

Test Report

Report No. : MTi250312008-0401E1

Date of issue : 2025-04-09

Applicant : Shenzhen Jiayz photo industrial ., Ltd

Product : AI-Powered Mini Wireless Microphone

Model(s) : BOYAMIC 2-TX, BOYAMIC 2 Lite-TX

FCC ID : 2ARN3-40501TX

Shenzhen Microtest Co., Ltd.

Table of contents

1	General Description	4
1.1	Description of the EUT	4
1.2	Description of test modes.....	4
1.3	Environmental Conditions	6
1.4	Description of support units	6
1.5	Measurement uncertainty.....	6
2	Summary of Test Result	7
3	Test Facilities and accreditations	8
3.1	Test laboratory.....	8
4	List of test equipment	9
5	Evaluation Results (Evaluation)	11
5.1	Antenna requirement.....	11
6	Radio Spectrum Matter Test Results (RF)	12
6.1	Conducted Emission at AC power line.....	12
6.2	20dB Bandwidth	15
6.3	Maximum Conducted Output Power	17
6.4	Channel Separation	19
6.5	Number of Hopping Frequencies	21
6.6	Dwell Time.....	23
6.7	RF conducted spurious emissions and band edge measurement	25
6.8	Band edge emissions (Radiated).....	27
6.9	Radiated emissions (below 1GHz).....	30
6.10	Radiated emissions (above 1GHz)	34
	Photographs of the test setup	38
	Photographs of the EUT	39
	Appendix A: 20dB Emission Bandwidth.....	41
	Appendix B: Maximum conducted output power	44
	Appendix C: Carrier frequency separation.....	47
	Appendix D: Time of occupancy	49
	Appendix E: Number of hopping channels	51
	Appendix F: Band edge measurements	53
	Appendix G: Conducted Spurious Emission	55

TEST REPORT

Report No.: MTi250312008-0401E1

Test Result Certification		
Applicant	Shenzhen Jiayz photo industrial ., Ltd	
Applicant Address	A16 Building, Intelligent Terminal Industrial Park of Silicon Valley Power, Guanlan, Longhua District, Shenzhen, China	
Manufacturer	Shenzhen Jiayz photo industrial ., Ltd	
Manufacturer Address	A16 Building, Intelligent Terminal Industrial Park of Silicon Valley Power, Guanlan, Longhua District, Shenzhen, China	
Product description		
Product name	AI-Powered Mini Wireless Microphone	
Trademark	BOYA	
Model name	BOYAMIC 2-TX	
Series Model(s)	BOYAMIC 2 Lite-TX	
Standards	47 CFR Part 15.247	
Test Method	KDB 558074 D01 15.247 Meas Guidance v05r02 ANSI C63.10-2013	
Testing Information		
Date of test	2025-03-19 to 2025-04-07	
Test result	Pass	
Prepared by:	Yanice.Xie	<i>Yanice Xie</i>
Reviewed by:	David Lee	<i>David. Lee</i>
Approved by:	Lewis Lian	<i>lewis lian</i>

TEST REPORT

Report No.: MTi250312008-0401E1

1 General Description

1.1 Description of the EUT

Product name:	AI-Powered Mini Wireless Microphone
Model name:	BOYAMIC 2-TX
Series Model(s):	BOYAMIC 2 Lite-TX
Model difference:	All the models are the same circuit and module, except the model name.
Electrical rating:	Input:DC 5V Battery: DC 3.8V 220mAh 0.836Wh
Accessories:	<ol style="list-style-type: none"> 1. Charging case*1 2. USC-C to USB-C cable 0.3m*1 3. 3.5mm TRS to TRS Audio cable 0.3m*1 4. Microphone*2 5. RX *1 6. USB-C Adapter*1
Hardware version:	V1.0
Software version:	2.0.3
Test sample(s) number:	MTi250312008-04-R001
RF specification	
Operating frequency range:	2402-2480MHz
Channel number:	79
Modulation type:	GFSK
Antenna(s) type:	Ceramic antenna
Antenna(s) gain:	1.78 dBi

1.2 Description of test modes

No.	Emission test modes
Mode1	TX-GFSK

1.2.1 Operation channel list

Channel	Frequency (MHz)	Channel	Frequency (MHz)	Channel	Frequency (MHz)	Channel	Frequency (MHz)
0	2402	20	2422	40	2442	60	2462
1	2403	21	2423	41	2443	61	2463
2	2404	22	2424	42	2444	62	2464
3	2405	23	2425	43	2445	63	2465
4	2406	24	2426	44	2446	64	2466
5	2407	25	2427	45	2447	65	2467

TEST REPORT

Report No.: MTi250312008-0401E1

6	2408	26	2428	46	2448	66	2468
7	2409	27	2429	47	2449	67	2469
8	2410	28	2430	48	2450	68	2470
9	2411	29	2431	49	2451	69	2471
10	2412	30	2432	50	2452	70	2472
11	2413	31	2433	51	2453	71	2473
12	2414	32	2434	52	2454	72	2474
13	2415	33	2435	53	2455	73	2475
14	2416	34	2436	54	2456	74	2476
15	2417	35	2437	55	2457	75	2477
16	2418	36	2438	56	2458	76	2478
17	2419	37	2439	57	2459	77	2479
18	2420	38	2440	58	2460	78	2480
19	2421	39	2441	59	2461	-	-

Test Channel List

Operation Band: 2400-2483.5 MHz

Bandwidth (MHz)	Lowest Channel (LCH) (MHz)	Middle Channel (MCH) (MHz)	Highest Channel (HCH) (MHz)
1	2402	2441	2480

Note: The test software provided by manufacturer is used to control EUT for working in engineering mode, that enables selectable channel, and capable of continuous transmitting mode.

Test Software: SmartLink FCC tool V1.2.0

For power setting, refer to below table.

Mode	2402MHz	2441MHz	2480MHz
GFSK	22	22	22

TEST REPORT

Report No.: MTi250312008-0401E1

1.3 Environmental Conditions

During the measurement the environmental conditions were within the listed ranges:

Temperature:	15°C ~ 35°C
Humidity:	20% RH ~ 75% RH
Atmospheric pressure:	98 kPa ~ 101 kPa

1.4 Description of support units

Support equipment list			
Description	Model	Serial No.	Manufacturer
Adapter	A2443	/	Apple
Support cable list			
Description	Length (m)	From	To
/	/	/	/

1.5 Measurement uncertainty

Measurement	Uncertainty
Conducted emissions (AMN 150kHz~30MHz)	±3.1dB
Occupied channel bandwidth	±3 %
RF output power, conducted	±1 dB
Time	±1 %
Unwanted Emissions, conducted	±1 dB
Radiated spurious emissions (above 1GHz)	±5.3dB
Radiated spurious emissions (9kHz~30MHz)	±4.3dB
Radiated spurious emissions (30MHz~1GHz)	±4.7dB
Temperature	±1 °C
Humidity	± 5 %

This uncertainty represents an expanded uncertainty expressed at approximately the 95% confidence level using a coverage factor of k=2.

TEST REPORT

Report No.: MTi250312008-0401E1

2 Summary of Test Result

No.	Item	Requirement	Result
1	Antenna requirement	47 CFR 15.203	Pass
2	Conducted Emission at AC power line	47 CFR 15.207(a)	Pass
3	20dB Bandwidth	47 CFR 15.247(a)(1)	Pass
4	Maximum Conducted Output Power	47 CFR 15.247(b)(1)	Pass
5	Channel Separation	47 CFR 15.247(a)(1)	Pass
6	Number of Hopping Frequencies	47 CFR 15.247(a)(1)(iii)	Pass
7	Dwell Time	47 CFR 15.247(a)(1)(iii)	Pass
8	RF conducted spurious emissions and band edge measurement	47 CFR 15.247(d), 15.209, 15.205	Pass
9	Band edge emissions (Radiated)	47 CFR 15.247(d), 15.209, 15.205	Pass
10	Radiated emissions (below 1GHz)	47 CFR 15.247(d), 15.209, 15.205	Pass
11	Radiated emissions (above 1GHz)	47 CFR 15.247(d), 15.209, 15.205	Pass

TEST REPORT

Report No.: MTi250312008-0401E1

3 Test Facilities and accreditations

3.1 Test laboratory

Test laboratory:	Shenzhen Microtest Co., Ltd.
Test site location:	101, No.7, Zone 2, Xinxing Industrial Park, Fuhai Avenue, Xinhe Community, Fuhai Street, Bao'an District, Shenzhen, Guangdong, China
Telephone:	(86-755)88850135
Fax:	(86-755)88850136
CNAS Registration No.:	CNAS L5868
FCC Registration No.:	448573
IC Registration No.:	21760
CABID:	CN0093

TEST REPORT

Report No.: MTi250312008-0401E1

4 List of test equipment

No.	Equipment	Manufacturer	Model	Serial No.	Cal. date	Cal. Due
Conducted Emission at AC power line						
1	EMI Test Receiver	Rohde&schwarz	ESCI3	101368	2025-03-13	2026-03-12
2	Artificial mains network	Schwarzbeck	NSLK 8127	183	2025-03-18	2026-03-17
3	Artificial Mains Network	Rohde & Schwarz	ESH2-Z5	100263	2025-03-18	2026-03-17
20dB Bandwidth Maximum Conducted Output Power Channel Separation Number of Hopping Frequencies Dwell Time Emissions in non-restricted frequency bands						
1	Wideband Radio Communication Tester	Rohde&schwarz	CMW500	149155	2025-03-18	2026-03-17
2	ESG Series Analog Ssignal Generator	Agilent	E4421B	GB40051240	2025-03-14	2026-03-13
3	PXA Signal Analyzer	Agilent	N9030A	MY51350296	2025-03-14	2026-03-13
4	Synthesized Sweeper	Agilent	83752A	3610A01957	2025-03-18	2026-03-17
5	MXA Signal Analyzer	Agilent	N9020A	MY50143483	2025-03-18	2026-03-17
6	RF Control Unit	Tonscend	JS0806-1	19D8060152	2025-03-18	2026-03-17
7	Band Reject Filter Group	Tonscend	JS0806-F	19D8060160	2025-03-18	2026-03-17
8	ESG Vector Signal Generator	Agilent	N5182A	MY50143762	2025-03-14	2026-03-13
9	DC Power Supply	Agilent	E3632A	MY40027695	2025-03-18	2026-03-17
Band edge emissions (Radiated) Emissions in frequency bands (above 1GHz)						
1	EMI Test Receiver	Rohde&schwarz	ESCI7	101166	2025-03-14	2026-03-13
2	Double Ridged Broadband Horn Antenna	schwarabeck	BBHA 9120 D	2278	2023-06-17	2025-06-16
3	Amplifier	Agilent	8449B	3008A01120	2025-03-18	2026-03-17
4	MXA signal analyzer	Agilent	N9020A	MY54440859	2025-03-14	2026-03-13
5	PXA Signal Analyzer	Agilent	N9030A	MY51350296	2025-03-14	2026-03-13
6	Horn antenna	Schwarzbeck	BBHA 9170	00987	2023-06-17	2025-06-16
7	Pre-amplifier	Space-Dtronics	EWLAN1840G	210405001	2025-03-19	2026-03-18
Emissions in frequency bands (below 1GHz)						
1	EMI Test Receiver	Rohde&schwarz	ESCI7	101166	2025-03-14	2026-03-13
2	TRILOG Broadband Antenna	schwarabeck	VULB 9163	9163-1338	2023-06-11	2025-06-10

TEST REPORT

Report No.: MTi250312008-0401E1

No.	Equipment	Manufacturer	Model	Serial No.	Cal. date	Cal. Due
3	Active Loop Antenna	Schwarzbeck	FMZB 1519 B	00066	2024-03-23	2026-03-22
4	Amplifier	Hewlett-Packard	8447F	3113A06184	2025-03-18	2026-03-17

TEST REPORT

Report No.: MTi250312008-0401E1

5 Evaluation Results (Evaluation)

5.1 Antenna requirement

Test Requirement:	Refer to 47 CFR Part 15.203, an intentional radiator shall be designed to ensure that no antenna other than that furnished by the responsible party shall be used with the device. The use of a permanently attached antenna or of an antenna that uses a unique coupling to the intentional radiator shall be considered sufficient to comply with the provisions of this section.
-------------------	---

5.1.1 Conclusion:

The antenna of the EUT is permanently attached. The EUT complies with the requirement of FCC PART 15.203.
--

TEST REPORT

Report No.: MTi250312008-0401E1

6 Radio Spectrum Matter Test Results (RF)

6.1 Conducted Emission at AC power line

Test Requirement:	Refer to 47 CFR 15.207(a), Except as shown in paragraphs (b) and (c) of this section, for an intentional radiator that is designed to be connected to the public utility (AC) power line, the radio frequency voltage that is conducted back onto the AC power line on any frequency or frequencies, within the band 150 kHz to 30 MHz, shall not exceed the limits in the following table, as measured using a 50 μ H/50 ohms line impedance stabilization network (LISN).		
Test Limit:	Frequency of emission (MHz)	Conducted limit (dB μ V)	
		Quasi-peak	Average
	0.15-0.5	66 to 56*	56 to 46*
	0.5-5	56	46
	5-30	60	50
	*Decreases with the logarithm of the frequency.		
Test Method:	ANSI C63.10-2013 section 6.2		
Procedure:	Refer to ANSI C63.10-2013 section 6.2, standard test method for ac power-line conducted emissions from unlicensed wireless devices		

6.1.1 E.U.T. Operation:

Operating Environment:					
Temperature:	21.3 °C	Humidity:	41 %	Atmospheric Pressure:	100 kPa
Pre test mode:	Mode1				
Final test mode:	Mode1				

6.1.2 Test Setup Diagram:

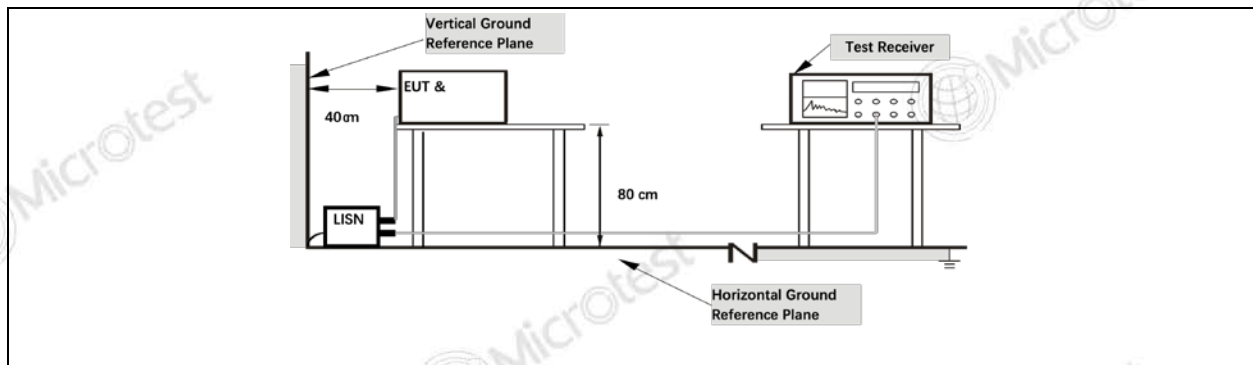

TEST REPORT

Report No.: MTi250312008-0401E1

6.1.3 Test Data:

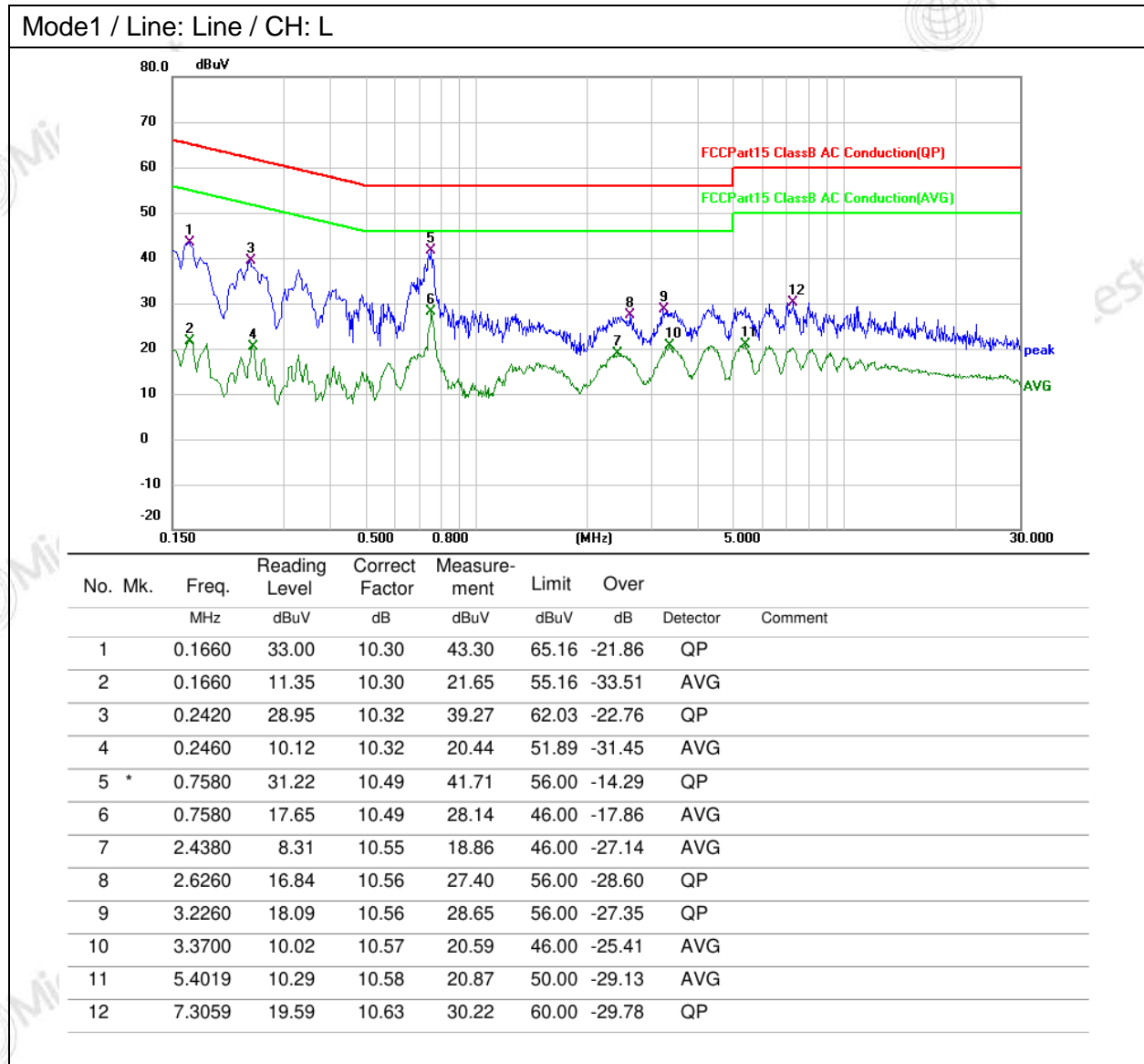

TEST REPORT

Report No.: MTi250312008-0401E1

Mode1 / Line: Neutral / CH: L

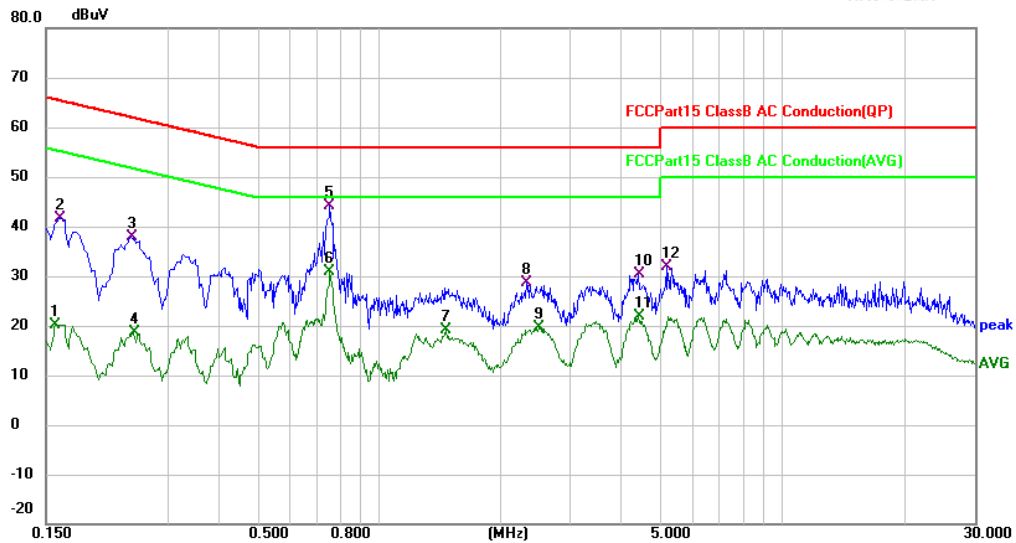

No. Mk.	Freq. MHz	Reading Level dBuV	Correct Factor dB	Measure- ment dBuV	Limit dBuV	Over dB	Detector	Comment
1	0.1580	9.95	10.30	20.25	55.57	-35.32	AVG	
2	0.1620	31.40	10.30	41.70	65.36	-23.66	QP	
3	0.2420	27.50	10.32	37.82	62.03	-24.21	QP	
4	0.2460	8.29	10.32	18.61	51.89	-33.28	AVG	
5 *	0.7580	33.57	10.49	44.06	56.00	-11.94	QP	
6	0.7580	20.44	10.49	30.93	46.00	-15.07	AVG	
7	1.4700	8.66	10.54	19.20	46.00	-26.80	AVG	
8	2.3380	17.99	10.55	28.54	56.00	-27.46	QP	
9	2.5100	9.05	10.56	19.61	46.00	-26.39	AVG	
10	4.4180	19.82	10.57	30.39	56.00	-25.61	QP	
11	4.4180	11.30	10.57	21.87	46.00	-24.13	AVG	
12	5.1700	21.22	10.58	31.80	60.00	-28.20	QP	

TEST REPORT

Report No.: MTi250312008-0401E1

6.2 20dB Bandwidth

Test Requirement:	47 CFR 15.247(a)(1)
Test Limit:	Refer to 47 CFR 15.215(c), intentional radiators operating under the alternative provisions to the general emission limits, as contained in §§ 15.217 through 15.257 and in subpart E of this part, must be designed to ensure that the 20 dB bandwidth of the emission, or whatever bandwidth may otherwise be specified in the specific rule section under which the equipment operates, is contained within the frequency band designated in the rule section under which the equipment is operated.
Test Method:	ANSI C63.10-2013, section 7.8.7, For occupied bandwidth measurements, use the procedure in 6.9.2. KDB 558074 D01 15.247 Meas Guidance v05r02
Procedure:	<p>a) The spectrum analyzer center frequency is set to the nominal EUT channel center frequency. The span range for the EMI receiver or spectrum analyzer shall be between two times and five times the OBW.</p> <p>b) The nominal IF filter bandwidth (3 dB RBW) shall be in the range of 1% to 5% of the OBW and video bandwidth (VBW) shall be approximately three times RBW, unless otherwise specified by the applicable requirement.</p> <p>c) Set the reference level of the instrument as required, keeping the signal from exceeding the maximum input mixer level for linear operation. In general, the peak of the spectral envelope shall be more than $[10 \log (OBW/RBW)]$ below the reference level. Specific guidance is given in 4.1.5.2.</p> <p>d) Steps a) through c) might require iteration to adjust within the specified tolerances.</p> <p>e) The dynamic range of the instrument at the selected RBW shall be more than 10 dB below the target “-xx dB down” requirement; that is, if the requirement calls for measuring the -20 dB OBW, the instrument noise floor at the selected RBW shall be at least 30 dB below the reference value.</p> <p>f) Set detection mode to peak and trace mode to max hold.</p> <p>g) Determine the reference value: Set the EUT to transmit an unmodulated carrier or modulated signal, as applicable. Allow the trace to stabilize. Set the spectrum analyzer marker to the highest level of the displayed trace (this is the reference value).</p> <p>h) Determine the “-xx dB down amplitude” using [(reference value) - xx]. Alternatively, this calculation may be made by using the marker-delta function of the instrument.</p> <p>i) If the reference value is determined by an unmodulated carrier, then turn the EUT modulation ON, and either clear the existing trace or start a new trace on the spectrum analyzer and allow the new trace to stabilize. Otherwise, the trace from step g) shall be used for step j).</p> <p>j) Place two markers, one at the lowest frequency and the other at the highest frequency of the envelope of the spectral display, such that each marker is at or slightly below the “-xx dB down amplitude” determined in step h). If a marker is below this “-xx dB down amplitude” value, then it shall be as close as possible to this value. The occupied bandwidth is the frequency difference between the two markers. Alternatively, set a marker at the lowest frequency of the</p>

TEST REPORT

Report No.: MTi250312008-0401E1

	<p>envelope of the spectral display, such that the marker is at or slightly below the “-xx dB down amplitude” determined in step h). Reset the marker-delta function and move the marker to the other side of the emission until the delta marker amplitude is at the same level as the reference marker amplitude. The marker-delta frequency reading at this point is the specified emission bandwidth.</p> <p>k) The occupied bandwidth shall be reported by providing plot(s) of the measuring instrument display; the plot axes and the scale units per division shall be clearly labeled. Tabular data may be reported in addition to the plot(s).</p>
--	--

6.2.1 E.U.T. Operation:

Operating Environment:					
Temperature:	22.5 °C	Humidity:	46 %	Atmospheric Pressure:	101 kPa
Pre test mode:	Mode1				
Final test mode:	Mode1				

6.2.2 Test Setup Diagram:

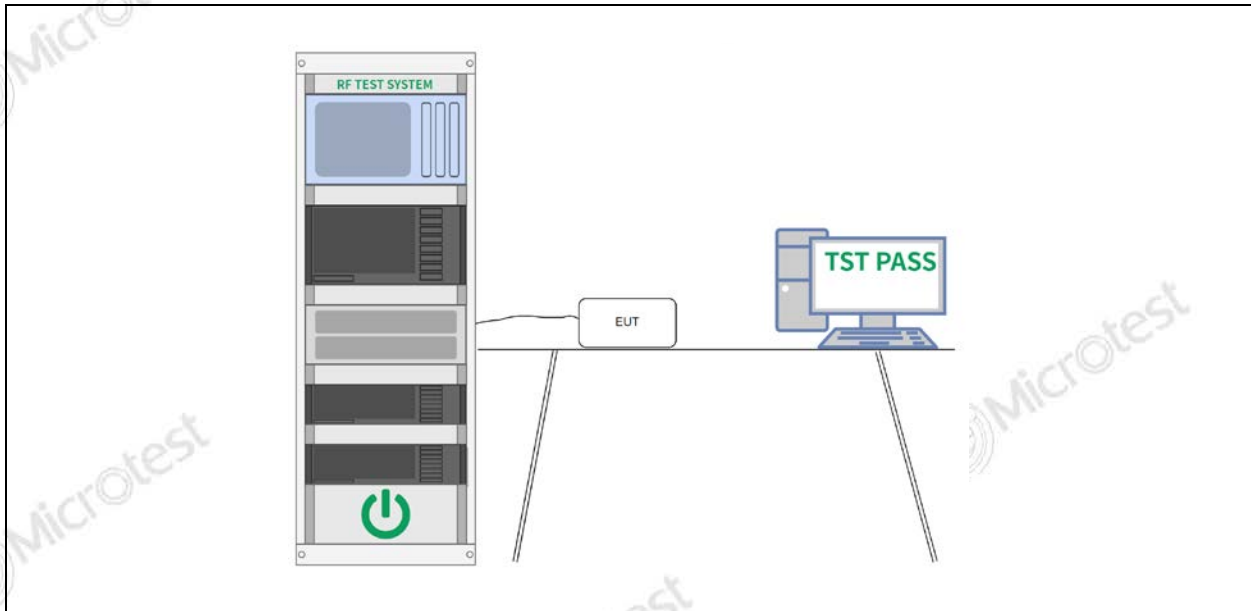

6.2.3 Test Data:

Please Refer to Appendix for Details.

TEST REPORT

Report No.: MTi250312008-0401E1

6.3 Maximum Conducted Output Power

Test Requirement:	47 CFR 15.247(b)(1)
Test Limit:	Refer to 47 CFR 15.247(b)(1), For frequency hopping systems operating in the 2400-2483.5 MHz band employing at least 75 non-overlapping hopping channels, and all frequency hopping systems in the 5725-5850 MHz band: 1 watt. For all other frequency hopping systems in the 2400-2483.5 MHz band: 0.125 watts.
Test Method:	ANSI C63.10-2013, section 7.8.5 KDB 558074 D01 15.247 Meas Guidance v05r02
Procedure:	<p>This is an RF-conducted test to evaluate maximum peak output power. Use a direct connection between the antenna port of the unlicensed wireless device and the spectrum analyzer, through suitable attenuation. The hopping shall be disabled for this test:</p> <p>a) Use the following spectrum analyzer settings:</p> <ol style="list-style-type: none"> 1) Span: Approximately five times the 20 dB bandwidth, centered on a hopping channel. 2) RBW > 20 dB bandwidth of the emission being measured. 3) VBW >= RBW. 4) Sweep: Auto. 5) Detector function: Peak. 6) Trace: Max hold. <p>b) Allow trace to stabilize.</p> <p>c) Use the marker-to-peak function to set the marker to the peak of the emission.</p> <p>d) The indicated level is the peak output power, after any corrections for external attenuators and cables.</p> <p>e) A plot of the test results and setup description shall be included in the test report.</p> <p>NOTE—A peak responding power meter may be used, where the power meter and sensor system video bandwidth is greater than the occupied bandwidth of the unlicensed wireless device, rather than a spectrum analyzer.</p>

6.3.1 E.U.T. Operation:

Operating Environment:					
Temperature:	22.5 °C	Humidity:	46 %	Atmospheric Pressure:	101 kPa
Pre test mode:	Mode1				
Final test mode:	Mode1				

6.3.2 Test Setup Diagram:

--

TEST REPORT

Report No.: MTi250312008-0401E1

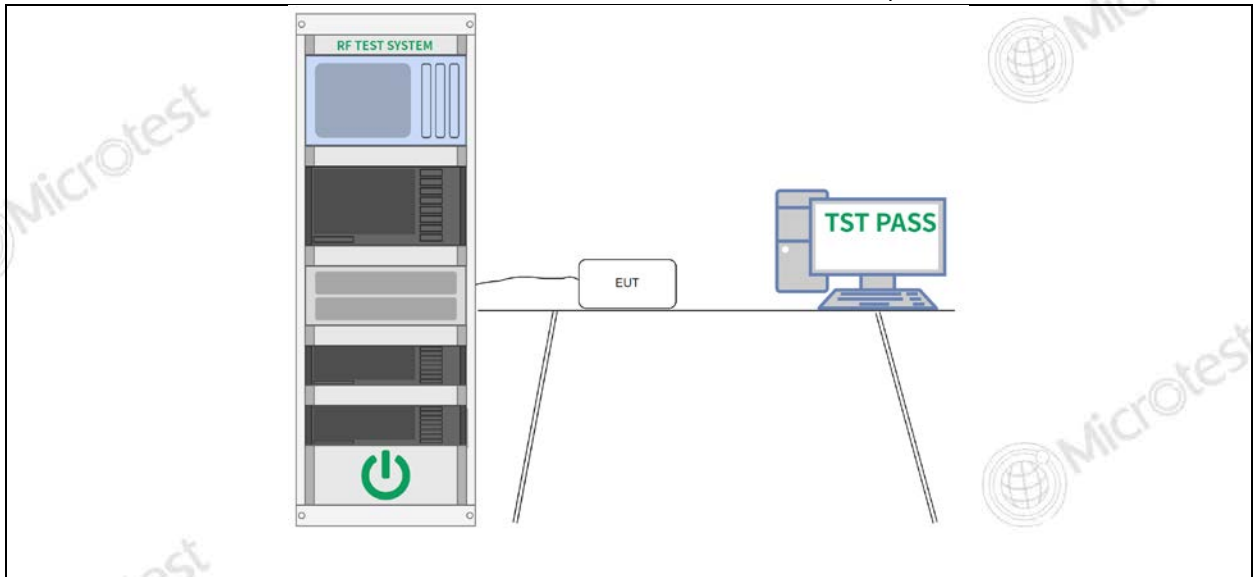

6.3.3 Test Data:

Please Refer to Appendix for Details.

TEST REPORT

Report No.: MTi250312008-0401E1

6.4 Channel Separation

Test Requirement:	47 CFR 15.247(a)(1)
Test Limit:	Refer to 47 CFR 15.247(a)(1), Frequency hopping systems shall have hopping channel carrier frequencies separated by a minimum of 25 kHz or the 20 dB bandwidth of the hopping channel, whichever is greater. Alternatively, frequency hopping systems operating in the 2400-2483.5 MHz band may have hopping channel carrier frequencies that are separated by 25 kHz or two-thirds of the 20 dB bandwidth of the hopping channel, whichever is greater, provided the systems operate with an output power no greater than 125 mW.
Test Method:	ANSI C63.10-2013, section 7.8.2 KDB 558074 D01 15.247 Meas Guidance v05r02
Procedure:	<p>The EUT shall have its hopping function enabled. Use the following spectrum analyzer settings:</p> <ul style="list-style-type: none"> a) Span: Wide enough to capture the peaks of two adjacent channels. b) RBW: Start with the RBW set to approximately 30% of the channel spacing; adjust as necessary to best identify the center of each individual channel. c) Video (or average) bandwidth (VBW) \geq RBW. d) Sweep: Auto. e) Detector function: Peak. f) Trace: Max hold. g) Allow the trace to stabilize. <p>Use the marker-delta function to determine the separation between the peaks of the adjacent channels. Compliance of an EUT with the appropriate regulatory limit shall be determined. A plot of the data shall be included in the test report.</p>

6.4.1 E.U.T. Operation:

Operating Environment:					
Temperature:	22.5 °C	Humidity:	46 %	Atmospheric Pressure:	101 kPa
Pre test mode:	Mode1				
Final test mode:	Mode1				

6.4.2 Test Setup Diagram:

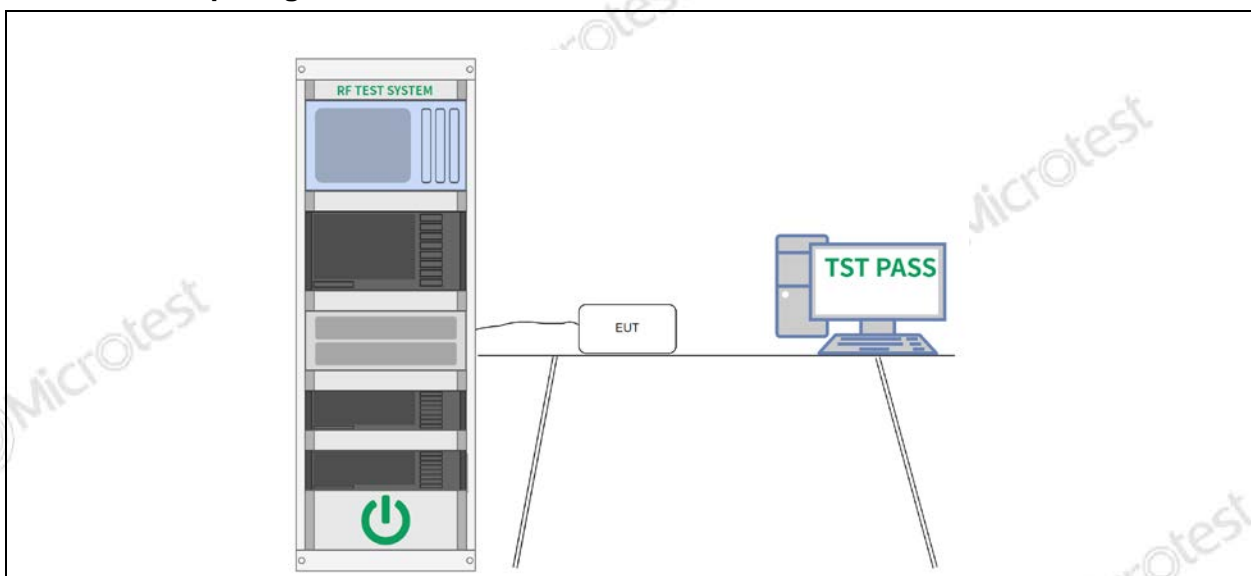

6.4.3 Test Data:

Please Refer to Appendix for Details.

TEST REPORT

Report No.: MTi250312008-0401E1

6.5 Number of Hopping Frequencies

Test Requirement:	47 CFR 15.247(a)(1)(iii)
Test Limit:	Refer to 47 CFR 15.247(a)(1)(iii), Frequency hopping systems in the 2400-2483.5 MHz band shall use at least 15 channels. The average time of occupancy on any channel shall not be greater than 0.4 seconds within a period of 0.4 seconds multiplied by the number of hopping channels employed. Frequency hopping systems may avoid or suppress transmissions on a particular hopping frequency provided that a minimum of 15 channels are used.
Test Method:	ANSI C63.10-2013, section 7.8.3 KDB 558074 D01 15.247 Meas Guidance v05r02
Procedure:	<p>The EUT shall have its hopping function enabled. Use the following spectrum analyzer settings:</p> <ul style="list-style-type: none"> a) Span: The frequency band of operation. Depending on the number of channels the device supports, it may be necessary to divide the frequency range of operation across multiple spans, to allow the individual channels to be clearly seen. b) RBW: To identify clearly the individual channels, set the RBW to less than 30% of the channel spacing or the 20 dB bandwidth, whichever is smaller. c) VBW \geq RBW. d) Sweep: Auto. e) Detector function: Peak. f) Trace: Max hold. g) Allow the trace to stabilize. <p>It might prove necessary to break the span up into subranges to show clearly all of the hopping frequencies. Compliance of an EUT with the appropriate regulatory limit shall be determined for the number of hopping channels. A plot of the data shall be included in the test report.</p>

6.5.1 E.U.T. Operation:

Operating Environment:					
Temperature:	22.5 °C	Humidity:	46 %	Atmospheric Pressure:	101 kPa
Pre test mode:	Mode1				
Final test mode:	Mode1				

6.5.2 Test Setup Diagram:

--

TEST REPORT

Report No.: MTi250312008-0401E1

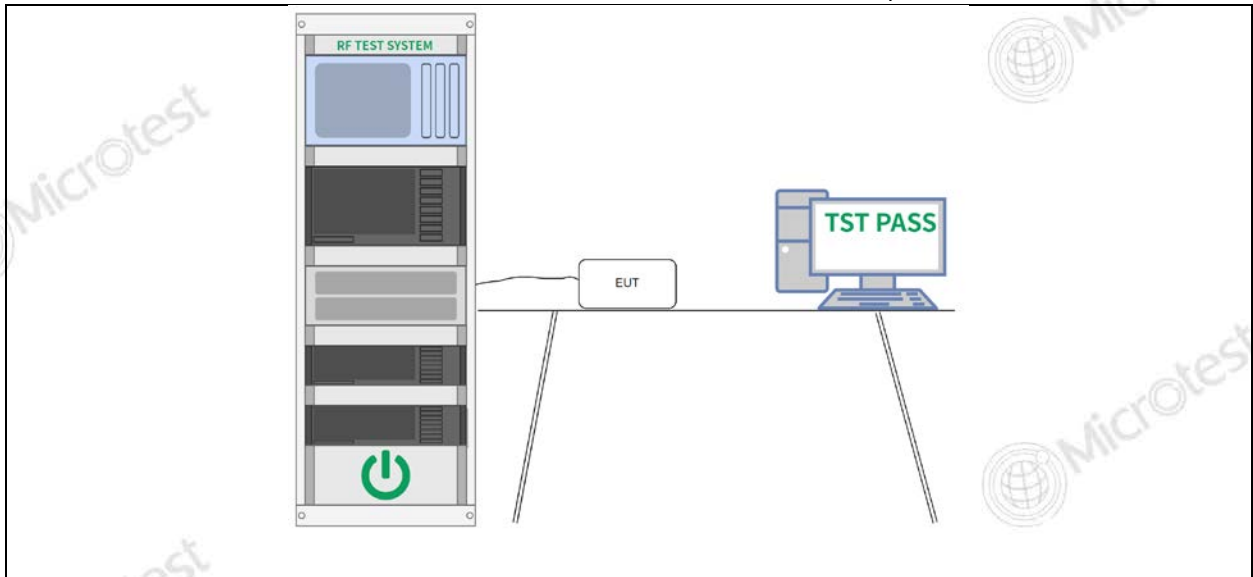

6.5.3 Test Data:

Please Refer to Appendix for Details.

TEST REPORT

Report No.: MTi250312008-0401E1

6.6 Dwell Time

Test Requirement:	47 CFR 15.247(a)(1)(iii)
Test Limit:	Refer to 47 CFR 15.247(a)(1)(iii), Frequency hopping systems in the 2400-2483.5 MHz band shall use at least 15 channels. The average time of occupancy on any channel shall not be greater than 0.4 seconds within a period of 0.4 seconds multiplied by the number of hopping channels employed. Frequency hopping systems may avoid or suppress transmissions on a particular hopping frequency provided that a minimum of 15 channels are used.
Test Method:	ANSI C63.10-2013, section 7.8.4 KDB 558074 D01 15.247 Meas Guidance v05r02
Procedure:	<p>The EUT shall have its hopping function enabled. Use the following spectrum analyzer settings:</p> <p>a) Span: Zero span, centered on a hopping channel.</p> <p>b) RBW shall be \leq channel spacing and where possible RBW should be set $\gg 1 / T$, where T is the expected dwell time per channel.</p> <p>c) Sweep: As necessary to capture the entire dwell time per hopping channel; where possible use a video trigger and trigger delay so that the transmitted signal starts a little to the right of the start of the plot. The trigger level might need slight adjustment to prevent triggering when the system hops on an adjacent channel; a second plot might be needed with a longer sweep time to show two successive hops on a channel.</p> <p>d) Detector function: Peak.</p> <p>e) Trace: Max hold.</p> <p>Use the marker-delta function to determine the transmit time per hop. If this value varies with different modes of operation (data rate, modulation format, number of hopping channels, etc.), then repeat this test for each variation in transmit time.</p> <p>Repeat the measurement using a longer sweep time to determine the number of hops over the period specified in the requirements. The sweep time shall be equal to, or less than, the period specified in the requirements. Determine the number of hops over the sweep time and calculate the total number of hops in the period specified in the requirements, using the following equation:</p> $(\text{Number of hops in the period specified in the requirements}) = (\text{number of hops on spectrum analyzer}) \times (\text{period specified in the requirements} / \text{analyzer sweep time})$ <p>The average time of occupancy is calculated from the transmit time per hop multiplied by the number of hops in the period specified in the requirements. If the number of hops in a specific time varies with different modes of operation (data rate, modulation format, number of hopping channels, etc.), then repeat this test for each variation.</p> <p>The measured transmit time and time between hops shall be consistent with the values described in the operational description for the EUT.</p>

6.6.1 E.U.T. Operation:

Operating Environment:					
Temperature:	22.5 °C	Humidity:	46 %	Atmospheric Pressure:	101 kPa
Pre test mode:	Mode1				

Final test mode:	Mode1
------------------	-------

6.6.2 Test Setup Diagram:

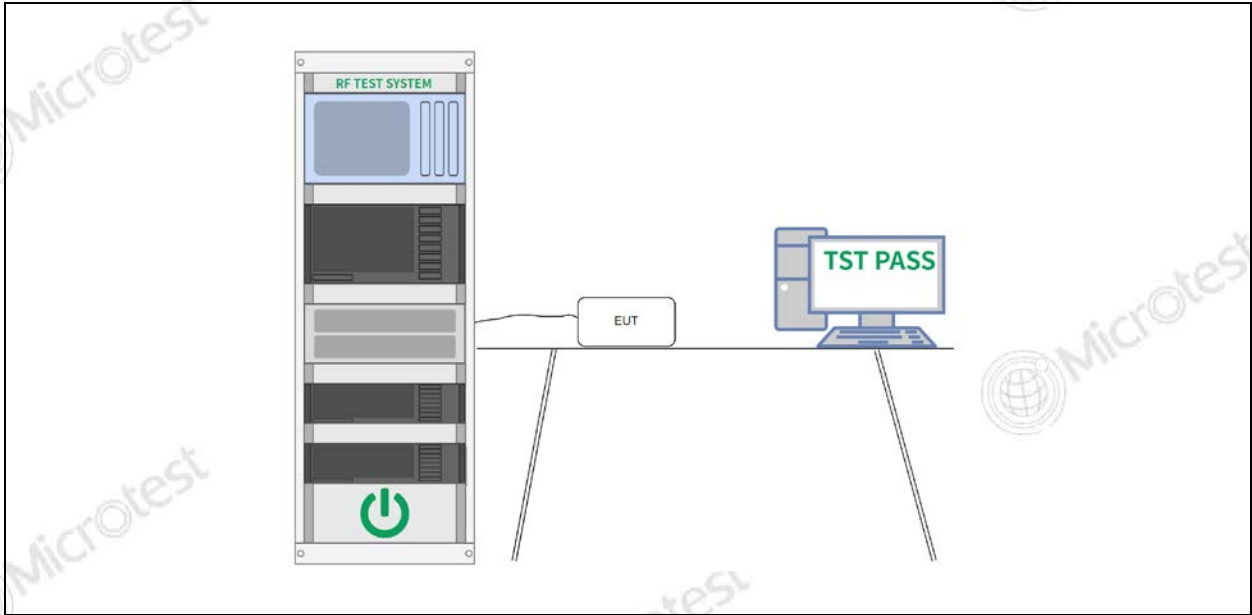

6.6.3 Test Data:

Please Refer to Appendix for Details.

TEST REPORT

Report No.: MTi250312008-0401E1

6.7 RF conducted spurious emissions and band edge measurement

Test Requirement:	47 CFR 15.247(d), 15.209, 15.205
Test Limit:	Refer to 47 CFR 15.247(d), In any 100 kHz bandwidth outside the frequency band in which the spread spectrum or digitally modulated intentional radiator is operating, the radio frequency power that is produced by the intentional radiator shall be at least 20 dB below that in the 100 kHz bandwidth within the band that contains the highest level of the desired power, based on either an RF conducted or a radiated measurement, provided the transmitter demonstrates compliance with the peak conducted power limits. If the transmitter complies with the conducted power limits based on the use of RMS averaging over a time interval, as permitted under paragraph (b)(3) of this section, the attenuation required under this paragraph shall be 30 dB instead of 20 dB. Attenuation below the general limits specified in § 15.209(a) is not required.
Test Method:	ANSI C63.10-2013 section 7.8.8 KDB 558074 D01 15.247 Meas Guidance v05r02
Procedure:	Conducted spurious emissions shall be measured for the transmit frequency, per 5.5 and 5.6, and at the maximum transmit powers. Connect the primary antenna port through an attenuator to the spectrum analyzer input; in the results, account for all losses between the unlicensed wireless device output and the spectrum analyzer. The instrument shall span 30 MHz to 10 times the operating frequency in GHz, with a resolution bandwidth of 100 kHz, video bandwidth of 300 kHz, and a coupled sweep time with a peak detector. The band 30 MHz to the highest frequency may be split into smaller spans, as long as the entire spectrum is covered.

6.7.1 E.U.T. Operation:

Operating Environment:					
Temperature:	22.5 °C	Humidity:	46 %	Atmospheric Pressure:	101 kPa
Pre test mode:	Mode1				
Final test mode:	Mode1				

6.7.2 Test Setup Diagram:

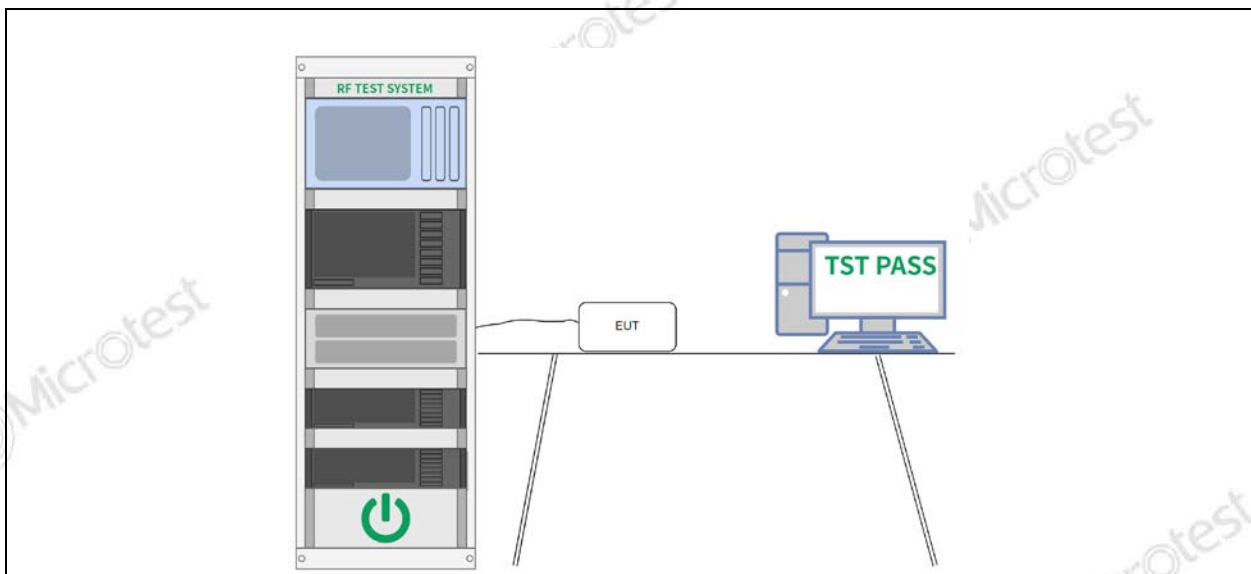

6.7.3 Test Data:

Please Refer to Appendix for Details.

TEST REPORT

Report No.: MTi250312008-0401E1

6.8 Band edge emissions (Radiated)

Test Requirement:	Refer to 47 CFR 15.247(d), In addition, radiated emissions which fall in the restricted bands, as defined in § 15.205(a), must also comply with the radiated emission limits specified in § 15.209(a)(see § 15.205(c)).		
Test Limit:	Frequency (MHz)	Field strength (microvolts/meter)	Measurement distance (meters)
	0.009-0.490	2400/F(kHz)	300
	0.490-1.705	24000/F(kHz)	30
	1.705-30.0	30	30
	30-88	100 **	3
	88-216	150 **	3
	216-960	200 **	3
	Above 960	500	3
	** Except as provided in paragraph (g), fundamental emissions from intentional radiators operating under this section shall not be located in the frequency bands 54-72 MHz, 76-88 MHz, 174-216 MHz or 470-806 MHz. However, operation within these frequency bands is permitted under other sections of this part, e.g., §§ 15.231 and 15.241. In the emission table above, the tighter limit applies at the band edges. The emission limits shown in the above table are based on measurements employing a CISPR quasi-peak detector except for the frequency bands 9-90 kHz, 110-490 kHz and above 1000 MHz. Radiated emission limits in these three bands are based on measurements employing an average detector.		
Test Method:	ANSI C63.10-2013 section 6.10 KDB 558074 D01 15.247 Meas Guidance v05r02		
Procedure:	ANSI C63.10-2013 section 6.10.5.2		

6.8.1 E.U.T. Operation:

Operating Environment:			
Temperature:	19.3 °C	Humidity:	45.2 %
		Atmospheric Pressure:	101 kPa
Pre test mode:	Mode1		
Final test mode:	Mode1		
Note: The amplitude of spurious emissions which are attenuated more than 20 dB below the limits are not reported.			

6.8.2 Test Setup Diagram:

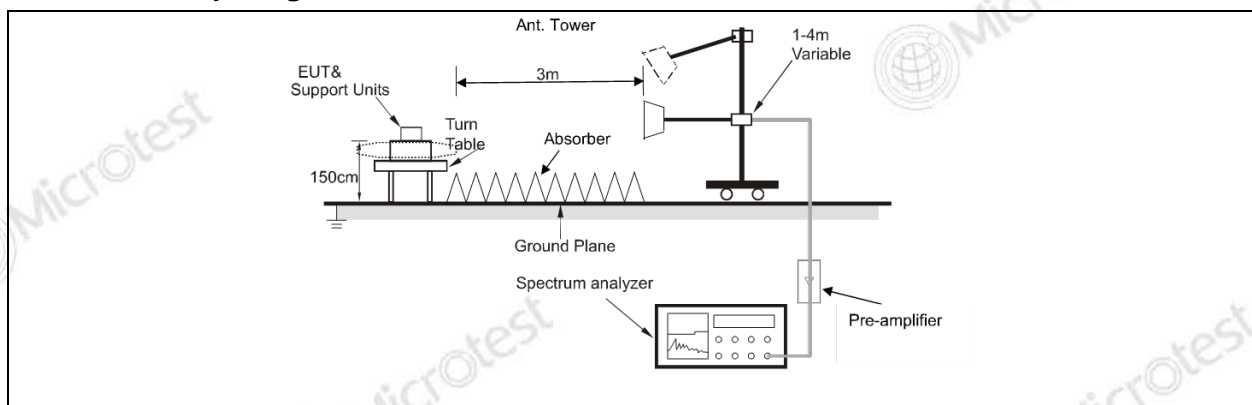

TEST REPORT

Report No.: MTi250312008-0401E1

6.8.3 Test Data:

Mode1 / Polarization: Horizontal / CH: L								
No.	Mk.	Freq.	Reading Level	Correct Factor	Measurement	Limit	Over	
		MHz	dBuV	dB	dBuV/m	dBuV/m	dB	
							Detector	
1		2310.000	47.93	-4.83	43.10	74.00	-30.90	peak
2		2310.000	38.16	-4.83	33.33	54.00	-20.67	AVG
3		2390.000	48.20	-4.31	43.89	74.00	-30.11	peak
4	*	2390.000	38.42	-4.31	34.11	54.00	-19.89	AVG

Mode1 / Polarization: Vertical / CH: L								
No.	Mk.	Freq.	Reading Level	Correct Factor	Measurement	Limit	Over	
		MHz	dBuV	dB	dBuV/m	dBuV/m	dB	
							Detector	
1		2310.000	48.44	-4.83	43.61	74.00	-30.39	peak
2		2310.000	38.11	-4.83	33.28	54.00	-20.72	AVG
3		2390.000	48.18	-4.31	43.87	74.00	-30.13	peak
4	*	2390.000	38.33	-4.31	34.02	54.00	-19.98	AVG

TEST REPORT

Report No.: MTi250312008-0401E1

Mode1 / Polarization: Horizontal / CH: H

No.	Mk.	Freq.	Reading Level	Correct Factor	Measurement	Limit	Over	Detector
		MHz	dBuV	dB	dBuV/m	dBuV/m	dB	
1		2483.500	52.25	-4.21	48.04	74.00	-25.96	peak
2	*	2483.500	42.04	-4.21	37.83	54.00	-16.17	AVG
3		2500.000	49.34	-4.10	45.24	74.00	-28.76	peak
4		2500.000	38.62	-4.10	34.52	54.00	-19.48	AVG

Mode1 / Polarization: Vertical / CH: H

No.	Mk.	Freq.	Reading Level	Correct Factor	Measurement	Limit	Over	Detector
		MHz	dBuV	dB	dBuV/m	dBuV/m	dB	
1		2483.500	47.66	-4.21	43.45	74.00	-30.55	peak
2		2483.500	38.21	-4.21	34.00	54.00	-20.00	AVG
3		2500.000	48.19	-4.10	44.09	74.00	-29.91	peak
4	*	2500.000	38.33	-4.10	34.23	54.00	-19.77	AVG

TEST REPORT

Report No.: MTI250312008-0401E1

6.9 Radiated emissions (below 1GHz)

Test Requirement:	Refer to 47 CFR 15.247(d), In addition, radiated emissions which fall in the restricted bands, as defined in § 15.205(a), must also comply with the radiated emission limits specified in § 15.209(a)(see § 15.205(c)).		
Test Limit:	Frequency (MHz)	Field strength (microvolts/meter)	Measurement distance (meters)
	0.009-0.490	2400/F(kHz)	300
	0.490-1.705	24000/F(kHz)	30
	1.705-30.0	30	30
	30-88	100 **	3
	88-216	150 **	3
	216-960	200 **	3
	Above 960	500	3
	** Except as provided in paragraph (g), fundamental emissions from intentional radiators operating under this section shall not be located in the frequency bands 54-72 MHz, 76-88 MHz, 174-216 MHz or 470-806 MHz. However, operation within these frequency bands is permitted under other sections of this part, e.g., §§ 15.231 and 15.241. In the emission table above, the tighter limit applies at the band edges. The emission limits shown in the above table are based on measurements employing a CISPR quasi-peak detector except for the frequency bands 9-90 kHz, 110-490 kHz and above 1000 MHz. Radiated emission limits in these three bands are based on measurements employing an average detector.		
Test Method:	ANSI C63.10-2013 section 6.6.4 KDB 558074 D01 15.247 Meas Guidance v05r02		
Procedure:	ANSI C63.10-2013 section 6.6.4		

6.9.1 E.U.T. Operation:

Operating Environment:					
Temperature:	19.3 °C	Humidity:	45.2 %	Atmospheric Pressure:	101 kPa
Pre test mode:	Mode1				
Final test mode:	Mode1				
Note:					
The amplitude of spurious emissions which are attenuated more than 20 dB below the limits are not reported.					
All modes of operation of the EUT were investigated, and only the worst-case results are reported. There were no emissions found below 30MHz within 20dB of the limit.					

6.9.2 Test Setup Diagram:

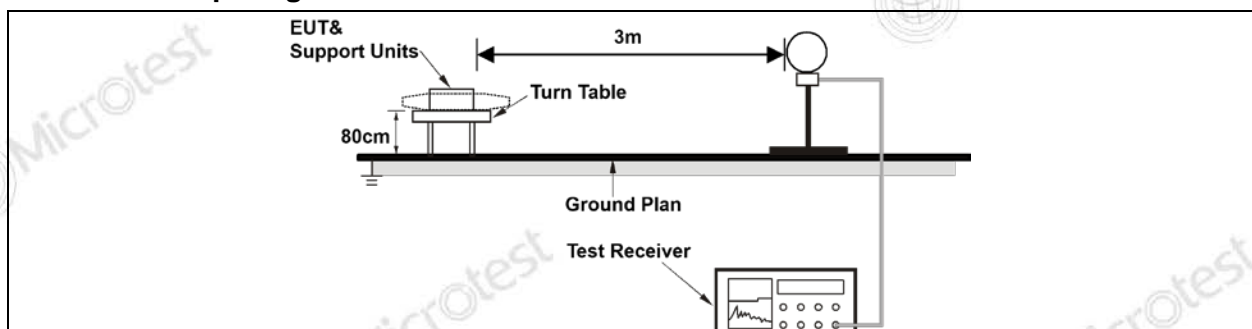

TEST REPORT

Report No.: MTi250312008-0401E1

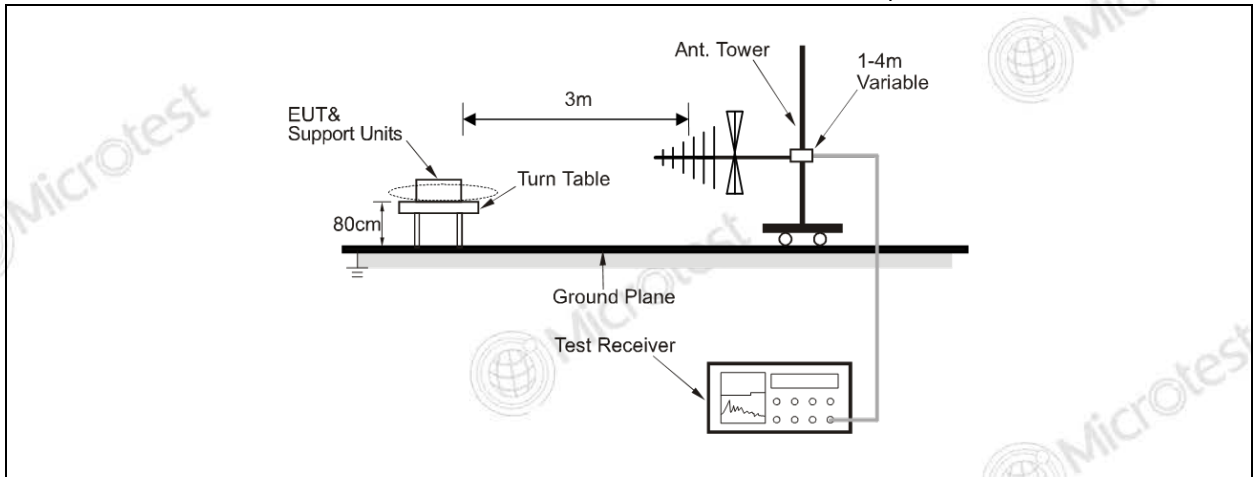

TEST REPORT

Report No.: MTi250312008-0401E1

6.9.3 Test Data:

Mode1 / Polarization: Horizontal / CH: H

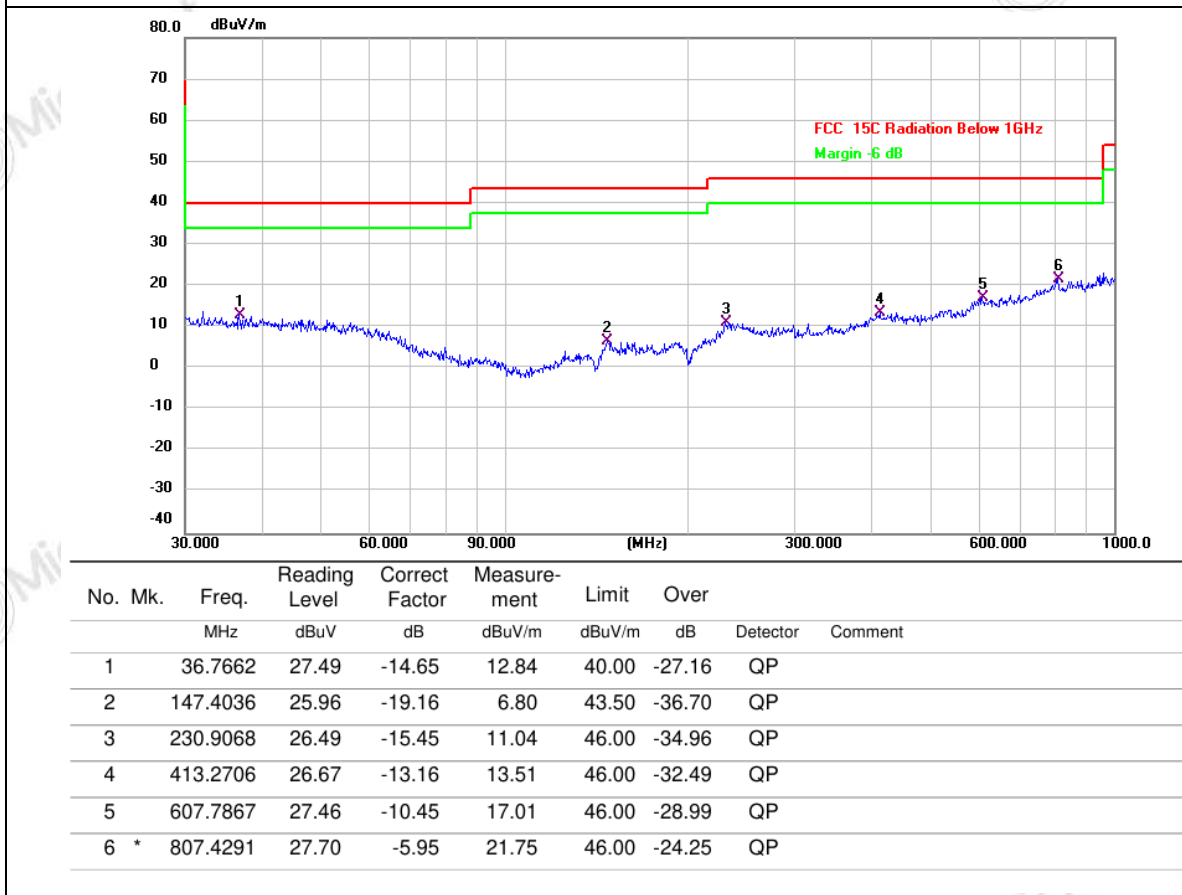

TEST REPORT

Report No.: MTi250312008-0401E1

Mode1 / Polarization: Vertical / CH: H

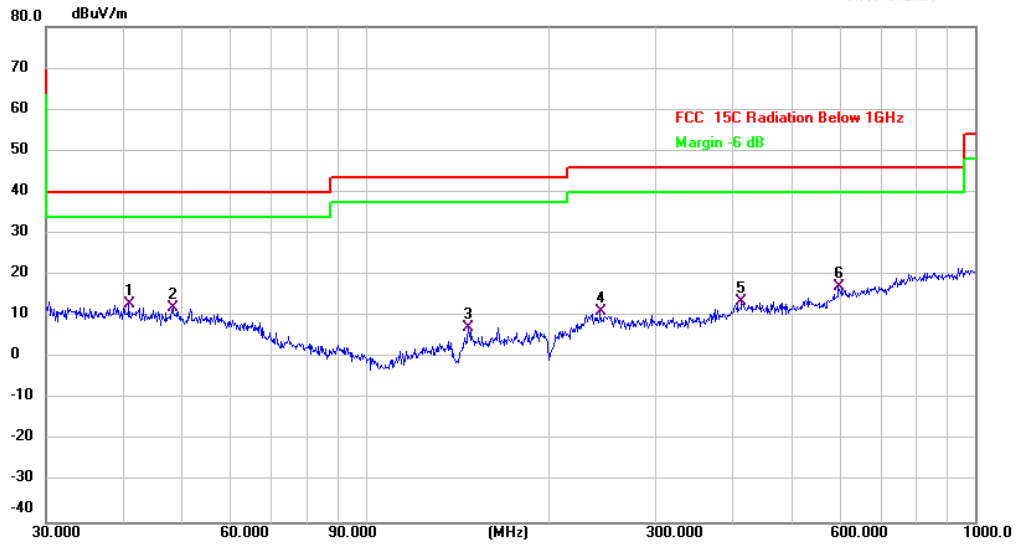

No.	Mk.	Freq. MHz	Reading Level dBuV	Correct Factor dB	Measure- ment dBuV/m	Limit dBuV/m	Over dB	Detector	Comment
1	*	40.9881	37.41	-24.53	12.88	40.00	-27.12	QP	
2		48.3318	34.82	-22.66	12.16	40.00	-27.84	QP	
3		147.4036	22.96	-15.77	7.19	43.50	-36.31	QP	
4		243.3772	30.06	-18.82	11.24	46.00	-34.76	QP	
5		414.7223	27.73	-14.20	13.53	46.00	-32.47	QP	
6		597.2234	27.76	-10.68	17.08	46.00	-28.92	QP	

TEST REPORT

Report No.: MTI250312008-0401E1

6.10 Radiated emissions (above 1GHz)

Test Requirement:	In addition, radiated emissions which fall in the restricted bands, as defined in § 15.205(a), must also comply with the radiated emission limits specified in § 15.209(a)(see § 15.205(c)).`		
Test Limit:	Frequency (MHz)	Field strength (microvolts/meter)	Measurement distance (meters)
	0.009-0.490	2400/F(kHz)	300
	0.490-1.705	24000/F(kHz)	30
	1.705-30.0	30	30
	30-88	100 **	3
	88-216	150 **	3
	216-960	200 **	3
	Above 960	500	3
	** Except as provided in paragraph (g), fundamental emissions from intentional radiators operating under this section shall not be located in the frequency bands 54-72 MHz, 76-88 MHz, 174-216 MHz or 470-806 MHz. However, operation within these frequency bands is permitted under other sections of this part, e.g., §§ 15.231 and 15.241. In the emission table above, the tighter limit applies at the band edges. The emission limits shown in the above table are based on measurements employing a CISPR quasi-peak detector except for the frequency bands 9–90 kHz, 110–490 kHz and above 1000 MHz. Radiated emission limits in these three bands are based on measurements employing an average detector.		
Test Method:	ANSI C63.10-2013 section 6.6.4 KDB 558074 D01 15.247 Meas Guidance v05r02		
Procedure:	ANSI C63.10-2013 section 6.6.4		

6.10.1 E.U.T. Operation:

Operating Environment:			
Temperature:	19.3 °C	Humidity:	45.2 %
		Atmospheric Pressure:	101 kPa
Pre test mode:	Mode1		
Final test mode:	Mode1		
Note: Test frequency are from 1GHz to 25GHz, the amplitude of spurious emissions which are attenuated more than 20 dB below the limits are not reported. All modes of operation of the EUT were investigated, and only the worst-case results are reported.			

6.10.2 Test Setup Diagram:

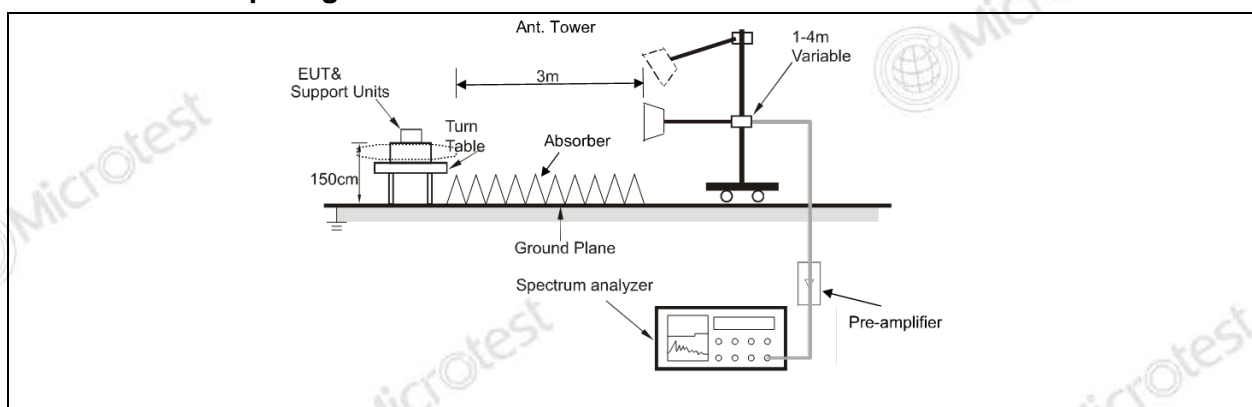

TEST REPORT

Report No.: MTi250312008-0401E1

6.10.3 Test Data:

Mode1 / Polarization: Horizontal / CH: L							
No.	Mk.	Freq.	Reading Level	Correct Factor	Measurement	Limit	Over
		MHz	dBuV	dB	dBuV/m	dBuV/m	dB
1		4804.000	45.48	0.53	46.01	74.00	-27.99
							peak
2		4804.000	40.70	0.53	41.23	54.00	-12.77
							AVG
3		7206.000	44.21	7.90	52.11	74.00	-21.89
							peak
4	*	7206.000	40.33	7.90	48.23	54.00	-5.77
							AVG
5		9608.000	44.70	8.85	53.55	74.00	-20.45
							peak
6		9608.000	38.39	8.85	47.24	54.00	-6.76
							AVG

Mode1 / Polarization: Vertical / CH: L							
No.	Mk.	Freq.	Reading Level	Correct Factor	Measurement	Limit	Over
		MHz	dBuV	dB	dBuV/m	dBuV/m	dB
1		4804.000	43.14	0.53	43.67	74.00	-30.33
							peak
2		4804.000	37.73	0.53	38.26	54.00	-15.74
							AVG
3		7206.000	44.81	7.90	52.71	74.00	-21.29
							peak
4	*	7206.000	39.64	7.90	47.54	54.00	-6.46
							AVG
5		9608.000	44.40	8.85	53.25	74.00	-20.75
							peak
6		9608.000	38.30	8.85	47.15	54.00	-6.85
							AVG

TEST REPORT

Report No.: MTi250312008-0401E1

Mode1 / Polarization: Horizontal / CH: M

No.	Mk.	Freq.	Reading Level	Correct Factor	Measurement	Limit	Over	Detector
		MHz	dBuV	dB	dBuV/m	dBuV/m	dB	
1		4882.000	43.56	0.57	44.13	74.00	-29.87	peak
2		4882.000	38.00	0.57	38.57	54.00	-15.43	AVG
3		7323.000	42.61	7.57	50.18	74.00	-23.82	peak
4		7323.000	37.66	7.57	45.23	54.00	-8.77	AVG
5		9764.000	44.04	9.33	53.37	74.00	-20.63	peak
6	*	9764.000	38.23	9.33	47.56	54.00	-6.44	AVG

Mode1 / Polarization: Vertical / CH: M

No.	Mk.	Freq.	Reading Level	Correct Factor	Measurement	Limit	Over	Detector
		MHz	dBuV	dB	dBuV/m	dBuV/m	dB	
1		4882.000	43.19	0.57	43.76	74.00	-30.24	peak
2		4882.000	37.99	0.57	38.56	54.00	-15.44	AVG
3		7323.000	43.03	7.57	50.60	74.00	-23.40	peak
4		7323.000	37.70	7.57	45.27	54.00	-8.73	AVG
5		9764.000	43.79	9.33	53.12	74.00	-20.88	peak
6	*	9764.000	40.18	9.33	49.51	54.00	-4.49	AVG

TEST REPORT

Report No.: MTi250312008-0401E1

Mode1 / Polarization: Horizontal / CH: H

No.	Mk.	Freq.	Reading Level	Correct Factor	Measurement	Limit	Over	Detector
		MHz	dBuV	dB	dBuV/m	dBuV/m	dB	
1		4960.000	44.36	0.66	45.02	74.00	-28.98	peak
2		4960.000	39.60	0.66	40.26	54.00	-13.74	AVG
3		7440.000	43.49	7.94	51.43	74.00	-22.57	peak
4		7440.000	36.33	7.94	44.27	54.00	-9.73	AVG
5		9920.000	44.30	9.69	53.99	74.00	-20.01	peak
6	*	9920.000	39.99	9.69	49.68	54.00	-4.32	AVG

Mode1 / Polarization: Vertical / CH: H

No.	Mk.	Freq.	Reading Level	Correct Factor	Measurement	Limit	Over	Detector
		MHz	dBuV	dB	dBuV/m	dBuV/m	dB	
1		4960.000	44.14	0.66	44.80	74.00	-29.20	peak
2		4960.000	39.55	0.66	40.21	54.00	-13.79	AVG
3		7440.000	43.34	7.94	51.28	74.00	-22.72	peak
4		7440.000	38.29	7.94	46.23	54.00	-7.77	AVG
5		9920.000	44.38	9.69	54.07	74.00	-19.93	peak
6	*	9920.000	40.02	9.69	49.71	54.00	-4.29	AVG

TEST REPORT

Report No.: MTi250312008-0401E1

Photographs of the test setup

Refer to Appendix - Test Setup Photos

TEST REPORT

Report No.: MTi250312008-0401E1

Photographs of the EUT

Refer to Appendix - EUT Photos

Appendix

TEST REPORT

Report No.: MTi250312008-0401E1

Appendix A: 20dB Emission Bandwidth

Test Result

Test Mode	Antenna	Frequency [MHz]	20db EBW [MHz]
GFSK	Ant1	2402	0.936
		2441	0.951
		2480	0.948

TEST REPORT

Report No.: MTi250312008-0401E1

Test Graphs



TEST REPORT

Report No.: MTi250312008-0401E1



TEST REPORT

Report No.: MTi250312008-0401E1

Appendix B: Maximum conducted output power

Test Result Peak

Test Mode	Antenna	Frequency [MHz]	Conducted Peak Power [dBm]	Limit [dBm]	Verdict
GFSK	Ant1	2402	-3.62	≤20.97	PASS
		2441	-2.68	≤20.97	PASS
		2480	-2.24	≤20.97	PASS

TEST REPORT

Report No.: MTI250312008-0401E1

Test Graphs

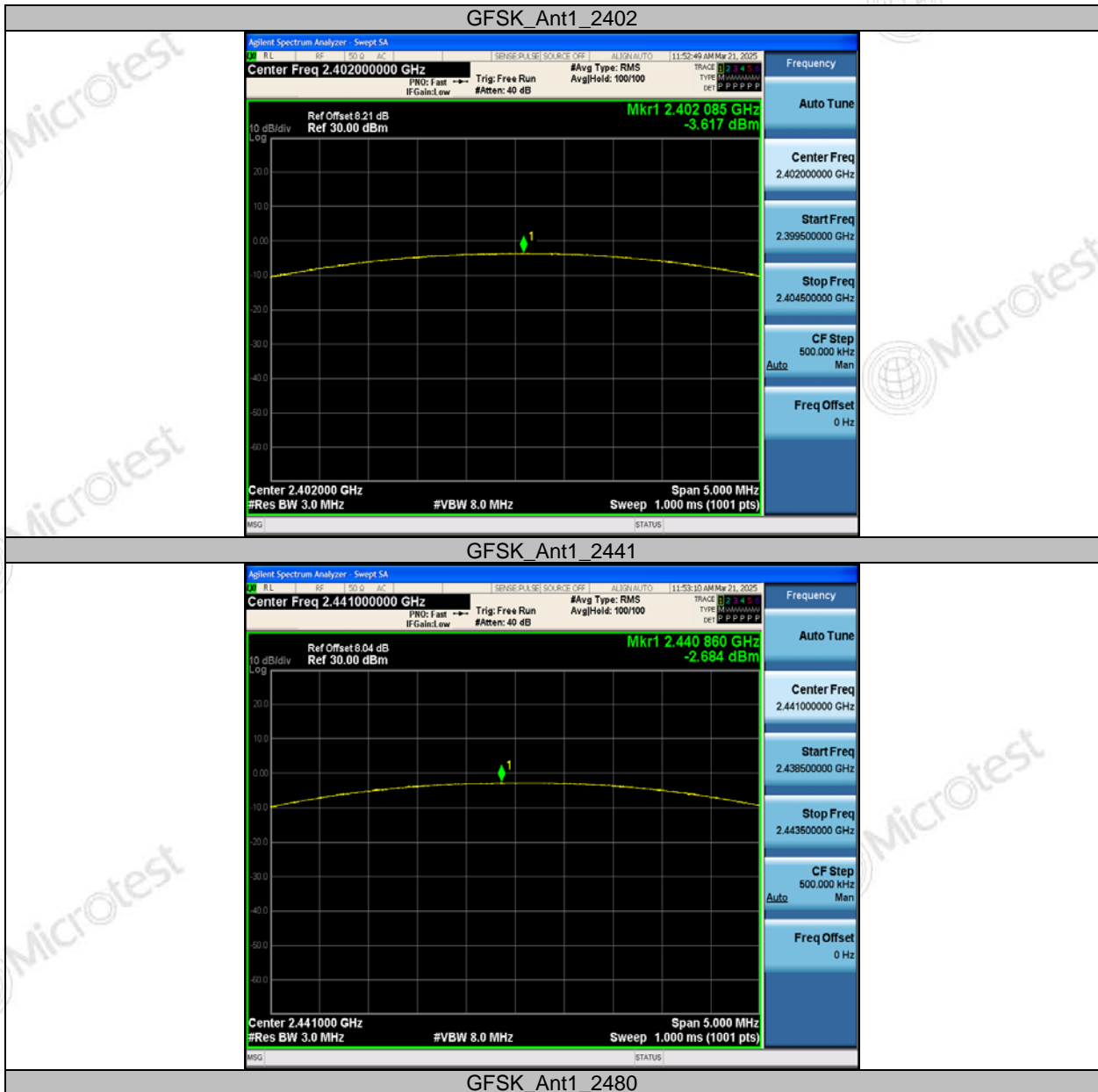

TEST REPORT

Report No.: MTi250312008-0401E1



TEST REPORT

Report No.: MTi250312008-0401E1

Appendix C: Carrier frequency separation

Test Result

Test Mode	Antenna	Frequency [MHz]	Result [MHz]	Limit [MHz]	Verdict
GFSK	Ant1	Hop	1.014	≥0.634	PASS

TEST REPORT

Report No.: MTi250312008-0401E1

Test Graphs

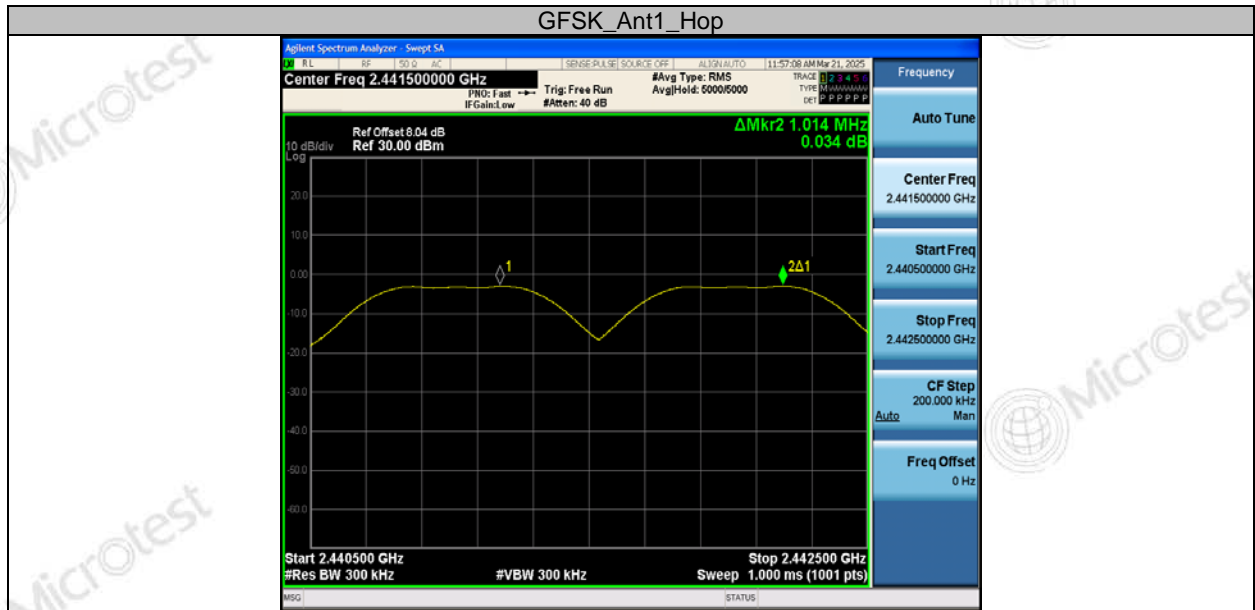

TEST REPORT

Report No.: MTi250312008-0401E1

Appendix D: Time of occupancy

Test Result

Test Mode	Antenna	Frequency [MHz]	BurstWidth [ms]	Hops in 31.6s [Num]	Result [s]	Limit [s]	Verdict
GFSK	Ant1	Hop	2.874	77	0.221	≤0.4	PASS

Notes:

1. Period time = 0.4s * 79 = 31.6s
2. Result (Time of occupancy) = BurstWidth[ms] * Hops in 31.6s [Num]

TEST REPORT

Report No.: MTi250312008-0401E1

Test Graphs

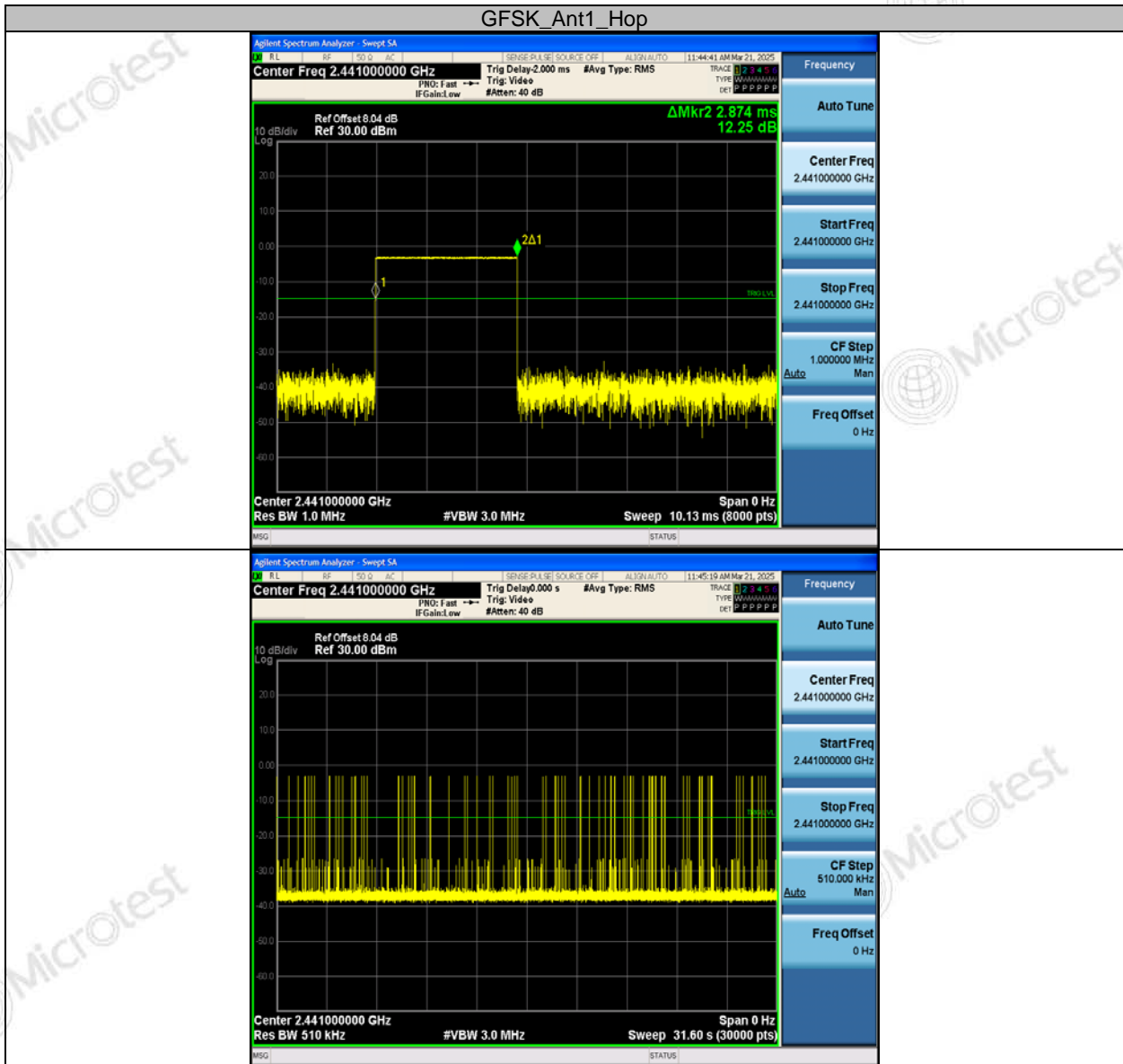

TEST REPORT

Report No.: MTi250312008-0401E1

Appendix E: Number of hopping channels

Test Result

Test Mode	Antenna	Frequency [MHz]	Result [Num]	Limit [Num]	Verdict
GFSK	Ant1	Hop	79	≥15	PASS

TEST REPORT

Report No.: MTi250312008-0401E1

Test Graphs

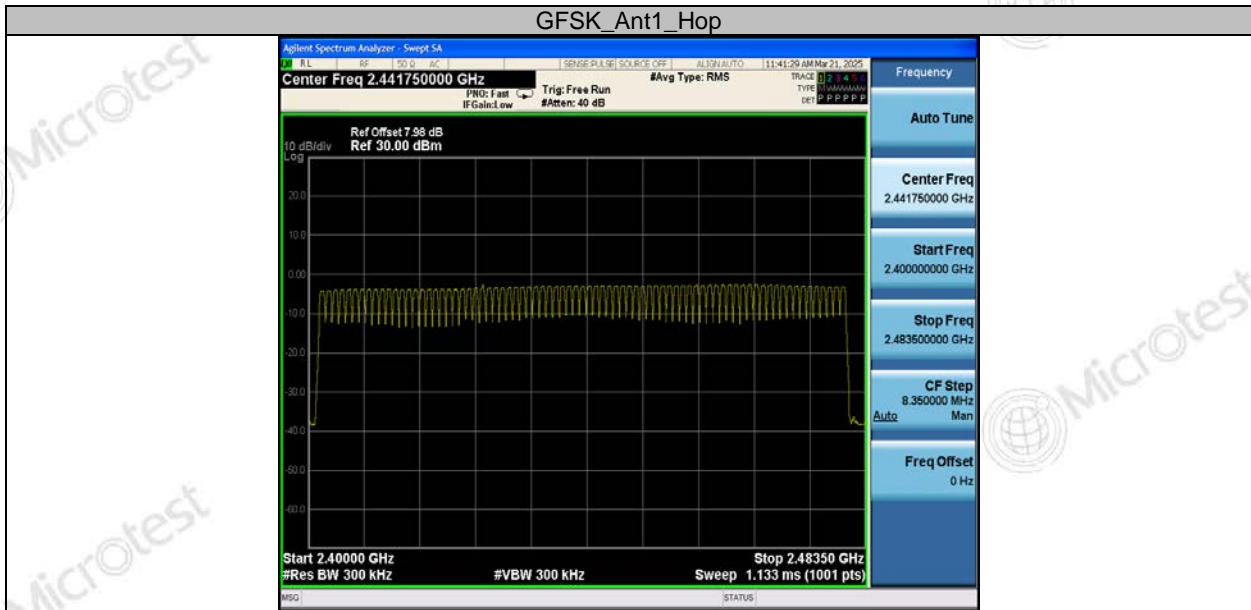

TEST REPORT

Report No.: MTI250312008-0401E1

Appendix F: Band edge measurements

Test Graphs

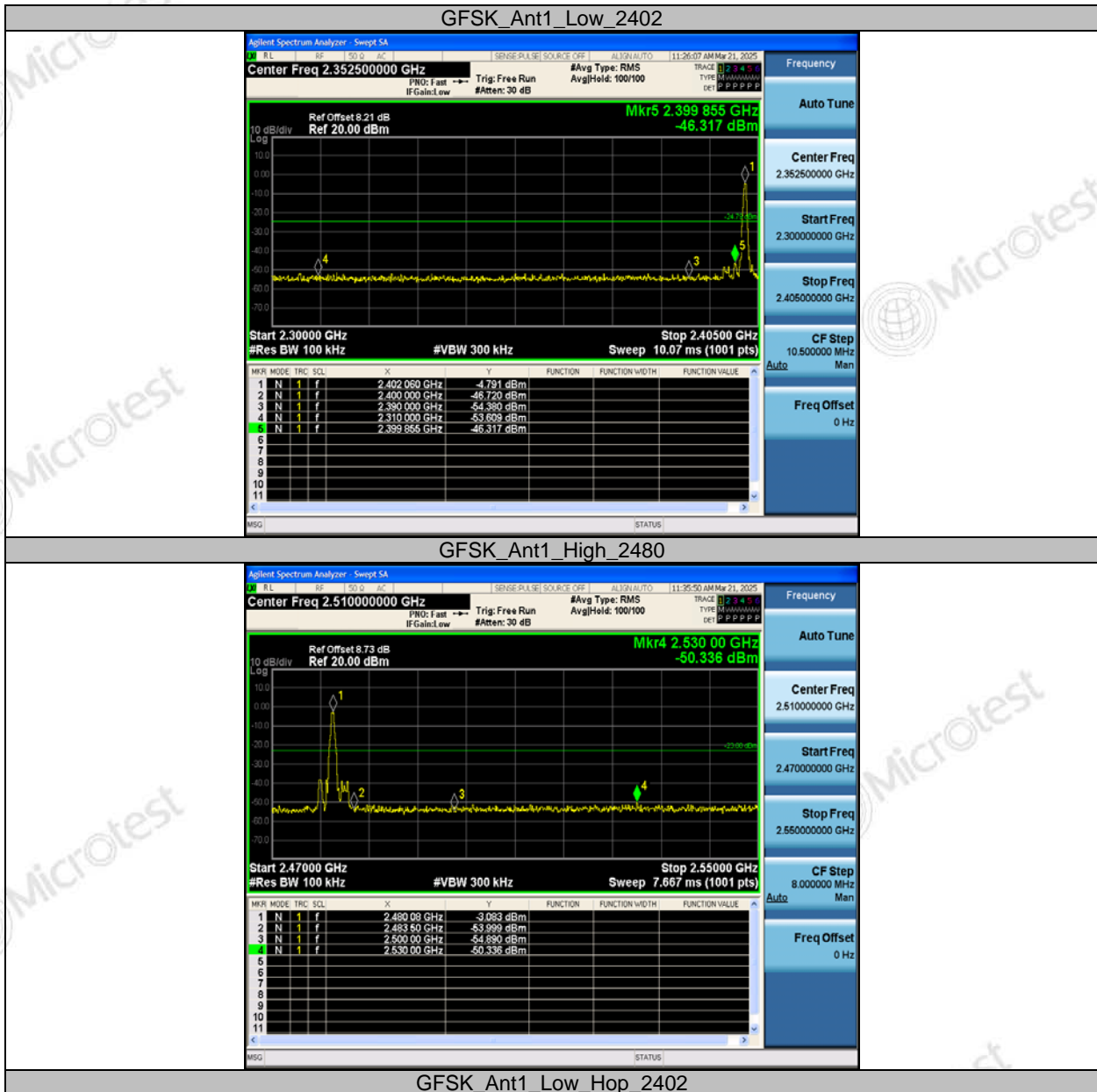

TEST REPORT

Report No.: MTI250312008-0401E1

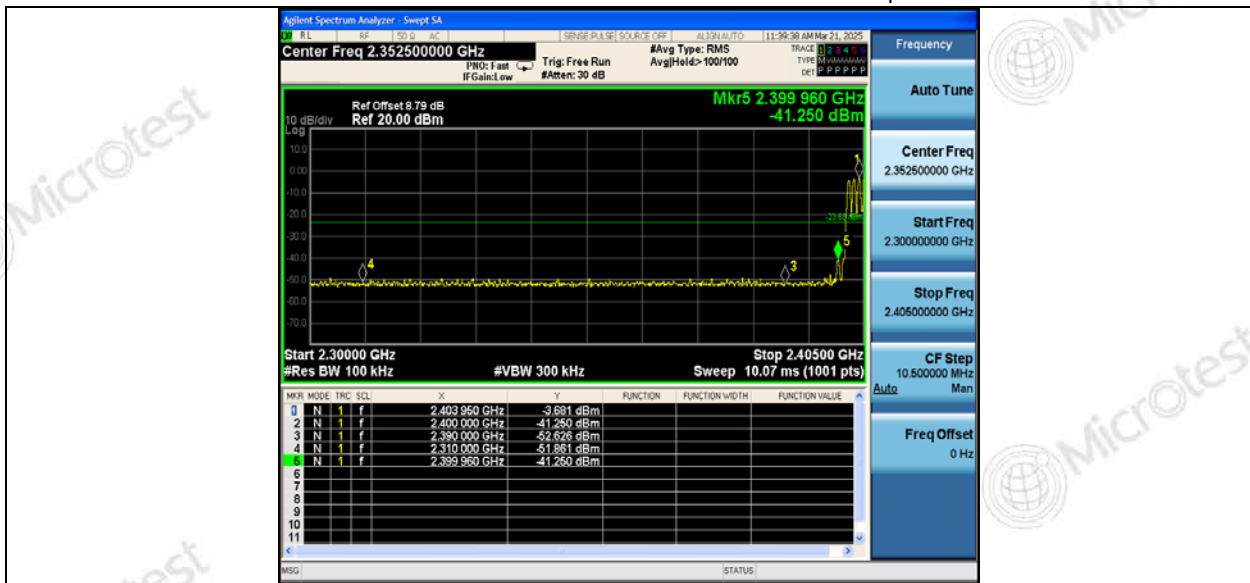

GFSK_Ant1_High_Hop_2480

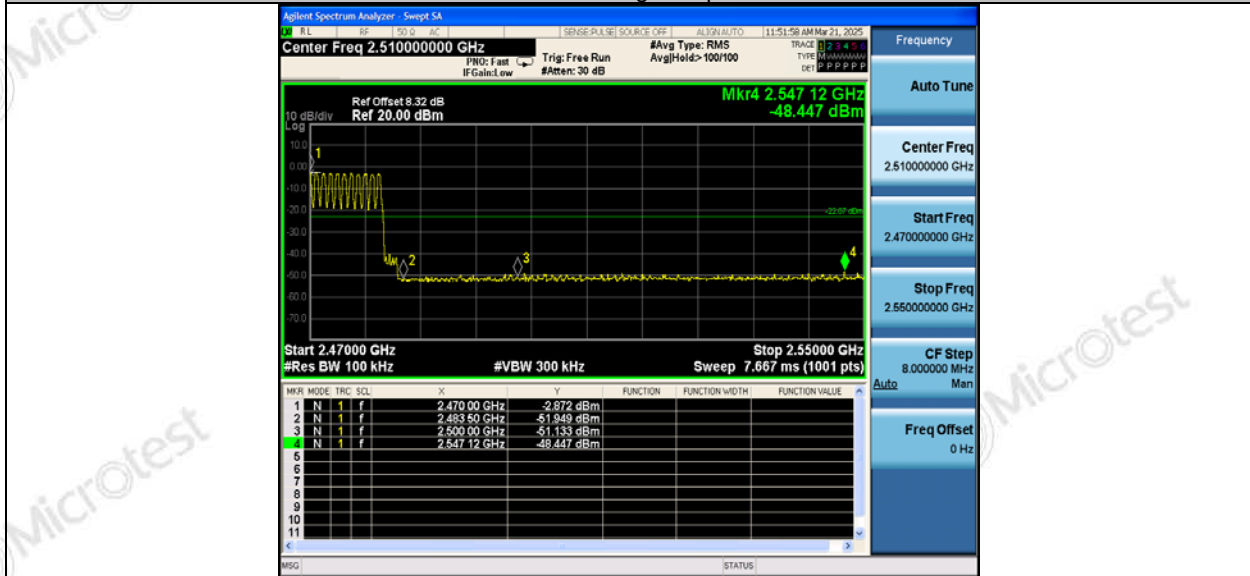

TEST REPORT

Report No.: MTI250312008-0401E1

Appendix G: Conducted Spurious Emission

Test Graphs

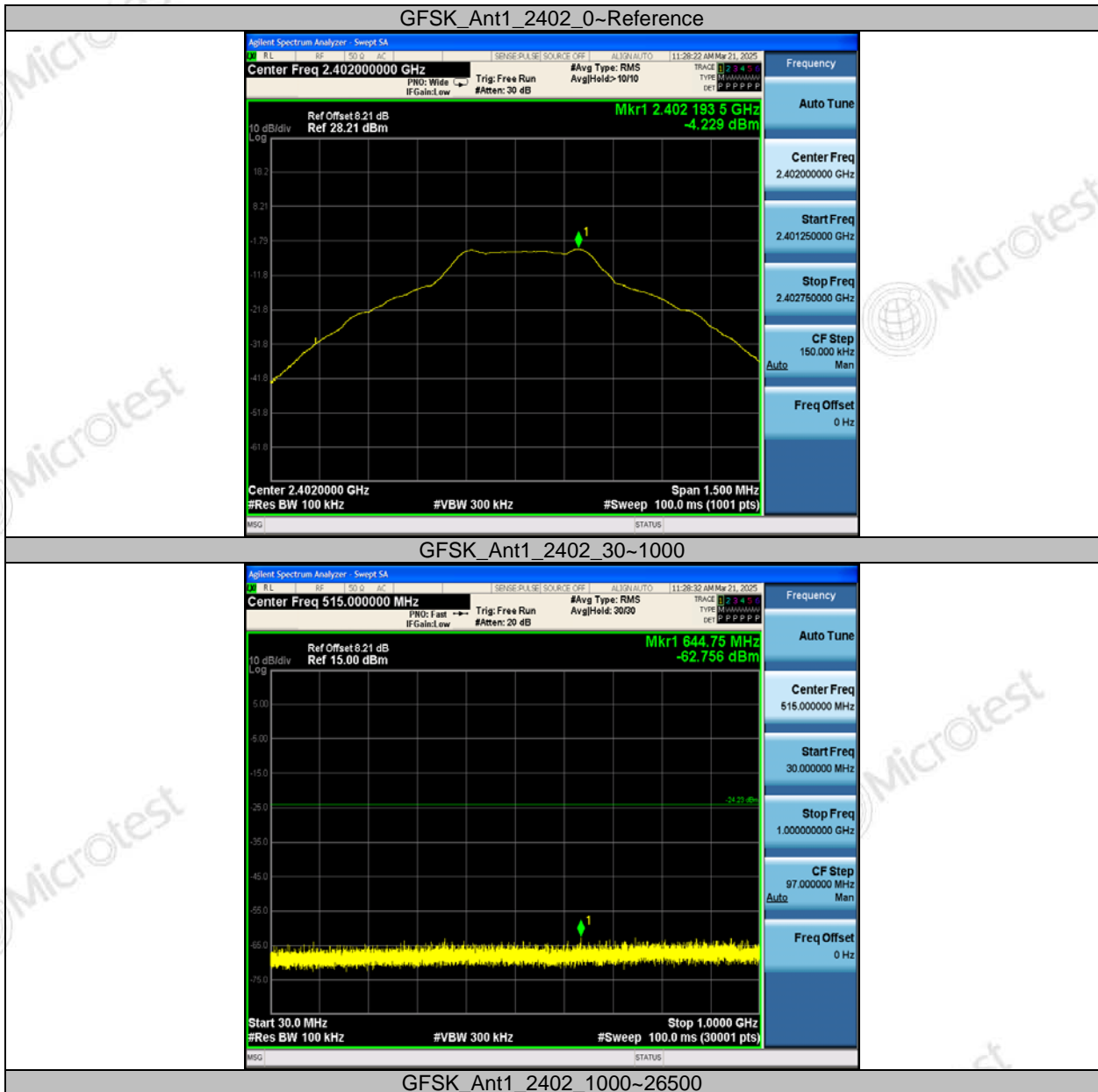

TEST REPORT

Report No.: MTI250312008-0401E1



GFSK_Ant1_2441_0~Reference



GFSK_Ant1_2441_30~1000

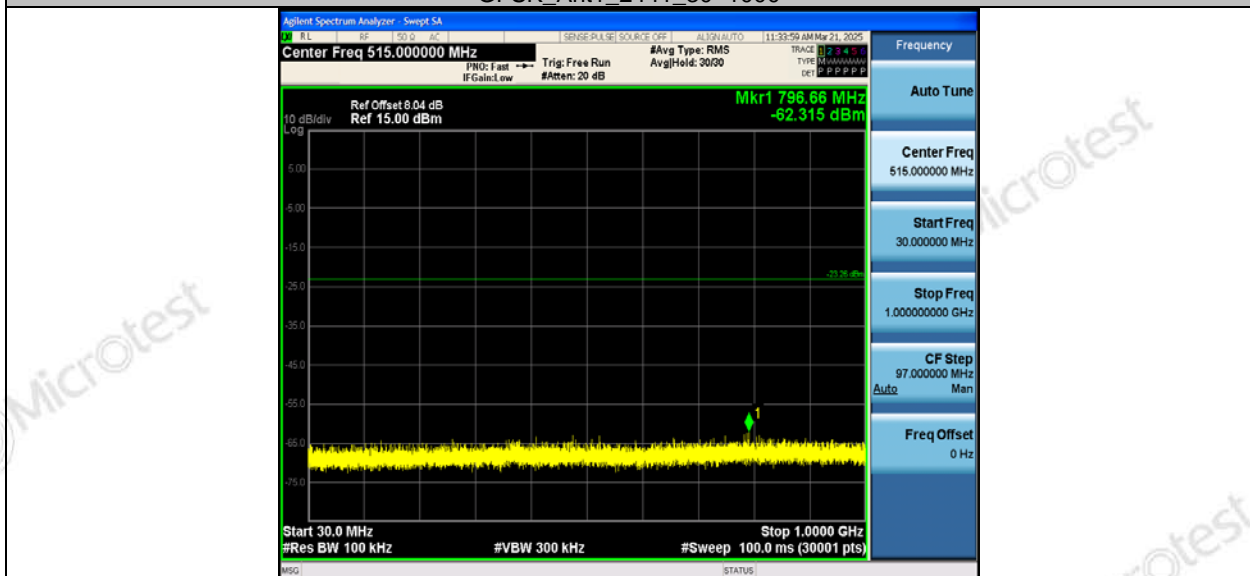

TEST REPORT

Report No.: MTi250312008-0401E1

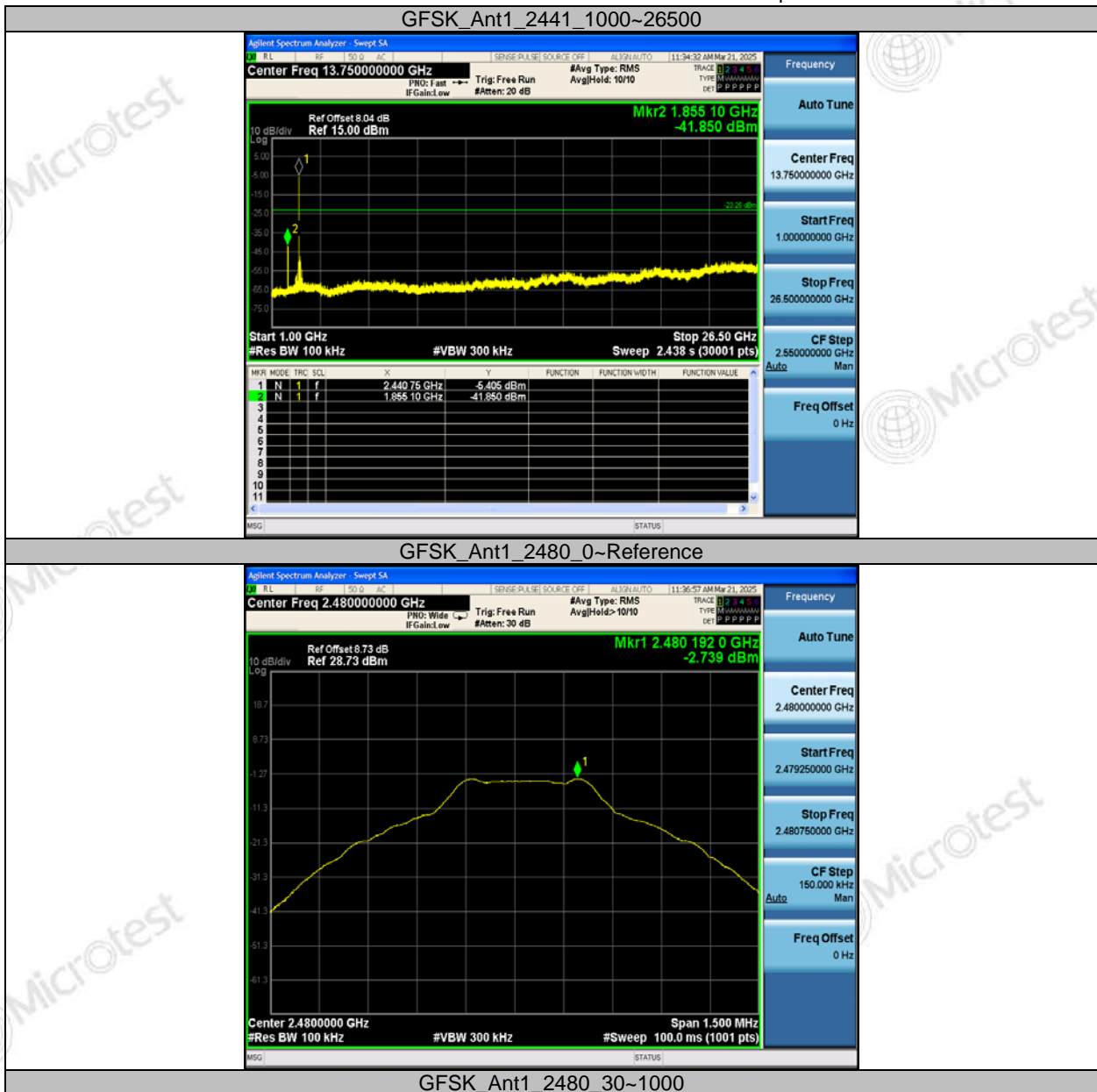

TEST REPORT

Report No.: MTi250312008-0401E1

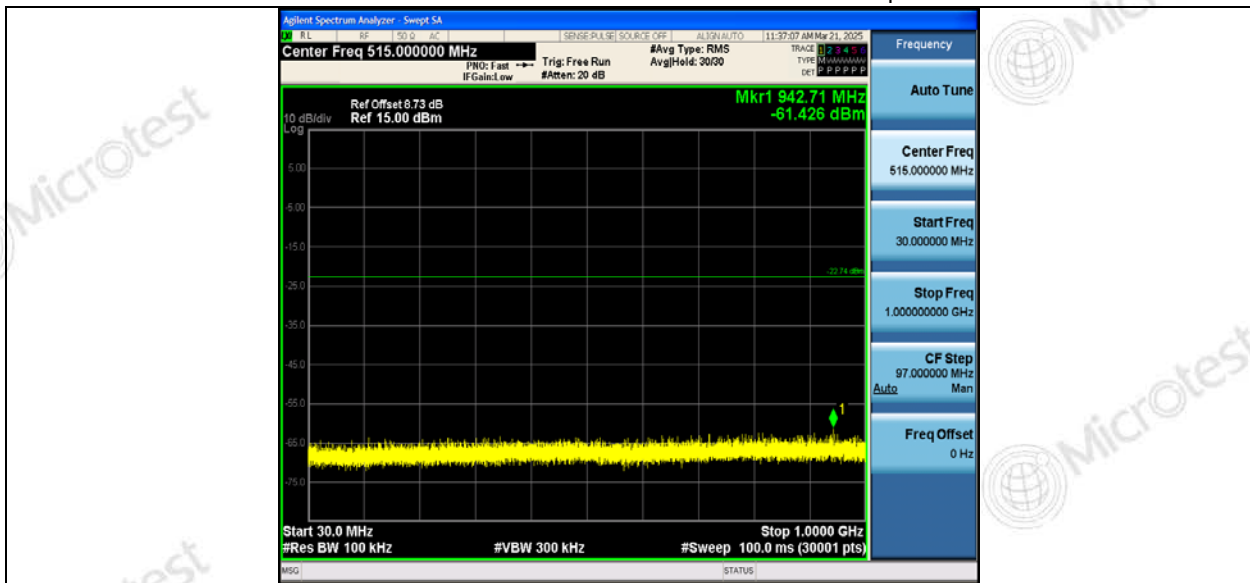

GFSK_Ant1_2480_1000~26500

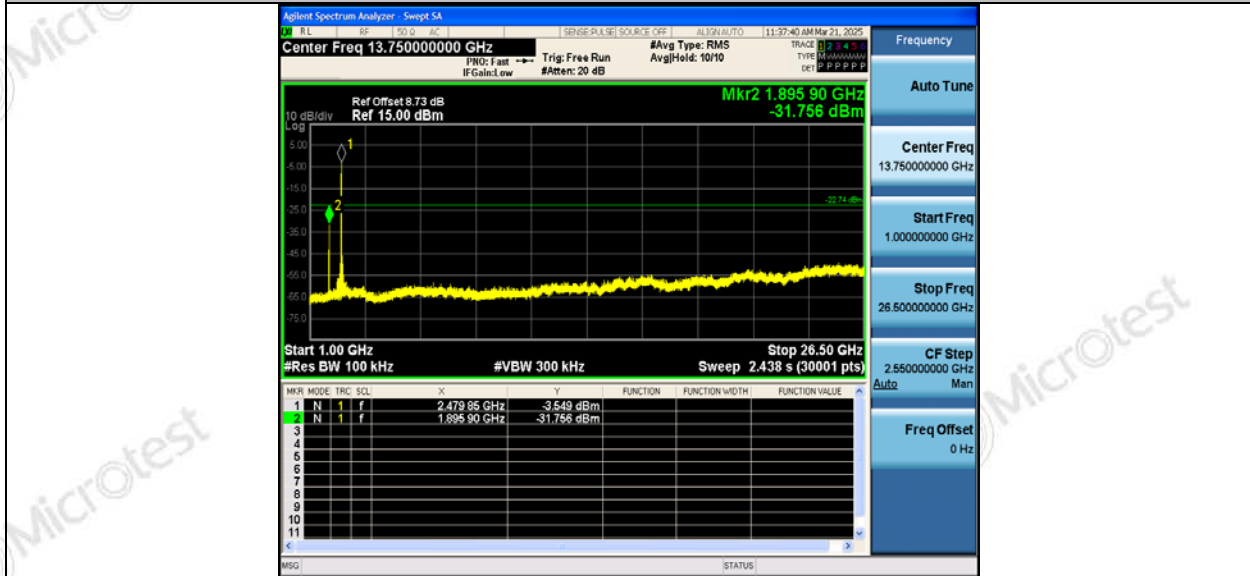

Statement

1. This report is invalid without the seal and signature of the laboratory.
2. The test results of this report are only responsible for the samples submitted. Client shall be responsible for representativeness of the sample and authenticity of the material.
3. The report shall not be partially reproduced without the written consent of the Laboratory.
4. This report is invalid if transferred, altered or tampered with in any form without authorization.
5. The observations or tests with special mark fall outside the scope of accreditation, and are only used for purpose of commission, research, training, internal quality control etc.
6. Any objection to this report shall be submitted to the laboratory within 15 days from the date of receipt of the report.

***** END OF REPORT *****