



# TEST REPORT



**DT&C Co., Ltd.**

42, Yurim-ro, 154Beon-gil, Cheoin-gu, Yongin-si, Gyeonggi-do, Korea, 17042  
Tel : 031-321-2664, Fax : 031-321-1664

1. Report No : DRTFCC1811-0256
2. Customer
  - Name: SEOJINFNI Co., LTD
  - Address : #632, 21, Baekbeom-ro 31-gil Mapo-gu, Seoul, South Korea
3. Use of Report : FCC Original Grant
4. Product Name / Model Name : ZEROi SMART HAT / ZEROi  
FCC ID : 2ARMAZEROI
5. Test Method Used : ANSI C63.10-2013  
Test Specification : FCC Part 15 Subpart C.247
6. Date of Test : 2018.08.13 ~ 2018.11.01
7. Testing Environment : See appended test report.
8. Test Result : Refer to the attached test result.

Affirmation	Tested by	Reviewed by
	Name : JaeHyeok Bang 	Name : GeunKi Son 

The test results presented in this test report are limited only to the sample supplied by applicant and the use of this test report is inhibited other than its purpose. This test report shall not be reproduced except in full, without the written approval of DT&C Co., Ltd.

2018 . 11 . 02.

**DT&C Co., Ltd.**

If this report is required to confirmation of authenticity, please contact to [report@dtnc.net](mailto:report@dtnc.net)

## Test Report Version

Test Report No.	Date	Description
DRTFCC1811-0256	Nov. 02, 2018	Initial issue

## Table of Contents

<b>1. General Information</b> .....	<b>4</b>
1.1 Testing Laboratory .....	4
1.2 Testing Environment .....	4
1.3 Measurement Uncertainty .....	4
1.4 Details of Applicant .....	5
1.5 Description of EUT .....	5
1.6 Declaration by the applicant / manufacturer .....	5
1.7 Information about the FHSS characteristics .....	6
1.8 Test Equipment List.....	7
1.9 Summary of Test Results.....	8
1.10 Conclusion of worst-case and operation mode.....	9
<b>2. Maximum Peak Output Power Measurement</b> .....	<b>10</b>
2.1 Test Setup .....	10
2.2 Limit.....	10
2.3 Test Procedure.....	10
2.4 Test Results .....	11
<b>3. 20 dB BW</b> .....	<b>17</b>
3.1 Test Setup .....	17
3.2 Limit.....	17
3.3 Test Procedure.....	17
3.4 Test Results .....	17
<b>4. Carrier Frequency Separation</b> .....	<b>23</b>
4.1 Test Setup .....	23
4.2 Limit.....	23
4.3 Procedure.....	23
4.4 Test Results .....	23
<b>5. Number of Hopping Frequencies</b> .....	<b>28</b>
5.1 Test Setup .....	28
5.2 Limit.....	28
5.3 Procedure.....	28
5.4 Test Results .....	28
<b>6. Time of Occupancy (Dwell Time)</b> .....	<b>34</b>
6.1 Test Setup .....	34
6.2 Limit.....	34
6.3 Test Procedure.....	34
6.4 Test Results .....	34
<b>7. Transmitter Radiated Spurious Emissions and Conducted Spurious Emission</b> .....	<b>39</b>
7.1 Test Setup .....	39
7.2 Limit.....	39
7.3. Test Procedures.....	40
7.3.1. Test Procedures for Radiated Spurious Emissions .....	40
7.3.2. Test Procedures for Conducted Spurious Emissions.....	41
7.4. Test Results .....	42
7.4.1. Radiated Emissions .....	42
7.4.2. Conducted Spurious Emissions .....	45
<b>8. Transmitter AC Power Line Conducted Emission</b> .....	<b>69</b>
8.1 Test Setup .....	69
8.2 Limit.....	69
8.3 Test Procedures.....	69
8.4 Test Results .....	70
<b>9. Antenna Requirement</b> .....	<b>72</b>
<b>APPENDIX I</b> .....	<b>73</b>
<b>APPENDIX II</b> .....	<b>74</b>

## 1. General Information

### 1.1 Testing Laboratory

<b>DT&amp;C Co., Ltd.</b>		
The 3 m test site and conducted measurement facility used to collect the radiated data are located at the 42, Yurim-ro, 154beon-gil, Cheoin-gu, Yongin-si, Gyeonggi-do, Korea 17042. The test site complies with the requirements of § 2.948 according to ANSI C63.4-2014.		
<b>- FCC MRA Accredited Test Firm No. : KR0034</b>		
<a href="http://www.dtnc.net">www.dtnc.net</a>		
Telephone	:	+ 82-31-321-2664
FAX	:	+ 82-31-321-1664

### 1.2 Testing Environment

Ambient Condition	
▪ Temperature	+23 °C ~ +25 °C
▪ Relative Humidity	43 % ~ 46 %

### 1.3 Measurement Uncertainty

The measurement uncertainties shown below were calculated in accordance with requirements of ANSI C63.4-2014 and ANSI C63.10-2013. All measurement uncertainty values are shown with a coverage factor of  $k = 2$  to indicate a 95 % level of confidence.

Test items	Measurement uncertainty
Transmitter Output Power	0.9 dB (The confidence level is about 95 %, $k = 2$ )
Conducted spurious emission	0.9 dB (The confidence level is about 95 %, $k = 2$ )
AC conducted emission	2.4 dB (The confidence level is about 95 %, $k = 2$ )
Radiated spurious emission (1 GHz Below)	5.1 dB (The confidence level is about 95 %, $k = 2$ )
Radiated spurious emission (1 GHz ~ 18 GHz)	5.4 dB (The confidence level is about 95 %, $k = 2$ )
Radiated spurious emission (18 GHz Above)	5.3 dB (The confidence level is about 95 %, $k = 2$ )

### 1.4 Details of Applicant

Applicant : SEOJINFNI CO., LTD  
 Address : #632, 21, Baekbeom-ro 31-gil Mapo-gu, Seoul, South Korea  
 Contact person : TaeKyeong Oh

### 1.5 Description of EUT

<b>EUT</b>	ZEROi SMART HAT
<b>Model Name</b>	ZEROi
<b>Add Model Name</b>	NA
<b>Hardware Version</b>	REV 1.1
<b>Software Version</b>	REV 1.2
<b>Power Supply</b>	DC 3.7 V
<b>Frequency Range</b>	2402 MHz ~ 2480 MHz
<b>Modulation Technique</b>	GFSK, $\pi/4$ DQPSK, 8DPSK
<b>Number of Channels</b>	79
<b>Antenna Type</b>	Chip Antenna
<b>Antenna Gain</b>	PK : 0.06 dBi

### 1.6 Declaration by the applicant / manufacturer

- NA

## 1.7 Information about the FHSS characteristics

- This Bluetooth module has been tested by a Bluetooth Qualification Lab, and we confirm the following :

A) The hopping sequence is pseudorandom

Note 1 : Pseudorandom Frequency Hopping Sequence Table as below:

Channel: 08, 24, 40, 56, 42, 54, 72, 09, 01, 11, 33, 41, 34, 42, 65, 73, 53, 69, 06, 22, 04, 20,  
36, 52, 38, 46, 70, 78, 68, 76, 21, 29, 10, 26, 41, 58, 44, 60, 76, 13, 03, 11, 35, 43,  
37, 45, 69, 77, 52, 71, 08, 24, 06, 24, 48, 56, 45, 46, 70, 01, 72, 06, 25, 33, 12, 28,  
49, 60, 45, 58, 74, 13, 05, 18, 37, 49 etc

.. The System receiver have input bandwidths that match the hopping channel bandwidths of their corresponding transmitters and shift frequencies in synchroniztation with the transmitted signals.

B) All channels are used equally on average

C) The receiver input bandwidth equals the transmit bandwidth

D) The receiver hops in sequence with the transmit signal

- 15.247(g) : In accordance with the Bluetooth Industry Standard, the system is designed to comply with all of the regulations in Section 15.247 when the transmitter is presented with a continuous data (or information) system.

- 15.247(h) : In accordance with the Bluetooth Industry Standard, the system does not coordinate its channels selection / hopping sequence with other frequency hopping systems for the express purpose of avoiding the simultaneous occupancy of individual hopping frequencies by multiple transmitters.

- 15.247(h) : The EUT employs Adaptive Frequency Hopping (AFH) which identifies sources of interference namely devices operating in 802.11 WLAN and excludes them from the list of available channels. The process of re-mapping reduces the number of test channels from 79 channels to a minimum number of 20 channels.

## 1.8 Test Equipment List

Type	Manufacturer	Model	Cal.Date (yy/mm/dd)	Next.Cal.Date (yy/mm/dd)	S/N
Spectrum Analyzer	Agilent Technologies	N9020A	18/07/09	19/07/09	MY46471251
Spectrum Analyzer	Agilent Technologies	N9020A	17/12/26	18/12/26	MY50200828
Multimeter	FLUKE	17B+	17/12/26	18/12/26	26030065WS
BlueTooth Tester	TESCOM	TC-3000C	17/12/26	18/12/26	3000C000396
Signal Generator	Rohde Schwarz	SMBV100A	17/12/27	18/12/27	255571
Signal Generator	Rohde Schwarz	SMF100A	18/06/07	19/06/07	102341
Power Splitter	Anritsu	K241B	17/12/27	18/12/27	1301182
Thermohyrometer	BODYCOM	BJ5478	18/01/03	19/01/03	120612-1
Thermohyrometer	BODYCOM	BJ5478	18/01/03	19/01/03	120612-2
HYGROMETER	TESTO	608-H1	18/02/10	19/02/10	34862883
Loop Antenna	Schwarzbeck	FMZB1513	18/01/30	20/01/30	1513-128
BILOG ANTENNA	Schwarzbeck	VULB 9160	18/07/13	20/07/13	3359
HORN ANT	ETS	3117	18/05/10	20/05/10	140394
HORN ANT	A.H.Systems	SAS-574	17/07/31	19/07/31	155
PreAmplifier	Agilent Technologies	8449B	18/07/05	19/07/05	3008A02108
PreAmplifier	H.P	8447D	17/12/26	18/12/26	2944A07774
LISN	SCHWARZBECK	NNLK 8121	18/03/20	19/03/20	6183
PULSE LIMITER	Rohde Schwarz	ESH3-Z2	17/09/29	18/09/29	101333
			18/09/27	19/09/27	
EMI Test Receiver	Rohde Schwarz	ESR7	18/02/13	19/02/13	101061
EMI Test Receiver	Rohde Schwarz	ESCI7	18/02/12	19/02/12	100910
High-pass filter	Wainwright	WHKX12-2580-3000-18000-80SS	18/07/05	19/07/05	3
High-pass filter	Wainwright	WHNX6-6320-8000-26500-40CC	18/07/05	19/07/05	1
Power Meter & Wide Bandwidth Sensor	Anritsu	ML2495A	18/04/17	19/04/17	1306007
		MA2490A	18/04/17	19/04/17	1249001
CABLE	Radiall	TESTPRO3	18/07/06	19/07/06	M-01
CABLE	HUBER+SUHNER	SUCOFLEX103	18/07/06	19/07/06	M-03
CABLE	DTNC	CABLE	18/07/06	19/07/06	M-04
CABLE	DTNC	CABLE	18/06/25	19/06/25	RF-08
CABLE	DTNC	CABLE	18/07/05	19/07/05	RF-82
CABEL	DTNC	CABLE	18/07/04	19/07/04	RF-62

Note 1: The measurement antennas were calibrated in accordance to the requirements of ANSI C63.5-2017.

Note 2: The cable is not a regular calibration item, so it has been calibrated by DT & C itself.

## 1.9 Summary of Test Results

FCC Part RSS Std.	Parameter	Limit (Using in 2400~ 2483.5 MHz)	Test Condition	Status Note 1
15.247(a) RSS-247(5.1)	Carrier Frequency Separation	>= 25 kHz or >= Two thirds of the 20 dB BW, whichever is greater.	Conducted	C
	Number of Hopping Frequencies	>= 15 hops		C
	20 dB Bandwidth	N/A		C
	Dwell Time	=< 0.4 seconds		C
15.247(b) RSS-247(5.4)	Transmitter Output Power	<b>For FCC</b> =< 1 Watt , if CHs >= 75 Others =< 0.125 W <b>For IC</b> if CHs >= 75 =< 1 Watt For Conducted Power =< 4 Watt For e.i.r.p, Others =< 0.125 W For Conducted Power. =< 0.5 Watt For e.i.r.p		C
15.247(d) RSS-247(5.5)	Conducted Spurious Emissions	The radiated emission to any 100 kHz of out-band shall be at least 20 dB below the highest in-band spectral density.	C	
RSS Gen(6.7)	Occupied Bandwidth (99 %)	N/A		NA
15.247(d) 15.205 & 209 RSS-247(5.5) RSS-Gen (8.9 & 8.10)	Radiated Spurious Emissions	FCC 15.209 Limits	Radiated	C <sup>Note3</sup>
15.207 RSS-Gen(8.8)	AC Conducted Emissions	FCC 15.207 Limits	AC Line Conducted	C
15.203	Antenna Requirements	FCC 15.203	-	C

Note 1 : **C** = Comply    **NC** = Not Comply    **NT** = Not Tested    **NA** = Not Applicable

Note 2 : For radiated emission tests below 30 MHz were performed on semi-anechoic chamber which is correlated with OATS.

Note 3 : This test item was performed in each axis and the worst case data was reported.



### 1.10 Conclusion of worst-case and operation mode

The EUT has three types of modulation (GFSK,  $\pi/4$ DQPSK and 8DPSK).

Therefore all applicable requirements were tested with all the modulations.

And packet type was tested at the worst case(DH5).

The field strength of spurious emission was measured in three orthogonal EUT positions (X-axis, Y-axis and Z-axis).

#### Tested frequency information,

- Hopping Function : Enable

	TX Frequency (MHz)	RX Frequency (MHz)
<b>Hopping Band</b>	2402 ~ 2480	2402 ~ 2480

- Hopping Function : Disable

	TX Frequency (MHz)	RX Frequency (MHz)
<b>Lowest Channel</b>	2402	2402
<b>Middle Channel</b>	2441	2441
<b>Highest Channel</b>	2480	2480

## 2. Maximum Peak Output Power Measurement

### 2.1 Test Setup

Refer to the APPENDIX I.

### 2.2 Limit

#### ■ FCC Requirements

The maximum peak output power of the intentional radiator shall not exceed the following :

1. §15.247(a)(1), Frequency hopping systems shall have hopping channel carrier frequencies separated by a minimum of 25 kHz or the 20 dB bandwidth of the hopping channel, whichever is greater. Alternatively, frequency hopping systems operating in the 2400-2483.5 MHz band may have hopping channel carrier frequencies that are separated by 25 kHz or two-thirds of the 20 dB bandwidth of the hopping channel, whichever is greater, provided the systems operate with an output power no greater than 125 mW.
2. §15.247(b)(1), For frequency hopping systems operating in the 2400 – 2483.5 MHz employing at least 75 non-overlapping hopping channels, and all frequency hopping systems in the 5725 – 5805 MHz band : 1 Watt. For all other frequency hopping systems in the 2400-2483.5 MHz band: 0.125 watts.

#### ■ IC Requirements

1. RSS-247(5.4) (b), For FHSS operating in the band 2400 - 2483.5 MHz, the maximum peak conducted output power shall not exceed 1.0 W if the hopset uses 75 or more hopping channels, the maximum peak conducted output power shall not exceed 0.125 W if the hopset uses less than 75 hopping channels. The e.i.r.p shall not exceed 4 W, except as provided in section 5.4(e)

### 2.3 Test Procedure

1. The RF output power was measured with a spectrum analyzer connected to the RF Antenna connector (conducted measurement) while EUT was operating in transmit mode at the appropriate center frequency, A spectrum analyzer was used to record the shape of the transmit signal.
2. The peak output power of the fundamental frequency was measured with the spectrum analyzer using ;  
Span = approximately 5 times of the 20 dB bandwidth, centered on a hopping channel  
RBW  $\geq$  20 dB BW  
VBW  $\geq$  RBW  
Sweep = auto  
Detector function = peak  
Trace = max hold

## 2.4 Test Results

Modulation	Tested Channel	Frame Average Output Power		Peak Output Power	
		dBm	mW	dBm	mW
<b><u>GFSK</u></b>	<b>Lowest</b>	2.40	1.74	3.33	2.15
	<b>Middle</b>	2.43	1.75	3.34	2.16
	<b>Highest</b>	<b>2.81</b>	<b>1.91</b>	<b>3.92</b>	<b>2.47</b>
<b><u><math>\pi/4</math>DQPSK</u></b>	<b>Lowest</b>	0.66	1.16	3.18	2.08
	<b>Middle</b>	0.69	1.17	3.23	2.10
	<b>Highest</b>	<b>1.03</b>	<b>1.27</b>	<b>3.77</b>	<b>2.38</b>
<b><u>8DPSK</u></b>	<b>Lowest</b>	0.67	1.17	3.35	2.16
	<b>Middle</b>	0.70	1.17	3.41	2.19
	<b>Highest</b>	<b>1.02</b>	<b>1.26</b>	<b>3.96</b>	<b>2.49</b>

Note 1 : The Frame average output power was tested using an average power meter for reference only.

Note 2 : See next pages for actual measured spectrum plots.

Peak Output Power

Lowest Channel & Modulation : GFSK

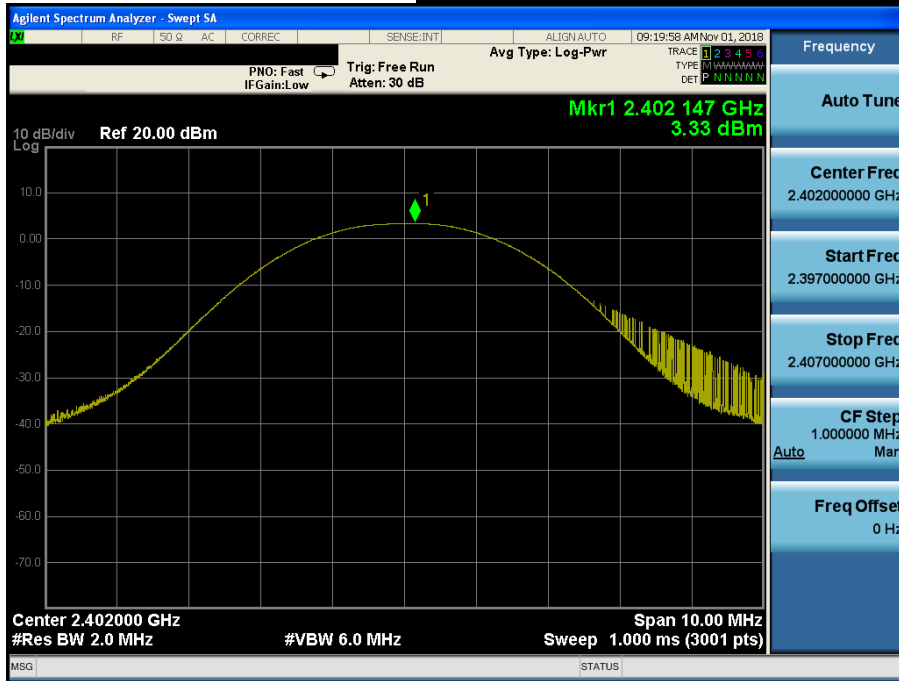

Peak Output Power

Middle Channel & Modulation : GFSK

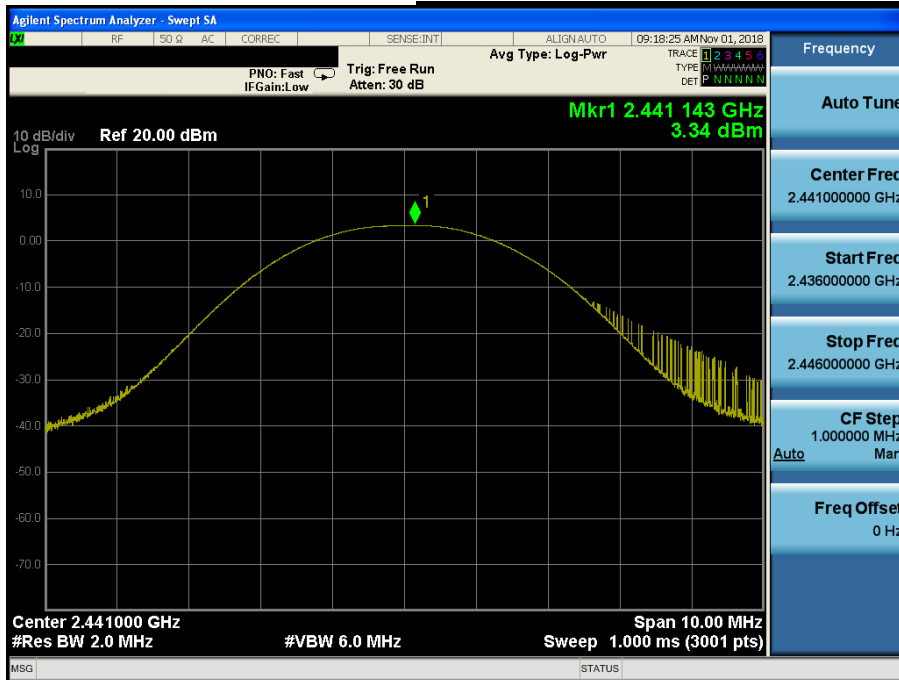

Peak Output Power

Highest Channel & Modulation : GFSK

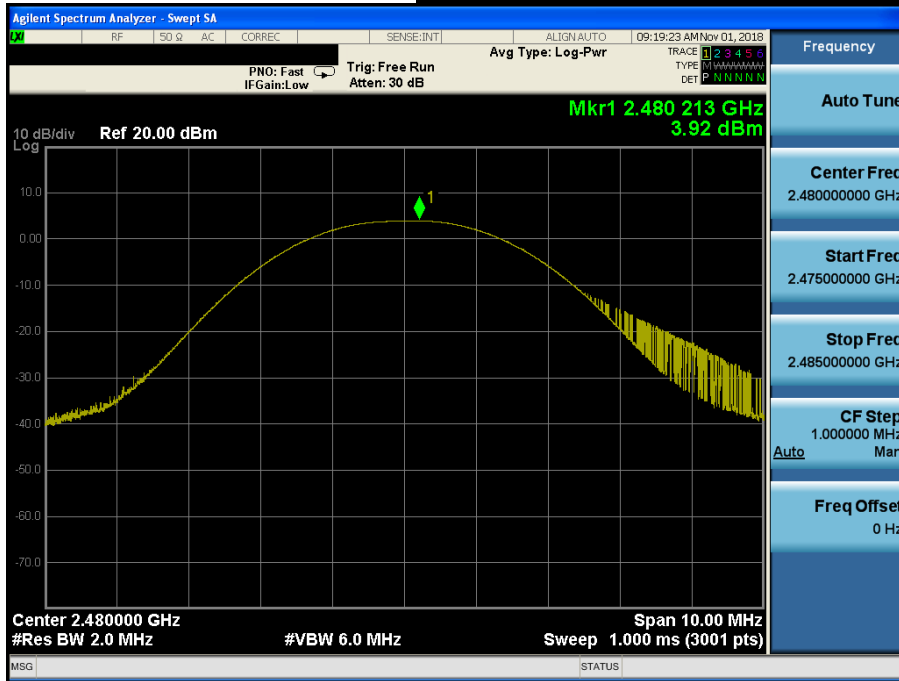

Peak Output Power

Lowest Channel & Modulation :  $\pi/4$ DQPSK

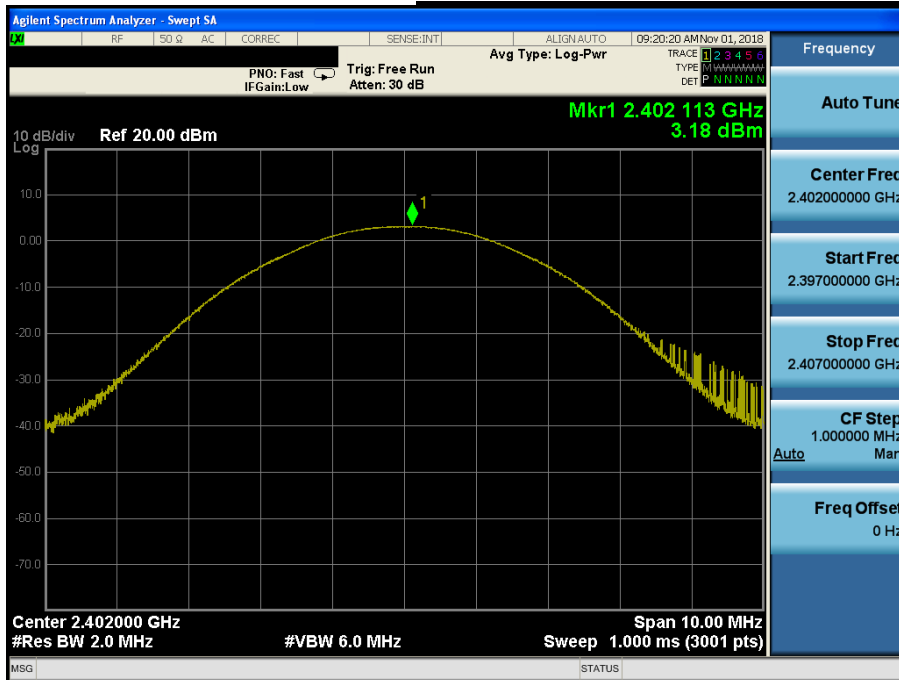

Peak Output Power

Middle Channel & Modulation :  $\pi/4$ DQPSK

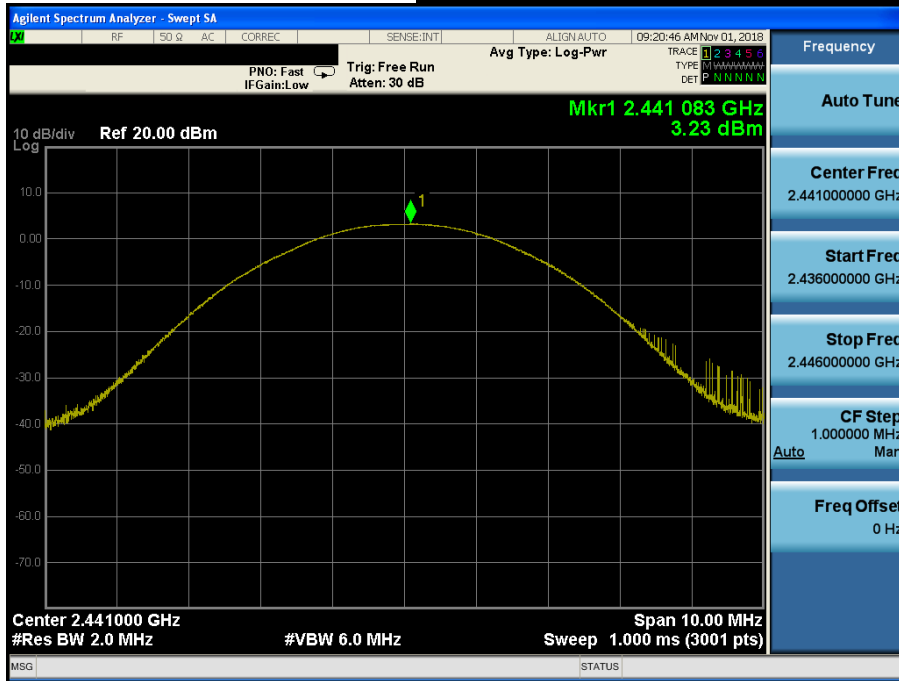

Peak Output Power

Highest Channel & Modulation :  $\pi/4$ DQPSK

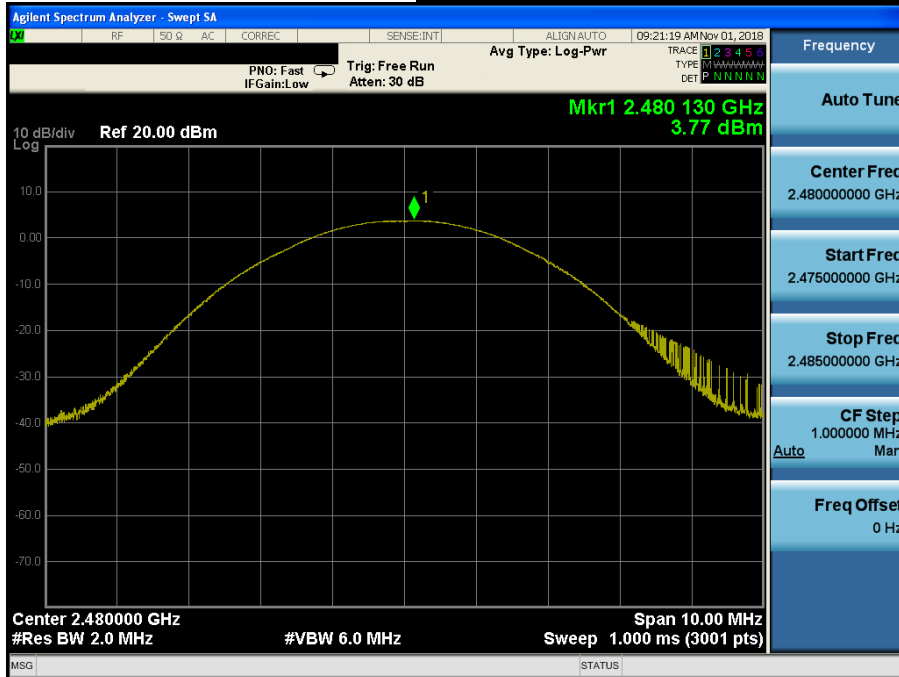

Peak Output Power

***Lowest Channel & Modulation : 8DPSK***

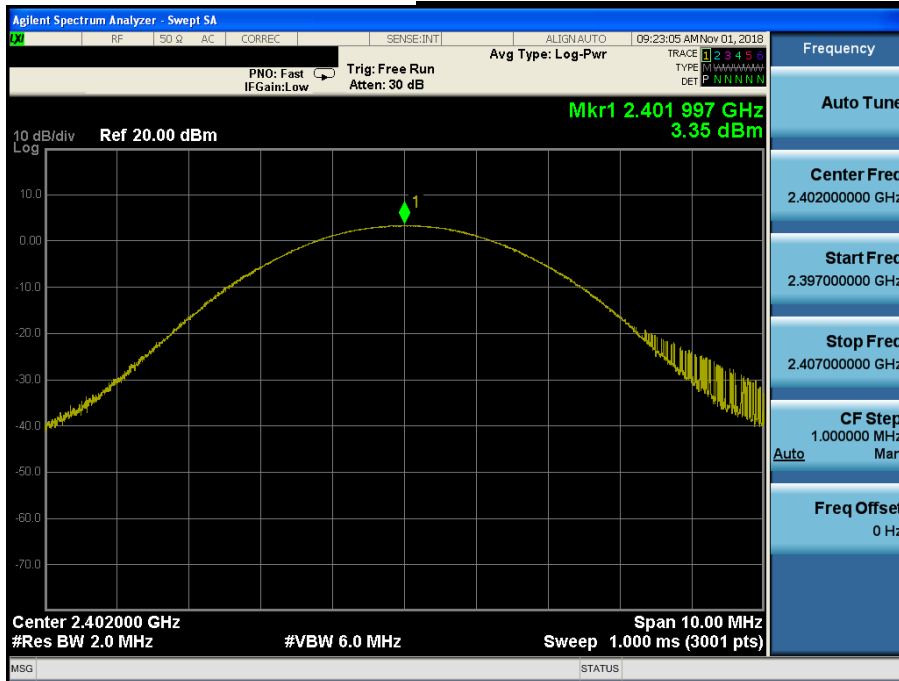

Peak Output Power

***Middle Channel & Modulation : 8DPSK***

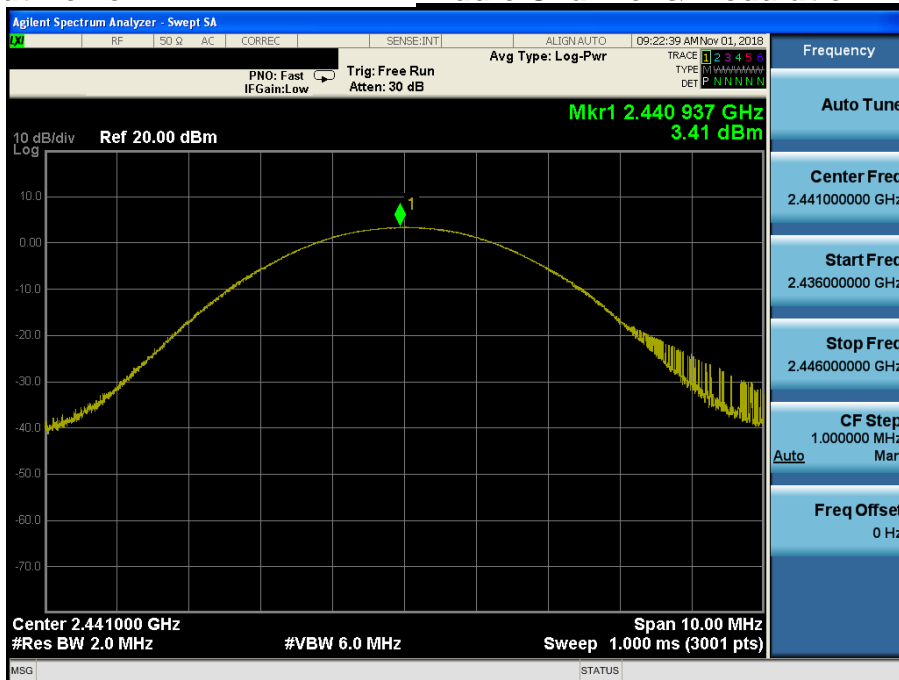

Peak Output Power

**Highest Channel & Modulation : 8DPSK**

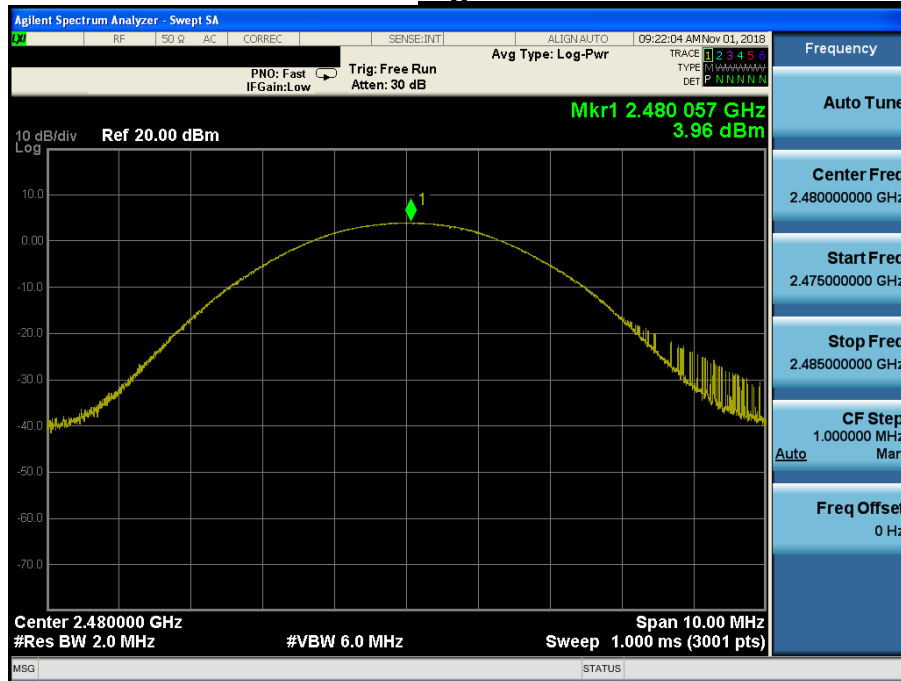



### 3. 20 dB BW

#### 3.1 Test Setup

Refer to the APPENDIX I.

#### 3.2 Limit

Limit : Not Applicable

#### 3.3 Test Procedure

1. The 20 dB bandwidth & Occupied bandwidth were measured with a spectrum analyzer connected to RF antenna Connector(conducted measurement) while EUT was operating in transmit mode. The analyzer center frequency was set to the EUT carrier frequency, using the analyzer.
2. The bandwidth of the fundamental frequency was measured with the spectrum analyzer using below setting:  
 RBW = 1% to 5% of the 20 dB BW & Occupied BW  
 VBW  $\geq 3 \times$  RBW  
 Span = between two times and five times the 20 dB bandwidth & Occupied BW  
 Sweep = auto  
 Detector function = peak  
 Trace = max hold

#### 3.4 Test Results

Modulation	Tested Channel	20 dB BW (MHz)
<b><u>GFSK</u></b>	Lowest	0.881
	Middle	0.879
	Highest	<b>0.882</b>
<b><u><math>\pi/4</math>DQPSK</u></b>	Lowest	1.207
	Middle	<b>1.221</b>
	Highest	1.209
<b><u>8DPSK</u></b>	Lowest	<b>1.246</b>
	Middle	<b>1.246</b>
	Highest	1.243

20 dB BW

***Lowest Channel & Modulation : GFSK***

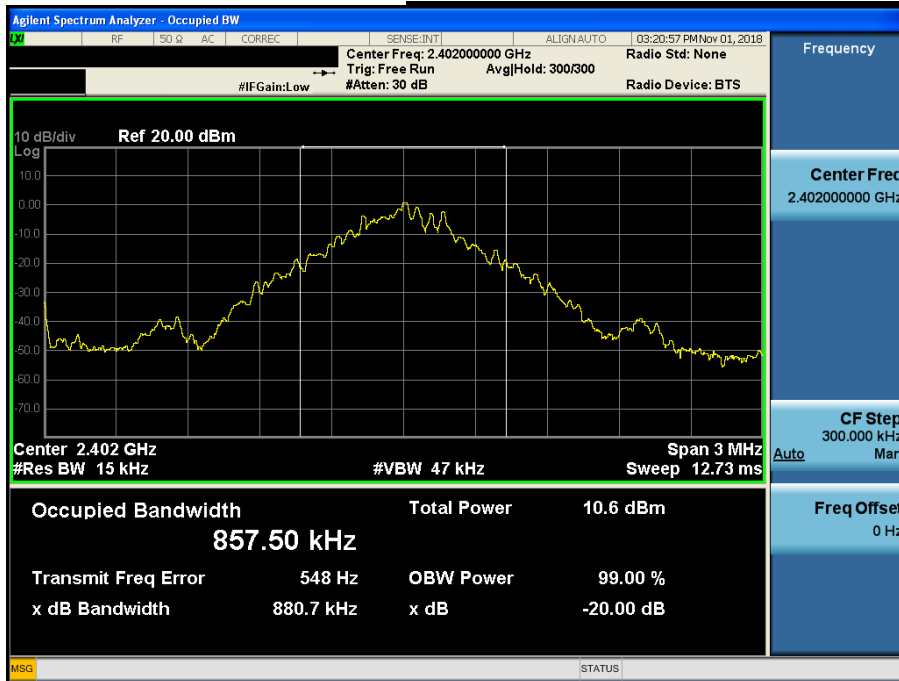

20 dB BW

***Middle Channel & Modulation : GFSK***

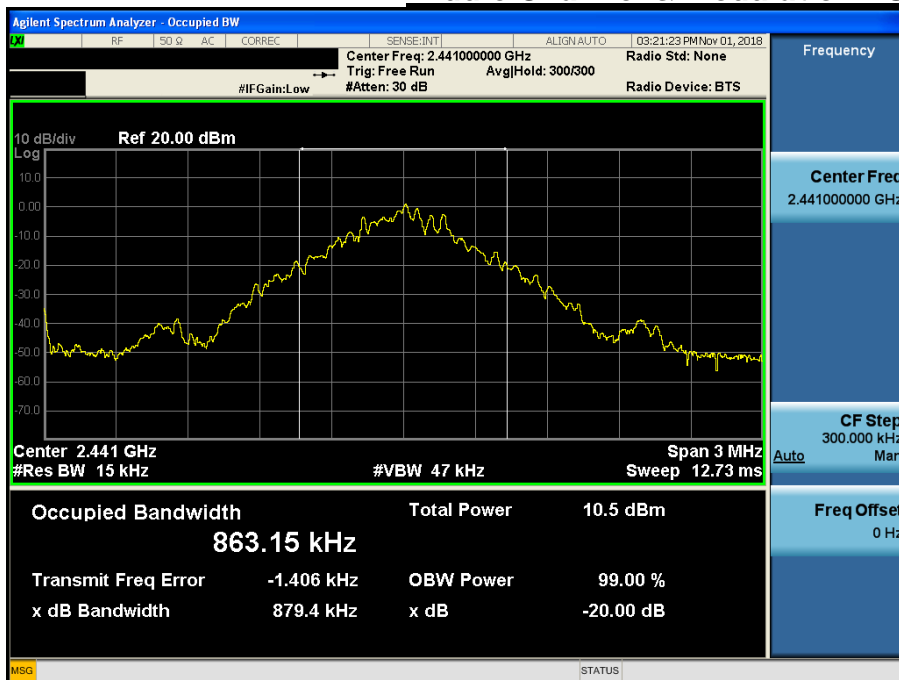

20 dB BW

**Highest Channel & Modulation : GFSK**

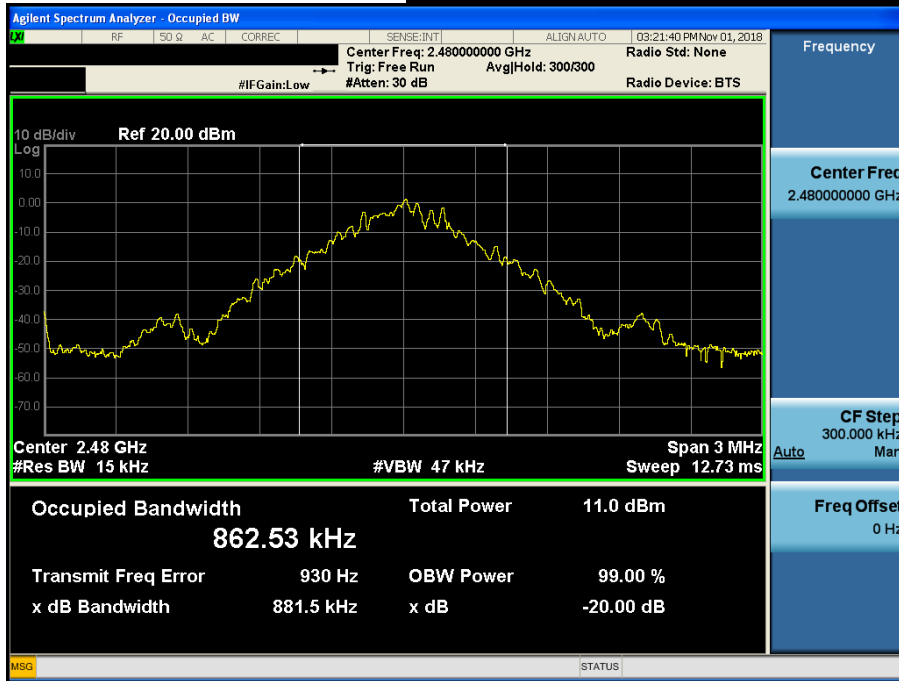

20 dB BW

**Lowest Channel & Modulation :  $\pi/4$ DQPSK**

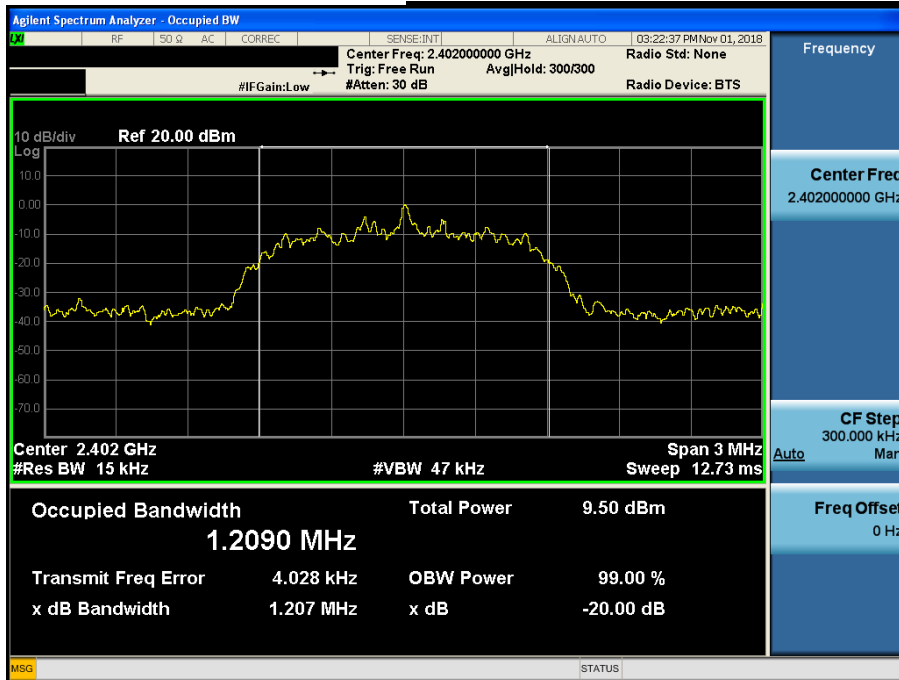

20 dB BW

**Middle Channel & Modulation :  $\pi/4$ DQPSK**

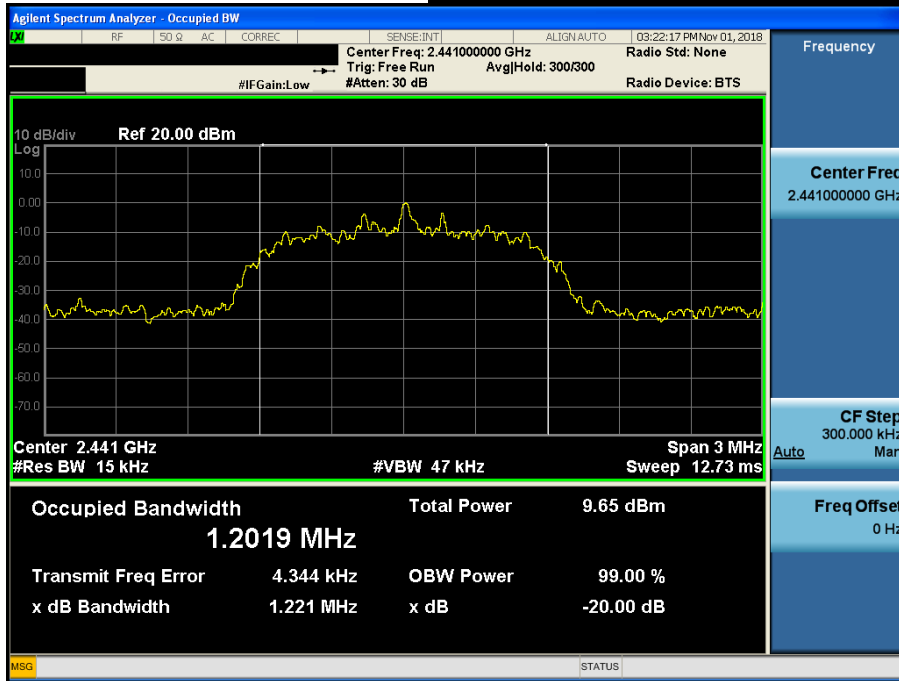

20 dB BW

**Highest Channel & Modulation :  $\pi/4$ DQPSK**

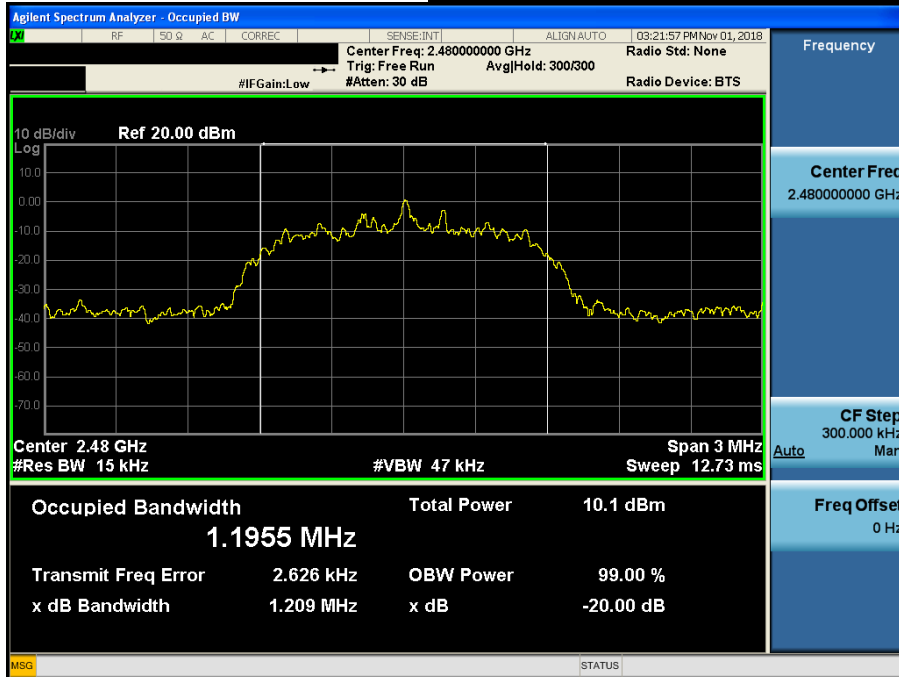

20 dB BW

***Lowest Channel & Modulation : 8DPSK***

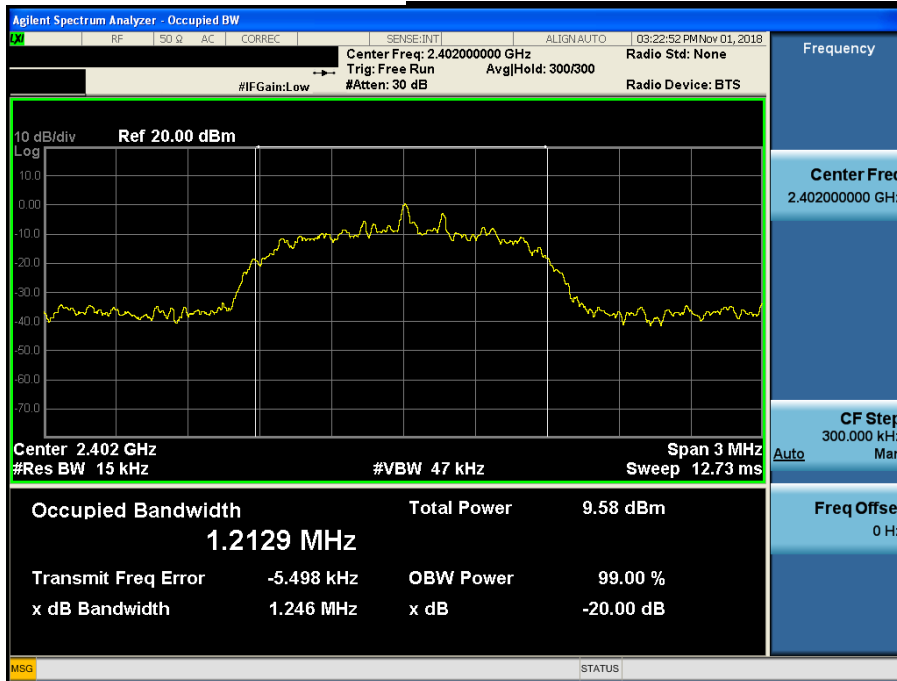

20 dB BW

***Middle Channel & Modulation : 8DPSK***

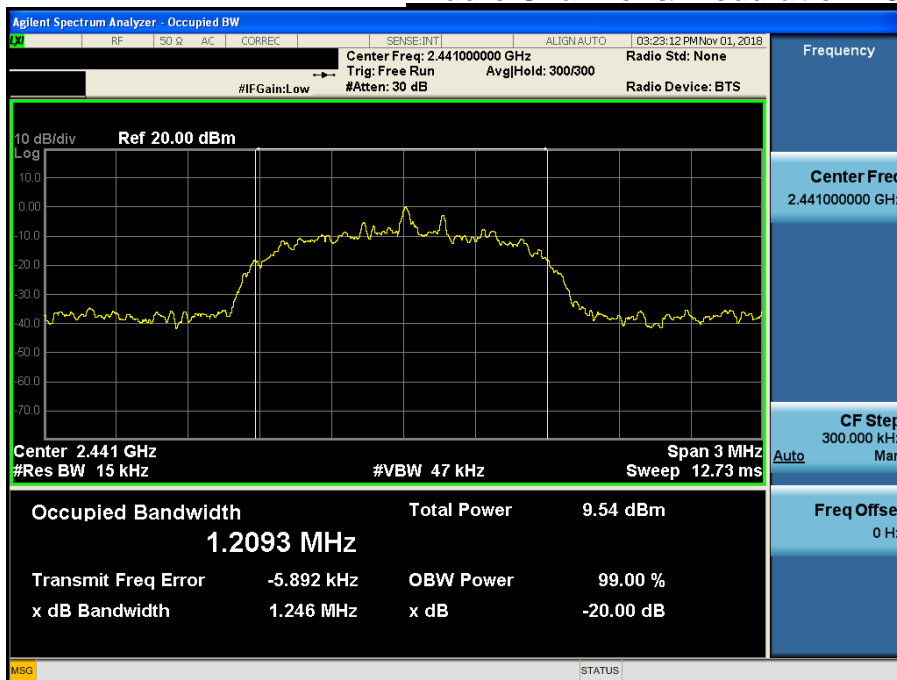

20 dB BW

**Highest Channel & Modulation : 8DPSK**

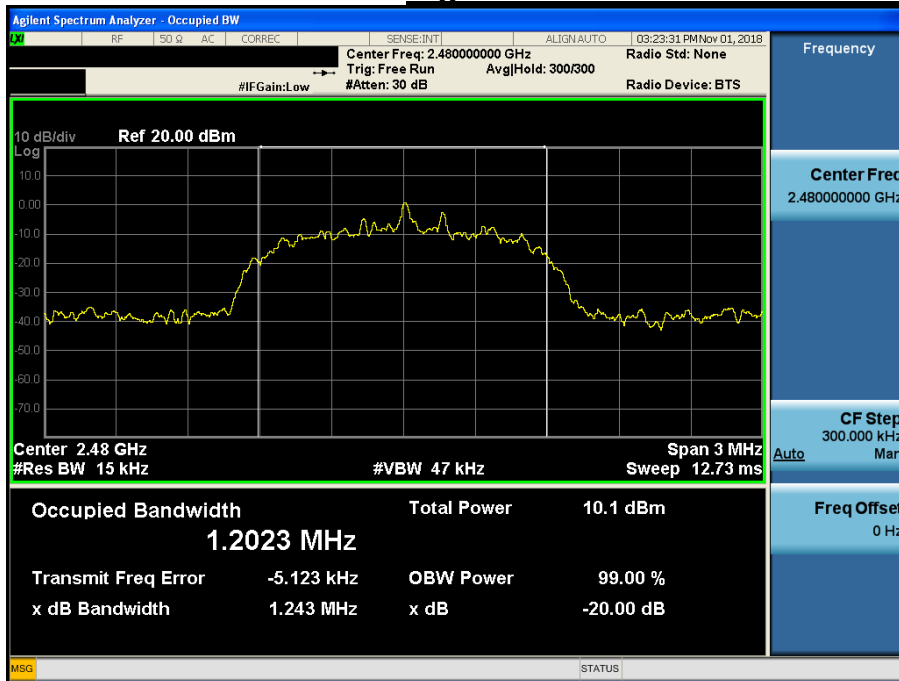

## 4. Carrier Frequency Separation

### 4.1 Test Setup

Refer to the APPENDIX I.

### 4.2 Limit

Limit :  $\geq 25$  kHz or  $\geq$  Two-Thirds of the 20 dB BW whichever is greater.

### 4.3 Procedure

The carrier frequency separation was measured with a spectrum analyzer connected to the antenna terminal, while EUT had its hopping function enabled.

After the trace being stable, the reading value between the peaks of the adjacent channels using the marker-delta function was recorded as the measurement results.

The spectrum analyzer is set to :

Span = wide enough to capture the peaks of two adjacent channels

RBW = Start with the RBW set to approximately 30% of the channel spacing; adjust as necessary to best identify the center of each individual channel.

VBW  $\geq$  RBW

Sweep = auto

Detector function = peak

Trace = max hold

### 4.4 Test Results

#### FH mode

Hopping Mode	Modulation	Peak of center channel (MHz)	Peak of adjacent Channel (MHz)	Test Result (MHz)
Enable	GFSK	2441.009	2442.008	0.999
	$\pi/4$ DQPSK	2441.006	2442.008	1.002
	8DPSK	2441.009	2442.008	0.999

#### AFH mode

Hopping Mode	Modulation	Peak of center channel (MHz)	Peak of adjacent Channel (MHz)	Test Result (MHz)
Enable	GFSK	2441.012	2442.011	0.999
	$\pi/4$ DQPSK	2441.009	2442.008	0.999
	8DPSK	2441.009	2442.008	0.999

Note 1 : See next pages for actual measured spectrum

#### - Minimum Standard :

Frequency hopping systems shall have hopping channel carrier frequencies separated by a minimum of 25 kHz or the 20 dB bandwidth of the hopping channel, whichever is greater. Alternatively, frequency hopping systems operating in the 2400 - 2483.5 MHz band may have hopping channel carrier frequencies that are separated by 25 kHz or two-thirds of the 20 dB bandwidth of the hopping channel, whichever is greater, provided the systems operate with an output power no greater than 125 mW

**Carrier Frequency Separation (FH) *Hopping mode : Enable & GFSK***



**Carrier Frequency Separation (FH) *Hopping mode : Enable & π/4DQPSK***





**Carrier Frequency Separation (FH) *Hopping mode : Enable & 8DPSK***



**Carrier Frequency Separation (AFH) *Hopping mode : Enable & GFSK***



**Carrier Frequency Separation (AFH) *Hopping mode : Enable &  $\pi/4$ DQPSK***

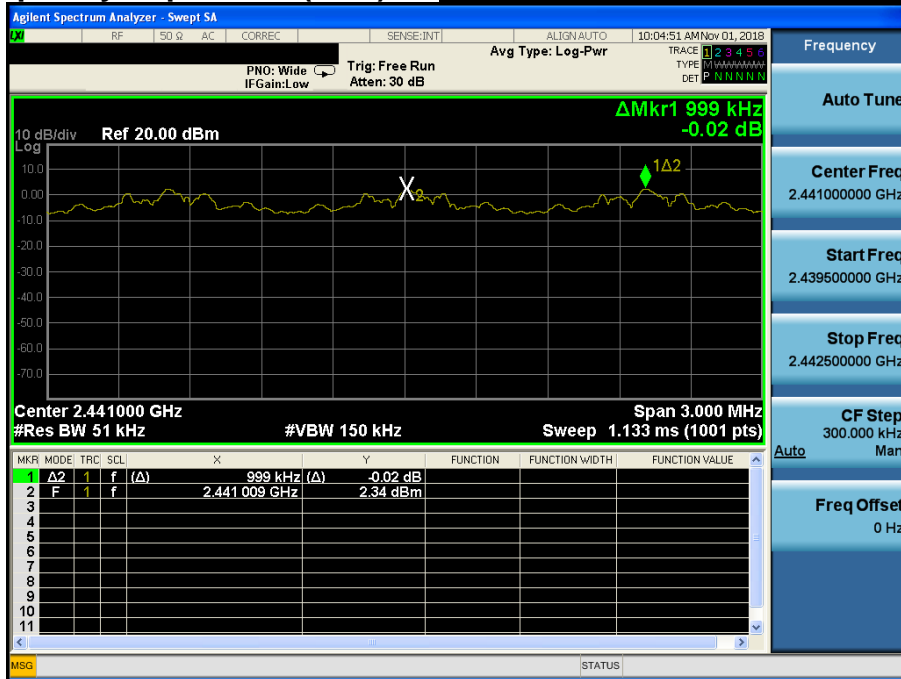

**Carrier Frequency Separation (AFH) *Hopping mode : Enable & 8DPSK***

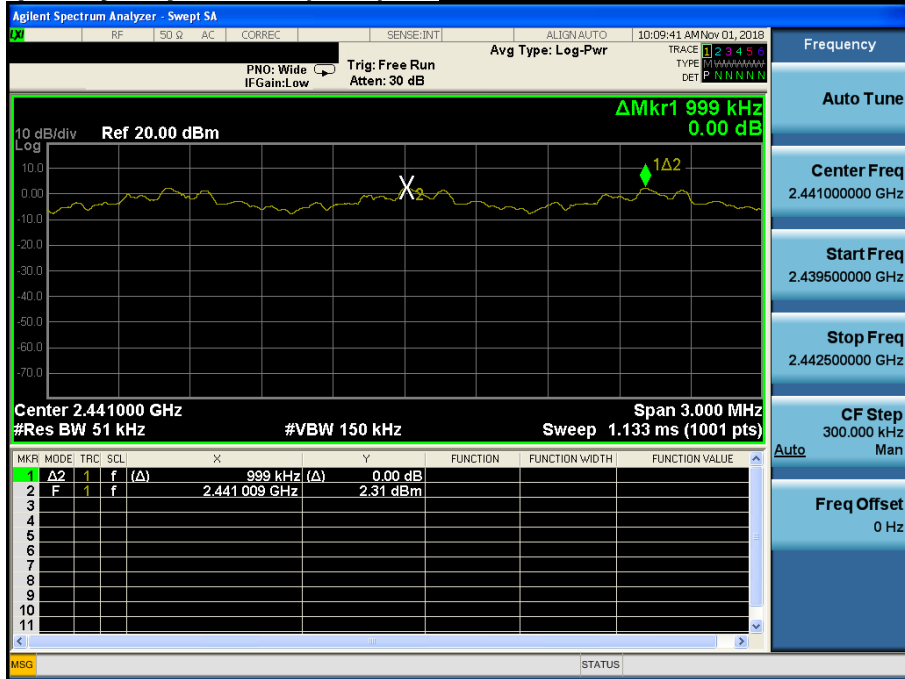

## 5. Number of Hopping Frequencies

### 5.1 Test Setup

Refer to the APPENDIX I.

### 5.2 Limit

Limit :  $\geq 15$  hops

### 5.3 Procedure

The number of hopping frequencies was measured with a spectrum analyzer connected to the antenna terminal, while EUT had its hopping function enabled.

To get higher resolution, two frequency ranges for FH mode within the 2400 ~ 2483.5 MHz were examined.

The spectrum analyzer is set to :

Span for FH mode = 50 MHz      Start Frequency = 2391.5 MHz,      Stop Frequency = 2441.5 MHz

Start Frequency = 2441.5 MHz,      Stop Frequency = 2491.5 MHz

Span for AFH mode = 50 MHz      Start Frequency = 2416.0 MHz,      Stop Frequency = 2466.0 MHz

RBW = To identify clearly the individual channels, set the RBW to less than 30% of the channel spacing or the 20 dB bandwidth, whichever is smaller.

VBW  $\geq$  RBW

Sweep = auto

Detector function = peak

Trace = max hold

### 5.4 Test Results

#### FH mode

Hopping mode	Modulation	Test Result (Total Hops)
Enable	GFSK	79
	$\pi/4$ DQPSK	79
	8DPSK	79

#### AFH mode

Hopping mode	Modulation	Test Result (Total Hops)
Enable	GFSK	20
	$\pi/4$ DQPSK	20
	8DPSK	20

Note 1 : See next pages for actual measured spectrum plots.

#### - Minimum Standard :

At least 15 hops
------------------

**Number of Hopping Frequencies 1(FH)      *Hopping mode : Enable & GFSK***

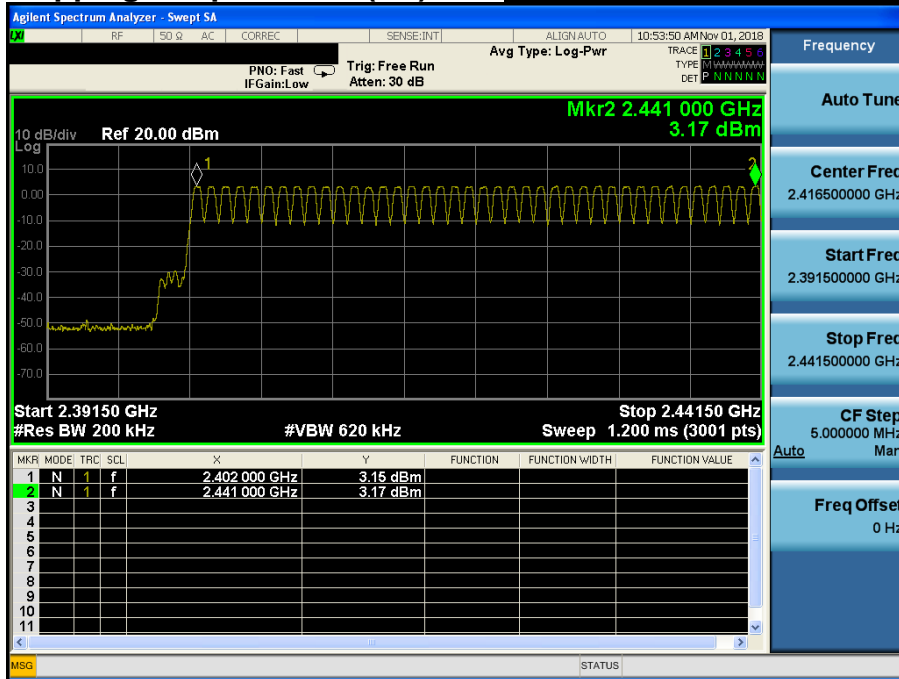

**Number of Hopping Frequencies 2(FH)      *Hopping mode : Enable & GFSK***

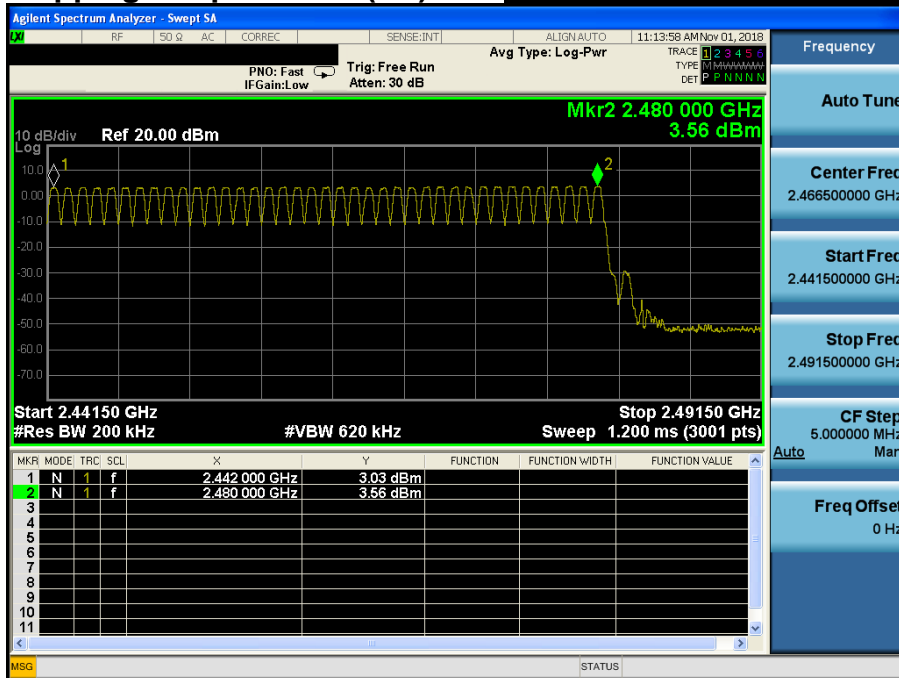

**Number of Hopping Frequencies 1(FH) *Hopping mode : Enable &  $\pi/4$ DQPSK***



**Number of Hopping Frequencies 2(FH) *Hopping mode : Enable &  $\pi/4$ DQPSK***



**Number of Hopping Frequencies 1(FH) *Hopping mode : Enable & 8DPSK***



**Number of Hopping Frequencies 2(FH) *Hopping mode : Enable & 8DPSK***



**Number of Hopping Frequencies 1(AFH) *Hopping mode : Enable & GFSK***

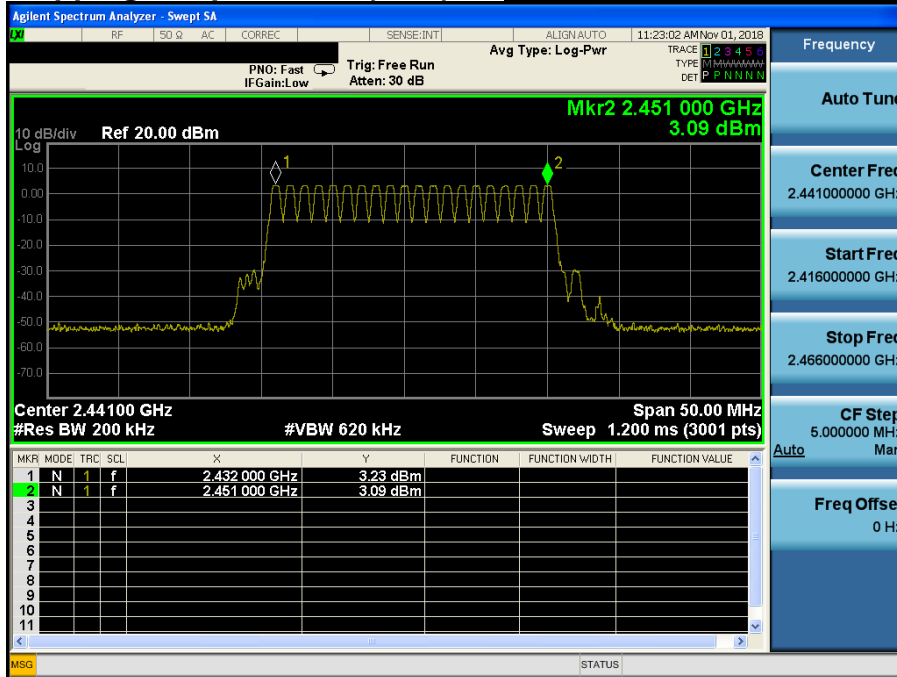

**Number of Hopping Frequencies 1(AFH) *Hopping mode : Enable & π/4DQPSK***

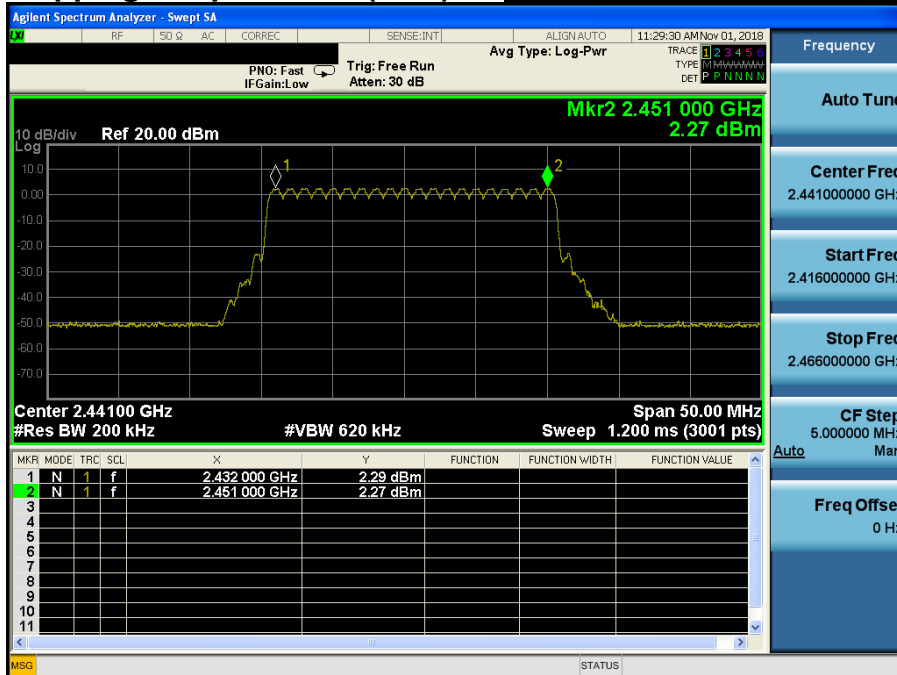



Number of Hopping Frequencies 1(AFH) *Hopping mode : Enable & 8DPSK*

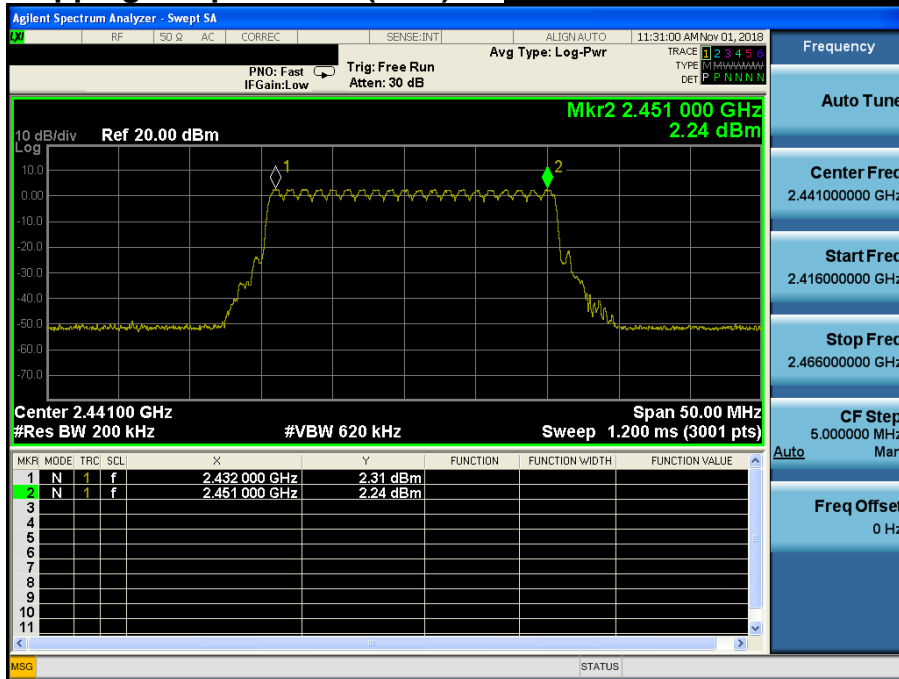

## 6. Time of Occupancy (Dwell Time)

### 6.1 Test Setup

Refer to the APPENDIX I.

### 6.2 Limit

The maximum permissible time of occupancy is 400 ms within a period of 400 ms multiplied by the number of hopping channels employed.

### 6.3 Test Procedure

The dwell time was measured with a spectrum analyzer connected to the antenna terminal, while EUT had its hopping function enabled.

The spectrum analyzer is set to :

Center frequency = 2441 MHz

Span = zero

RBW = 1 MHz (RBW shall be  $\leq$  channel spacing and where possible RBW should be set  $\gg 1 / T$ , where T is the expected dwell time per channel)

VBW  $\geq$  RBW

Detector function = peak

Trace = max hold

### 6.4 Test Results

#### FH mode

Hopping mode	Packet Type	Number of hopping Channels	Burst On Time (ms)	Period (ms)	Test Result (sec)
Enable	DH 5	79	2.880	3.750	0.307
	2 DH 5	79	2.880	3.750	0.307
	3 DH 5	79	2.880	3.750	0.307

#### AFH mode

Hopping mode	Packet Type	Number of hopping Channels	Burst On Time (ms)	Period (ms)	Test Result (sec)
Enable	DH 5	20	2.880	3.750	0.154
	2 DH 5	20	2.880	3.750	0.154
	3 DH 5	20	2.880	3.750	0.154

Note 1 : Dwell Time =  $0.4 \times \text{Hopping channel} \times \text{Burst ON time} \times ((\text{Hopping rate} \div \text{Time slots}) \div \text{Hopping channel})$

- Time slots for DH5 = 6 slots (TX = 5 slot / RX = 1 slot)

- Hopping Rate = 1600 for FH mode & 800 for AFH mode

Note 2 : See next pages for actual measured spectrum plots.

Time of Occupancy (FH)

Hopping mode : Enable & DH5

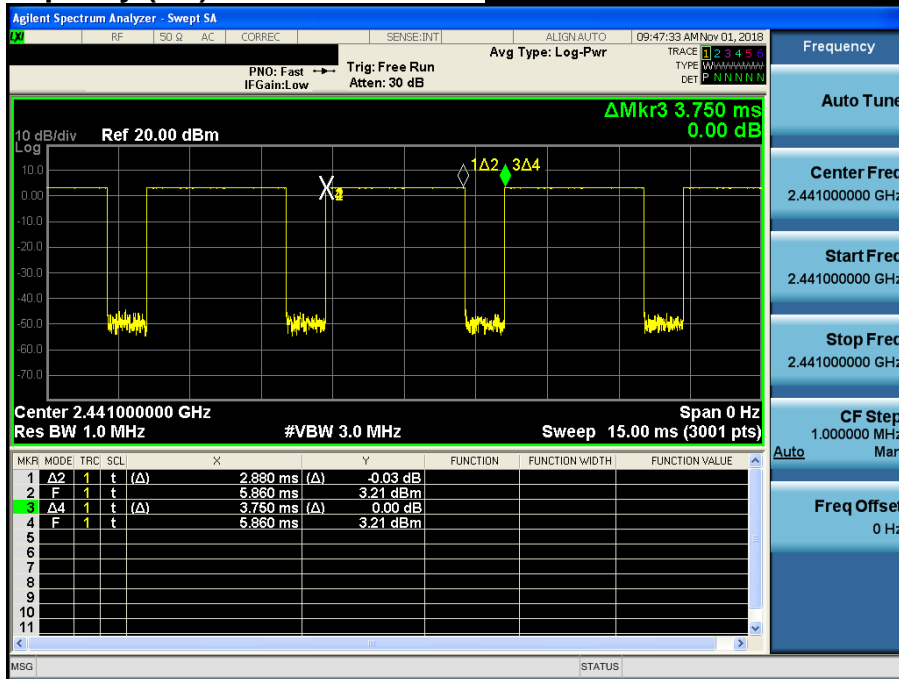

Time of Occupancy (FH)

Hopping mode : Enable & 2-DH5

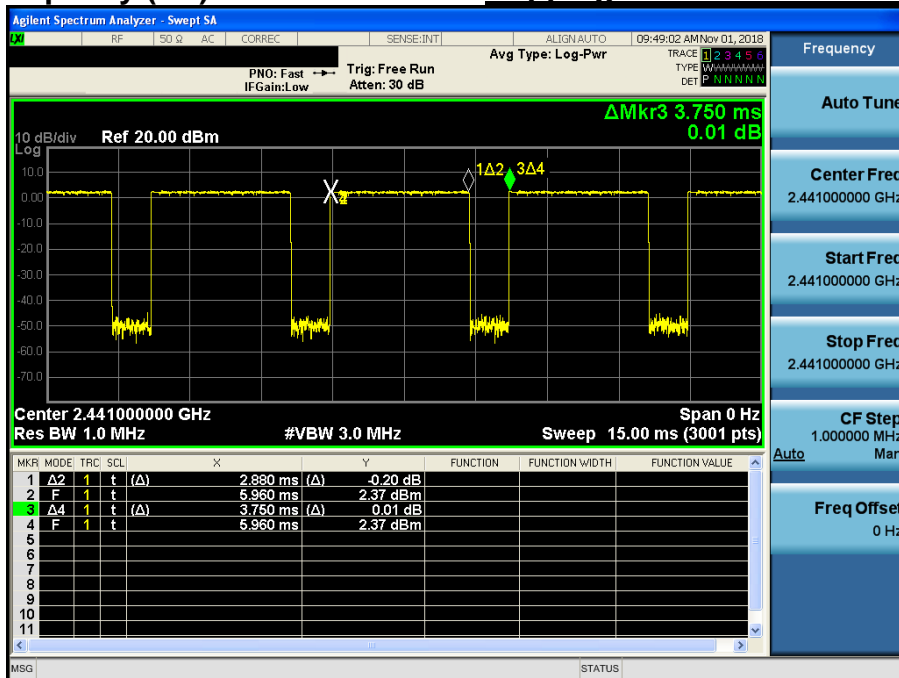

Time of Occupancy (FH)

Hopping mode : Enable & 3-DH5

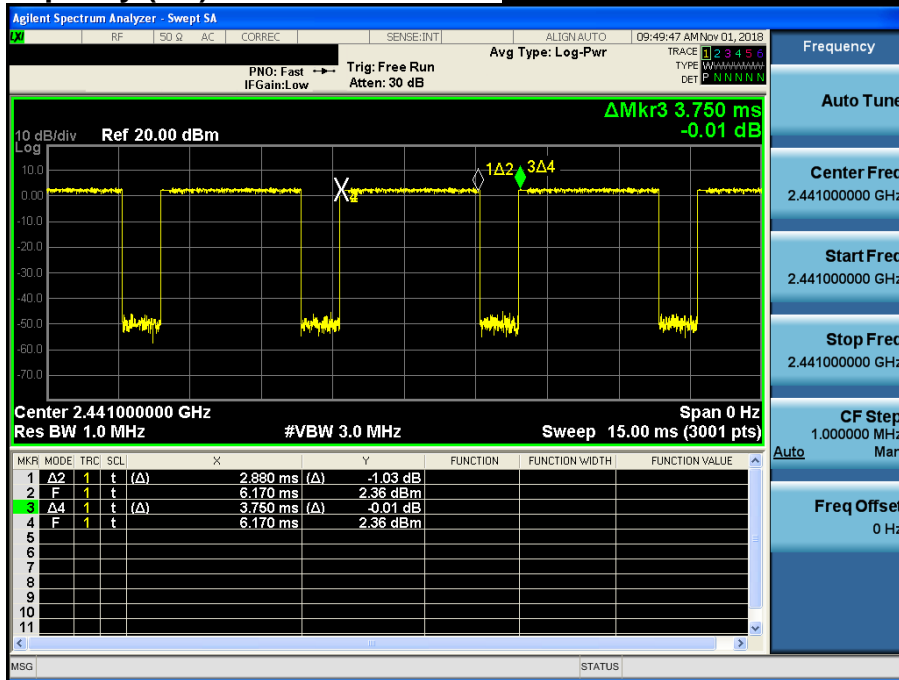

Time of Occupancy (AFH)

Hopping mode : Enable & DH5

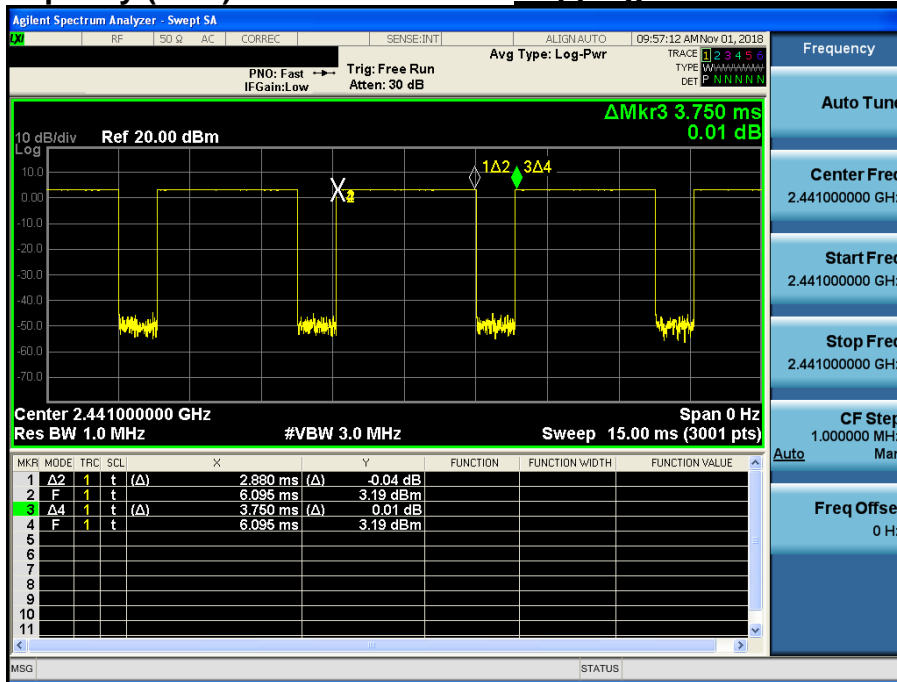

Time of Occupancy (AFH)

Hopping mode : Enable & 2-DH5

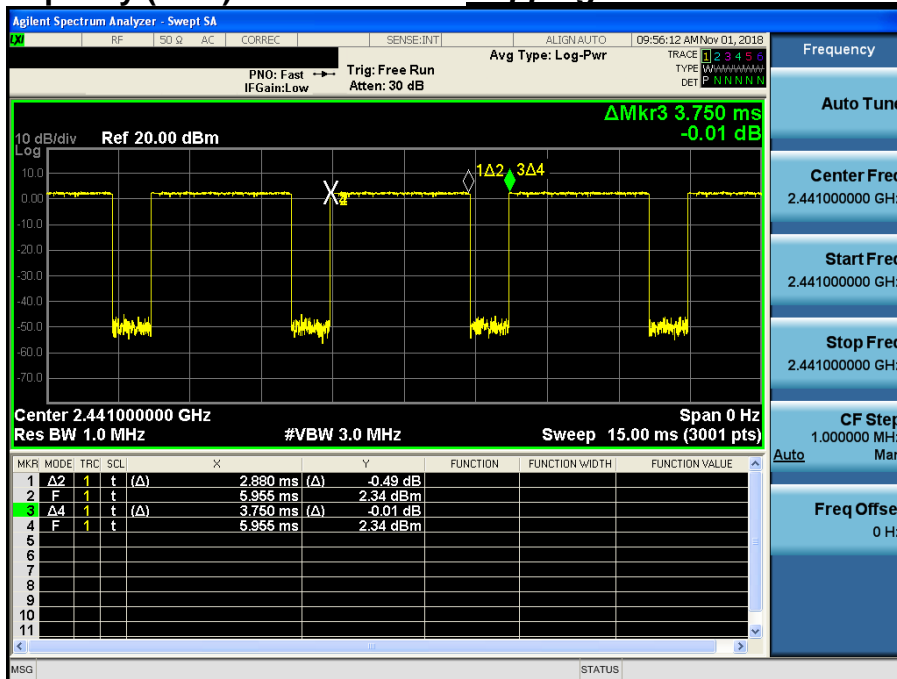

Time of Occupancy (AFH)

Hopping mode : Enable & 3-DH5

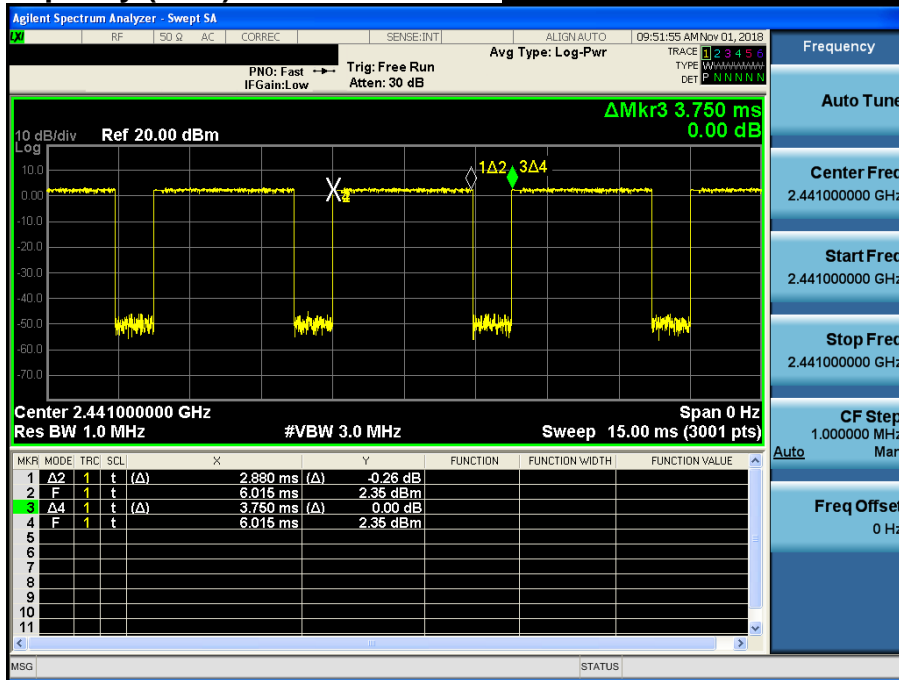

## 7. Transmitter Radiated Spurious Emissions and Conducted Spurious Emission

### 7.1 Test Setup

Refer to the APPENDIX I.

### 7.2 Limit

According to §15.247(d), in any 100 kHz bandwidth outside the frequency band in which the spread spectrum or digitally modulated intentional radiator is operating, the radio frequency power that is produced by the intentional radiator shall be at least 20 dB below that in the 100 kHz bandwidth within the band that contains the highest level of the desired power, based on either an RF conducted or a radiated measurement, provided the transmitter demonstrates compliance with the peak conducted power limits. If the transmitter complies with the conducted power limits based on the use of RMS averaging over a time interval, as permitted under paragraph(b)(3) of this section, the attenuation required under this paragraph shall be 30 dB instead of 20 dB. Attenuation below the general limits specified in section §15.209(a) is not required. In addition, radiated emission which in the restricted band, as define in section §15.205(a), must also comply the radiated emission limits specified in section §15.209(a) (see section §15.205(c))

According to § 15.209(a), except as provided elsewhere in this Subpart, the emissions from an intentional radiator shall not exceed the field strength levels specified in the following table

Frequency (MHz)	Limit (uV/m)	Measurement Distance (meter)
0.009 ~ 0.490	2400/F (kHz)	300
0.490 ~ 1705	24000/F (kHz)	30
1705 ~ 30.0	30	30
30 ~ 88	100 **	3
88 ~ 216	150 **	3
216 ~ 960	200 **	3
Above 960	500	3

\*\* Except as provided in 15.209(g), fundamental emissions from intentional radiators operating under this Section shall not be located in the frequency bands 54 - 72 MHz, 76 - 88 MHz, 174 - 216 MHz or 470 - 806 MHz. However, operation within these frequency bands is permitted under other sections of this Part, e.g. 15.231 and 15.241.

According to § 15.205(a) and (b), only spurious emissions are permitted in any of the frequency bands listed below :

MHz	MHz	MHz	GHz
0.009 ~ 0.110	16.42 ~ 16.423	399.90 ~ 410	4.5 ~ 5.15
0.495 ~ 0.505	16.69475 ~ 16.69525	608 ~ 614	5.35 ~ 5.46
2.1735 ~ 2.1905	16.80425 ~ 16.80475	960 ~ 1240	7.25 ~ 7.75
4.125 ~ 4.128	25.5 ~ 25.67	1300 ~ 1427	8.025 ~ 8.5
4.17725 ~ 4.17775	37.5 ~ 38.25	1435 ~ 1626.5	9.0 ~ 9.2
4.20725 ~ 4.20775	73 ~ 74.6	1645.5 ~ 1646.5	9.3 ~ 9.5
6.215 ~ 6.218	74.8 ~ 75.2	1660 ~ 1710	10.6 ~ 12.7
6.26775 ~ 6.26825	108 ~ 121.94	1718.8 ~ 1722.2	13.25 ~ 13.4
6.31175 ~ 6.31225	123 ~ 138	2200 ~ 2300	14.47 ~ 14.5
8.291 ~ 8.294	149.9 ~ 150.05	2310 ~ 2390	15.35 ~ 16.2
8.362 ~ 8.366	156.52475 ~ 156.52525	2483.5 ~ 2500	17.7 ~ 21.4
8.37625 ~ 8.38675	156.7 ~ 156.9	2690 ~ 2900	22.01 ~ 23.12
8.41425 ~ 8.41475	162.0125 ~ 167.17	3260 ~ 3267	23.6 ~ 24.0
12.29 ~ 12.293	167.72 ~ 173.2	3332 ~ 3339	31.2 ~ 31.8
12.51975 ~ 12.52025	240 ~ 285	3345.8 ~ 3358	36.43 ~ 36.5
12.57675 ~ 12.57725	322 ~ 335.4	3600 ~ 4400	Above 38.6
13.36 ~ 13.41			

The field strength of emissions appearing within these frequency bands shall not exceed the limits shown in §15.209. At frequencies equal to or less than 1000 MHz, compliance with the limits in §15.209 shall be demonstrated using measurement instrumentation employing a CISPR quasi-peak detector. Above 1000 MHz, compliance with the emission limits in §15.209 shall be demonstrated based on the average value of the measured emissions. The provisions in §15.35 apply to these measurements.

## 7.3. Test Procedures

### 7.3.1. Test Procedures for Radiated Spurious Emissions

1. The EUT is placed on a non-conductive table. For emission measurements at or below 1 GHz, the table height is 80 cm. For emission measurements above 1 GHz, the table height is 1.5 m. The table was rotated 360 degrees to determine the position of the highest radiation.
2. During performing radiated emission below 1 GHz, the EUT was set 3 meters away from the interference receiving antenna, which was mounted on the top of a variable-height antenna tower. During performing radiated emission above 1 GHz, the EUT was set 1 or 3 meter away from the interference-receiving antenna.
3. For measurements above 1GHz absorbers are placed on the floor between the turn table and the antenna mast in such a way so as to maximize the reduction of reflections. For measurements below 1 GHz, the absorbers are removed.
4. The antenna is a broadband antenna, and its height is varied from one meter to four meters above the ground to determine the maximum value of the field strength. Both horizontal and vertical polarizations of the antenna are set to make the measurement.
5. For each suspected emission, the EUT was arranged to its worst case and then the antenna was tuned to heights from 1 meter to 4 meters and the table was turned from 0 degrees to 360 degrees to find the maximum reading.
6. The test-receiver system was set to Peak Detect Function and Specified Bandwidth with Maximum Hold Mode.
7. If the emission level of the EUT in peak mode was 10 dB lower than the limit specified, then testing could be stopped and the peak values of the EUT would be reported. Otherwise the emissions that did not have 10 dB margin would be re-tested one by one using peak, quasi-peak or average method as specified and then reported in a data sheet.

Note: The radiated spurious emission was tested with below settings.

1. The resolution bandwidth and video bandwidth of test receiver/spectrum analyzer is 120 kHz for Quasi-peak detection (QP) at frequency below 1 GHz.
2. The resolution bandwidth and video bandwidth of test receiver/spectrum analyzer is 1 MHz for Peak detection at frequency above 1GHz.
3. The resolution bandwidth of test receiver/spectrum analyzer is 1 MHz and video bandwidth is  $[1/(\text{minimum transmitter on time})]$  for Average detection (AV) at frequency above 1GHz.



### 7.3.2. Test Procedures for Conducted Spurious Emissions

1. The transmitter output was connected to the spectrum analyzer.
2. The **reference level** of the fundamental frequency was measured with the spectrum analyzer using RBW = 100 kHz, VBW = 300 kHz.
3. The conducted spurious emission was tested each ranges were set as below.

**Frequency range : 9 kHz ~ 30 MHz**

RBW = 100 kHz, VBW = 300 kHz, SWEEP TIME = AUTO, DETECTOR = PEAK, TRACE = MAX HOLD, SWEEP POINT : 40001

**Frequency range : 30 MHz ~ 10 GHz, 10 GHz ~ 25 GHz**

RBW = 1 MHz, VBW = 3 MHz, SWEEP TIME = AUTO, DETECTOR = PEAK, TRACE = MAX HOLD, SWEEP POINT : 40001

**LIMIT LINE = 20 dB below of the reference level of above measurement procedure Step 2. (RBW = 100 kHz, VBW = 300 kHz)**

If the emission level with above setting was close to the limit (ie, less than 3 dB margin) then zoom scan is required using RBW = 100 kHz, VBW = 300 kHz, SPAN = 100 MHz and BINS = 2001 to get accurate emission level within 100 kHz BW.

Also the path loss for conducted measurement setup was used as described on the Appendix I of this test report.

## 7.4. Test Results

### 7.4.1. Radiated Emissions

#### 9 kHz ~ 25 GHz Data (Modulation : GFSK)

##### ▪ Lowest Channel

Frequency (MHz)	ANT Pol	EUT Position (Axis)	Detector Mode	Reading (dBuV)	T.F (dB/m)	D.C.F (dB)	Distance Factor (dB)	Result (dBuV/m)	Limit (dBuV/m)	Margin (dB)
2388.01	H	X	PK	44.83	1.70	N/A	N/A	46.53	74.00	27.47
2387.99	H	X	AV	34.49	1.70	N/A	N/A	36.19	54.00	17.81
4803.60	V	Y	PK	47.93	5.45	N/A	N/A	53.38	74.00	20.62
4803.96	V	Y	AV	38.98	5.45	N/A	N/A	44.43	54.00	9.57
7205.81	V	Y	PK	45.31	7.86	N/A	N/A	53.17	74.00	20.83
7206.04	V	Y	AV	36.42	7.86	N/A	N/A	44.28	54.00	9.72
9611.83	H	Y	PK	45.23	9.94	N/A	N/A	55.17	74.00	18.83
9611.91	H	Y	AV	35.41	9.94	N/A	N/A	45.35	54.00	8.65

##### ▪ Middle Channel

Frequency (MHz)	ANT Pol	EUT Position (Axis)	Detector Mode	Reading (dBuV)	T.F (dB/m)	D.C.F (dB)	Distance Factor (dB)	Result (dBuV/m)	Limit (dBuV/m)	Margin (dB)
4882.10	V	Y	PK	48.04	5.64	N/A	N/A	53.68	74.00	20.32
4882.01	V	Y	AV	42.30	5.64	N/A	N/A	47.94	54.00	6.06
7323.29	V	Y	PK	46.43	8.04	N/A	N/A	54.47	74.00	19.53
7323.11	V	Y	AV	39.24	8.04	N/A	N/A	47.28	54.00	6.72
9768.08	H	Y	PK	46.15	9.96	N/A	N/A	56.11	74.00	17.89
9767.94	H	Y	AV	36.61	9.96	N/A	N/A	46.57	54.00	7.43

##### ▪ Highest Channel

Frequency (MHz)	ANT Pol	EUT Position (Axis)	Detector Mode	Reading (dBuV)	T.F (dB/m)	D.C.F (dB)	Distance Factor (dB)	Result (dBuV/m)	Limit (dBuV/m)	Margin (dB)
2483.52	H	X	PK	58.59	1.79	N/A	N/A	60.38	74.00	13.62
2483.50	H	X	AV	41.58	1.79	N/A	N/A	43.37	54.00	10.63
4959.88	V	Y	PK	46.99	5.76	N/A	N/A	52.75	74.00	21.25
4960.02	V	Y	AV	40.46	5.76	N/A	N/A	46.22	54.00	7.78
7440.38	V	Y	PK	46.31	7.87	N/A	N/A	54.18	74.00	19.82
7439.90	V	Y	AV	38.59	7.87	N/A	N/A	46.46	54.00	7.54
9923.72	H	Y	PK	44.96	10.09	N/A	N/A	55.05	74.00	18.95
9924.03	H	Y	AV	36.08	10.09	N/A	N/A	46.17	54.00	7.83

##### ▪ Note.

1. The radiated emissions were investigated 9 kHz to 25 GHz. And no other spurious and harmonic emissions were found above listed frequencies.

##### 2. Information of Distance Factor

For finding emissions, the test distance might be reduced from 3m to 1m. In this case, the distance factor(-9.54dB) is applied to the result.

- Calculation of distance factor =  $20 \log(\text{applied distance} / \text{required distance}) = 20 \log(1 \text{ m} / 3 \text{ m}) = -9.54 \text{ dB}$

When distance factor is "N/A", the distance is 3 m and distance factor is not applied.

##### 3. Sample Calculation.

Margin = Limit – Result / Result = Reading + T.F + D.C.F / T.F = AF + CL – AG

Where, T.F = Total Factor, AF = Antenna Factor, CL = Cable Loss, AG = Amplifier Gain.

**9 kHz ~ 25 GHz Data (Modulation :  $\pi/4$ DQPSK)**

## ▪ Lowest Channel

Frequency (MHz)	ANT Pol	EUT Position (Axis)	Detector Mode	Reading (dBuV)	T.F (dB/m)	D.C.F (dB)	Distance Factor (dB)	Result (dBuV/m)	Limit (dBuV/m)	Margin (dB)
2389.47	V	Y	PK	44.15	1.71	N/A	N/A	45.86	74.00	28.14
2389.29	V	Y	AV	34.40	1.71	N/A	N/A	36.11	54.00	17.89
4803.94	V	Y	PK	49.48	5.45	N/A	N/A	54.93	74.00	19.07
4803.81	V	Y	AV	40.48	5.45	N/A	N/A	45.93	54.00	8.07
7206.50	V	Y	PK	46.02	7.86	N/A	N/A	53.88	74.00	20.12
7206.24	V	Y	AV	37.37	7.86	N/A	N/A	45.23	54.00	8.77
9611.83	V	Z	PK	45.39	9.94	N/A	N/A	55.33	74.00	18.67
9611.95	V	Z	AV	36.84	9.94	N/A	N/A	46.78	54.00	7.22

## ▪ Middle Channel

Frequency (MHz)	ANT Pol	EUT Position (Axis)	Detector Mode	Reading (dBuV)	T.F (dB/m)	D.C.F (dB)	Distance Factor (dB)	Result (dBuV/m)	Limit (dBuV/m)	Margin (dB)
4882.08	V	Y	PK	46.68	5.64	N/A	N/A	52.32	74.00	21.68
4881.96	V	Y	AV	38.58	5.64	N/A	N/A	44.22	54.00	9.78
7323.56	V	Y	PK	45.93	8.04	N/A	N/A	53.97	74.00	20.03
7323.11	V	Y	AV	36.47	8.04	N/A	N/A	44.51	54.00	9.49
9768.34	V	Z	PK	45.70	9.96	N/A	N/A	55.66	74.00	18.34
9767.97	V	Z	AV	37.18	9.96	N/A	N/A	47.14	54.00	6.86

## ▪ Highest Channel

Frequency (MHz)	ANT Pol	EUT Position (Axis)	Detector Mode	Reading (dBuV)	T.F (dB/m)	D.C.F (dB)	Distance Factor (dB)	Result (dBuV/m)	Limit (dBuV/m)	Margin (dB)
2483.51	V	Y	PK	55.91	1.79	N/A	N/A	57.70	74.00	16.30
2483.50	V	Y	AV	40.54	1.79	N/A	N/A	42.33	54.00	11.67
4959.73	V	Y	PK	46.33	5.76	N/A	N/A	52.09	74.00	21.91
4960.12	V	Y	AV	37.17	5.76	N/A	N/A	42.93	54.00	11.07
7440.34	V	Y	PK	45.58	7.87	N/A	N/A	53.45	74.00	20.55
7440.05	V	Y	AV	36.98	7.87	N/A	N/A	44.85	54.00	9.15
9924.03	V	Z	PK	45.25	10.09	N/A	N/A	55.34	74.00	18.66
9923.87	V	Z	AV	35.56	10.09	N/A	N/A	45.65	54.00	8.35

 ▪ Note.

1. The radiated emissions were investigated 9 kHz to 25 GHz. And no other spurious and harmonic emissions were found above listed frequencies.

2. Information of Distance Factor

For finding emissions, the test distance might be reduced from 3m to 1m. In this case, the distance factor(-9.54dB) is applied to the result.

- Calculation of distance factor =  $20 \log(\text{applied distance} / \text{required distance}) = 20 \log(1 \text{ m} / 3 \text{ m}) = \underline{-9.54 \text{ dB}}$

When distance factor is "N/A", the distance is 3 m and distance factor is not applied.

3. Sample Calculation.

Margin = Limit – Result / Result = Reading + T.F + D.C.F / T.F = AF + CL – AG

Where, T.F = Total Factor, AF = Antenna Factor, CL = Cable Loss, AG = Amplifier Gain.

**9 kHz ~ 25 GHz Data (Modulation : 8DPSK)**
**▪ Lowest Channel**

Frequency (MHz)	ANT Pol	EUT Position (Axis)	Detector Mode	Reading (dBuV)	T.F (dB/m)	D.C.F (dB)	Distance Factor (dB)	Result (dBuV/m)	Limit (dBuV/m)	Margin (dB)
2389.53	V	Y	PK	43.52	1.71	N/A	N/A	45.23	74.00	28.77
2389.53	V	Y	AV	34.43	1.71	N/A	N/A	36.14	54.00	17.86
4804.33	V	Y	PK	49.29	5.45	N/A	N/A	54.74	74.00	19.26
4804.00	V	Y	AV	41.62	5.45	N/A	N/A	47.07	54.00	6.93
7206.31	V	Y	PK	46.43	7.86	N/A	N/A	54.29	74.00	19.71
7206.03	V	Y	AV	37.66	7.86	N/A	N/A	45.52	54.00	8.48
9612.00	H	Y	PK	45.79	9.94	N/A	N/A	55.73	74.00	18.27
9612.04	H	Y	AV	37.25	9.94	N/A	N/A	47.19	54.00	6.81

**▪ Middle Channel**

Frequency (MHz)	ANT Pol	EUT Position (Axis)	Detector Mode	Reading (dBuV)	T.F (dB/m)	D.C.F (dB)	Distance Factor (dB)	Result (dBuV/m)	Limit (dBuV/m)	Margin (dB)
4882.01	V	Y	PK	48.26	5.64	N/A	N/A	53.90	74.00	20.10
4881.93	V	Y	AV	39.48	5.64	N/A	N/A	45.12	54.00	8.88
7322.90	V	Y	PK	46.10	8.04	N/A	N/A	54.14	74.00	19.86
7322.96	V	Y	AV	37.22	8.04	N/A	N/A	45.26	54.00	8.74
9768.10	H	Y	PK	45.86	9.96	N/A	N/A	55.82	74.00	18.18
9767.89	H	Y	AV	37.15	9.96	N/A	N/A	47.11	54.00	6.89

**▪ Highest Channel**

Frequency (MHz)	ANT Pol	EUT Position (Axis)	Detector Mode	Reading (dBuV)	T.F (dB/m)	D.C.F (dB)	Distance Factor (dB)	Result (dBuV/m)	Limit (dBuV/m)	Margin (dB)
2483.56	V	Y	PK	57.76	1.79	N/A	N/A	59.55	74.00	14.45
2483.50	V	Y	AV	41.57	1.79	N/A	N/A	43.36	54.00	10.64
4960.06	V	Y	PK	46.10	5.76	N/A	N/A	51.86	74.00	22.14
4960.07	V	Y	AV	37.30	5.76	N/A	N/A	43.06	54.00	10.94
7439.79	V	Y	PK	45.95	7.87	N/A	N/A	53.82	74.00	20.18
7440.08	V	Y	AV	37.05	7.87	N/A	N/A	44.92	54.00	9.08
9924.17	H	Y	PK	44.56	10.09	N/A	N/A	54.65	74.00	19.35
9923.84	H	Y	AV	35.11	10.09	N/A	N/A	45.20	54.00	8.80

**▪ Note.**

1. The radiated emissions were investigated 9 kHz to 25 GHz. And no other spurious and harmonic emissions were found above listed frequencies.

2. Information of Distance Factor

For finding emissions, the test distance might be reduced from 3m to 1m. In this case, the distance factor(-9.54dB) is applied to the result.

- Calculation of distance factor =  $20 \log(\text{applied distance} / \text{required distance}) = 20 \log(1 \text{ m} / 3 \text{ m}) = \underline{-9.54 \text{ dB}}$

When distance factor is "N/A", the distance is 3 m and distance factor is not applied.

3. Sample Calculation.

Margin = Limit – Result / Result = Reading + T.F + D.C.F / T.F = AF + CL – AG

Where, T.F = Total Factor, AF = Antenna Factor, CL = Cable Loss, AG = Amplifier Gain.

7.4.2. Conducted Spurious Emissions

Low Band-edge

***Lowest Channel & Modulation : GFSK***



Low Band-edge

***Hopping mode & Modulation : GFSK***

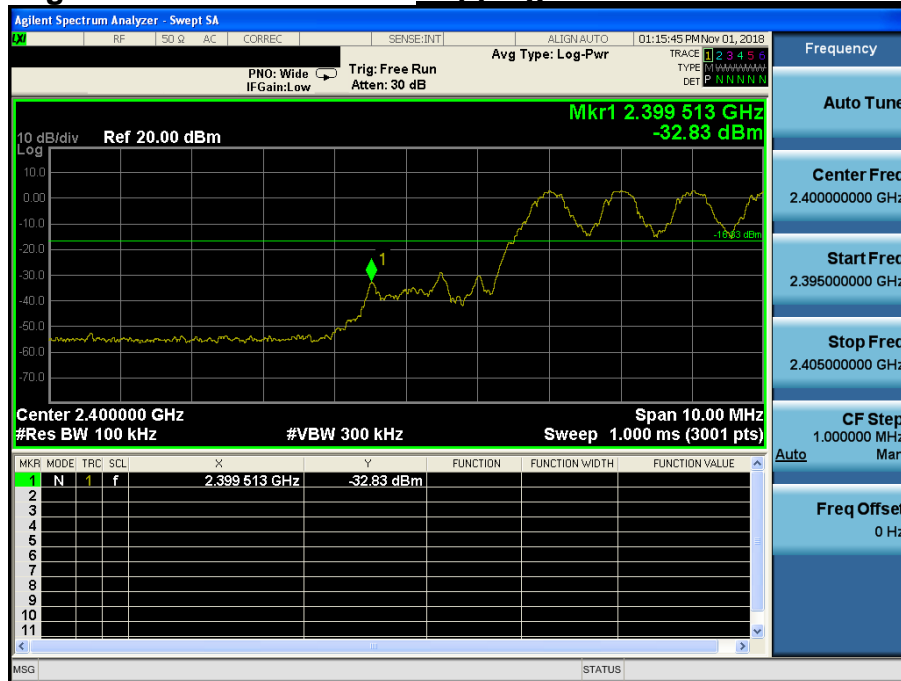

Conducted Spurious Emissions Lowest Channel & Modulation : GFSK

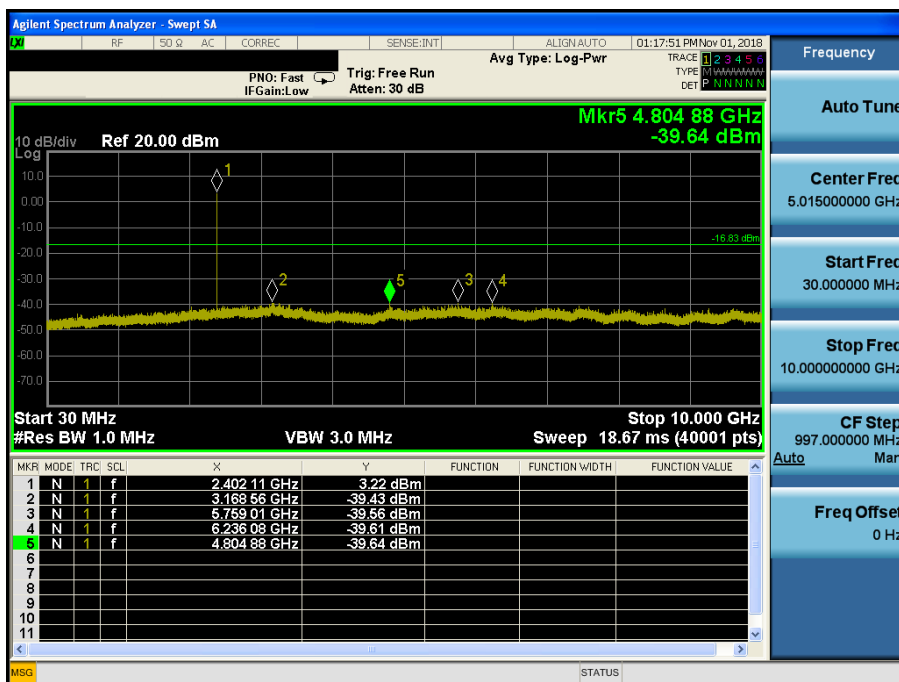
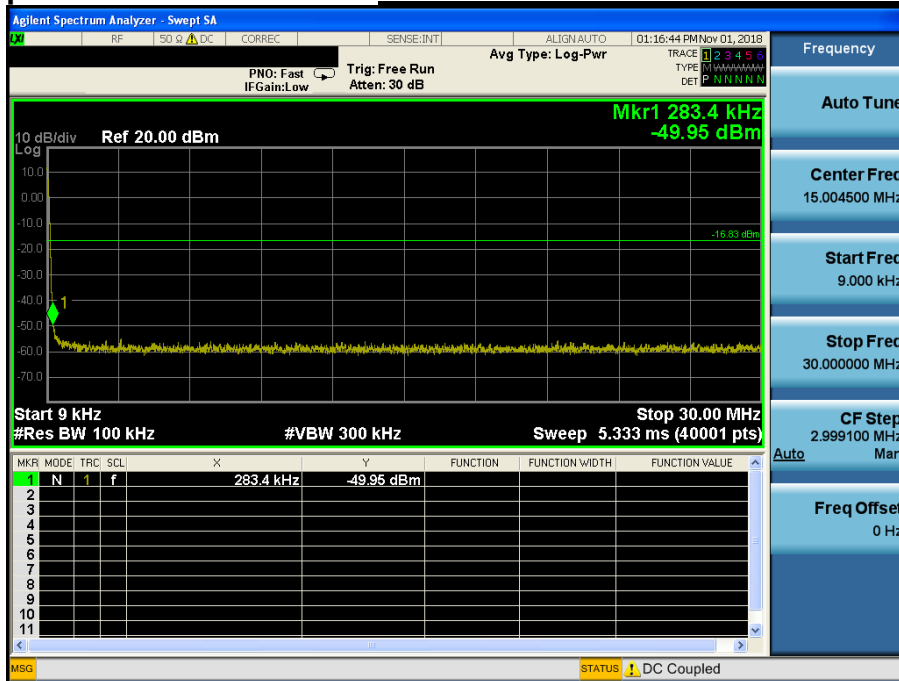

**Conducted Spurious Emissions**      ***Lowest Channel & Modulation : GFSK***

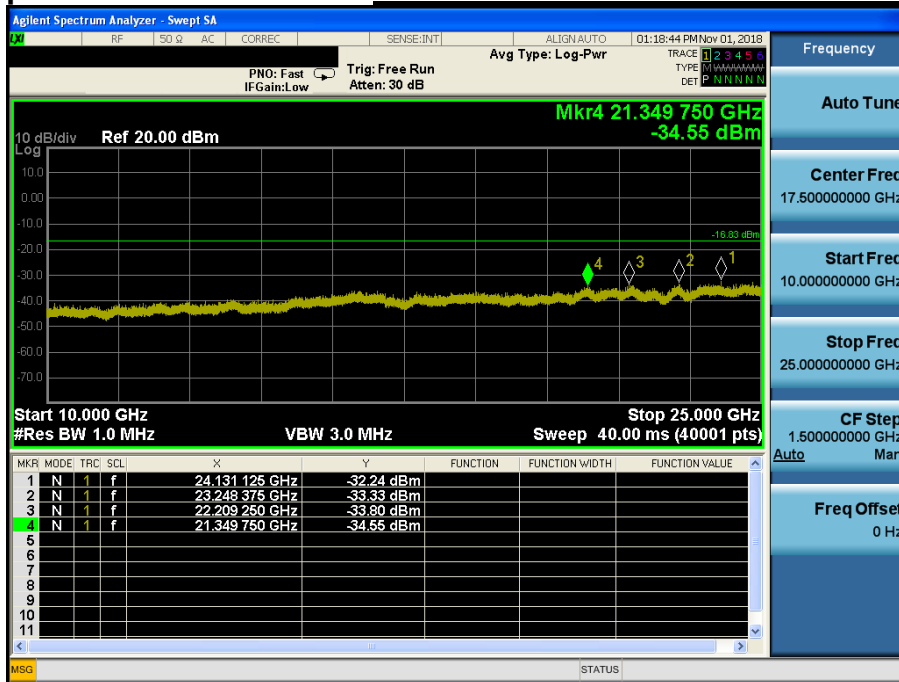

Reference for limit

***Middle Channel & Modulation : GFSK***



Conducted Spurious Emissions

***Middle Channel & Modulation : GFSK***

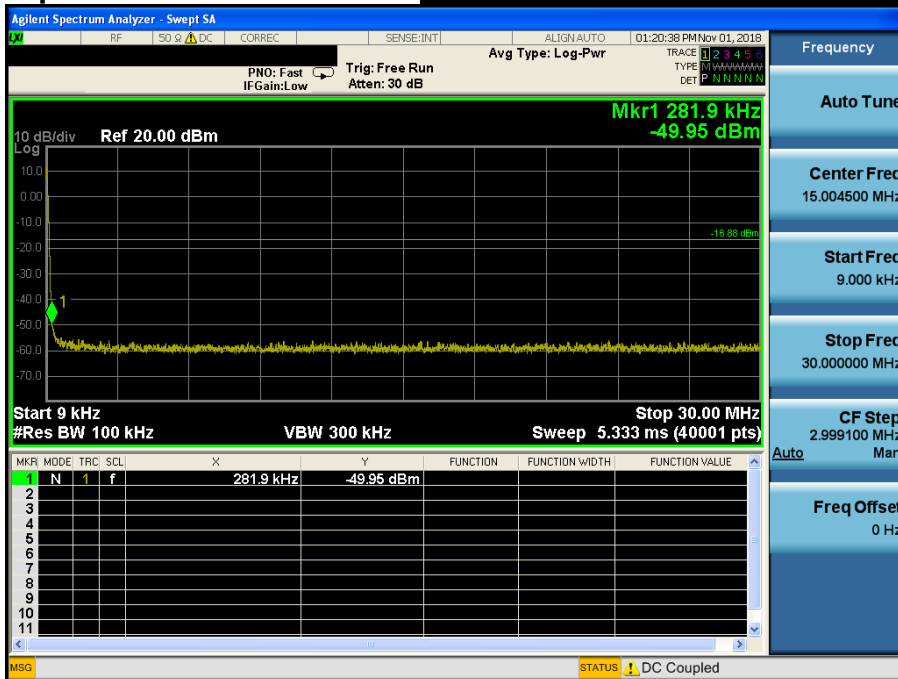



Conducted Spurious Emissions **Middle Channel & Modulation : GFSK**

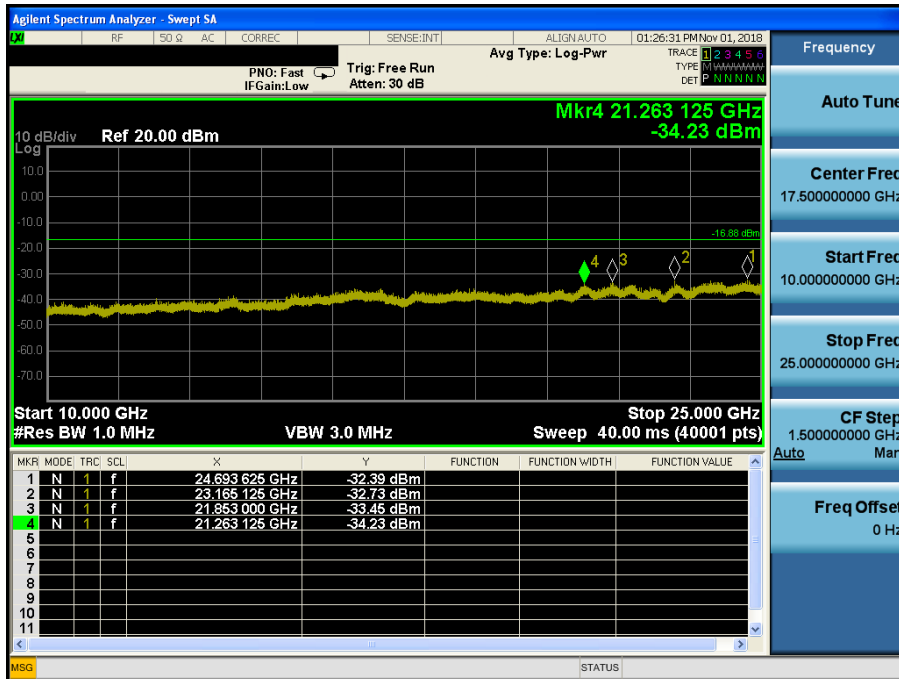
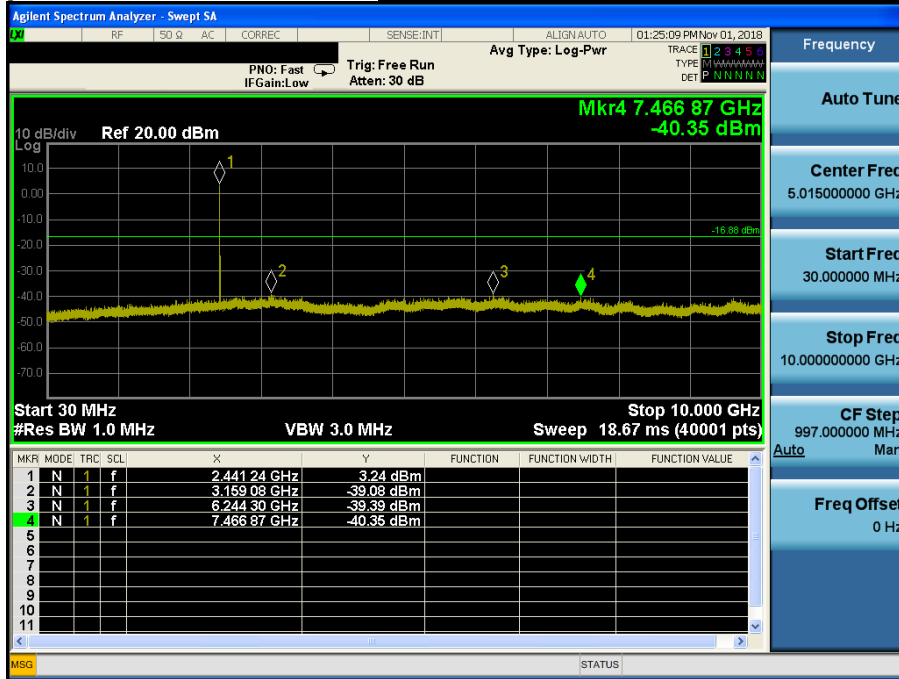

High Band-edge

Highest Channel & Modulation : GFSK



High Band-edge

Hopping mode & Modulation : GFSK



Conducted Spurious Emissions *Highest Channel & Modulation : GFSK*

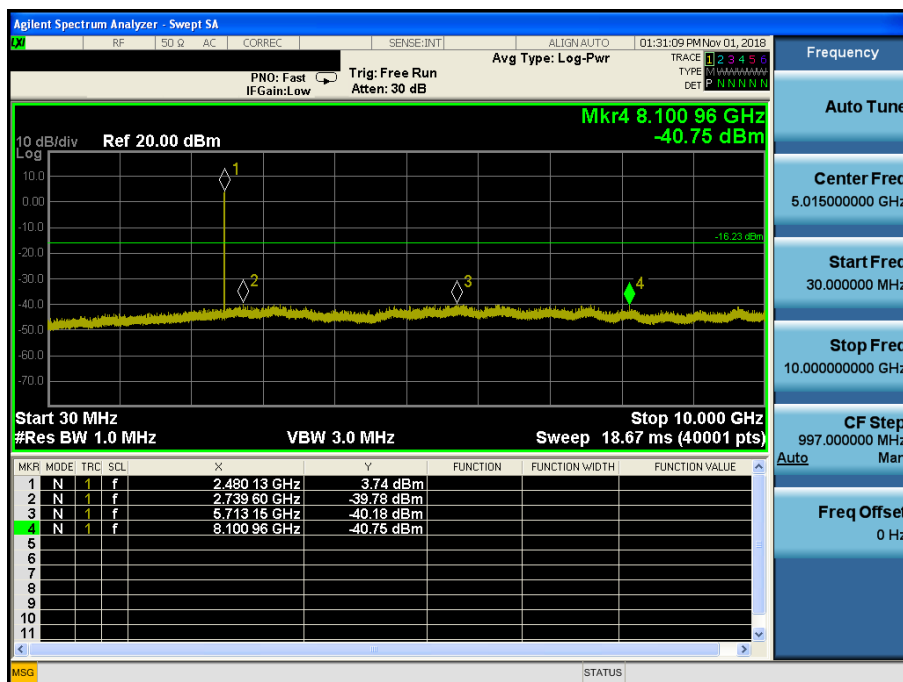
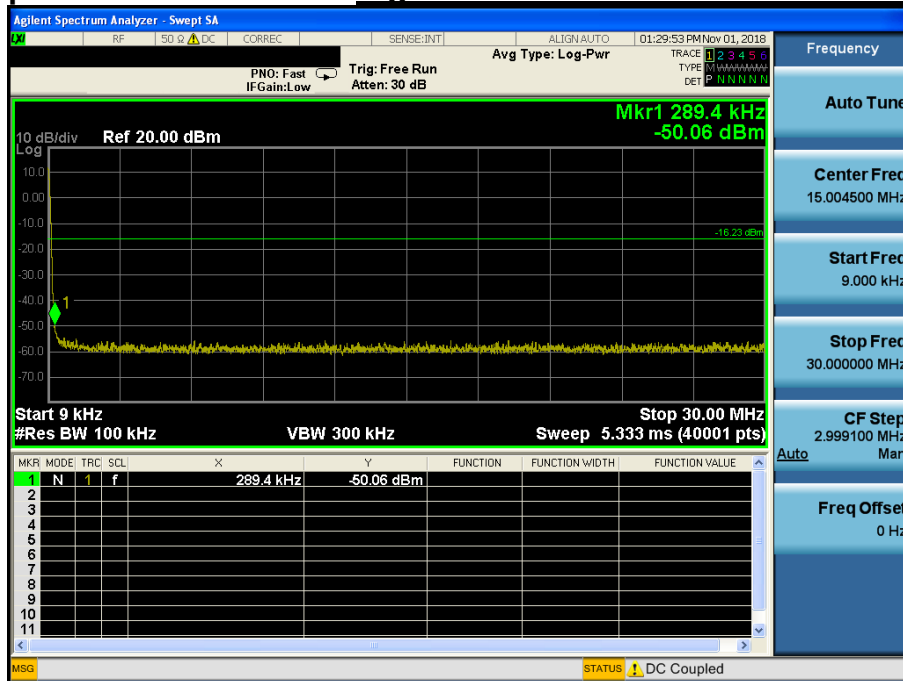

Conducted Spurious Emissions *Highest Channel & Modulation : GFSK*

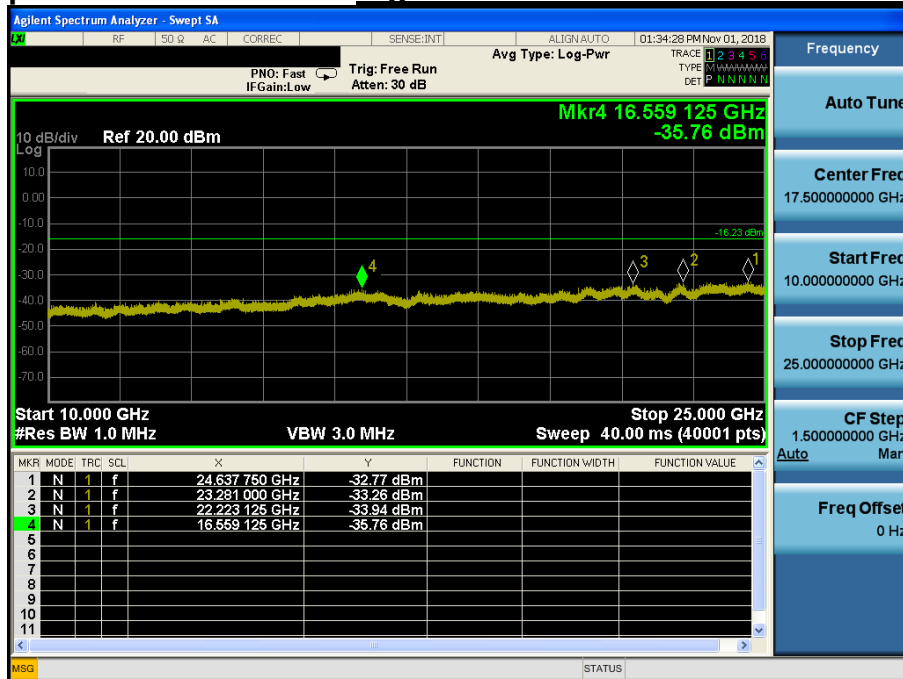

Low Band-edge

**Lowest Channel & Modulation :  $\pi/4$ DQPSK**



Frequency

Auto Tune

Center Freq  
2.400000000 GHz

Start Freq  
2.395000000 GHz

Stop Freq  
2.405000000 GHz

CF Step  
1.000000 MHz

Auto Man

Freq Offset  
0 Hz

Low Band-edge

**Hopping mode & Modulation :  $\pi/4$ DQPSK**



Frequency

Auto Tune

Center Freq  
2.400000000 GHz

Start Freq  
2.395000000 GHz

Stop Freq  
2.405000000 GHz

CF Step  
1.000000 MHz

Auto Man

Freq Offset  
0 Hz

Conducted Spurious Emissions **Lowest Channel & Modulation :  $\pi/4$ DQPSK**

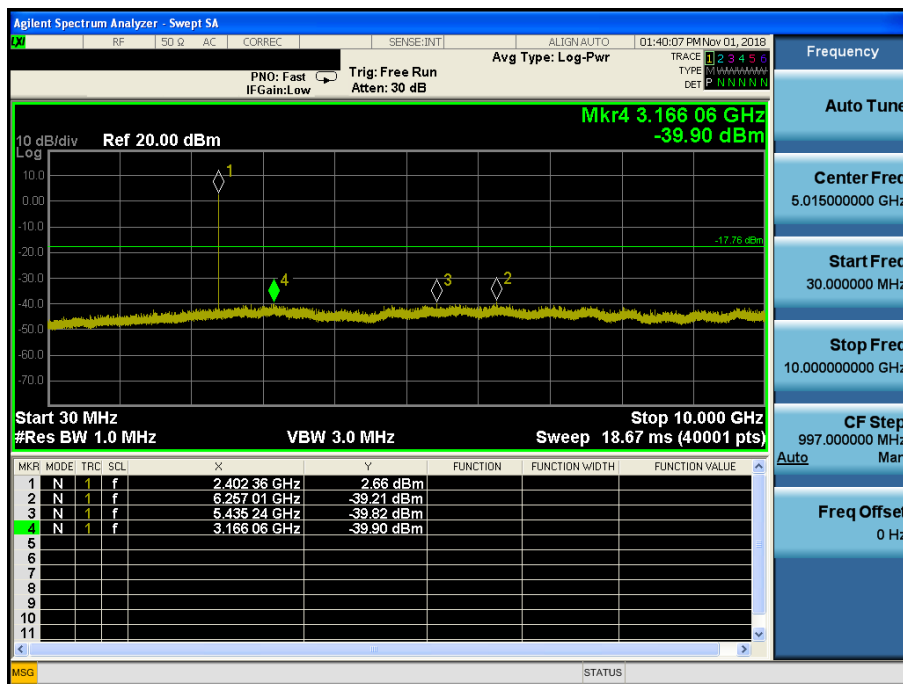
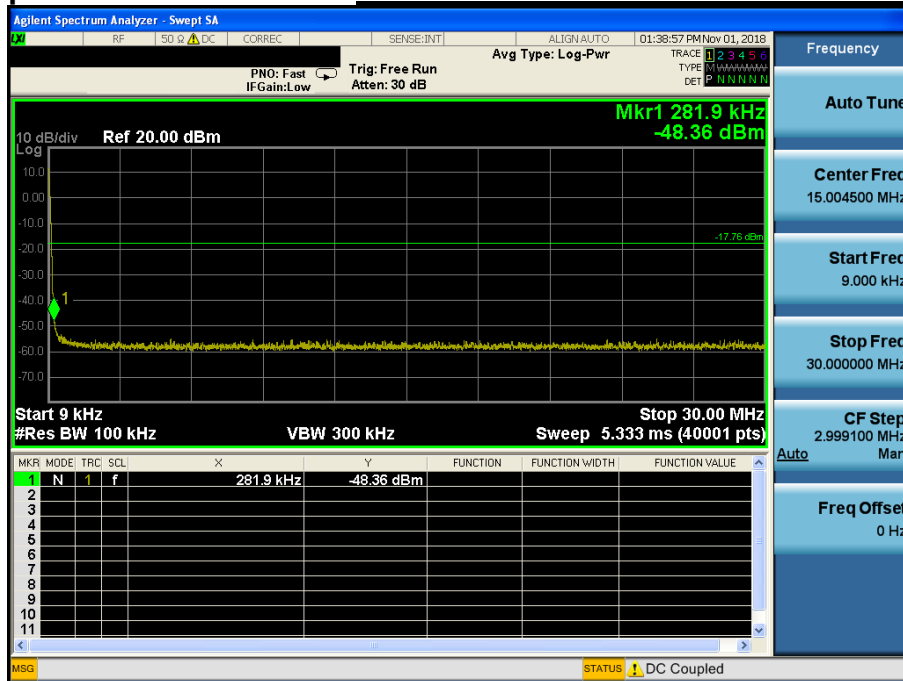

Conducted Spurious Emissions **Lowest Channel & Modulation :  $\pi/4$ DQPSK**

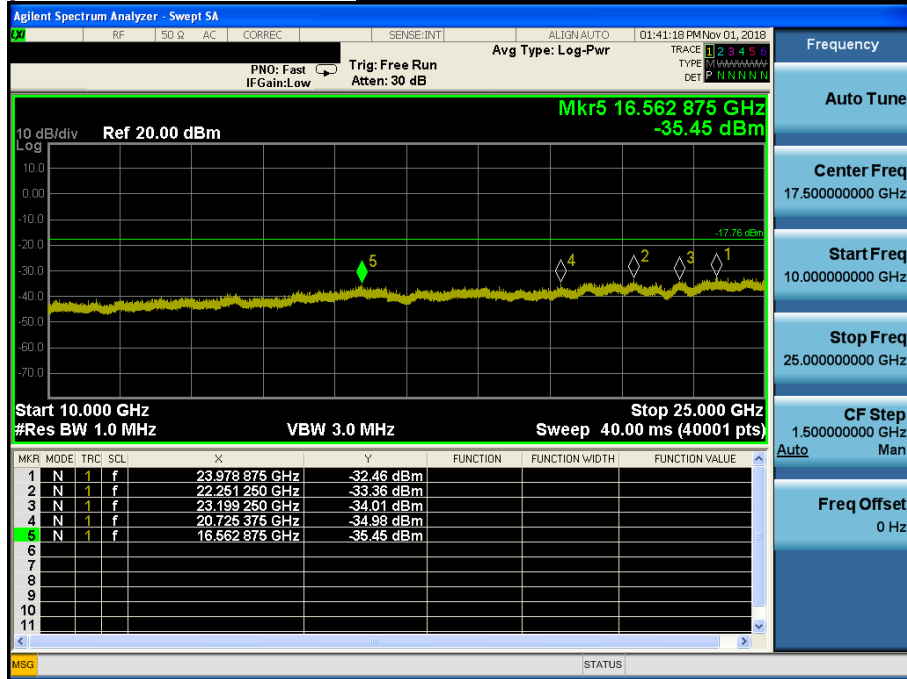

Reference for limit

**Middle Channel & Modulation :  $\pi/4$ DQPSK**

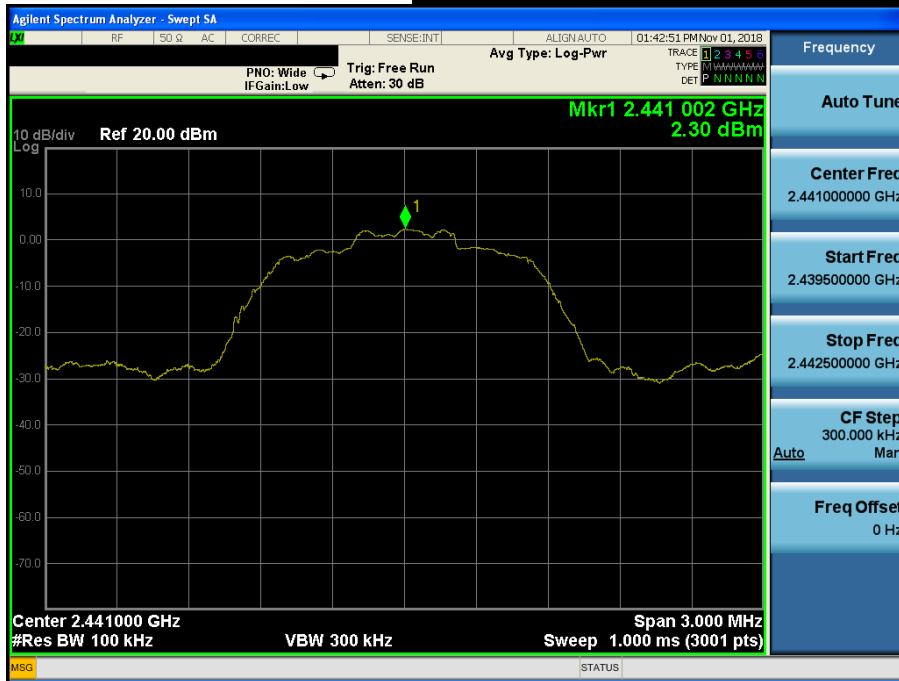

Conducted Spurious Emissions

**Middle Channel & Modulation :  $\pi/4$ DQPSK**

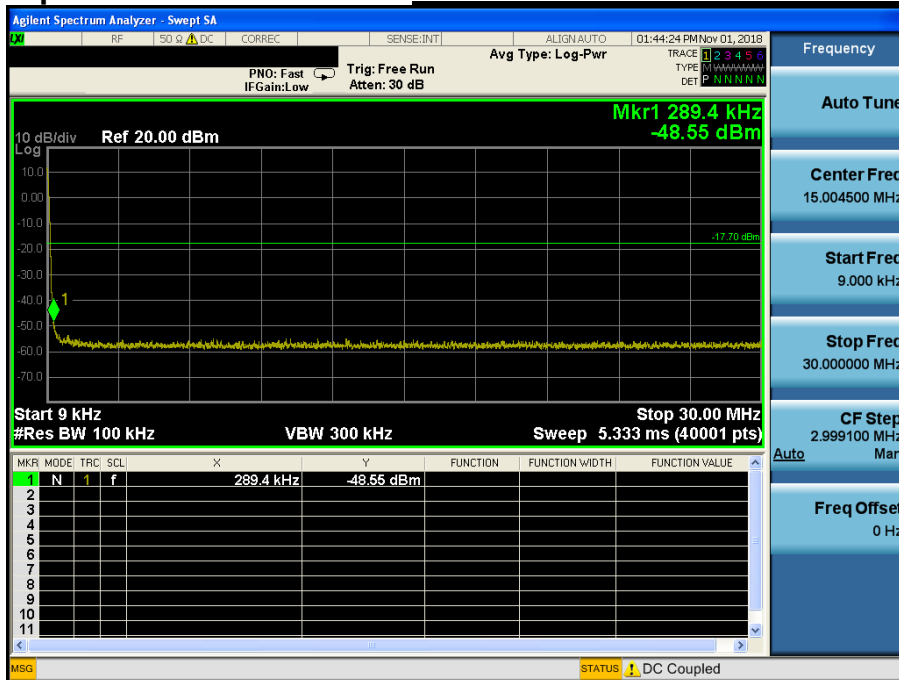



Conducted Spurious Emissions *Middle Channel & Modulation :  $\pi/4$ DQPSK*

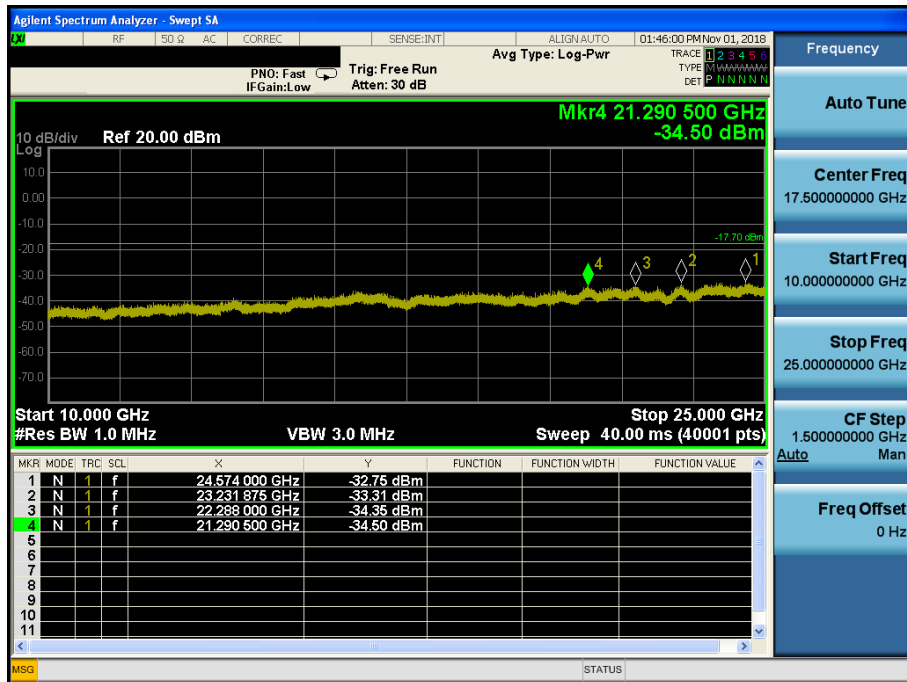
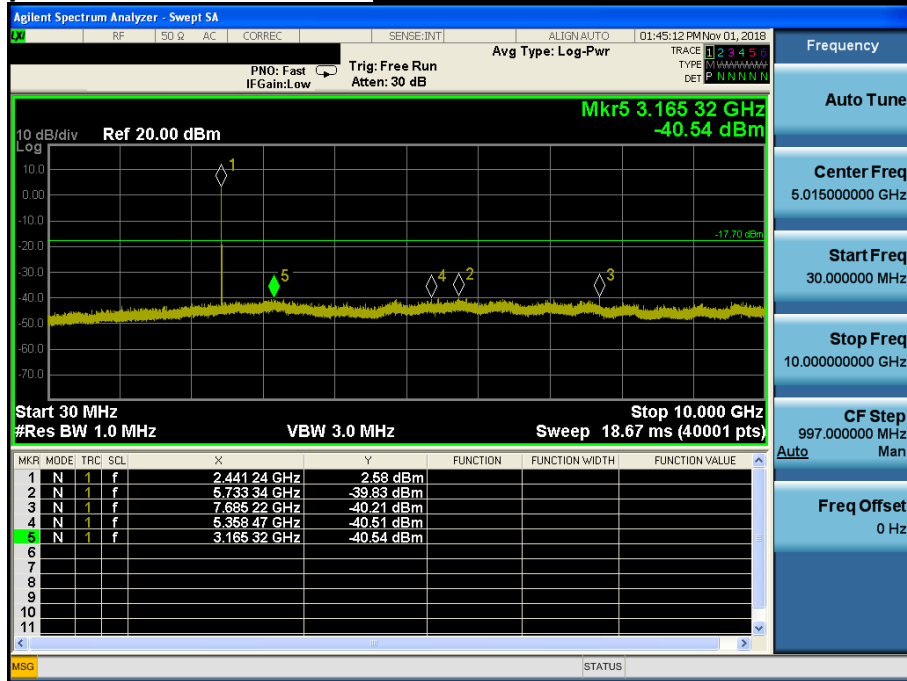

High Band-edge

**Highest Channel & Modulation :  $\pi/4$ DQPSK**



High Band-edge

**Hopping mode & Modulation :  $\pi/4$ DQPSK**



Conducted Spurious Emissions **Highest Channel & Modulation :  $\pi/4$ DQPSK**

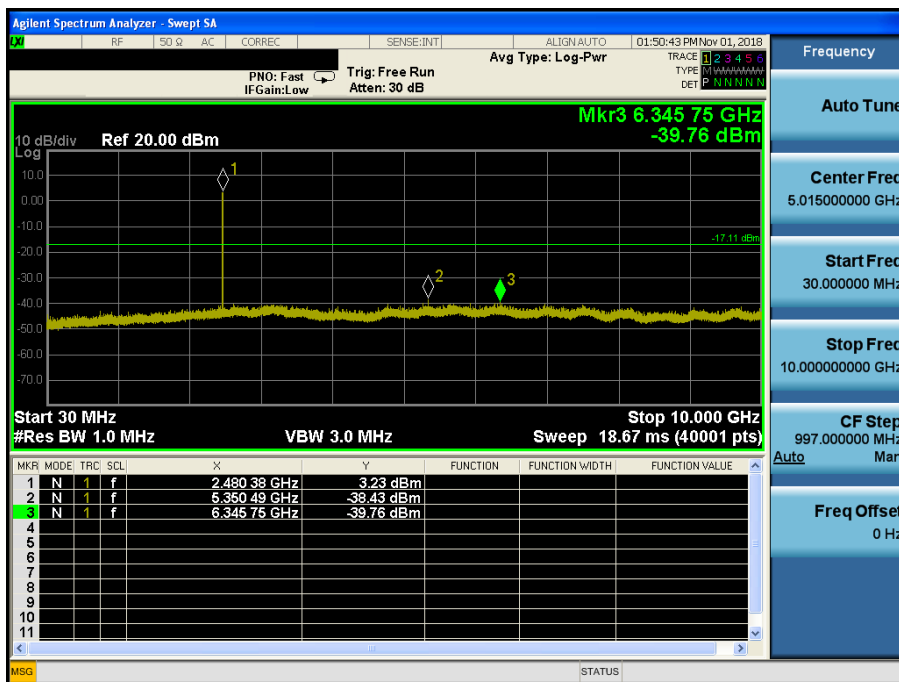
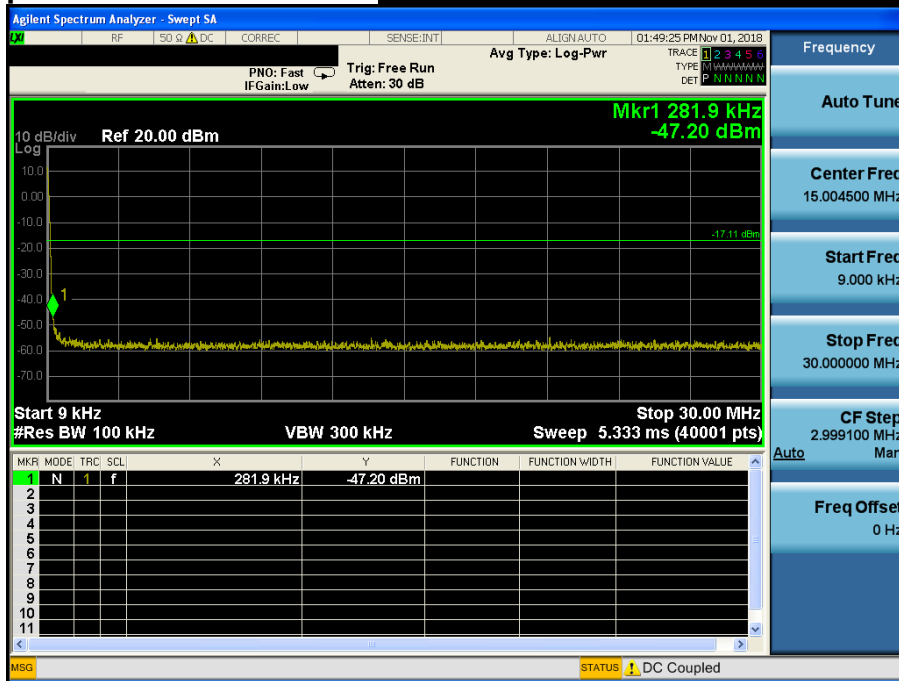

Conducted Spurious Emissions **Highest Channel & Modulation :  $\pi/4$ DQPSK**

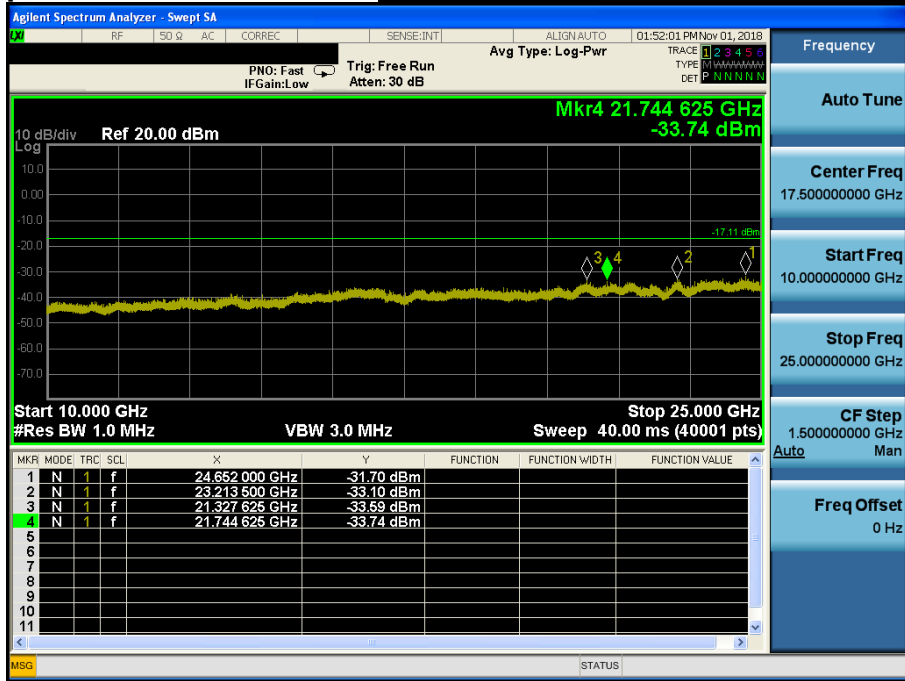

Low Band-edge

***Lowest Channel & Modulation : 8DPSK***



Low Band-edge

***Hopping mode & Modulation : 8DPSK***



Conducted Spurious Emissions **Lowest Channel & Modulation : 8DPSK**

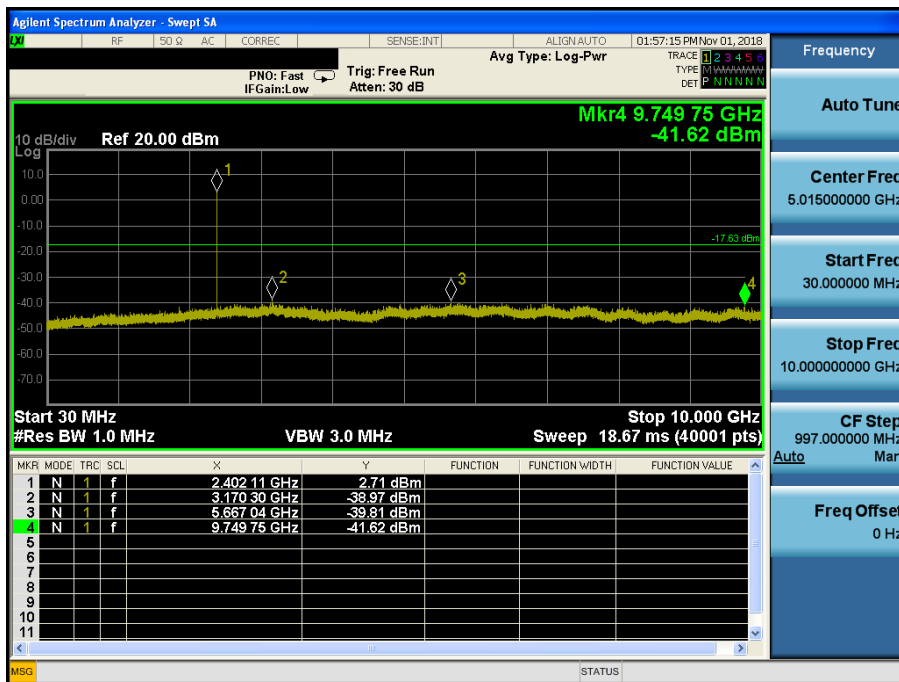
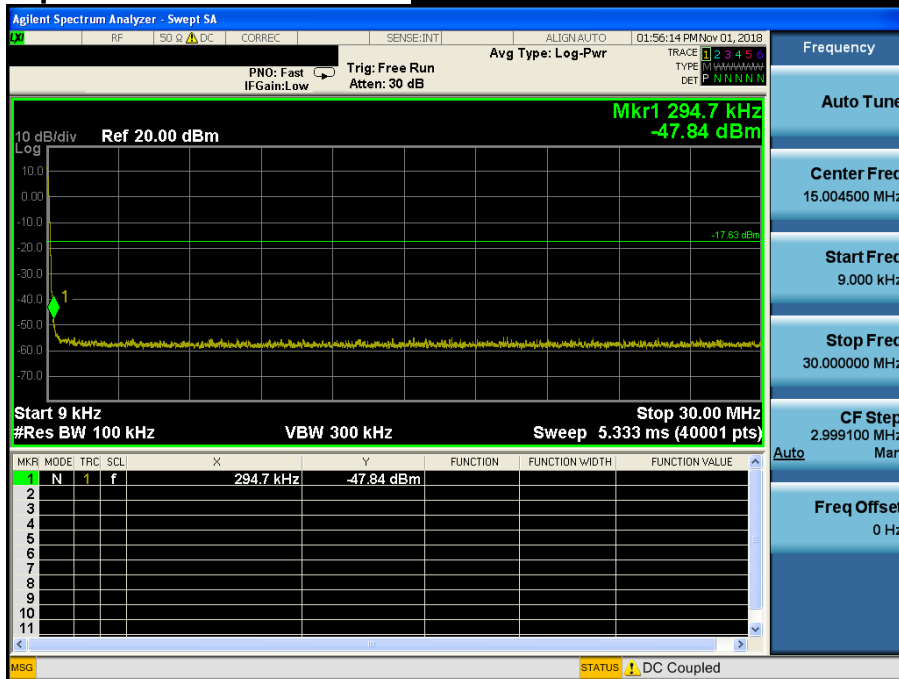

**Conducted Spurious Emissions**      **Lowest Channel & Modulation : 8DPSK**

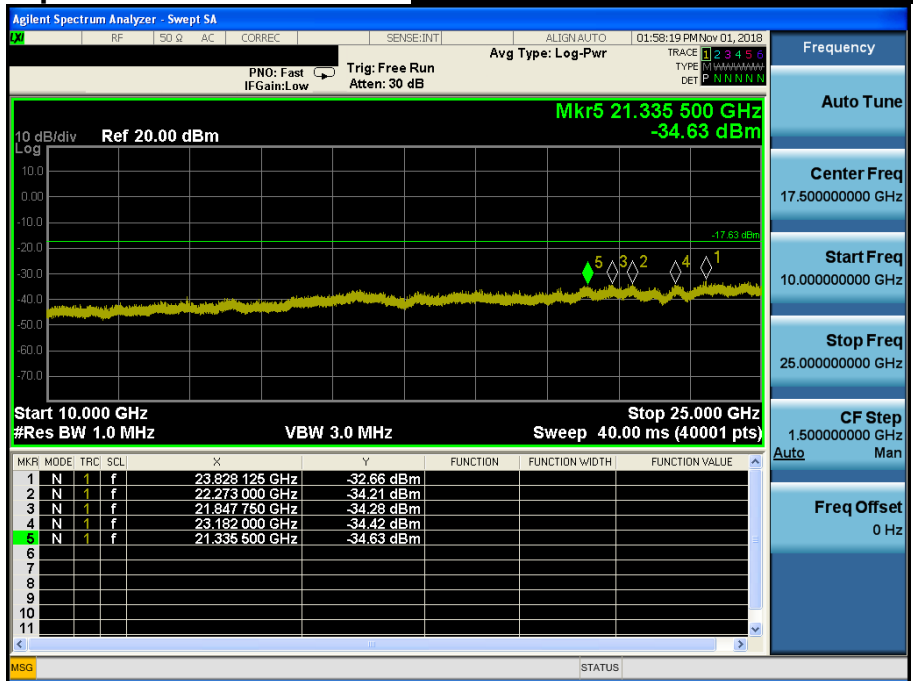

Reference for limit

**Middle Channel & Modulation : 8DPSK**

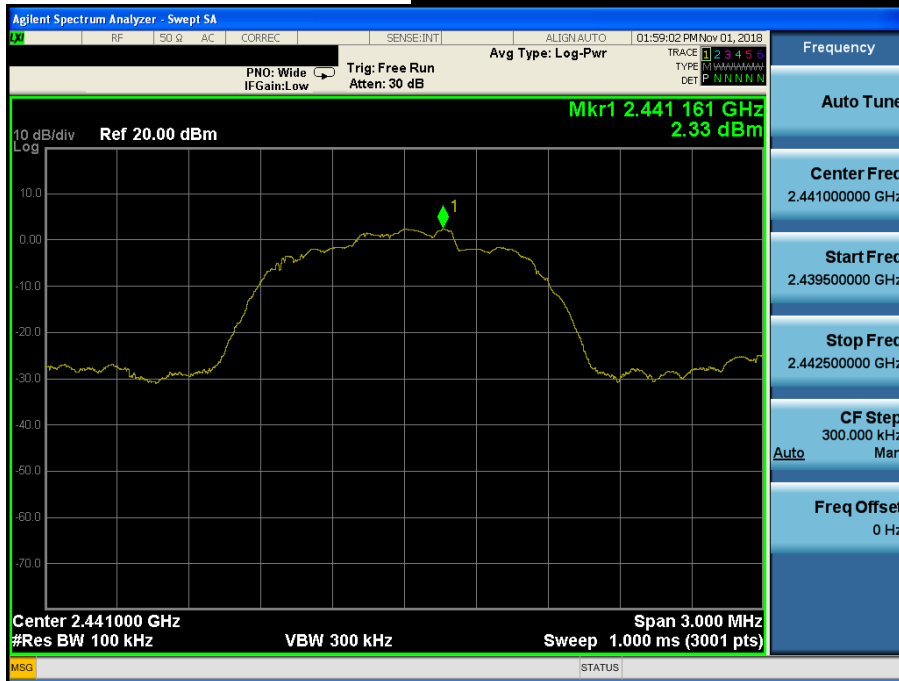

Conducted Spurious Emissions

**Middle Channel & Modulation : 8DPSK**

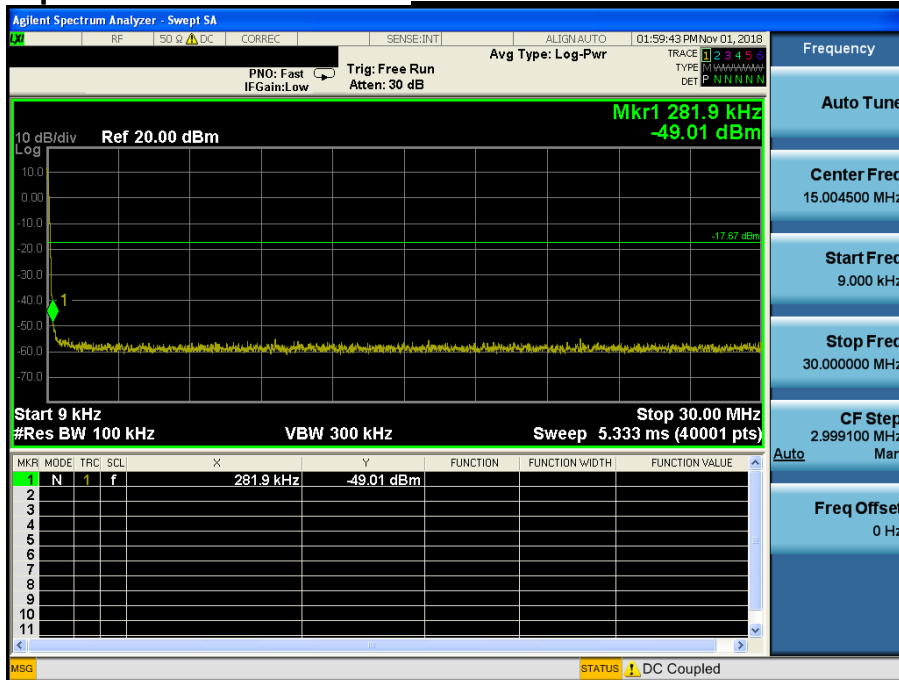



Conducted Spurious Emissions **Middle Channel & Modulation : 8DPSK**

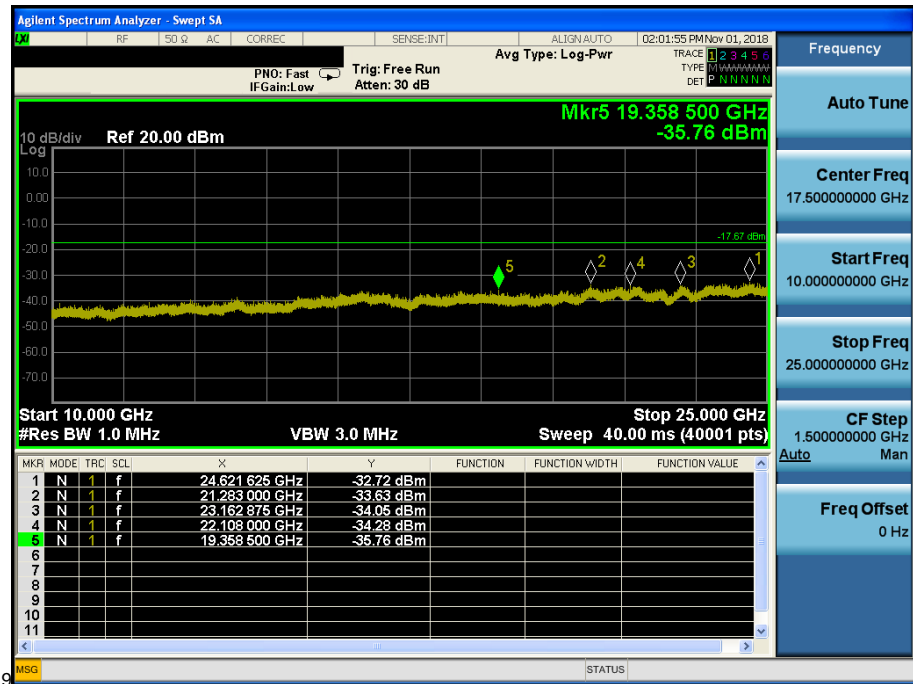
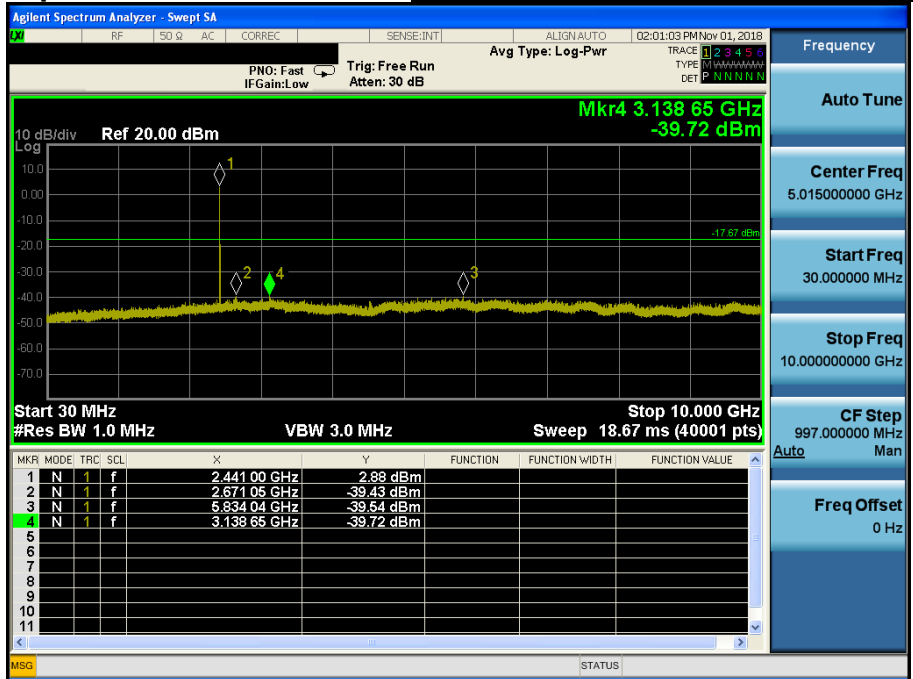

High Band-edge

**Highest Channel & Modulation : 8DPSK**



High Band-edge

**Hopping mode & Modulation : 8DPSK**



Conducted Spurious Emissions **Highest Channel & Modulation : 8DPSK**

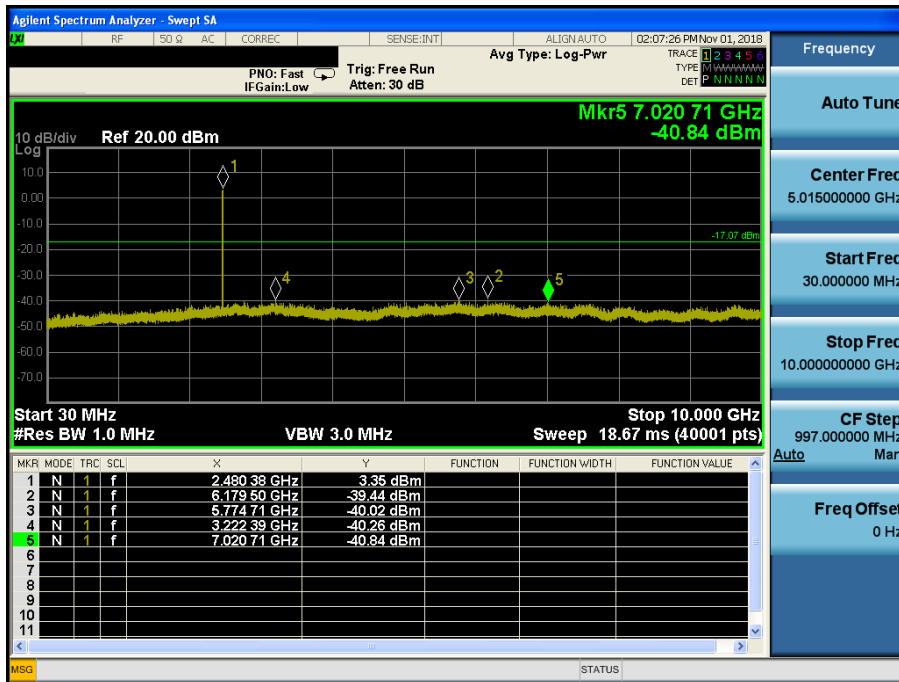
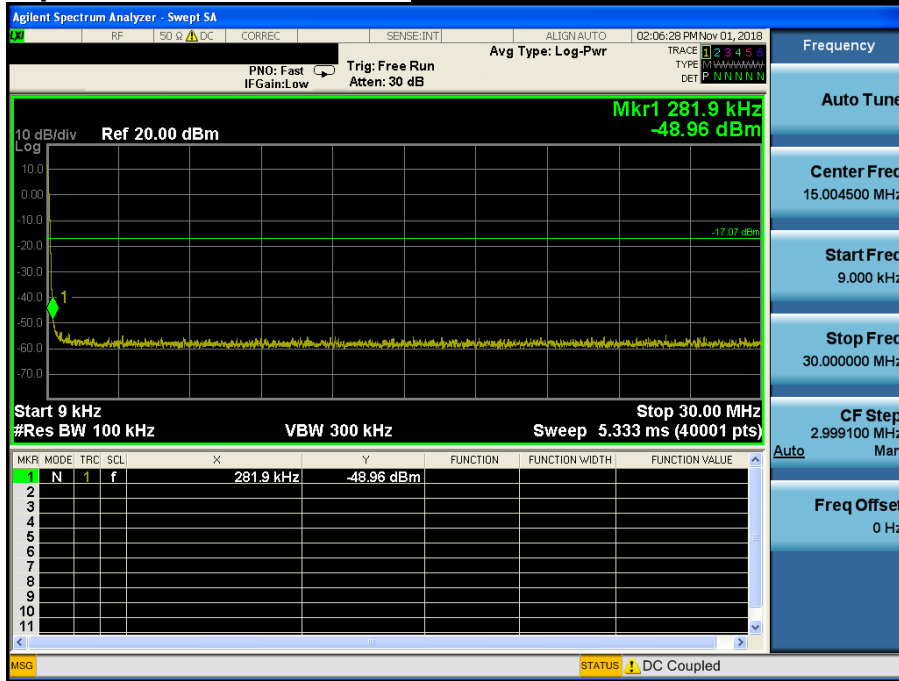

**Conducted Spurious Emissions**      **Highest Channel & Modulation : 8DPSK**

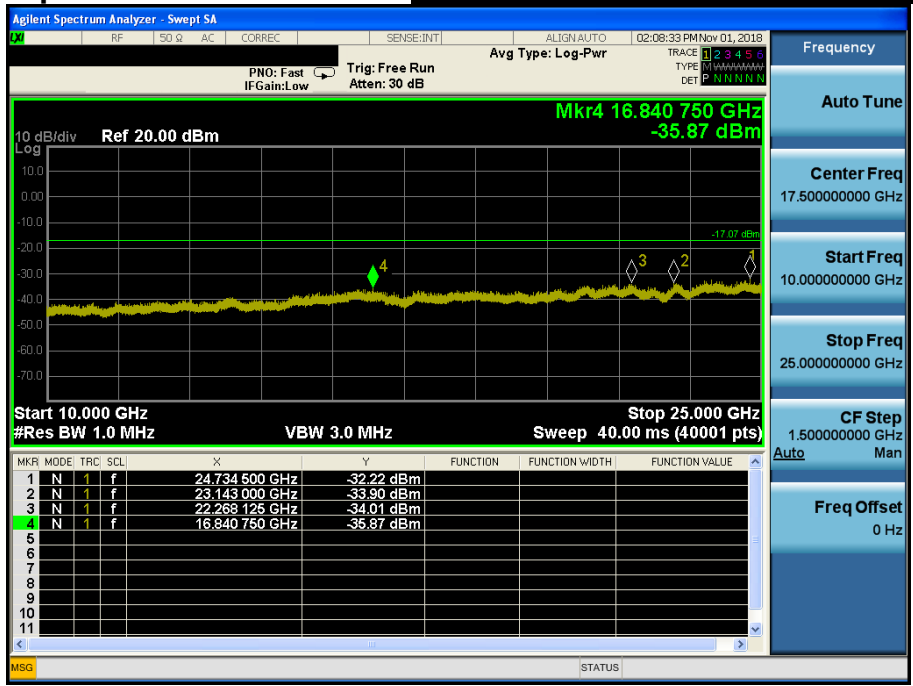

## 8. Transmitter AC Power Line Conducted Emission

### 8.1 Test Setup

See test photographs for the actual connections between EUT and support equipment.

### 8.2 Limit

According to §15.207(a) for an intentional radiator that is designed to be connected to the public utility (AC) power line, the radio frequency voltage that is conducted back onto the AC power line on any frequency or frequencies, within the band 150 kHz to 30 MHz, shall not exceed the limits in the following table, as measured using a 50 uH/50 ohm line impedance stabilization network (LISN).

Compliance with the provision of this paragraph shall on the measurement of the radio frequency voltage between each power line and ground at the power terminal. The lower applies at the boundary between the frequency ranges.

Frequency Range (MHz)	Conducted Limit (dBuV)	
	Quasi-Peak	Average
0.15 ~ 0.5	66 to 56 *	56 to 46 *
0.5 ~ 5	56	46
5 ~ 30	60	50

\* Decreases with the logarithm of the frequency

### 8.3 Test Procedures

Conducted emissions from the EUT were measured according to the ANSI C63.10.

1. The test procedure is performed in a 6.5 m × 3.5 m × 3.5 m (L × W × H) shielded room. The EUT along with its peripherals were placed on a 1.0 m (W) × 1.5 m (L) and 0.8 m in height wooden table and the EUT was adjusted to maintain a 0.4 meter space from a vertical reference plane.
2. The EUT was connected to power mains through a line impedance stabilization network (LISN) which provides 50 ohm coupling impedance for measuring instrument and the chassis ground was bounded to the horizontal ground plane of shielded room.
3. All peripherals were connected to the second LISN and the chassis ground also bounded to the horizontal ground plane of shielded room.
4. The excess power cable between the EUT and the LISN was bundled. The power cables of peripherals were unbundled. All connecting cables of EUT and peripherals were moved to find the maximum emission.

8.4 Test Results

AC Line Conducted Emissions (Graph) = Modulation : 8DPSK

Results of Conducted Emission

DTNC Date 2018-10-05

Order No.	ZEROi	Reference No.	
Model No.		Power Supply	120 V / 60Hz
Serial No.		Temp/Humi.	25 'C / 45 %
Test Condition	Bluetooth	Operator	J.H Bang

Memo

LIMIT : FCC P15.207 QP  
FCC P15.207 AV

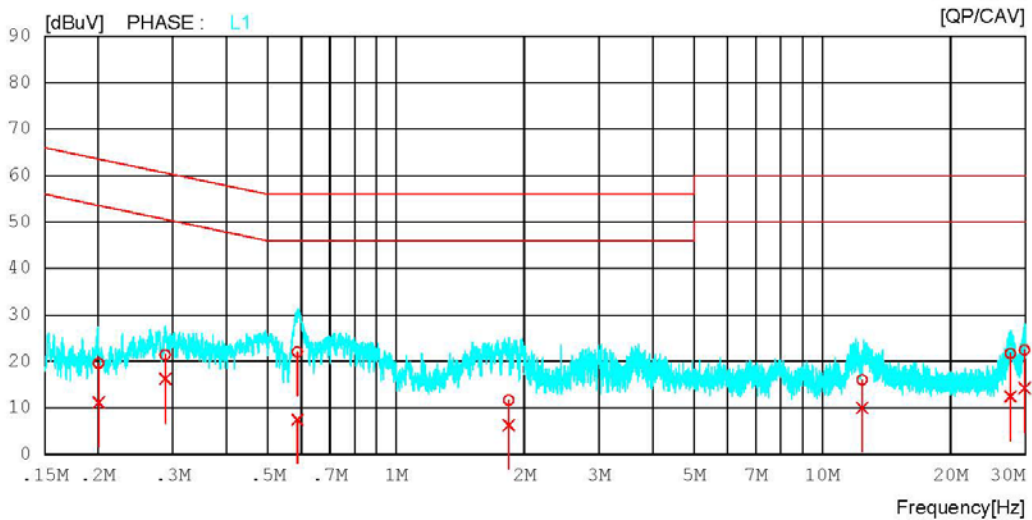
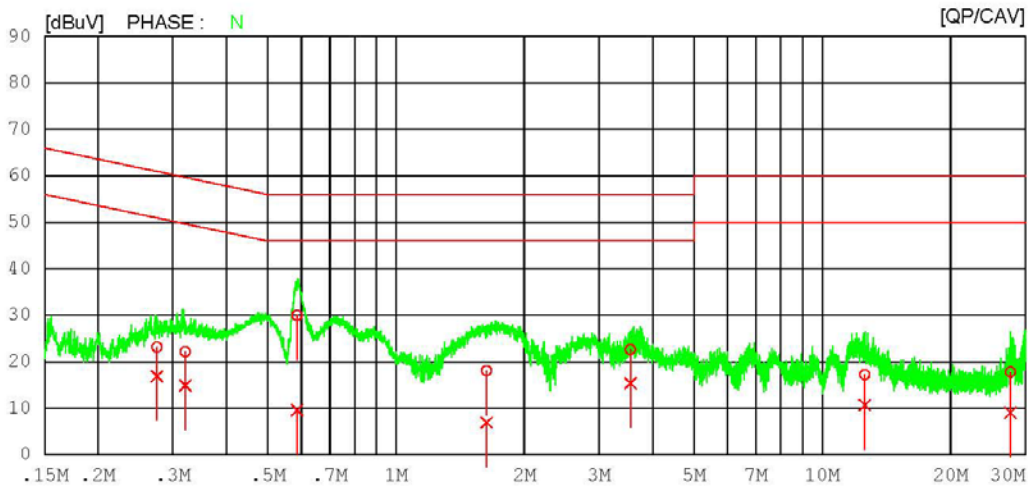

**AC Line Conducted Emissions (List) = Modulation : 8DPSK**

### Results of Conducted Emission

DTNC

Date 2018-10-05

Order No.	ZEROi	Reference No.	
Model No.		Power Supply	120 V / 60Hz
Serial No.		Temp/Humi.	25 'C / 45 %
Test Condition	Bluetooth	Operator	J.H Bang

Memo

 LIMIT : FCC P15.207 QP  
 FCC P15.207 AV

NO	FREQ [MHz]	READING		C. FACTOR [dB]	RESULT		LIMIT		MARGIN		PHASE
		QP [dBuV]	CAV [dBuV]		QP [dBuV]	CAV [dBuV]	QP [dBuV]	CAV [dBuV]			
1	0.27515	13.10	6.90	10.02	23.12	16.92	60.96	50.96	37.84	34.04	N
2	0.32050	12.12	4.88	10.02	22.14	14.90	59.69	49.69	37.55	34.79	N
3	0.58655	19.92	-0.42	10.04	29.96	9.62	56.00	46.00	26.04	36.38	N
4	1.63220	7.95	-3.19	10.09	18.04	6.90	56.00	46.00	37.96	39.10	N
5	3.55080	12.46	5.20	10.18	22.64	15.38	56.00	46.00	33.36	30.62	N
6	12.59020	6.78	0.20	10.45	17.23	10.65	60.00	50.00	42.77	39.35	N
7	27.66660	7.07	-1.63	10.69	17.76	9.06	60.00	50.00	42.24	40.94	N
8	0.20064	9.63	1.16	9.98	19.61	11.14	63.58	53.58	43.97	42.44	L1
9	0.28761	11.48	6.28	9.98	21.46	16.26	60.59	50.59	39.13	34.33	L1
10	0.58762	12.07	-2.53	10.01	22.08	7.48	56.00	46.00	33.92	38.52	L1
11	1.83980	1.60	-3.79	10.07	11.67	6.28	56.00	46.00	44.33	39.72	L1
12	12.41020	5.68	-0.38	10.39	16.07	10.01	60.00	50.00	43.93	39.99	L1
13	27.65480	11.11	1.86	10.63	21.74	12.49	60.00	50.00	38.26	37.51	L1
14	29.82084	11.81	3.60	10.67	22.48	14.27	60.00	50.00	37.52	35.73	L1

## 9. Antenna Requirement

Describe how the EUT complies with the requirement that either its antenna is permanently attached, or that it employs a unique antenna connector, for every antenna proposed for use with the EUT.

**Conclusion: Comply**

**The antenna is permanently attached. (Refer to Internal Photo file.)  
Therefore this EUT complies with the requirement of §15.203.**

**- Minimum Standard :**

An intentional radiator shall be designed to ensure that no antenna other than that furnished by the responsible party shall be used with the device. The use of a permanently attached antenna or of an antenna that uses a unique coupling to the intentional radiator shall be considered sufficient to comply with the provisions.
--



**APPENDIX I**

**Test set up diagrams**

**▪ Radiated Measurement**

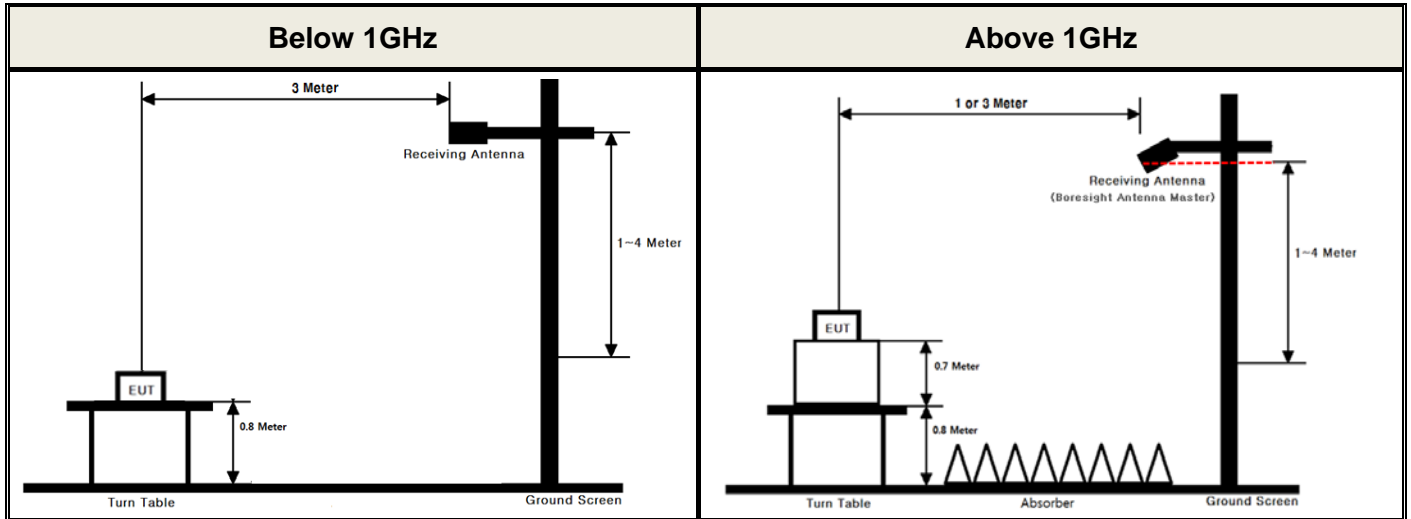

**▪ Conducted Measurement**

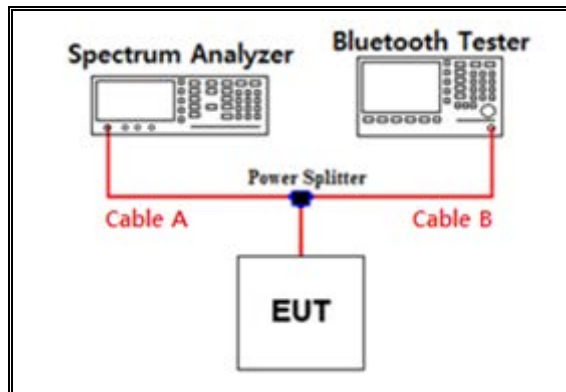

**Path loss information**

Frequency (GHz)	Path Loss (dB)	Frequency (GHz)	Path Loss (dB)
0.03	6.00	15	6.59
1	6.10	20	6.62
2.402 & 2.441 & 2.480	6.18	25	6.77
5	6.21	-	-
10	6.31	-	-

Note 1 : The path loss from EUT to Spectrum analyzer were measured and used for test.

Path loss ( S/A's Correction factor) = Cable A+ Power splitter

APPENDIX II

Unwanted Emissions (Radiated) Test Plot

GFSK & Lowest & X & Hor

Detector Mode : AV

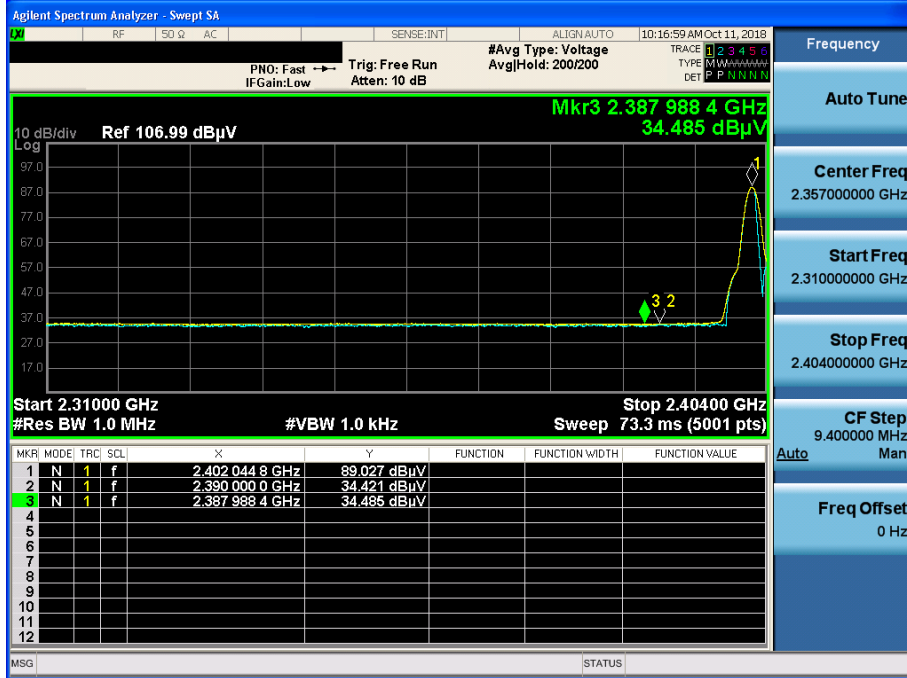

GFSK & Highest & X & Hor

Detector Mode : AV



$\pi$ /4DQPSK & Lowest & Y & Ver

Detector Mode : AV

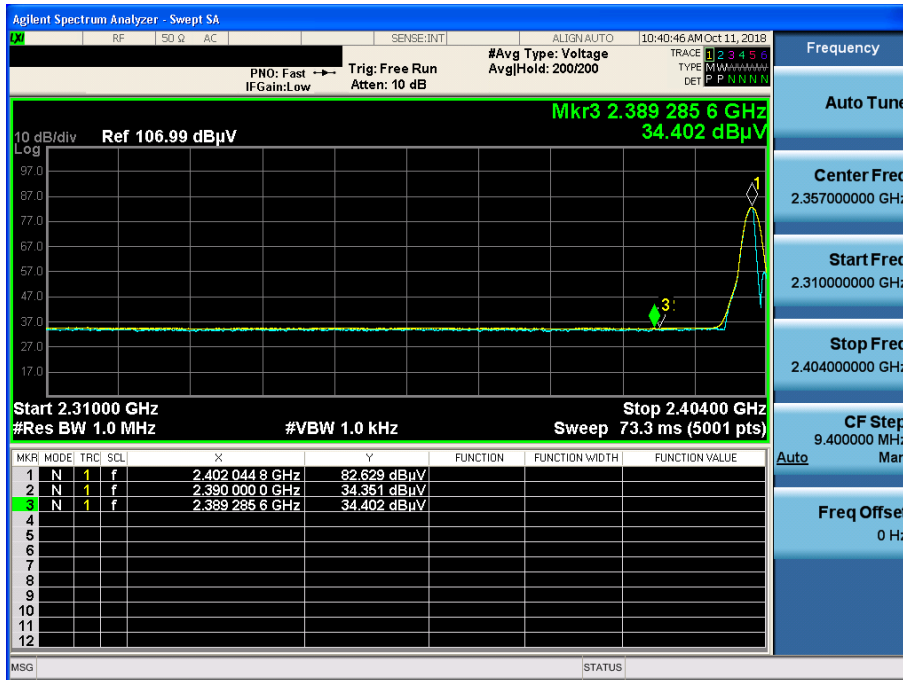

$\pi$ /4DQPSK & Highest & Y & Ver

Detector Mode : AV



8DPSK & Lowest & Y & Ver

Detector Mode : AV

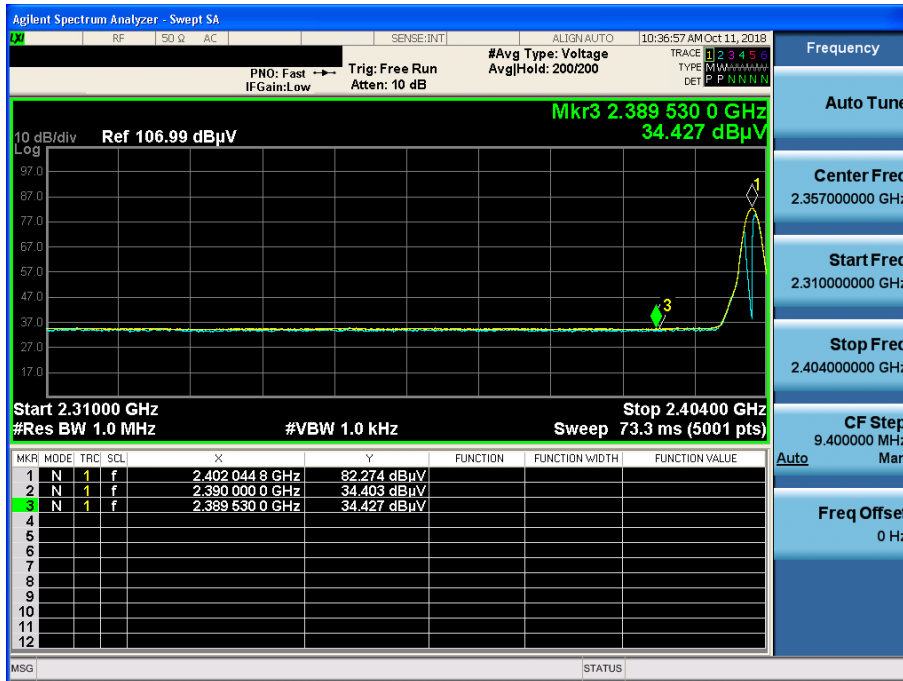

8DPSK & Highest & Y & Ver

Detector Mode : AV

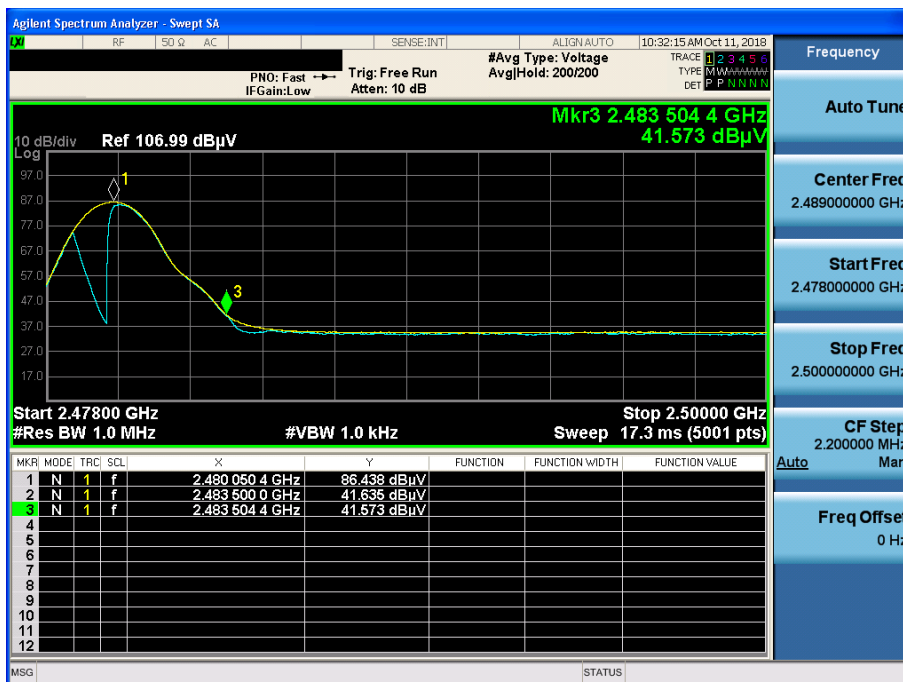

GFSK & Middle & Y & Ver

Detector Mode : AV

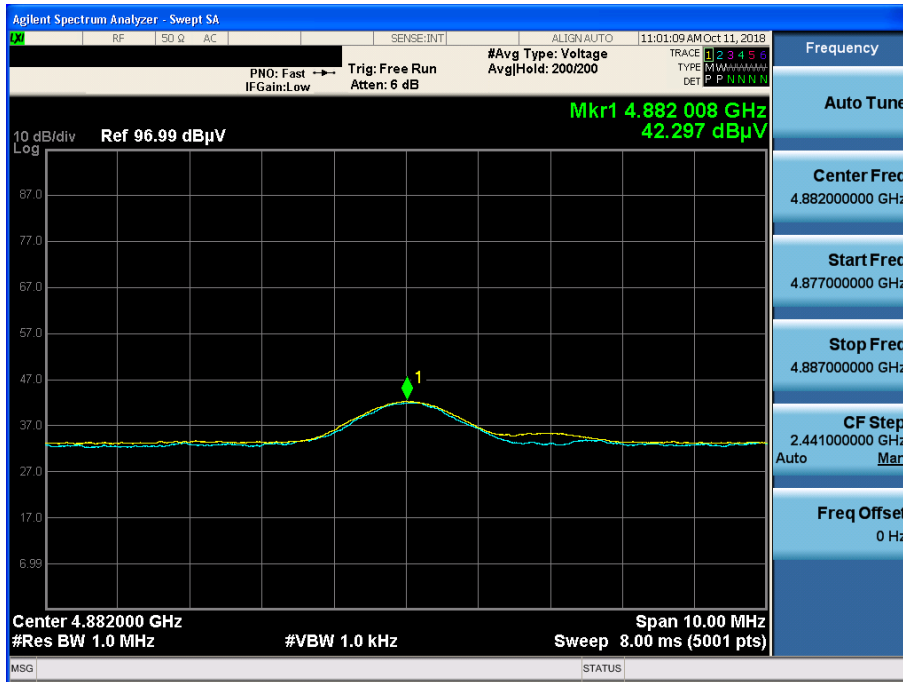

$\pi/4$ DQPSK & Middle & Z & Ver

Detector Mode : AV

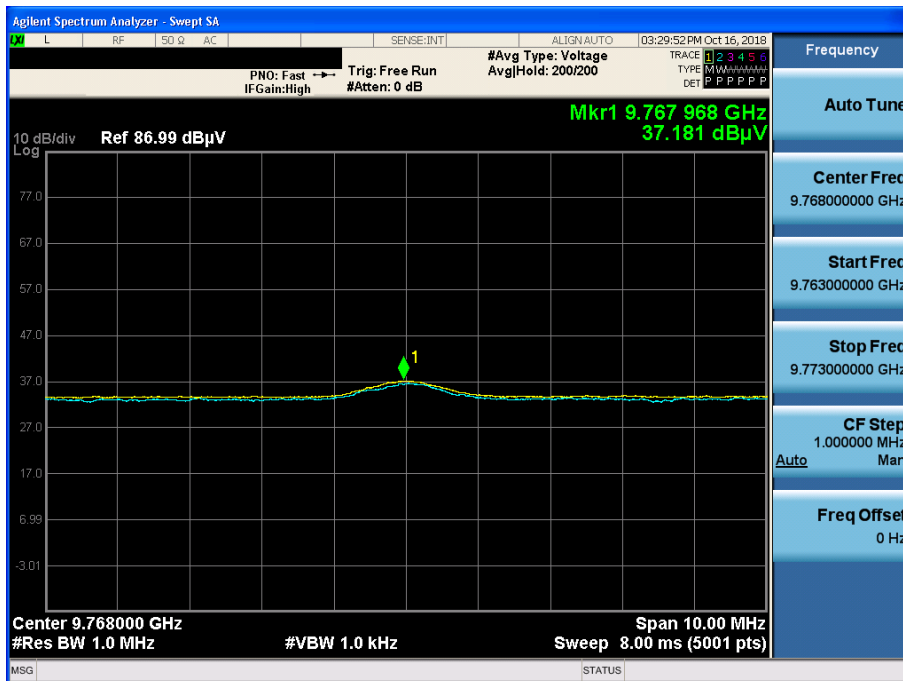

8DPSK & Lowest & Y & Hor

Detector Mode : AV

