

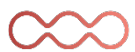

# Care@Home™

**C7000**

User Guide



February 2021



# Table of Contents

- 1. Overview.....3
- 2. Installing the C7000.....5
  - 2.1. Determining the Best Location for the C7000.....5
  - 2.2. Necessary Items .....5
  - 2.3. Setting Up the C7000 ..... 6
  - 2.4. Wall Mounting the C7000 ..... 9
  - 2.5. Configuring C7000 Parameters ..... 9
- 3. Operating the C7000..... 10
  - 3.1. Monitoring a Resident – Pro and Family ..... 10
  - 3.2. Monitoring a Resident - PERS..... 10
    - 3.2.1 Activity Timer ..... 10
    - 3.2.2 Inactivity Timer ..... 10
  - 3.3. Emergency Alarms ..... 11
  - 3.4. Safety Alarms ..... 11
  - 3.5. Vocal Reminders ..... 12
  - 3.6. Speakerphone..... 12
  - 3.7. Emergency Conversation Flow with the C7000..... 12
    - 3.7.1 Half-Duplex Conversation Flow ..... 12
  - 3.8. Making a Remote Call-In ..... 13
  - 3.9. C7000 LEDs..... 14
- 4. Restoring Factory Settings..... 16
- 5. Removing All Peripherals ..... 17
- 6. Maintaining the C7000 ..... 18
  - 6.1. Software Updates..... 18
  - 6.2. Communications Maintenance..... 18
  - 6.3. Replacing the Backup Battery ..... 18
  - 6.4. Resetting the C7000 ..... 19
- 7. Specifications..... 20
- Appendix A Testing Peripherals..... 23
  - Testing Activity Sensors ..... 23
  - Testing Emergency Devices..... 23
    - Troubleshooting ..... 24
  - Testing the MDsense ..... 25

# 1. Overview

The Care@Home™ C7000 is a connected, emergency-response control device, used for personal emergency applications. The C7000 is designed to monitor people living at home or in an assisted-living facility. The C7000 works with the Care@Home™ sensor devices, collects information about the resident’s daily activities, and transmits the information to the monitoring station.



**NOTE:** C7000 is the trade name used for marketing the Care@Home™ ES7502HC family of control panels.



The C7000 includes a high-volume speaker, and a sensitive microphone. The **EMERGENCY CALL** and **RESET** buttons on the C7000, include raised braille characters, for ease of use by visually impaired residents.

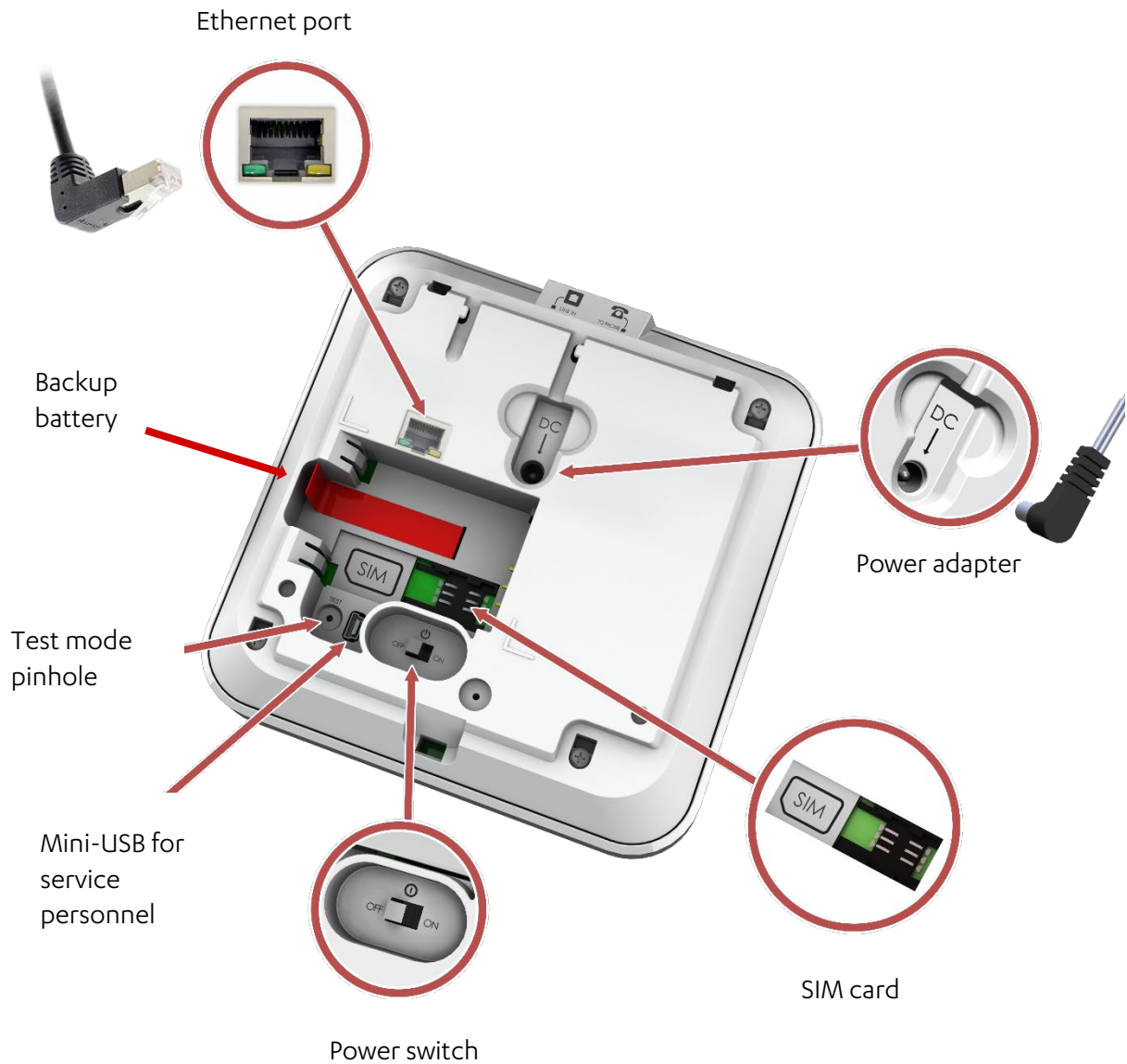

The C7000 has a rechargeable battery as a backup power source. The C7000 communicates with the monitoring station using a cellular network or a standard telephone network Public Switched Telephone Network (PSTN) landline or Ethernet, according to the C7000 version. Cellular and Ethernet communication are supported by Pro, Family, and PERS. PSTN communication is supported by PERS. If there is a communications failure, the C7000 saves messages and sends them when communications are restored.

## 2. Installing the C7000

Installing the C7000 includes the following:

- Determining the best location for the C7000
- Setting up the C7000
- Table placement or wall mounting
- Configuring the C7000 parameters

### 2.1. Determining the Best Location for the C7000

Survey the premises to determine the best location for the C7000. It is recommended that you install the C7000 in either the living room or the master bedroom, in a location:

- Central within the premises
- Strong cellular reception
- For a PSTN model, near a telephone jack
- For a Ethernet model, near an Ethernet connection
- Convenient for the resident to access, yet not where the C7000 would attract attention from unauthorized users
- Where the C7000 speakerphone can be heard throughout the premises
- Away from concrete walls to eliminate radio frequency (RF) interference
- Away from metal obstructions
- At least 2 m (6 ft.) from the peripheral devices

### 2.2. Necessary Items

Ensure you have the following:

Cellular Model	PSTN Model	Ethernet Model
Rechargeable backup battery (provided)	Rechargeable backup battery (provided)	Rechargeable backup battery (provided)
Power adapter (provided)	Power adapter (provided)	Power adapter (provided)
SIM card – from the cellular service provider	PSTN telephone jack PSTN telephone cable	Ethernet port Ethernet cable

## 2.3. Setting Up the C7000

To set up the C7000:

1. Ensure the power switch is **OFF**.
2. Place your thumb in the oval hole above the power switch, and lift off the back cover.



3. For the cellular model, insert the SIM card, with its contacts facing downward.

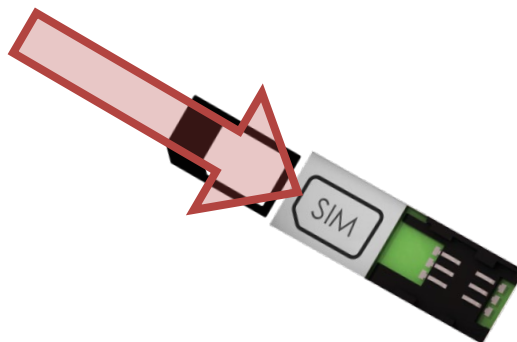

4. Insert the backup battery over the pull strip, such that:
  - The printed side of the battery is facing up
  - The battery contacts are pointing towards the C7000 contacts
  - The end of the pull strip is showing.





**Caution:** A new battery can cause damage if it is incorrectly installed.

5. Plug the power cable into the C7000 power socket and secure the cable under the tab.

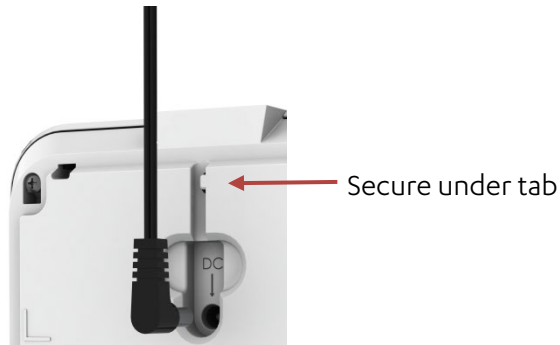

6. Connect the cable to power.



**Caution:** Do not connect to a socket controlled by a switch.

7. For US models , secure the power adapter cube.

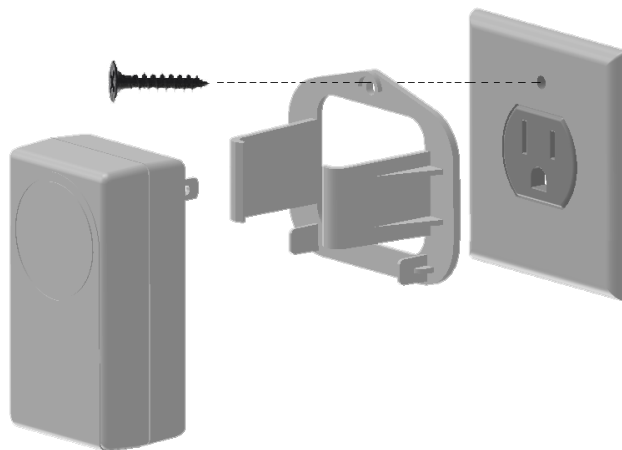

**NOTE:** Install in accordance with the requirements of: The National Electrical Code, NFPA 70

8. For Ethernet models, plug the 90° Ethernet connector into the C7000's Ethernet port and secure the cable under the tab. Plug the other end of the Ethernet cable into an Ethernet port.

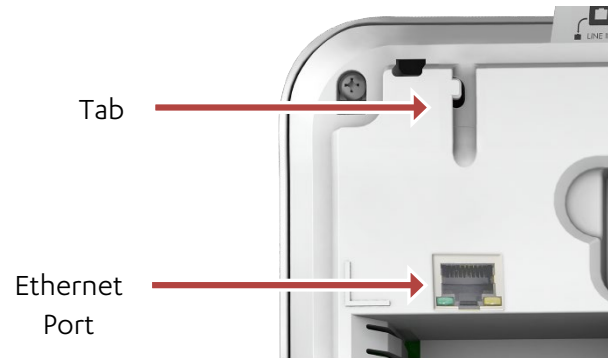

9. Replace the back cover.

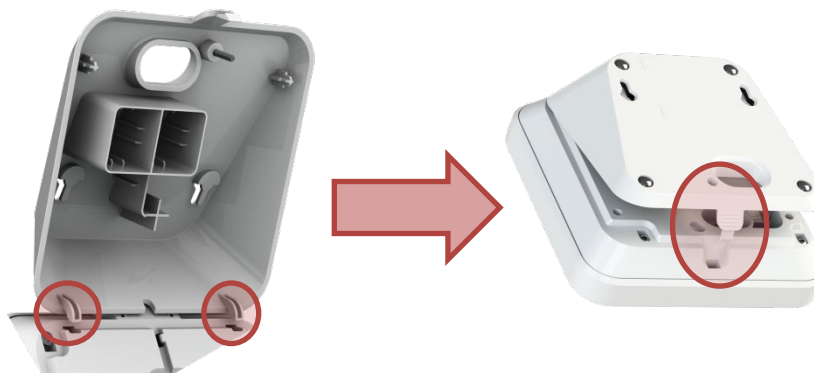

10. For the PSTN model, connect the C7000 to the landline.



- a. Connect the phone cable between the **LINE IN** socket and the home phone jack. The telephone cable used should be at least of 26 AWG.
  - b. Optionally, you can connect a telephone to the **TO PHONE** socket, using the cable included in the Care@Home™ PERS kit.
11. Turn on the power switch.



The **Power** LED lights green.



The **Communication** LED lights red.



## 2.4. Wall Mounting the C7000

The C7000 can be placed on a tabletop or mounted on a wall with screws.

To mount the C7000 on a wall:

1. Prepare the following equipment:
  - A drill with a standard bit
  - Two 3 X 35 DIN 7982 C screws and wall anchors:
  - A standard Philips screwdriver
2. Choose a flat, smooth, non-concrete wall.
3. Determine the height at which you want to mount the C7000. This is usually the eye level of the resident when seated.
4. At the desired height, drill two holes 7.5 cm (2.95 inches) away from each other horizontally. Ensure that they are level.
5. Screw the screws into the holes, leaving a space of a few millimeters between the wall and the screw heads.
6. Remove the back cover of the C7000.
7. Align the screw mount holes on the back cover of the C7000 over the screw heads.
8. Slide the back cover down gently until the screws lock in place.
9. Reattach the C7000 to the back cover.

## 2.5. Configuring C7000 Parameters

The C7000 is pre-configured to manage and control the C7000 and its associated peripherals. Use Care@Home™ CMS to adjust the configuration for the requirements of the resident and the resident's family. Refer to ESUG05074 Care@Home CMS Reference Manual. Some adjustments can be made to multiple C7000s using Care@Home™ CareView. Refer to ESUGSC181 CareView User Guide.



**NOTE:** To receive power fail notifications, the CMS Mains Failure C7000 parameter must be enabled.

---

## 3. Operating the C7000

The C7000 communicates with the peripherals to monitor a resident's activity, triggers emergency and safety alarms, and acts as a speakerphone, enabling emergency conversations and remote call-in.

### 3.1. Monitoring a Resident – Pro and Family

The Pro and Family solutions use the Care@Home™ app and Care@Home™ web application to monitor and analyze a resident's activities based on data collected by the peripherals. Refer to ESUG05050 Care@Home Caregiver User Guide.

### 3.2. Monitoring a Resident – PERS

The PERS solution enables the monitoring of residents using:

- Activity Timer
- Inactivity Timer

#### 3.2.1 Activity Timer

The activity timer monitors residents by asking them to press the **RESET** button during a specific time frame.

- When the activity timer is enabled, the **Activity** LED is a steady blue
- Fifteen minutes before the end of the session, the C7000 reminds the resident to press the **RESET** button, and the **Activity** LED blinks blue

If no activity is confirmed during the session, the C7000 announces that the activity timer has expired and an activity event is reported to the monitoring station.

The activity timer can be configured using Care@Home™ CMS. Refer to ESUG05074 Care@Home CMS Reference Manual.

#### 3.2.2 Inactivity Timer

The inactivity timer monitors a resident's activity using sensors. The resident is not notified.

The C7000 communicates with the monitoring station if no activity is detected.

The inactivity timer can be configured using Care@Home™ CMS. Refer to ESUG05074 Care@Home CMS Reference Manual.

### 3.3. Emergency Alarms

To trigger an emergency alarm, the resident presses the **EMERGENCY** button on the C7000 or uses one of the following peripherals.

Device	Description	Emergency Trigger
Emergency Pendant Advanced (ES700EPA)	Pendant with panic button and fall detection	Resident presses panic button
Emergency Pendant Advanced Jewelry (ES700EPAJ)		EPA detects fall
Emergency Pendant (ES700EP)	Panic button worn as pendant or on the wrist	Resident presses panic button
Emergency Pendant Plus (ES700EPP)		
Emergency Pendant Plus Jewelry (ES700EPPJ)		
Emergency Pendant Advanced - BC (ES700EPA – BC)		
Voice Panic Detector (ES700VPD)	Stationary panic button with active voice detection and optional pull cord	Resident presses panic button Resident pulls out cord Resident calls out the trigger phrase
Stationary Panic Detector (ES700SPD)	Stationary panic button with optional pull cord	Resident presses panic button Resident pulls out cord
MDsense (ES700MDS)	Multidimensional fall sensor	MDsense detects fall

In response to an emergency alarm, the C7000 communicates with the monitoring station.

### 3.4. Safety Alarms

The C7000 sounds an alarm when peripherals indicate an emergency. These include:

- Flood detector senses water
- Smoke detector detects smoke



**NOTE:** Flood and smoke detectors are not supported in the US and Canada.

### 3.5. Vocal Reminders

You can configure the C7000 to remind the resident of activities. The C7000 makes an announcement, and the **RESET** button flashes orange. Reminders include taking medication, appointments, and testing emergency pendants. Refer to ESUG05074 Care@Home CMS Reference Manual. Vocal reminders can be enabled or disabled for multiple C7000s using Care@Home CareView. Refer to ESUGSC181 CareView User Guide.

### 3.6. Speakerphone

The C7000 can be configured to function as a speakerphone for incoming calls.

When the C7000 rings, the resident can:

- Press the **EMERGENCY** button to initiate a full-duplex conversation
- End the call by pressing the **EMERGENCY** button again

C7000 only works as a speakerphone when connected to AC power. The monitoring station can disable the speakerphone.

### 3.7. Emergency Conversation Flow with the C7000

The C7000 supports the following types of conversation flow:

- Half-Duplex: only one party can speak at a time. In this mode, keypad control is supported. Refer to 3.6.1 Half-Duplex Conversation Flow on page 12.
- Full-Duplex: both parties can hear and speak at the same time. The call center operator can use telephone keypad numbers **1** or **3** (or as otherwise configured) to switch to half-duplex.





**NOTE:** To configure the keypad assignments, or the conversation mode parameter, refer to the ESUG05074 Care@Home CMS Reference Manual. Conversation mode can also be configured for multiple C7000s using Care@Home™ CareView, Refer to ESUGSC181 CareView User Guide.

---

#### 3.7.1 Half-Duplex Conversation Flow

When a resident presses the **EMERGENCY** button on their C7000, the C7000 connects to the call center. A call center operator responds, speaking first. The operator manages the half-duplex conversation flow, using the telephone keypad or monitoring center software.

The following table describes the half-duplex conversation flow triggered when the call center operator presses the telephone keypad. Default settings are shown.

Keypad Number	C7000 Response
1	Disables the C7000 microphone and enables the C7000 speaker. 
3	Enables the C7000 microphone and disables the C7000 speaker. 
2	Increases the speaker volume one level. There are five volume levels.
0	Lowers the speaker volume one level. There are five volume levels.
9	Disconnects call.

The following table shows the additional keypad codes which apply if Care@Home™ has a VPD with voice extender capability. Refer to ESUGSC018 Care@Home VPD User Guide.

Keypad Number	Action	C7000 Announcement
6	Transfers the call to the next device in the loop of VPD and C7000 devices.	<ul style="list-style-type: none"> <li>When talking to C7000: "Now talking to Control Panel"</li> <li>When using VPD and device location is known: "Now talking to &lt;location&gt;"</li> <li>When using VPD and device location is unknown: "Now talking to VPD &lt;device ID&gt;"</li> </ul>
5	Transfers a call that had previously been to a VPD to the C7000.	C7000 announces, "Now talking to Control Panel"

### 3.8. Making a Remote Call-In

Remote call-in enables the operator or the caregiver to call the resident’s home using the C7000. They can use remote call-in to verify a resident’s status when there is some concern about the resident. The C7000 answers remote call-ins automatically.

The emergency conversation flow is always half-duplex. Refer to 3.6.1 Half-Duplex Conversation Flow on page 12.

You can configure remote call-in in the CMS application. Refer to ESUG05074 Care@Home CMS Reference Manual. You can enable and disable remote call in for multiple C7000s using Care@Home CareView. Refer to ESUGSC181 CareView User Guide.

To make a remote call-in:

1. Call the resident’s C7000, using either the C7000 landline or cell phone number. The C7000 answers automatically after a configured number of rings.
2. Press ‘\*’ and enter the four-digit code.











**NOTE:** The default code is 1234. It is recommended to check if the code has been changed.

3. Manage the half-duplex conversation. Refer to 3.6.1 Half-Duplex Conversation Flow on page 12.

### 3.9. C7000 LEDs

The LEDs on the C7000 display operational information, as described in the following table.

LED	Display	Description
Power	 Green	<ul style="list-style-type: none"> <li>● Lit – AC power connected</li> <li>● Blinking – Battery operation</li> <li>● Off – No power</li> </ul>
Communication	 Green	<ul style="list-style-type: none"> <li>● Lit – Communication available</li> <li>● Blinking – Active transmission</li> </ul>
	 Red	<ul style="list-style-type: none"> <li>● Lit – Communications failure: <ul style="list-style-type: none"> <li>■ Cellular version: no SIM card, loss of cellular network, or GSM connectivity test failed</li> <li>■ PSTN version: PSTN line unavailable</li> <li>■ Cellular/Ethernet version: Both channels unavailable</li> <li>■ PSTN/Ethernet version: Both channels unavailable</li> </ul> </li> <li>● Blinking – Blocked transmission</li> </ul>

LED	Display	Description
	 Orange	<ul style="list-style-type: none"> <li>● Lit – Active conversation</li> </ul>
RESET	<b>RESET</b> Orange	<ul style="list-style-type: none"> <li>● Lit (for three seconds) – Button pressed</li> <li>● Flashing - Vocal reminder</li> </ul>
Trouble	 Red	<ul style="list-style-type: none"> <li>● Lit and C7000 beeps – C7000 or peripheral malfunction, or lost communications with the monitoring station</li> <li>● Blinking and C7000 beeps – Peripheral supervision lost or low battery power</li> </ul> <p><b>NOTE:</b> To stop the beeps, press <b>RESET</b></p>
Activity	 Blue ring	<ul style="list-style-type: none"> <li>● Lit – Activity timer is on</li> <li>● Off – Activity timer is off</li> <li>● Blinking – Activity timer expires in less than 15 minutes</li> </ul>
EMERGENCY CALL	 Red	<ul style="list-style-type: none"> <li>● Blinking – Alert in progress</li> <li>● Lit – Message acknowledged</li> </ul>
Combination of LEDs		<ul style="list-style-type: none"> <li>● Half-duplex call. C7000 microphone active, speaker inactive.                             <ul style="list-style-type: none"> <li>■ Communication - Lit orange</li> <li>■ RESET - Lit orange</li> <li>■ Trouble - Lit red</li> <li>■ Activity Timer - Lit blue</li> </ul> </li> </ul>

## 4. Restoring Factory Settings

Restoring the C7000 to factory settings:

- Removes all peripherals
- Resets all parameters to factory defaults



**Caution:** Consult with Essence Smart Care technical support before restoring factory settings.

To restore factory settings:

1. Press and hold the **RESET** button.



2. While holding the **RESET** button:
  - a. Insert a probe or the open end of a paperclip into the C7000's TEST pinhole.
  - b. Press the button inside the TEST pinhole and hold for five seconds.

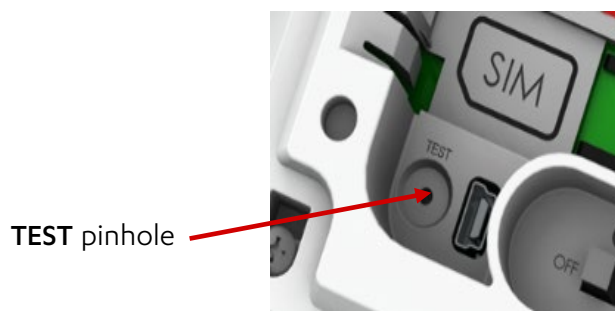

The C7000 LEDs flash and the C7000 beeps three times. The C7000 is restored to factory settings.



## 5. Removing All Peripherals

The monitoring station continues to receive updates about lost peripherals until they are removed from the C7000.



---

**NOTE:** This action removes all peripherals from the C7000. You need to pair all the peripherals with the C7000 again.

---

To remove all the peripherals from the C7000:

1. Press the **PAIRING** button, and hold for five seconds.
2. Press the **RESET** button, and hold for five seconds. A voice message from the C7000 instructs you to press the **PAIRING** button to remove all peripherals.
3. Press the **PAIRING** button. A voice message from the C7000 confirms that all devices were removed from the C7000.

## 6. Maintaining the C7000

C7000 maintenance includes:

- Software updates
- Communications maintenance
- Backup battery replacement
- Resetting the C7000

### 6.1. Software Updates

To perform software and firmware updates for the C7000 and its peripherals, use the remote boot function in Care@Home™ CMS. Refer to ESUG05074 Care@Home CMS Reference Manual. Updates for multiple C7000s can be performed using Care@Home CareView. Refer to ESUGSC181 CareView User Guide.

After a firmware update, reset the C7000. Refer to 6.4 Resetting the C7000 on page 19. Care@Home CareView can be used to restart multiple C7000s. Refer to ESUGSC181 CareView User Guide.

### 6.2. Communications Maintenance

If the C7000 uses cellular communications and the quality of the connection becomes unreliable, consult the cellular service provider to replace your SIM card or repair the connection.

After replacing the SIM card, reset the C7000. Refer to 6.4 Resetting the C7000 on page 19.

If the C7000 uses Ethernet communications and the quality of the Ethernet connection becomes unreliable, contact your network service provider.

If the C7000 uses landline (PSTN) communications and the quality of the landline becomes unreliable, consult the landline service provider.

### 6.3. Replacing the Backup Battery

The backup battery is charged automatically when installed in the C7000 and the C7000 is connected to AC power. The battery lasts for up to three years.

When the C7000 reports low battery for the C7000, replace the backup battery.



**Caution:** A new battery can cause damage if it is incorrectly installed. Be careful to replace the battery only with the same or equivalent type recommended by the manufacturer. Discard used batteries responsibly.

---

## 6.4. Resetting the C7000

Resetting prepares the C7000 for use after maintenance. For example, firmware updates.



**NOTE:** During a reset, the C7000 does not communicate with the server or peripherals.

---

To reset the C7000:

1. Turn the power switch **OFF**.
2. Remove the back cover.
3. Disconnect the power cable.
4. Remove the backup battery.
5. Wait 20 seconds.
6. Replace the backup battery.
7. Connect the power cable.
8. Replace the back cover.
9. Turn the power switch **ON**. The power LED lights green.

## 7. Specifications

The following table lists the C7000 technical specifications.

Item	Data
Part Number	ES7502HC
Weight	1.23 lb. (0.56 kg), including adapter and battery
Dimensions (H x W x D)	152 x 152 x 71 mm (6 x 6 x 2.8 in.)
Main Power	100-240 VAC, 50/60 Hz, 500 mA
Backup Battery	<p>Standard Battery:</p> <ul style="list-style-type: none"> <li>● One Li-Po, 3.7 V, 1400 mAh</li> <li>● Rechargeable with three-year battery life</li> <li>● Provides a minimum of 24 hours of continuous operation</li> </ul> <p>Optional Double Capacity Battery:</p> <ul style="list-style-type: none"> <li>● One Li-Po, 3.7 V, 2800 mAh</li> <li>● Rechargeable with three-year battery life</li> <li>● Provides a minimum of 48 hours of continuous operation</li> </ul>
Reporting Modes	<p>Cellular models:</p> <ul style="list-style-type: none"> <li>● SIA IP</li> <li>● DC – 09</li> <li>● SCAIP</li> <li>● BS8521:2009</li> </ul> <p>Ethernet models:</p> <ul style="list-style-type: none"> <li>● SIA IP</li> <li>● DC – 09</li> <li>● SCAIP</li> </ul> <p>PSTN models:</p> <ul style="list-style-type: none"> <li>● SIA</li> <li>● Contact ID</li> <li>● CPC</li> <li>● BS 8521:2009</li> </ul>
Frequency	<ul style="list-style-type: none"> <li>● FSK modulation: <ul style="list-style-type: none"> <li>■ 869.225 MHz (Europe)</li> <li>■ 868.3 MHz (China)</li> <li>■ 916.5 MHz (North America and Australia)</li> <li>■ 916.3 MHz (Israel)</li> </ul> </li> <li>● Bluetooth LE</li> </ul>

Communication Channels	<p>PSTN, cellular or Ethernet, dependent on model and software release</p> <p>Messages are normally sent and received using the primary communication channel. In the event of a communication failure, the C7000 automatically switches to the alternate communication channel.</p> <p>For cellular-PSTN models, cellular communication is used whenever the SIM is registered on a cellular network. PSTN is used only when the SIM is not registered on a cellular network.</p>
Color	White and gray
Peripheral Devices	Up to 30 peripheral devices
Operating temperature	0°C - 49°C (32°F - 120°F)
Compliance	<p>CE, FCC, IC</p> <p>ETL :</p> <ul style="list-style-type: none"> <li>● UL 1637</li> <li>● UL 1635</li> <li>● CSA 22.2 #205</li> </ul> <p>EN 60950-1                  EN 301 489-1 &amp; EN 301 489-3                  EN 300 220-1 &amp; EN 300 220-2; Receiver sensitivity: -108 dBm                  EN 50130-4                  EN 50130-5 Environmental Class I                  EN 50134-2, EN 50134-3, and 50134-5                  EN 50136-2:2013 Category C (D3,M3,T1,A1,S0,I0)                  Operation Mode-Pass-Through</p> <p>PSTN model: ANSI/TIA-968-B - Terminal equipment standard                  Cellular model: AT&amp;T and PTCRB compliance</p> <p>EN910-EUR – Compliant with Global Connection (GCF) requirements, as well as the Global System for mobile communications standard EN 301 511.</p>

This device complies with FCC Rules Part 15 and with Industry Canada’s license-exempt RSSs. Operation is subject to the following two conditions:

- (1) This device may not cause harmful interference
- (2) this device must accept any interference received including interference that may cause undesired operation.

For Industry Canada:

*Le présent appareil est conforme aux CNR d’Industrie Canada applicables aux appareils radio exempts de licence. L’exploitation est autorisée aux deux conditions suivantes :*

- (1) l’appareil ne doit pas produire de brouillage;*

*(2) L'utilisateur de l'appareil doit accepter tout brouillage radioélectrique subi, même si le brouillage est susceptible d'en compromettre le fonctionnement.*

NOTE: This equipment has been tested and found to comply with the limits for a Class B digital device, pursuant to Part 15 of the FCC Rules. These limits are designed to provide reasonable protection against harmful interference in a residential installation. This equipment generates, uses and can radiate radio frequency energy and, if not installed and used in accordance with the instructions, may cause harmful interference to radio communications. However, there is no guarantee that interference will not occur in a particular installation. If this equipment does cause harmful interference to radio or television reception, which can be determined by turning the equipment off and on, the user is encouraged to try to correct the interference by one or more of the following measures:

- Reorient or relocate the receiving antenna.
- Increase the separation between the equipment and receiver.
- Connect the equipment into an outlet on a circuit different from that to which the receiver is connected.
- Consult the dealer or an experienced radio/TV technician for help.

For Industry Canada:

- This Class B digital apparatus complies with Canadian ICES-003.
- Cet appareil numérique de la classe B est conforme à la norme NMB-003 du Canada.



**WARNING!** To comply with FCC RF exposure compliance requirements, the device should be located at a distance of at least 20 cm from all persons during normal operation. The antennas used for this product must not be co-located or operated in conjunction with any other antenna or transmitter.

---

Changes or modifications to this equipment not expressly approved by the party responsible for compliance (Essence Security International Ltd.) could void the user's authority to operate the equipment.

## Appendix A Testing Peripherals

The C7000 enables testing paired peripherals to ensure that all components work properly.

### Testing Activity Sensors

The C7000 responds with a voice message after each interaction with a peripheral. If the C7000 does not respond, make a note and continue testing.

To test the activity sensors:

1. Push a probe into the C7000's **TEST** pinhole, once or twice, until the C7000 responds "Installation test starts".

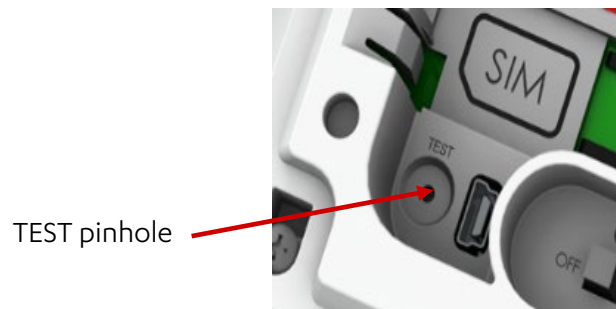

2. Test the MGLs:
  - a. Open and close the main door.
  - b. Open and close the refrigerator door.
3. Walk past each PIR.
4. Push a probe into the control panel's **TEST** pinhole until the C7000 responds, "Installation test ends".

### Testing Emergency Devices

Emergency devices are button-based devices, including:

- VPD
- SPB
- Pendants
  - EPA
  - EPP
  - EP

To test the emergency devices:

1. Press the C7000's **PAIRING** button twice. The C7000 responds, "Control panel entered test mode". The power, communication, and trouble LEDs flash.

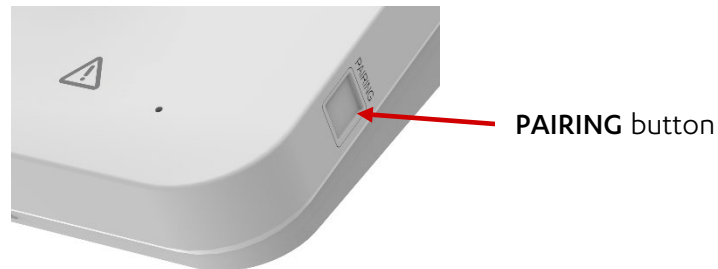

2. Press the pendant's button. The C7000 confirms with a voice message.
3. Test the VPD - Do one of the following:
  - Press the **EMERGENCY CALL** button.
  - Pull the emergency cord.
  - Shout the trigger phrase.

The C7000 confirms with a voice message.

4. Press the SPB's **SOS** button. The C7000 confirms with a voice message.
5. Test the SPD - Do one of the following:
  - Press the **EMERGENCY CALL** button.
  - Pull the emergency cord.

The C7000 confirms with a voice message.

6. Press the C7000's **RESET** button. The C7000 responds, "Control panel exited test mode".

## Troubleshooting

If the C7000 does not respond to a device being triggered:

1. Try moving the device and testing again.
2. Check CMS to ensure that the Trouble LED is not disabled:
  - a. Log on to CMS.
  - b. From the **Main** menu, click **Voice & LED**. The **Voice & LED** screen appears.



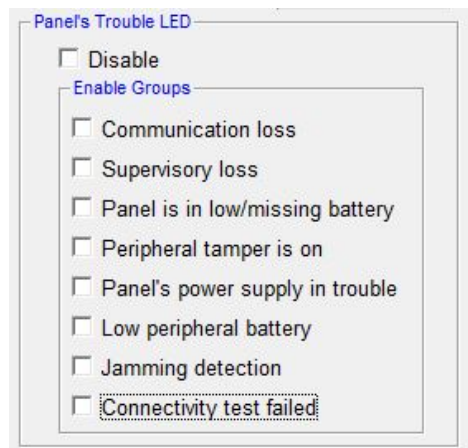

- c. Ensure that **Disable** is not selected.
- d. To disable the Trouble LED, while allowing emergency device testing, clear all choices.

## Testing the MDsense

To test the MDsense:

1. Press the control panel's **PAIRING** button twice. The control panel responds, "Control panel entered test mode". The control panel's power, communication, and trouble LEDs flash.

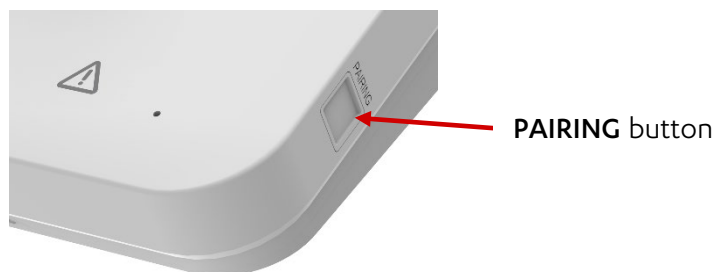

2. Remove the MDsense's socket cover, pull cord or power cord. The MDsense's LED lights. The control panel responds with a voice message.



3. Replace the socket cover, pull cord or power cable.

4. Remove the MDsense's battery compartment, by pressing the release buttons and pulling downward. The MDsense goes into test mode for 10 minutes.



5. Slide the battery compartment upward into the MDsense until it clicks. The LED flashes.



6. Walk in front of the MDsense. The LED flashes.
7. Lie on the floor. Remain still while the LED is solid red. Remain on the floor until the LED flashes slowly.
8. Press the control panel's **RESET** button. The control panel exits test mode.

## Legal Notice

*Usage of this document, and all information (including product information) provided within, are subject to the following terms and conditions, and all applicable laws. If you do not agree with these terms, please do not access or use the remainder of this document.*

*This document contains highly confidential information, which is proprietary to Essence SmartCare Ltd. and/or its affiliates (hereafter, "Essence"). No part of this document's contents may be used, copied, disclosed or conveyed to any third party in any manner whatsoever without prior written permission from Essence.*

*The information included in this document is intended for your knowledge and for negotiation purposes only. Essence makes no implicit representations or warranties with respect to such information.*

*The information included in this document is subject to change without notice. Any decision to rely on the information contained herein shall be at your sole responsibility, and Essence will not accept any liability for your decision to use any information or for any damages resulting therefrom.*

*Certain laws do not allow limitations on implied warranties or the exclusion or limitation of certain damages. If these laws apply to you, some or all of the above disclaimers, exclusions, or limitations may not apply to you.*

*By using the information contained herein, you agree that the laws of the State of Israel, without regard to principles of conflict of laws, will govern any dispute of any sort that might arise between you and Essence regarding the information contained herein, and any such dispute shall be settled exclusively in the competent courts of Tel Aviv-Jaffa, Israel.*

*All registered or unregistered trademarks, product names, logos and other service marks mentioned within this document are the property of Essence, or their respective owners. Nothing contained herein shall be construed as conferring by implication, estoppels, or otherwise any license or right, either express or implied, under any patent or trademark of Essence or any third party. No use of any trademark may be made without the prior written authorization of Essence.*

*This document and all of its contents are protected intellectual property of Essence. Any copying, reprinting, reuse, reproduction, adaptation, distribution or translation without the prior written permission of Essence is prohibited.*

*Please check your End User License Agreement (EULA) for terms and conditions.*

*© 2021 All rights reserved to Essence SmartCare Ltd.*

For more information, please contact:

Essence SmartCare Ltd.  
12 Abba Eban Avenue,  
Ackerstein Towers Bldg. D  
Herzliya Pituach, 4612001 Israel  
[www.essence-grp.com](http://www.essence-grp.com)  
Tel: +972-73-2447777  
Fax: +972-9-7729962