



CTC Laboratories, Inc.

1-2/F., Building 2, Jiaquan Building, Guanlan High-Tech Park, Shenzhen, Guangdong, China
Tel: +86-755- 27521059 Fax: +86-755- 27521011 Http://www.sz-ctc.org.cn

TEST REPORT

Report No......: **CTC20211289E04**

FCC ID.....: **2AR24-AIBOX30US**

Applicant: **Shenzhen Absen Optoelectronic Co.,Ltd**

Address.....: 18-20F Building 3A, Cloud Park, Bantian, Longgang District, Shenzhen, China

Manufacturer.....: Shenzhen Absen Optoelectronic Co.,Ltd

Address.....: 18-20F Building 3A, Cloud Park, Bantian, Longgang District, Shenzhen, China

Product Name: **LED Multimedia Processor**

Trade Mark: /

Model/Type reference.....: Ai Box3.0 US

Listed Model(s).....: /

Standard: **FCC Part 15, Subpart E 15. 407**

Date of receipt of test sample...: Aug. 02, 2021

Date of testing.....: Aug. 02, 2021 to Aug. 20, 2021

Date of issue.....: Aug. 25, 2021

Result.....: **PASS**

| | | |
|--------------------------|-------------|--------------------|
| Compiled by: | | |
| (Printed name+signature) | Lucy Lan | <i>Lucy Lan</i> |
| Supervised by: | | |
| (Printed name+signature) | Miller Ma | <i>Miller Ma</i> |
| Approved by: | | |
| (Printed name+signature) | Walter Chen | <i>Walter Chen</i> |

Testing Laboratory Name.....: **CTC Laboratories, Inc.**

Address: 1-2/F., Building 2, Jiaquan Building, Guanlan High-Tech Park, Shenzhen, Guangdong, China

This test report may be duplicated completely for legal use with the approval of the applicant. It should not be reproduced except in full, without the written approval of our laboratory. The client should not use it to claim product endorsement by CTC. The test results in the report only apply to the tested sample. The test report shall be invalid without all the signatures of testing engineers, reviewer and approver. Any objections must be raised to CTC within 15 days since the date when the report is received. It will not be taken into consideration beyond this limit. The test report merely correspond to the test sample.



Table of Contents

Page

| | |
|---|-----------|
| 1. TEST SUMMARY..... | 3 |
| 1.1. TEST STANDARDS..... | 3 |
| 1.2. REPORT VERSION | 3 |
| 1.3. TEST DESCRIPTION | 4 |
| 1.4. TEST FACILITY | 5 |
| 1.5. MEASUREMENT UNCERTAINTY | 5 |
| 1.6. ENVIRONMENTAL CONDITIONS..... | 6 |
| 2. GENERAL INFORMATION..... | 7 |
| 2.1. CLIENT INFORMATION | 7 |
| 2.2. GENERAL DESCRIPTION OF EUT | 7 |
| 2.3. ACCESSORY EQUIPMENT INFORMATION | 8 |
| 2.4. OPERATION STATE | 8 |
| 2.5. MEASUREMENT INSTRUMENTS LIST | 10 |
| 3. TEST ITEM AND RESULTS | 12 |
| 3.1. CONDUCTED EMISSION..... | 12 |
| 3.2. RADIATED EMISSION | 15 |
| 3.3. BAND EDGE EMISSIONS | 52 |
| 3.4. BANDWIDTH TEST | 77 |
| 3.5. OUTPUT POWER TEST | 79 |
| 3.6. POWER SPECTRAL DENSITY TEST | 81 |
| 3.7. FREQUENCY STABILITY MEASUREMENT | 83 |
| 3.8. ANTENNA REQUIREMENT..... | 84 |
| 3.9. DYNAMIC FREQUENCY SELECTION(DFS) | 85 |



1. TEST SUMMARY

1.1. Test Standards

The tests were performed according to following standards:

[FCC Part 15, Subpart E\(15.407\)](#) — for 802.11a/n/ac, the test procedure follows the FCC KDB 789033 D02 General UNII Test Procedures New Rules V02r01.

[RSS-247 Issue 2 February 2017](#) — Digital Transmission Systems (DTSS), Frequency Hopping Systems (FHSs) and Licence-Exempt Local Area Network (LE-LAN) Devices

[RSS-Gen](#) — General Requirements for Compliance of Radio Apparatus

1.2. Report Version

| Revised No. | Date of issue | Description |
|-------------|---------------|-------------|
| 01 | Aug. 25, 2021 | Original |
| | | |
| | | |
| | | |



1.3. Test Description

| FCC Part 15 Subpart E (15.407) / RSS-247 Issue 2 February 2017 | | | | |
|--|----------------------|---|--------|---------------|
| Test Item | Test require | | Result | Test Engineer |
| | FCC | IC | | |
| Antenna Requirement | 15.203 | / | Pass | Lucy Lan |
| Conducted Emission | 15.207 | RSS-Gen 8.8 | Pass | Lucy Lan |
| Band Edge Emissions | 15.407(b) | RSS-247 6.2.1.2 RSS-247 6.2.2.2 RSS-247 6.2.4.2 | Pass | Lucy Lan |
| 26dB Bandwidth & 99% Bandwidth | 15.407(a) (5) | RSS-247 6.2.1.2 | Pass | Lucy Lan |
| 6dB Bandwidth (only for UNII-3) | 15.407(e) | RSS-247 6.2.4.1 | Pass | Lucy Lan |
| Peak Output Power | 15.407(a) | RSS-247 6.2.1.1 RSS-247 6.2.4.1 | Pass | Lucy Lan |
| Power Spectral Density | 15.407(a) | RSS-247 6.2 | Pass | Lucy Lan |
| Transmitter Radiated Spurious Emission | 15.407(b) &15.209 | RSS-Gen 8.9 RSS-247 6.2.1.2 RSS-247 6.2.4.2 | Pass | Lucy Lan |
| Frequency Stability | 15.407(g) | / | Pass | Lucy Lan |
| Dynamic Frequency Selection (DFS) | 15.407(h) | RSS-247 6.3 | N/A | N/A |
| Automatically DiscontinueTransmission | 15.407(c) | / | Pass | Note(3) |

Note:

(1)“N/A” is not applicable.

(2)The measurement uncertainty is not included in the test result.

(3)During no any information transmission, the EUT can automatically discontinue transmission and become standby mode for power saving. the EUT can detect the controlling signal of ACK message transmitting from remote device and verify whether it shall resend or discontinue transmission.



1.4. Test Facility

CTC Laboratories, Inc.

Add: 1-2/F., Building 2, Jiaquan Building, Guanlan High-Tech Park, Shenzhen, Guangdong, China

Laboratory accreditation

The test facility is recognized, certified, or accredited by the following organizations:

CNAS-Lab Code: L5365

CTC Laboratories, Inc. has been assessed and proved to be in compliance with CNAS-CL01 Accreditation. Criteria for Testing and Calibration Laboratories (identical to ISO/IEC17025: 2017 General Requirements) for the Competence of Testing and Calibration Laboratories.

A2LA-Lab Cert. No.: 4340.01

CTC Laboratories, Inc. EMC Laboratory has been accredited by A2LA for technical competence in the field of electrical testing, and proved to be in compliance with ISO/IEC 17025: 2017 General Requirements for the Competence of Testing and Calibration Laboratories and any additional program requirements in the identified field of testing.

Industry Canada (Registration No.: 9783A, CAB Identifier: CN0029)

CTC Laboratories, Inc. EMC Laboratory has been registered by Certification and Engineer Bureau of Industry Canada for the performance of with Registration NO.: 9783A on Jan, 2016.

FCC (Registration No.: 951311, Designation Number CN1208)

CTC Laboratories, Inc. EMC Laboratory has been registered and fully described in a report filed with the (FCC) Federal Communications Commission. The acceptance letter from the FCC is maintained in our files. Registration 951311, Aug. 26, 2017.

1.5. Measurement Uncertainty

The data and results referenced in this document are true and accurate. The reader is cautioned that there may be errors within the calibration limits of the equipment and facilities. The measurement uncertainty was calculated for all measurements listed in this test report acc. to TR-100028-01 "Electromagnetic compatibility and Radio spectrum Matters (ERM); Uncertainties in the measurement of mobile radio equipment characteristics; Part 1" and TR-100028-02 "Electromagnetic compatibility and Radio spectrum Matters (ERM); Uncertainties in the measurement of mobile radio equipment characteristics; Part 2" and is documented in the CTC Laboratories, Inc. quality system acc. to DIN EN ISO/IEC 17025. Furthermore, component and process variability of devices similar to that tested may result in additional deviation. The manufacturer has the sole responsibility of continued compliance of the device.

Below is the best measurement capability for CTC Laboratories, Inc.



| Test Items | Measurement Uncertainty | Notes |
|---|-------------------------|-------|
| Transmitter power conducted | 0.42 dB | (1) |
| Transmitter power Radiated | 2.14 dB | (1) |
| Conducted spurious emissions 9kHz~40GHz | 1.60 dB | (1) |
| Radiated spurious emissions 9kHz~40GHz | 2.20 dB | (1) |
| Conducted Emissions 9kHz~30MHz | 3.08 dB | (1) |
| Radiated Emissions 30~1000MHz | 4.51 dB | (1) |
| Radiated Emissions 1~18GHz | 5.84 dB | (1) |
| Radiated Emissions 18~40GHz | 6.12 dB | (1) |
| Occupied Bandwidth | ----- | (1) |

Note (1): This uncertainty represents an expanded uncertainty expressed at approximately the 95% confidence level using a coverage factor of $k=1.96$.

1.6. Environmental Conditions

| | | |
|--------------------------|-------------------|--|
| Normal Condition | Temperature | 21°C~27°C |
| | Relative humidity | 40%~60% |
| | Voltage | The equipment shall be the nominal voltage for which the equipment was designed. |
| Extreme Condition | Temperature | Measurements shall be made over the extremes of the operating temperature range as declared by the manufacturer. |
| | Voltage | Measurements shall be made over the extremes of the operating temperature range as declared by the manufacturer. |

| | | |
|--------------------------|---------------------------|-----------|
| Normal Condition | T_N =Normal Temperature | 21°C~27°C |
| Extreme Condition | T_L =Lower Temperature | -10 °C |
| | T_H =Higher Temperature | 40 °C |



2. GENERAL INFORMATION

2.1. Client Information

| | |
|---------------|---|
| Applicant: | Shenzhen Absen Optoelectronic Co.,Ltd |
| Address: | 18-20F Building 3A, Cloud Park, Bantian, Longgang District, Shenzhen, China |
| Manufacturer: | Shenzhen Absen Optoelectronic Co.,Ltd |
| Address: | 18-20F Building 3A, Cloud Park, Bantian, Longgang District, Shenzhen, China |

2.2. General Description of EUT

| | |
|-----------------------|---|
| Product Name: | LED Multimedia Processor |
| Trade Mark: | / |
| Model/Type reference: | Ai Box3.0 US |
| Listed Model(s): | / |
| Model Difference: | / |
| Power supply: | 100-240V~ 50/60Hz 23W |
| RF Module Model: | ZK-7632A |
| Hardware version: | / |
| Software version: | / |
| Remark: | EUT is a fixed point-to-point access points operating device. According to the power limit for 5150~5250MHz band, ZK-7632A can operating in client mode. |

Technical index for 5G WIFI

| | | | | |
|----------------------------|---|---|---|---|
| Operation Band: | <input checked="" type="checkbox"/> U-NII-1 | <input type="checkbox"/> U-NII-2A | <input type="checkbox"/> U-NII-2C | <input checked="" type="checkbox"/> U-NII-3 |
| Operation Frequency Range: | U-NII-1: | 5150MHz~5250MHz | | |
| | U-NII-3: | 5725MHz~5850MHz | | |
| Support bandwidth: | 802.11a | <input checked="" type="checkbox"/> 20MHz | | |
| | 802.11n | <input checked="" type="checkbox"/> 20MHz | <input checked="" type="checkbox"/> 40MHz | |
| Modulation: | 802.11a: OFDM (BIT/SK, QPSK, BPSK, 16QAM) 802.11n: OFDM (BIT/SK, QPSK, BPSK, 16QAM, 64QAM) | | | |
| Bit Rate of Transmitter: | 802.11a: 6/9/12/18/24/36/48/54 Mbps 802.11n: up to 300Mbps | | | |
| Antenna 1 or 2 type: | PCB Antenna | | | |
| Antenna 1 or 2 gain: | 5dBi | | | |



2.3. Accessory Equipment Information

| Equipment Information | | | |
|---------------------------|------------------|--------------|--------------|
| Name | Model | S/N | Manufacturer |
| Notebook | X220 | / | Lenovo |
| Cable Information | | | |
| Name | Shielded Type | Ferrite Core | Length |
| USB Cable | Unshielded | NO | 150cm |
| AC Cable | Unshielded | NO | 120cm |
| Test Software Information | | | |
| Name | Software version | / | / |
| QA Tool | 0.0.1.88 | / | / |

2.4. Operation State

Operation Frequency List:

| Band (MHz) | 20MHz Bandwidth | | 40MHz Bandwidth | |
|------------|-----------------|-----------------|-----------------|-----------------|
| | Channel | Frequency (MHz) | Channel | Frequency (MHz) |
| U-NII-1 | 36 | 5180 | 38 | 5190 |
| | 40 | 5200 | | |
| | 44 | 5220 | 46 | 5230 |
| | 48 | 5240 | | |
| U-NII-3 | 149 | 5745 | 151 | 5755 |
| | 153 | 5765 | | |
| | 157 | 5785 | 159 | 5795 |
| | 161 | 5805 | | |
| | 165 | 5825 | | |

Test channel is below:

| Operating Band | Test Channel | 20MHz | | 40MHz | |
|----------------|-----------------|---------|-----------------|---------|-----------------|
| | | Channel | Frequency (MHz) | Channel | Frequency (MHz) |
| U-NII-1 | CH _L | 36 | 5180 | 38 | 5190 |
| | CH _M | 40 | 5200 | / | / |
| | CH _H | 48 | 5240 | 46 | 5230 |
| U-NII-3 | CH _L | 149 | 5745 | 151 | 5755 |
| | CH _M | 157 | 5785 | / | / |
| | CH _H | 165 | 5825 | 159 | 5795 |



Data Rated

Preliminary tests were performed in different data rate, and found which the below bit rate is worst case mode, so only show data which it is a worst case mode.

| Mode | Data rate (worst mode) |
|------------------------------|------------------------|
| 802.11a | 6Mbps |
| 802.11n(HT20)/ 802.11n(HT40) | HT-MCS0 |

Test mode

| |
|--|
| For RF test items |
| The engineering test program was provided and enabled to make EUT continuous transmit. |
| For AC power line conducted emissions: |
| The EUT was set to connect with the WLAN AP under large package sizes transmission. |
| For Radiated spurious emissions test item: |
| The engineering test program was provided and enabled to make EUT continuous transmit. The EUT in each of three orthogonal axis emissions had been tested, but only the worst case (X axis) data Recorded in the report. |



2.5. Measurement Instruments List

| Tonscend JS0806-2 Test system | | | | | |
|-------------------------------|-------------------------------------|-----------------|-----------|------------|------------------|
| Item | Test Equipment | Manufacturer | Model No. | Serial No. | Calibrated until |
| 1 | Spectrum Analyzer | Rohde & Schwarz | FSU26 | 100105 | Dec. 25, 2021 |
| 2 | Spectrum Analyzer | Rohde & Schwarz | FSV40-N | 101331 | Mar. 15, 2022 |
| 3 | Spectrum Analyzer | KEYSIGHT | N9020A | 100231 | Dec. 25, 2021 |
| 4 | MXG Vector Signal Generator | Agilent | N5182A | MY47420864 | Dec. 25, 2021 |
| 5 | Signal Generator | Agilent | E8257D | MY46521908 | Dec. 25, 2021 |
| 6 | Power Sensor | Agilent | U2021XA | MY5365004 | Dec. 25, 2021 |
| 7 | Power Sensor | Agilent | U2021XA | MY5365006 | Dec. 25, 2021 |
| 8 | Simultaneous Sampling DAQ | Agilent | U2531A | TW54493510 | Dec. 25, 2021 |
| 9 | Climate Chamber | TABAI | PR-4G | A8708055 | Dec. 25, 2021 |
| 10 | Wideband Radio Communication Tester | Rohde & Schwarz | CMW500 | 116410 | Dec. 25, 2021 |
| 11 | Climate Chamber | ESPEC | MT3065 | / | Dec. 25, 2021 |
| 12 | 300328 v2.2.2 test system | TONSCEND | v2.6 | / | / |

| Radiated Emission and Transmitter spurious emissions | | | | | |
|--|-------------------------|-----------------|--------------|------------|------------------|
| Item | Test Equipment | Manufacturer | Model No. | Serial No. | Calibrated until |
| 1 | EMI Test Receiver | Rohde & Schwarz | ESCI | 100658 | Dec. 25, 2021 |
| 2 | High pass filter | micro-tranics | HPM50111 | 142 | Dec. 25, 2021 |
| 3 | Log-Bicon Antenna | Schwarzbeck | CBL6141A | 4180 | Dec. 25, 2021 |
| 4 | Ultra-Broadband Antenna | ShwarzBeck | BBHA9170 | 25841 | Dec. 25, 2021 |
| 5 | Loop Antenna | LAPLAC | RF300 | 9138 | Dec. 25, 2021 |
| 6 | Spectrum Analyzer | Rohde & Schwarz | FSU26 | 100105 | Dec. 25, 2021 |
| 7 | Horn Antenna | Schwarzbeck | BBHA 9120D | 647 | Dec. 25, 2021 |
| 8 | Pre-Amplifier | HP | 8447D | 1937A03050 | Dec. 25, 2021 |
| 9 | Pre-Amplifier | EMCI | EMC051835 | 980075 | Dec. 25, 2021 |
| 10 | Antenna Mast | UC | UC3000 | N/A | N/A |
| 11 | Turn Table | UC | UC3000 | N/A | N/A |
| 12 | Cable Below 1GHz | Schwarzbeck | AK9515E | 33155 | Dec. 25, 2021 |
| 13 | Cable Above 1GHz | Hubersuhner | SUCOFLEX 102 | DA1580 | Dec. 25, 2021 |
| 14 | Splitter | Mini-Circuit | ZAPD-4 | 400059 | Dec. 25, 2021 |
| 15 | RF Connection Cable | HUBER+SUHNER | RE-7-FL | N/A | Dec. 25, 2021 |

CTC Laboratories, Inc.

1-2/F., Building 2, Jiaquan Building, Guanlan High-Tech Park, Shenzhen, Guangdong, China

Tel.: (86)755-27521059

Fax: (86)755-27521011

Http://www.sz-ctc.org.cn



For anti-fake verification, please visit the official website of Certification and Accreditation Administration of the People's Republic of China : yz.cnca.cn



| | | | | | |
|----|------------------------------|------------------------------|--------------------|----------|---------------|
| 16 | RF Connection Cable | Chengdu E-Microwave | --- | --- | Dec. 25, 2021 |
| 17 | High pass filter | Compliance Direction systems | BSU-6 | 34202 | Dec. 25, 2021 |
| 18 | Attenuator | Chengdu E-Microwave | EMCAXX-10 RNZ-3 | --- | Dec. 25, 2021 |
| 19 | High and low temperature box | ESPEC | MT3065 | 12114019 | Dec. 25, 2021 |

| Conducted Emission | | | | | |
|--------------------|-------------------|--------------|-----------|------------|------------------|
| Item | Test Equipment | Manufacturer | Model No. | Serial No. | Calibrated until |
| 1 | LISN | R&S | ENV216 | 101112 | Dec. 25, 2021 |
| 2 | LISN | R&S | ENV216 | 101113 | Dec. 25, 2021 |
| 3 | EMI Test Receiver | R&S | ESCI | 100658 | Dec. 25, 2021 |

Note: 1. The Cal. Interval was one year.

2. The cable loss has calculated in test result which connection between each test instruments.

3. TEST ITEM AND RESULTS

3.1. Conducted Emission

Limit

FCC CFR Title 47 Part 15 Subpart C Section 15.207/ RSS – Gen 8.8:

| Frequency range (MHz) | Limit (dBuV) | |
|-----------------------|--------------|-----------|
| | Quasi-peak | Average |
| 0.15-0.5 | 66 to 56* | 56 to 46* |
| 0.5-5 | 56 | 46 |
| 5-30 | 60 | 50 |

* Decreases with the logarithm of the frequency.

Test Configuration

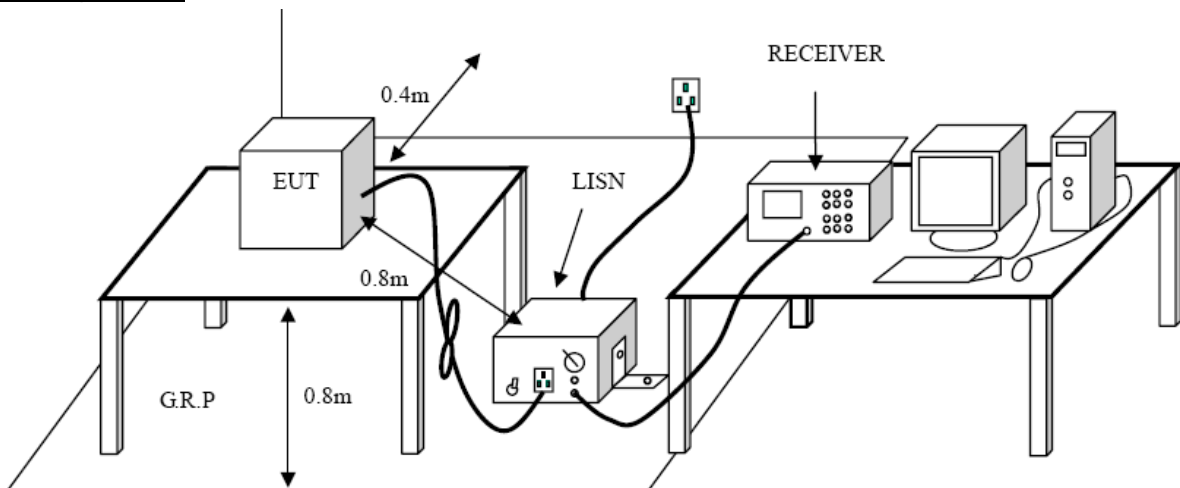

Test Procedure

1. The EUT was setup according to ANSI C63.10:2013 requirements.
2. The EUT was placed on a platform of nominal size, 1 m by 1.5 m, raised 80 cm above the conducting ground plane. The vertical conducting plane was located 40 cm to the rear of the EUT. All other surfaces of EUT were at least 80 cm from any other grounded conducting surface.
3. The EUT and simulators are connected to the main power through a line impedances stabilization network (LISN). The LISN provides a 50 ohm /50uH coupling impedance for the measuring equipment.
The peripheral devices are also connected to the main power through a LISN. (Please refer to the block diagram of the test setup and photographs)
4. Each current-carrying conductor of the EUT power cord, except the ground (safety) conductor, was individually connected through a LISN to the input power source.
5. The excess length of the power cord between the EUT and the LISN receptacle were folded back and forth at the center of the lead to form a bundle not exceeding 40 cm in length.
6. Conducted Emissions were investigated over the frequency range from 0.15MHz to 30MHz using a receiver bandwidth of 9 kHz.
7. During the above scans, the emissions were maximized by cable manipulation.

Test Mode

Please refer to the clause 2.4.



Test Results

| | |
|----------------------|---------------|
| Test Voltage: | AC 120V/60 Hz |
| Terminal: | Line |

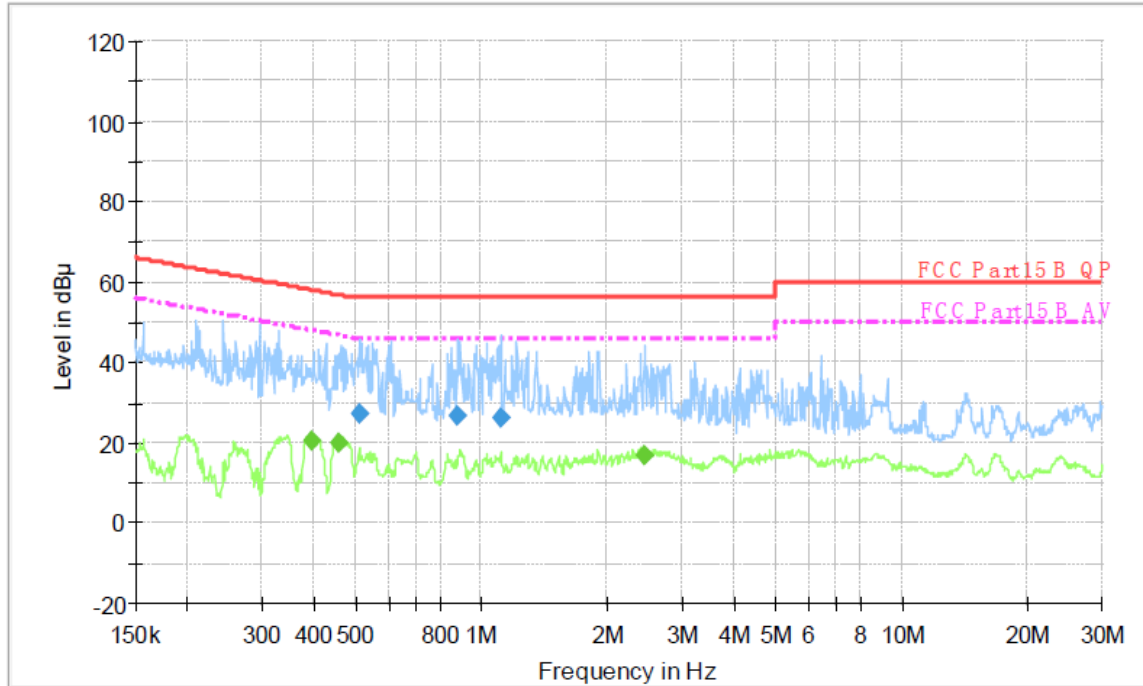

Final Measurement Detector 1

| Frequency (MHz) | QuasiPeak (dBu V) | Meas. Time (ms) | Bandwidth (kHz) | Filter | Line | Corr. (dB) | Margin (dB) | Limit (dBu V) | Comment |
|-----------------|-------------------|-----------------|-----------------|--------|------|------------|-------------|---------------|---------|
| 0.510910 | 27.1 | 1000.00 | 9.000 | On | L1 | 9.7 | 28.9 | 56.0 | |
| 0.875780 | 26.5 | 1000.00 | 9.000 | On | L1 | 9.7 | 29.5 | 56.0 | |
| 1.108360 | 25.9 | 1000.00 | 9.000 | On | L1 | 9.7 | 30.1 | 56.0 | |

Final Measurement Detector 2

| Frequency (MHz) | Average (dBu V) | Meas. Time (ms) | Bandwidth (kHz) | Filter | Line | Corr. (dB) | Margin (dB) | Limit (dBu V) | Comment |
|-----------------|-----------------|-----------------|-----------------|--------|------|------------|-------------|---------------|---------|
| 0.394140 | 20.4 | 1000.00 | 9.000 | On | L1 | 9.7 | 27.6 | 48.0 | |
| 0.460540 | 19.9 | 1000.00 | 9.000 | On | L1 | 9.7 | 26.8 | 46.7 | |
| 2.433450 | 17.0 | 1000.00 | 9.000 | On | L1 | 9.7 | 29.0 | 46.0 | |

Emission Level= Read Level+ Correct Factor



| | |
|----------------------|---------------|
| Test Voltage: | AC 120V/60 Hz |
| Terminal: | Neutral |

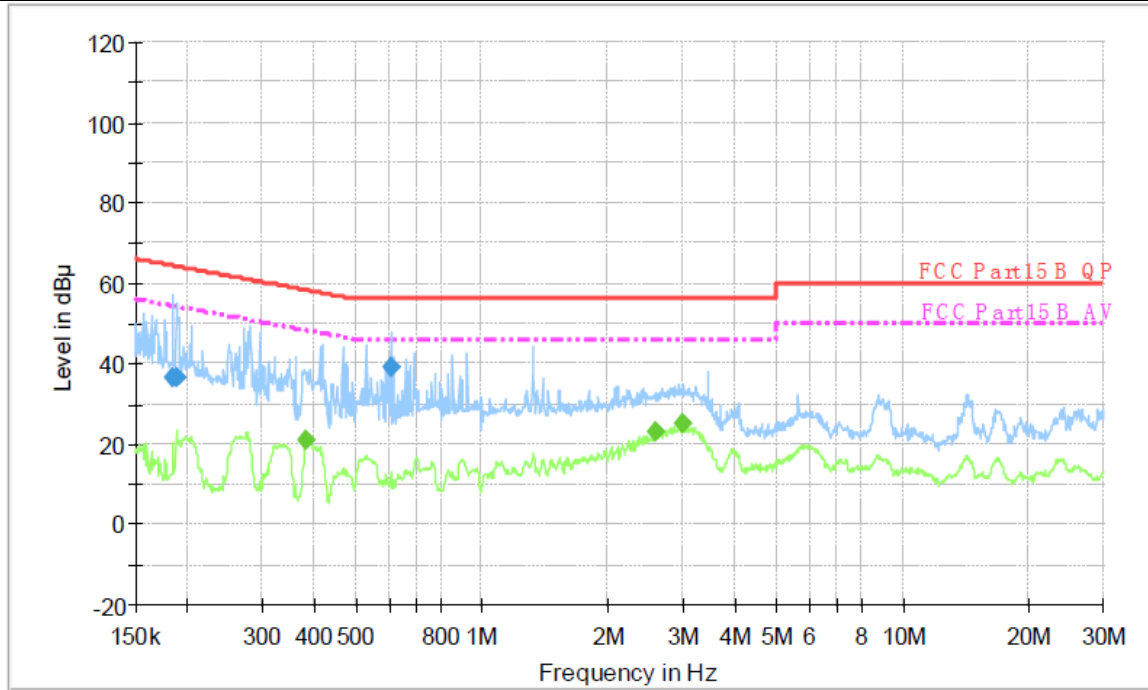

Final Measurement Detector 1

| Frequency (MHz) | QuasiPeak (dBu V) | Meas. Time (ms) | Bandwidth (kHz) | Filter | Line | Corr. (dB) | Margin (dB) | Limit (dBu V) | Comment |
|-----------------|-------------------|-----------------|-----------------|--------|------|------------|-------------|---------------|---------|
| 0.183870 | 36.8 | 1000.00 | 9.000 | On | N | 10.0 | 27.5 | 64.3 | |
| 0.187580 | 36.4 | 1000.00 | 9.000 | On | N | 10.0 | 27.7 | 64.1 | |
| 0.606580 | 39.2 | 1000.00 | 9.000 | On | N | 10.0 | 16.8 | 56.0 | |

Final Measurement Detector 2

| Frequency (MHz) | Average (dBu V) | Meas. Time (ms) | Bandwidth (kHz) | Filter | Line | Corr. (dB) | Margin (dB) | Limit (dBu V) | Comment |
|-----------------|-----------------|-----------------|-----------------|--------|------|------------|-------------|---------------|---------|
| 0.381750 | 21.0 | 1000.00 | 9.000 | On | N | 10.0 | 27.2 | 48.2 | |
| 2.593960 | 22.9 | 1000.00 | 9.000 | On | N | 10.0 | 23.1 | 46.0 | |
| 3.018860 | 25.0 | 1000.00 | 9.000 | On | N | 10.0 | 21.0 | 46.0 | |

Emission Level= Read Level+ Correct Factor



3.2. Radiated Emission

Limit

FCC CFR Title 47 Part 15 Subpart C Section 15.209/ RSS-Gen 8.9

| Frequency (MHz) | Field Strength (microvolts/meter) | Measurement Distance (meters) |
|-----------------|-----------------------------------|-------------------------------|
| 0.009~0.490 | 2400/F(KHz) | 300 |
| 0.490~1.705 | 24000/F(KHz) | 30 |
| 1.705~30.0 | 30 | 30 |
| 30~88 | 100 | 3 |
| 88~216 | 150 | 3 |
| 216~960 | 200 | 3 |
| 960~1000 | 500 | 3 |

| Frequency (MHz) | dB(uV/m) (at 3 meters) | |
|-----------------|------------------------|---------|
| | Peak | Average |
| Above 1000 | 74 | 54 |

Note:

- (1) The tighter limit applies at the band edges.
- (2) Emission Level (dBuV/m)= 20log Emission Level (uV/m).

Limits of unwanted emission out of the restricted bands

FCC CFR Title 47 Part 15 Subpart C Section 15.407(b)/ RSS-247 6.2.1.2 & RSS-247 6.2.4.2

| Frequency (MHz) | EIRP Limits (dBm) | Equivalent Field Strength at 3m (dBuV/m) |
|-----------------|-------------------|--|
| 5150~5250 | -27 | 68.2 |
| 5250~5350 | -27 | 68.2 |
| 5470~5725 | -27 | 68.2 |
| 5725~5825 | -27(Note 2) | 68.2 |
| | 10(Note 2) | 105.2 |
| | 15.6(Note 2) | 110.8 |
| | 27(Note 2) | 122.2 |

Note: 1. The following formula is used to convert the equipment isotropic radiated power (eirp) to field strength: $E = \frac{1000000\sqrt{30P}}{3}$ uV/m, where P is the eirp (Watts)

2. According to FCC 16-24, All emissions shall be limited to a level of -27 dBm/MHz at 75 MHz or more above or below the band edge increasing linearly to 10 dBm/MHz at 25 MHz above or below the band edge, and from 25MHz above or below the band edge increasing linearly to a level of 15.6 dBm/MHz at 5 MHz above or below the band edge, and from 5 MHz above or below the band edge increasing linearly to a level of 27dBm/MHz at the band edge.

Test Configuration

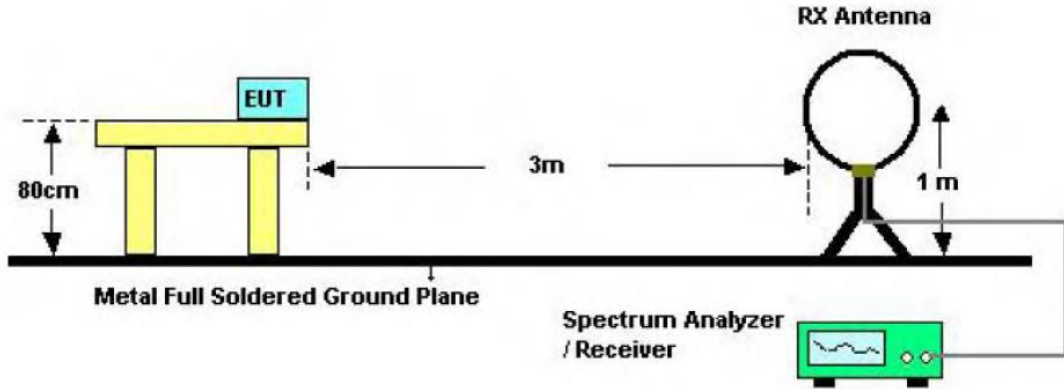

Below 30MHz Test Setup

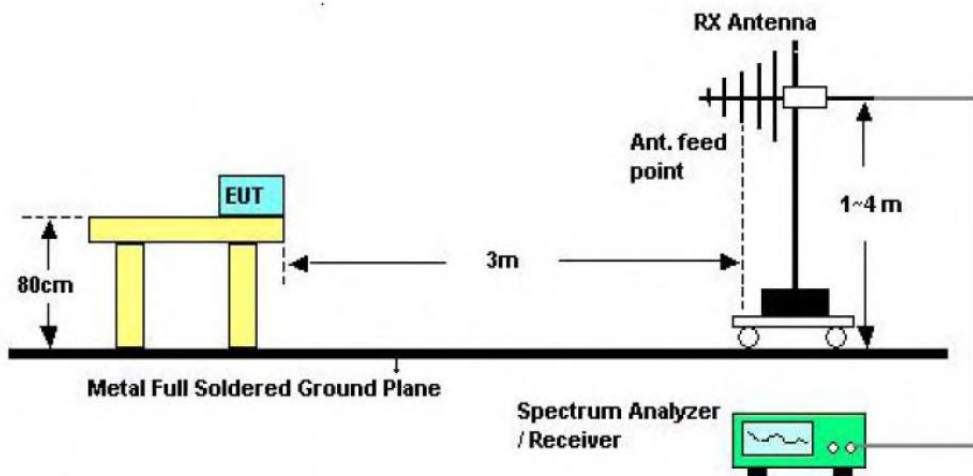

Below 1000MHz Test Setup

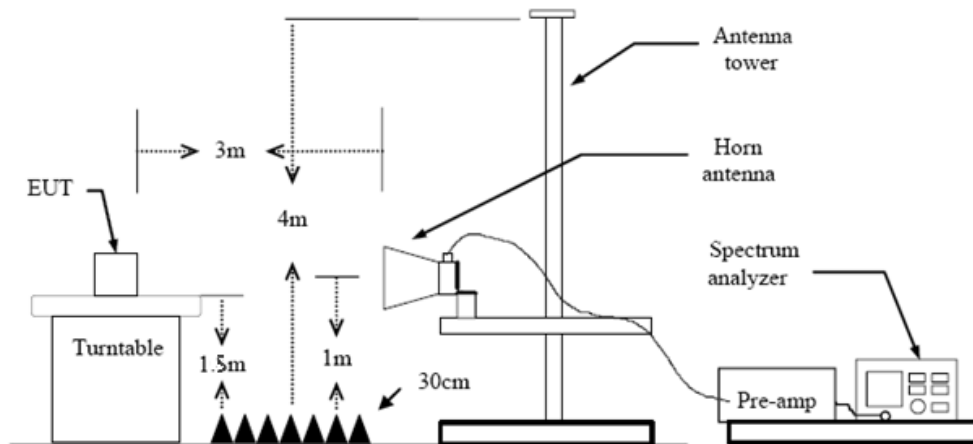

Above 1GHz Test Setup

Test Procedure

1. The EUT was setup and tested according to ANSI C63.10:2013
2. The EUT is placed on a turn table which is 0.8 meter above ground for below 1 GHz, and 1.5 m for above 1 GHz. The turn table is rotated 360 degrees to determine the position of the maximum emission level.



3. The EUT was set 3 meters from the receiving antenna, which was mounted on the top of a variable height antenna tower.
4. For each suspected emission, the EUT was arranged to its worst case and then tune the Antenna tower (from 1 m to 4 m) and turntable (from 0 degree to 360 degrees) to find the maximum reading. A pre-amp and a high pass filter are used for the test in order to get better signal level to comply with the guidelines.
5. Set to the maximum power setting and enable the EUT transmit continuously.
6. Use the following spectrum analyzer settings
 - (1) Span shall wide enough to fully capture the emission being measured;
 - (2) Below 1 GHz:
RBW=120 kHz, VBW=300 kHz, Sweep=auto, Detector function=peak, Trace=max hold;
If the emission level of the EUT measured by the peak detector is 3 dB lower than the applicable limit, the peak emission level will be reported. Otherwise, the emission measurement will be repeated using the quasi-peak detector and reported.
 - (3) From 1 GHz to 10th harmonic:
RBW=1MHz, VBW=3MHz Peak detector for Peak value.
RBW=1MHz, VBW \geq 1/T Peak detector for Average value.
Note 1: For the 1/T& Duty Cycle please refer to clause Duty Cycle.

Test Mode

Please refer to the clause 2.4.

Test Result

9 KHz~30 MHz

From 9 KHz to 30 MHz: Conclusion: PASS

Note: The amplitude of spurious emissions which are attenuated by more than 20dB below the permissible value has no need to be reported.

Pre-scan all antenna, only show the test data for worse case antenna on the test report.



30MHz-1GHz

| | |
|------------|--------------------------------|
| Ant No.: | Ant 1 |
| Ant. Pol. | Horizontal |
| Test Mode: | 802.11a Mode 5180MHz (U-NII-1) |
| Remark: | Only worse case is reported |

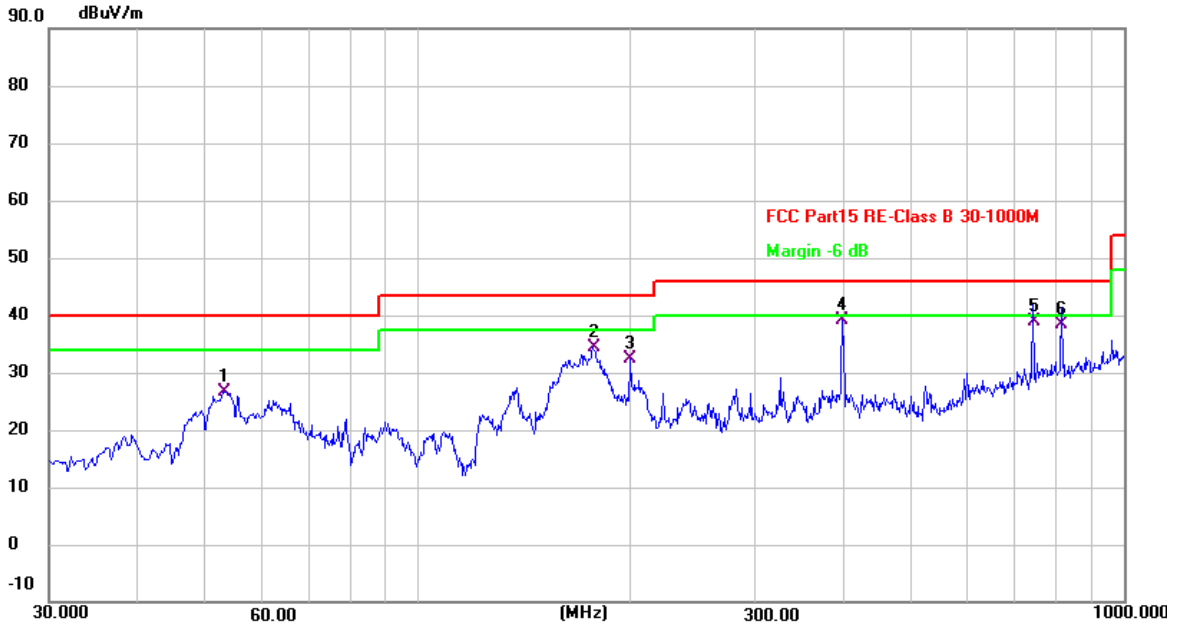

| No. | Frequency (MHz) | Reading (dBuV) | Factor (dB/m) | Level (dBuV/m) | Limit (dBuV/m) | Margin (dB) | Detector |
|-----|-----------------|----------------|---------------|----------------|----------------|-------------|----------|
| 1 | 53.2800 | 41.55 | -14.90 | 26.65 | 40.00 | -13.35 | QP |
| 2 | 177.1167 | 50.17 | -15.79 | 34.38 | 43.50 | -9.12 | QP |
| 3 | 200.0733 | 50.23 | -17.89 | 32.34 | 43.50 | -11.16 | QP |
| 4 * | 399.8933 | 50.87 | -11.85 | 39.02 | 46.00 | -6.98 | QP |
| 5 | 742.6267 | 42.73 | -3.93 | 38.80 | 46.00 | -7.20 | QP |
| 6 | 816.6700 | 40.94 | -2.64 | 38.30 | 46.00 | -7.70 | QP |

Remarks:

- 1. Factor (dB/m) = Antenna Factor (dB/m)+Cable Factor (dB)-Pre-amplifier Factor
- 2. Margin value = Level -Limit value



| | |
|-------------------|--------------------------------|
| Ant No.: | Ant 1 |
| Ant. Pol. | Vertical |
| Test Mode: | 802.11a Mode 5180MHz (U-NII-1) |
| Remark: | Only worse case is reported |

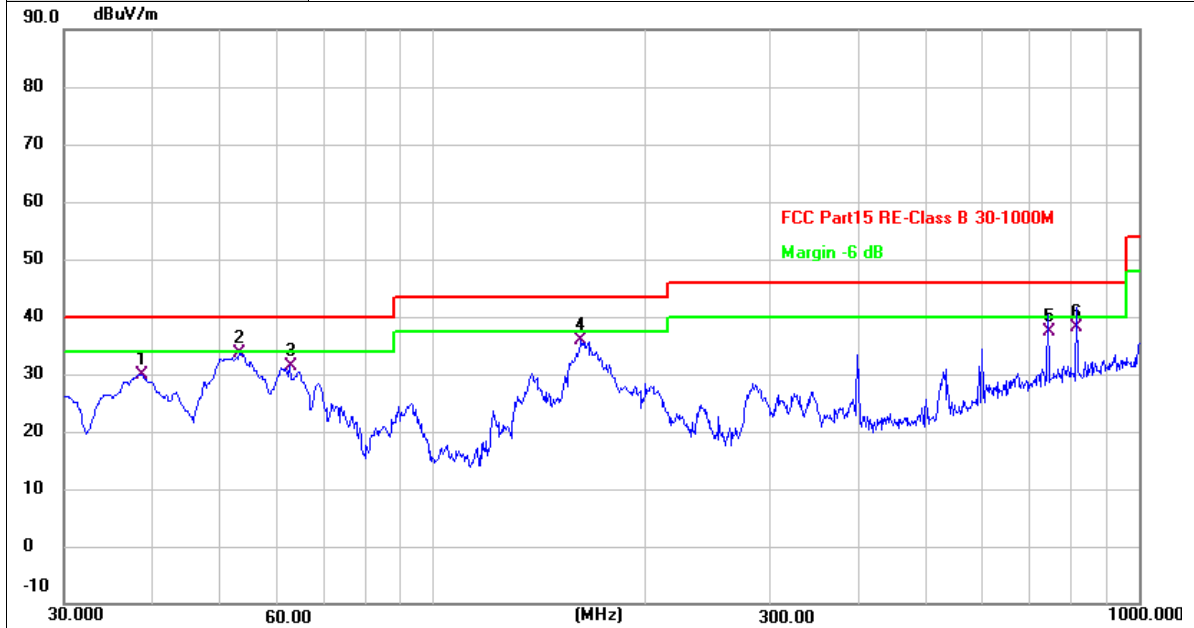

| No. | Frequency (MHz) | Reading (dBuV) | Factor (dB/m) | Level (dBuV/m) | Limit (dBuV/m) | Margin (dB) | Detector |
|-----|-----------------|----------------|---------------|----------------|----------------|-------------|----------|
| 1 | 38.7300 | 44.42 | -14.52 | 29.90 | 40.00 | -10.10 | QP |
| 2 * | 53.2800 | 48.44 | -14.90 | 33.54 | 40.00 | -6.46 | QP |
| 3 | 62.6567 | 47.08 | -15.74 | 31.34 | 40.00 | -8.66 | QP |
| 4 | 162.2433 | 50.54 | -14.58 | 35.96 | 43.50 | -7.54 | QP |
| 5 | 742.6267 | 41.33 | -3.93 | 37.40 | 46.00 | -8.60 | QP |
| 6 | 816.6700 | 40.84 | -2.64 | 38.20 | 46.00 | -7.80 | QP |

Remarks:

- 1. Factor (dB/m) = Antenna Factor (dB/m)+Cable Factor (dB)-Pre-amplifier Factor
- 2. Margin value = Level -Limit value





Above 1GHz

| Ant No.: | Ant 1 | | | | | | | | | | | | | | | | | | | | | | | | | | | | | | |
|---|--|----------------|---------------|----------------|----------------|-------------|----------|-----|-----------------|----------------|---------------|----------------|----------------|-------------|----------|---|-----------|-------|-------|-------|-------|--------|------|-----|-----------|-------|-------|-------|-------|--------|-----|
| Ant. Pol.: | Horizontal | | | | | | | | | | | | | | | | | | | | | | | | | | | | | | |
| Test Mode: | TX 802.11a Mode 5180MHz (U-NII-1) | | | | | | | | | | | | | | | | | | | | | | | | | | | | | | |
| Remark: | No report for the emission which more than 20 dB below the prescribed limit. | | | | | | | | | | | | | | | | | | | | | | | | | | | | | | |
| <table border="1"> <thead> <tr> <th>No.</th> <th>Frequency (MHz)</th> <th>Reading (dBuV)</th> <th>Factor (dB/m)</th> <th>Level (dBuV/m)</th> <th>Limit (dBuV/m)</th> <th>Margin (dB)</th> <th>Detector</th> </tr> </thead> <tbody> <tr> <td>1</td> <td>10359.540</td> <td>40.50</td> <td>14.96</td> <td>55.46</td> <td>74.00</td> <td>-18.54</td> <td>peak</td> </tr> <tr> <td>2 *</td> <td>10361.780</td> <td>28.52</td> <td>14.96</td> <td>43.48</td> <td>54.00</td> <td>-10.52</td> <td>AVG</td> </tr> </tbody> </table> | | | | | | | | No. | Frequency (MHz) | Reading (dBuV) | Factor (dB/m) | Level (dBuV/m) | Limit (dBuV/m) | Margin (dB) | Detector | 1 | 10359.540 | 40.50 | 14.96 | 55.46 | 74.00 | -18.54 | peak | 2 * | 10361.780 | 28.52 | 14.96 | 43.48 | 54.00 | -10.52 | AVG |
| No. | Frequency (MHz) | Reading (dBuV) | Factor (dB/m) | Level (dBuV/m) | Limit (dBuV/m) | Margin (dB) | Detector | | | | | | | | | | | | | | | | | | | | | | | | |
| 1 | 10359.540 | 40.50 | 14.96 | 55.46 | 74.00 | -18.54 | peak | | | | | | | | | | | | | | | | | | | | | | | | |
| 2 * | 10361.780 | 28.52 | 14.96 | 43.48 | 54.00 | -10.52 | AVG | | | | | | | | | | | | | | | | | | | | | | | | |
| <p>Note: The chart shows Limits 74dBuV for Peak, 54dBuV for AVG, but Unwanted Emissions that fall Outside of the Restricted Bands is 68.2dBuV for Peak. No limit for AVG. All test results are in t compliance with the limits. After calculation, the Peak measurement value meets the limit requirements.</p> | | | | | | | | | | | | | | | | | | | | | | | | | | | | | | | |
| <p>Remarks: 1.Factor (dB/m) = Antenna Factor (dB/m)+Cable Factor (dB)-Pre-amplifier Factor 2.Margin value = Level -Limit value</p> | | | | | | | | | | | | | | | | | | | | | | | | | | | | | | | |



| Ant No.: | Ant 1 | | | | | | | | | | | | | | | | | | | | | | | | | | | | | | |
|---|--|----------------|---------------|----------------|----------------|-------------|----------|-----|-----------------|----------------|---------------|----------------|----------------|-------------|----------|-----|-----------|-------|-------|-------|-------|--------|-----|---|-----------|-------|-------|-------|-------|--------|------|
| Ant. Pol.: | Vertical | | | | | | | | | | | | | | | | | | | | | | | | | | | | | | |
| Test Mode: | TX 802.11a Mode 5180MHz (U-NII-1) | | | | | | | | | | | | | | | | | | | | | | | | | | | | | | |
| Remark: | No report for the emission which more than 20 dB below the prescribed limit. | | | | | | | | | | | | | | | | | | | | | | | | | | | | | | |
| <table border="1"> <thead> <tr> <th>No.</th> <th>Frequency (MHz)</th> <th>Reading (dBuV)</th> <th>Factor (dB/m)</th> <th>Level (dBuV/m)</th> <th>Limit (dBuV/m)</th> <th>Margin (dB)</th> <th>Detector</th> </tr> </thead> <tbody> <tr> <td>1 *</td> <td>10360.036</td> <td>28.06</td> <td>14.96</td> <td>43.02</td> <td>54.00</td> <td>-10.98</td> <td>AVG</td> </tr> <tr> <td>2</td> <td>10360.428</td> <td>40.73</td> <td>14.95</td> <td>55.68</td> <td>74.00</td> <td>-18.32</td> <td>peak</td> </tr> </tbody> </table> | | | | | | | | No. | Frequency (MHz) | Reading (dBuV) | Factor (dB/m) | Level (dBuV/m) | Limit (dBuV/m) | Margin (dB) | Detector | 1 * | 10360.036 | 28.06 | 14.96 | 43.02 | 54.00 | -10.98 | AVG | 2 | 10360.428 | 40.73 | 14.95 | 55.68 | 74.00 | -18.32 | peak |
| No. | Frequency (MHz) | Reading (dBuV) | Factor (dB/m) | Level (dBuV/m) | Limit (dBuV/m) | Margin (dB) | Detector | | | | | | | | | | | | | | | | | | | | | | | | |
| 1 * | 10360.036 | 28.06 | 14.96 | 43.02 | 54.00 | -10.98 | AVG | | | | | | | | | | | | | | | | | | | | | | | | |
| 2 | 10360.428 | 40.73 | 14.95 | 55.68 | 74.00 | -18.32 | peak | | | | | | | | | | | | | | | | | | | | | | | | |
| <p>Note: The chart shows Limits 74dBuV for Peak, 54dBuV for AVG, but Unwanted Emissions that fall Outside of the Restricted Bands is 68.2dBuV for Peak. No limit for AVG. All test results are in t compliance with the limits. After calculation, the Peak measurement value meets the limit requirements.</p> | | | | | | | | | | | | | | | | | | | | | | | | | | | | | | | |
| <p>Remarks: 1.Factor (dB/m) = Antenna Factor (dB/m)+Cable Factor (dB)-Pre-amplifier Factor 2.Margin value = Level -Limit value</p> | | | | | | | | | | | | | | | | | | | | | | | | | | | | | | | |



| Ant No.: | Ant 1 | | | | | | | | | | | | | | | | | | | | | | | | | | | | | | |
|---|--|----------------|---------------|----------------|----------------|-------------|----------|-----|-----------------|----------------|---------------|----------------|----------------|-------------|----------|---|-----------|-------|-------|-------|-------|--------|------|-----|-----------|-------|-------|-------|-------|--------|-----|
| Ant. Pol.: | Horizontal | | | | | | | | | | | | | | | | | | | | | | | | | | | | | | |
| Test Mode: | TX 802.11a Mode 5200MHz (U-NII-1) | | | | | | | | | | | | | | | | | | | | | | | | | | | | | | |
| Remark: | No report for the emission which more than 20 dB below the prescribed limit. | | | | | | | | | | | | | | | | | | | | | | | | | | | | | | |
| <table border="1"> <thead> <tr> <th>No.</th> <th>Frequency (MHz)</th> <th>Reading (dBuV)</th> <th>Factor (dB/m)</th> <th>Level (dBuV/m)</th> <th>Limit (dBuV/m)</th> <th>Margin (dB)</th> <th>Detector</th> </tr> </thead> <tbody> <tr> <td>1</td> <td>10397.890</td> <td>39.39</td> <td>15.02</td> <td>54.41</td> <td>74.00</td> <td>-19.59</td> <td>peak</td> </tr> <tr> <td>2 *</td> <td>10399.230</td> <td>27.29</td> <td>15.02</td> <td>42.31</td> <td>54.00</td> <td>-11.69</td> <td>AVG</td> </tr> </tbody> </table> | | | | | | | | No. | Frequency (MHz) | Reading (dBuV) | Factor (dB/m) | Level (dBuV/m) | Limit (dBuV/m) | Margin (dB) | Detector | 1 | 10397.890 | 39.39 | 15.02 | 54.41 | 74.00 | -19.59 | peak | 2 * | 10399.230 | 27.29 | 15.02 | 42.31 | 54.00 | -11.69 | AVG |
| No. | Frequency (MHz) | Reading (dBuV) | Factor (dB/m) | Level (dBuV/m) | Limit (dBuV/m) | Margin (dB) | Detector | | | | | | | | | | | | | | | | | | | | | | | | |
| 1 | 10397.890 | 39.39 | 15.02 | 54.41 | 74.00 | -19.59 | peak | | | | | | | | | | | | | | | | | | | | | | | | |
| 2 * | 10399.230 | 27.29 | 15.02 | 42.31 | 54.00 | -11.69 | AVG | | | | | | | | | | | | | | | | | | | | | | | | |
| <p>Note: The chart shows Limits 74dBuV for Peak, 54dBuV for AVG, but Unwanted Emissions that fall Outside of the Restricted Bands is 68.2dBuV for Peak. No limit for AVG. All test results are in t compliance with the limits. After calculation, the Peak measurement value meets the limit requirements.</p> | | | | | | | | | | | | | | | | | | | | | | | | | | | | | | | |
| <p>Remarks: 1.Factor (dB/m) = Antenna Factor (dB/m)+Cable Factor (dB)-Pre-amplifier Factor 2.Margin value = Level -Limit value</p> | | | | | | | | | | | | | | | | | | | | | | | | | | | | | | | |



| Ant No.: | Ant 1 | | | | | | | | | | | | | | | | | | | | | | | | | | | | | | |
|---|--|----------------|---------------|----------------|----------------|-------------|----------|-----|-----------------|----------------|---------------|----------------|----------------|-------------|----------|---|-----------|-------|-------|-------|-------|--------|------|-----|-----------|-------|-------|-------|-------|--------|-----|
| Ant. Pol.: | Vertical | | | | | | | | | | | | | | | | | | | | | | | | | | | | | | |
| Test Mode: | TX 802.11a Mode 5200MHz (U-NII-1) | | | | | | | | | | | | | | | | | | | | | | | | | | | | | | |
| Remark: | No report for the emission which more than 20 dB below the prescribed limit. | | | | | | | | | | | | | | | | | | | | | | | | | | | | | | |
| <table border="1"> <thead> <tr> <th>No.</th> <th>Frequency (MHz)</th> <th>Reading (dBuV)</th> <th>Factor (dB/m)</th> <th>Level (dBuV/m)</th> <th>Limit (dBuV/m)</th> <th>Margin (dB)</th> <th>Detector</th> </tr> </thead> <tbody> <tr> <td>1</td> <td>10399.446</td> <td>37.73</td> <td>15.02</td> <td>52.75</td> <td>74.00</td> <td>-21.25</td> <td>peak</td> </tr> <tr> <td>2 *</td> <td>10400.808</td> <td>25.97</td> <td>15.02</td> <td>40.99</td> <td>54.00</td> <td>-13.01</td> <td>AVG</td> </tr> </tbody> </table> | | | | | | | | No. | Frequency (MHz) | Reading (dBuV) | Factor (dB/m) | Level (dBuV/m) | Limit (dBuV/m) | Margin (dB) | Detector | 1 | 10399.446 | 37.73 | 15.02 | 52.75 | 74.00 | -21.25 | peak | 2 * | 10400.808 | 25.97 | 15.02 | 40.99 | 54.00 | -13.01 | AVG |
| No. | Frequency (MHz) | Reading (dBuV) | Factor (dB/m) | Level (dBuV/m) | Limit (dBuV/m) | Margin (dB) | Detector | | | | | | | | | | | | | | | | | | | | | | | | |
| 1 | 10399.446 | 37.73 | 15.02 | 52.75 | 74.00 | -21.25 | peak | | | | | | | | | | | | | | | | | | | | | | | | |
| 2 * | 10400.808 | 25.97 | 15.02 | 40.99 | 54.00 | -13.01 | AVG | | | | | | | | | | | | | | | | | | | | | | | | |
| <p>Note: The chart shows Limits 74dBuV for Peak, 54dBuV for AVG, but Unwanted Emissions that fall Outside of the Restricted Bands is 68.2dBuV for Peak. No limit for AVG. All test results are in t compliance with the limits. After calculation, the Peak measurement value meets the limit requirements.</p> | | | | | | | | | | | | | | | | | | | | | | | | | | | | | | | |
| <p>Remarks: 1.Factor (dB/m) = Antenna Factor (dB/m)+Cable Factor (dB)-Pre-amplifier Factor 2.Margin value = Level -Limit value</p> | | | | | | | | | | | | | | | | | | | | | | | | | | | | | | | |



| Ant No.: | Ant 1 | | | | | | | | | | | | | | | | | | | | | | | | | | | | | | |
|---|--|----------------|---------------|----------------|----------------|-------------|----------|-----|-----------------|----------------|---------------|----------------|----------------|-------------|----------|---|-----------|-------|-------|-------|-------|--------|------|-----|-----------|-------|-------|-------|-------|--------|-----|
| Ant. Pol.: | Horizontal | | | | | | | | | | | | | | | | | | | | | | | | | | | | | | |
| Test Mode: | TX 802.11a Mode 5240MHz (U-NII-1) | | | | | | | | | | | | | | | | | | | | | | | | | | | | | | |
| Remark: | No report for the emission which more than 20 dB below the prescribed limit. | | | | | | | | | | | | | | | | | | | | | | | | | | | | | | |
| <table border="1"> <thead> <tr> <th>No.</th> <th>Frequency (MHz)</th> <th>Reading (dBuV)</th> <th>Factor (dB/m)</th> <th>Level (dBuV/m)</th> <th>Limit (dBuV/m)</th> <th>Margin (dB)</th> <th>Detector</th> </tr> </thead> <tbody> <tr> <td>1</td> <td>10480.440</td> <td>38.99</td> <td>15.13</td> <td>54.12</td> <td>74.00</td> <td>-19.88</td> <td>peak</td> </tr> <tr> <td>2 *</td> <td>10482.070</td> <td>26.37</td> <td>15.13</td> <td>41.50</td> <td>54.00</td> <td>-12.50</td> <td>AVG</td> </tr> </tbody> </table> | | | | | | | | No. | Frequency (MHz) | Reading (dBuV) | Factor (dB/m) | Level (dBuV/m) | Limit (dBuV/m) | Margin (dB) | Detector | 1 | 10480.440 | 38.99 | 15.13 | 54.12 | 74.00 | -19.88 | peak | 2 * | 10482.070 | 26.37 | 15.13 | 41.50 | 54.00 | -12.50 | AVG |
| No. | Frequency (MHz) | Reading (dBuV) | Factor (dB/m) | Level (dBuV/m) | Limit (dBuV/m) | Margin (dB) | Detector | | | | | | | | | | | | | | | | | | | | | | | | |
| 1 | 10480.440 | 38.99 | 15.13 | 54.12 | 74.00 | -19.88 | peak | | | | | | | | | | | | | | | | | | | | | | | | |
| 2 * | 10482.070 | 26.37 | 15.13 | 41.50 | 54.00 | -12.50 | AVG | | | | | | | | | | | | | | | | | | | | | | | | |
| <p>Note: The chart shows Limits 74dBuV for Peak, 54dBuV for AVG, but Unwanted Emissions that fall Outside of the Restricted Bands is 68.2dBuV for Peak. No limit for AVG. All test results are in t compliance with the limits. After calculation, the Peak measurement value meets the limit requirements.</p> | | | | | | | | | | | | | | | | | | | | | | | | | | | | | | | |
| <p>Remarks: 1.Factor (dB/m) = Antenna Factor (dB/m)+Cable Factor (dB)-Pre-amplifier Factor 2.Margin value = Level -Limit value</p> | | | | | | | | | | | | | | | | | | | | | | | | | | | | | | | |



| Ant No.: | Ant 1 | | | | | | | | | | | | | | | | | | | | | | | | | | | | | | |
|---|--|----------------|---------------|----------------|----------------|-------------|----------|-----|-----------------|----------------|---------------|----------------|----------------|-------------|----------|---|-----------|-------|-------|-------|-------|--------|------|-----|-----------|-------|-------|-------|-------|--------|-----|
| Ant. Pol.: | Vertical | | | | | | | | | | | | | | | | | | | | | | | | | | | | | | |
| Test Mode: | TX 802.11a Mode 5240MHz (U-NII-1) | | | | | | | | | | | | | | | | | | | | | | | | | | | | | | |
| Remark: | No report for the emission which more than 20 dB below the prescribed limit. | | | | | | | | | | | | | | | | | | | | | | | | | | | | | | |
| <table border="1"> <thead> <tr> <th>No.</th> <th>Frequency (MHz)</th> <th>Reading (dBuV)</th> <th>Factor (dB/m)</th> <th>Level (dBuV/m)</th> <th>Limit (dBuV/m)</th> <th>Margin (dB)</th> <th>Detector</th> </tr> </thead> <tbody> <tr> <td>1</td> <td>10479.598</td> <td>38.93</td> <td>15.13</td> <td>54.06</td> <td>74.00</td> <td>-19.94</td> <td>peak</td> </tr> <tr> <td>2 *</td> <td>10479.912</td> <td>25.86</td> <td>15.13</td> <td>40.99</td> <td>54.00</td> <td>-13.01</td> <td>AVG</td> </tr> </tbody> </table> | | | | | | | | No. | Frequency (MHz) | Reading (dBuV) | Factor (dB/m) | Level (dBuV/m) | Limit (dBuV/m) | Margin (dB) | Detector | 1 | 10479.598 | 38.93 | 15.13 | 54.06 | 74.00 | -19.94 | peak | 2 * | 10479.912 | 25.86 | 15.13 | 40.99 | 54.00 | -13.01 | AVG |
| No. | Frequency (MHz) | Reading (dBuV) | Factor (dB/m) | Level (dBuV/m) | Limit (dBuV/m) | Margin (dB) | Detector | | | | | | | | | | | | | | | | | | | | | | | | |
| 1 | 10479.598 | 38.93 | 15.13 | 54.06 | 74.00 | -19.94 | peak | | | | | | | | | | | | | | | | | | | | | | | | |
| 2 * | 10479.912 | 25.86 | 15.13 | 40.99 | 54.00 | -13.01 | AVG | | | | | | | | | | | | | | | | | | | | | | | | |
| <p>Note: The chart shows Limits 74dBuV for Peak, 54dBuV for AVG, but Unwanted Emissions that fall Outside of the Restricted Bands is 68.2dBuV for Peak. No limit for AVG. All test results are in t compliance with the limits. After calculation, the Peak measurement value meets the limit requirements.</p> | | | | | | | | | | | | | | | | | | | | | | | | | | | | | | | |
| <p>Remarks: 1.Factor (dB/m) = Antenna Factor (dB/m)+Cable Factor (dB)-Pre-amplifier Factor 2.Margin value = Level -Limit value</p> | | | | | | | | | | | | | | | | | | | | | | | | | | | | | | | |



| Ant No.: | Ant 1 + Ant 2 | | | | | | | | | | | | | | | | | | | | | | | | | | | | | | |
|---|--|----------------|---------------|----------------|----------------|-------------|----------|-----|-----------------|----------------|---------------|----------------|----------------|-------------|----------|-----|-----------|-------|-------|-------|-------|--------|-----|---|-----------|-------|-------|-------|-------|--------|------|
| Ant. Pol.: | Horizontal | | | | | | | | | | | | | | | | | | | | | | | | | | | | | | |
| Test Mode: | TX 802.11n(HT20) Mode 5180MHz (U-NII-1) | | | | | | | | | | | | | | | | | | | | | | | | | | | | | | |
| Remark: | No report for the emission which more than 20 dB below the prescribed limit. | | | | | | | | | | | | | | | | | | | | | | | | | | | | | | |
| <table border="1"> <thead> <tr> <th>No.</th> <th>Frequency (MHz)</th> <th>Reading (dBuV)</th> <th>Factor (dB/m)</th> <th>Level (dBuV/m)</th> <th>Limit (dBuV/m)</th> <th>Margin (dB)</th> <th>Detector</th> </tr> </thead> <tbody> <tr> <td>1 *</td> <td>10359.844</td> <td>28.05</td> <td>14.96</td> <td>43.01</td> <td>54.00</td> <td>-10.99</td> <td>AVG</td> </tr> <tr> <td>2</td> <td>10360.564</td> <td>39.29</td> <td>14.95</td> <td>54.24</td> <td>74.00</td> <td>-19.76</td> <td>peak</td> </tr> </tbody> </table> | | | | | | | | No. | Frequency (MHz) | Reading (dBuV) | Factor (dB/m) | Level (dBuV/m) | Limit (dBuV/m) | Margin (dB) | Detector | 1 * | 10359.844 | 28.05 | 14.96 | 43.01 | 54.00 | -10.99 | AVG | 2 | 10360.564 | 39.29 | 14.95 | 54.24 | 74.00 | -19.76 | peak |
| No. | Frequency (MHz) | Reading (dBuV) | Factor (dB/m) | Level (dBuV/m) | Limit (dBuV/m) | Margin (dB) | Detector | | | | | | | | | | | | | | | | | | | | | | | | |
| 1 * | 10359.844 | 28.05 | 14.96 | 43.01 | 54.00 | -10.99 | AVG | | | | | | | | | | | | | | | | | | | | | | | | |
| 2 | 10360.564 | 39.29 | 14.95 | 54.24 | 74.00 | -19.76 | peak | | | | | | | | | | | | | | | | | | | | | | | | |
| <p>Note: The chart shows Limits 74dBuV for Peak, 54dBuV for AVG, but Unwanted Emissions that fall Outside of the Restricted Bands is 68.2dBuV for Peak. No limit for AVG. All test results are in t compliance with the limits. After calculation, the Peak measurement value meets the limit requirements.</p> | | | | | | | | | | | | | | | | | | | | | | | | | | | | | | | |
| <p>Remarks: 1.Factor (dB/m) = Antenna Factor (dB/m)+Cable Factor (dB)-Pre-amplifier Factor 2.Margin value = Level -Limit value</p> | | | | | | | | | | | | | | | | | | | | | | | | | | | | | | | |



| Ant No.: | Ant 1 + Ant 2 | | | | | | | | | | | | | | | | | | | | | | | | | | | | | | |
|---|--|----------------|---------------|----------------|----------------|-------------|----------|-----|-----------------|----------------|---------------|----------------|----------------|-------------|----------|-----|-----------|-------|-------|-------|-------|--------|-----|---|-----------|-------|-------|-------|-------|--------|------|
| Ant. Pol.: | Vertical | | | | | | | | | | | | | | | | | | | | | | | | | | | | | | |
| Test Mode: | TX 802.11n(HT20) Mode 5180MHz (U-NII-1) | | | | | | | | | | | | | | | | | | | | | | | | | | | | | | |
| Remark: | No report for the emission which more than 20 dB below the prescribed limit. | | | | | | | | | | | | | | | | | | | | | | | | | | | | | | |
| <table border="1"> <thead> <tr> <th>No.</th> <th>Frequency (MHz)</th> <th>Reading (dBuV)</th> <th>Factor (dB/m)</th> <th>Level (dBuV/m)</th> <th>Limit (dBuV/m)</th> <th>Margin (dB)</th> <th>Detector</th> </tr> </thead> <tbody> <tr> <td>1 *</td> <td>10360.226</td> <td>28.04</td> <td>14.96</td> <td>43.00</td> <td>54.00</td> <td>-11.00</td> <td>AVG</td> </tr> <tr> <td>2</td> <td>10360.842</td> <td>40.35</td> <td>14.96</td> <td>55.31</td> <td>74.00</td> <td>-18.69</td> <td>peak</td> </tr> </tbody> </table> | | | | | | | | No. | Frequency (MHz) | Reading (dBuV) | Factor (dB/m) | Level (dBuV/m) | Limit (dBuV/m) | Margin (dB) | Detector | 1 * | 10360.226 | 28.04 | 14.96 | 43.00 | 54.00 | -11.00 | AVG | 2 | 10360.842 | 40.35 | 14.96 | 55.31 | 74.00 | -18.69 | peak |
| No. | Frequency (MHz) | Reading (dBuV) | Factor (dB/m) | Level (dBuV/m) | Limit (dBuV/m) | Margin (dB) | Detector | | | | | | | | | | | | | | | | | | | | | | | | |
| 1 * | 10360.226 | 28.04 | 14.96 | 43.00 | 54.00 | -11.00 | AVG | | | | | | | | | | | | | | | | | | | | | | | | |
| 2 | 10360.842 | 40.35 | 14.96 | 55.31 | 74.00 | -18.69 | peak | | | | | | | | | | | | | | | | | | | | | | | | |
| <p>Note: The chart shows Limits 74dBuV for Peak, 54dBuV for AVG, but Unwanted Emissions that fall Outside of the Restricted Bands is 68.2dBuV for Peak. No limit for AVG. All test results are in t compliance with the limits. After calculation, the Peak measurement value meets the limit requirements.</p> | | | | | | | | | | | | | | | | | | | | | | | | | | | | | | | |
| <p>Remarks: 1.Factor (dB/m) = Antenna Factor (dB/m)+Cable Factor (dB)-Pre-amplifier Factor 2.Margin value = Level -Limit value</p> | | | | | | | | | | | | | | | | | | | | | | | | | | | | | | | |



| | |
|-------------------|--|
| Ant No.: | Ant 1 + Ant 2 |
| Ant. Pol.: | Horizontal |
| Test Mode: | TX 802.11n(HT20) Mode 5200MHz (U-NII-1) |
| Remark: | No report for the emission which more than 20 dB below the prescribed limit. |

| No. | Frequency (MHz) | Reading (dBuV) | Factor (dB/m) | Level (dBuV/m) | Limit (dBuV/m) | Margin (dB) | Detector |
|-----|-----------------|----------------|---------------|----------------|----------------|-------------|----------|
| 1 | 10399.326 | 38.48 | 15.02 | 53.50 | 74.00 | -20.50 | peak |
| 2 * | 10399.398 | 26.08 | 15.02 | 41.10 | 54.00 | -12.90 | AVG |

Note: The chart shows Limits 74dBuV for Peak, 54dBuV for AVG, but Unwanted Emissions that fall Outside of the Restricted Bands is 68.2dBuV for Peak. No limit for AVG. All test results are in t compliance with the limits. After calculation, the Peak measurement value meets the limit requirements.

Remarks:

1. Factor (dB/m) = Antenna Factor (dB/m)+Cable Factor (dB)-Pre-amplifier Factor
2. Margin value = Level -Limit value



| Ant No.: | Ant 1 + Ant 2 | | | | | | | | | | | | | | | | | | | | | | | | | | | | | | |
|---|--|----------------|---------------|----------------|----------------|-------------|----------|-----|-----------------|----------------|---------------|----------------|----------------|-------------|----------|---|-----------|-------|-------|-------|-------|--------|------|-----|-----------|-------|-------|-------|-------|--------|-----|
| Ant. Pol.: | Vertical | | | | | | | | | | | | | | | | | | | | | | | | | | | | | | |
| Test Mode: | TX 802.11n(HT20) Mode 5200MHz (U-NII-1) | | | | | | | | | | | | | | | | | | | | | | | | | | | | | | |
| Remark: | No report for the emission which more than 20 dB below the prescribed limit. | | | | | | | | | | | | | | | | | | | | | | | | | | | | | | |
| <table border="1"> <thead> <tr> <th>No.</th> <th>Frequency (MHz)</th> <th>Reading (dBuV)</th> <th>Factor (dB/m)</th> <th>Level (dBuV/m)</th> <th>Limit (dBuV/m)</th> <th>Margin (dB)</th> <th>Detector</th> </tr> </thead> <tbody> <tr> <td>1</td> <td>10399.022</td> <td>38.20</td> <td>15.02</td> <td>53.22</td> <td>74.00</td> <td>-20.78</td> <td>peak</td> </tr> <tr> <td>2 *</td> <td>10400.480</td> <td>25.95</td> <td>15.02</td> <td>40.97</td> <td>54.00</td> <td>-13.03</td> <td>AVG</td> </tr> </tbody> </table> | | | | | | | | No. | Frequency (MHz) | Reading (dBuV) | Factor (dB/m) | Level (dBuV/m) | Limit (dBuV/m) | Margin (dB) | Detector | 1 | 10399.022 | 38.20 | 15.02 | 53.22 | 74.00 | -20.78 | peak | 2 * | 10400.480 | 25.95 | 15.02 | 40.97 | 54.00 | -13.03 | AVG |
| No. | Frequency (MHz) | Reading (dBuV) | Factor (dB/m) | Level (dBuV/m) | Limit (dBuV/m) | Margin (dB) | Detector | | | | | | | | | | | | | | | | | | | | | | | | |
| 1 | 10399.022 | 38.20 | 15.02 | 53.22 | 74.00 | -20.78 | peak | | | | | | | | | | | | | | | | | | | | | | | | |
| 2 * | 10400.480 | 25.95 | 15.02 | 40.97 | 54.00 | -13.03 | AVG | | | | | | | | | | | | | | | | | | | | | | | | |
| <p>Note: The chart shows Limits 74dBuV for Peak, 54dBuV for AVG, but Unwanted Emissions that fall Outside of the Restricted Bands is 68.2dBuV for Peak. No limit for AVG. All test results are in t compliance with the limits. After calculation, the Peak measurement value meets the limit requirements.</p> | | | | | | | | | | | | | | | | | | | | | | | | | | | | | | | |
| <p>Remarks: 1.Factor (dB/m) = Antenna Factor (dB/m)+Cable Factor (dB)-Pre-amplifier Factor 2.Margin value = Level -Limit value</p> | | | | | | | | | | | | | | | | | | | | | | | | | | | | | | | |



| Ant No.: | Ant 1 + Ant 2 | | | | | | | | | | | | | | | | | | | | | | | | | | | | | | |
|---|--|----------------|---------------|----------------|----------------|-------------|----------|-----|-----------------|----------------|---------------|----------------|----------------|-------------|----------|-----|-----------|-------|-------|-------|-------|--------|-----|---|-----------|-------|-------|-------|-------|--------|------|
| Ant. Pol.: | Horizontal | | | | | | | | | | | | | | | | | | | | | | | | | | | | | | |
| Test Mode: | TX 802.11n(HT20) Mode 5240MHz (U-NII-1) | | | | | | | | | | | | | | | | | | | | | | | | | | | | | | |
| Remark: | No report for the emission which more than 20 dB below the prescribed limit. | | | | | | | | | | | | | | | | | | | | | | | | | | | | | | |
| <table border="1"> <thead> <tr> <th>No.</th> <th>Frequency (MHz)</th> <th>Reading (dBuV)</th> <th>Factor (dB/m)</th> <th>Level (dBuV/m)</th> <th>Limit (dBuV/m)</th> <th>Margin (dB)</th> <th>Detector</th> </tr> </thead> <tbody> <tr> <td>1 *</td> <td>10479.154</td> <td>26.05</td> <td>15.13</td> <td>41.18</td> <td>54.00</td> <td>-12.82</td> <td>AVG</td> </tr> <tr> <td>2</td> <td>10480.046</td> <td>38.36</td> <td>15.13</td> <td>53.49</td> <td>74.00</td> <td>-20.51</td> <td>peak</td> </tr> </tbody> </table> | | | | | | | | No. | Frequency (MHz) | Reading (dBuV) | Factor (dB/m) | Level (dBuV/m) | Limit (dBuV/m) | Margin (dB) | Detector | 1 * | 10479.154 | 26.05 | 15.13 | 41.18 | 54.00 | -12.82 | AVG | 2 | 10480.046 | 38.36 | 15.13 | 53.49 | 74.00 | -20.51 | peak |
| No. | Frequency (MHz) | Reading (dBuV) | Factor (dB/m) | Level (dBuV/m) | Limit (dBuV/m) | Margin (dB) | Detector | | | | | | | | | | | | | | | | | | | | | | | | |
| 1 * | 10479.154 | 26.05 | 15.13 | 41.18 | 54.00 | -12.82 | AVG | | | | | | | | | | | | | | | | | | | | | | | | |
| 2 | 10480.046 | 38.36 | 15.13 | 53.49 | 74.00 | -20.51 | peak | | | | | | | | | | | | | | | | | | | | | | | | |
| <p>Note: The chart shows Limits 74dBuV for Peak, 54dBuV for AVG, but Unwanted Emissions that fall Outside of the Restricted Bands is 68.2dBuV for Peak. No limit for AVG. All test results are in t compliance with the limits. After calculation, the Peak measurement value meets the limit requirements.</p> | | | | | | | | | | | | | | | | | | | | | | | | | | | | | | | |
| <p>Remarks: 1.Factor (dB/m) = Antenna Factor (dB/m)+Cable Factor (dB)-Pre-amplifier Factor 2.Margin value = Level -Limit value</p> | | | | | | | | | | | | | | | | | | | | | | | | | | | | | | | |



| Ant No.: | Ant 1 + Ant 2 | | | | | | | | | | | | | | | | | | | | | | | | | | | | | | |
|---|--|----------------|---------------|----------------|----------------|-------------|----------|-----|-----------------|----------------|---------------|----------------|----------------|-------------|----------|---|-----------|-------|-------|-------|-------|--------|------|-----|-----------|-------|-------|-------|-------|--------|-----|
| Ant. Pol.: | Vertical | | | | | | | | | | | | | | | | | | | | | | | | | | | | | | |
| Test Mode: | TX 802.11n(HT20) Mode 5240MHz (U-NII-1) | | | | | | | | | | | | | | | | | | | | | | | | | | | | | | |
| Remark: | No report for the emission which more than 20 dB below the prescribed limit. | | | | | | | | | | | | | | | | | | | | | | | | | | | | | | |
| <table border="1"> <thead> <tr> <th>No.</th> <th>Frequency (MHz)</th> <th>Reading (dBuV)</th> <th>Factor (dB/m)</th> <th>Level (dBuV/m)</th> <th>Limit (dBuV/m)</th> <th>Margin (dB)</th> <th>Detector</th> </tr> </thead> <tbody> <tr> <td>1</td> <td>10479.484</td> <td>38.12</td> <td>15.13</td> <td>53.25</td> <td>74.00</td> <td>-20.75</td> <td>peak</td> </tr> <tr> <td>2 *</td> <td>10480.886</td> <td>26.12</td> <td>15.13</td> <td>41.25</td> <td>54.00</td> <td>-12.75</td> <td>AVG</td> </tr> </tbody> </table> | | | | | | | | No. | Frequency (MHz) | Reading (dBuV) | Factor (dB/m) | Level (dBuV/m) | Limit (dBuV/m) | Margin (dB) | Detector | 1 | 10479.484 | 38.12 | 15.13 | 53.25 | 74.00 | -20.75 | peak | 2 * | 10480.886 | 26.12 | 15.13 | 41.25 | 54.00 | -12.75 | AVG |
| No. | Frequency (MHz) | Reading (dBuV) | Factor (dB/m) | Level (dBuV/m) | Limit (dBuV/m) | Margin (dB) | Detector | | | | | | | | | | | | | | | | | | | | | | | | |
| 1 | 10479.484 | 38.12 | 15.13 | 53.25 | 74.00 | -20.75 | peak | | | | | | | | | | | | | | | | | | | | | | | | |
| 2 * | 10480.886 | 26.12 | 15.13 | 41.25 | 54.00 | -12.75 | AVG | | | | | | | | | | | | | | | | | | | | | | | | |
| <p>Note: The chart shows Limits 74dBuV for Peak, 54dBuV for AVG, but Unwanted Emissions that fall Outside of the Restricted Bands is 68.2dBuV for Peak. No limit for AVG. All test results are in t compliance with the limits. After calculation, the Peak measurement value meets the limit requirements.</p> | | | | | | | | | | | | | | | | | | | | | | | | | | | | | | | |
| <p>Remarks: 1.Factor (dB/m) = Antenna Factor (dB/m)+Cable Factor (dB)-Pre-amplifier Factor 2.Margin value = Level -Limit value</p> | | | | | | | | | | | | | | | | | | | | | | | | | | | | | | | |



| Ant No.: | Ant 1 + Ant 2 | | | | | | | | | | | | | | | | | | | | | | | | | | | | | | |
|---|--|----------------|---------------|----------------|----------------|-------------|----------|-----|-----------------|----------------|---------------|----------------|----------------|-------------|----------|---|-----------|-------|-------|-------|-------|--------|------|-----|-----------|-------|-------|-------|-------|--------|-----|
| Ant. Pol.: | Horizontal | | | | | | | | | | | | | | | | | | | | | | | | | | | | | | |
| Test Mode: | TX 802.11n(HT40) Mode 5190MHz (U-NII-1) | | | | | | | | | | | | | | | | | | | | | | | | | | | | | | |
| Remark: | No report for the emission which more than 20 dB below the prescribed limit. | | | | | | | | | | | | | | | | | | | | | | | | | | | | | | |
| <table border="1"> <thead> <tr> <th>No.</th> <th>Frequency (MHz)</th> <th>Reading (dBuV)</th> <th>Factor (dB/m)</th> <th>Level (dBuV/m)</th> <th>Limit (dBuV/m)</th> <th>Margin (dB)</th> <th>Detector</th> </tr> </thead> <tbody> <tr> <td>1</td> <td>10379.704</td> <td>38.85</td> <td>14.99</td> <td>53.84</td> <td>74.00</td> <td>-20.16</td> <td>peak</td> </tr> <tr> <td>2 *</td> <td>10380.612</td> <td>26.54</td> <td>14.99</td> <td>41.53</td> <td>54.00</td> <td>-12.47</td> <td>AVG</td> </tr> </tbody> </table> | | | | | | | | No. | Frequency (MHz) | Reading (dBuV) | Factor (dB/m) | Level (dBuV/m) | Limit (dBuV/m) | Margin (dB) | Detector | 1 | 10379.704 | 38.85 | 14.99 | 53.84 | 74.00 | -20.16 | peak | 2 * | 10380.612 | 26.54 | 14.99 | 41.53 | 54.00 | -12.47 | AVG |
| No. | Frequency (MHz) | Reading (dBuV) | Factor (dB/m) | Level (dBuV/m) | Limit (dBuV/m) | Margin (dB) | Detector | | | | | | | | | | | | | | | | | | | | | | | | |
| 1 | 10379.704 | 38.85 | 14.99 | 53.84 | 74.00 | -20.16 | peak | | | | | | | | | | | | | | | | | | | | | | | | |
| 2 * | 10380.612 | 26.54 | 14.99 | 41.53 | 54.00 | -12.47 | AVG | | | | | | | | | | | | | | | | | | | | | | | | |
| <p>Note: The chart shows Limits 74dBuV for Peak, 54dBuV for AVG, but Unwanted Emissions that fall Outside of the Restricted Bands is 68.2dBuV for Peak. No limit for AVG. All test results are in t compliance with the limits. After calculation, the Peak measurement value meets the limit requirements.</p> | | | | | | | | | | | | | | | | | | | | | | | | | | | | | | | |
| <p>Remarks: 1.Factor (dB/m) = Antenna Factor (dB/m)+Cable Factor (dB)-Pre-amplifier Factor 2.Margin value = Level -Limit value</p> | | | | | | | | | | | | | | | | | | | | | | | | | | | | | | | |



| Ant No.: | Ant 1 + Ant 2 | | | | | | | | | | | | | | | | | | | | | | | | | | | | | | |
|---|--|----------------|---------------|----------------|----------------|-------------|----------|-----|-----------------|----------------|---------------|----------------|----------------|-------------|----------|---|-----------|-------|-------|-------|-------|--------|------|-----|-----------|-------|-------|-------|-------|--------|-----|
| Ant. Pol.: | Vertical | | | | | | | | | | | | | | | | | | | | | | | | | | | | | | |
| Test Mode: | TX 802.11n(HT40) Mode 5190MHz (U-NII-1) | | | | | | | | | | | | | | | | | | | | | | | | | | | | | | |
| Remark: | No report for the emission which more than 20 dB below the prescribed limit. | | | | | | | | | | | | | | | | | | | | | | | | | | | | | | |
| <table border="1"> <thead> <tr> <th>No.</th> <th>Frequency (MHz)</th> <th>Reading (dBuV)</th> <th>Factor (dB/m)</th> <th>Level (dBuV/m)</th> <th>Limit (dBuV/m)</th> <th>Margin (dB)</th> <th>Detector</th> </tr> </thead> <tbody> <tr> <td>1</td> <td>10379.374</td> <td>38.32</td> <td>14.99</td> <td>53.31</td> <td>74.00</td> <td>-20.69</td> <td>peak</td> </tr> <tr> <td>2 *</td> <td>10379.962</td> <td>26.35</td> <td>14.99</td> <td>41.34</td> <td>54.00</td> <td>-12.66</td> <td>AVG</td> </tr> </tbody> </table> | | | | | | | | No. | Frequency (MHz) | Reading (dBuV) | Factor (dB/m) | Level (dBuV/m) | Limit (dBuV/m) | Margin (dB) | Detector | 1 | 10379.374 | 38.32 | 14.99 | 53.31 | 74.00 | -20.69 | peak | 2 * | 10379.962 | 26.35 | 14.99 | 41.34 | 54.00 | -12.66 | AVG |
| No. | Frequency (MHz) | Reading (dBuV) | Factor (dB/m) | Level (dBuV/m) | Limit (dBuV/m) | Margin (dB) | Detector | | | | | | | | | | | | | | | | | | | | | | | | |
| 1 | 10379.374 | 38.32 | 14.99 | 53.31 | 74.00 | -20.69 | peak | | | | | | | | | | | | | | | | | | | | | | | | |
| 2 * | 10379.962 | 26.35 | 14.99 | 41.34 | 54.00 | -12.66 | AVG | | | | | | | | | | | | | | | | | | | | | | | | |
| <p>Note: The chart shows Limits 74dBuV for Peak, 54dBuV for AVG, but Unwanted Emissions that fall Outside of the Restricted Bands is 68.2dBuV for Peak. No limit for AVG. All test results are in t compliance with the limits. After calculation, the Peak measurement value meets the limit requirements.</p> | | | | | | | | | | | | | | | | | | | | | | | | | | | | | | | |
| <p>Remarks: 1.Factor (dB/m) = Antenna Factor (dB/m)+Cable Factor (dB)-Pre-amplifier Factor 2.Margin value = Level -Limit value</p> | | | | | | | | | | | | | | | | | | | | | | | | | | | | | | | |



| Ant No.: | Ant 1 + Ant 2 | | | | | | | | | | | | | | | | | | | | | | | | | | | | | | |
|---|--|----------------|---------------|----------------|----------------|-------------|----------|-----|-----------------|----------------|---------------|----------------|----------------|-------------|----------|-----|-----------|-------|-------|-------|-------|--------|-----|---|-----------|-------|-------|-------|-------|--------|------|
| Ant. Pol.: | Horizontal | | | | | | | | | | | | | | | | | | | | | | | | | | | | | | |
| Test Mode: | TX 802.11n(HT40) Mode 5230MHz (U-NII-1) | | | | | | | | | | | | | | | | | | | | | | | | | | | | | | |
| Remark: | No report for the emission which more than 20 dB below the prescribed limit. | | | | | | | | | | | | | | | | | | | | | | | | | | | | | | |
| <table border="1"> <thead> <tr> <th>No.</th> <th>Frequency (MHz)</th> <th>Reading (dBuV)</th> <th>Factor (dB/m)</th> <th>Level (dBuV/m)</th> <th>Limit (dBuV/m)</th> <th>Margin (dB)</th> <th>Detector</th> </tr> </thead> <tbody> <tr> <td>1 *</td> <td>10459.290</td> <td>25.83</td> <td>15.10</td> <td>40.93</td> <td>54.00</td> <td>-13.07</td> <td>AVG</td> </tr> <tr> <td>2</td> <td>10460.306</td> <td>37.97</td> <td>15.10</td> <td>53.07</td> <td>74.00</td> <td>-20.93</td> <td>peak</td> </tr> </tbody> </table> | | | | | | | | No. | Frequency (MHz) | Reading (dBuV) | Factor (dB/m) | Level (dBuV/m) | Limit (dBuV/m) | Margin (dB) | Detector | 1 * | 10459.290 | 25.83 | 15.10 | 40.93 | 54.00 | -13.07 | AVG | 2 | 10460.306 | 37.97 | 15.10 | 53.07 | 74.00 | -20.93 | peak |
| No. | Frequency (MHz) | Reading (dBuV) | Factor (dB/m) | Level (dBuV/m) | Limit (dBuV/m) | Margin (dB) | Detector | | | | | | | | | | | | | | | | | | | | | | | | |
| 1 * | 10459.290 | 25.83 | 15.10 | 40.93 | 54.00 | -13.07 | AVG | | | | | | | | | | | | | | | | | | | | | | | | |
| 2 | 10460.306 | 37.97 | 15.10 | 53.07 | 74.00 | -20.93 | peak | | | | | | | | | | | | | | | | | | | | | | | | |
| <p>Note: The chart shows Limits 74dBuV for Peak, 54dBuV for AVG, but Unwanted Emissions that fall Outside of the Restricted Bands is 68.2dBuV for Peak. No limit for AVG. All test results are in t compliance with the limits. After calculation, the Peak measurement value meets the limit requirements.</p> | | | | | | | | | | | | | | | | | | | | | | | | | | | | | | | |
| <p>Remarks: 1.Factor (dB/m) = Antenna Factor (dB/m)+Cable Factor (dB)-Pre-amplifier Factor 2.Margin value = Level -Limit value</p> | | | | | | | | | | | | | | | | | | | | | | | | | | | | | | | |



| Ant No.: | Ant 1 + Ant 2 | | | | | | | | | | | | | | | | | | | | | | | | | | | | | | |
|---|--|----------------|---------------|----------------|----------------|-------------|----------|-----|-----------------|----------------|---------------|----------------|----------------|-------------|----------|---|-----------|-------|-------|-------|-------|--------|------|-----|-----------|-------|-------|-------|-------|--------|-----|
| Ant. Pol.: | Vertical | | | | | | | | | | | | | | | | | | | | | | | | | | | | | | |
| Test Mode: | TX 802.11n(HT40) Mode 5230MHz (U-NII-1) | | | | | | | | | | | | | | | | | | | | | | | | | | | | | | |
| Remark: | No report for the emission which more than 20 dB below the prescribed limit. | | | | | | | | | | | | | | | | | | | | | | | | | | | | | | |
| <table border="1"> <thead> <tr> <th>No.</th> <th>Frequency (MHz)</th> <th>Reading (dBuV)</th> <th>Factor (dB/m)</th> <th>Level (dBuV/m)</th> <th>Limit (dBuV/m)</th> <th>Margin (dB)</th> <th>Detector</th> </tr> </thead> <tbody> <tr> <td>1</td> <td>10459.624</td> <td>38.52</td> <td>15.10</td> <td>53.62</td> <td>74.00</td> <td>-20.38</td> <td>peak</td> </tr> <tr> <td>2 *</td> <td>10459.704</td> <td>25.84</td> <td>15.10</td> <td>40.94</td> <td>54.00</td> <td>-13.06</td> <td>AVG</td> </tr> </tbody> </table> | | | | | | | | No. | Frequency (MHz) | Reading (dBuV) | Factor (dB/m) | Level (dBuV/m) | Limit (dBuV/m) | Margin (dB) | Detector | 1 | 10459.624 | 38.52 | 15.10 | 53.62 | 74.00 | -20.38 | peak | 2 * | 10459.704 | 25.84 | 15.10 | 40.94 | 54.00 | -13.06 | AVG |
| No. | Frequency (MHz) | Reading (dBuV) | Factor (dB/m) | Level (dBuV/m) | Limit (dBuV/m) | Margin (dB) | Detector | | | | | | | | | | | | | | | | | | | | | | | | |
| 1 | 10459.624 | 38.52 | 15.10 | 53.62 | 74.00 | -20.38 | peak | | | | | | | | | | | | | | | | | | | | | | | | |
| 2 * | 10459.704 | 25.84 | 15.10 | 40.94 | 54.00 | -13.06 | AVG | | | | | | | | | | | | | | | | | | | | | | | | |
| <p>Note: The chart shows Limits 74dBuV for Peak, 54dBuV for AVG, but Unwanted Emissions that fall Outside of the Restricted Bands is 68.2dBuV for Peak. No limit for AVG. All test results are in t compliance with the limits. After calculation, the Peak measurement value meets the limit requirements.</p> | | | | | | | | | | | | | | | | | | | | | | | | | | | | | | | |
| <p>Remarks: 1.Factor (dB/m) = Antenna Factor (dB/m)+Cable Factor (dB)-Pre-amplifier Factor 2.Margin value = Level -Limit value</p> | | | | | | | | | | | | | | | | | | | | | | | | | | | | | | | |



| Ant No.: | Ant 1 | | | | | | | | | | | | | | | | | | | | | | | | | | | | | | |
|---|--|----------------|---------------|----------------|----------------|-------------|----------|-----|-----------------|----------------|---------------|----------------|----------------|-------------|----------|---|-----------|-------|-------|-------|-------|--------|------|-----|-----------|-------|-------|-------|-------|--------|-----|
| Ant. Pol.: | Horizontal | | | | | | | | | | | | | | | | | | | | | | | | | | | | | | |
| Test Mode: | TX 802.11a Mode 5745MHz (U-NII-3) | | | | | | | | | | | | | | | | | | | | | | | | | | | | | | |
| Remark: | No report for the emission which more than 20 dB below the prescribed limit. | | | | | | | | | | | | | | | | | | | | | | | | | | | | | | |
| <table border="1"> <thead> <tr> <th>No.</th> <th>Frequency (MHz)</th> <th>Reading (dBuV)</th> <th>Factor (dB/m)</th> <th>Level (dBuV/m)</th> <th>Limit (dBuV/m)</th> <th>Margin (dB)</th> <th>Detector</th> </tr> </thead> <tbody> <tr> <td>1</td> <td>11489.614</td> <td>38.10</td> <td>16.27</td> <td>54.37</td> <td>74.00</td> <td>-19.63</td> <td>peak</td> </tr> <tr> <td>2 *</td> <td>11490.160</td> <td>26.44</td> <td>16.27</td> <td>42.71</td> <td>54.00</td> <td>-11.29</td> <td>AVG</td> </tr> </tbody> </table> | | | | | | | | No. | Frequency (MHz) | Reading (dBuV) | Factor (dB/m) | Level (dBuV/m) | Limit (dBuV/m) | Margin (dB) | Detector | 1 | 11489.614 | 38.10 | 16.27 | 54.37 | 74.00 | -19.63 | peak | 2 * | 11490.160 | 26.44 | 16.27 | 42.71 | 54.00 | -11.29 | AVG |
| No. | Frequency (MHz) | Reading (dBuV) | Factor (dB/m) | Level (dBuV/m) | Limit (dBuV/m) | Margin (dB) | Detector | | | | | | | | | | | | | | | | | | | | | | | | |
| 1 | 11489.614 | 38.10 | 16.27 | 54.37 | 74.00 | -19.63 | peak | | | | | | | | | | | | | | | | | | | | | | | | |
| 2 * | 11490.160 | 26.44 | 16.27 | 42.71 | 54.00 | -11.29 | AVG | | | | | | | | | | | | | | | | | | | | | | | | |
| Remarks: 1.Factor (dB/m) = Antenna Factor (dB/m)+Cable Factor (dB)-Pre-amplifier Factor 2.Margin value = Level -Limit value | | | | | | | | | | | | | | | | | | | | | | | | | | | | | | | |



| Ant No.: | Ant 1 | | | | | | | | | | | | | | | | | | | | | | | | | | | | | | |
|---|--|----------------|---------------|----------------|----------------|-------------|----------|-----|-----------------|----------------|---------------|----------------|----------------|-------------|----------|-----|-----------|-------|-------|-------|-------|--------|-----|---|-----------|-------|-------|-------|-------|--------|------|
| Ant. Pol.: | Vertical | | | | | | | | | | | | | | | | | | | | | | | | | | | | | | |
| Test Mode: | TX 802.11a Mode 5745MHz (U-NII-3) | | | | | | | | | | | | | | | | | | | | | | | | | | | | | | |
| Remark: | No report for the emission which more than 20 dB below the prescribed limit. | | | | | | | | | | | | | | | | | | | | | | | | | | | | | | |
| <table border="1"> <thead> <tr> <th>No.</th> <th>Frequency (MHz)</th> <th>Reading (dBuV)</th> <th>Factor (dB/m)</th> <th>Level (dBuV/m)</th> <th>Limit (dBuV/m)</th> <th>Margin (dB)</th> <th>Detector</th> </tr> </thead> <tbody> <tr> <td>1 *</td> <td>11489.572</td> <td>26.37</td> <td>16.27</td> <td>42.64</td> <td>54.00</td> <td>-11.36</td> <td>AVG</td> </tr> <tr> <td>2</td> <td>11490.964</td> <td>38.53</td> <td>16.27</td> <td>54.80</td> <td>74.00</td> <td>-19.20</td> <td>peak</td> </tr> </tbody> </table> | | | | | | | | No. | Frequency (MHz) | Reading (dBuV) | Factor (dB/m) | Level (dBuV/m) | Limit (dBuV/m) | Margin (dB) | Detector | 1 * | 11489.572 | 26.37 | 16.27 | 42.64 | 54.00 | -11.36 | AVG | 2 | 11490.964 | 38.53 | 16.27 | 54.80 | 74.00 | -19.20 | peak |
| No. | Frequency (MHz) | Reading (dBuV) | Factor (dB/m) | Level (dBuV/m) | Limit (dBuV/m) | Margin (dB) | Detector | | | | | | | | | | | | | | | | | | | | | | | | |
| 1 * | 11489.572 | 26.37 | 16.27 | 42.64 | 54.00 | -11.36 | AVG | | | | | | | | | | | | | | | | | | | | | | | | |
| 2 | 11490.964 | 38.53 | 16.27 | 54.80 | 74.00 | -19.20 | peak | | | | | | | | | | | | | | | | | | | | | | | | |
| Remarks: 1. Factor (dB/m) = Antenna Factor (dB/m)+Cable Factor (dB)-Pre-amplifier Factor 2. Margin value = Level -Limit value | | | | | | | | | | | | | | | | | | | | | | | | | | | | | | | |



| Ant No.: | Ant 1 | | | | | | | | | | | | | | | | | | | | | | | | | | | | | | |
|---|--|----------------|---------------|----------------|----------------|-------------|----------|-----|-----------------|----------------|---------------|----------------|----------------|-------------|----------|-----|-----------|-------|-------|-------|-------|--------|-----|---|-----------|-------|-------|-------|-------|--------|------|
| Ant. Pol.: | Horizontal | | | | | | | | | | | | | | | | | | | | | | | | | | | | | | |
| Test Mode: | TX 802.11a Mode 5785MHz (U-NII-3) | | | | | | | | | | | | | | | | | | | | | | | | | | | | | | |
| Remark: | No report for the emission which more than 20 dB below the prescribed limit. | | | | | | | | | | | | | | | | | | | | | | | | | | | | | | |
| <table border="1"> <thead> <tr> <th>No.</th> <th>Frequency (MHz)</th> <th>Reading (dBuV)</th> <th>Factor (dB/m)</th> <th>Level (dBuV/m)</th> <th>Limit (dBuV/m)</th> <th>Margin (dB)</th> <th>Detector</th> </tr> </thead> <tbody> <tr> <td>1 *</td> <td>11569.446</td> <td>26.30</td> <td>16.35</td> <td>42.65</td> <td>54.00</td> <td>-11.35</td> <td>AVG</td> </tr> <tr> <td>2</td> <td>11570.542</td> <td>38.21</td> <td>16.35</td> <td>54.56</td> <td>74.00</td> <td>-19.44</td> <td>peak</td> </tr> </tbody> </table> | | | | | | | | No. | Frequency (MHz) | Reading (dBuV) | Factor (dB/m) | Level (dBuV/m) | Limit (dBuV/m) | Margin (dB) | Detector | 1 * | 11569.446 | 26.30 | 16.35 | 42.65 | 54.00 | -11.35 | AVG | 2 | 11570.542 | 38.21 | 16.35 | 54.56 | 74.00 | -19.44 | peak |
| No. | Frequency (MHz) | Reading (dBuV) | Factor (dB/m) | Level (dBuV/m) | Limit (dBuV/m) | Margin (dB) | Detector | | | | | | | | | | | | | | | | | | | | | | | | |
| 1 * | 11569.446 | 26.30 | 16.35 | 42.65 | 54.00 | -11.35 | AVG | | | | | | | | | | | | | | | | | | | | | | | | |
| 2 | 11570.542 | 38.21 | 16.35 | 54.56 | 74.00 | -19.44 | peak | | | | | | | | | | | | | | | | | | | | | | | | |
| Remarks: 1.Factor (dB/m) = Antenna Factor (dB/m)+Cable Factor (dB)-Pre-amplifier Factor 2.Margin value = Level -Limit value | | | | | | | | | | | | | | | | | | | | | | | | | | | | | | | |



| Ant No.: | Ant 1 | | | | | | | | | | | | | | | | | | | | | | | | | | | | | | |
|---|--|----------------|---------------|----------------|----------------|-------------|----------|-----|-----------------|----------------|---------------|----------------|----------------|-------------|----------|-----|-----------|-------|-------|-------|-------|--------|-----|---|-----------|-------|-------|-------|-------|--------|------|
| Ant. Pol.: | Vertical | | | | | | | | | | | | | | | | | | | | | | | | | | | | | | |
| Test Mode: | TX 802.11a Mode 5785MHz (U-NII-3) | | | | | | | | | | | | | | | | | | | | | | | | | | | | | | |
| Remark: | No report for the emission which more than 20 dB below the prescribed limit. | | | | | | | | | | | | | | | | | | | | | | | | | | | | | | |
| <table border="1"> <thead> <tr> <th>No.</th> <th>Frequency (MHz)</th> <th>Reading (dBuV)</th> <th>Factor (dB/m)</th> <th>Level (dBuV/m)</th> <th>Limit (dBuV/m)</th> <th>Margin (dB)</th> <th>Detector</th> </tr> </thead> <tbody> <tr> <td>1 *</td> <td>11570.144</td> <td>26.18</td> <td>16.35</td> <td>42.53</td> <td>54.00</td> <td>-11.47</td> <td>AVG</td> </tr> <tr> <td>2</td> <td>11570.462</td> <td>38.23</td> <td>16.35</td> <td>54.58</td> <td>74.00</td> <td>-19.42</td> <td>peak</td> </tr> </tbody> </table> | | | | | | | | No. | Frequency (MHz) | Reading (dBuV) | Factor (dB/m) | Level (dBuV/m) | Limit (dBuV/m) | Margin (dB) | Detector | 1 * | 11570.144 | 26.18 | 16.35 | 42.53 | 54.00 | -11.47 | AVG | 2 | 11570.462 | 38.23 | 16.35 | 54.58 | 74.00 | -19.42 | peak |
| No. | Frequency (MHz) | Reading (dBuV) | Factor (dB/m) | Level (dBuV/m) | Limit (dBuV/m) | Margin (dB) | Detector | | | | | | | | | | | | | | | | | | | | | | | | |
| 1 * | 11570.144 | 26.18 | 16.35 | 42.53 | 54.00 | -11.47 | AVG | | | | | | | | | | | | | | | | | | | | | | | | |
| 2 | 11570.462 | 38.23 | 16.35 | 54.58 | 74.00 | -19.42 | peak | | | | | | | | | | | | | | | | | | | | | | | | |
| Remarks: 1. Factor (dB/m) = Antenna Factor (dB/m)+Cable Factor (dB)-Pre-amplifier Factor 2. Margin value = Level -Limit value | | | | | | | | | | | | | | | | | | | | | | | | | | | | | | | |



| Ant No.: | Ant 1 | | | | | | | | | | | | | | | | | | | | | | | | | | | | | | |
|--|--|----------------|---------------|----------------|----------------|-------------|----------|-----|-----------------|----------------|---------------|----------------|----------------|-------------|----------|---|-----------|-------|-------|-------|-------|--------|------|-----|-----------|-------|-------|-------|-------|--------|-----|
| Ant. Pol.: | Horizontal | | | | | | | | | | | | | | | | | | | | | | | | | | | | | | |
| Test Mode: | TX 802.11a Mode 5825MHz (U-NII-3) | | | | | | | | | | | | | | | | | | | | | | | | | | | | | | |
| Remark: | No report for the emission which more than 20 dB below the prescribed limit. | | | | | | | | | | | | | | | | | | | | | | | | | | | | | | |
| <table border="1"><thead><tr><th>No.</th><th>Frequency (MHz)</th><th>Reading (dBuV)</th><th>Factor (dB/m)</th><th>Level (dBuV/m)</th><th>Limit (dBuV/m)</th><th>Margin (dB)</th><th>Detector</th></tr></thead><tbody><tr><td>1</td><td>11649.038</td><td>38.84</td><td>16.43</td><td>55.27</td><td>74.00</td><td>-18.73</td><td>peak</td></tr><tr><td>2 *</td><td>11650.110</td><td>26.22</td><td>16.44</td><td>42.66</td><td>54.00</td><td>-11.34</td><td>AVG</td></tr></tbody></table> | | | | | | | | No. | Frequency (MHz) | Reading (dBuV) | Factor (dB/m) | Level (dBuV/m) | Limit (dBuV/m) | Margin (dB) | Detector | 1 | 11649.038 | 38.84 | 16.43 | 55.27 | 74.00 | -18.73 | peak | 2 * | 11650.110 | 26.22 | 16.44 | 42.66 | 54.00 | -11.34 | AVG |
| No. | Frequency (MHz) | Reading (dBuV) | Factor (dB/m) | Level (dBuV/m) | Limit (dBuV/m) | Margin (dB) | Detector | | | | | | | | | | | | | | | | | | | | | | | | |
| 1 | 11649.038 | 38.84 | 16.43 | 55.27 | 74.00 | -18.73 | peak | | | | | | | | | | | | | | | | | | | | | | | | |
| 2 * | 11650.110 | 26.22 | 16.44 | 42.66 | 54.00 | -11.34 | AVG | | | | | | | | | | | | | | | | | | | | | | | | |
| Remarks: 1.Factor (dB/m) = Antenna Factor (dB/m)+Cable Factor (dB)-Pre-amplifier Factor 2.Margin value = Level -Limit value | | | | | | | | | | | | | | | | | | | | | | | | | | | | | | | |



| Ant No.: | Ant 1 | | | | | | | | | | | | | | | | | | | | | | | | | | | | | | |
|--|--|----------------|---------------|----------------|----------------|-------------|----------|-----|-----------------|----------------|---------------|----------------|----------------|-------------|----------|---|-----------|-------|-------|-------|-------|--------|------|-----|-----------|-------|-------|-------|-------|--------|-----|
| Ant. Pol.: | Vertical | | | | | | | | | | | | | | | | | | | | | | | | | | | | | | |
| Test Mode: | TX 802.11a Mode 5825MHz (U-NII-3) | | | | | | | | | | | | | | | | | | | | | | | | | | | | | | |
| Remark: | No report for the emission which more than 20 dB below the prescribed limit. | | | | | | | | | | | | | | | | | | | | | | | | | | | | | | |
| <table border="1"><thead><tr><th>No.</th><th>Frequency (MHz)</th><th>Reading (dBuV)</th><th>Factor (dB/m)</th><th>Level (dBuV/m)</th><th>Limit (dBuV/m)</th><th>Margin (dB)</th><th>Detector</th></tr></thead><tbody><tr><td>1</td><td>11649.502</td><td>37.90</td><td>16.43</td><td>54.33</td><td>74.00</td><td>-19.67</td><td>peak</td></tr><tr><td>2 *</td><td>11650.300</td><td>26.17</td><td>16.44</td><td>42.61</td><td>54.00</td><td>-11.39</td><td>AVG</td></tr></tbody></table> | | | | | | | | No. | Frequency (MHz) | Reading (dBuV) | Factor (dB/m) | Level (dBuV/m) | Limit (dBuV/m) | Margin (dB) | Detector | 1 | 11649.502 | 37.90 | 16.43 | 54.33 | 74.00 | -19.67 | peak | 2 * | 11650.300 | 26.17 | 16.44 | 42.61 | 54.00 | -11.39 | AVG |
| No. | Frequency (MHz) | Reading (dBuV) | Factor (dB/m) | Level (dBuV/m) | Limit (dBuV/m) | Margin (dB) | Detector | | | | | | | | | | | | | | | | | | | | | | | | |
| 1 | 11649.502 | 37.90 | 16.43 | 54.33 | 74.00 | -19.67 | peak | | | | | | | | | | | | | | | | | | | | | | | | |
| 2 * | 11650.300 | 26.17 | 16.44 | 42.61 | 54.00 | -11.39 | AVG | | | | | | | | | | | | | | | | | | | | | | | | |
| Remarks: 1.Factor (dB/m) = Antenna Factor (dB/m)+Cable Factor (dB)-Pre-amplifier Factor 2.Margin value = Level -Limit value | | | | | | | | | | | | | | | | | | | | | | | | | | | | | | | |



| Ant No.: | Ant 1 + Ant 2 | | | | | | | | | | | | | | | | | | | | | | | | | | | | | | |
|---|--|----------------|---------------|----------------|----------------|-------------|----------|-----|-----------------|----------------|---------------|----------------|----------------|-------------|----------|-----|-----------|-------|-------|-------|-------|--------|-----|---|-----------|-------|-------|-------|-------|--------|------|
| Ant. Pol.: | Horizontal | | | | | | | | | | | | | | | | | | | | | | | | | | | | | | |
| Test Mode: | TX 802.11n(HT20) Mode 5745MHz (U-NII-3) | | | | | | | | | | | | | | | | | | | | | | | | | | | | | | |
| Remark: | No report for the emission which more than 20 dB below the prescribed limit. | | | | | | | | | | | | | | | | | | | | | | | | | | | | | | |
| <table border="1"> <thead> <tr> <th>No.</th> <th>Frequency (MHz)</th> <th>Reading (dBuV)</th> <th>Factor (dB/m)</th> <th>Level (dBuV/m)</th> <th>Limit (dBuV/m)</th> <th>Margin (dB)</th> <th>Detector</th> </tr> </thead> <tbody> <tr> <td>1 *</td> <td>11489.244</td> <td>26.27</td> <td>16.27</td> <td>42.54</td> <td>54.00</td> <td>-11.46</td> <td>AVG</td> </tr> <tr> <td>2</td> <td>11489.938</td> <td>38.23</td> <td>16.27</td> <td>54.50</td> <td>74.00</td> <td>-19.50</td> <td>peak</td> </tr> </tbody> </table> | | | | | | | | No. | Frequency (MHz) | Reading (dBuV) | Factor (dB/m) | Level (dBuV/m) | Limit (dBuV/m) | Margin (dB) | Detector | 1 * | 11489.244 | 26.27 | 16.27 | 42.54 | 54.00 | -11.46 | AVG | 2 | 11489.938 | 38.23 | 16.27 | 54.50 | 74.00 | -19.50 | peak |
| No. | Frequency (MHz) | Reading (dBuV) | Factor (dB/m) | Level (dBuV/m) | Limit (dBuV/m) | Margin (dB) | Detector | | | | | | | | | | | | | | | | | | | | | | | | |
| 1 * | 11489.244 | 26.27 | 16.27 | 42.54 | 54.00 | -11.46 | AVG | | | | | | | | | | | | | | | | | | | | | | | | |
| 2 | 11489.938 | 38.23 | 16.27 | 54.50 | 74.00 | -19.50 | peak | | | | | | | | | | | | | | | | | | | | | | | | |
| Remarks: 1.Factor (dB/m) = Antenna Factor (dB/m)+Cable Factor (dB)-Pre-amplifier Factor 2.Margin value = Level -Limit value | | | | | | | | | | | | | | | | | | | | | | | | | | | | | | | |



| Ant No.: | Ant 1 + Ant 2 | | | | | | | | | | | | | | | | | | | | | | | | | | | | | | |
|---|--|----------------|---------------|----------------|----------------|-------------|----------|-----|-----------------|----------------|---------------|----------------|----------------|-------------|----------|-----|-----------|-------|-------|-------|-------|--------|-----|---|-----------|-------|-------|-------|-------|--------|------|
| Ant. Pol.: | Vertical | | | | | | | | | | | | | | | | | | | | | | | | | | | | | | |
| Test Mode: | TX 802.11n(HT20) Mode 5745MHz (U-NII-3) | | | | | | | | | | | | | | | | | | | | | | | | | | | | | | |
| Remark: | No report for the emission which more than 20 dB below the prescribed limit. | | | | | | | | | | | | | | | | | | | | | | | | | | | | | | |
| <table border="1"> <thead> <tr> <th>No.</th> <th>Frequency (MHz)</th> <th>Reading (dBuV)</th> <th>Factor (dB/m)</th> <th>Level (dBuV/m)</th> <th>Limit (dBuV/m)</th> <th>Margin (dB)</th> <th>Detector</th> </tr> </thead> <tbody> <tr> <td>1 *</td> <td>11489.904</td> <td>26.29</td> <td>16.27</td> <td>42.56</td> <td>54.00</td> <td>-11.44</td> <td>AVG</td> </tr> <tr> <td>2</td> <td>11489.994</td> <td>38.39</td> <td>16.27</td> <td>54.66</td> <td>74.00</td> <td>-19.34</td> <td>peak</td> </tr> </tbody> </table> | | | | | | | | No. | Frequency (MHz) | Reading (dBuV) | Factor (dB/m) | Level (dBuV/m) | Limit (dBuV/m) | Margin (dB) | Detector | 1 * | 11489.904 | 26.29 | 16.27 | 42.56 | 54.00 | -11.44 | AVG | 2 | 11489.994 | 38.39 | 16.27 | 54.66 | 74.00 | -19.34 | peak |
| No. | Frequency (MHz) | Reading (dBuV) | Factor (dB/m) | Level (dBuV/m) | Limit (dBuV/m) | Margin (dB) | Detector | | | | | | | | | | | | | | | | | | | | | | | | |
| 1 * | 11489.904 | 26.29 | 16.27 | 42.56 | 54.00 | -11.44 | AVG | | | | | | | | | | | | | | | | | | | | | | | | |
| 2 | 11489.994 | 38.39 | 16.27 | 54.66 | 74.00 | -19.34 | peak | | | | | | | | | | | | | | | | | | | | | | | | |
| Remarks: 1. Factor (dB/m) = Antenna Factor (dB/m)+Cable Factor (dB)-Pre-amplifier Factor 2. Margin value = Level -Limit value | | | | | | | | | | | | | | | | | | | | | | | | | | | | | | | |



| Ant No.: | Ant 1 + Ant 2 | | | | | | | | | | | | | | | | | | | | | | | | | | | | | | |
|---|--|----------------|---------------|----------------|----------------|-------------|----------|-----|-----------------|----------------|---------------|----------------|----------------|-------------|----------|---|-----------|-------|-------|-------|-------|--------|------|-----|-----------|-------|-------|-------|-------|--------|-----|
| Ant. Pol.: | Horizontal | | | | | | | | | | | | | | | | | | | | | | | | | | | | | | |
| Test Mode: | TX 802.11n(HT20) Mode 5785MHz (U-NII-3) | | | | | | | | | | | | | | | | | | | | | | | | | | | | | | |
| Remark: | No report for the emission which more than 20 dB below the prescribed limit. | | | | | | | | | | | | | | | | | | | | | | | | | | | | | | |
| <table border="1"> <thead> <tr> <th>No.</th> <th>Frequency (MHz)</th> <th>Reading (dBuV)</th> <th>Factor (dB/m)</th> <th>Level (dBuV/m)</th> <th>Limit (dBuV/m)</th> <th>Margin (dB)</th> <th>Detector</th> </tr> </thead> <tbody> <tr> <td>1</td> <td>11569.118</td> <td>38.45</td> <td>16.35</td> <td>54.80</td> <td>74.00</td> <td>-19.20</td> <td>peak</td> </tr> <tr> <td>2 *</td> <td>11570.432</td> <td>26.09</td> <td>16.35</td> <td>42.44</td> <td>54.00</td> <td>-11.56</td> <td>AVG</td> </tr> </tbody> </table> | | | | | | | | No. | Frequency (MHz) | Reading (dBuV) | Factor (dB/m) | Level (dBuV/m) | Limit (dBuV/m) | Margin (dB) | Detector | 1 | 11569.118 | 38.45 | 16.35 | 54.80 | 74.00 | -19.20 | peak | 2 * | 11570.432 | 26.09 | 16.35 | 42.44 | 54.00 | -11.56 | AVG |
| No. | Frequency (MHz) | Reading (dBuV) | Factor (dB/m) | Level (dBuV/m) | Limit (dBuV/m) | Margin (dB) | Detector | | | | | | | | | | | | | | | | | | | | | | | | |
| 1 | 11569.118 | 38.45 | 16.35 | 54.80 | 74.00 | -19.20 | peak | | | | | | | | | | | | | | | | | | | | | | | | |
| 2 * | 11570.432 | 26.09 | 16.35 | 42.44 | 54.00 | -11.56 | AVG | | | | | | | | | | | | | | | | | | | | | | | | |
| Remarks: 1.Factor (dB/m) = Antenna Factor (dB/m)+Cable Factor (dB)-Pre-amplifier Factor 2.Margin value = Level -Limit value | | | | | | | | | | | | | | | | | | | | | | | | | | | | | | | |



| Ant No.: | Ant 1 + Ant 2 | | | | | | | | | | | | | | | | | | | | | | | | | | | | | | |
|---|--|----------------|---------------|----------------|----------------|-------------|----------|-----|-----------------|----------------|---------------|----------------|----------------|-------------|----------|-----|-----------|-------|-------|-------|-------|--------|-----|---|-----------|-------|-------|-------|-------|--------|------|
| Ant. Pol.: | Vertical | | | | | | | | | | | | | | | | | | | | | | | | | | | | | | |
| Test Mode: | TX 802.11n(HT20) Mode 5785MHz (U-NII-3) | | | | | | | | | | | | | | | | | | | | | | | | | | | | | | |
| Remark: | No report for the emission which more than 20 dB below the prescribed limit. | | | | | | | | | | | | | | | | | | | | | | | | | | | | | | |
| <table border="1"> <thead> <tr> <th>No.</th> <th>Frequency (MHz)</th> <th>Reading (dBuV)</th> <th>Factor (dB/m)</th> <th>Level (dBuV/m)</th> <th>Limit (dBuV/m)</th> <th>Margin (dB)</th> <th>Detector</th> </tr> </thead> <tbody> <tr> <td>1 *</td> <td>11569.190</td> <td>26.27</td> <td>16.35</td> <td>42.62</td> <td>54.00</td> <td>-11.38</td> <td>AVG</td> </tr> <tr> <td>2</td> <td>11570.592</td> <td>38.23</td> <td>16.35</td> <td>54.58</td> <td>74.00</td> <td>-19.42</td> <td>peak</td> </tr> </tbody> </table> | | | | | | | | No. | Frequency (MHz) | Reading (dBuV) | Factor (dB/m) | Level (dBuV/m) | Limit (dBuV/m) | Margin (dB) | Detector | 1 * | 11569.190 | 26.27 | 16.35 | 42.62 | 54.00 | -11.38 | AVG | 2 | 11570.592 | 38.23 | 16.35 | 54.58 | 74.00 | -19.42 | peak |
| No. | Frequency (MHz) | Reading (dBuV) | Factor (dB/m) | Level (dBuV/m) | Limit (dBuV/m) | Margin (dB) | Detector | | | | | | | | | | | | | | | | | | | | | | | | |
| 1 * | 11569.190 | 26.27 | 16.35 | 42.62 | 54.00 | -11.38 | AVG | | | | | | | | | | | | | | | | | | | | | | | | |
| 2 | 11570.592 | 38.23 | 16.35 | 54.58 | 74.00 | -19.42 | peak | | | | | | | | | | | | | | | | | | | | | | | | |
| Remarks: 1. Factor (dB/m) = Antenna Factor (dB/m)+Cable Factor (dB)-Pre-amplifier Factor 2. Margin value = Level -Limit value | | | | | | | | | | | | | | | | | | | | | | | | | | | | | | | |



| Ant No.: | Ant 1 + Ant 2 | | | | | | | | | | | | | | | | | | | | | | | | | | | | | | |
|---|--|----------------|---------------|----------------|----------------|-------------|----------|-----|-----------------|----------------|---------------|----------------|----------------|-------------|----------|-----|-----------|-------|-------|-------|-------|--------|-----|---|-----------|-------|-------|-------|-------|--------|------|
| Ant. Pol.: | Horizontal | | | | | | | | | | | | | | | | | | | | | | | | | | | | | | |
| Test Mode: | TX 802.11n(HT20) Mode 5825MHz (U-NII-3) | | | | | | | | | | | | | | | | | | | | | | | | | | | | | | |
| Remark: | No report for the emission which more than 20 dB below the prescribed limit. | | | | | | | | | | | | | | | | | | | | | | | | | | | | | | |
| <table border="1"> <thead> <tr> <th>No.</th> <th>Frequency (MHz)</th> <th>Reading (dBuV)</th> <th>Factor (dB/m)</th> <th>Level (dBuV/m)</th> <th>Limit (dBuV/m)</th> <th>Margin (dB)</th> <th>Detector</th> </tr> </thead> <tbody> <tr> <td>1 *</td> <td>11649.336</td> <td>26.25</td> <td>16.43</td> <td>42.68</td> <td>54.00</td> <td>-11.32</td> <td>AVG</td> </tr> <tr> <td>2</td> <td>11650.092</td> <td>38.31</td> <td>16.44</td> <td>54.75</td> <td>74.00</td> <td>-19.25</td> <td>peak</td> </tr> </tbody> </table> | | | | | | | | No. | Frequency (MHz) | Reading (dBuV) | Factor (dB/m) | Level (dBuV/m) | Limit (dBuV/m) | Margin (dB) | Detector | 1 * | 11649.336 | 26.25 | 16.43 | 42.68 | 54.00 | -11.32 | AVG | 2 | 11650.092 | 38.31 | 16.44 | 54.75 | 74.00 | -19.25 | peak |
| No. | Frequency (MHz) | Reading (dBuV) | Factor (dB/m) | Level (dBuV/m) | Limit (dBuV/m) | Margin (dB) | Detector | | | | | | | | | | | | | | | | | | | | | | | | |
| 1 * | 11649.336 | 26.25 | 16.43 | 42.68 | 54.00 | -11.32 | AVG | | | | | | | | | | | | | | | | | | | | | | | | |
| 2 | 11650.092 | 38.31 | 16.44 | 54.75 | 74.00 | -19.25 | peak | | | | | | | | | | | | | | | | | | | | | | | | |
| Remarks: 1.Factor (dB/m) = Antenna Factor (dB/m)+Cable Factor (dB)-Pre-amplifier Factor 2.Margin value = Level -Limit value | | | | | | | | | | | | | | | | | | | | | | | | | | | | | | | |



| Ant No.: | Ant 1 + Ant 2 | | | | | | | | | | | | | | | | | | | | | | | | | | | | | | |
|--|--|----------------|---------------|----------------|----------------|-------------|----------|-----|-----------------|----------------|---------------|----------------|----------------|-------------|----------|-----|-----------|-------|-------|-------|-------|--------|-----|---|-----------|-------|-------|-------|-------|--------|------|
| Ant. Pol.: | Vertical | | | | | | | | | | | | | | | | | | | | | | | | | | | | | | |
| Test Mode: | TX 802.11n(HT20) Mode 5825MHz (U-NII-3) | | | | | | | | | | | | | | | | | | | | | | | | | | | | | | |
| Remark: | No report for the emission which more than 20 dB below the prescribed limit. | | | | | | | | | | | | | | | | | | | | | | | | | | | | | | |
| <table border="1"><thead><tr><th>No.</th><th>Frequency (MHz)</th><th>Reading (dBuV)</th><th>Factor (dB/m)</th><th>Level (dBuV/m)</th><th>Limit (dBuV/m)</th><th>Margin (dB)</th><th>Detector</th></tr></thead><tbody><tr><td>1 *</td><td>11649.632</td><td>26.25</td><td>16.43</td><td>42.68</td><td>54.00</td><td>-11.32</td><td>AVG</td></tr><tr><td>2</td><td>11649.868</td><td>38.05</td><td>16.43</td><td>54.48</td><td>74.00</td><td>-19.52</td><td>peak</td></tr></tbody></table> | | | | | | | | No. | Frequency (MHz) | Reading (dBuV) | Factor (dB/m) | Level (dBuV/m) | Limit (dBuV/m) | Margin (dB) | Detector | 1 * | 11649.632 | 26.25 | 16.43 | 42.68 | 54.00 | -11.32 | AVG | 2 | 11649.868 | 38.05 | 16.43 | 54.48 | 74.00 | -19.52 | peak |
| No. | Frequency (MHz) | Reading (dBuV) | Factor (dB/m) | Level (dBuV/m) | Limit (dBuV/m) | Margin (dB) | Detector | | | | | | | | | | | | | | | | | | | | | | | | |
| 1 * | 11649.632 | 26.25 | 16.43 | 42.68 | 54.00 | -11.32 | AVG | | | | | | | | | | | | | | | | | | | | | | | | |
| 2 | 11649.868 | 38.05 | 16.43 | 54.48 | 74.00 | -19.52 | peak | | | | | | | | | | | | | | | | | | | | | | | | |
| Remarks: 1. Factor (dB/m) = Antenna Factor (dB/m)+Cable Factor (dB)-Pre-amplifier Factor 2. Margin value = Level -Limit value | | | | | | | | | | | | | | | | | | | | | | | | | | | | | | | |



| Ant No.: | Ant 1 + Ant 2 | | | | | | | | | | | | | | | | | | | | | | | | | | | | | | |
|---|--|----------------|---------------|----------------|----------------|-------------|----------|-----|-----------------|----------------|---------------|----------------|----------------|-------------|----------|---|-----------|-------|-------|-------|-------|--------|------|-----|-----------|-------|-------|-------|-------|--------|-----|
| Ant. Pol.: | Horizontal | | | | | | | | | | | | | | | | | | | | | | | | | | | | | | |
| Test Mode: | TX 802.11n(HT40) Mode 5755MHz (U-NII-3) | | | | | | | | | | | | | | | | | | | | | | | | | | | | | | |
| Remark: | No report for the emission which more than 20 dB below the prescribed limit. | | | | | | | | | | | | | | | | | | | | | | | | | | | | | | |
| <table border="1"> <thead> <tr> <th>No.</th> <th>Frequency (MHz)</th> <th>Reading (dBuV)</th> <th>Factor (dB/m)</th> <th>Level (dBuV/m)</th> <th>Limit (dBuV/m)</th> <th>Margin (dB)</th> <th>Detector</th> </tr> </thead> <tbody> <tr> <td>1</td> <td>11509.824</td> <td>38.52</td> <td>16.28</td> <td>54.80</td> <td>74.00</td> <td>-19.20</td> <td>peak</td> </tr> <tr> <td>2 *</td> <td>11510.532</td> <td>26.06</td> <td>16.28</td> <td>42.34</td> <td>54.00</td> <td>-11.66</td> <td>AVG</td> </tr> </tbody> </table> | | | | | | | | No. | Frequency (MHz) | Reading (dBuV) | Factor (dB/m) | Level (dBuV/m) | Limit (dBuV/m) | Margin (dB) | Detector | 1 | 11509.824 | 38.52 | 16.28 | 54.80 | 74.00 | -19.20 | peak | 2 * | 11510.532 | 26.06 | 16.28 | 42.34 | 54.00 | -11.66 | AVG |
| No. | Frequency (MHz) | Reading (dBuV) | Factor (dB/m) | Level (dBuV/m) | Limit (dBuV/m) | Margin (dB) | Detector | | | | | | | | | | | | | | | | | | | | | | | | |
| 1 | 11509.824 | 38.52 | 16.28 | 54.80 | 74.00 | -19.20 | peak | | | | | | | | | | | | | | | | | | | | | | | | |
| 2 * | 11510.532 | 26.06 | 16.28 | 42.34 | 54.00 | -11.66 | AVG | | | | | | | | | | | | | | | | | | | | | | | | |
| Remarks: 1.Factor (dB/m) = Antenna Factor (dB/m)+Cable Factor (dB)-Pre-amplifier Factor 2.Margin value = Level -Limit value | | | | | | | | | | | | | | | | | | | | | | | | | | | | | | | |



| Ant No.: | Ant 1 + Ant 2 | | | | | | | | | | | | | | | | | | | | | | | | | | | | | | |
|---|--|----------------|---------------|----------------|----------------|-------------|----------|-----|-----------------|----------------|---------------|----------------|----------------|-------------|----------|-----|-----------|-------|-------|-------|-------|--------|-----|---|-----------|-------|-------|-------|-------|--------|------|
| Ant. Pol.: | Vertical | | | | | | | | | | | | | | | | | | | | | | | | | | | | | | |
| Test Mode: | TX 802.11n(HT40) Mode 5755MHz (U-NII-3) | | | | | | | | | | | | | | | | | | | | | | | | | | | | | | |
| Remark: | No report for the emission which more than 20 dB below the prescribed limit. | | | | | | | | | | | | | | | | | | | | | | | | | | | | | | |
| <table border="1"> <thead> <tr> <th>No.</th> <th>Frequency (MHz)</th> <th>Reading (dBuV)</th> <th>Factor (dB/m)</th> <th>Level (dBuV/m)</th> <th>Limit (dBuV/m)</th> <th>Margin (dB)</th> <th>Detector</th> </tr> </thead> <tbody> <tr> <td>1 *</td> <td>11509.602</td> <td>26.23</td> <td>16.28</td> <td>42.51</td> <td>54.00</td> <td>-11.49</td> <td>AVG</td> </tr> <tr> <td>2</td> <td>11510.508</td> <td>38.20</td> <td>16.28</td> <td>54.48</td> <td>74.00</td> <td>-19.52</td> <td>peak</td> </tr> </tbody> </table> | | | | | | | | No. | Frequency (MHz) | Reading (dBuV) | Factor (dB/m) | Level (dBuV/m) | Limit (dBuV/m) | Margin (dB) | Detector | 1 * | 11509.602 | 26.23 | 16.28 | 42.51 | 54.00 | -11.49 | AVG | 2 | 11510.508 | 38.20 | 16.28 | 54.48 | 74.00 | -19.52 | peak |
| No. | Frequency (MHz) | Reading (dBuV) | Factor (dB/m) | Level (dBuV/m) | Limit (dBuV/m) | Margin (dB) | Detector | | | | | | | | | | | | | | | | | | | | | | | | |
| 1 * | 11509.602 | 26.23 | 16.28 | 42.51 | 54.00 | -11.49 | AVG | | | | | | | | | | | | | | | | | | | | | | | | |
| 2 | 11510.508 | 38.20 | 16.28 | 54.48 | 74.00 | -19.52 | peak | | | | | | | | | | | | | | | | | | | | | | | | |
| Remarks: 1. Factor (dB/m) = Antenna Factor (dB/m)+Cable Factor (dB)-Pre-amplifier Factor 2. Margin value = Level -Limit value | | | | | | | | | | | | | | | | | | | | | | | | | | | | | | | |



| Ant No.: | Ant 1 + Ant 2 | | | | | | | | | | | | | | | | | | | | | | | | | | | | | | |
|---|--|----------------|---------------|----------------|----------------|-------------|----------|-----|-----------------|----------------|---------------|----------------|----------------|-------------|----------|---|-----------|-------|-------|-------|-------|--------|------|-----|-----------|-------|-------|-------|-------|--------|-----|
| Ant. Pol.: | Horizontal | | | | | | | | | | | | | | | | | | | | | | | | | | | | | | |
| Test Mode: | TX 802.11n(HT40) Mode 5795MHz (U-NII-3) | | | | | | | | | | | | | | | | | | | | | | | | | | | | | | |
| Remark: | No report for the emission which more than 20 dB below the prescribed limit. | | | | | | | | | | | | | | | | | | | | | | | | | | | | | | |
| <table border="1"> <thead> <tr> <th>No.</th> <th>Frequency (MHz)</th> <th>Reading (dBuV)</th> <th>Factor (dB/m)</th> <th>Level (dBuV/m)</th> <th>Limit (dBuV/m)</th> <th>Margin (dB)</th> <th>Detector</th> </tr> </thead> <tbody> <tr> <td>1</td> <td>11590.240</td> <td>37.76</td> <td>16.37</td> <td>54.13</td> <td>74.00</td> <td>-19.87</td> <td>peak</td> </tr> <tr> <td>2 *</td> <td>11590.536</td> <td>26.17</td> <td>16.37</td> <td>42.54</td> <td>54.00</td> <td>-11.46</td> <td>AVG</td> </tr> </tbody> </table> | | | | | | | | No. | Frequency (MHz) | Reading (dBuV) | Factor (dB/m) | Level (dBuV/m) | Limit (dBuV/m) | Margin (dB) | Detector | 1 | 11590.240 | 37.76 | 16.37 | 54.13 | 74.00 | -19.87 | peak | 2 * | 11590.536 | 26.17 | 16.37 | 42.54 | 54.00 | -11.46 | AVG |
| No. | Frequency (MHz) | Reading (dBuV) | Factor (dB/m) | Level (dBuV/m) | Limit (dBuV/m) | Margin (dB) | Detector | | | | | | | | | | | | | | | | | | | | | | | | |
| 1 | 11590.240 | 37.76 | 16.37 | 54.13 | 74.00 | -19.87 | peak | | | | | | | | | | | | | | | | | | | | | | | | |
| 2 * | 11590.536 | 26.17 | 16.37 | 42.54 | 54.00 | -11.46 | AVG | | | | | | | | | | | | | | | | | | | | | | | | |
| Remarks: 1.Factor (dB/m) = Antenna Factor (dB/m)+Cable Factor (dB)-Pre-amplifier Factor 2.Margin value = Level -Limit value | | | | | | | | | | | | | | | | | | | | | | | | | | | | | | | |



| Ant No.: | Ant 1 + Ant 2 | | | | | | | | | | | | | | | | | | | | | | | | | | | | | | |
|---|--|----------------|---------------|----------------|----------------|-------------|----------|-----|-----------------|----------------|---------------|----------------|----------------|-------------|----------|---|-----------|-------|-------|-------|-------|--------|------|-----|-----------|-------|-------|-------|-------|--------|-----|
| Ant. Pol.: | Vertical | | | | | | | | | | | | | | | | | | | | | | | | | | | | | | |
| Test Mode: | TX 802.11n(HT40) Mode 5795MHz (U-NII-3) | | | | | | | | | | | | | | | | | | | | | | | | | | | | | | |
| Remark: | No report for the emission which more than 20 dB below the prescribed limit. | | | | | | | | | | | | | | | | | | | | | | | | | | | | | | |
| <table border="1"> <thead> <tr> <th>No.</th> <th>Frequency (MHz)</th> <th>Reading (dBuV)</th> <th>Factor (dB/m)</th> <th>Level (dBuV/m)</th> <th>Limit (dBuV/m)</th> <th>Margin (dB)</th> <th>Detector</th> </tr> </thead> <tbody> <tr> <td>1</td> <td>11589.242</td> <td>38.18</td> <td>16.37</td> <td>54.55</td> <td>74.00</td> <td>-19.45</td> <td>peak</td> </tr> <tr> <td>2 *</td> <td>11590.022</td> <td>25.99</td> <td>16.37</td> <td>42.36</td> <td>54.00</td> <td>-11.64</td> <td>AVG</td> </tr> </tbody> </table> | | | | | | | | No. | Frequency (MHz) | Reading (dBuV) | Factor (dB/m) | Level (dBuV/m) | Limit (dBuV/m) | Margin (dB) | Detector | 1 | 11589.242 | 38.18 | 16.37 | 54.55 | 74.00 | -19.45 | peak | 2 * | 11590.022 | 25.99 | 16.37 | 42.36 | 54.00 | -11.64 | AVG |
| No. | Frequency (MHz) | Reading (dBuV) | Factor (dB/m) | Level (dBuV/m) | Limit (dBuV/m) | Margin (dB) | Detector | | | | | | | | | | | | | | | | | | | | | | | | |
| 1 | 11589.242 | 38.18 | 16.37 | 54.55 | 74.00 | -19.45 | peak | | | | | | | | | | | | | | | | | | | | | | | | |
| 2 * | 11590.022 | 25.99 | 16.37 | 42.36 | 54.00 | -11.64 | AVG | | | | | | | | | | | | | | | | | | | | | | | | |
| Remarks: 1. Factor (dB/m) = Antenna Factor (dB/m)+Cable Factor (dB)-Pre-amplifier Factor 2. Margin value = Level -Limit value | | | | | | | | | | | | | | | | | | | | | | | | | | | | | | | |

3.3. Band Edge Emissions

Limit

Limits of unwanted emission out of the restricted bands

FCC CFR Title 47 Part 15 Subpart C Section 15.407(b)/ RSS-247 6.2.1.2 & RSS-247 6.2.4.2

| Frequency (MHz) | EIRP Limits (dBm) | Equivalent Field Strength at 3m (dBuV/m) |
|-----------------|-------------------|--|
| 5150~5250 | -27 | 68.2 |
| 5250~5350 | -27 | 68.2 |
| 5470~5725 | -27 | 68.2 |
| 5725~5825 | -27(Note 2) | 68.2 |
| | 10(Note 2) | 105.2 |
| | 15.6(Note 2) | 110.8 |
| | 27(Note 2) | 122.2 |

Note: 1. The following formula is used to convert the equipment isotropic radiated power (eirp) to field strength:

$$\text{strength: } E = \frac{1000000\sqrt{30P}}{3} \text{ uV/m, where P is the eirp (Watts)}$$

2. According to FCC 16-24, All emissions shall be limited to a level of -27 dBm/MHz at 75 MHz or more above or below the band edge increasing linearly to 10 dBm/MHz at 25 MHz above or below the band edge, and from 25MHz above or below the band edge increasing linearly to a level of 15.6 dBm/MHz at 5 MHz above or below the band edge, and from 5 MHz above or below the band edge increasing linearly to a level of 27dBm/MHz at the band edge.

Test Configuration

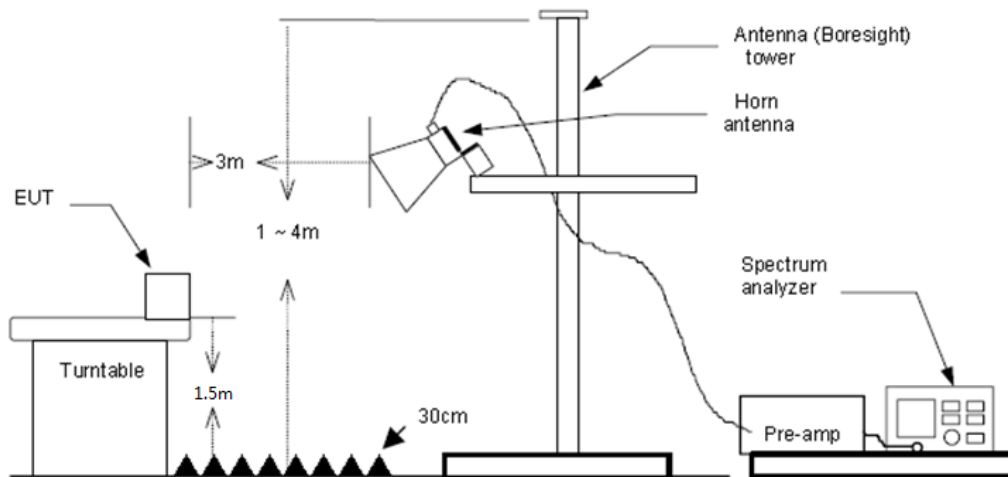

Test Procedure

1. The EUT was setup and tested according to ANSI C63.10:2013 requirements.
2. The EUT is placed on a turn table which is 1.5 meter above ground. The turn table is rotated 360 degrees to determine the position of the maximum emission level.
3. The EUT was positioned such that the distance from antenna to the EUT was 3 meters.
4. The antenna is scanned from 1 meter to 4 meters to find out the maximum emission level. This is repeated for both horizontal and vertical polarization of the antenna. In order to find the maximum emission, all of the interface cables were manipulated according to ANSI C63.10:2013 on radiated measurement.



- 5. The receiver set as follow:
 RBW=1MHz, VBW=3MHz PEAK detector for Peak value.
 RBW=1MHz, VBW see note 1 with Peak Detector for Average Value.

Note 1: For measurements above 1 GHz the resolution bandwidth is set to 1 MHz, then the video bandwidth is set to 3 MHz for peak measurements and 1 MHz resolution bandwidth with 1/T video bandwidth with peak detector for average measurements. For the Duty Cycle please refer to clause Appendix E: Duty Cycle

Test Mode

Please refer to the clause 2.4.

Test Results

Pre-scan all antenna, only show the test data for worse case antenna on the test report.

| | |
|-------------------|--|
| Ant No.: | Ant 1 |
| Ant. Pol.: | Horizontal |
| Test Mode: | TX 802.11a Mode 5180MHz (U-NII-1) |
| Remark: | No report for the emission which more than 20 dB below the prescribed limit. |

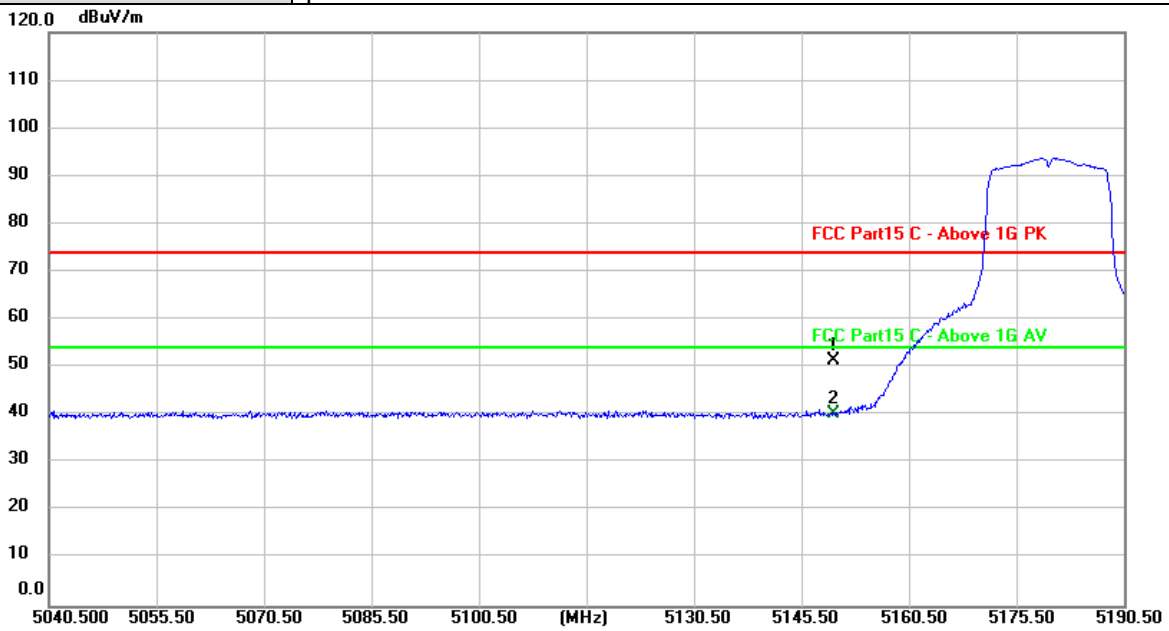

| No. | Frequency (MHz) | Reading (dBuV) | Factor (dB/m) | Level (dBuV/m) | Limit (dBuV/m) | Margin (dB) | Detector |
|-----|-----------------|----------------|---------------|----------------|----------------|-------------|----------|
| 1 | 5150.000 | 14.22 | 37.15 | 51.37 | 74.00 | -22.63 | peak |
| 2 * | 5150.000 | 3.21 | 37.15 | 40.36 | 54.00 | -13.64 | AVG |

Remarks:

- 1. Factor (dB/m) = Antenna Factor (dB/m)+Cable Factor (dB)-Pre-amplifier Factor
- 2. Margin value = Level -Limit value





| | |
|------------|--|
| Ant No.: | Ant 1 |
| Ant. Pol.: | Vertical |
| Test Mode: | TX 802.11a Mode 5180MHz (U-NII-1) |
| Remark: | No report for the emission which more than 20 dB below the prescribed limit. |

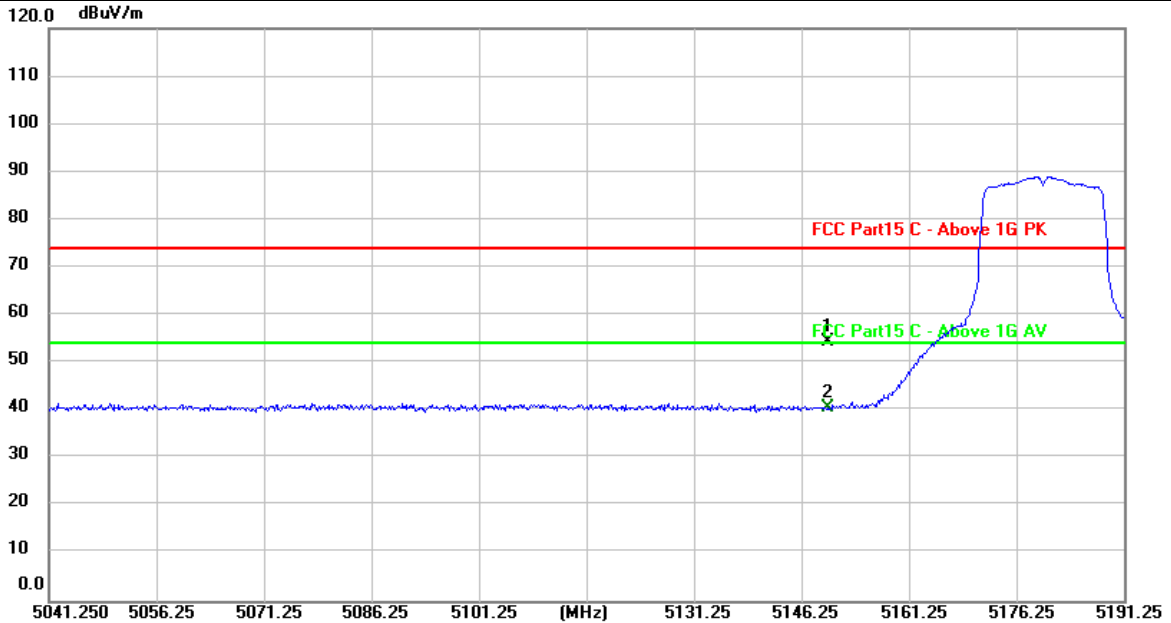

| No. | Frequency (MHz) | Reading (dBuV) | Factor (dB/m) | Level (dBuV/m) | Limit (dBuV/m) | Margin (dB) | Detector |
|-----|-----------------|----------------|---------------|----------------|----------------|-------------|----------|
| 1 | 5150.000 | 17.44 | 37.15 | 54.59 | 74.00 | -19.41 | peak |
| 2 * | 5150.000 | 3.53 | 37.15 | 40.68 | 54.00 | -13.32 | AVG |

Remarks:

1. Factor (dB/m) = Antenna Factor (dB/m)+Cable Factor (dB)-Pre-amplifier Factor

2. Margin value = Level -Limit value



| | |
|-------------------|--|
| Ant No.: | Ant 1 |
| Ant. Pol.: | Horizontal |
| Test Mode: | TX 802.11a Mode 5240MHz (U-NII-1) |
| Remark: | No report for the emission which more than 20 dB below the prescribed limit. |

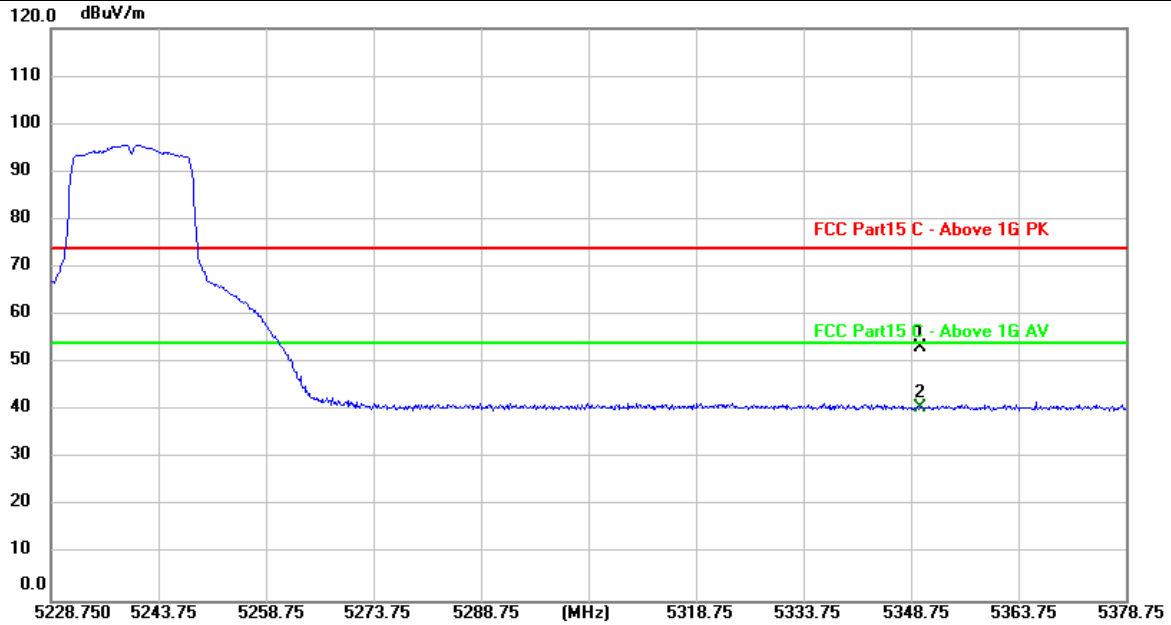

| No. | Frequency (MHz) | Reading (dBuV) | Factor (dB/m) | Level (dBuV/m) | Limit (dBuV/m) | Margin (dB) | Detector |
|-----|-----------------|----------------|---------------|----------------|----------------|-------------|----------|
| 1 | 5350.000 | 15.72 | 37.41 | 53.13 | 74.00 | -20.87 | peak |
| 2 * | 5350.000 | 3.29 | 37.41 | 40.70 | 54.00 | -13.30 | AVG |

Remarks:

1. Factor (dB/m) = Antenna Factor (dB/m)+Cable Factor (dB)-Pre-amplifier Factor
2. Margin value = Level -Limit value



| | |
|-------------------|--|
| Ant No.: | Ant 1 |
| Ant. Pol.: | Vertical |
| Test Mode: | TX 802.11a Mode 5240MHz (U-NII-1) |
| Remark: | No report for the emission which more than 20 dB below the prescribed limit. |

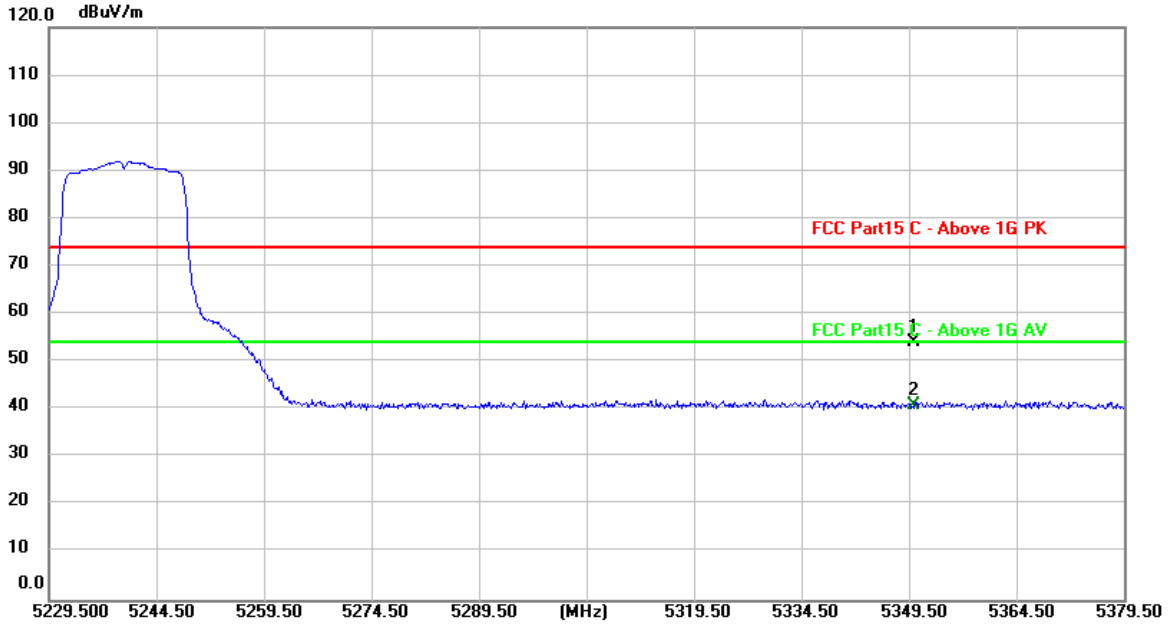

| No. | Frequency (MHz) | Reading (dBuV) | Factor (dB/m) | Level (dBuV/m) | Limit (dBuV/m) | Margin (dB) | Detector |
|-----|-----------------|----------------|---------------|----------------|----------------|-------------|----------|
| 1 | 5350.000 | 16.76 | 37.41 | 54.17 | 74.00 | -19.83 | peak |
| 2 * | 5350.000 | 3.43 | 37.41 | 40.84 | 54.00 | -13.16 | AVG |

Remarks:

- Factor (dB/m) = Antenna Factor (dB/m)+Cable Factor (dB)-Pre-amplifier Factor
- Margin value = Level -Limit value



| | |
|------------|--|
| Ant No.: | Ant 1 + Ant 2 |
| Ant. Pol.: | Horizontal |
| Test Mode: | TX 802.11n(HT20) Mode 5180MHz (U-NII-1) |
| Remark: | No report for the emission which more than 20 dB below the prescribed limit. |

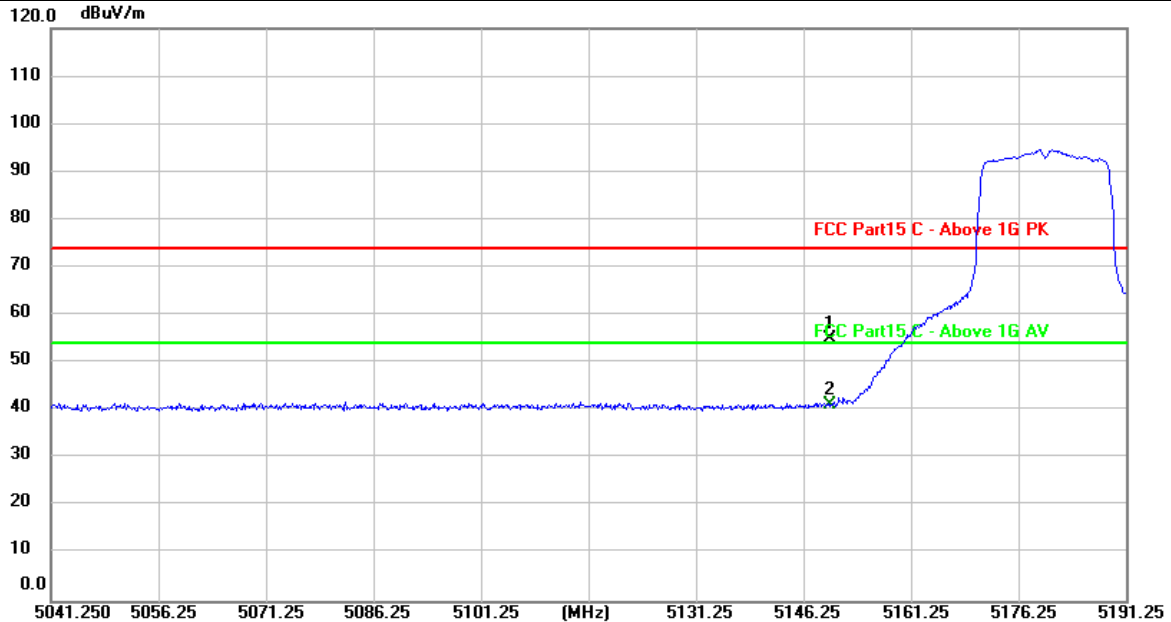

| No. | Frequency (MHz) | Reading (dBuV) | Factor (dB/m) | Level (dBuV/m) | Limit (dBuV/m) | Margin (dB) | Detector |
|-----|-----------------|----------------|---------------|----------------|----------------|-------------|----------|
| 1 | 5150.000 | 17.79 | 37.15 | 54.94 | 74.00 | -19.06 | peak |
| 2 * | 5150.000 | 4.03 | 37.15 | 41.18 | 54.00 | -12.82 | AVG |

Remarks:

1. Factor (dB/m) = Antenna Factor (dB/m)+Cable Factor (dB)-Pre-amplifier Factor
2. Margin value = Level -Limit value



| | |
|-------------------|--|
| Ant No.: | Ant 1 + Ant 2 |
| Ant. Pol.: | Vertical |
| Test Mode: | TX 802.11n(HT20) Mode 5180MHz (U-NII-1) |
| Remark: | No report for the emission which more than 20 dB below the prescribed limit. |

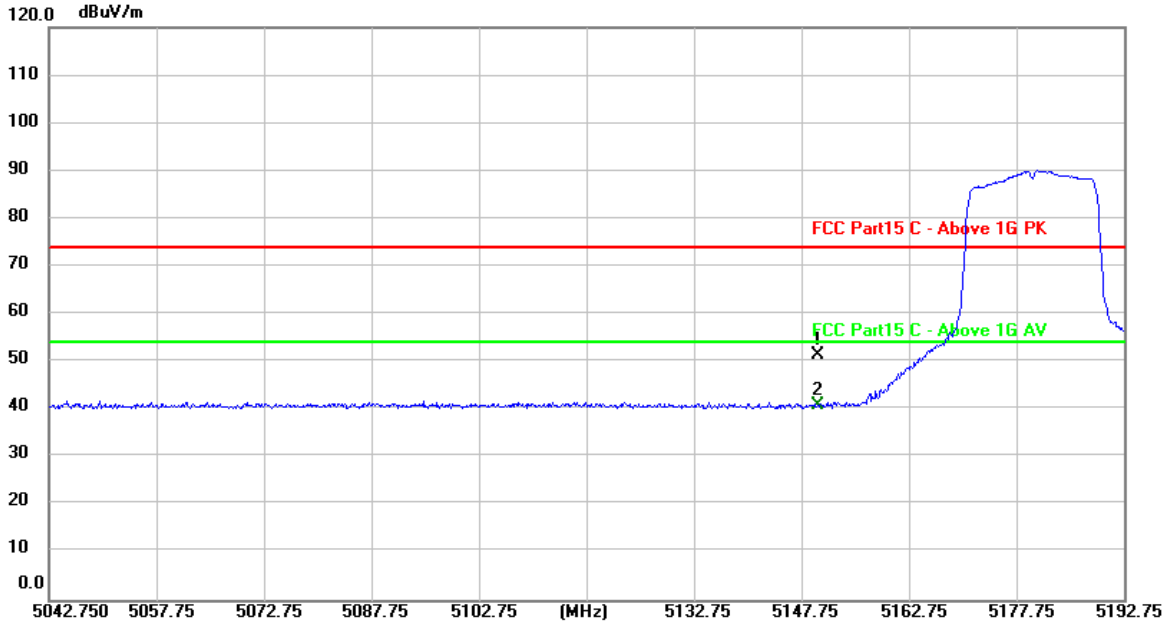

| No. | Frequency (MHz) | Reading (dBuV) | Factor (dB/m) | Level (dBuV/m) | Limit (dBuV/m) | Margin (dB) | Detector |
|-----|-----------------|----------------|---------------|----------------|----------------|-------------|----------|
| 1 | 5150.000 | 14.21 | 37.15 | 51.36 | 74.00 | -22.64 | peak |
| 2 * | 5150.000 | 3.86 | 37.15 | 41.01 | 54.00 | -12.99 | AVG |

Remarks:

1. Factor (dB/m) = Antenna Factor (dB/m)+Cable Factor (dB)-Pre-amplifier Factor
2. Margin value = Level -Limit value



| | |
|-------------------|--|
| Ant No.: | Ant 1 + Ant 2 |
| Ant. Pol.: | Horizontal |
| Test Mode: | TX 802.11n(HT20) Mode 5240MHz (U-NII-1) |
| Remark: | No report for the emission which more than 20 dB below the prescribed limit. |

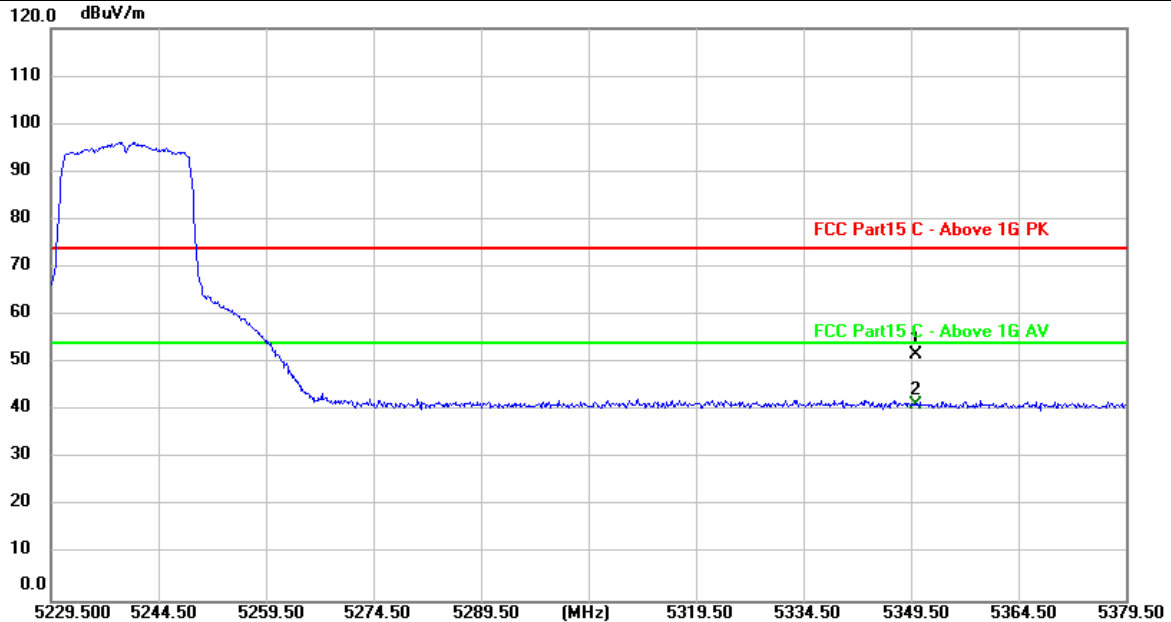

| No. | Frequency (MHz) | Reading (dBuV) | Factor (dB/m) | Level (dBuV/m) | Limit (dBuV/m) | Margin (dB) | Detector |
|-----|-----------------|----------------|---------------|----------------|----------------|-------------|----------|
| 1 | 5350.000 | 14.46 | 37.41 | 51.87 | 74.00 | -22.13 | peak |
| 2 * | 5350.000 | 3.99 | 37.41 | 41.40 | 54.00 | -12.60 | AVG |

Remarks:

- Factor (dB/m) = Antenna Factor (dB/m)+Cable Factor (dB)-Pre-amplifier Factor
- Margin value = Level -Limit value



| | |
|-------------------|--|
| Ant No.: | Ant 1 + Ant 2 |
| Ant. Pol.: | Vertical |
| Test Mode: | TX 802.11n(HT20) Mode 5240MHz (U-NII-1) |
| Remark: | No report for the emission which more than 20 dB below the prescribed limit. |

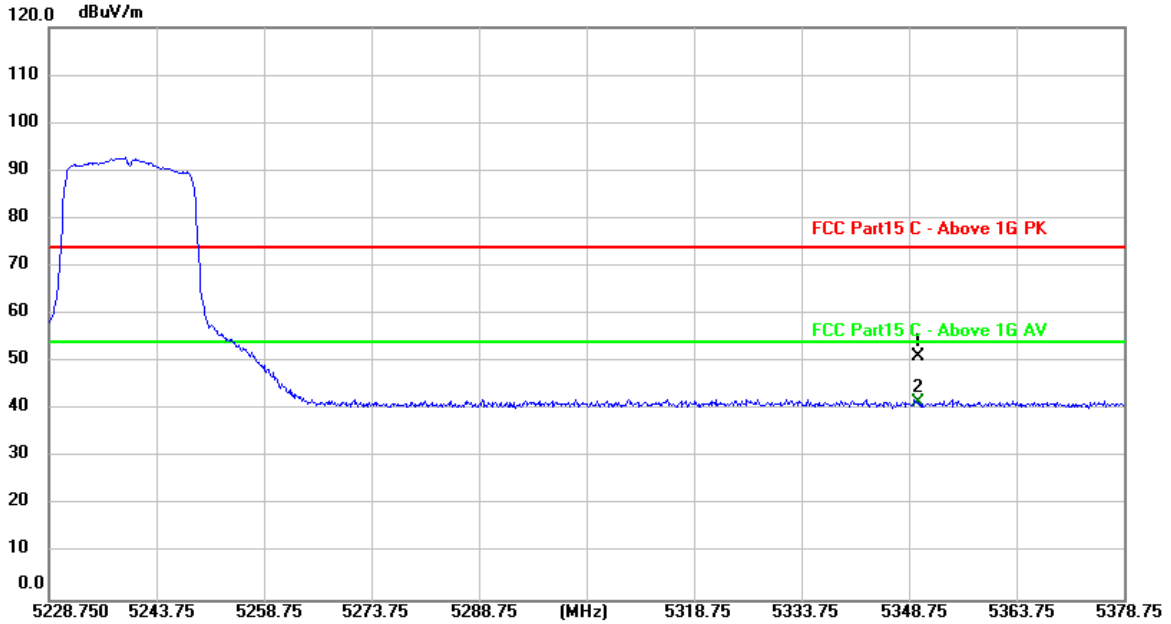

| No. | Frequency (MHz) | Reading (dBuV) | Factor (dB/m) | Level (dBuV/m) | Limit (dBuV/m) | Margin (dB) | Detector |
|-----|-----------------|----------------|---------------|----------------|----------------|-------------|----------|
| 1 | 5350.000 | 13.87 | 37.41 | 51.28 | 74.00 | -22.72 | peak |
| 2 * | 5350.000 | 4.12 | 37.41 | 41.53 | 54.00 | -12.47 | AVG |

Remarks:

- Factor (dB/m) = Antenna Factor (dB/m)+Cable Factor (dB)-Pre-amplifier Factor
- Margin value = Level -Limit value



| | |
|-------------------|--|
| Ant No.: | Ant 1 + Ant 2 |
| Ant. Pol.: | Horizontal |
| Test Mode: | TX 802.11n(HT40) Mode 5190MHz (U-NII-1) |
| Remark: | No report for the emission which more than 20 dB below the prescribed limit. |

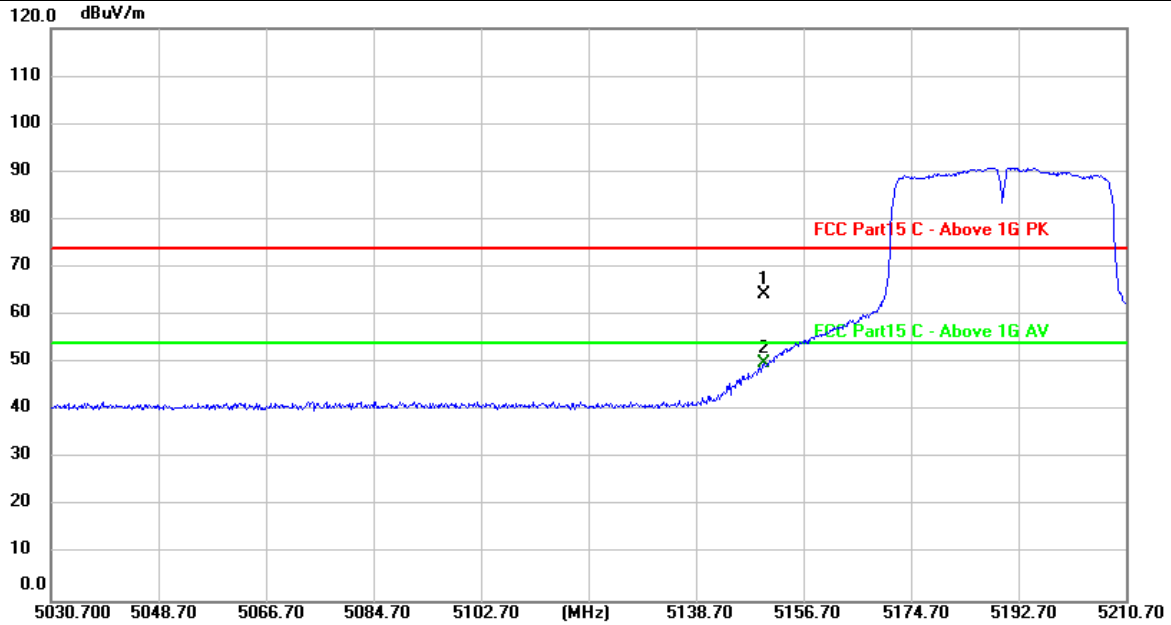

| No. | Frequency (MHz) | Reading (dBuV) | Factor (dB/m) | Level (dBuV/m) | Limit (dBuV/m) | Margin (dB) | Detector |
|-----|-----------------|----------------|---------------|----------------|----------------|-------------|----------|
| 1 | 5150.000 | 27.23 | 37.15 | 64.38 | 74.00 | -9.62 | peak |
| 2 * | 5150.000 | 12.69 | 37.15 | 49.84 | 54.00 | -4.16 | AVG |

Remarks:

- Factor (dB/m) = Antenna Factor (dB/m)+Cable Factor (dB)-Pre-amplifier Factor
- Margin value = Level -Limit value



| | |
|------------|--|
| Ant No.: | Ant 1 + Ant 2 |
| Ant. Pol.: | Vertical |
| Test Mode: | TX 802.11n(HT40) Mode 5190MHz (U-NII-1) |
| Remark: | No report for the emission which more than 20 dB below the prescribed limit. |

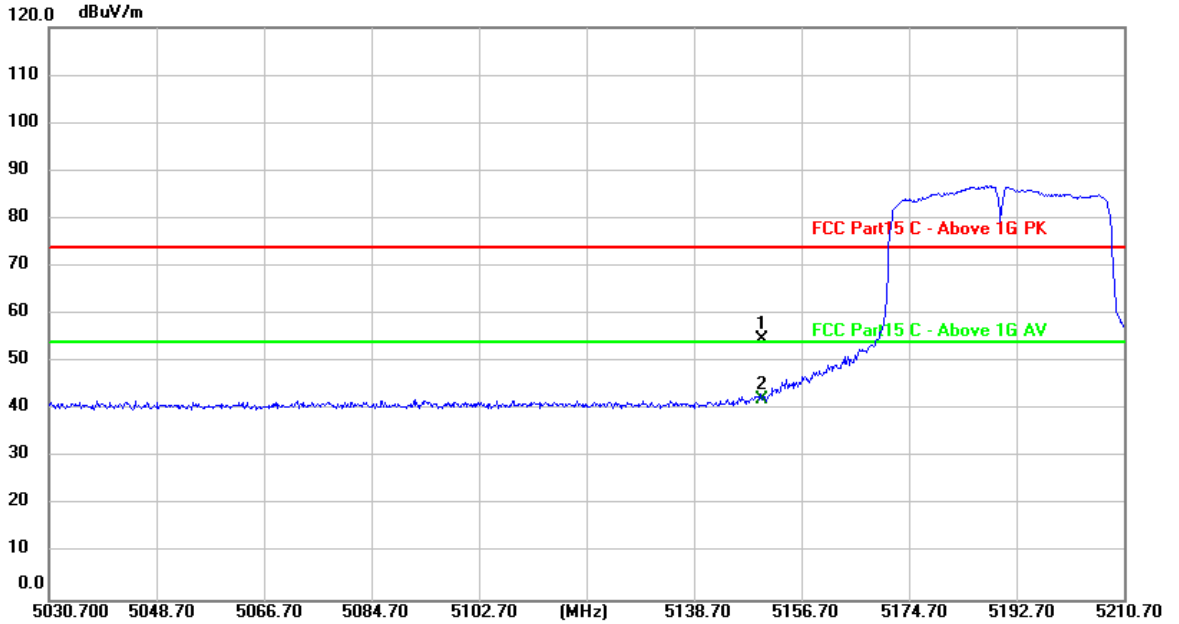

| No. | Frequency (MHz) | Reading (dBuV) | Factor (dB/m) | Level (dBuV/m) | Limit (dBuV/m) | Margin (dB) | Detector |
|-----|-----------------|----------------|---------------|----------------|----------------|-------------|----------|
| 1 | 5150.000 | 17.50 | 37.15 | 54.65 | 74.00 | -19.35 | peak |
| 2 * | 5150.000 | 5.07 | 37.15 | 42.22 | 54.00 | -11.78 | AVG |

Remarks:

- 1. Factor (dB/m) = Antenna Factor (dB/m)+Cable Factor (dB)-Pre-amplifier Factor
- 2. Margin value = Level -Limit value



| | |
|-------------------|--|
| Ant No.: | Ant 1 + Ant 2 |
| Ant. Pol.: | Horizontal |
| Test Mode: | TX 802.11n(HT40) Mode 5230MHz (U-NII-1) |
| Remark: | No report for the emission which more than 20 dB below the prescribed limit. |

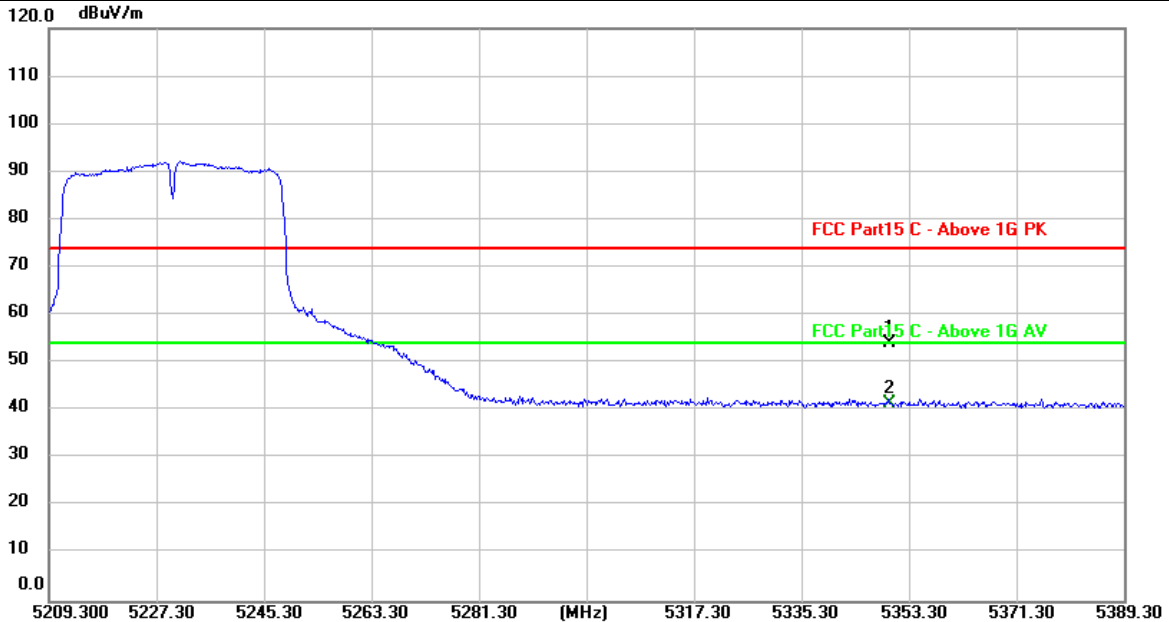

| No. | Frequency (MHz) | Reading (dBuV) | Factor (dB/m) | Level (dBuV/m) | Limit (dBuV/m) | Margin (dB) | Detector |
|-----|-----------------|----------------|---------------|----------------|----------------|-------------|----------|
| 1 | 5350.000 | 16.68 | 37.41 | 54.09 | 74.00 | -19.91 | peak |
| 2 * | 5350.000 | 4.07 | 37.41 | 41.48 | 54.00 | -12.52 | AVG |

Remarks:

- Factor (dB/m) = Antenna Factor (dB/m)+Cable Factor (dB)-Pre-amplifier Factor
- Margin value = Level -Limit value



| | |
|-------------------|--|
| Ant No.: | Ant 1 + Ant 2 |
| Ant. Pol.: | Vertical |
| Test Mode: | TX 802.11n(HT40) Mode 5230MHz (U-NII-1) |
| Remark: | No report for the emission which more than 20 dB below the prescribed limit. |

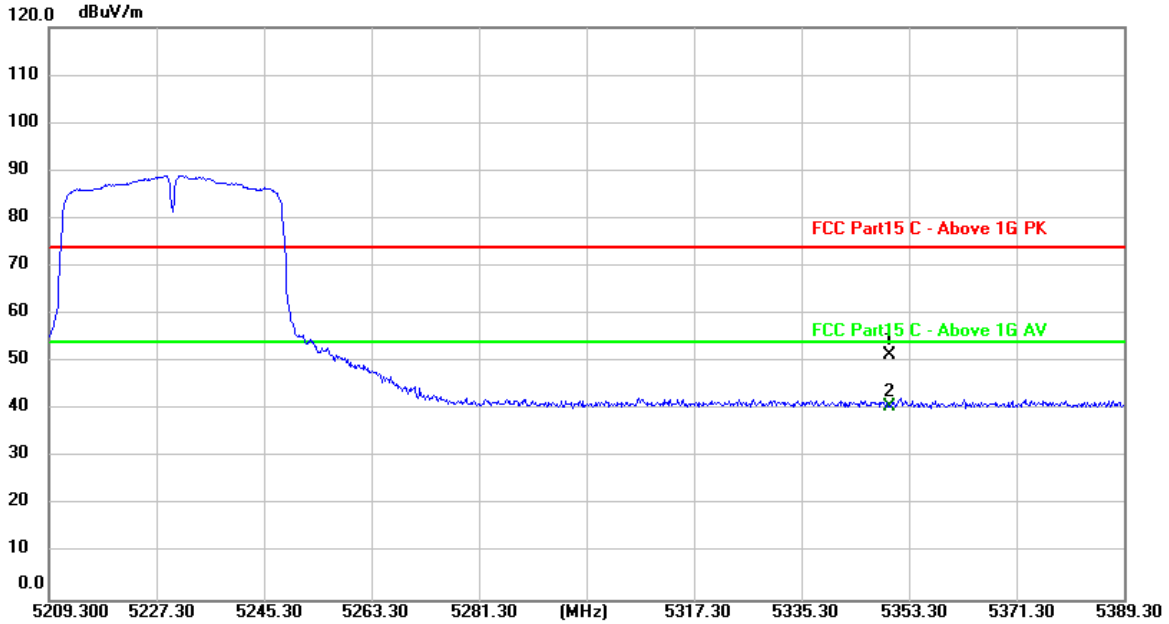

| No. | Frequency (MHz) | Reading (dBuV) | Factor (dB/m) | Level (dBuV/m) | Limit (dBuV/m) | Margin (dB) | Detector |
|-----|-----------------|----------------|---------------|----------------|----------------|-------------|----------|
| 1 | 5350.000 | 14.01 | 37.41 | 51.42 | 74.00 | -22.58 | peak |
| 2 * | 5350.000 | 3.39 | 37.41 | 40.80 | 54.00 | -13.20 | AVG |

Remarks:

- Factor (dB/m) = Antenna Factor (dB/m)+Cable Factor (dB)-Pre-amplifier Factor
- Margin value = Level -Limit value



| | |
|-------------------|--|
| Ant No.: | Ant 1 |
| Ant. Pol.: | Horizontal |
| Test Mode: | TX 802.11a Mode 5745MHz (U-NII-3) |
| Remark: | No report for the emission which more than 20 dB below the prescribed limit. |

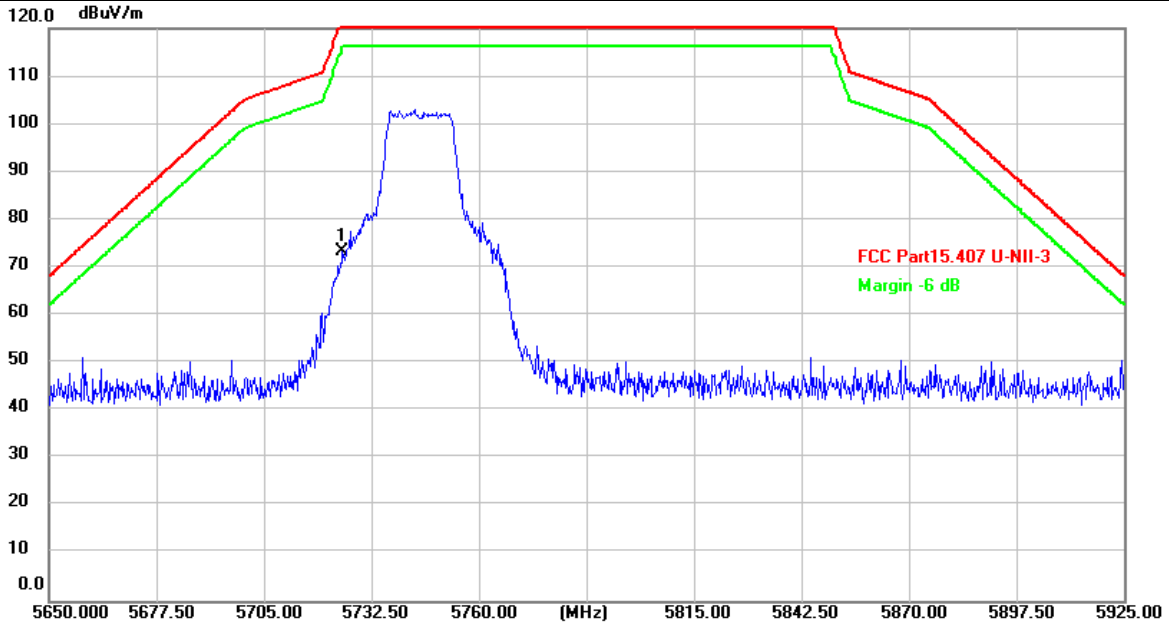

| No. | Frequency (MHz) | Reading (dBuV) | Factor (dB/m) | Level (dBuV/m) | Limit (dBuV/m) | Margin (dB) | Detector |
|-----|-----------------|----------------|---------------|----------------|----------------|-------------|----------|
| 1 * | 5725.000 | 35.23 | 38.07 | 73.30 | 122.20 | -48.90 | peak |

Remarks:

1. Factor (dB/m) = Antenna Factor (dB/m)+Cable Factor (dB)-Pre-amplifier Factor
2. Margin value = Level -Limit value



| | |
|------------|--|
| Ant No.: | Ant 1 |
| Ant. Pol.: | Vertical |
| Test Mode: | TX 802.11a Mode 5745MHz (U-NII-3) |
| Remark: | No report for the emission which more than 20 dB below the prescribed limit. |

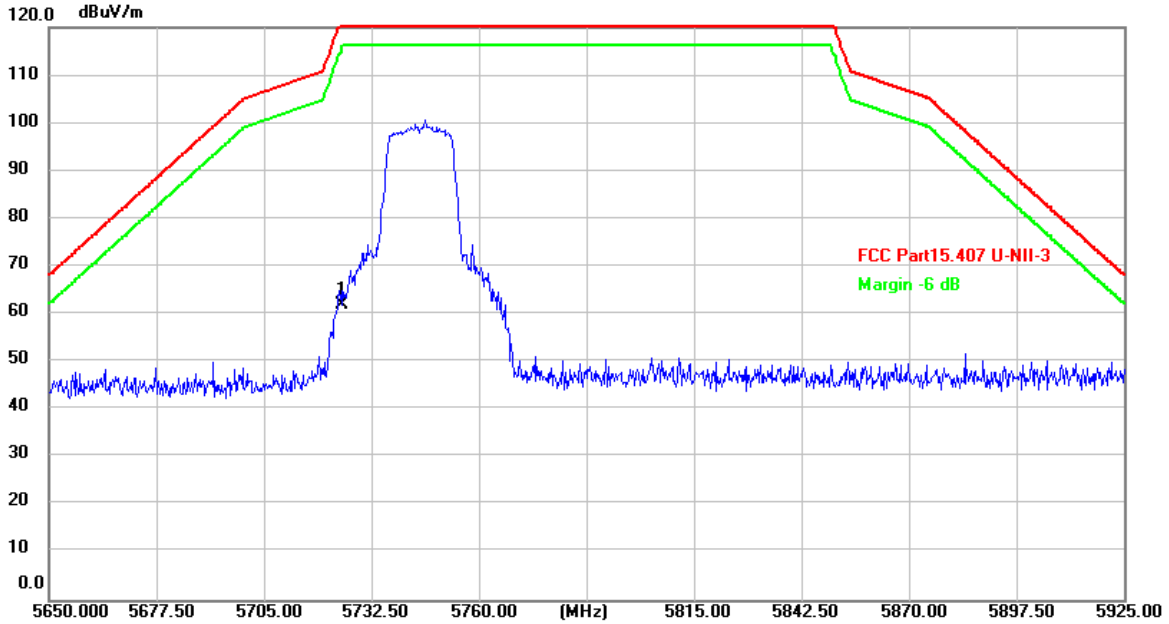

| No. | Frequency (MHz) | Reading (dBuV) | Factor (dB/m) | Level (dBuV/m) | Limit (dBuV/m) | Margin (dB) | Detector |
|-----|-----------------|----------------|---------------|----------------|----------------|-------------|----------|
| 1 * | 5725.000 | 23.84 | 38.07 | 61.91 | 122.20 | -60.29 | peak |

Remarks:

- Factor (dB/m) = Antenna Factor (dB/m)+Cable Factor (dB)-Pre-amplifier Factor
- Margin value = Level -Limit value



| | |
|-------------------|--|
| Ant No.: | Ant 1 |
| Ant. Pol.: | Horizontal |
| Test Mode: | TX 802.11a Mode 5825MHz (U-NII-3) |
| Remark: | No report for the emission which more than 20 dB below the prescribed limit. |

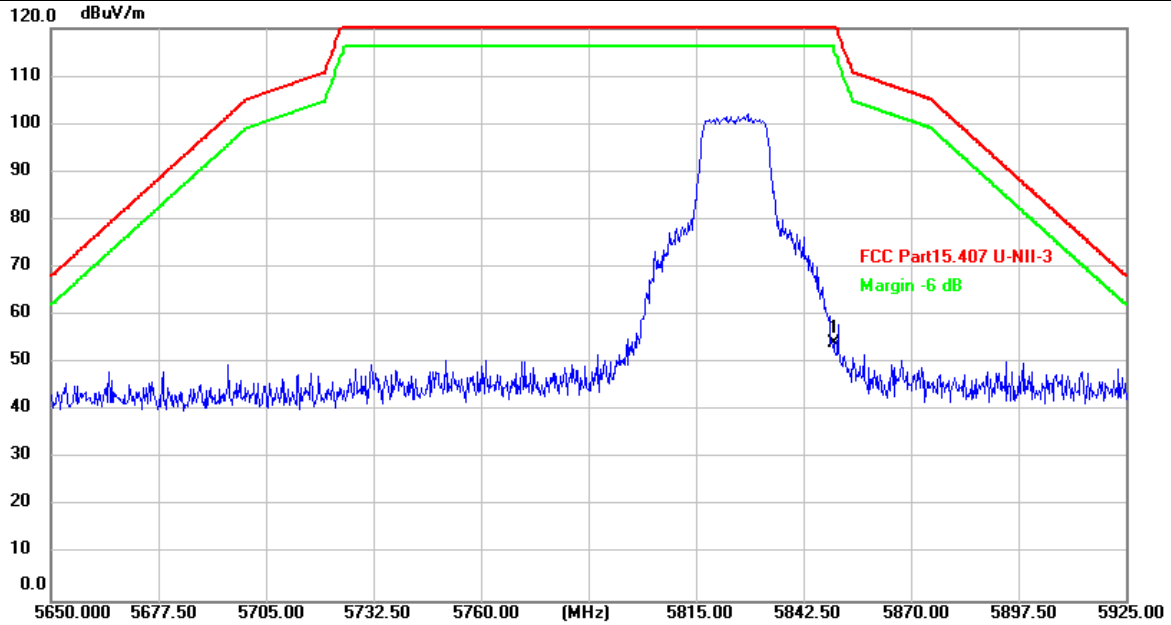

| No. | Frequency (MHz) | Reading (dBuV) | Factor (dB/m) | Level (dBuV/m) | Limit (dBuV/m) | Margin (dB) | Detector |
|-----|-----------------|----------------|---------------|----------------|----------------|-------------|----------|
| 1 * | 5850.000 | 15.76 | 38.33 | 54.09 | 122.20 | -68.11 | peak |

Remarks:

- Factor (dB/m) = Antenna Factor (dB/m)+Cable Factor (dB)-Pre-amplifier Factor
- Margin value = Level -Limit value



| | |
|------------|--|
| Ant No.: | Ant 1 |
| Ant. Pol.: | Vertical |
| Test Mode: | TX 802.11a Mode 5825MHz (U-NII-3) |
| Remark: | No report for the emission which more than 20 dB below the prescribed limit. |

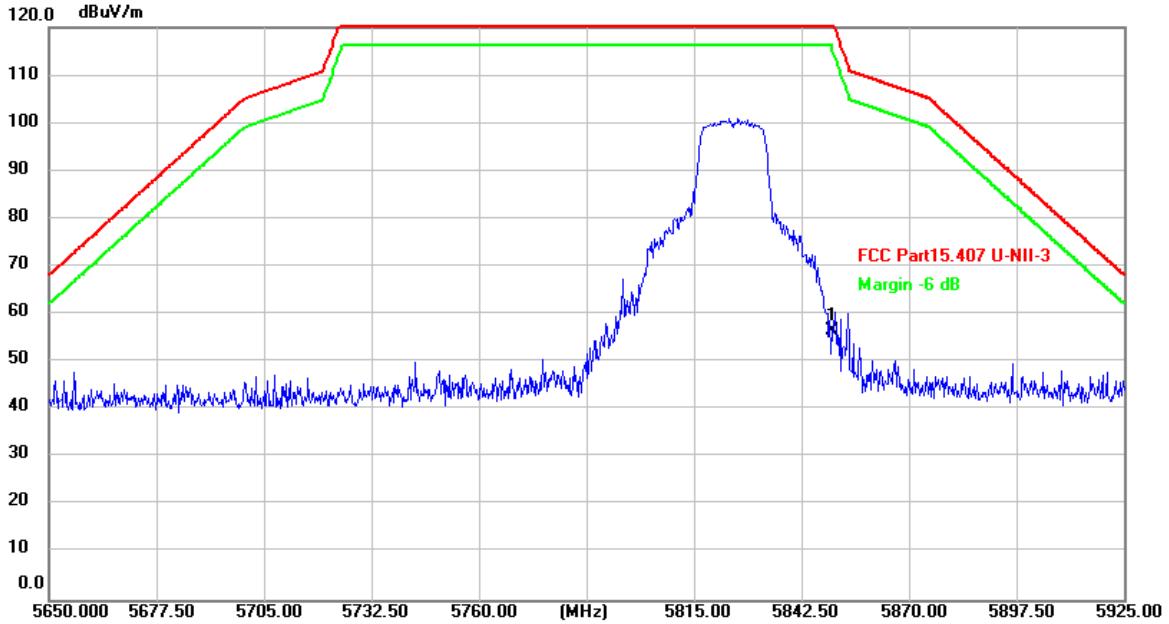

| No. | Frequency (MHz) | Reading (dBuV) | Factor (dB/m) | Level (dBuV/m) | Limit (dBuV/m) | Margin (dB) | Detector |
|-----|-----------------|----------------|---------------|----------------|----------------|-------------|----------|
| 1 * | 5850.000 | 18.08 | 38.33 | 56.41 | 122.20 | -65.79 | peak |

Remarks:

- Factor (dB/m) = Antenna Factor (dB/m)+Cable Factor (dB)-Pre-amplifier Factor
- Margin value = Level -Limit value



| | |
|-------------------|--|
| Ant No.: | Ant 1 + Ant 2 |
| Ant. Pol.: | Horizontal |
| Test Mode: | TX 802.11n(HT20) Mode 5745MHz (U-NII-3) |
| Remark: | No report for the emission which more than 20 dB below the prescribed limit. |

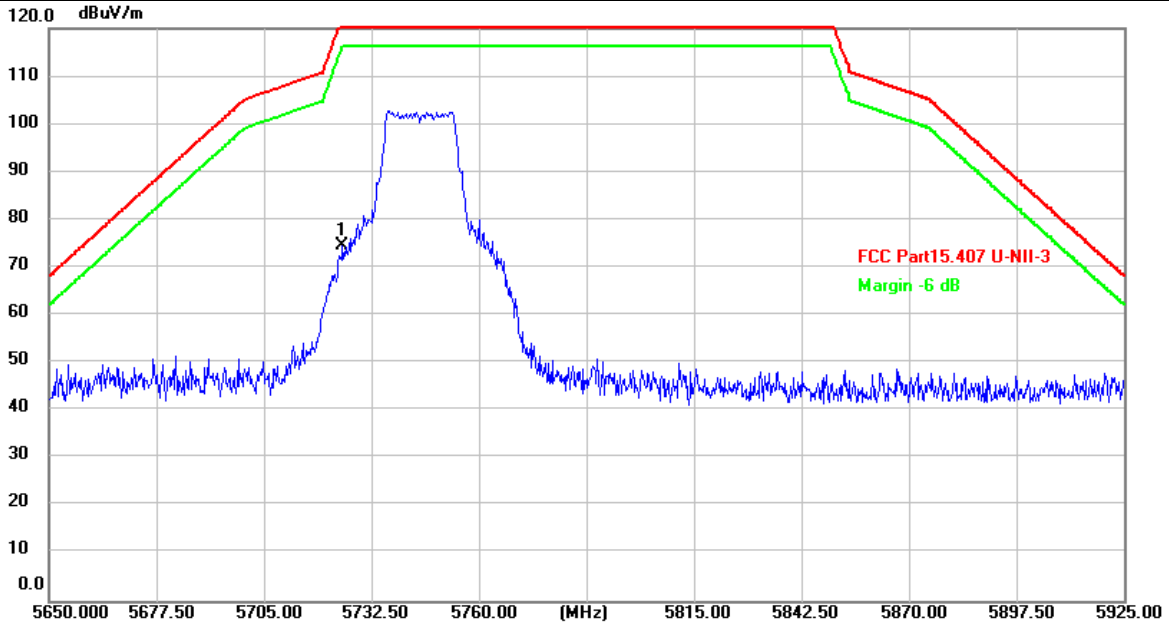

| No. | Frequency (MHz) | Reading (dBuV) | Factor (dB/m) | Level (dBuV/m) | Limit (dBuV/m) | Margin (dB) | Detector |
|-----|-----------------|----------------|---------------|----------------|----------------|-------------|----------|
| 1 * | 5725.000 | 36.38 | 38.07 | 74.45 | 122.20 | -47.75 | peak |

Remarks:

1. Factor (dB/m) = Antenna Factor (dB/m)+Cable Factor (dB)-Pre-amplifier Factor
2. Margin value = Level -Limit value



| | |
|-------------------|--|
| Ant No.: | Ant 1 + Ant 2 |
| Ant. Pol.: | Vertical |
| Test Mode: | TX 802.11n(HT20) Mode 5745MHz (U-NII-3) |
| Remark: | No report for the emission which more than 20 dB below the prescribed limit. |

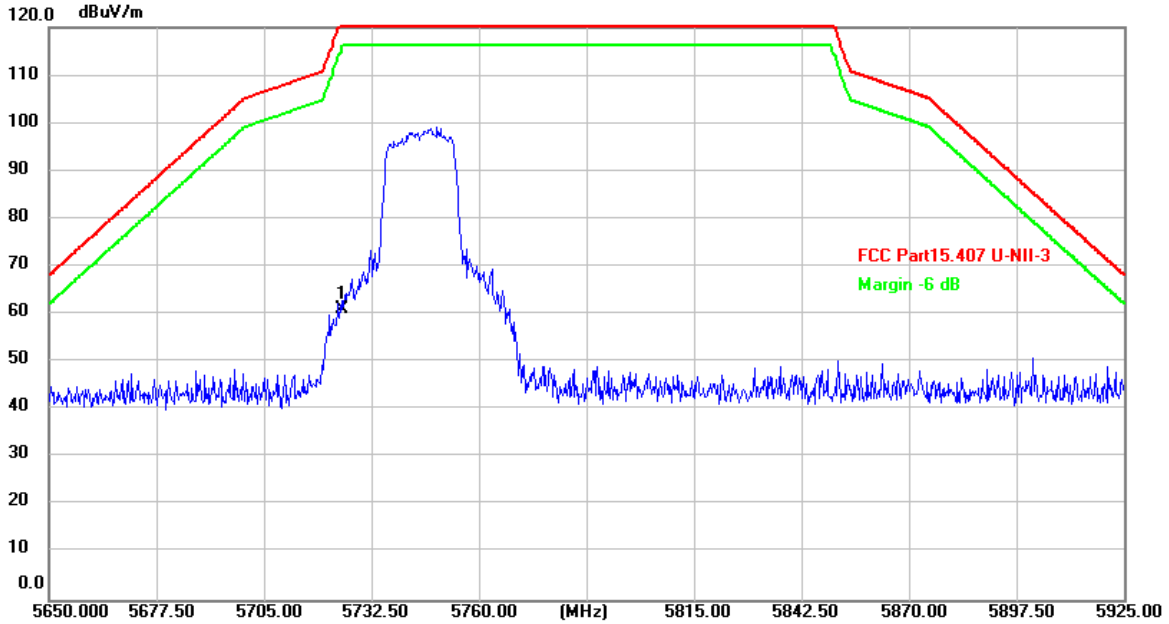

| No. | Frequency (MHz) | Reading (dBuV) | Factor (dB/m) | Level (dBuV/m) | Limit (dBuV/m) | Margin (dB) | Detector |
|-----|-----------------|----------------|---------------|----------------|----------------|-------------|----------|
| 1 * | 5725.000 | 22.89 | 38.07 | 60.96 | 122.20 | -61.24 | peak |

Remarks:

1. Factor (dB/m) = Antenna Factor (dB/m)+Cable Factor (dB)-Pre-amplifier Factor
2. Margin value = Level -Limit value



| | |
|-------------------|--|
| Ant No.: | Ant 1 + Ant 2 |
| Ant. Pol.: | Horizontal |
| Test Mode: | TX 802.11n(HT20) Mode 5825MHz (U-NII-3) |
| Remark: | No report for the emission which more than 20 dB below the prescribed limit. |

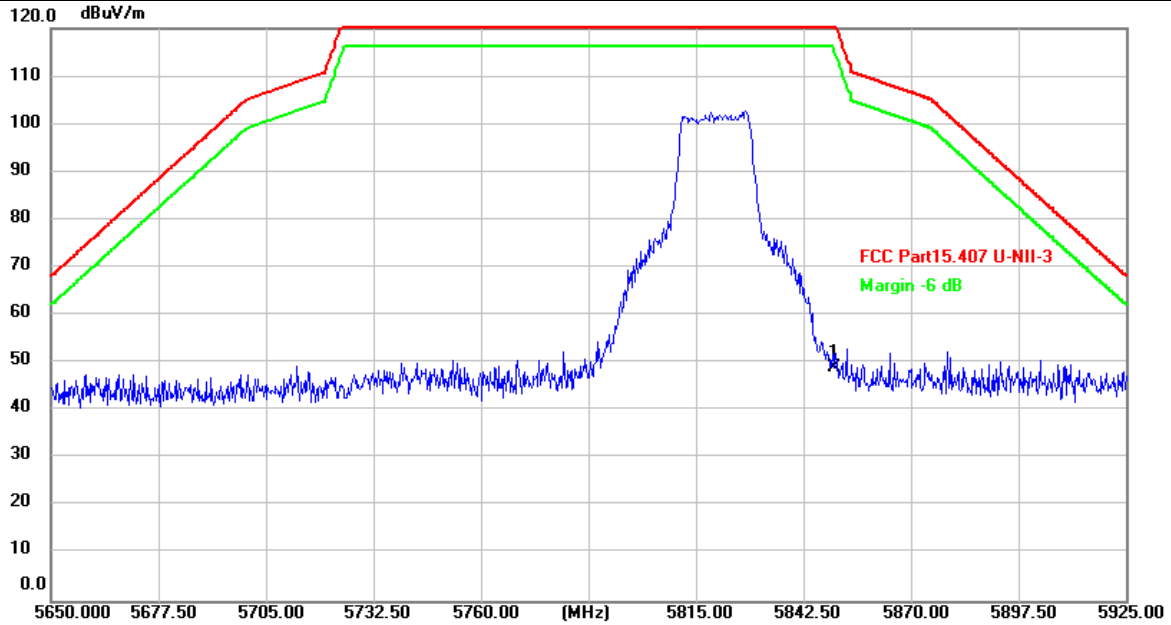

| No. | Frequency (MHz) | Reading (dBuV) | Factor (dB/m) | Level (dBuV/m) | Limit (dBuV/m) | Margin (dB) | Detector |
|-----|-----------------|----------------|---------------|----------------|----------------|-------------|----------|
| 1 * | 5850.000 | 10.85 | 38.33 | 49.18 | 122.20 | -73.02 | peak |

Remarks:

1. Factor (dB/m) = Antenna Factor (dB/m)+Cable Factor (dB)-Pre-amplifier Factor
2. Margin value = Level -Limit value



| | |
|-------------------|--|
| Ant No.: | Ant 1 + Ant 2 |
| Ant. Pol.: | Vertical |
| Test Mode: | TX 802.11n(HT20) Mode 5825MHz (U-NII-3) |
| Remark: | No report for the emission which more than 20 dB below the prescribed limit. |

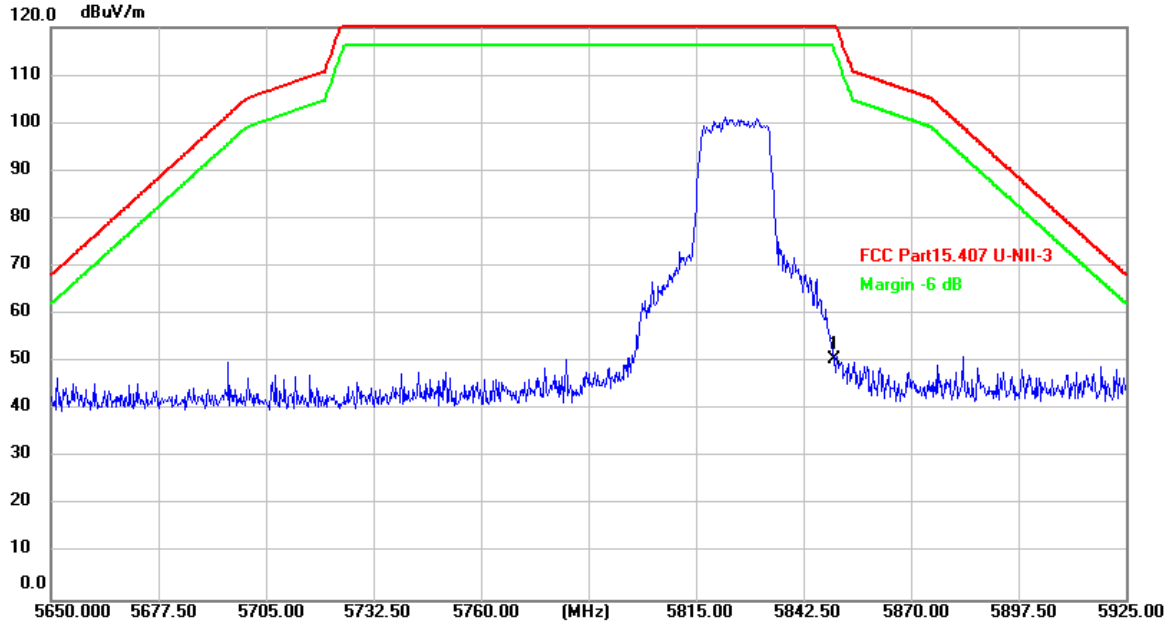

| No. | Frequency (MHz) | Reading (dBuV) | Factor (dB/m) | Level (dBuV/m) | Limit (dBuV/m) | Margin (dB) | Detector |
|-----|-----------------|----------------|---------------|----------------|----------------|-------------|----------|
| 1 * | 5850.000 | 12.19 | 38.33 | 50.52 | 122.20 | -71.68 | peak |

Remarks:

- Factor (dB/m) = Antenna Factor (dB/m)+Cable Factor (dB)-Pre-amplifier Factor
- Margin value = Level -Limit value



| | |
|-------------------|--|
| Ant No.: | Ant 1 + Ant 2 |
| Ant. Pol.: | Horizontal |
| Test Mode: | TX 802.11n(HT40) Mode 5755MHz (U-NII-3) |
| Remark: | No report for the emission which more than 20 dB below the prescribed limit. |

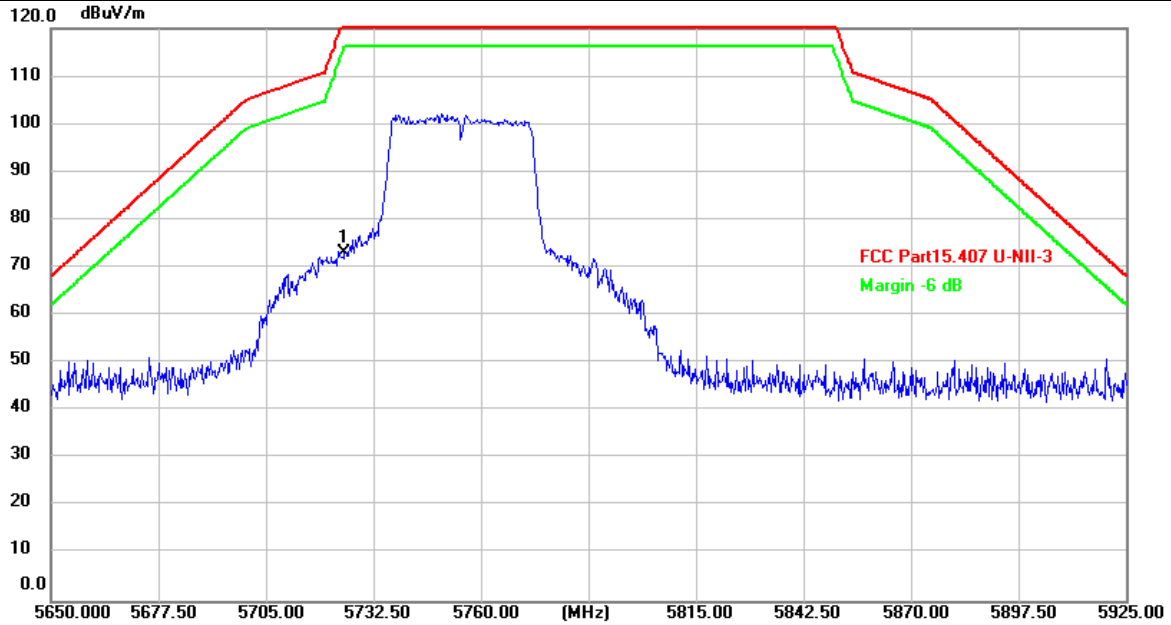

| No. | Frequency (MHz) | Reading (dBuV) | Factor (dB/m) | Level (dBuV/m) | Limit (dBuV/m) | Margin (dB) | Detector |
|-----|-----------------|----------------|---------------|----------------|----------------|-------------|----------|
| 1 * | 5725.000 | 34.99 | 38.07 | 73.06 | 122.20 | -49.14 | peak |

Remarks:

1. Factor (dB/m) = Antenna Factor (dB/m)+Cable Factor (dB)-Pre-amplifier Factor
2. Margin value = Level -Limit value



| | |
|-------------------|--|
| Ant No.: | Ant 1 + Ant 2 |
| Ant. Pol.: | Vertical |
| Test Mode: | TX 802.11n(HT40) Mode 5755MHz (U-NII-3) |
| Remark: | No report for the emission which more than 20 dB below the prescribed limit. |

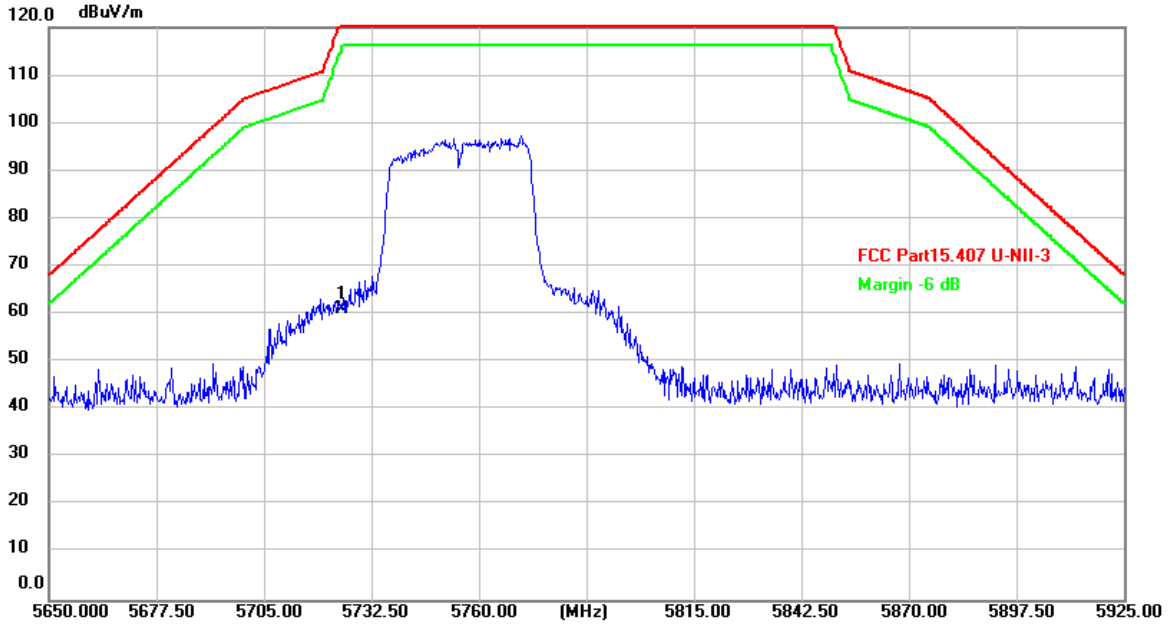

| No. | Frequency (MHz) | Reading (dBuV) | Factor (dB/m) | Level (dBuV/m) | Limit (dBuV/m) | Margin (dB) | Detector |
|-----|-----------------|----------------|---------------|----------------|----------------|-------------|----------|
| 1 * | 5725.000 | 22.86 | 38.07 | 60.93 | 122.20 | -61.27 | peak |

Remarks:

- Factor (dB/m) = Antenna Factor (dB/m)+Cable Factor (dB)-Pre-amplifier Factor
- Margin value = Level -Limit value



| | |
|-------------------|--|
| Ant No.: | Ant 1 + Ant 2 |
| Ant. Pol.: | Horizontal |
| Test Mode: | TX 802.11n(HT40) Mode 5795MHz (U-NII-3) |
| Remark: | No report for the emission which more than 20 dB below the prescribed limit. |

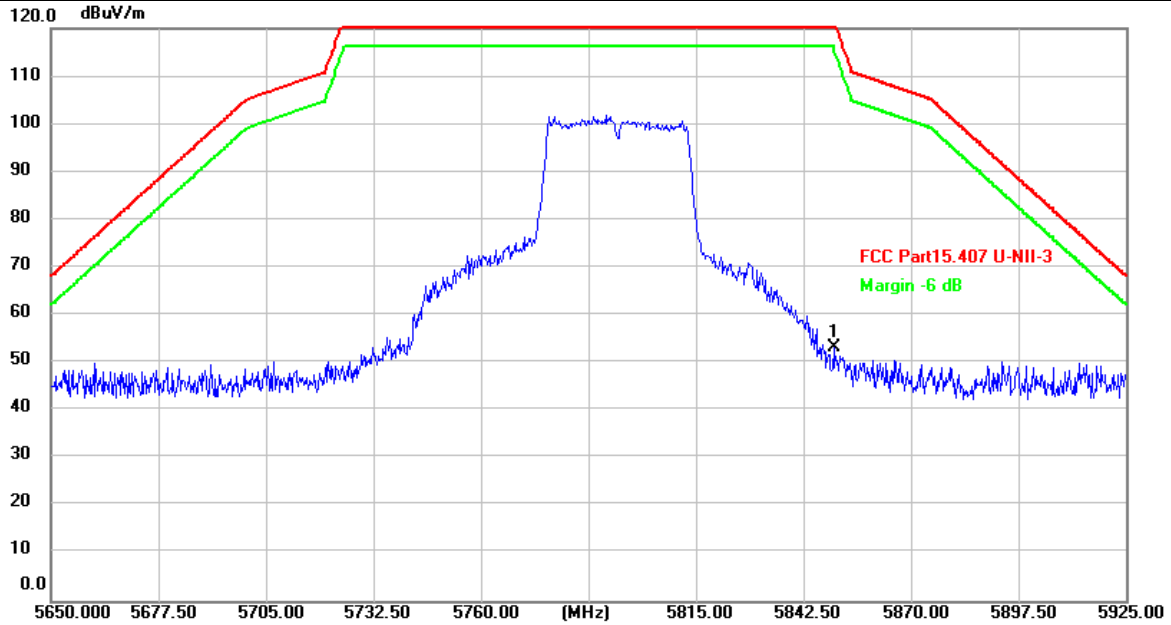

| No. | Frequency (MHz) | Reading (dBuV) | Factor (dB/m) | Level (dBuV/m) | Limit (dBuV/m) | Margin (dB) | Detector |
|-----|-----------------|----------------|---------------|----------------|----------------|-------------|----------|
| 1 * | 5850.000 | 14.80 | 38.33 | 53.13 | 122.20 | -69.07 | peak |

Remarks:

1. Factor (dB/m) = Antenna Factor (dB/m)+Cable Factor (dB)-Pre-amplifier Factor
2. Margin value = Level -Limit value



| | |
|-------------------|--|
| Ant No.: | Ant 1 + Ant 2 |
| Ant. Pol.: | Vertical |
| Test Mode: | TX 802.11n(HT40) Mode 5795MHz (U-NII-3) |
| Remark: | No report for the emission which more than 20 dB below the prescribed limit. |

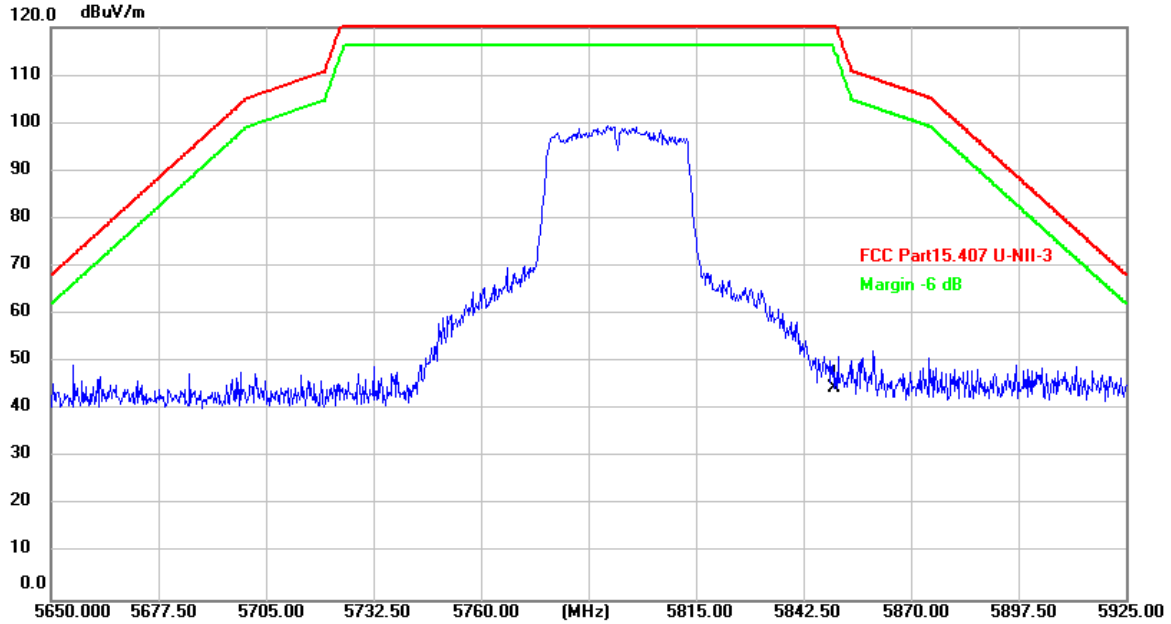

| No. | Frequency (MHz) | Reading (dBuV) | Factor (dB/m) | Level (dBuV/m) | Limit (dBuV/m) | Margin (dB) | Detector |
|-----|-----------------|----------------|---------------|----------------|----------------|-------------|----------|
| 1 * | 5850.000 | 6.26 | 38.33 | 44.59 | 122.20 | -77.61 | peak |

Remarks:

- Factor (dB/m) = Antenna Factor (dB/m)+Cable Factor (dB)-Pre-amplifier Factor
- Margin value = Level -Limit value

3.4. Bandwidth Test

Limit

| FCC Part 15 Subpart C(15.407)/ RSS-247 | | |
|--|---------|-----------------------|
| Test Item | Limit | Frequency Range (MHz) |
| 26 dB Bandwidth | N/A | 5150~5250 |
| | | 5250~5350 |
| | | 5500~5700 |
| 6 dB Bandwidth | >500kHz | 5725~5850 |

Test Configuration

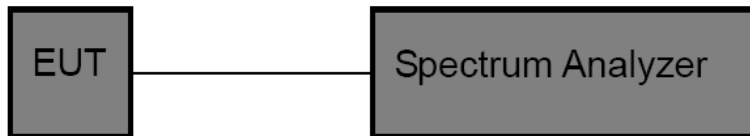

Test Procedure

Please refer to According to KDB789033 D02, for the measurement methods.

The setting of the spectrum analyser as below:

| 26dB Bandwidth Test | |
|---------------------|--|
| Spectrum Parameters | Setting |
| Attenuation | Auto |
| Span | >26 dB Bandwidth |
| RBW | Approximately 1% of the emission bandwidth |
| VBW | VBW>RBW |
| Detector | Peak |
| Trace | Max Hold |
| Sweep Time | Auto |



| 6dB Bandwidth Test | |
|---------------------|--------------------|
| Spectrum Parameters | Setting |
| Attenuation | Auto |
| Span | >6 dB Bandwidth |
| RBW | 100 kHz |
| VBW | $VBW \geq 3 * RBW$ |
| Detector | Peak |
| Trace | Max Hold |
| Sweep Time | Auto |

| 99% Occupied Bandwidth Test | |
|-----------------------------|---------------------|
| Spectrum Parameters | Setting |
| Attenuation | Auto |
| RBW | 1% to 5% of the OBW |
| VBW | $\geq 3RBW$ |
| Detector | Peak |
| Trace | Max Hold |

Note: The EUT was set to continuously transmitting in each mode and low, Middle and high channel for the test.

Test Mode

Please refer to the clause 2.4.

Test Results

Please see the Appendix A1, A2, A3.

3.5. Output Power Test

Limit

| FCC Part 15 Subpart E (15.407) | | |
|--------------------------------|--|----------------------|
| Test Item | Limit | Frequency Range(MHz) |
| Conducted Output Power | Fixed: 1 Watt (30dBm) Mobile and Portable: 250mW (24dBm) | 5150~5250 |
| | 250mW (24dBm) | 5250~5350 |
| | 250mW (24dBm) | 5500~5700 |
| | 1 Watt (30dBm) | 5725~5850 |

| IC Power@PSD Limit | | | | | |
|------------------------------------|-----------------|--|---|----------------------------------|-----------------------------|
| Frequency | Type of devices | Maximum Conducted Output Power | EIRP Output Power | Conducted Power Spectral Density | EIRP Power Spectral Density |
| 5150MHz-5250MHz | in vehicles | | 30mW or $1.76 + 10 \times \log_{10}B$ dBm, whichever is less (B=99% OBW in MHz) | | |
| | Other Devices | | 200mW or $10 + 10 \times \log_{10}B$ dBm, whichever is less (B=99% OBW in MHz) | | 10dBm/MHz |
| 5250MHz-5350MHz | in vehicles | | 30mW or $1.76 + 10 \times \log_{10}B$ dBm, whichever is less (B=99% OBW in MHz) | | |
| | Other Devices | 250mW or $11 + 10 \times \log_{10}B$ dBm, whichever is less (B=99% OBW in MHz) | 1W or $17 + 10 \times \log_{10}B$ dBm, whichever is less (B=99% OBW in MHz) | 11 dBm/MHz | |
| 5470MHz-5600MHz 5650MHz-5725MHz | ALL Devices | 250mW or $11 + 10 \times \log_{10}B$ dBm, whichever is less (B=99% OBW in MHz) | 1W or $17 + 10 \times \log_{10}B$ dBm, whichever is less (B=99% OBW in MHz) | 11 dBm/MHz | |
| 5725MHz-5850MHz | ALL Devices | 1W | | 30dBm/500KHz | |

Test Configuration

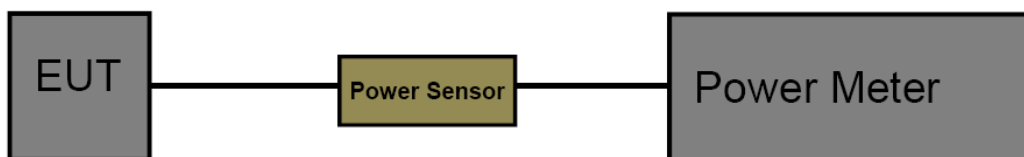



Test Procedure

The measurement is according to section 3 of KDB 789033 D02 General UNII Test Procedures New Rules V02r01.

Test Mode

Please refer to the clause 2.4.

Test Result

Please see the Appendix B.



3.6. Power Spectral Density Test

Limit

FCC Part 15 Subpart E(15.407)/ RSS-247

For the 5.15~5.25GHz band:

- Outdoor AP
The peak power spectral density (PSD) shall not exceed the lesser of 17dBm/MHz.
If $G_{TX} > 6\text{dBi}$, then $\text{PSD} = 17 - (G_{TX} - 6)$.
- Indoor AP
The peak power spectral density (PSD) shall not exceed the lesser of 17dBm/MHz.
If $G_{TX} > 6\text{dBi}$, then $\text{PSD} = 17 - (G_{TX} - 6)$.
- Point-to-point AP
The peak power spectral density (PSD) shall not exceed the lesser of 17dBm/MHz.
If $G_{TX} > 23\text{dBi}$, then $\text{PSD} = 17 - (G_{TX} - 23)$.
- Client devices
The peak power spectral density (PSD) shall not exceed the lesser of 11dBm/MHz.
If $G_{TX} > 6\text{dBi}$, then $\text{PSD} = 11 - (G_{TX} - 6)$.

For the 5.25~5.35GHz band:

The peak power spectral density (PSD) shall not exceed the lesser of 11dBm/MHz.
If $G_{TX} > 6\text{dBi}$, then $\text{PSD} = 11 - (G_{TX} - 6)$.

For the 5.47~5.725GHz band:

The peak power spectral density (PSD) shall not exceed the lesser of 11dBm/MHz.
If $G_{TX} > 6\text{dBi}$, then $\text{PSD} = 11 - (G_{TX} - 6)$.

For the 5.725~5.85GHz band:

- Point-to-multipoint systems (P2M)
The peak power spectral density (PSD) shall not exceed the lesser of 30dBm/500kHz.
If $G_{TX} > 6\text{dBi}$, then $\text{PSD} = 30 - (G_{TX} - 6)$.
- Point-to-point systems (P2P)
The peak power spectral density (PSD) shall not exceed the lesser of 30dBm/500kHz.

Note: G_{TX} : EUT Antenna gain.

| IC Power&PSD Limit | | | | | |
|------------------------------------|-----------------|--|---|----------------------------------|-----------------------------|
| Frequency | Type of devices | Maximum Conducted Output Power | EIRP Output Power | Conducted Power Spectral Density | EIRP Power Spectral Density |
| 5150MHz-5250MHz | in vehicles | | 30mW or $1.76 + 10 \times \log_{10}\text{B dBm}$, whichever is less (B=99% OBW in MHz) | | |
| | Other Devices | | 200mW or $10 + 10 \times \log_{10}\text{B dBm}$, whichever is less (B=99% OBW in MHz) | | 10dBm/MHz |
| 5250MHz-5350MHz | in vehicles | | 30mW or $1.76 + 10 \times \log_{10}\text{B dBm}$, whichever is less (B=99% OBW in MHz) | | |
| | Other Devices | 250mW or $11 + 10 \times \log_{10}\text{B dBm}$, whichever is less (B=99% OBW in MHz) | 1W or $17 + 10 \times \log_{10}\text{B dBm}$, whichever is less (B=99% OBW in MHz) | 11dBm/MHz | |
| 5470MHz-5600MHz 5650MHz-5725MHz | ALL Devices | 250mW or $11 + 10 \times \log_{10}\text{B dBm}$, whichever is less (B=99% OBW in MHz) | 1W or $17 + 10 \times \log_{10}\text{B dBm}$, whichever is less (B=99% OBW in MHz) | 11dBm/MHz | |
| 5725MHz-5850MHz | ALL Devices | 1W | | 30 dBm/500KHz | |

CTC Laboratories, Inc.

1-2/F., Building 2, Jiaquan Building, Guanlan High-Tech Park, Shenzhen, Guangdong, China
Tel.: (86)755-27521059 Fax: (86)755-27521011 Http://www.sz-ctc.org.cn



For anti-fake verification, please visit the official website of Certification and Accreditation Administration of the People's Republic of China : yz.cnca.cn

Test Configuration

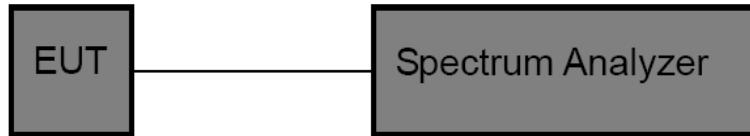

Test Procedure

The EUT was directly connected to the Spectrum Analyzer and antenna output port as show in the block diagram above. The measurement is according to KDB 789033 D02 General UNII Test Procedures New Rules V02r01.

- (1) The EUT was directly connected to the spectrum analyzer and antenna output port as show in the block diagram above.
- (2) Set analyzer center frequency to transmitting frequency.
- (3) Set the span to encompass the entire emissions bandwidth (EBW)(alternatively, the entire 99% OBW) of the signal.
- (4) RBW=1MHz for devices operating in the bands 5.15-5.25 GHz, 5.25-5.35 GHz, and 5.47-5.725 GHz
RBW=500kHz for devices operating in the band 5.725-5.85 GHz. Many spectrum analyzers do not have 500 kHz RBW, thus a narrower RBW may need to be used. The rules permit the use of RBWs less than 1 MHz, or 500 kHz, “provided that the measured power is integrated over the full reference bandwidth” to show the total power over the specified measurement bandwidth (i.e., 1 MHz, or 500 kHz). If measurement bandwidth of Maximum PSD is specified in 500 kHz, add $10 \log(500 \text{ kHz}/\text{RBW})$ to the measured result, whereas RBW (<500 kHz) is the reduced resolution bandwidth of the spectrum analyzer set during measurement. If measurement bandwidth of Maximum PSD is specified in 1 MHz, add $10 \log(1\text{MHz}/\text{RBW})$ to the measured result, whereas RBW (< 1 MHz) is the reduced resolution bandwidth of spectrum analyzer set during measurement.
- (5) Set the VBW to: $\geq 3 \text{ RBW}$
- (6) Detector: AVG
- (7) Trace: Max Hold and View
- (7) Sweep time: auto
- (8) Trace average at least 100 traces in power averaging.
- (9) Use the peak marker function to determine the maximum amplitude level within the RBW. Apply correction to the result if different RBW is used.

NOTE: The EUT was set to continuously transmitting in each mode and low, Middle and high channel for the test.

Test Mode

Please refer to the clause 2.4.

Test Result

Please see the Appendix C.

3.7. Frequency Stability Measurement

Limit

| FCC Part 15 Subpart C(15.407) | | |
|-------------------------------|--|----------------------|
| Test Item | Limit | Frequency Range(MHz) |
| Peak Excursion Measurement | Specified in the user’s manual, the transmitter center frequency tolerance shall be ± 20 ppm maximum for the 5 GHz band (IEEE 802.11n specification) | 5150~5250 |
| | | 5250~5350 |
| | | 5500~5700 |
| | | 5725~5850 |

Test Configuration

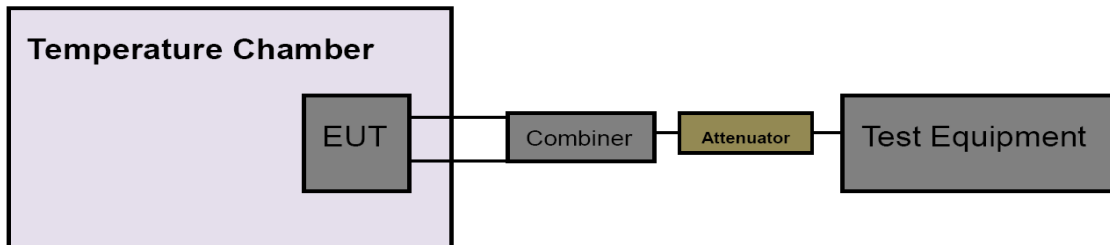

Test Procedure

The EUT was directly connected to the Spectrum Analyzer and antenna output port as show in the block diagram above.

- (1) The EUT was directly connected to the spectrum analyzer and antenna output port as show in the block diagram above.
- (2) Set analyzer center frequency to transmitting frequency.
- (3) Set the span to encompass the entire emissions bandwidth (EBW) of the signal.
- (4) Set the RBW to: 10MHz, VBW=10MHz with peak detector and maxhold settings.
- (5) The test extreme voltage is to change the primary supply voltage from 6.66V to 8.14V percent of the nominal value.
- (6) Extreme temperature is -10°C~40°C

NOTE: The EUT was set to continuously transmitting in continuously un-modulation transmitting mode. The limit for frequency stability is maintained within the band of operation.

Test Mode

Please refer to the clause 2.4.

Test Result

Please see the Appendix D.



3.8. Antenna Requirement

Standard Requirement

FCC CFR Title 47 Part 15 Subpart C Section 15.203:

An intentional radiator shall be designed to ensure that no antenna other than that furnished by the responsible party shall be used with the device. The use of a permanently attached antenna or of an antenna that uses a unique coupling to the intentional radiator, the manufacturer may design the unit so that a broken antenna can be replaced by the user, but the use of a standard antenna jack or electrical connector is prohibited.

Test Result

Complies

Directional gain = $G_{ANT} = 5\text{dBi}$

Note: All transmit signals are completely uncorrelated with each other in MIMO transmitting modes (Manufacturer's Declaration).



3.9. Dynamic Frequency Selection(DFS)

Requirement

Table 1: Applicability of DFS Requirements Prior to Use of a Channel

| Requirement | Operational Mode | | |
|---------------------------------|------------------|--------------------------------|-----------------------------|
| | Master | Client Without Radar Detection | Client With Radar Detection |
| Non-Occupancy Period | Yes | Not required | Yes |
| DFS Detection Threshold | Yes | Not required | Yes |
| Channel Availability Check Time | Yes | Not required | Not required |
| U-NII Detection Bandwidth | Yes | Not required | Yes |

Table 2: Applicability of DFS requirements during normal operation

| Requirement | Operational Mode | |
|-----------------------------------|--|--------------------------------|
| | Master Device or Client with Radar Detection | Client Without Radar Detection |
| DFS Detection Threshold | Yes | Not required |
| Channel Closing Transmission Time | Yes | Yes |
| Channel Move Time | Yes | Yes |
| U-NII Detection Bandwidth | Yes | Not required |

| Additional requirements for devices with multiple bandwidth modes | Master Device or Client with Radar Detection | Client Without Radar Detection |
|---|--|--|
| U-NII Detection Bandwidth and Statistical Performance Check | All BW modes must be tested | Not required |
| Channel Move Time and Channel Closing Transmission Time | Test using widest BW mode available | Test using the widest BW mode available for the link |
| All other tests | Any single BW mode | Not required |

Note: Frequencies selected for statistical performance check (Section 7.8.4) should include several frequencies within the radar detection bandwidth and frequencies near the edge of the radar detection bandwidth. For 802.11 devices it is suggested to select frequencies in each of the bonded 20 MHz channels and the channel center frequency.

**LIMIT**

1. DFS Detection Thresholds

Table 3: DFS Detection Thresholds for Master Devices and Client Devices With Radar Detection

| Maximum Transmit Power | Value (See Notes 1, 2, and 3) |
|--|-------------------------------|
| EIRP \geq 200 milliwatt | -64 dBm |
| EIRP < 200 milliwatt and power spectral density < 10 dBm/MHz | -62 dBm |
| EIRP < 200 milliwatt that do not meet the power spectral density requirement | -64 dBm |

Note 1: This is the level at the input of the receiver assuming a 0dBi receive antenna.
Note 2: Throughout these test procedures an additional 1 dB has been added to the amplitude of the test transmission waveforms to account for variations in measurement equipment. This will ensure that the test signal is at or above the detection threshold level to trigger a DFS response.
Note3: EIRP is based on the highest antenna gain. For MIMO devices refer to KDB Publication 662911 D01.

2. DFS Response Requirements

Table 4: DFS Response Requirement Values

| Parameter | Value |
|-----------------------------------|--|
| Non-occupancy period | Minimum 30 minutes |
| Channel Availability Check Time | 60 seconds |
| Channel Move Time | 10 seconds See Note 1. |
| Channel Closing Transmission Time | 200 milliseconds + an aggregate of 60 milliseconds over remaining 10 second period. See Notes 1 and 2. |
| U-NII Detection Bandwidth | Minimum 100% of the U-NII 99% transmission power bandwidth. See Note 3. |

Note 1: Channel Move Time and the Channel Closing Transmission Time should be performed with Radar Type 0. The measurement timing begins at the end of the Radar Type 0 burst.
Note 2: The Channel Closing Transmission Time is comprised of 200 milliseconds starting at the beginning of the Channel Move Time plus any additional intermittent control signals required facilitating a Channel move (an aggregate of 60 milliseconds) during the remainder of the 10 second period. The aggregate duration of control signals will not count quiet periods in between transmissions.
Note 3: During the U-NII Detection Bandwidth detection test, radar type 0 should be used. For each frequency step the minimum percentage of detection is 90 percent. Measurements are performed with no data traffic.

RADAR TEST WAVEFORMS

This section provides the parameters for required test waveforms, minimum percentage of successful detections, and the minimum number of trials that must be used for determining DFS conformance. Step intervals of 0.1 microsecond for Pulse Width, 1 microsecond for PRI, 1 MHz for chirp width and 1 for the number of pulses will be utilized for the random determination of specific test waveforms.



Table 5 Short Pulse Radar Test Waveforms

| Radar Type | Pulse Width (μsec) | PRI (μsec) | Number of Pulses | Minimum Percentage of Successful Detection | Minimum Number of Trials |
|--|--------------------|---|--|--|--------------------------|
| 0 | 1 | 1428 | 18 | See Note 1 | See Note 1 |
| 1 | 1 | Test A: 15 unique PRI values randomly selected from the list of 23 PRI values in Table 5a | Roundup $\left\{ \left(\frac{1}{360} \right) \cdot \left(\frac{19 \cdot 10^6}{PRI_{\mu sec}} \right) \right\}$ | 60% | 30 |
| | | Test B: 15 unique PRI values randomly selected within the range of 518-3066 μsec, with a minimum increment of 1 μsec, excluding PRI values selected in Test A | | | |
| 2 | 1-5 | 150-230 | 23-29 | 60% | 30 |
| 3 | 6-10 | 200-500 | 16-18 | 60% | 30 |
| 4 | 11-20 | 200-500 | 12-16 | 60% | 30 |
| Aggregate (Radar Types 1-4) | | | | 80% | 120 |
| Note 1: Short Pulse Radar Type 0 should be used for the detection bandwidth test, channel move time, and channel closing time tests. | | | | | |

A minimum of 30 unique waveforms are required for each of the Short Pulse Radar Types 2 through 4. If more than 30 waveforms are used for Short Pulse Radar Types 2 through 4, then each additional waveform must also be unique and not repeated from the previous waveforms. If more than 30 waveforms are used for Short Pulse Radar Type 1, then each additional waveform is generated with Test B and must also be unique and not repeated from the previous waveforms in Tests A or B.

For example if in Short Pulse Radar Type 1 Test B a PRI of 3066 μsec is selected, the number of pulses

$$\left\{ \left(\frac{1}{360} \right) \cdot \left(\frac{19 \cdot 10^6}{3066} \right) \right\}$$

would be Round up $\left\{ \left(\frac{1}{360} \right) \cdot \left(\frac{19 \cdot 10^6}{3066} \right) \right\} = \text{Round up } \{17.2\} = 18$.

Table 5a - Pulse Repetition Intervals Values for Test A

| Pulse Repetition Frequency Number | Pulse Repetition Frequency (Pulses Per Second) | Pulse Repetition Interval (Microseconds) |
|-----------------------------------|--|--|
| 1 | 1930.5 | 518 |
| 2 | 1858.7 | 538 |
| 3 | 1792.1 | 558 |
| 4 | 1730.1 | 578 |
| 5 | 1672.2 | 598 |
| 6 | 1618.1 | 618 |
| 7 | 1567.4 | 638 |
| 8 | 1519.8 | 658 |
| 9 | 1474.9 | 678 |
| 10 | 1432.7 | 698 |

CTC Laboratories, Inc.

1-2/F., Building 2, Jiaquan Building, Guanlan High-Tech Park, Shenzhen, Guangdong, China
 Tel.: (86)755-27521059 Fax: (86)755-27521011 Http://www.sz-ctc.org.cn



For anti-fake verification, please visit the official website of Certification and Accreditation Administration of the People's Republic of China : yz.cnca.cn



| | | |
|----|--------|------|
| 11 | 1392.8 | 718 |
| 12 | 1355 | 738 |
| 13 | 1319.3 | 758 |
| 14 | 1285.3 | 778 |
| 15 | 1253.1 | 798 |
| 16 | 1222.5 | 818 |
| 17 | 1193.3 | 838 |
| 18 | 1165.6 | 858 |
| 19 | 1139 | 878 |
| 20 | 1113.6 | 898 |
| 21 | 1089.3 | 918 |
| 22 | 1066.1 | 938 |
| 23 | 326.2 | 3066 |

Table 6 – Long Pulse Radar Test Waveform

| Radar Type | Pulse Width (μsec) | Chirp Width (MHz) | PRI (μsec) | Number of Pulses per Burst | Number of Bursts | Minimum Percentage of Successful Detection | Minimum Number of Trials |
|------------|--------------------|-------------------|------------|----------------------------|------------------|--|--------------------------|
| 5 | 50-100 | 5-20 | 1000-2000 | 1-3 | 8-20 | 80% | 30 |

The parameters for this waveforms are randomly chosen. Thirty unique waveforms are required for the Long Pulse Radar Type waveforms. If more than 30 waveforms are used for the Long Pulse Radar Type wave forms, then each additional waveform must also be unique and not repeated from the previous waveforms.

Table 7 – Frequency Hopping Radar Test Waveform

| Radar Type | Pulse Width (μsec) | PRI (μsec) | Pulses per Hop | Hopping Rate (kHz) | Hopping Sequence Length (msec) | Minimum Percentage of Successful Detection | Minimum Number of Trials |
|------------|--------------------|------------|----------------|--------------------|--------------------------------|--|--------------------------|
| 6 | 1 | 333 | 9 | 0.333 | 300 | 70% | 30 |

For the Frequency Hopping Radar Type, the same Burst parameters are used for each wave form. The hopping sequence is different for each wave form and a 100-length segment is selected from the hopping sequence defined by the following algorithm:

The first frequency in a hopping sequence is selected randomly from the group of 475 integer frequencies from 5250–5724MHz. Next, the frequency that was just chosen is removed from the group and a frequency is randomly selected from the remaining 474 frequencies in the group. This process continues until all 475 frequencies are chosen for the set. For selection of a random frequency, the frequencies remaining within the group are always treated as equally likely.

Calibration of Radar Waveform

Radar Waveform Calibration Procedure

- 1) A 50 ohm load is connected in place of the spectrum analyzer, and the spectrum analyzer is connected to place of the master
- 2) The interference Radar Detection Threshold Level is $-62\text{dBm} + 0\text{dBi} + 1\text{dB} = -61\text{dBm}$ that had been taken into account the output power range and antenna gain.
- 3) The following equipment setup was used to calibrate the conducted radar waveform. A vector signal generator was utilized to establish the test signal level for radar type 0. During this process there were no transmissions by either the master or client device. The spectrum analyzer was switched to the zero spans (time domain) at the frequency of the radar waveform generator. Peak detection was

used. The spectrum analyzer resolution bandwidth (RBW) and video bandwidth (VBW) were set to 3 MHz. The spectrum analyzer had offset -1.0dB to compensate RF cable loss 1.0dB.

- 4) The vector signal generator amplitude was set so that the power level measured at the spectrum analyzer was $-62\text{dBm} + 0\text{dBi} + 1\text{dB} = -61\text{dBm}$. Capture the spectrum analyzer plots on short pulse radar waveform.

Conducted Calibration Setup

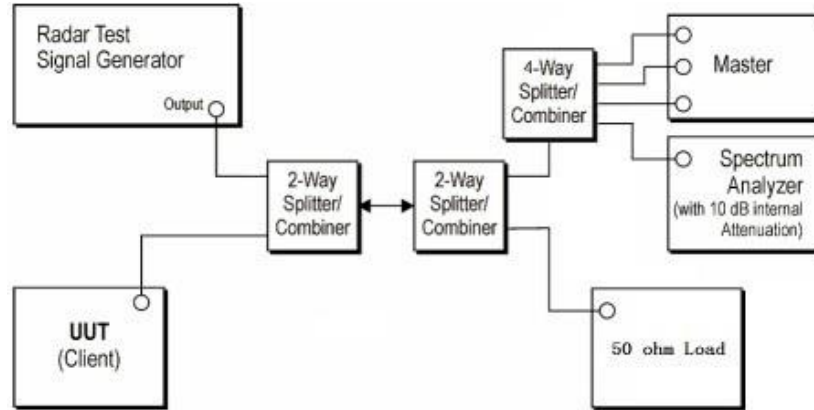

Test Configuration

Setup for Client with injection at the Master

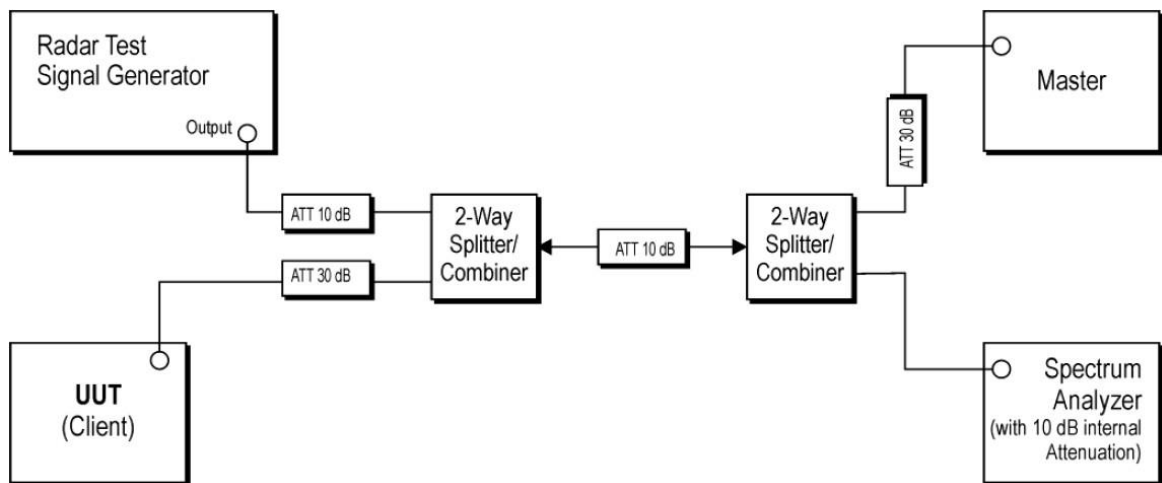



Radar Waveform Calibration Result

Not Applicable

Test Procedure

1. The radar pulse generator is setup to provide a pulse at frequency that the master and client are operating. A type 0 radar pulse with a 1us pulse width and a 1428us PRI is used for the testing.
2. The vector signal generator is adjusted to provide the radar burst (18 pulses) at the level of approximately -61dBm at the antenna port of the master device
3. A trigger is provided from the pulse generator to the DFS monitoring system in order to capture the traffic and the occurrence of the radar pulse.
4. EUT will associate with the master at channel. The file "iperf.exe" specified by the FCC is streamed from the PC 2 through the master and the client device to the PC 1 and played in full motion video using Media Player Classic Ver. 6.4.8.6 in order to properly load the network for the entire period of the test.
5. When radar burst with a level equal to the DFS Detection Threshold +1dB is generated on the operating channel of the U-NII device. At time T0 the radar waveform generator sends a burst of pulse of the radar waveform at Detection Threshold +1dB.
6. Observe the transmissions of the EUT at the end of the radar Burst on the Operating Channel Measure and record the transmissions from the UUT during the observation time (Channel Move Time). One 15 seconds plot is reported for the Short Pulse Radar Type 0. The plot for the Short Pulse Radar Types start at the end of the radar burst. The Channel Move Time will be calculated based on the zoom in 600ms plot of the Short Pulse Radar Type
7. Measurement of the aggregate duration of the Channel Closed Transmission Time method. With the spectrum analyzer set to zero span tuned to the center frequency of the EUT operating channel at the radar simulated frequency, peak detection, and max hold, the dwell time per bin is given by: $Dwell (0.3ms) = S (12000ms) / B (4000)$; where Dwell is the dwell time per spectrum analyzer sampling bin, S is sweep time and B is the number of spectrum analyzer sampling bins. An upper bound of the aggregate duration of the intermittent control signals of Channel Closing Transmission Time is calculated by: $C (ms) = N \times Dwell (0.3ms)$; where C is the Closing Time, N is the number of spectrum analyzer sampling bins (intermittent control signals) showing a U-NII transmission and Dwell is the dwell time per bin.
8. Measurement the EUT for more than 30 minutes following the channel move time to verify that no transmission or beacons occur on this channel.

Test Mode

Please refer to the clause 2.4.

Test Results

Passed

Not Applicable

*****THE END*****