



# FCC TEST REPORT (PART 22)

Applicant:	Foxx Development Inc
Address:	3480 Preston Ridge Road Suite 500, Alpharetta, GA 30005

Manufacturer or Supplier:	Foxx Development Inc
Address:	3480 Preston Ridge Road Suite 500, Alpharetta, GA 30005
Product:	LTE Cat 1bis Module
Brand Name:	FOXX
Model Name:	IQ10
FCC ID:	2AQRM-IQ10
Date of tests:	Feb. 07, 2025 ~ Feb. 28, 2025

The tests have been carried out according to the requirements of the following standard:

- |  |  |
|--|--|
| <input checked="" type="checkbox"/> FCC PART 22, Subpart H | <input checked="" type="checkbox"/> FCC Part 2       |
| <input checked="" type="checkbox"/> ANSI/TIA/EIA-603-D     | <input checked="" type="checkbox"/> ANSI C63.26-2015 |
| <input checked="" type="checkbox"/> ANSI/TIA/EIA-603-E     |  |

CONCLUSION: The submitted sample was found to COMPLY with the test requirement

Prepared by Hanwen Xu Engineer / Mobile Department	Approved by Peibo Sun Manager / Mobile Department
Date: Feb. 28, 2025	Date: Feb. 28, 2025

This report is governed by, and incorporates by reference, the Conditions of Testing as posted at the date of issuance of this report at <http://www.bureauveritas.com/home/about-us/our-business/cps/about-us/terms-conditions/> and is intended for your exclusive use. Any copying or replication of this report to or for any other person or entity, or use of our name or trademark, is permitted only with our prior written permission. This report sets forth our findings solely with respect to the test samples identified herein. The results set forth in this report are not indicative or representative of the quality or characteristics of the lot from which a test sample was taken or any similar or identical product unless specifically and expressly noted. Our report includes all of the tests requested by you and the results thereof based upon the information that you provided to us. Measurement uncertainty is only provided upon request for accredited tests. Statements of conformity are based on simple acceptance criteria without taking measurement uncertainty into account, unless otherwise requested in writing. You have 60 days from date of issuance of this report to notify us of any material error or omission caused by our negligence or if you require measurement uncertainty; provided, however, that such notice shall be in writing and shall specifically address the issue you wish to raise. A failure to raise such issue within the prescribed time shall constitute your unqualified acceptance of the completeness of this report, the tests conducted and the correctness of the report contents.



# TABLE OF CONTENTS

RELEASE CONTROL RECORD .....	4
1 SUMMARY OF TEST RESULTS .....	5
1.1 MEASUREMENT UNCERTAINTY .....	6
1.2 TEST SITE AND INSTRUMENTS .....	7
2 GENERAL INFORMATION .....	9
2.1 GENERAL DESCRIPTION OF EUT .....	9
2.2 CONFIGURATION OF SYSTEM UNDER TEST .....	11
2.3 DESCRIPTION OF SUPPORT UNITS .....	12
2.4 TEST ITEM AND TEST CONFIGURATION .....	12
2.5 EUT OPERATING CONDITIONS .....	16
2.6 GENERAL DESCRIPTION OF APPLIED STANDARDS .....	16
3 TEST TYPES AND RESULTS .....	17
3.1 OUTPUT POWER MEASUREMENT .....	17
3.1.1 LIMITS OF OUTPUT POWER MEASUREMENT .....	17
3.1.2 TEST PROCEDURES .....	17
3.1.3 TEST SETUP .....	18
3.1.4 TEST RESULTS .....	19
3.2 FREQUENCY STABILITY MEASUREMENT .....	29
3.2.1 LIMITS OF FREQUENCY STABILITY MEASUREMENT .....	29
3.2.2 TEST PROCEDURE .....	29
3.2.3 TEST SETUP .....	29
3.2.4 TEST RESULTS .....	29
3.3 OCCUPIED BANDWIDTH MEASUREMENT .....	30
3.3.1 LIMITS OF OCCUPIED BANDWIDTH MEASUREMENT .....	30
3.3.2 TEST SETUP .....	30
3.3.3 TEST PROCEDURES .....	30
3.3.4 TEST RESULTS .....	30
3.4 BAND EDGE MEASUREMENT .....	31
3.4.1 LIMITS OF BAND EDGE MEASUREMENT .....	31
3.4.2 TEST SETUP .....	31
3.4.3 TEST PROCEDURES .....	32
3.4.4 TEST RESULTS .....	32
3.5 CONDUCTED SPURIOUS EMISSIONS .....	33
3.5.1 LIMITS OF CONDUCTED SPURIOUS EMISSIONS MEASUREMENT .....	33
3.5.2 TEST PROCEDURE .....	33
3.5.3 TEST SETUP .....	33
3.5.4 TEST RESULTS .....	33
3.6 RADIATED EMISSION MEASUREMENT .....	34
3.6.1 LIMITS OF RADIATED EMISSION MEASUREMENT .....	34
3.6.2 TEST PROCEDURES .....	34
3.6.3 DEVIATION FROM TEST STANDARD .....	34
3.6.4 TEST SETUP .....	35
3.6.5 TEST RESULTS .....	37
3.7 PEAK TO AVERAGE RATIO .....	53
3.7.1 LIMITS OF PEAK TO AVERAGE RATIO MEASUREMENT .....	53
3.7.2 TEST SETUP .....	53
3.7.3 TEST PROCEDURES .....	53
3.7.4 TEST RESULTS .....	54
4 PHOTOGRAPHS OF THE TEST CONFIGURATION .....	55
5 INFORMATION ON THE TESTING LABORATORIES .....	56
6 MODIFICATIONS RECORDERS FOR ENGINEERING CHANGES TO THE EUT BY THE LAB .....	57
7 APPENDIX .....	58
LTE BAND26 (INCLUDING LTE BAND 5) .....	58
PEAK-TO-AVERAGE RATIO(CCDF) .....	58
TEST RESULT .....	58



**BUREAU VERITAS** Test Report No.: PSZ-NQN2412300616RF01

TEST GRAPHS .....	59
26DB BANDWIDTH AND OCCUPIED BANDWIDTH .....	65
TEST RESULT .....	65
TEST GRAPHS .....	66
BAND EDGE .....	81
TEST RESULT .....	81
TEST GRAPHS .....	82
CONDUCTED SPURIOUS EMISSION .....	102
TEST RESULT .....	102
TEST GRAPHS .....	103
FREQUENCY STABILITY .....	111
TEST RESULT .....	111



**BUREAU**  
**VERITAS**

Test Report No.: PSZ-NQN2412300616RF01

## RELEASE CONTROL RECORD

ISSUE NO.	REASON FOR CHANGE	DATE ISSUED
PSZ-NQN2412300616RF01	Original release	Feb. 28, 2025



# 1 SUMMARY OF TEST RESULTS

The EUT has been tested according to the following specifications:

APPLIED STANDARD: FCC Part 22 & Part 2			
STANDARD SECTION	TEST TYPE	RESULT	Test lab*
§2.1046	Conducted Output Power	Compliance	A
§22.913 (a)(5)	Equivalent Isotropic Radiated Power	Compliance	A
§2.1055 §22.355	Frequency Stability	Compliance	A
§2.1049	Occupied Bandwidth	Compliance	A
§22.913 (d)	Peak to average ratio*	Compliance	A
§2.1051 §22.917(a)	Band Edge Measurements	Compliance	A
§2.1051 §22.917(a)	Conducted Spurious Emissions	Compliance	A
§2.1053 §22.917(a)	Radiated Spurious Emissions	Compliance	A

\* Refer to KDB 971168 D01 Power Meas License Digital Systems v03r01.

### \*Test Lab Information Reference

**Lab A:**

Huarui 7Layers High Technology (Suzhou) Co., Ltd.

**Lab Address:**

Tower N, Innovation Center, 88 Zuyi Road, High-tech District, Suzhou City, Anhui Province

**Accredited Test Lab Cert 6613.01**

The FCC Site Registration No. is 434559; The Designation No. is CN1325.



### 1.1 MEASUREMENT UNCERTAINTY

Where relevant, the following measurement uncertainty levels have been estimated for tests performed on the EUT as specified in CISPR 16-4-2:

MEASUREMENT	UNCERTAINTY
Maximum Peak Output Power	±2.06dB
Frequency Stability	±76.97Hz
Radiated emissions (9KHz~30MHz)	±2.68dB
Radiated emissions (30MHz~1GHz)	±4.98dB
Radiated emissions (1GHz ~6GHz)	±4.70dB
Radiated emissions (6GHz ~18GHz)	±4.60dB
Radiated emissions (18GHz ~40GHz)	±4.12dB
Conducted emissions	±4.01dB
Occupied Channel Bandwidth	±43.58KHz
Band Edge Measurements	±4.70dB
Peak to average ratio	±0.76dB

This uncertainty represents an expanded uncertainty expressed at approximately the 95% confidence level using a coverage factor of k=2.

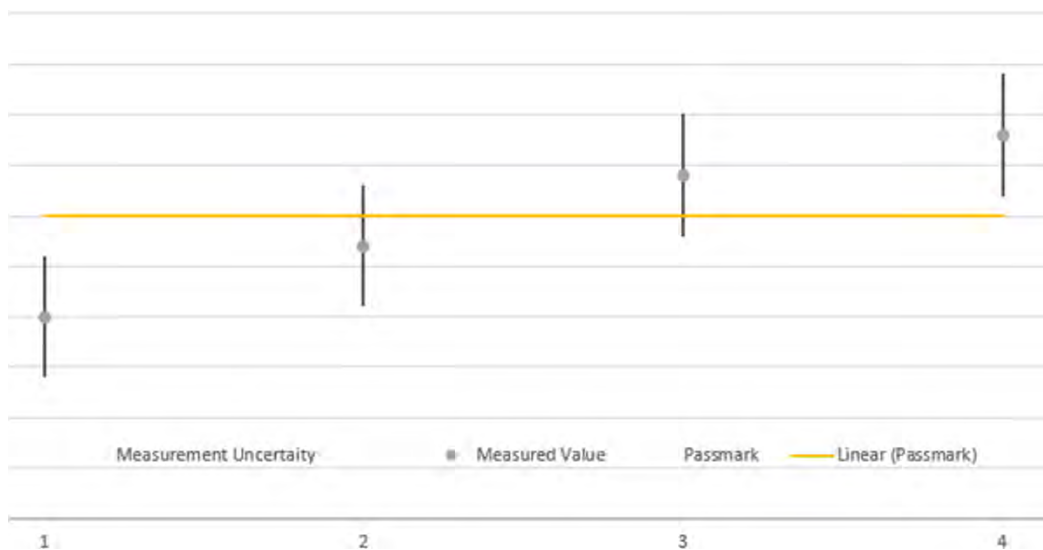

The verdicts in this test report are given according the above diagram:

Case	Measured Value	Uncertainty Range	Verdict
1	below pass mark	below pass mark	Passed
2	below pass mark	within pass mark	Passed
3	above pass mark	within pass mark	Failed
4	above pass mark	above pass mark	Failed

That means, the laboratory applies, as decision rule (see ISO/IEC 17025:2017), the so-called shared risk principle.



## 1.2 TEST SITE AND INSTRUMENTS

Equipment	Manufacturer	Model No.	Serial No.	Last Cal.	Next Cal.
Pre-Amplifier	R&S	SCU18F1	100815	Aug.30,23	Aug.29,25
Pre-Amplifier	R&S	SCU08F1	101028	Jan.22,24	Jan.21,26
Vector Signal Generator	R&S	SMBV100B	102176	Mar.29,24	Mar.28,26
Signal Generator	R&S	SMB100A	182185	Mar.29,24	Mar.28,26
3m Fully-anechoic Chamber	TDK	9m*6m*6m	HRSW-SZ-EMC-01Chamber	Nov.25,22	Nov.24,25
3m Semi-anechoic Chamber	TDK	9m*6m*6m	HRSW-SZ-EMC-02Chamber	Nov.25,22	Nov.24,25
EMI TEST Receiver	R&S	ESR26	101734	Mar.28,24	Mar.27,26
EMI TEST Receiver	R&S	ESW44	101973	Mar.28,24	Mar.27,26
Bilog Antenna	SCHWARZBECK	VULB 9163	1264	Dec.26,23	Dec.25,25
Horn Antenna	ETS-LINDGREN	3117	227836	Aug.22,23	Aug.21,25
Horn Antenna (18GHz-40GHz)	Steatite Q-par Antennas	QMS 00880	23486	Jul.15,24	Jul.14,26
Horn Antenna	Steatite Q-par Antennas	QMS 00208	23485	Aug.22,23	Aug.21,25
Loop Antenna	SCHWARZ	HFH2-Z2/Z2E	100976	Feb.23,23	Feb.22,25
Loop Antenna	SCHWARZ	HFH2-Z2/Z2E	100976	Feb.22,25	Feb.21,27
WIDEBANDRADIO COMMUNICATION TESTER	R&S	CMW500	169399	Jun.19,24	Jun.18,26
Test Software	EMC32	EMC32	N/A	N/A	N/A
6DB attenuator	Tonscend Technology Co., Ltd	N/A	23062787	N/A	N/A
Test Software	ELEKTRA	ELEKTRA4.32	N/A	N/A	N/A
Open Switch and Control Unit	R&S	OSP220	101964	N/A	N/A
DC Source	HYELEC	HY3010B	551016	Aug.31,23	Aug.30,25
Hygrothermograph	DELI	20210528	SZ014	Sep.06,23	Sep.05,25
PC	LENOVO	E14	HRSW0024	N/A	N/A
TMC-AMI18843A(CABLE)	R&S	HF290-NMNM-7.00M	N/A	N/A	N/A
TMC-AMI18843A(CABLE)	R&S	HF290-NMNM-4.00M	N/A	N/A	N/A
CABLE	R&S	W13.02	N/A	Apr.27,24	Apr.26,25
CABLE	R&S	W12.14	N/A	Apr.27,24	Apr.26,25
CABLE	R&S	J12J103539-00-1	SEP-03-20-069	Apr.27,24	Apr.26,25
CABLE	R&S	J12J103539-00-1	SEP-03-20-070	Apr.27,24	Apr.26,25
Temperature Chamber	votsch	VT4002	58566078100050	May.30,24	May.29,26



**Test Report No.: PSZ-NQN2412300616RF01**

- NOTE:**
1. The calibration interval of the above test instruments is 12 / 24/ 36 months and the calibrations are traceable to CEPREI/CHINA, GRGT/CHINA and NIM/CHINA.
  2. The test was performed in 3m Semi-anechoic Chamber and RF Oven Room.
  3. The horn antenna is used only for the measurement of emission frequency above 1GHz if tested.
  4. The FCC Site Registration No. is 434559; The Designation No. is CN1325.





## 2 GENERAL INFORMATION

### 2.1 GENERAL DESCRIPTION OF EUT

<b>PRODUCT*</b>	LTE Cat 1bis Module	
<b>BRAND NAME*</b>	FOXX	
<b>MODEL NAME*</b>	IQ10	
<b>NOMINAL VOLTAGE*</b>	EUT 3.8V	
<b>MODULATION TYPE</b>	LTE	QPSK, 16QAM
<b>FREQUENCY RANGE</b>	LTE Band 5 (Channel Bandwidth: 1.4MHz)	824.7MHz ~ 848.3MHz
	LTE Band 5 (Channel Bandwidth: 3MHz)	825.5MHz ~ 847.5MHz
	LTE Band 5 (Channel Bandwidth: 5MHz)	826.5MHz ~ 846.5MHz
	LTE Band 5 (Channel Bandwidth: 10MHz)	829MHz ~ 844MHz
	LTE Band 26 (Channel Bandwidth: 1.4MHz)	824.7MHz ~ 848.3MHz
	LTE Band 26 (Channel Bandwidth: 3MHz)	825.5MHz ~ 847.5MHz
	LTE Band 26 (Channel Bandwidth: 5MHz)	826.5MHz ~ 846.5MHz
	LTE Band 26 (Channel Bandwidth: 10MHz)	829MHz ~ 844MHz
	LTE Band 26 (Channel Bandwidth: 15MHz)	831.5MHz ~ 841.5MHz
	<b>MAX. ERP POWER</b>	LTE Band 5 (Channel Bandwidth: 1.4MHz)
LTE Band 5 (Channel Bandwidth: 3MHz)		174.58mW
LTE Band 5 (Channel Bandwidth: 5MHz)		172.98mW
LTE Band 5 (Channel Bandwidth: 10MHz)		176.2mW
LTE Band 26 (Channel Bandwidth: 1.4MHz)		145.88mW
LTE Band 26 (Channel Bandwidth: 3MHz)		144.88mW
LTE Band 26 (Channel Bandwidth: 5MHz)		146.89mW
LTE Band 26 (Channel Bandwidth: 10MHz)		143.88mW
LTE Band 26 (Channel Bandwidth: 15MHz)		163.31mW



<b>EMISSION DESIGNATOR</b> GOGN	<b>LTE Band 26 (Channel Bandwidth: 1.4MHz)</b>	QPSK: 1M08G7D 16QAM: 1M08W7D
	<b>LTE Band 26 (Channel Bandwidth: 3MHz)</b>	QPSK: 2M69G7D 16QAM: 2M69W7D
	<b>LTE Band 26 (Channel Bandwidth: 5MHz)</b>	QPSK: 4M48G7D 16QAM: 4M48W7D
	<b>LTE Band 26 (Channel Bandwidth: 10MHz)</b>	QPSK: 8M92G7D 16QAM: 4M82W7D
	<b>LTE Band 26 (Channel Bandwidth: 15MHz)</b>	QPSK: 13M4G7D 16QAM: 4M82W7D
	<b>ANTENNA GAIN*</b>	LTE B5
LTE B26		0.91dBi
<b>ANTENNA TYPE*</b>	PIFA Antenna	
<b>HW VERSION*</b>	V2.02	
<b>SW VERSION*</b>	2382B01IQ10M5A_M	
<b>I/O PORTS*</b>	Refer to user's manual	
<b>CABLE SUPPLIED*</b>	N/A	
<b>EXTREME TEMPERATURE*</b>	-30-75 °C	
<b>EXTREME VOLTAGE*</b>	3.4V - 4.2V	

**NOTE:**

- \*Since the above data and/or information is provided by the client relevant results or conclusions of this report are only made for these data and/or information, Test Lab is not responsible for the authenticity, integrity and results of the data and information and/or the validity of the conclusion.
- For a more detailed features description, please refer to the manufacturer's specifications or the user's manual.
- The EUT incorporates a SISO function. Physically, the EUT provides one completed transmitter and one receiver.

MODULATION MODE	TX FUNCTION
LTE	1TX/1RX

- For the test results, the EUT had been tested with all conditions. But only the worst case was shown in the test report.



## 2.2 CONFIGURATION OF SYSTEM UNDER TEST

### FOR RADIATION EMISSION

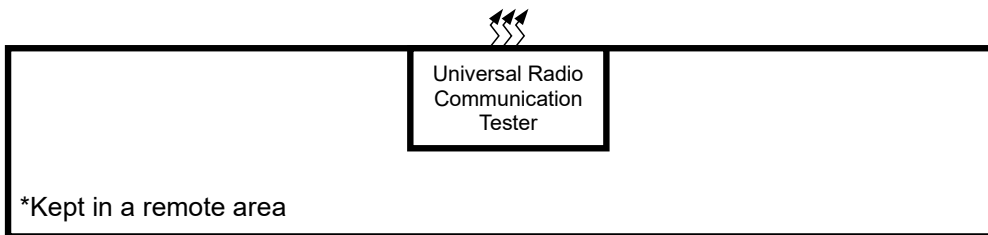
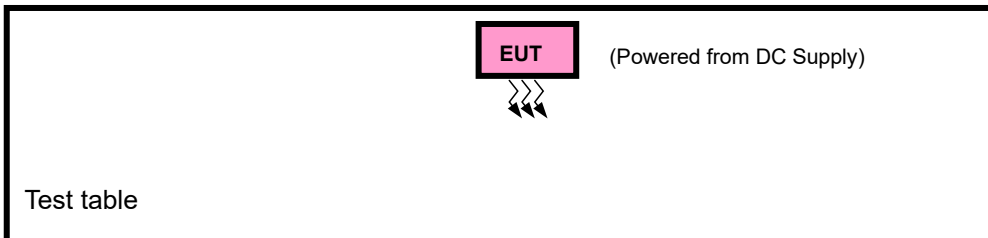
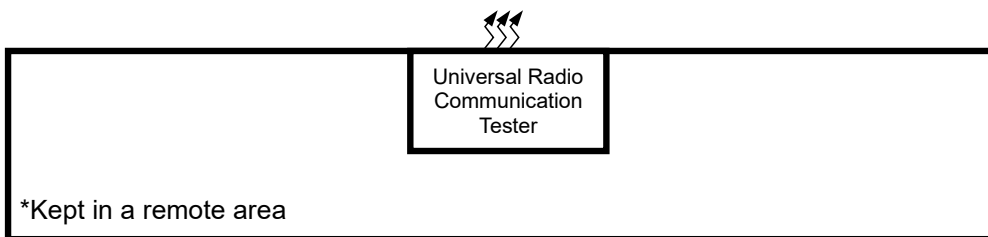
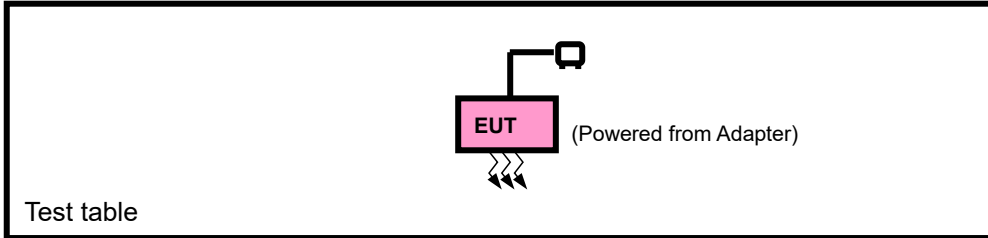



### 2.3 DESCRIPTION OF SUPPORT UNITS

The EUT has been tested as an independent unit together with other necessary accessories or support units. The following support units or accessories were used to form a representative test configuration during the tests.

NO.	PRODUCT	BRAND	MODEL NO.	SERIAL NO.	FCC ID
1	Adapter	N/A	N/A	N/A	N/A
2	DC Source	HYELEC	HY3010B	551016	N/A

NO.	SIGNAL CABLE DESCRIPTION OF THE ABOVE SUPPORT UNITS
1	DC Line: Unshielded, Detachable, 1.0m;
2	N/A

### 2.4 TEST ITEM AND TEST CONFIGURATION

Pre-Scan has been conducted to determine the worst-case mode from all possible combinations between available modulations, data rates, XYZ axis and antenna ports. The worst case in ERP and radiated emission was found when positioned on Y-plane for LTE. Following channel(s) was (were) selected for the final test as listed below:

EUT CONFIGURE MODE	DESCRIPTION
A	EUT + Adapter with LTE link
B	EUT + DC Supply with LTE link

#### LTE BAND 5 MODE

EUT CONFIGURE MODE	TEST ITEM	Available Channel	Tested Channel	Channel bandwidth	modulation	mode
A	ERP	20407 to 20643	20407, 20525, 20643	1.4MHz	QPSK, 16QAM	1 RB / 0 RB offset
		20415 to 20635	20415, 20525, 20635	3MHz	QPSK, 16QAM	1 RB / 0 RB offset
		20425 to 20625	20425, 20525, 20625	5MHz	QPSK, 16QAM	1 RB / 0 RB offset
		20450 to 20600	20450, 20525, 20600	10MHz	QPSK, 16QAM	1 RB / 0 RB offset

**Note:**

1. This device was tested under all bandwidths, RB configurations and modulations. The worst case was found in QPSK modulation.
2. LTE Band 5 are covered by LTE Band 26, Because it is a subset of LTE Band 26 with the same output power and supported bandwidths, So the test data please refer to LTE Band 26



**LTE BAND 26 MODE**

EUT CONFIGURE MODE	TEST ITEM	Available Channel	Tested Channel	Channel bandwidth	modulation	mode
A	ERP	26797 to 27033	26797, 26915, 27033	1.4MHz	QPSK,16QAM	1 RB / 0 RB offset
		26805 to 27025	26805, 26915, 27025	3MHz	QPSK,16QAM	1 RB / 0 RB offset
		26815 to 27015	26815, 26915, 27015	5MHz	QPSK,16QAM	1 RB / 0 RB offset
		26840 to 26990	26840, 26915, 26990	10MHz	QPSK,16QAM	1 RB / 0 RB offset
		26865 to 26965	26865, 26915, 26965	15MHz	QPSK,16QAM	1 RB / 0 RB offset
B	FREQUENCY STABILITY	26865 to 26965	26865, 26915, 26965	15MHz	QPSK	75 RB / 0 RB offset
A	OCCUPIED BANDWIDTH	26797 to 27033	26797, 26915, 27033	1.4MHz	QPSK,16QAM	6 RB / 0 RB offset
		26805 to 27025	26805, 26915, 27025	3MHz	QPSK,16QAM	15 RB / 0 RB offset
		26815 to 27015	26815, 26915, 27015	5MHz	QPSK,16QAM	25 RB / 0 RB offset
		26840 to 26990	26840, 26915, 26990	10MHz	QPSK,16QAM	50 RB / 0 RB offset 27 RB / 0 RB offset
		26865 to 26965	26865, 26915, 26965	15MHz	QPSK,16QAM	75 RB / 0 RB offset 27 RB / 0 RB offset
A	PEAK TO AVERAGE RATIO	26865 to 26965	26865, 26915, 26965	15MHz	QPSK,16QAM	1 RB / 0 RB offset 75 RB / 0 RB offset
A	BAND EDGE	26797 to 27033	26797	1.4 MHz	QPSK,16QAM	1 RB / 0 RB offset
						6 RB / 0 RB offset
		26797 to 27033	27033	1.4 MHz	QPSK,16QAM	1 RB / 5 RB offset
						6 RB / 0 RB offset
		26805 to 27025	26805	3 MHz	QPSK,16QAM	1 RB / 0 RB offset
						15 RB / 0 RB offset
		26805 to 27025	27025	3 MHz	QPSK,16QAM	1 RB / 14 RB offset
						15 RB / 0 RB offset
		26815 to 27015	26815	5MHz	QPSK,16QAM	1 RB / 0 RB offset
						25 RB / 0 RB offset
		26815 to 27015	27015	5MHz	QPSK,16QAM	1 RB / 24 RB offset
						25 RB / 0 RB offset
		26840 to 26990	26840	10MHz	QPSK,16QAM	1 RB / 0 RB offset
50 RB / 0 RB offset						
26840 to 26990	26990	10MHz	QPSK,16QAM	1 RB / 49 RB offset		
				50 RB / 0 RB offset		
26865 to 26965	26865	15MHz	QPSK,16QAM	1 RB / 0 RB offset		



						75 RB / 0 RB offset
		26865 to 26965	26965	15MHz	QPSK, 16QAM	1 RB / 74 RB offset
						75 RB / 0 RB offset
A	CONDCUDED EMISSION	26797 to 27033	26797, 26915, 27033	1.4MHz	QPSK	1 RB / 0 RB offset
		26805 to 27025	26805, 26915, 27025	3MHz	QPSK	1 RB / 0 RB offset
		26815 to 27015	26815, 26915, 27015	5MHz	QPSK	1 RB / 0 RB offset
		26840 to 26990	26840, 26915, 26990	10MHz	QPSK	1 RB / 0 RB offset
		26865 to 26965	26865, 26915, 26965	15MHz	QPSK	1 RB / 0 RB offset
A	RADIATED EMISSION	26797 to 27033	26915	1.4MHz	QPSK	1 RB / 0 RB offset
		26805 to 27025	26915	3MHz	QPSK	1 RB / 0 RB offset
		26815 to 27015	26815, 26915, 27015	5MHz	QPSK	1 RB / 0 RB offset
		26840 to 26990	26915	10MHz	QPSK	1 RB / 0 RB offset
		26865 to 26965	26915	15MHz	QPSK	1 RB / 0 RB offset

**Note:** This device was tested under all bandwidths, RB configurations and modulations. The worst case was found in QPSK modulation.



TEST CONDITION			
TEST ITEM	ENVIRONMENTAL CONDITIONS	INPUT POWER	TESTED BY
ERP	23deg. C, 70%RH	EUT 3.8V	Hanwen Xu
FREQUENCY STABILITY	23deg. C, 70%RH	DC 3.0V/3.8V/4.2V By DC Supply	Hanwen Xu
OCCUPIED BANDWIDTH	23deg. C, 70%RH	EUT 3.8V	Hanwen Xu
BAND EDGE	23deg. C, 70%RH	EUT 3.8V	Hanwen Xu
CONDCUDED EMISSION	23deg. C, 70%RH	EUT 3.8V	Hanwen Xu
RADIATED EMISSION	23deg. C, 70%RH	EUT 3.8V	Hanwen Xu
PEAK TO AVERAGE RATIO	23deg. C, 70%RH	EUT 3.8V	Hanwen Xu



## **2.5 EUT OPERATING CONDITIONS**

The EUT makes a call to the communication simulator. The communication simulator station system controlled a EUT to export maximum output power under transmission mode and specific channel frequency

## **2.6 GENERAL DESCRIPTION OF APPLIED STANDARDS**

The EUT is a RF product. According to the specifications of the manufacturer, it must comply with the requirements of the following standards:

**FCC 47 CFR Part 2**

**FCC 47 CFR Part 22**

**KDB 971168 D01 Power Meas License Digital Systems v03r01**

**ANSI/TIA/EIA-603-D**

**ANSI/TIA/EIA-603-E**

**ANSI C63.26-2015**

**NOTE:** All test items have been performed and recorded as per the above standards.





### 3 TEST TYPES AND RESULTS

#### 3.1 OUTPUT POWER MEASUREMENT

##### 3.1.1 LIMITS OF OUTPUT POWER MEASUREMENT

Mobile / Portable station are limited to 7 watts e.r.p.

##### 3.1.2 TEST PROCEDURES

###### **EIRP / ERP MEASUREMENT:**

Per KDB 971168 D01 Power Meas License Digital Systems v03r01 or subclause 5.2.5.5 of ANSI C63.26-2015, the relevant equation for determining the ERP or EIRP from the conducted RF output power measured using the guidance provided above is:

$$\text{ERP or EIRP} = P_{\text{Meas}} + G_{\text{T}} - L_{\text{C}}$$

Where:

ERP or EIRP = effective radiated power or equivalent isotropically radiated power, respectively

(expressed in the same units as  $P_{\text{Meas}}$ , typically dBW or dBm);

$P_{\text{Meas}}$  = measured transmitter output power or PSD, in dBm or dBW;

$G_{\text{T}}$  = gain of the transmitting antenna, in dBd (ERP) or dBi (EIRP);

$L_{\text{C}}$  = signal attenuation in the connecting cable between the transmitter and antenna, in dB.

###### **CONDUCTED POWER MEASUREMENT:**

The EUT was set up for the maximum power with WCDMA link data modulation and link up with simulator. Set the EUT to transmit under low, middle and high channel and record the power level shown on simulator.



### 3.1.3 TEST SETUP

**EIRP / ERP Measurement:**

**CONDUCTED POWER MEASUREMENT:**

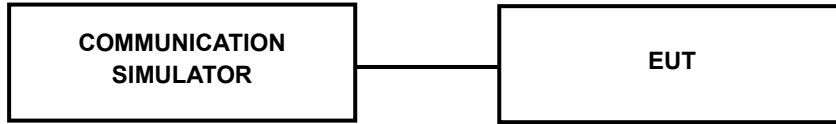



### 3.1.4 TEST RESULTS

#### CONDUCTED OUTPUT POWER (dBm):

LTE Band 5						
Band/BW	Modulation	RB Size	RB offset	Low CH20407	Mid CH20525	High CH20643
				Frequency 824.7 MHz	Frequency 836.5 MHz	Frequency 848.3 MHz
5/ 1.4	QPSK	1	0	23.04	22.68	22.85
		1	2	23.34	23.06	23.59
		1	5	22.74	23.17	22.81
		3	0	22.95	22.63	23.11
		3	1	23.04	22.59	23.30
		3	3	22.78	22.80	23.02
		6	0	22.21	21.94	22.54
	16QAM	1	0	22.02	21.75	21.89
		1	2	22.50	22.26	22.51
		1	5	22.20	22.10	22.28
		3	0	21.98	22.04	22.01
		3	1	22.19	22.14	22.10
		3	3	22.28	22.12	22.19
		6	0	21.95	21.88	21.91
Band/BW	Modulation	RB Size	RB offset	Low CH20415	Mid CH20525	High CH20635
				Frequency 825.5 MHz	Frequency 836.5 MHz	Frequency 847.5 MHz
5/ 3	QPSK	1	0	22.97	22.68	22.92
		1	7	23.43	23.06	23.66
		1	14	22.67	23.04	22.86
		8	0	22.30	21.97	22.45
		8	3	22.38	21.95	22.59
		8	7	22.14	22.11	22.43
		15	0	22.27	21.92	22.51
	16QAM	1	0	21.94	21.80	21.84
		1	7	22.44	22.36	22.50
		1	14	22.18	21.97	22.18
		8	0	21.96	22.03	22.00
		8	3	22.30	22.18	22.08
		8	7	22.26	22.19	22.20
		15	0	21.91	21.83	21.97



LTE Band 5						
Band/BW	Modulation	RB Size	RB offset	Low CH20425	Mid CH20525	High CH20625
				Frequency 826.5 MHz	Frequency 836.5 MHz	Frequency 846.5 MHz
5/ 5	QPSK	1	0	23.01	22.67	22.91
		1	12	23.48	23.08	23.62
		1	24	22.71	23.17	22.90
		12	0	22.33	21.99	22.45
		12	6	22.38	21.99	22.66
		12	13	22.16	22.00	22.44
		25	0	22.31	22.04	22.48
	16QAM	1	0	21.90	21.71	21.78
		1	12	22.56	22.26	22.44
		1	24	22.16	22.06	22.21
		12	0	22.08	21.95	22.08
		12	6	22.30	22.12	22.08
		12	13	22.32	22.09	22.13
		25	0	21.99	21.88	21.96
Band/BW	Modulation	RB Size	RB offset	Low CH20450	Mid CH20525	High CH20600
				Frequency 829 MHz	Frequency 836.5 MHz	Frequency 844 MHz
5/ 10	QPSK	1	0	23.08	22.70	22.99
		1	24	23.49	23.14	23.70
		1	49	22.82	23.19	22.94
		25	0	22.35	22.05	22.54
		25	12	22.39	22.04	22.69
		25	25	22.24	22.15	22.46
		50	0	22.36	22.06	22.55
	16QAM	1	0	22.03	21.86	21.92
		1	12	22.57	22.39	22.54
		1	24	22.23	22.12	22.33
		12	0	22.10	22.06	22.14
		12	17	22.32	22.22	22.17
		12	36	22.40	22.21	22.23
		27	0	22.00	21.94	22.04



LTE BAND 26						
Band/BW	Modulation	RB Size	RB offset	Low CH26797	Mid CH26915	High CH27033
				Frequency 824.7 MHz	Frequency 836.5 MHz	Frequency 848.3 MHz
26/ 1.4	QPSK	1	0	22.36	22.69	22.87
		1	2	22.88	22.68	22.60
		1	5	22.50	22.59	21.95
		3	0	22.39	22.72	22.39
		3	1	22.71	22.54	22.52
		3	3	22.58	22.47	22.31
		6	0	21.83	21.89	21.61
	16QAM	1	0	21.41	22.13	21.91
		1	2	22.15	22.18	21.89
		1	5	21.77	21.67	21.95
		3	0	21.52	22.02	21.86
		3	1	21.59	22.04	21.87
		3	3	21.56	21.95	21.77
		6	0	20.57	21.04	20.82
Band/BW	Modulation	RB Size	RB offset	Low CH26805	Mid CH26915	High CH27025
				Frequency 825.5 MHz	Frequency 836.5 MHz	Frequency 847.5 MHz
26/ 3	QPSK	1	0	22.40	22.66	22.79
		1	7	22.85	22.64	22.62
		1	14	22.43	22.65	21.58
		8	0	21.62	22.00	21.63
		8	3	21.94	21.87	21.73
		8	7	21.73	21.64	21.44
		15	0	21.83	21.82	21.54
	16QAM	1	0	21.48	22.01	21.98
		1	7	22.16	22.24	21.81
		1	14	21.65	21.77	22.00
		8	0	21.51	22.05	21.81
		8	3	21.51	21.99	21.73
		8	7	21.62	21.93	21.73
		15	0	20.58	20.93	20.72



LTE BAND 26						
Band/BW	Modulation	RB Size	RB offset	Low CH26815	Mid CH26915	High CH27015
				Frequency 826.5 MHz	Frequency 836.5 MHz	Frequency 846.5 MHz
26/ 5	QPSK	1	0	22.28	22.74	22.91
		1	12	22.74	22.71	22.63
		1	24	22.52	22.58	21.60
		12	0	21.70	22.00	21.64
		12	6	21.90	21.73	21.73
		12	13	21.77	21.66	21.42
		25	0	21.69	21.89	21.64
	16QAM	1	0	21.49	22.13	21.95
		1	12	22.07	22.24	21.88
		1	24	21.69	21.68	21.94
		12	0	21.52	22.04	21.83
		12	6	21.59	22.00	21.78
		12	13	21.59	21.88	21.65
		25	0	20.64	21.02	20.79
Band/BW	Modulation	RB Size	RB offset	Low CH26840	Mid CH26915	High CH26990
				Frequency 829 MHz	Frequency 836.5 MHz	Frequency 844 MHz
26/10	QPSK	1	0	22.31	22.69	22.82
		1	24	22.79	22.60	22.62
		1	49	22.43	22.66	21.57
		25	0	21.65	21.88	21.57
		25	12	21.90	21.75	21.63
		25	25	21.81	21.66	21.53
		50	0	21.79	21.79	21.58
	16QAM	1	0	21.49	22.01	22.03
		1	12	22.06	22.21	21.85
		1	24	21.72	21.73	21.87
		12	0	21.51	22.01	21.83
		12	17	21.62	21.99	21.75
		12	36	21.63	21.94	21.72
		27	0	20.65	21.01	20.77



LTE BAND 26						
Band/BW	Modulation	RB Size	RB offset	Low CH26865	Mid CH26915	High CH26965
				Frequency 831.5 MHz	Frequency 836.5 MHz	Frequency 841.5 MHz
26/ 15	QPSK	1	0	22.95	22.89	22.39
		1	37	22.87	22.78	23.37
		1	74	22.59	23.26	22.93
		36	0	21.94	21.81	21.77
		36	19	21.77	21.95	22.29
		36	39	21.55	22.16	22.35
		75	0	21.82	21.94	22.08
	16QAM	1	0	21.56	22.11	22.08
		1	37	22.17	22.28	21.98
		1	74	21.74	21.88	22.01
		12	0	21.50	22.08	21.94
		12	30	21.61	22.01	21.86
		12	61	21.61	22.00	21.70
		27	0	20.64	21.06	20.88



**ERP POWER (dBm)**

LTE BAND 5						
1.4MHz QPSK						
Channel	Frequency (MHz)	Conducted Power (dBm)	G <sub>T</sub> -L <sub>C</sub> (dB)	ERP (dBm)	ERP (mW)	Limit (W)
20407	824.7	23.34	0.91	22.1	162.18	7
20525	836.5	23.17	0.91	21.93	155.96	7
20643	848.3	23.59	0.91	22.35	171.79	7

CHANNEL BANDWIDTH: 1.4MHz 16QAM						
Channel	Frequency (MHz)	Conducted Power (dBm)	G <sub>T</sub> -L <sub>C</sub> (dB)	ERP (dBm)	ERP (mW)	Limit (W)
20407	824.7	22.50	0.91	21.26	133.66	7
20525	836.5	22.26	0.91	21.02	126.47	7
20643	848.3	22.51	0.91	21.27	133.97	7

CHANNEL BANDWIDTH: 3MHz QPSK						
Channel	Frequency (MHz)	Conducted Power (dBm)	G <sub>T</sub> -L <sub>C</sub> (dB)	ERP (dBm)	ERP (mW)	Limit (W)
20415	825.5	23.43	0.91	22.19	165.58	7
20525	836.5	23.06	0.91	21.82	152.05	7
20635	847.5	23.66	0.91	22.42	174.58	7

CHANNEL BANDWIDTH: 3MHz 16QAM						
Channel	Frequency (MHz)	Conducted Power (dBm)	G <sub>T</sub> -L <sub>C</sub> (dB)	ERP (dBm)	ERP (mW)	Limit (W)
20415	825.5	22.44	0.91	21.2	131.83	7
20525	836.5	22.36	0.91	21.12	129.42	7
20635	847.5	22.50	0.91	21.26	133.66	7





CHANNEL BANDWIDTH: 5MHz QPSK						
Channel	Frequency (MHz)	Conducted Power (dBm)	G <sub>T</sub> -L <sub>C</sub> (dB)	ERP (dBm)	ERP (mW)	Limit (W)
20425	826.5	23.48	0.91	22.24	167.49	7
20525	836.5	23.17	0.91	21.93	155.96	7
20625	846.5	23.62	0.91	22.38	172.98	7

CHANNEL BANDWIDTH: 5MHz 16QAM						
Channel	Frequency (MHz)	Conducted Power (dBm)	G <sub>T</sub> -L <sub>C</sub> (dB)	ERP (dBm)	ERP (mW)	Limit (W)
20425	826.5	22.56	0.91	21.32	135.52	7
20525	836.5	22.26	0.91	21.02	126.47	7
20625	846.5	22.44	0.91	21.2	131.83	7

CHANNEL BANDWIDTH: 10MHz QPSK						
Channel	Frequency (MHz)	Conducted Power (dBm)	G <sub>T</sub> -L <sub>C</sub> (dB)	ERP (dBm)	ERP (mW)	Limit (W)
20450	829	23.49	0.91	22.25	167.88	7
20525	836.5	23.19	0.91	21.95	156.68	7
20600	844	23.70	0.91	22.46	176.2	7

CHANNEL BANDWIDTH: 10MHz 16QAM						
Channel	Frequency (MHz)	Conducted Power (dBm)	G <sub>T</sub> -L <sub>C</sub> (dB)	ERP (dBm)	ERP (mW)	Limit (W)
20450	829	22.57	0.91	21.33	135.83	7
20525	836.5	22.39	0.91	21.15	130.32	7
20600	844	22.54	0.91	21.3	134.9	7



**LTE BAND 26**

CHANNEL BANDWIDTH: 1.4MHz QPSK						
Channel	Frequency (MHz)	Conducted Power (dBm)	G <sub>T</sub> -L <sub>C</sub> (dB)	ERP (dBm)	ERP (mW)	Limit (W)
26797	824.7	22.88	0.91	21.64	145.88	7
26915	836.5	22.72	0.91	21.48	140.6	7
27033	848.3	22.87	0.91	21.63	145.55	7

CHANNEL BANDWIDTH: 1.4MHz 16QAM						
Channel	Frequency (MHz)	Conducted Power (dBm)	G <sub>T</sub> -L <sub>C</sub> (dB)	ERP (dBm)	ERP (mW)	Limit (W)
26797	824.7	22.15	0.91	20.91	123.31	7
26915	836.5	22.18	0.91	20.94	124.17	7
27033	848.3	21.95	0.91	20.71	117.76	7

CHANNEL BANDWIDTH: 3MHz QPSK						
Channel	Frequency (MHz)	Conducted Power (dBm)	G <sub>T</sub> -L <sub>C</sub> (dB)	ERP (dBm)	ERP (mW)	Limit (W)
26805	825.5	22.85	0.91	21.61	144.88	7
26915	836.5	22.66	0.91	21.42	138.68	7
27025	847.5	22.79	0.91	21.55	142.89	7

CHANNEL BANDWIDTH: 3MHz 16QAM						
Channel	Frequency (MHz)	Conducted Power (dBm)	G <sub>T</sub> -L <sub>C</sub> (dB)	ERP (dBm)	ERP (mW)	Limit (W)
26805	825.5	22.16	0.91	20.92	123.59	7
26915	836.5	22.24	0.91	21	125.89	7
27025	847.5	22.00	0.91	20.76	119.12	7



CHANNEL BANDWIDTH: 5MHz QPSK						
Channel	Frequency (MHz)	Conducted Power (dBm)	G <sub>T</sub> -L <sub>C</sub> (dB)	ERP (dBm)	ERP (mW)	Limit (W)
26815	826.5	22.74	0.91	21.5	141.25	7
26915	836.5	22.74	0.91	21.5	141.25	7
27015	846.5	22.91	0.91	21.67	146.89	7

CHANNEL BANDWIDTH: 5MHz 16QAM						
Channel	Frequency (MHz)	Conducted Power (dBm)	G <sub>T</sub> -L <sub>C</sub> (dB)	ERP (dBm)	ERP (mW)	Limit (W)
26815	826.5	22.07	0.91	20.83	121.06	7
26915	836.5	22.24	0.91	21	125.89	7
27015	846.5	21.95	0.91	20.71	117.76	7

CHANNEL BANDWIDTH: 10MHz QPSK						
Channel	Frequency (MHz)	Conducted Power (dBm)	G <sub>T</sub> -L <sub>C</sub> (dB)	ERP (dBm)	ERP (mW)	Limit (W)
26840	829	22.79	0.91	21.55	142.89	7
26915	836.5	22.69	0.91	21.45	139.64	7
26990	844	22.82	0.91	21.58	143.88	7

CHANNEL BANDWIDTH: 10MHz 16QAM						
Channel	Frequency (MHz)	Conducted Power (dBm)	G <sub>T</sub> -L <sub>C</sub> (dB)	ERP (dBm)	ERP (mW)	Limit (W)
26840	829	22.06	0.91	20.82	120.78	7
26915	836.5	22.21	0.91	20.97	125.03	7
26990	844	22.03	0.91	20.79	119.95	7



CHANNEL BANDWIDTH: 15MHz QPSK						
Channel	Frequency (MHz)	Conducted Power (dBm)	G <sub>T</sub> -L <sub>C</sub> (dB)	ERP (dBm)	ERP (mW)	Limit (W)
26865	831.5	22.95	0.91	21.71	148.25	7
26915	836.5	23.26	0.91	22.02	159.22	7
26965	841.5	23.37	0.91	22.13	163.31	7

CHANNEL BANDWIDTH: 15MHz 16QAM						
Channel	Frequency (MHz)	Conducted Power (dBm)	G <sub>T</sub> -L <sub>C</sub> (dB)	ERP (dBm)	ERP (mW)	Limit (W)
26865	831.5	22.17	0.91	20.93	123.88	7
26915	836.5	22.28	0.91	21.04	127.06	7
26965	841.5	22.08	0.91	20.84	121.34	7

**REMARKS:** ERP Output Power (dBm) = EIRP (dBm) -2.15(dB).



### 3.2 FREQUENCY STABILITY MEASUREMENT

#### 3.2.1 LIMITS OF FREQUENCY STABILITY MEASUREMENT

1.5 ppm is for base and fixed station. 2.5 ppm is for mobile station.

#### 3.2.2 TEST PROCEDURE

- a. Device is placed at the oven room. The oven room could control the temperatures and humidity. Power warm up is at least 15 min and power applied should perform before recording frequency error.
- b. EUT is connected the external power supply to control the DC input power. The test voltage range is from minimum to maximum working voltage. Each step shall be record the frequency error rate.
- c. The temperature range step is 10 degrees in this test items. All temperature levels shall be hold the  $\pm 0.5^{\circ}\text{C}$  during the measurement testing. The each temperature step shall be at least 0.5 hours, consider the EUT could be test under the stability condition.

NOTE: The frequency error was recorded frequency error from the communication simulator.

#### 3.2.3 TEST SETUP

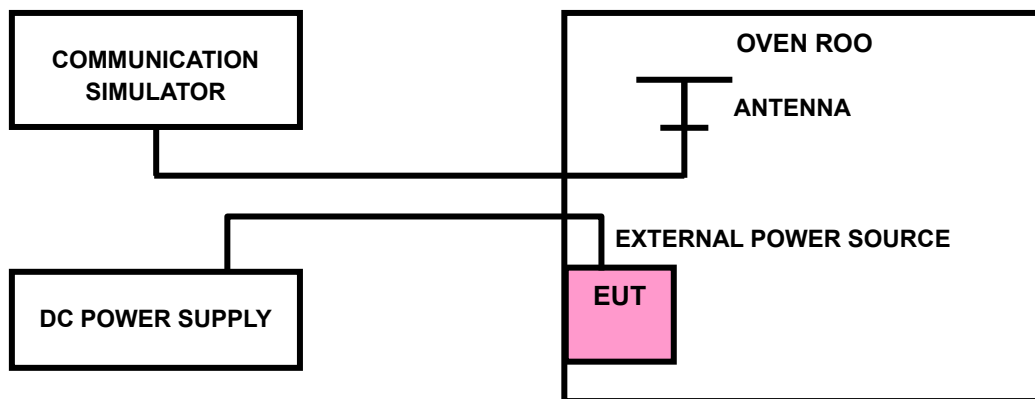

#### 3.2.4 TEST RESULTS

Please Refer to Appendix of this test report.

Note: VL = Low voltage(3.4V); VN/NV = Normal voltage(3.8V); VH = High voltage(4.2V);

NT = Normal temperature (25°C)



### 3.3 OCCUPIED BANDWIDTH MEASUREMENT

#### 3.3.1 LIMITS OF OCCUPIED BANDWIDTH MEASUREMENT

The width of a frequency band such that, below the lower and above the upper frequency limits, the mean powers emitted are each equal to a specified percentage 0.5 % of the total mean power of a given emission.

#### 3.3.2 TEST SETUP

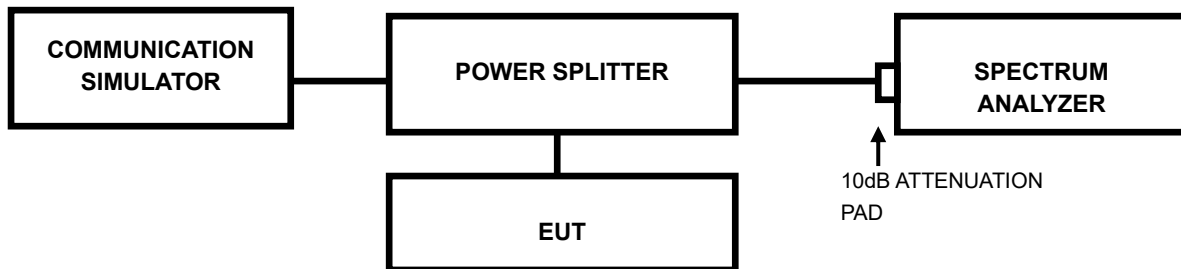

#### 3.3.3 TEST PROCEDURES

- The conducted occupied bandwidth used the power splitter via EUT RF power connector between simulation base station and spectrum analyzer.
- Use OBW measurement function of Spectrum analyzer to measure 99 % occupied bandwidth.

#### 3.3.4 TEST RESULTS

Please Refer to Appendix of this test report.



### 3.4 BAND EDGE MEASUREMENT

#### 3.4.1 LIMITS OF BAND EDGE MEASUREMENT

Power of any emission outside of the authorized operating frequency ranges must be attenuated below the transmitting power (P) by a factor of at least  $43 + 10 \log(P)$  dB. In the 1 MHz bands immediately outside and adjacent to the frequency block a resolution bandwidth of at least one percent of the emission bandwidth of the fundamental emission of the transmitter may be employed.

#### 3.4.2 TEST SETUP

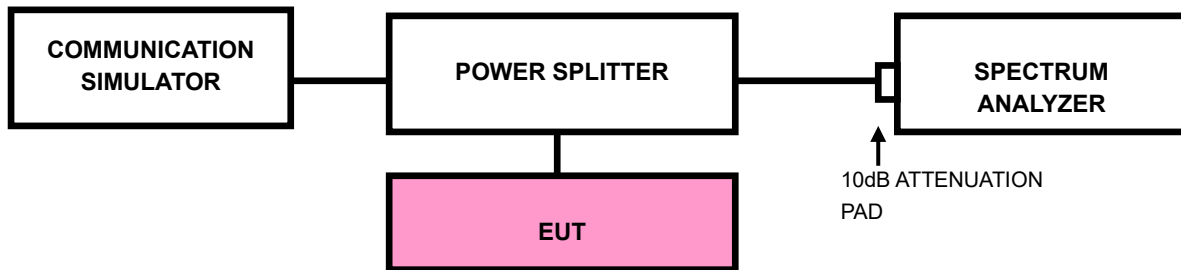



### 3.4.3 TEST PROCEDURES

- a) All measurements were done at low and high operational frequency range
- b) Connect the transmitter to the spectrum analyzer via coaxial cable while ensuring proper impedance matching.
- c) Tune the analyzer to the nominal center frequency of the emission bandwidth  
(EBW)
- d) .Set the resolution bandwidth (RBW)  $\geq 1\%$  EBW in the 1MHz band immediately outside and adjacent to the band edge.
- e) Beyond the 1MHz band from the band edge, RBW=1MHz was used.
- f) Set the video bandwidth (VBW) to  $\geq 3 \times$  RBW.
- g) Select the average power (RMS) display detector.
- h) Set the number of measurement points to  $\geq 1001$ .
- i) Use auto-coupled sweep time.
- j) Perform the measurement over an interval of time when the transmission is continuous and at its maximum power level.
- k) The RF fundamental frequency should be excluded against the limit line in the operating frequency band and use RBW is 10KHz or 100KHz.
- l) Record the max trace plot into the test report.

### 3.4.4 TEST RESULTS

Please Refer to Appendix of this test report.





### 3.5 CONDUCTED SPURIOUS EMISSIONS

#### 3.5.1 LIMITS OF CONDUCTED SPURIOUS EMISSIONS MEASUREMENT

The power of any emission outside of the authorized operating frequency ranges must be attenuated below the transmitting power (P) by a factor of at least  $43 + 10 \log(P)$  dB. The emission limit equal to  $-13\text{dBm}$ .

#### 3.5.2 TEST PROCEDURE

- a. The EUT makes a phone call to the communication simulator. All measurements were done at low, middle and high operational frequency range.
- b. Measuring frequency range is from 9kHz up to a frequency including its 10<sup>th</sup> harmonic. 10dB attenuation pad is connected with spectrum. RBW=1MHz and VBW=3MHz is used for conducted emission measurement.

#### 3.5.3 TEST SETUP

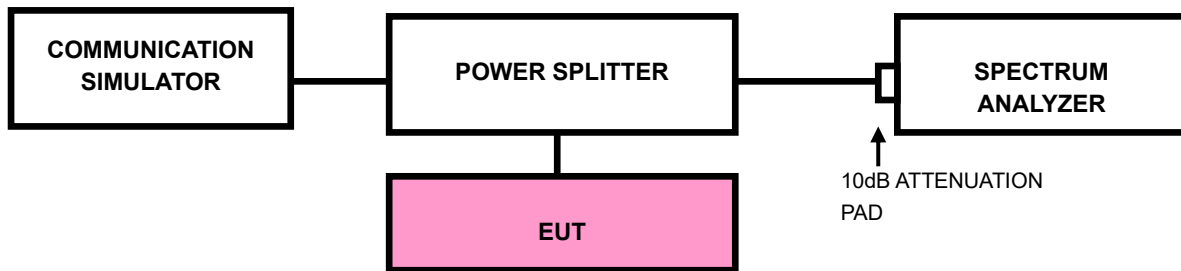

#### 3.5.4 TEST RESULTS

NOTE : The 9K~30MHz amplitude of spurious emissions attenuated more than 20 dB below the permissible value is not required in the report.

Please Refer to Appendix of this test report.



### 3.6 RADIATED EMISSION MEASUREMENT

#### 3.6.1 LIMITS OF RADIATED EMISSION MEASUREMENT

The power of any emission outside of the authorized operating frequency ranges must be attenuated below the transmitting power (P) by a factor of at least  $43 + 10 \log(P)$  dB. The emission limit equal to  $-13\text{dBm}$ .

#### 3.6.2 TEST PROCEDURES

- a. Substitution method is used for E.I.R.P measurement. In the semi-anechoic chamber, EUT placed on the 0.8m height of Turn Table, rotated the table around 360 degrees to search the maximum radiation power and receiver antenna shall be rotated vertical and horizontal polarization and moved height from 1m to 4m to find the maximum polar radiated power. The “Read Value” is the spectrum reading the maximum power value.
- b. The substitution horn antenna is substituted for EUT at the same position and signals generator export the CW signal to the substitution antenna via a TX cable. Rotated the Turn Table and moved receiving antenna to find the maximum radiation power. Adjust output power level of S.G to get a Value of spectrum reading equal to “Read Value “ of step a. Record the power level of S.G
- c.  $\text{EIRP} = \text{Output power level of S.G} - \text{TX cable loss} + \text{Antenna gain of substitution horn}$ .
- d. E.R.P power can be calculated form E.I.R.P power by subtracting the gain of dipole,  $\text{E.R.P power} = \text{E.I.P.R power} - 2.15\text{dBi}$ .

**NOTE:** The resolution bandwidth and video bandwidth of test receiver/spectrum analyzer is 1MHz/3MHz.

#### 3.6.3 DEVIATION FROM TEST STANDARD

No deviation



### 3.6.4 TEST SETUP

#### < Frequency Range below 30MHz >

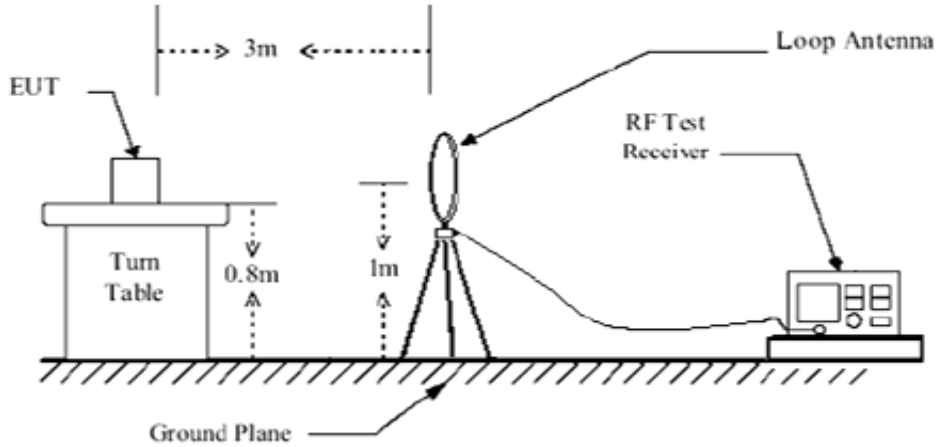

#### < Frequency Range 30MHz~1GHz >

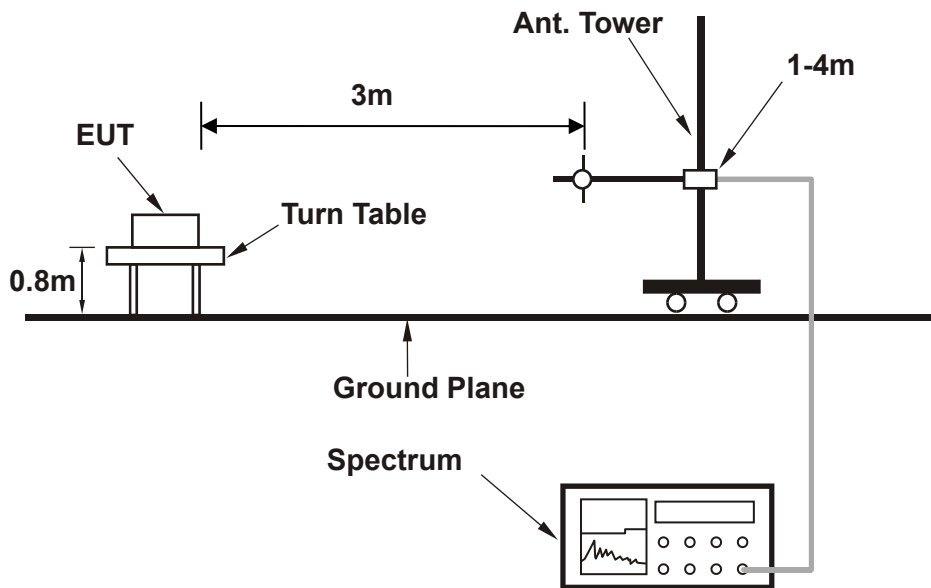



<Frequency Range above 1GHz>

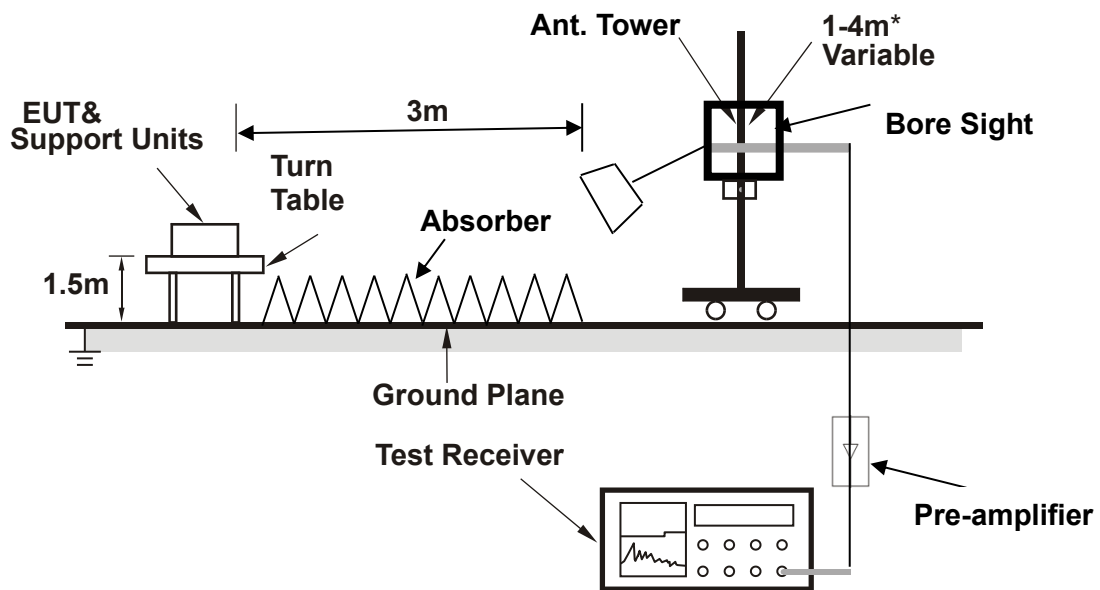

**Note:** Above 1G is a directional antenna

Depends on the EUT height and the antenna 3dB beamwidth both, refer to section 7.3 of CISPR 16-2-3.

For the actual test configuration, please refer to the attached file (Test Setup Photo).



### 3.6.5 TEST RESULTS

NOTE : The 9K~30MHz amplitude of spurious emissions attenuated more than 20 dB below the permissible value is not required in the report.

**BELOW 1GHz WORST-CASE DATA**

LTE Band 26			
CHANNEL BANDWIDTH: 5MHz / QPSK			
<b>MODE</b>	TX channel 26365	<b>FREQUENCY RANGE</b>	30 MHz – 1GHz
<b>ENVIRONMENTAL CONDITIONS</b>	23deg. C, 70%RH	<b>INPUT POWER</b>	120Vac 60HZ
<b>TESTED BY</b>	Hanwen Xu		

**ANTENNA POLARITY & TEST DISTANCE: HORIZONTAL AT 3 M**

Rg	Frequency [MHz]	PK+ Level [dBm]	PK+ Limit [dBm]	PK+ Margin [dB]	Correction [dB]	Polarization	Azimuth [deg]	Antenna Height [m]
1	36.750	-68.75	-13.00	55.75	-0.11	H	149.1	2.00
1	63.800	-77.32	-13.00	64.32	-6.64	H	0.9	2.00
1	116.900	-82.83	-13.00	69.83	-12.38	H	359	2.00
1	169.200	-74.03	-13.00	61.03	-9.92	H	163	1.00
1	238.850	-66.52	-13.00	53.52	-0.13	H	149.1	2.00
1	382.600	-78.79	-13.00	65.79	0.47	H	332.8	1.00

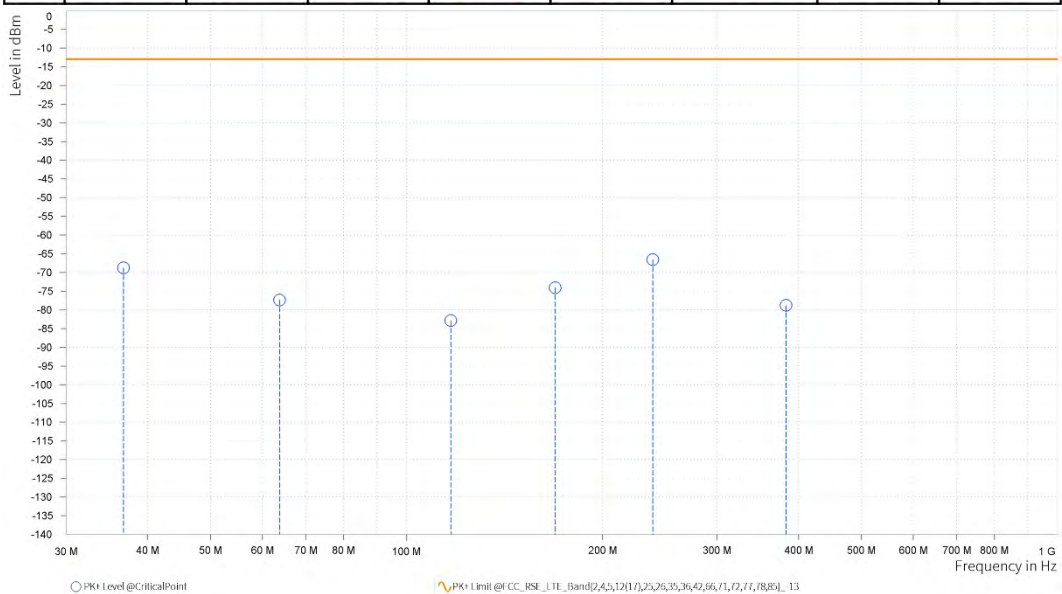



<b>MODE</b>	TX channel 26365	<b>FREQUENCY RANGE</b>	30 MHz – 1GHz
<b>ENVIRONMENTAL CONDITIONS</b>	23deg. C, 70%RH	<b>INPUT POWER</b>	120Vac 60HZ
<b>TESTED BY</b>	Hanwen Xu		

**ANTENNA POLARITY & TEST DISTANCE: VERTICAL AT 3 M**

Rg	Frequency [MHz]	PK+ Level [dBm]	PK+ Limit [dBm]	PK+ Margin [dB]	Correction [dB]	Polarization	Azimuth [deg]	Antenna Height [m]
1	37.000	-72.34	-13.00	59.34	-8.37	V	228.7	1.00
1	61.650	-70.01	-13.00	57.01	-9.08	V	301.7	1.00
1	98.900	-60.57	-13.00	47.57	5.06	V	149.1	2.00
1	188.550	-68.02	-13.00	55.02	-8.73	V	6.2	1.00
1	327.450	-62.87	-13.00	49.87	-1.53	V	216.1	2.00
1	443.150	-62.84	-13.00	49.84	0.71	V	337.4	1.00

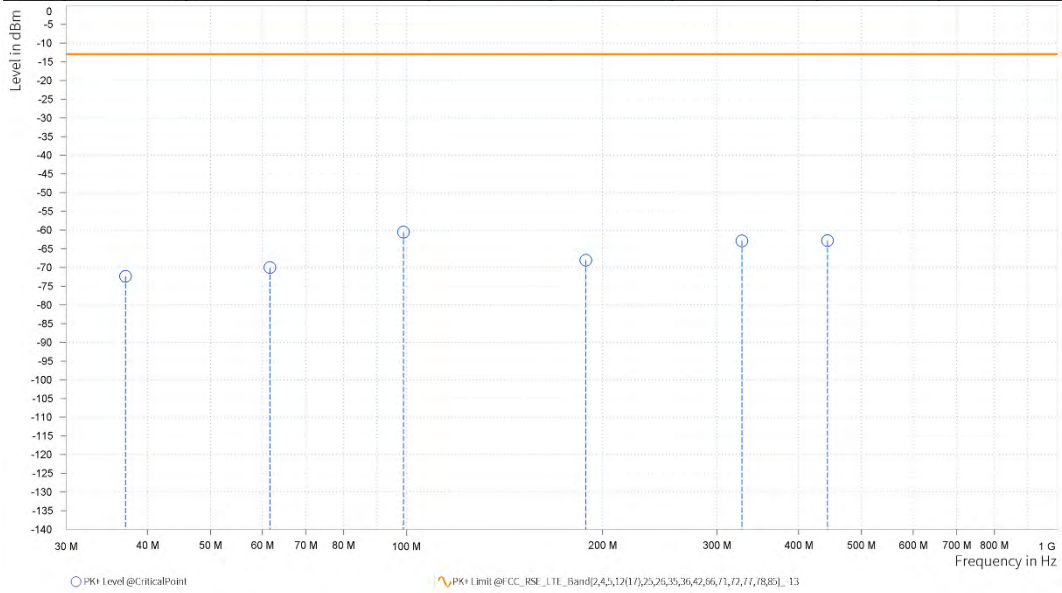



ABOVE 1GHz DATA

Note: For higher frequency, the emission is too low to be detected.

LTE Band 26			
CHANNEL BANDWIDTH	1.4MHz/QPSK	MODE	TX channel 26915
FREQUENCY RANGE	Above 1000MHz	ENVIRONMENTAL CONDITIONS	23deg. C, 70%RH
INPUT POWER	120Vac 60HZ	TESTED BY	Hanwen Xu

ANTENNA POLARITY & TEST DISTANCE: HORIZONTAL AT 3 M

Rg	Frequency [MHz]	PK+ Level [dBm]	PK+ Limit [dBm]	PK+ Margin [dB]	Correction [dB]	Polarization	Azimuth [deg]	Antenna Height [m]
2	1,671.740	-51.08	-13.00	38.08	19.83	H	359	2.00
3	2,507.610	-46.84	-13.00	33.84	23.81	H	1	2.00

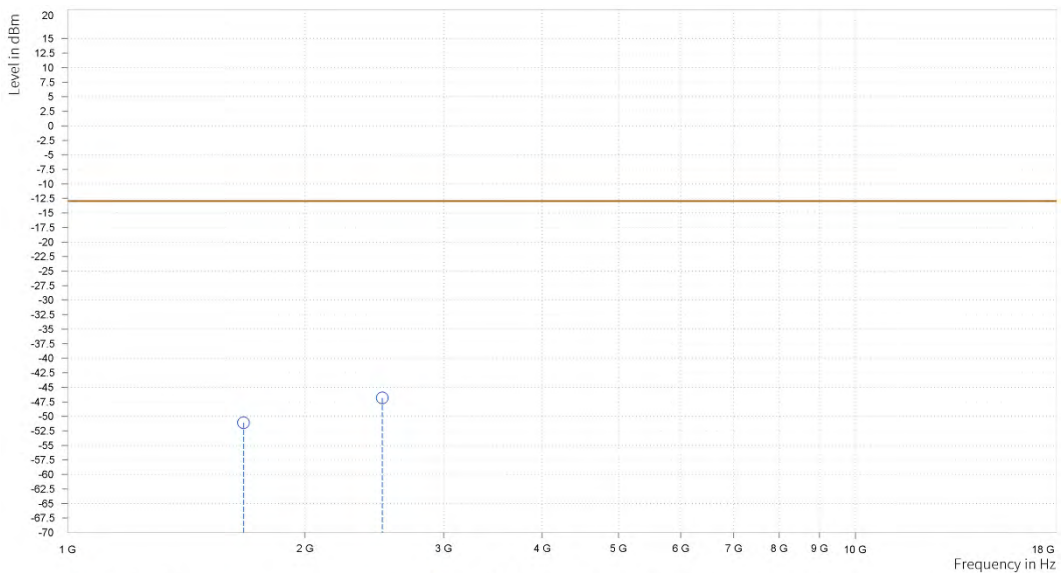



<b>CHANNEL BANDWIDTH</b>	1.4MHz/QPSK	<b>MODE</b>	TX channel 26915
<b>FREQUENCY RANGE</b>	Above 1000MHz	<b>ENVIRONMENTAL CONDITIONS</b>	23deg. C, 70%RH
<b>INPUT POWER</b>	120Vac 60HZ	<b>TESTED BY</b>	Hanwen Xu

**ANTENNA POLARITY & TEST DISTANCE: VERTICAL AT 3 M**

Rg	Frequency [MHz]	PK+ Level [dBm]	PK+ Limit [dBm]	PK+ Margin [dB]	Correction [dB]	Polarization	Azimuth [deg]	Antenna Height [m]
2	1,671.740	-50.45	-13.00	37.45	19.62	V	1	1.00
3	2,507.610	-48.37	-13.00	35.37	23.47	V	359	2.00

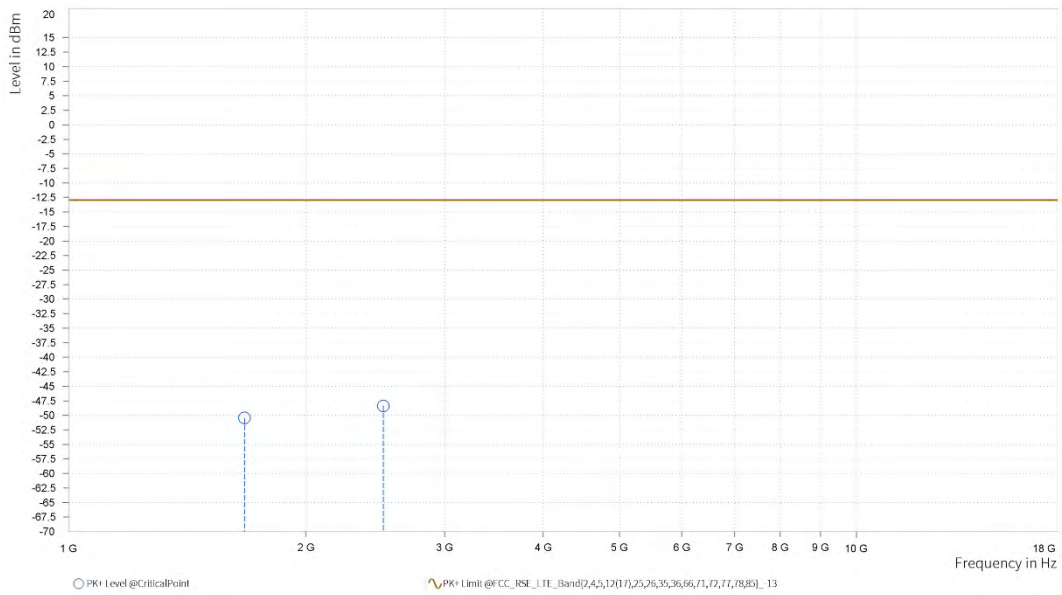





<b>CHANNEL BANDWIDTH</b>	3MHz/QPSK	<b>MODE</b>	TX channel 26915
<b>FREQUENCY RANGE</b>	Above 1000MHz	<b>ENVIRONMENTAL CONDITIONS</b>	23deg. C, 70%RH
<b>INPUT POWER</b>	120Vac 60HZ	<b>TESTED BY</b>	Hanwen Xu

**ANTENNA POLARITY & TEST DISTANCE: HORIZONTAL AT 3 M**

Rg	Frequency [MHz]	PK+ Level [dBm]	PK+ Limit [dBm]	PK+ Margin [dB]	Correction [dB]	Polarization	Azimuth [deg]	Antenna Height [m]
2	1,670.300	-49.94	-13.00	36.94	19.79	H	72.4	1.00
3	2,505.450	-47.39	-13.00	34.39	23.83	H	1	1.00

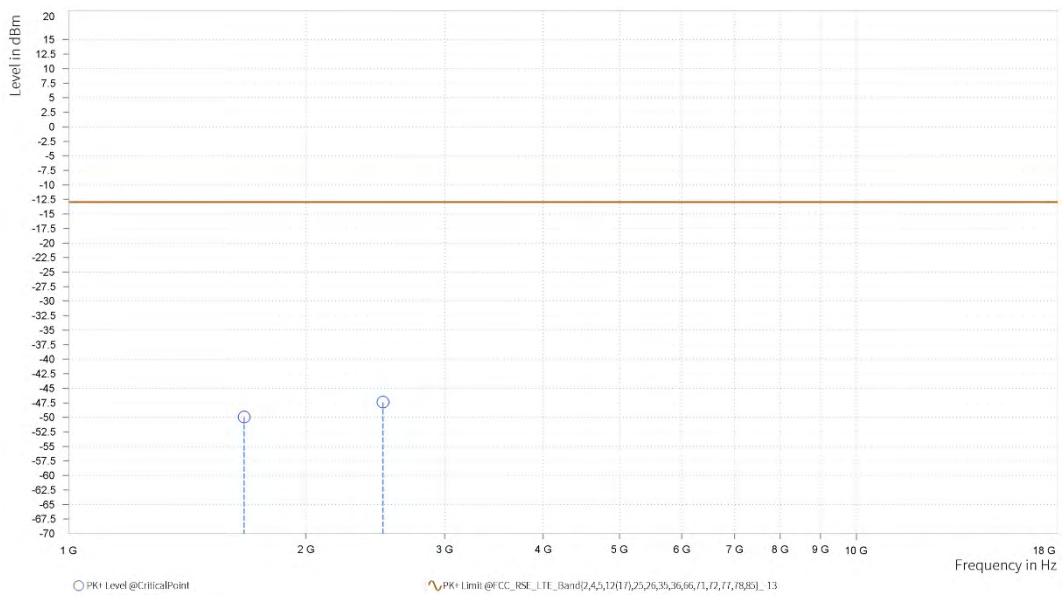



<b>CHANNEL BANDWIDTH</b>	3MHz/QPSK	<b>MODE</b>	TX channel 26915
<b>FREQUENCY RANGE</b>	Above 1000MHz	<b>ENVIRONMENTAL CONDITIONS</b>	23deg. C, 70%RH
<b>INPUT POWER</b>	120Vac 60HZ	<b>TESTED BY</b>	Hanwen Xu

**ANTENNA POLARITY & TEST DISTANCE: VERTICAL AT 3 M**

Rg	Frequency [MHz]	PK+ Level [dBm]	PK+ Limit [dBm]	PK+ Margin [dB]	Correction [dB]	Polarization	Azimuth [deg]	Antenna Height [m]
2	1,670.300	-51.29	-13.00	38.29	19.56	V	359	1.00
3	2,505.450	-47.24	-13.00	34.24	23.47	V	0.9	2.00

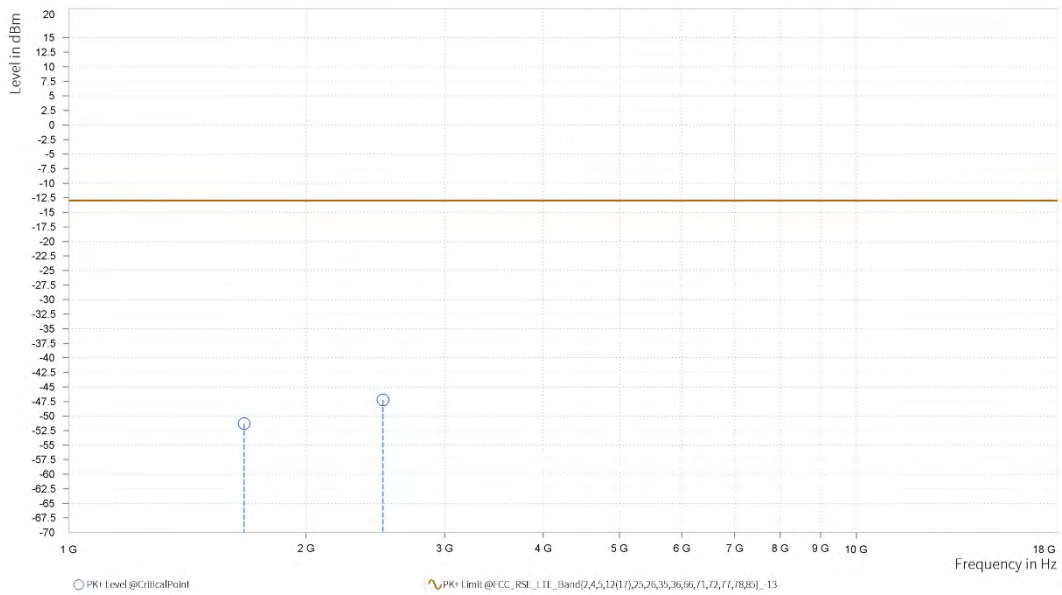



<b>CHANNEL BANDWIDTH</b>	5MHz/QPSK	<b>MODE</b>	TX channel 26815
<b>FREQUENCY RANGE</b>	Above 1000MHz	<b>ENVIRONMENTAL CONDITIONS</b>	23deg. C, 70%RH
<b>INPUT POWER</b>	120Vac 60HZ	<b>TESTED BY</b>	Hanwen Xu

**ANTENNA POLARITY & TEST DISTANCE: HORIZONTAL AT 3 M**

Rg	Frequency [MHz]	PK+ Level [dBm]	PK+ Limit [dBm]	PK+ Margin [dB]	Correction [dB]	Polarization	Azimuth [deg]	Antenna Height [m]
2	1,648.500	-52.26	-13.00	39.26	18.64	H	71.3	1.00
3	2,472.750	-47.08	-13.00	34.08	24.40	H	1	1.00

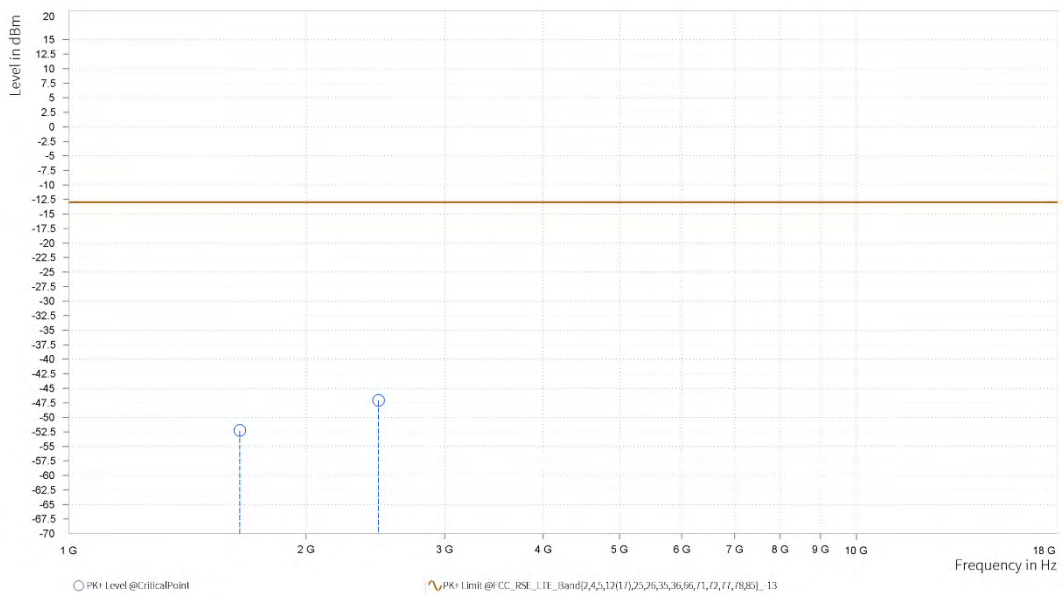



<b>CHANNEL BANDWIDTH</b>	5MHz/QPSK	<b>MODE</b>	TX channel 26815
<b>FREQUENCY RANGE</b>	Above 1000MHz	<b>ENVIRONMENTAL CONDITIONS</b>	23deg. C, 70%RH
<b>INPUT POWER</b>	120Vac 60HZ	<b>TESTED BY</b>	Hanwen Xu

**ANTENNA POLARITY & TEST DISTANCE: VERTICAL AT 3 M**

Rg	Frequency [MHz]	PK+ Level [dBm]	PK+ Limit [dBm]	PK+ Margin [dB]	Correction [dB]	Polarization	Azimuth [deg]	Antenna Height [m]
2	1,648.500	-51.93	-13.00	38.93	18.11	V	1	1.00
3	2,472.750	-47.34	-13.00	34.34	24.10	V	359	2.00

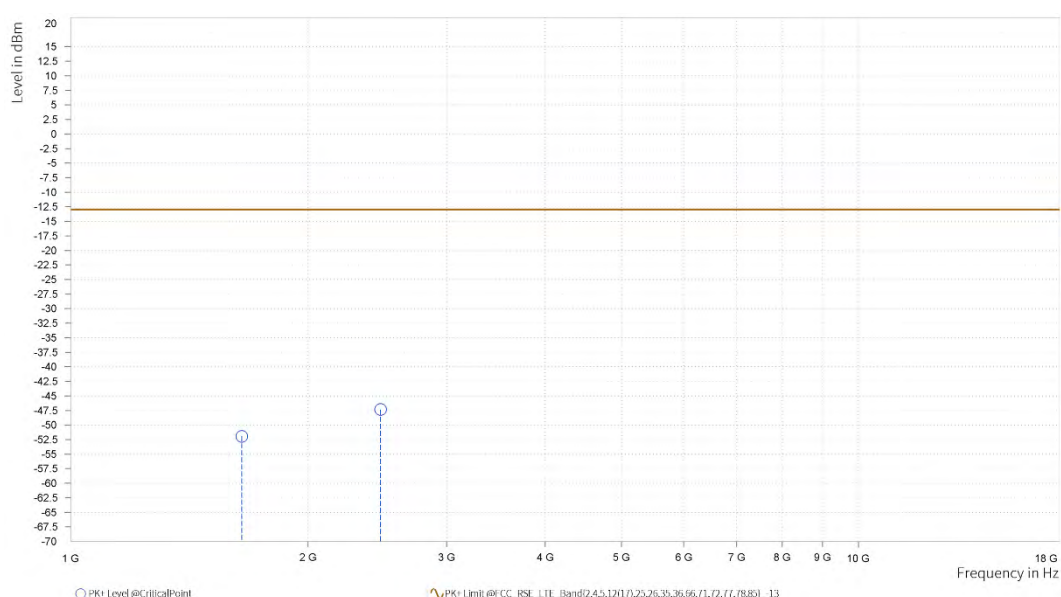



<b>CHANNEL BANDWIDTH</b>	5MHz/QPSK	<b>MODE</b>	TX channel 26915
<b>FREQUENCY RANGE</b>	Above 1000MHz	<b>ENVIRONMENTAL CONDITIONS</b>	23deg. C, 70%RH
<b>INPUT POWER</b>	120Vac 60HZ	<b>TESTED BY</b>	Hanwen Xu

**ANTENNA POLARITY & TEST DISTANCE: HORIZONTAL AT 3 M**

Rg	Frequency [MHz]	PK+ Level [dBm]	PK+ Limit [dBm]	PK+ Margin [dB]	Correction [dB]	Polarization	Azimuth [deg]	Antenna Height [m]
2	1,668.500	-50.29	-13.00	37.29	19.71	H	263.7	2.00
3	2,502.750	-46.30	-13.00	33.30	23.84	H	147.7	1.00

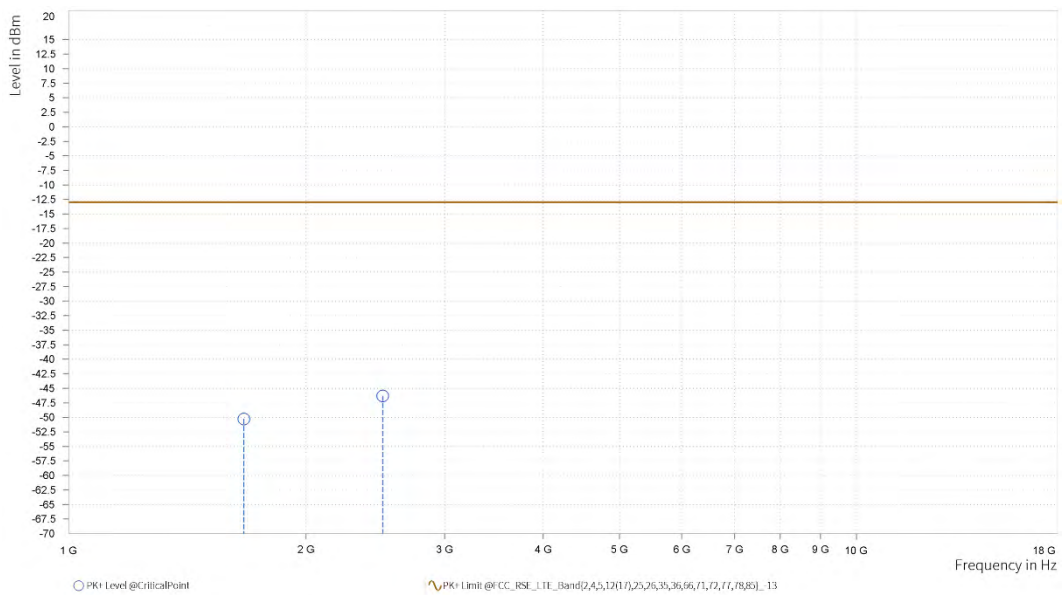



<b>CHANNEL BANDWIDTH</b>	5MHz/QPSK	<b>MODE</b>	TX channel 26915
<b>FREQUENCY RANGE</b>	Above 1000MHz	<b>ENVIRONMENTAL CONDITIONS</b>	23deg. C, 70%RH
<b>INPUT POWER</b>	120Vac 60HZ	<b>TESTED BY</b>	Hanwen Xu

**ANTENNA POLARITY & TEST DISTANCE: VERTICAL AT 3 M**

Rg	Frequency [MHz]	PK+ Level [dBm]	PK+ Limit [dBm]	PK+ Margin [dB]	Correction [dB]	Polarization	Azimuth [deg]	Antenna Height [m]
2	1,668.500	-50.71	-13.00	37.71	19.44	V	73.6	1.00
3	2,502.750	-48.13	-13.00	35.13	23.48	V	146.6	1.00

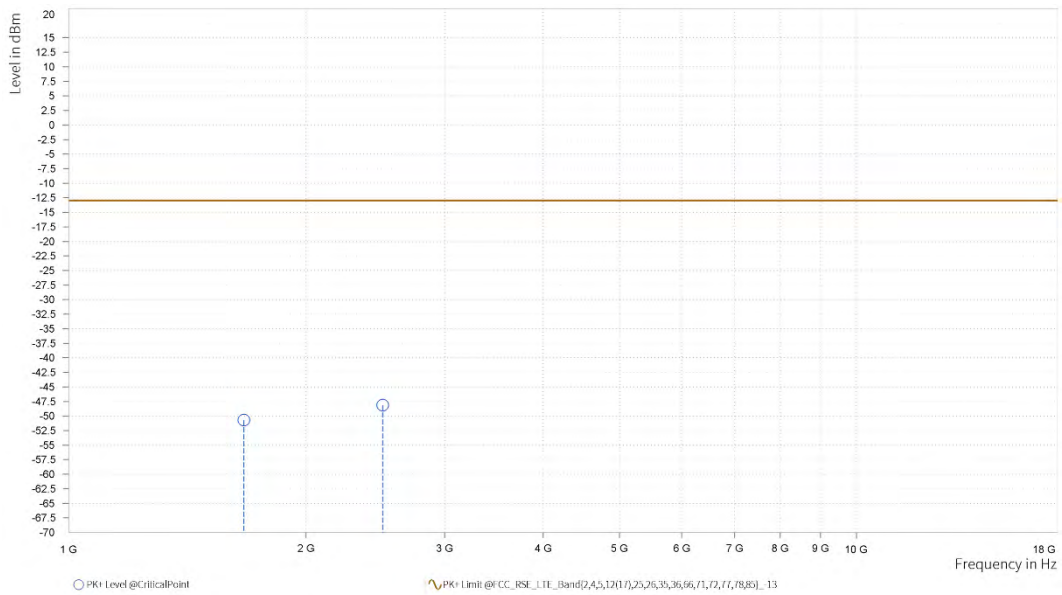



<b>CHANNEL BANDWIDTH</b>	5MHz/QPSK	<b>MODE</b>	TX channel 27015
<b>FREQUENCY RANGE</b>	Above 1000MHz	<b>ENVIRONMENTAL CONDITIONS</b>	23deg. C, 70%RH
<b>INPUT POWER</b>	120Vac 60HZ	<b>TESTED BY</b>	Hanwen Xu

**ANTENNA POLARITY & TEST DISTANCE: HORIZONTAL AT 3 M**

Rg	Frequency [MHz]	PK+ Level [dBm]	PK+ Limit [dBm]	PK+ Margin [dB]	Correction [dB]	Polarization	Azimuth [deg]	Antenna Height [m]
2	1,688.500	-46.26	-13.00	33.26	20.30	H	71.2	1.00
3	2,532.750	-47.25	-13.00	34.25	23.58	H	359	2.00

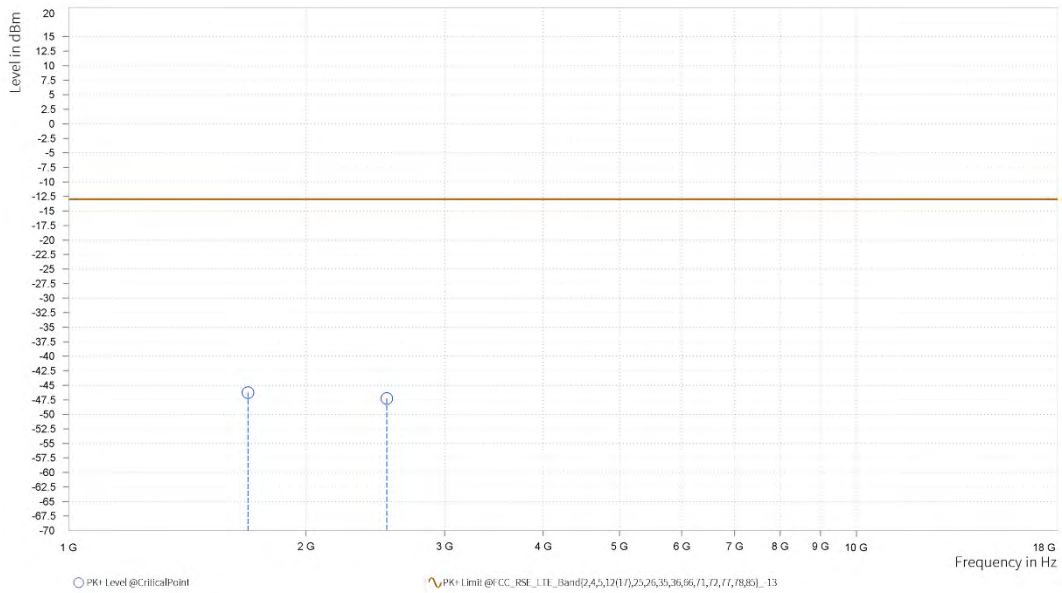



<b>CHANNEL BANDWIDTH</b>	5MHz/QPSK	<b>MODE</b>	TX channel 27015
<b>FREQUENCY RANGE</b>	Above 1000MHz	<b>ENVIRONMENTAL CONDITIONS</b>	23deg. C, 70%RH
<b>INPUT POWER</b>	120Vac 60HZ	<b>TESTED BY</b>	Hanwen Xu

**ANTENNA POLARITY & TEST DISTANCE: VERTICAL AT 3 M**

Rg	Frequency [MHz]	PK+ Level [dBm]	PK+ Limit [dBm]	PK+ Margin [dB]	Correction [dB]	Polarization	Azimuth [deg]	Antenna Height [m]
2	1,688.500	-48.35	-13.00	35.35	20.36	V	359.1	1.00
3	2,532.750	-49.29	-13.00	36.29	23.33	V	144.1	1.00

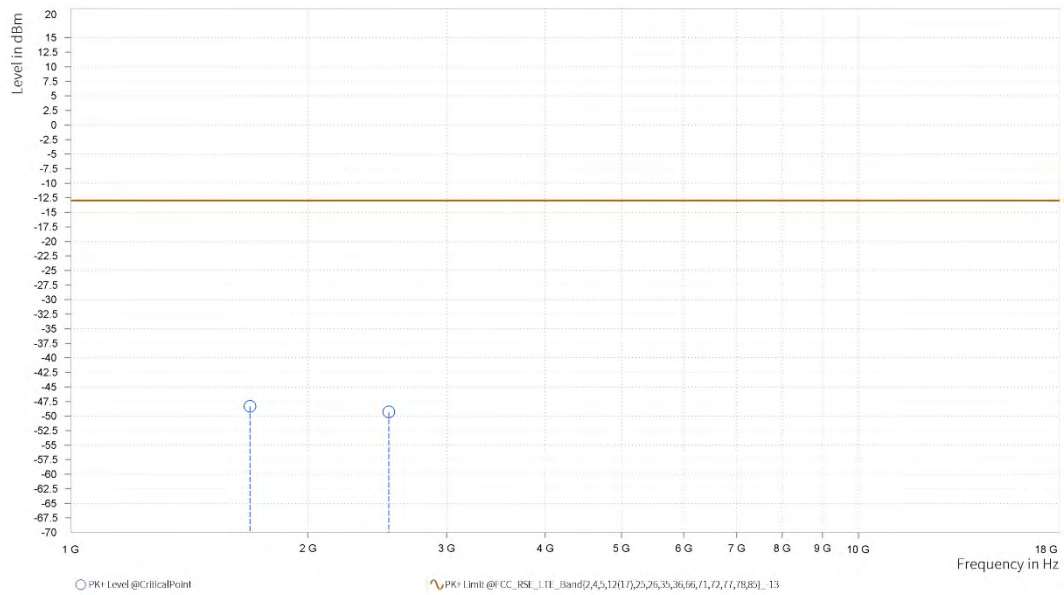





<b>CHANNEL BANDWIDTH</b>	10MHz/QPSK	<b>MODE</b>	TX channel 26915
<b>FREQUENCY RANGE</b>	Above 1000MHz	<b>ENVIRONMENTAL CONDITIONS</b>	23deg. C, 70%RH
<b>INPUT POWER</b>	120Vac 60HZ	<b>TESTED BY</b>	Hanwen Xu

**ANTENNA POLARITY & TEST DISTANCE: HORIZONTAL AT 3 M**

Rg	Frequency [MHz]	PK+ Level [dBm]	PK+ Limit [dBm]	PK+ Margin [dB]	Correction [dB]	Polarization	Azimuth [deg]	Antenna Height [m]
2	1,664.000	-48.00	-13.00	35.00	19.52	H	68.8	1.00
3	2,496.000	-47.26	-13.00	34.26	23.86	H	1	1.00

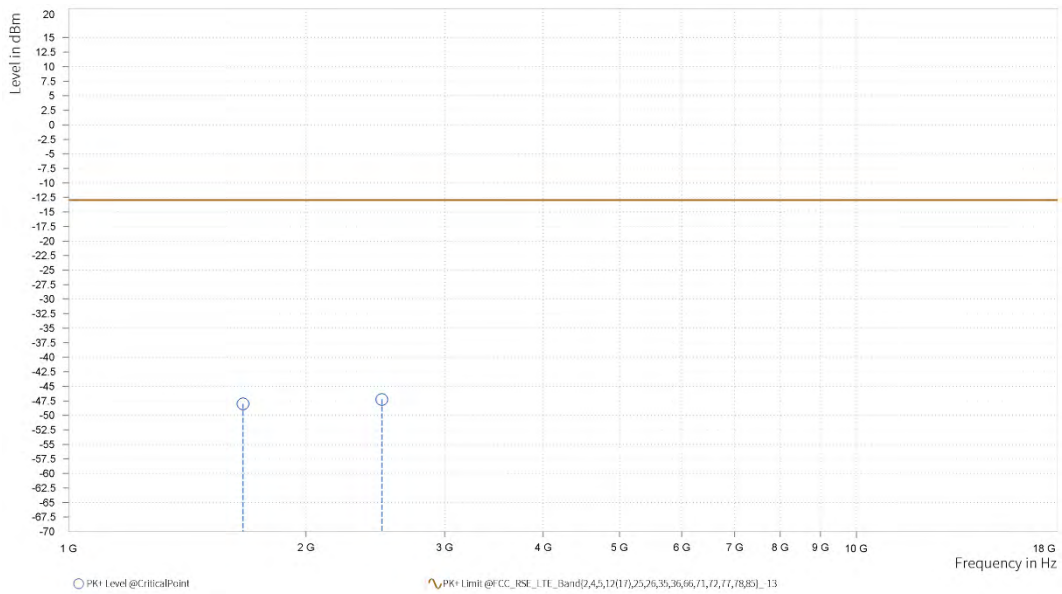



<b>CHANNEL BANDWIDTH</b>	10MHz/QPSK	<b>MODE</b>	TX channel 26915
<b>FREQUENCY RANGE</b>	Above 1000MHz	<b>ENVIRONMENTAL CONDITIONS</b>	23deg. C, 70%RH
<b>INPUT POWER</b>	120Vac 60HZ	<b>TESTED BY</b>	Hanwen Xu

**ANTENNA POLARITY & TEST DISTANCE: VERTICAL AT 3 M**

Rg	Frequency [MHz]	PK+ Level [dBm]	PK+ Limit [dBm]	PK+ Margin [dB]	Correction [dB]	Polarization	Azimuth [deg]	Antenna Height [m]
2	1,664.000	-51.19	-13.00	38.19	19.18	V	292.4	2.00
3	2,496.000	-47.83	-13.00	34.83	23.47	V	359.1	1.00

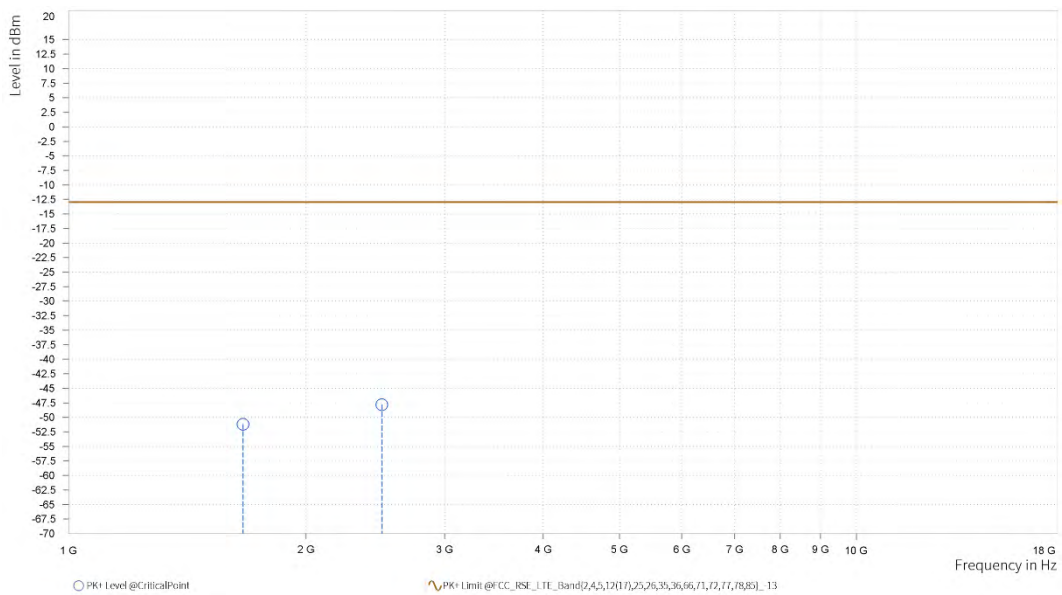



<b>CHANNEL BANDWIDTH</b>	15MHz/QPSK	<b>MODE</b>	TX channel 26915
<b>FREQUENCY RANGE</b>	Above 1000MHz	<b>ENVIRONMENTAL CONDITIONS</b>	23deg. C, 70%RH
<b>INPUT POWER</b>	120Vac 60HZ	<b>TESTED BY</b>	Hanwen Xu

**ANTENNA POLARITY & TEST DISTANCE: HORIZONTAL AT 3 M**

Rg	Frequency [MHz]	PK+ Level [dBm]	PK+ Limit [dBm]	PK+ Margin [dB]	Correction [dB]	Polarization	Azimuth [deg]	Antenna Height [m]
2	1,659.500	-48.94	-13.00	35.94	19.33	H	0.9	2.00
3	2,489.250	-48.47	-13.00	35.47	23.92	H	359	2.00

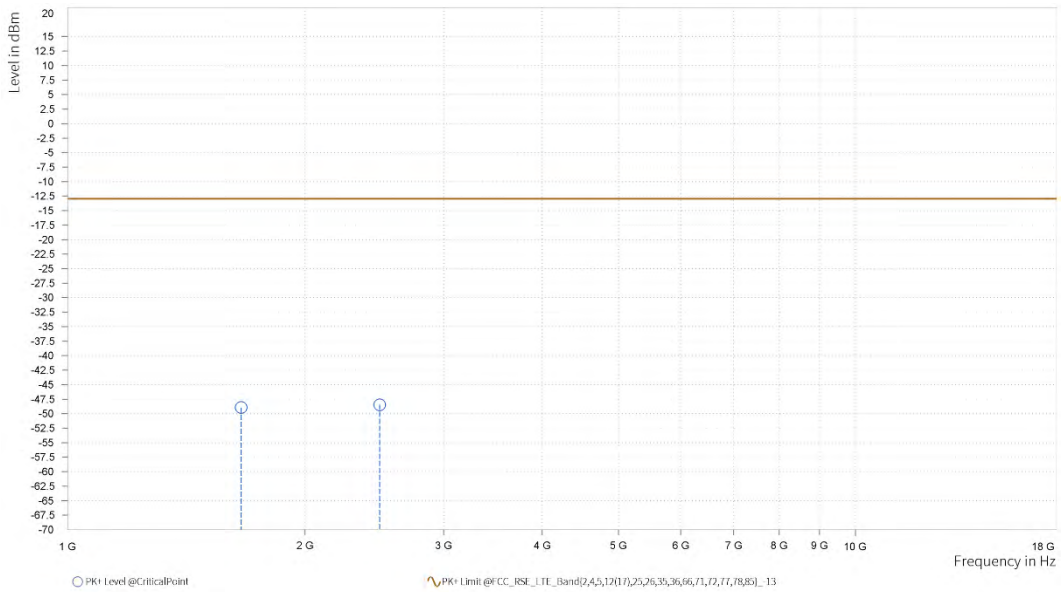



<b>CHANNEL BANDWIDTH</b>	15MHz/QPSK	<b>MODE</b>	TX channel 26915
<b>FREQUENCY RANGE</b>	Above 1000MHz	<b>ENVIRONMENTAL CONDITIONS</b>	23deg. C, 70%RH
<b>INPUT POWER</b>	120Vac 60HZ	<b>TESTED BY</b>	Hanwen Xu

**ANTENNA POLARITY & TEST DISTANCE: VERTICAL AT 3 M**

Rg	Frequency [MHz]	PK+ Level [dBm]	PK+ Limit [dBm]	PK+ Margin [dB]	Correction [dB]	Polarization	Azimuth [deg]	Antenna Height [m]
2	1,659.500	-51.96	-13.00	38.96	18.91	V	1	1.00
3	2,489.250	-48.38	-13.00	35.38	23.55	V	1	2.00

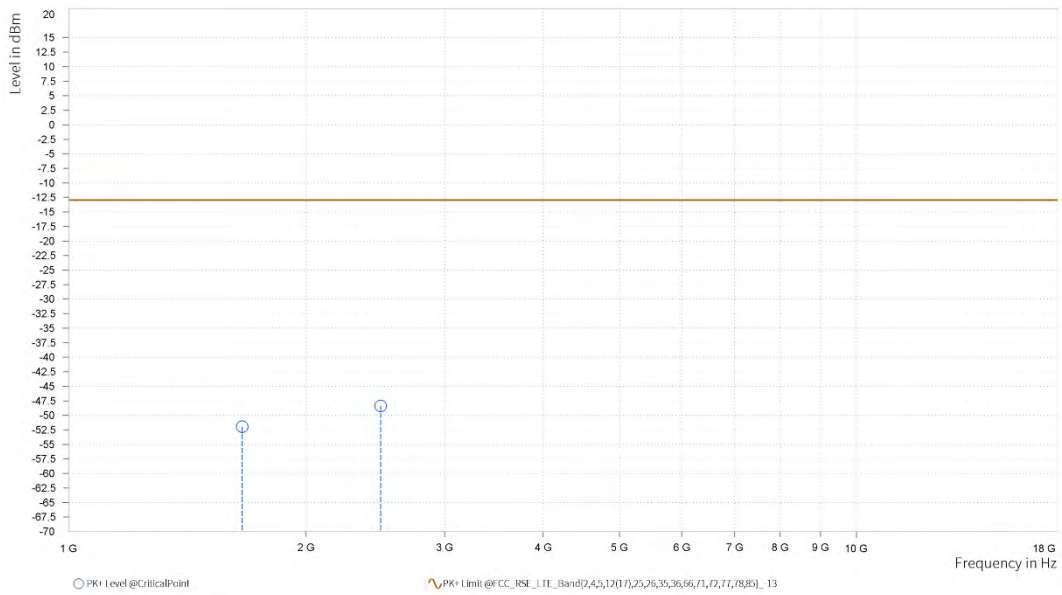



### 3.7 PEAK TO AVERAGE RATIO

#### 3.7.1 LIMITS OF PEAK TO AVERAGE RATIO MEASUREMENT

In measuring transmissions in this band using an average power technique, the peak to-average ratio (PAR) of the transmission may not exceed 13 dB

#### 3.7.2 TEST SETUP

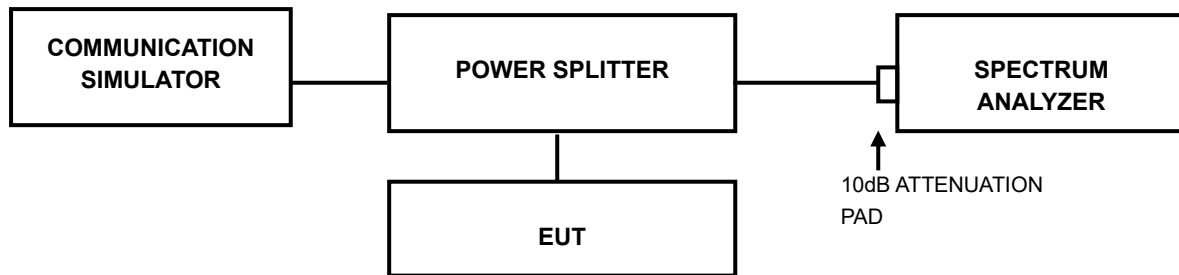

#### 3.7.3 TEST PROCEDURES

1. Set resolution/measurement bandwidth  $\geq$  signal's occupied bandwidth;
2. Set the number of counts to a value that stabilizes the measured CCDF curve;
3. Record the maximum PAPR level associated with a probability of 0.1%.



**BUREAU VERITAS** Test Report No.: PSZ-NQN2412300616RF01

### 3.7.4 TEST RESULTS

Please Refer to Appendix of this test report.



**BUREAU** Test Report No.: PSZ-NQN2412300616RF01  
**VERITAS**

## 4 PHOTOGRAPHS OF THE TEST CONFIGURATION

Please refer to the attached file (Test Setup Photo).



**BUREAU VERITAS** Test Report No.: PSZ-NQN2412300616RF01

## 5 INFORMATION ON THE TESTING LABORATORIES

We, Huarui 7layers High Technology (Suzhou) Co., Ltd. ,were founded in 2020 to provide our best service in EMC, Radio, Telecom and Safety consultation. Our laboratories are accredited and approved according to ISO/IEC 17025.

Huarui 7Layers High Technology (Suzhou) Co., Ltd.

Lab Address:

Tower N, Innovation Center, 88 Zuyi Road, High-tech District, Suzhou City, Anhui Province

Accredited Test Lab Cert 6613.01

If you have any comments, please feel free to contact us at the following:

**Suzhou EMC/RF Lab:**

Tel: +86 (0557) 368 1008





**BUREAU** Test Report No.: PSZ-NQN2412300616RF01  
**VERITAS**

## **6 MODIFICATIONS RECORDERS FOR ENGINEERING CHANGES TO THE EUT BY THE LAB**

No any modifications are made to the EUT by the lab during the test.



## 7 APPENDIX

### LTE BAND26 (INCLUDING LTE BAND 5)

#### PEAK-TO-AVERAGE RATIO(CCDF)

##### Test Result

Band	Bandwidth	Modulation	Channel	RB Configuration	Result(dB)	Limit(dB)	Verdict
Band26	15MHz	QPSK	26865	1RB#0	4.83	13	PASS
Band26	15MHz	QPSK	26865	75RB#0	5.61	13	PASS
Band26	15MHz	QPSK	26915	1RB#0	4.44	13	PASS
Band26	15MHz	QPSK	26915	75RB#0	5.77	13	PASS
Band26	15MHz	QPSK	26965	1RB#0	4.90	13	PASS
Band26	15MHz	QPSK	26965	75RB#0	5.64	13	PASS
Band26	15MHz	16QAM	26865	1RB#0	5.42	13	PASS
Band26	15MHz	16QAM	26865	27RB#0	5.95	13	PASS
Band26	15MHz	16QAM	26915	1RB#0	5.36	13	PASS
Band26	15MHz	16QAM	26915	27RB#0	5.95	13	PASS
Band26	15MHz	16QAM	26965	1RB#0	5.99	13	PASS
Band26	15MHz	16QAM	26965	27RB#0	6.22	13	PASS



### Test Graphs

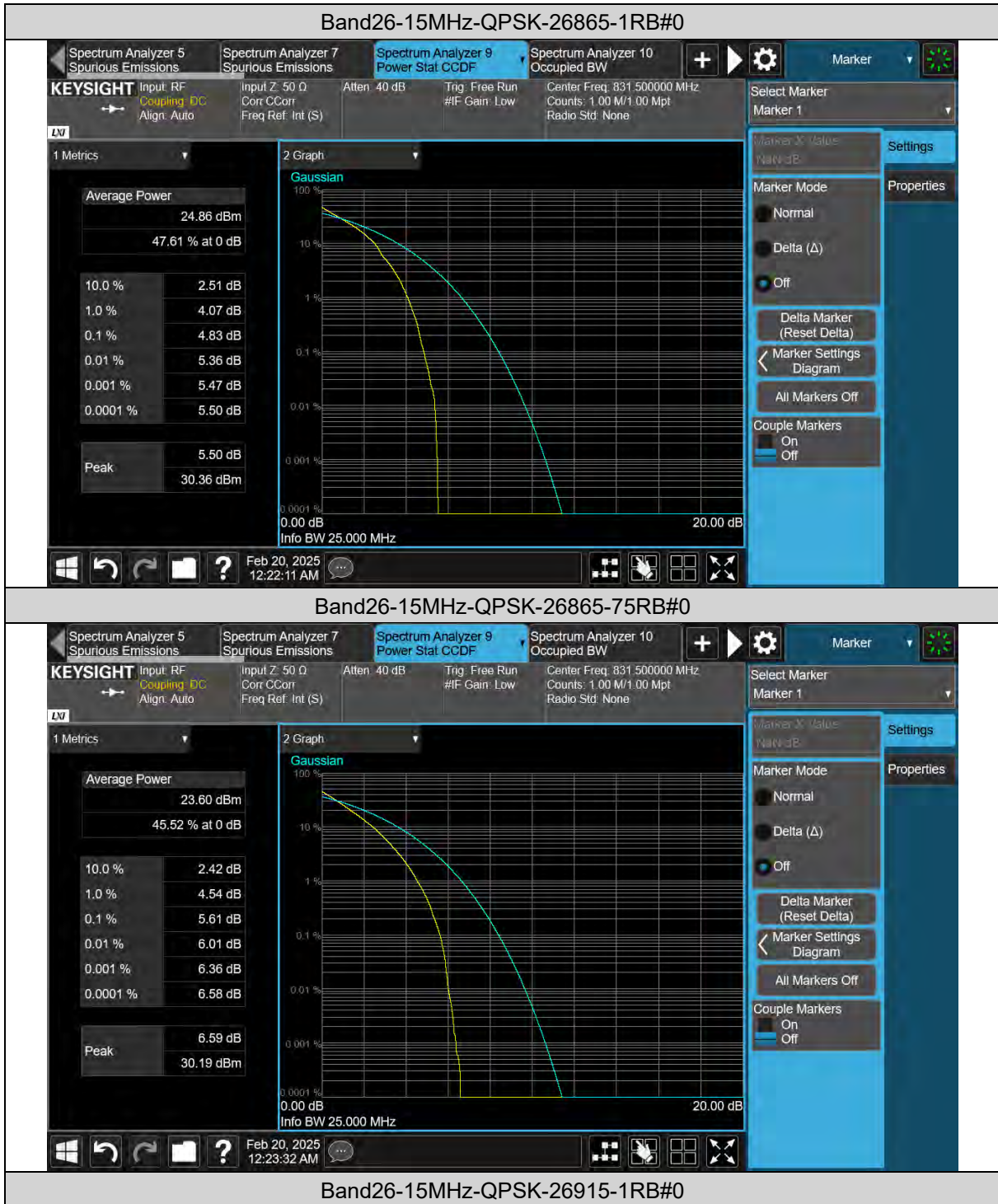

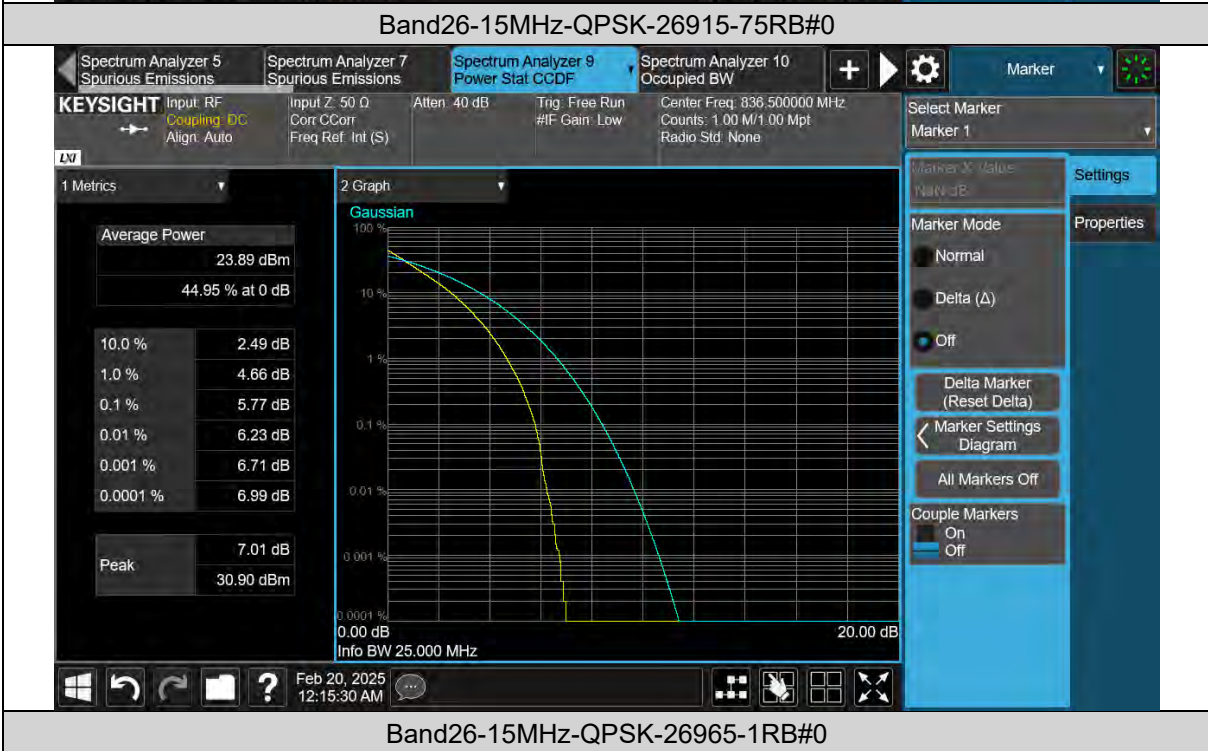

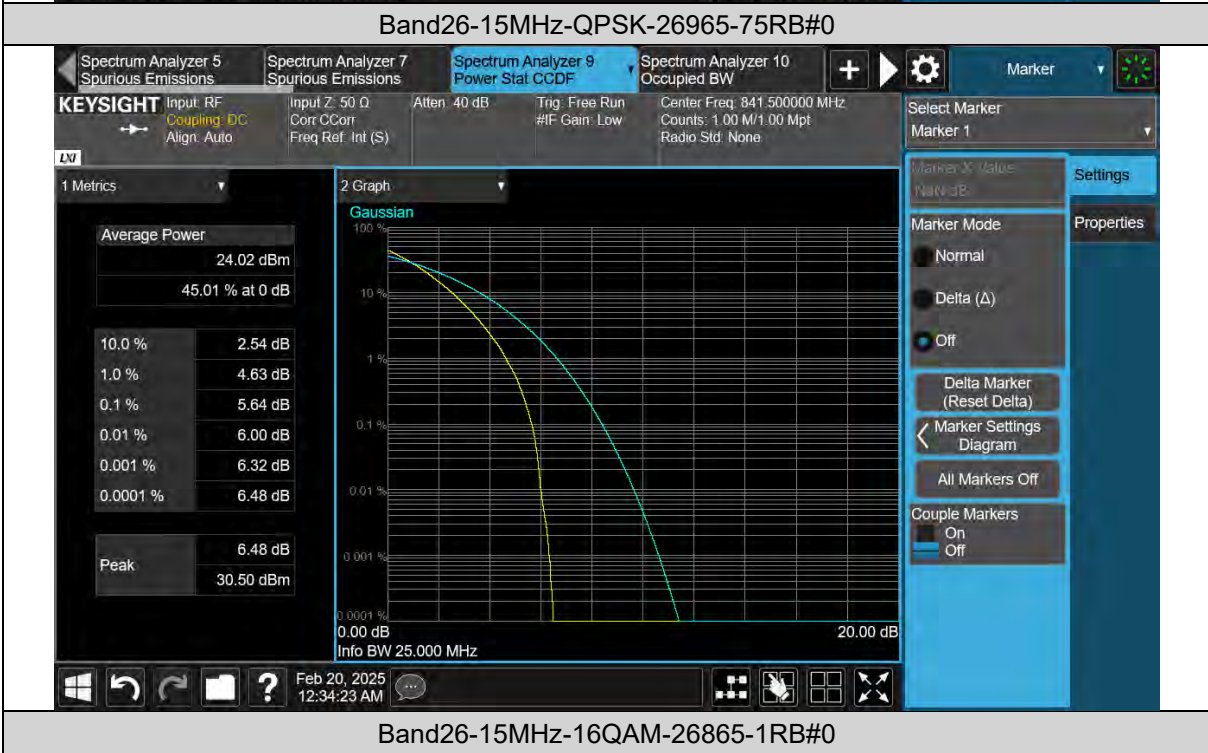

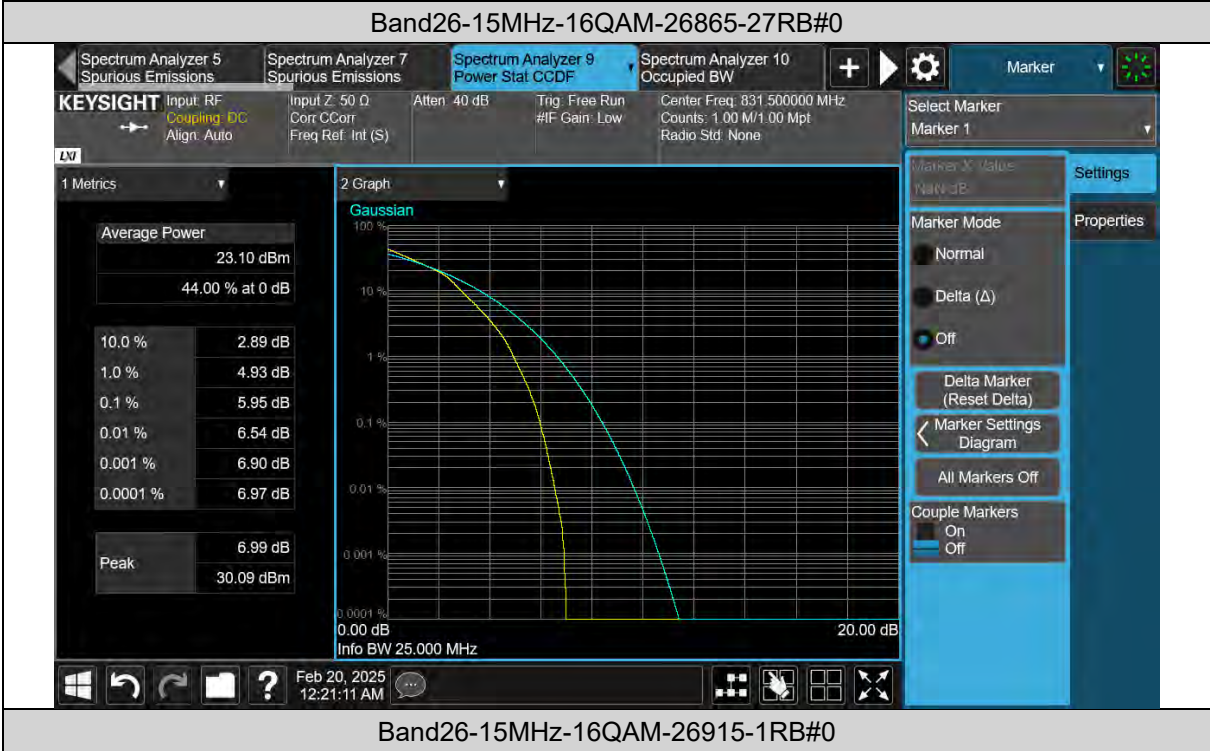

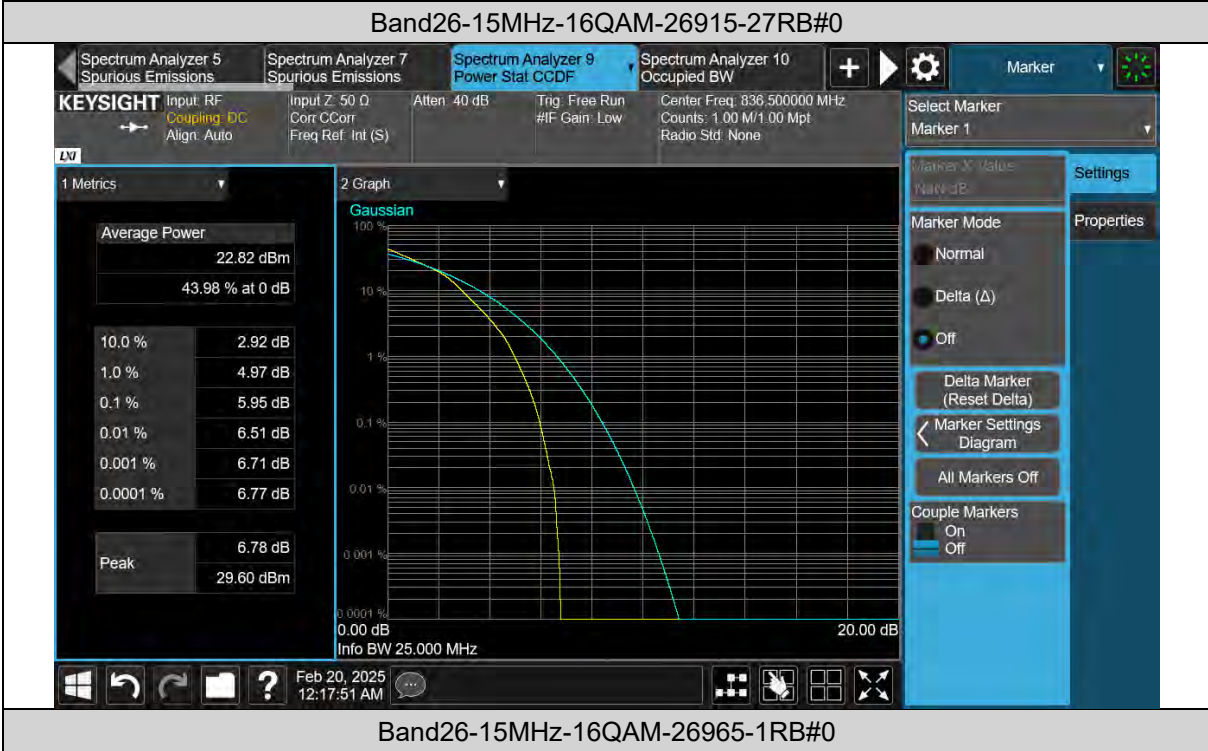
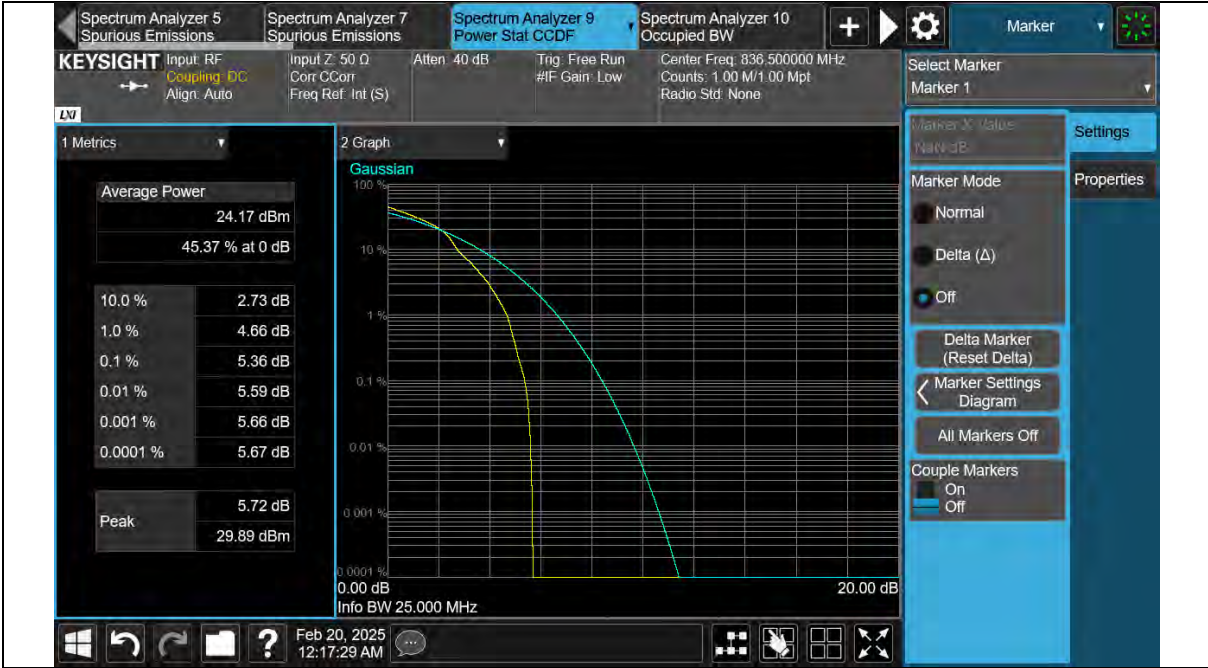



Band26-15MHz-16QAM-26965-27RB#0

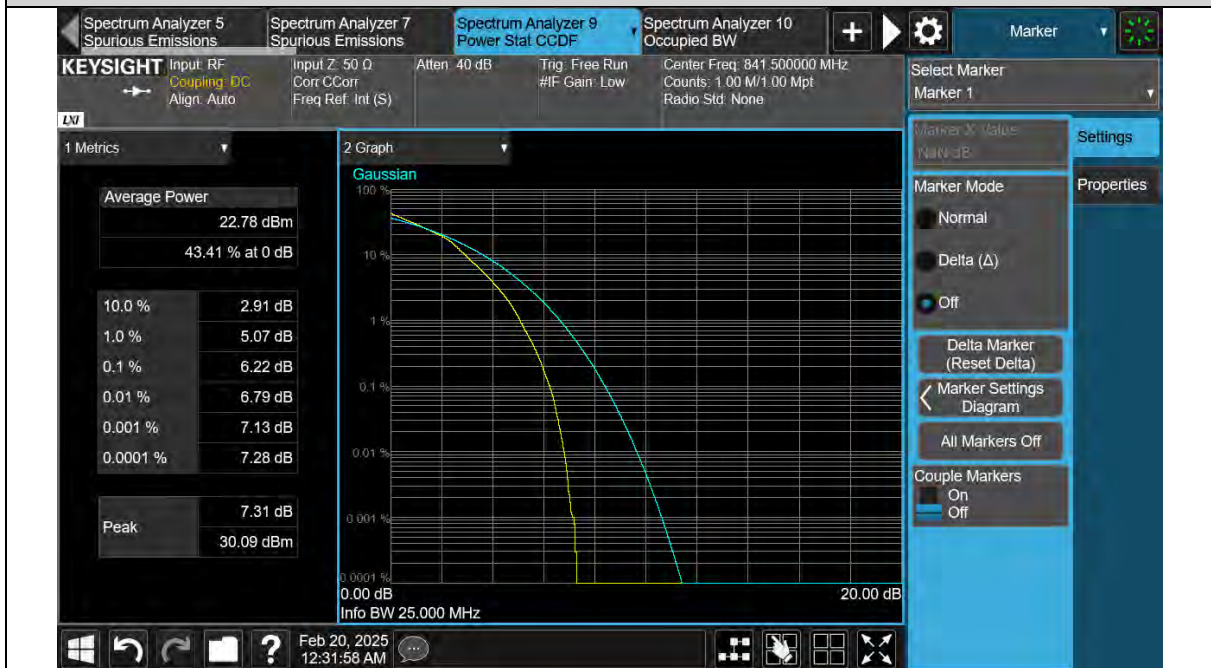





### 26DB BANDWIDTH AND OCCUPIED BANDWIDTH

#### Test Result

Band	Bandwidth	Modulation	Channel	RB Configuration	Occupied Bandwidth (MHz)	26dB Bandwidth (MHz)	Verdict
Band26	1.4MHz	QPSK	26797	6RB#0	1.083	1.230	PASS
Band26	1.4MHz	QPSK	26915	6RB#0	1.084	1.245	PASS
Band26	1.4MHz	QPSK	27033	6RB#0	1.082	1.249	PASS
Band26	1.4MHz	16QAM	26797	6RB#0	1.080	1.234	PASS
Band26	1.4MHz	16QAM	26915	6RB#0	1.084	1.251	PASS
Band26	1.4MHz	16QAM	27033	6RB#0	1.084	1.245	PASS
Band26	3MHz	QPSK	26805	15RB#0	2.684	2.877	PASS
Band26	3MHz	QPSK	26915	15RB#0	2.681	2.877	PASS
Band26	3MHz	QPSK	27025	15RB#0	2.687	2.877	PASS
Band26	3MHz	16QAM	26805	15RB#0	2.683	2.885	PASS
Band26	3MHz	16QAM	26915	15RB#0	2.682	2.876	PASS
Band26	3MHz	16QAM	27025	15RB#0	2.685	2.876	PASS
Band26	5MHz	QPSK	26815	25RB#0	4.480	4.786	PASS
Band26	5MHz	QPSK	26915	25RB#0	4.481	4.775	PASS
Band26	5MHz	QPSK	27015	25RB#0	4.471	4.767	PASS
Band26	5MHz	16QAM	26815	25RB#0	4.472	4.783	PASS
Band26	5MHz	16QAM	26915	25RB#0	4.479	4.787	PASS
Band26	5MHz	16QAM	27015	25RB#0	4.470	4.784	PASS
Band26	10MHz	QPSK	26840	50RB#0	8.895	9.325	PASS
Band26	10MHz	QPSK	26915	50RB#0	8.915	9.378	PASS
Band26	10MHz	QPSK	26990	50RB#0	8.900	9.308	PASS
Band26	10MHz	16QAM	26840	27RB#0	4.811	5.179	PASS
Band26	10MHz	16QAM	26915	27RB#0	4.822	5.203	PASS
Band26	10MHz	16QAM	26990	27RB#0	4.814	5.208	PASS
Band26	15MHz	QPSK	26865	75RB#0	13.369	13.920	PASS
Band26	15MHz	QPSK	26915	75RB#0	13.397	13.980	PASS
Band26	15MHz	QPSK	26965	75RB#0	13.369	13.940	PASS
Band26	15MHz	16QAM	26865	27RB#0	4.818	5.238	PASS
Band26	15MHz	16QAM	26915	27RB#0	4.819	5.216	PASS
Band26	15MHz	16QAM	26965	27RB#0	4.824	5.259	PASS



### Test Graphs





**BUREAU VERITAS** Test Report No.: PSZ-NQN2412300616RF01

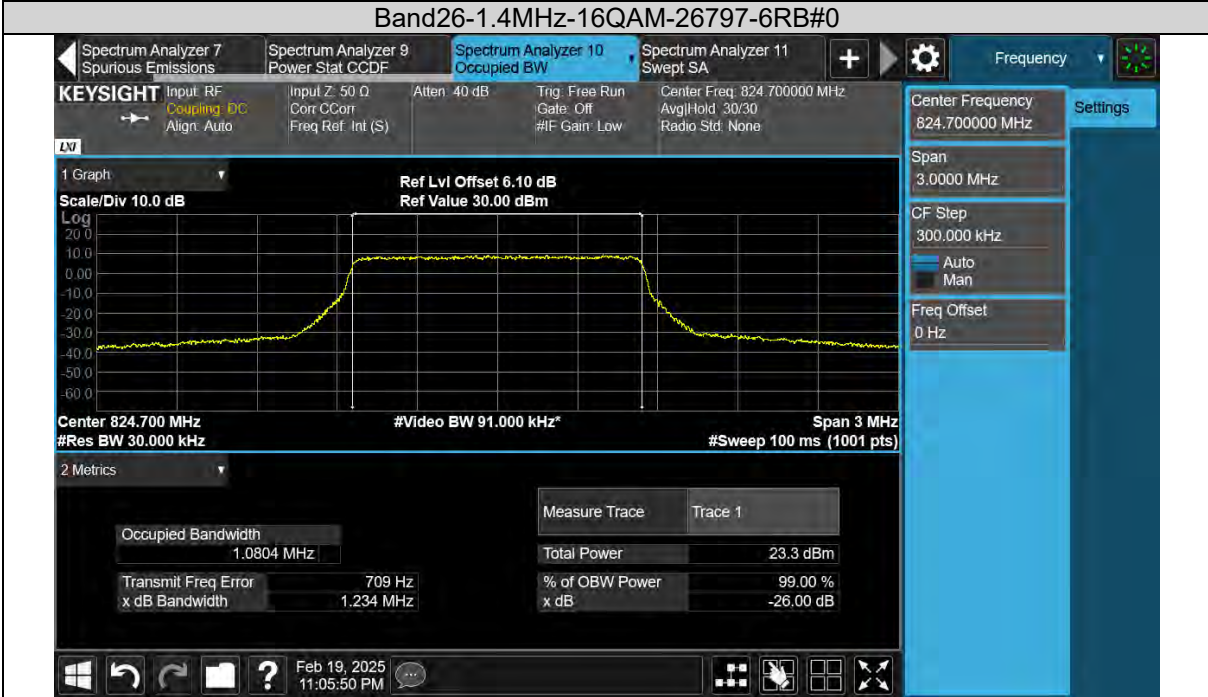
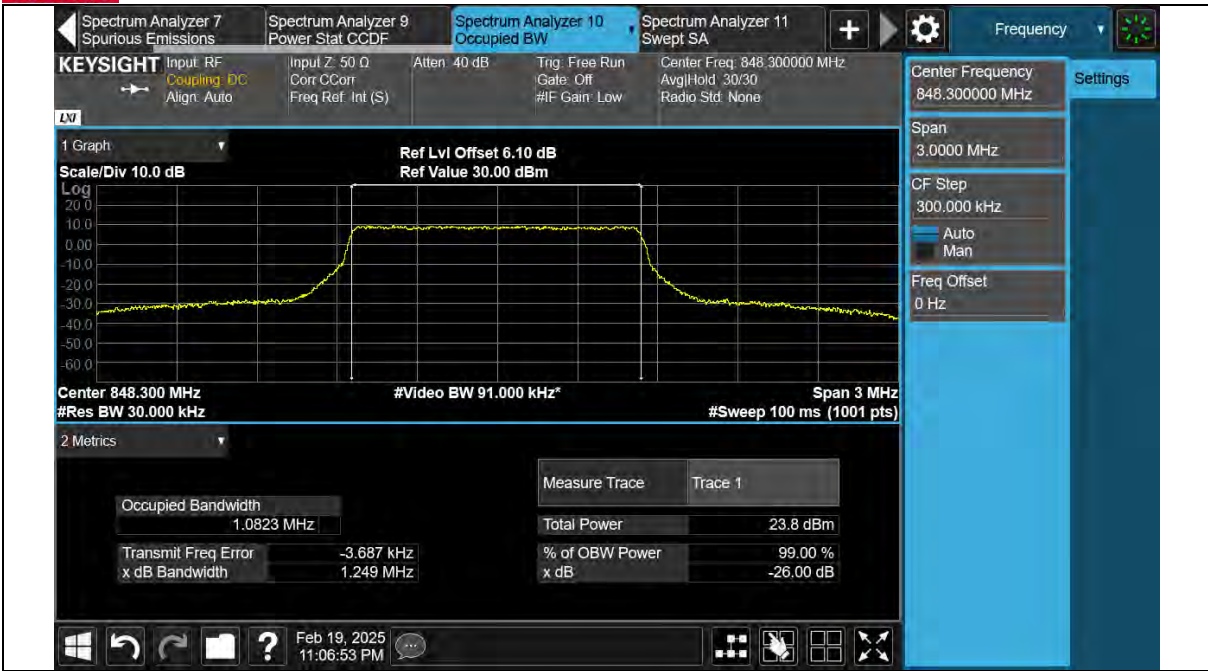



**BUREAU VERITAS** Test Report No.: PSZ-NQN2412300616RF01

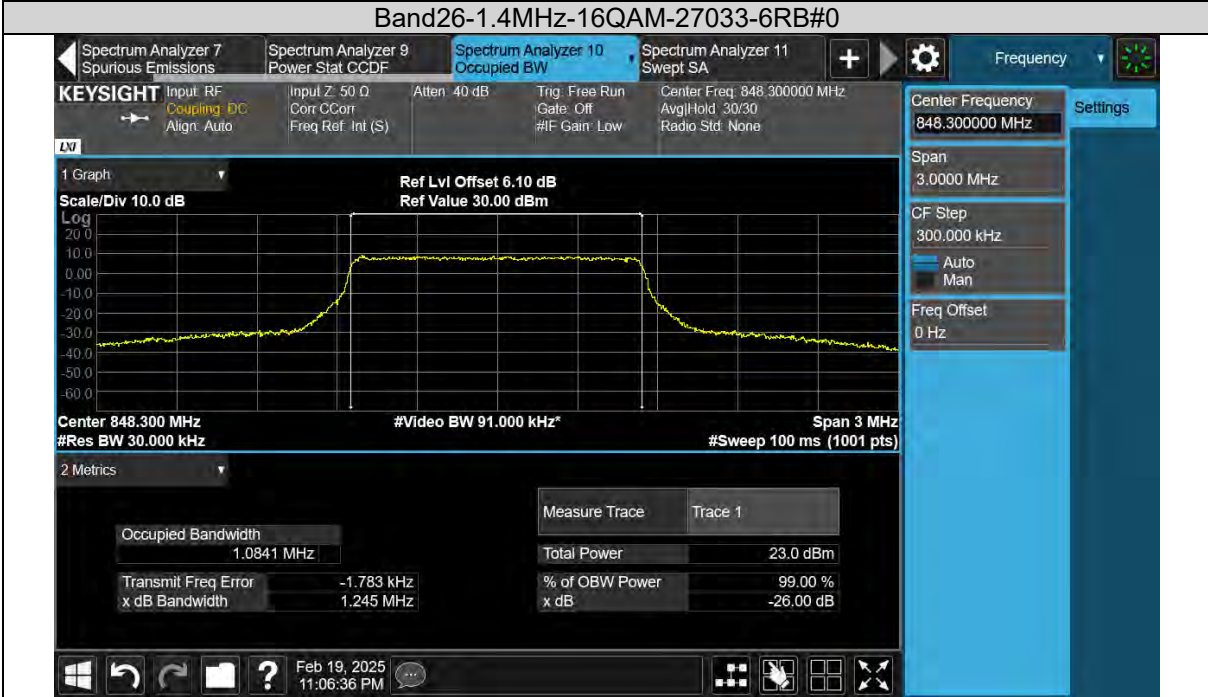
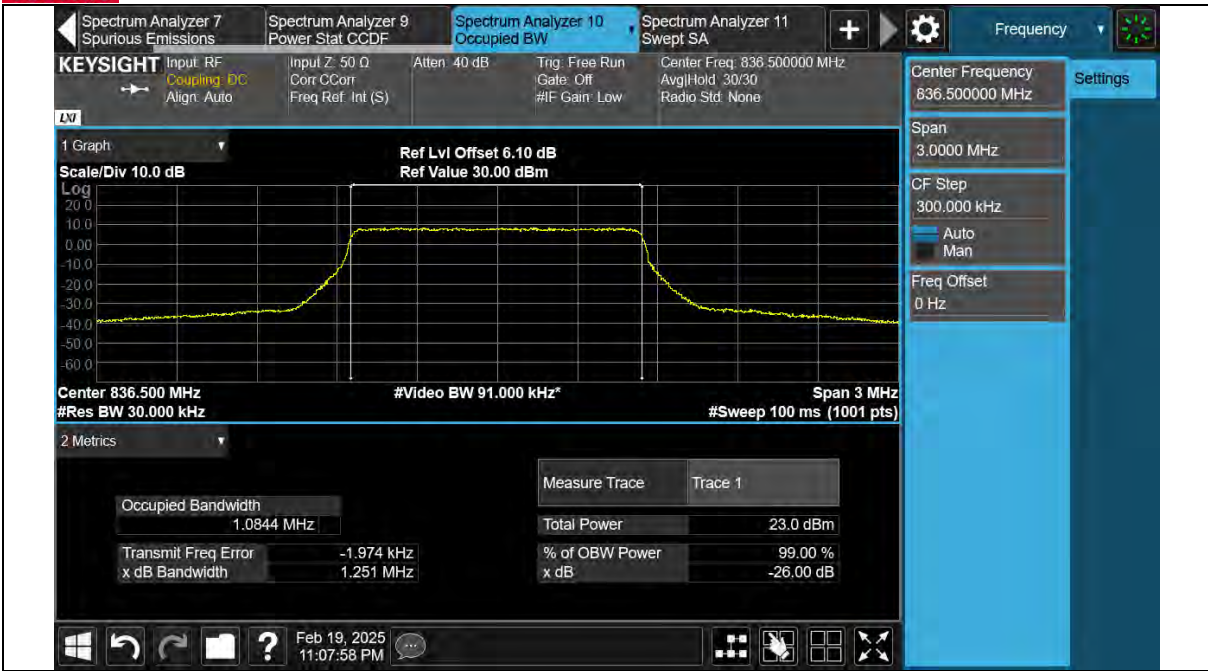

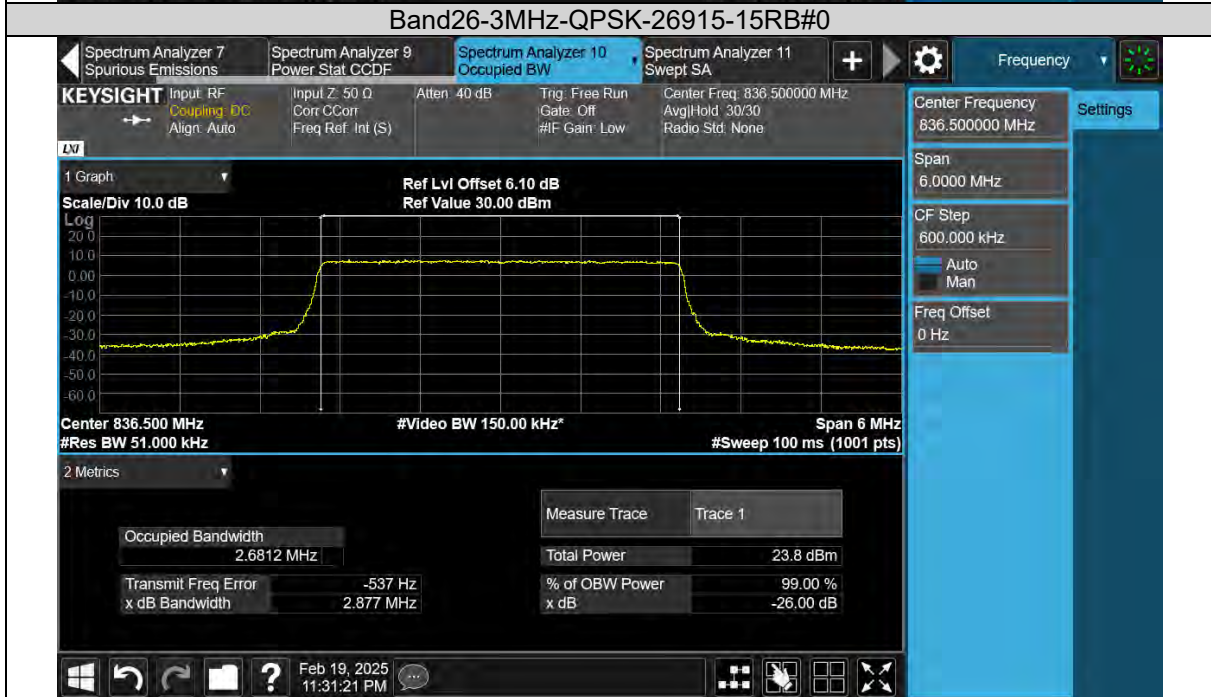



**BUREAU VERITAS** Test Report No.: PSZ-NQN2412300616RF01

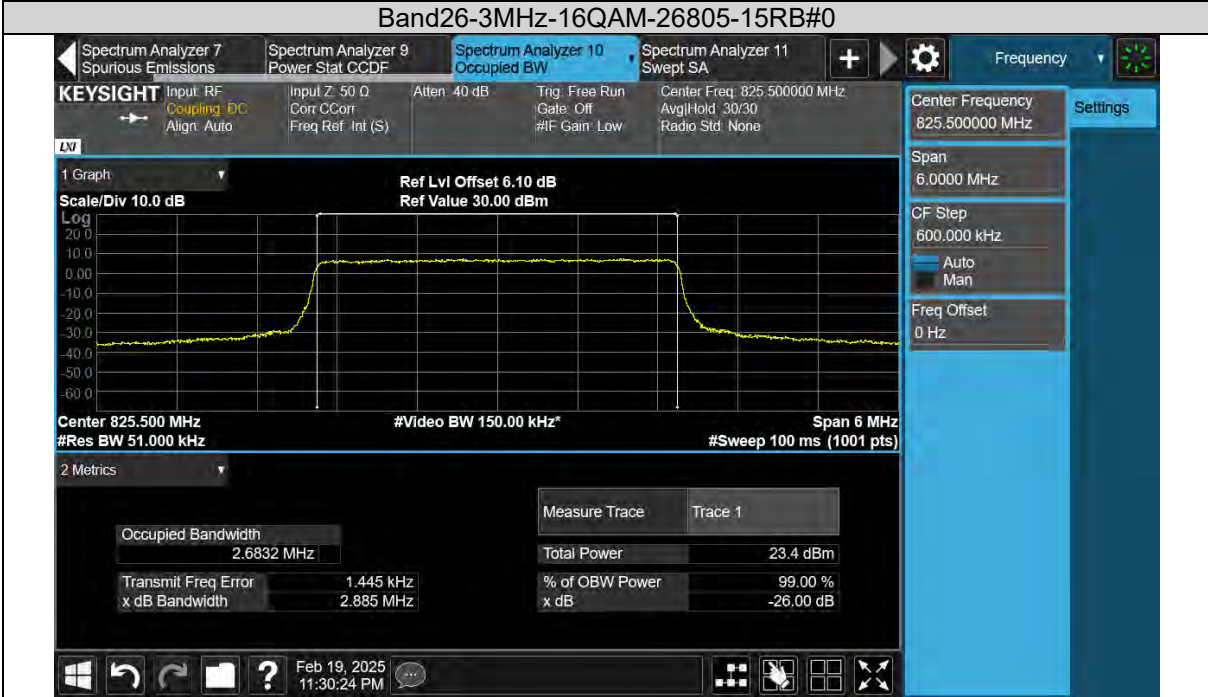

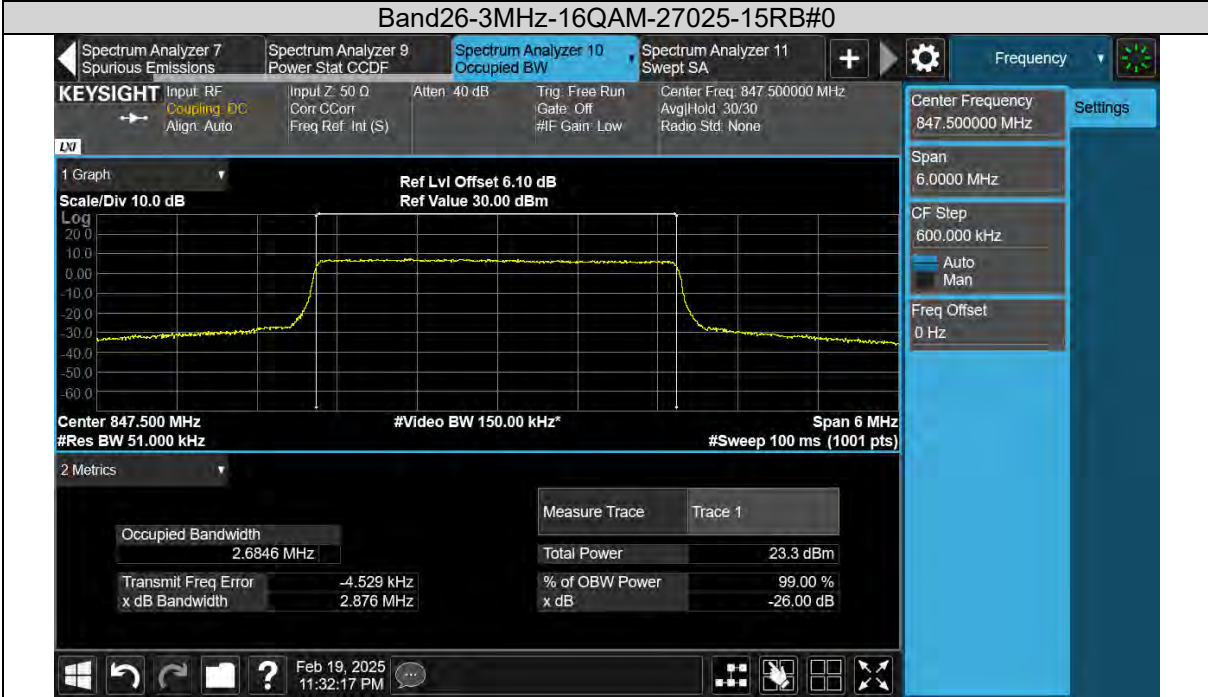
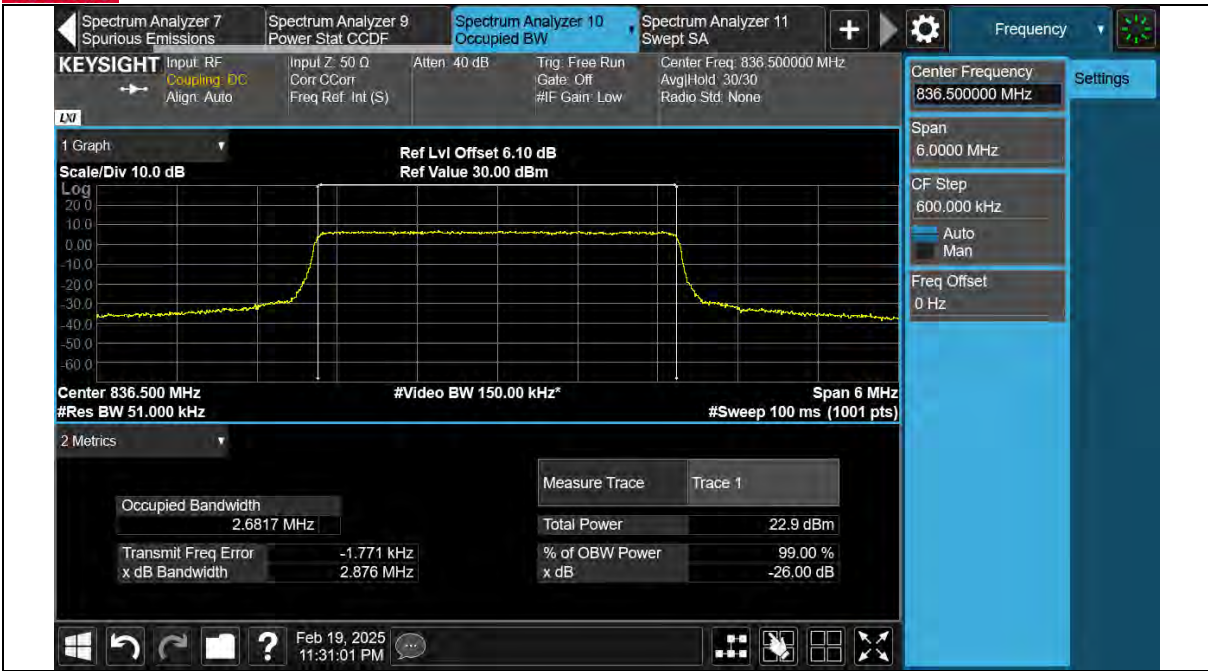

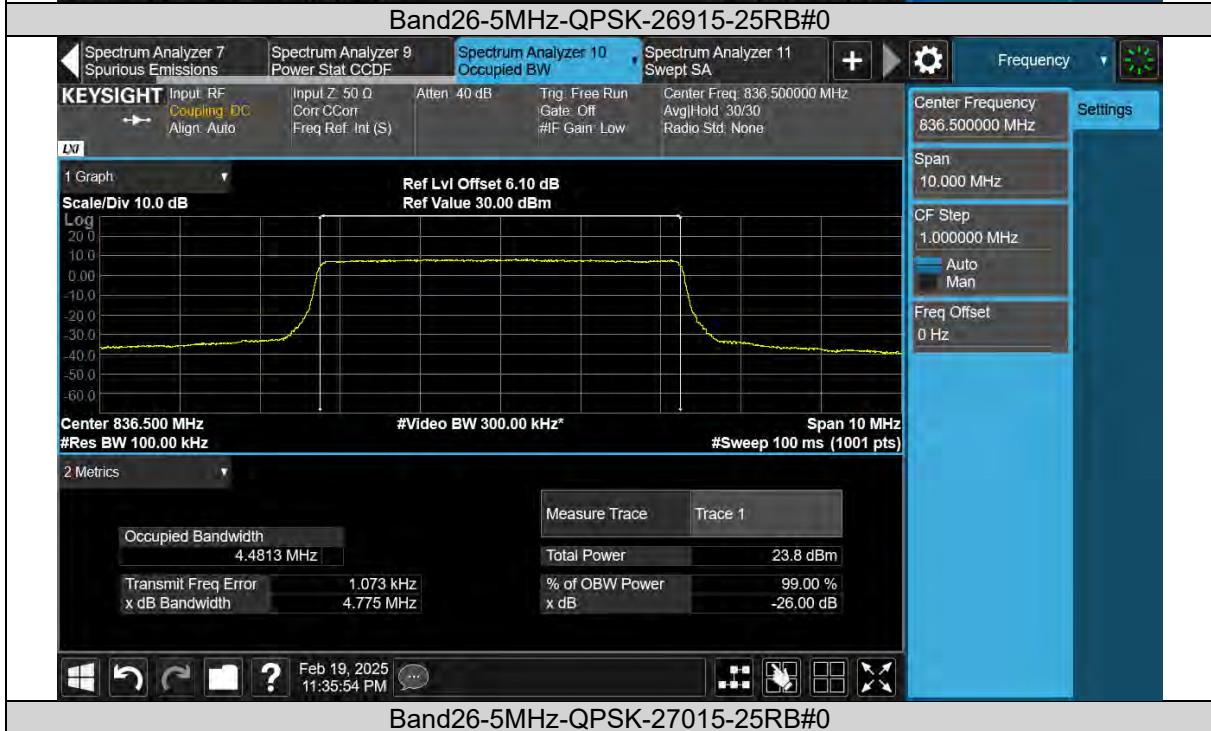



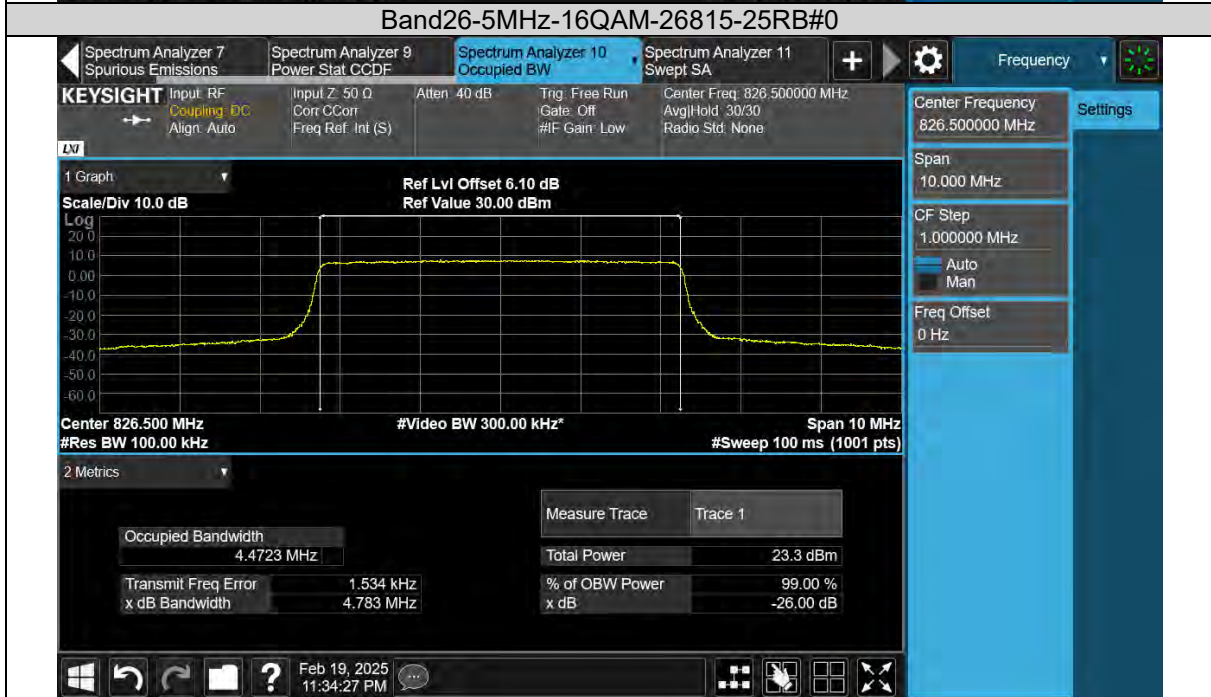

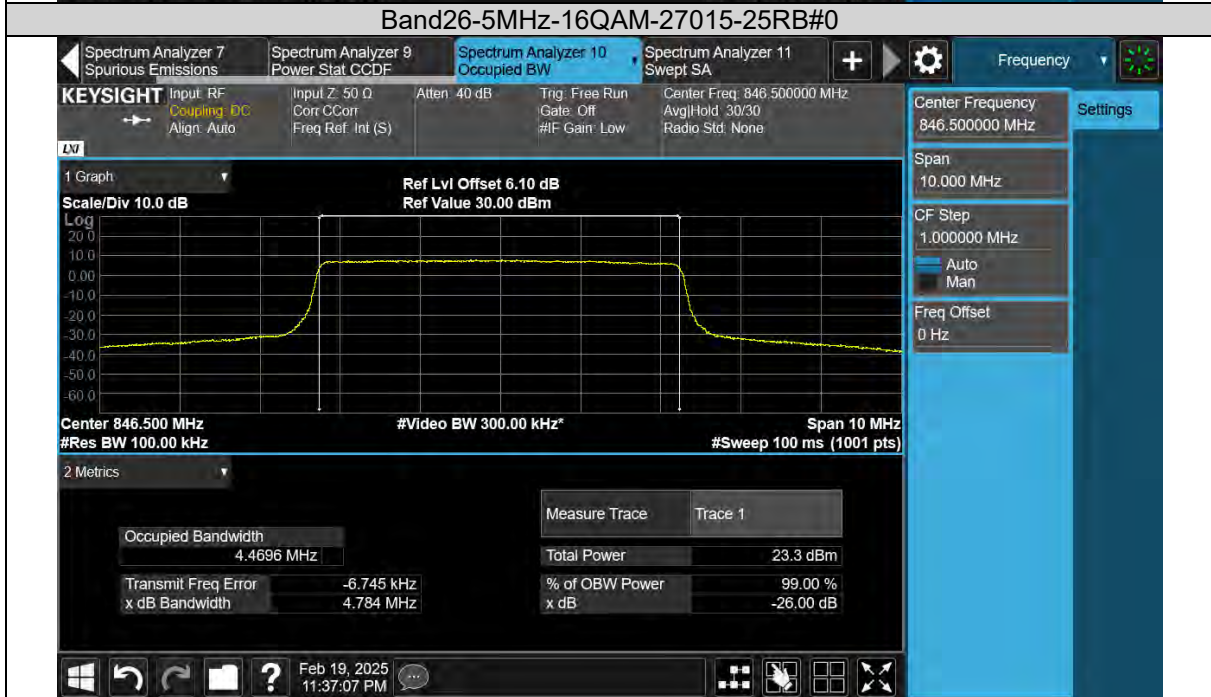

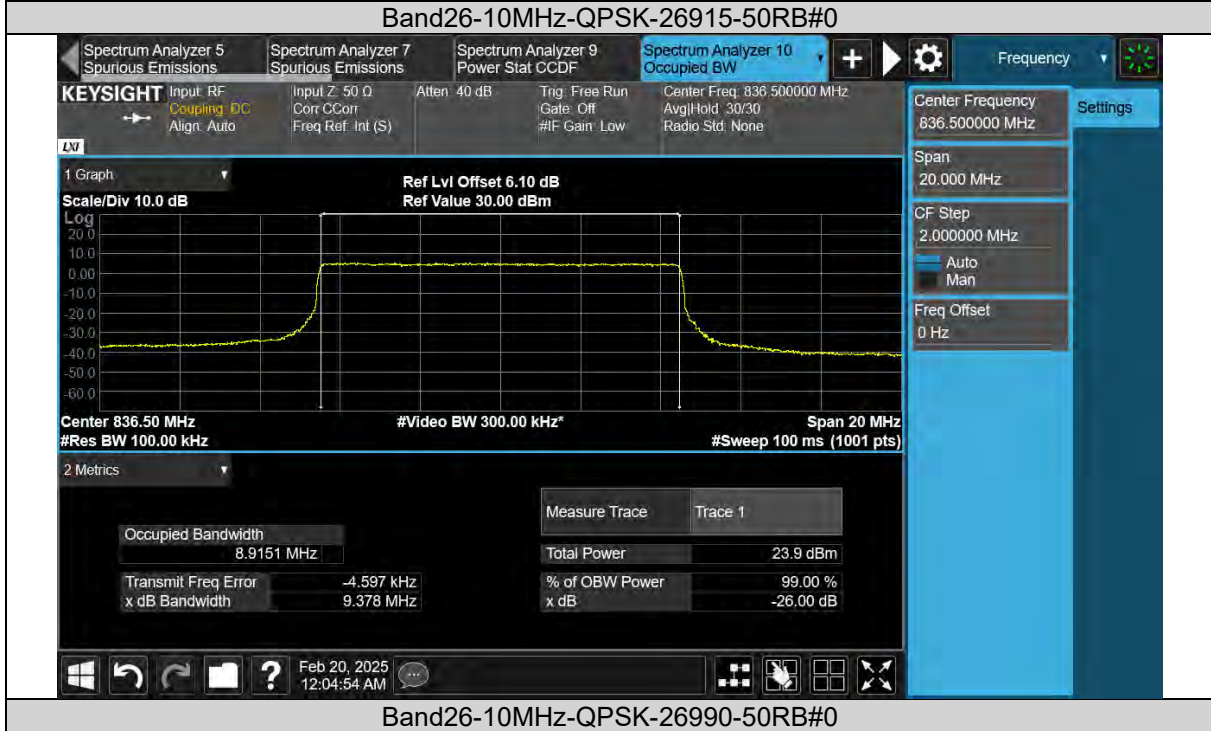
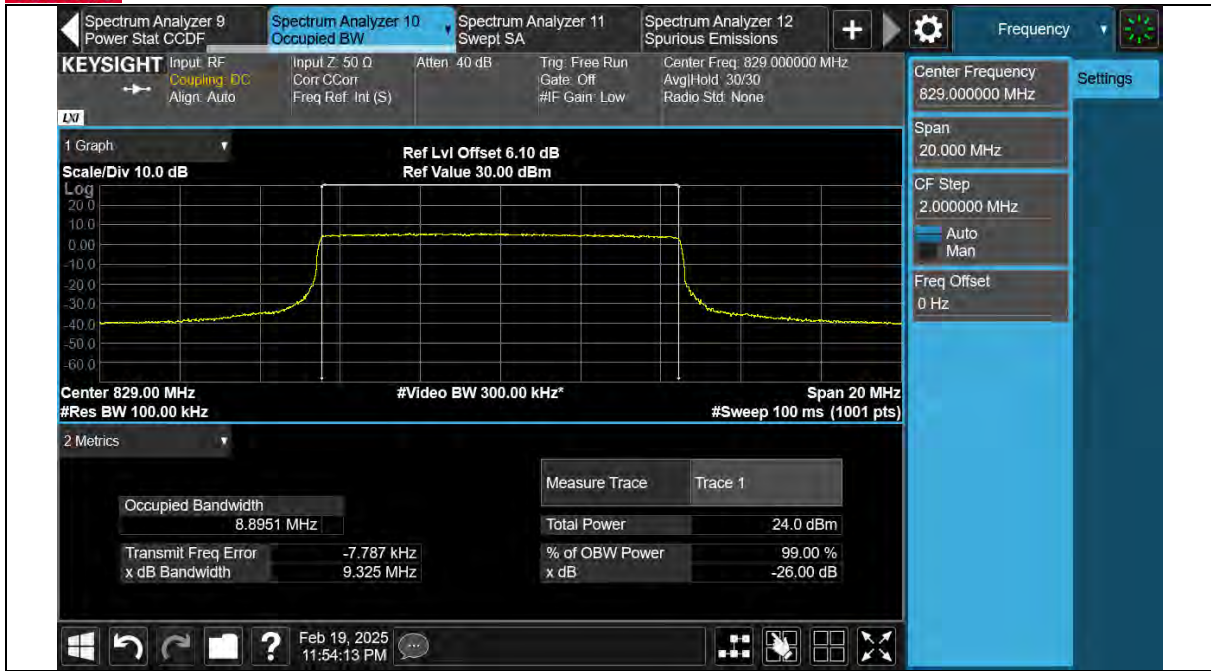



**BUREAU VERITAS** Test Report No.: PSZ-NQN2412300616RF01

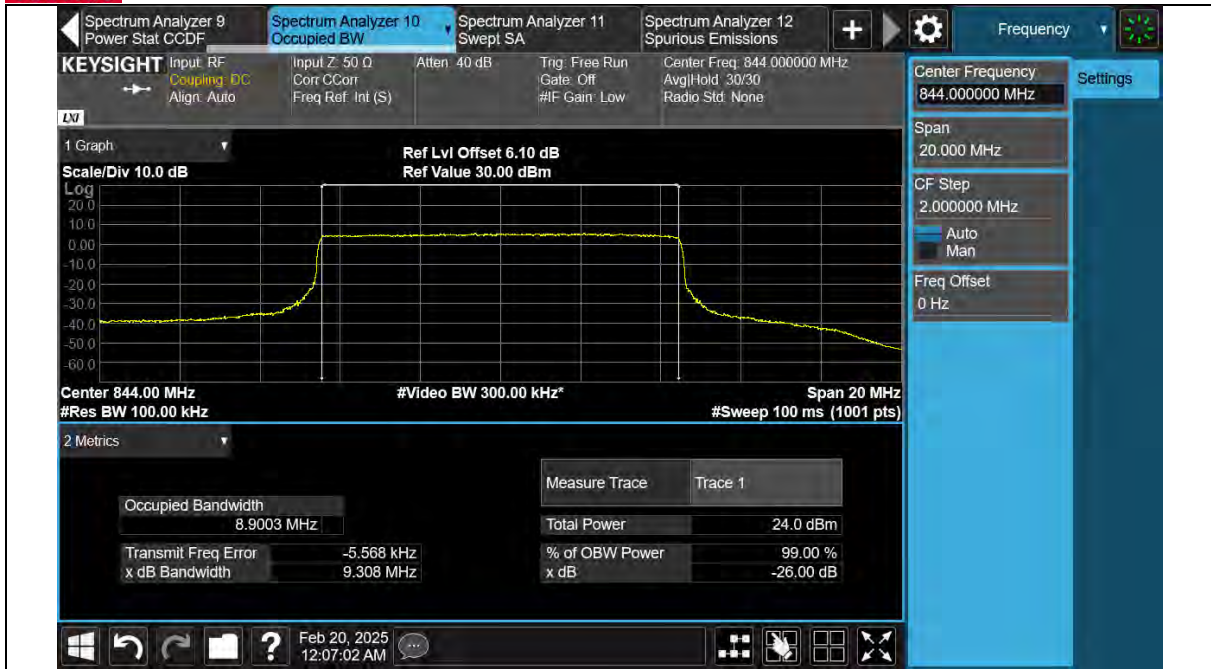

**Band26-10MHz-16QAM-26840-27RB#0**

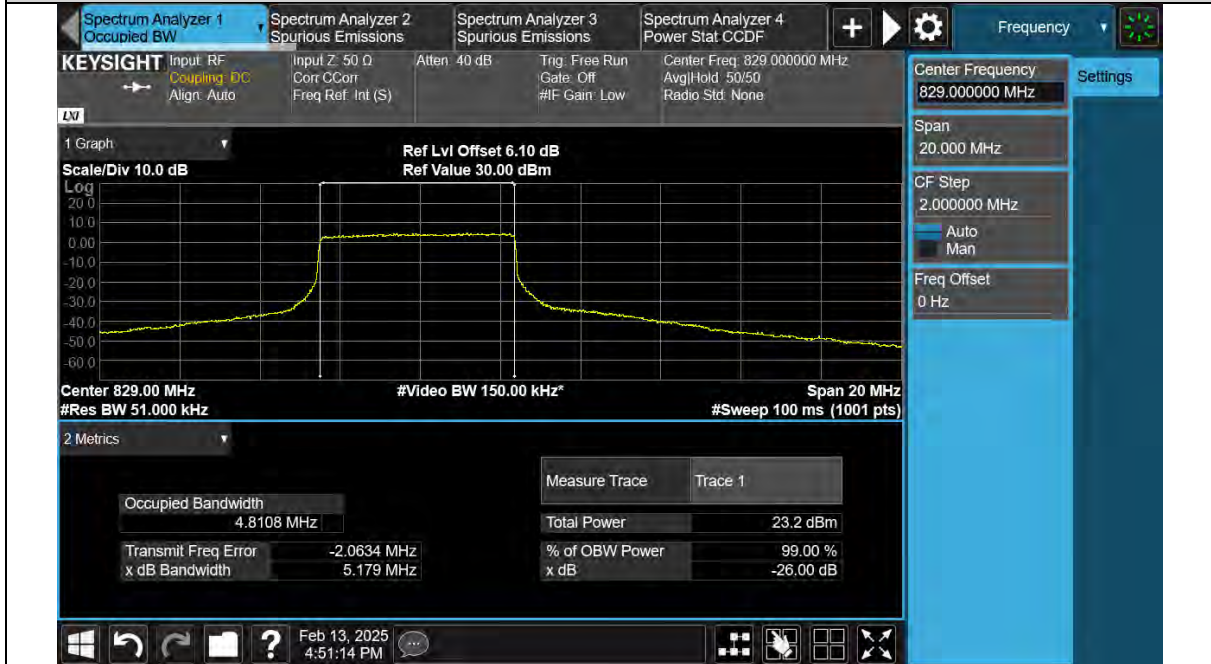

**Band26-10MHz-16QAM-26915-27RB#0**



**BUREAU VERITAS** Test Report No.: PSZ-NQN2412300616RF01

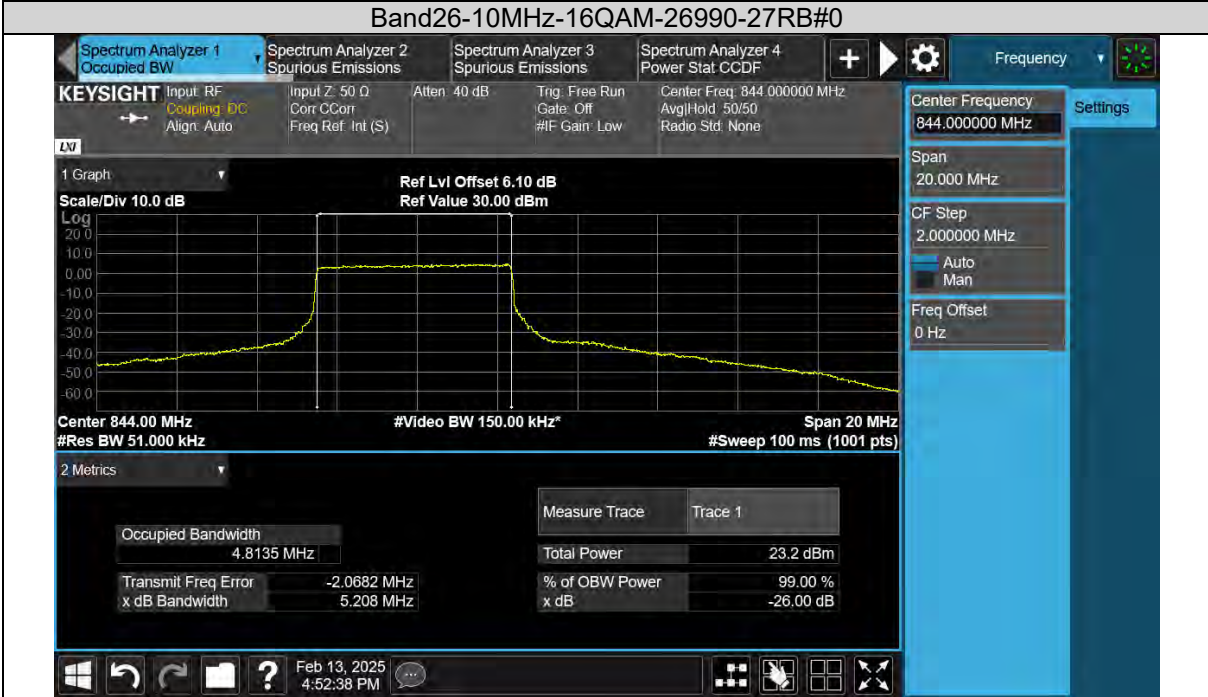
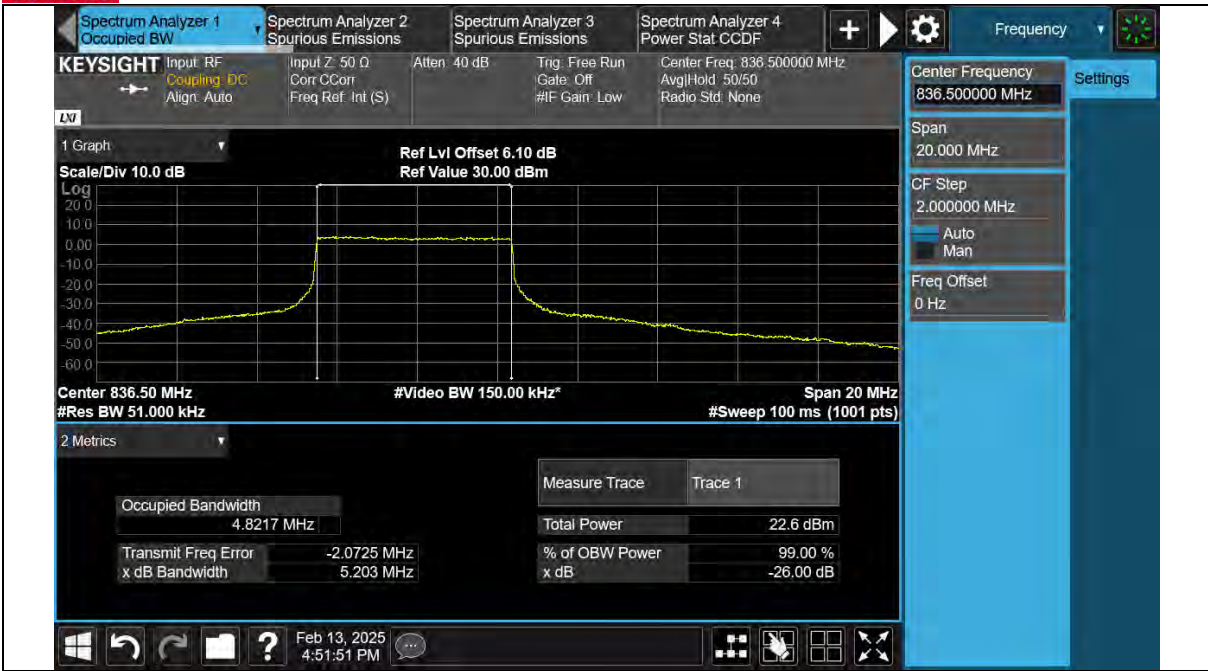



**BUREAU VERITAS** Test Report No.: PSZ-NQN2412300616RF01

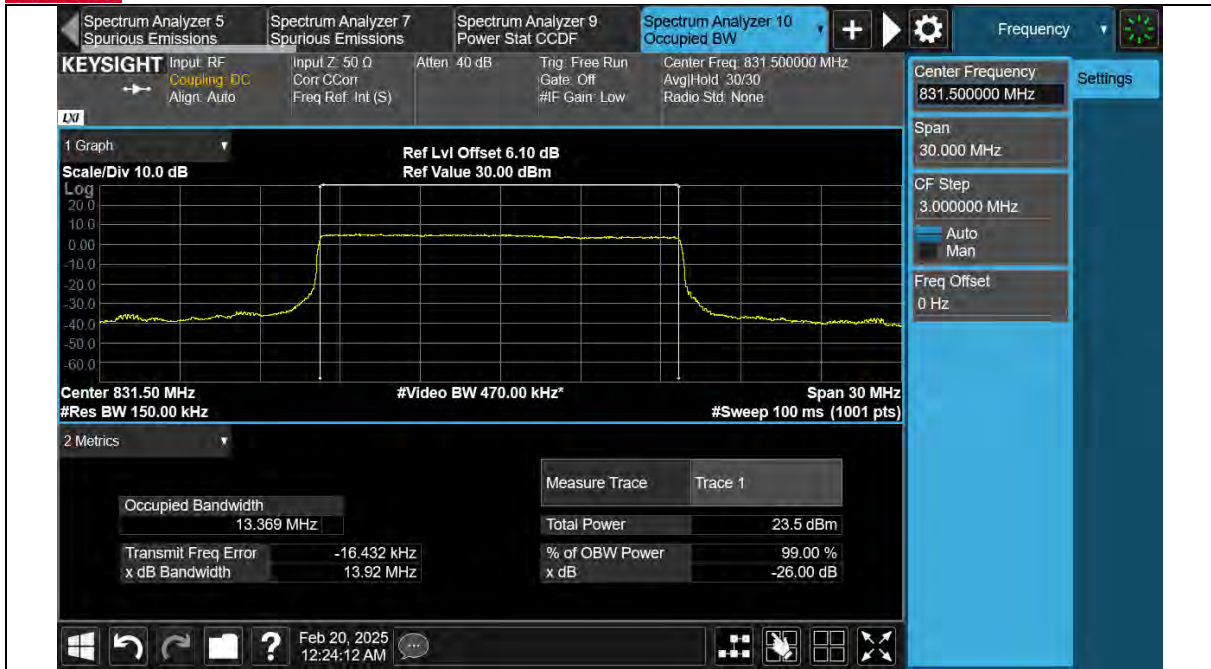

**Band26-15MHz-QPSK-26915-75RB#0**

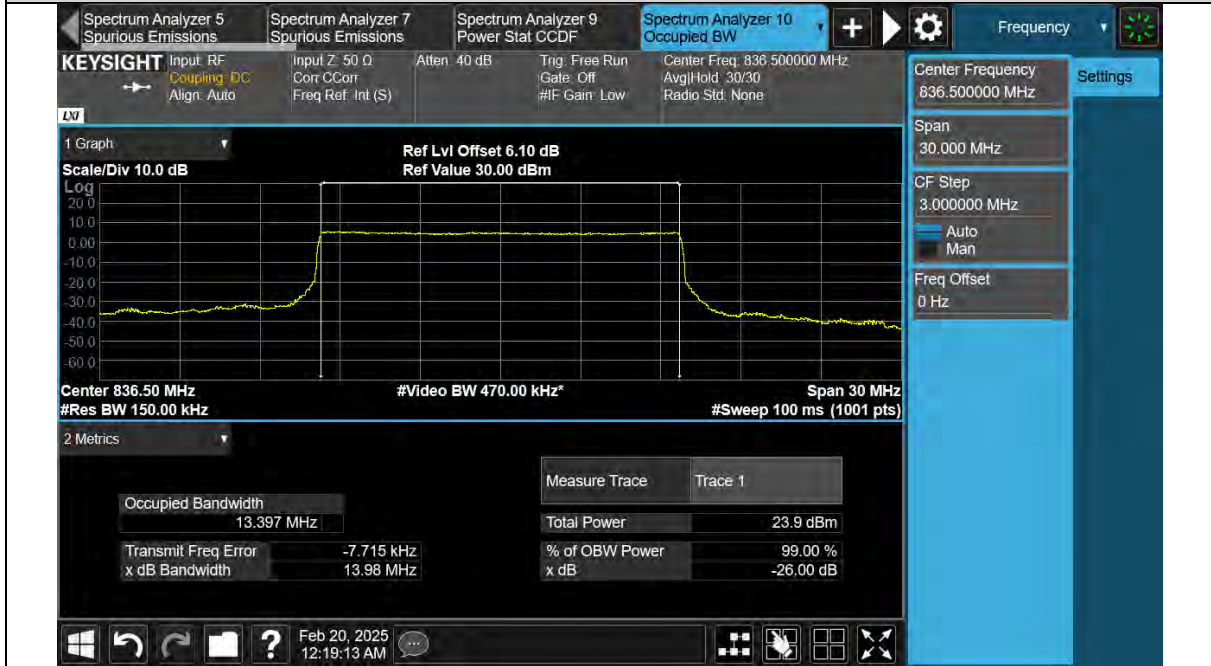

**Band26-15MHz-QPSK-26965-75RB#0**



**BUREAU VERITAS** Test Report No.: PSZ-NQN2412300616RF01



**Band26-15MHz-16QAM-26865-27RB#0**



**Band26-15MHz-16QAM-26915-27RB#0**



**Band26-15MHz-16QAM-26965-27RB#0**







**BAND EDGE**

**Test Result**

Band	Bandwidth	Modulation	Channel	RB Configuration	Result(dBm)	Verdict
Band26	1.4MHz	QPSK	26797	1RB#0	See Graph	PASS
Band26	1.4MHz	QPSK	26797	6RB#0	See Graph	PASS
Band26	1.4MHz	QPSK	27033	1RB#5	See Graph	PASS
Band26	1.4MHz	QPSK	27033	6RB#0	See Graph	PASS
Band26	1.4MHz	16QAM	26797	1RB#0	See Graph	PASS
Band26	1.4MHz	16QAM	26797	6RB#0	See Graph	PASS
Band26	1.4MHz	16QAM	27033	1RB#5	See Graph	PASS
Band26	1.4MHz	16QAM	27033	6RB#0	See Graph	PASS
Band26	3MHz	QPSK	26805	1RB#0	See Graph	PASS
Band26	3MHz	QPSK	26805	15RB#0	See Graph	PASS
Band26	3MHz	QPSK	27025	1RB#14	See Graph	PASS
Band26	3MHz	QPSK	27025	15RB#0	See Graph	PASS
Band26	3MHz	16QAM	26805	1RB#0	See Graph	PASS
Band26	3MHz	16QAM	26805	15RB#0	See Graph	PASS
Band26	3MHz	16QAM	27025	1RB#14	See Graph	PASS
Band26	3MHz	16QAM	27025	15RB#0	See Graph	PASS
Band26	5MHz	QPSK	26815	1RB#0	See Graph	PASS
Band26	5MHz	QPSK	26815	25RB#0	See Graph	PASS
Band26	5MHz	QPSK	27015	1RB#24	See Graph	PASS
Band26	5MHz	QPSK	27015	25RB#0	See Graph	PASS
Band26	5MHz	16QAM	26815	1RB#0	See Graph	PASS
Band26	5MHz	16QAM	26815	25RB#0	See Graph	PASS
Band26	5MHz	16QAM	27015	1RB#24	See Graph	PASS
Band26	5MHz	16QAM	27015	25RB#0	See Graph	PASS
Band26	10MHz	QPSK	26840	1RB#0	See Graph	PASS
Band26	10MHz	QPSK	26840	50RB#0	See Graph	PASS
Band26	10MHz	QPSK	26990	1RB#49	See Graph	PASS
Band26	10MHz	QPSK	26990	50RB#0	See Graph	PASS
Band26	10MHz	16QAM	26840	1RB#0	See Graph	PASS
Band26	10MHz	16QAM	26840	27RB#0	See Graph	PASS
Band26	10MHz	16QAM	26990	1RB#49	See Graph	PASS
Band26	10MHz	16QAM	26990	27RB#23	See Graph	PASS
Band26	15MHz	QPSK	26865	1RB#0	See Graph	PASS
Band26	15MHz	QPSK	26865	75RB#0	See Graph	PASS
Band26	15MHz	QPSK	26965	1RB#74	See Graph	PASS
Band26	15MHz	QPSK	26965	75RB#0	See Graph	PASS
Band26	15MHz	16QAM	26865	1RB#0	See Graph	PASS
Band26	15MHz	16QAM	26865	27RB#0	See Graph	PASS
Band26	15MHz	16QAM	26965	1RB#74	See Graph	PASS
Band26	15MHz	16QAM	26965	27RB#48	See Graph	PASS



### Test Graphs

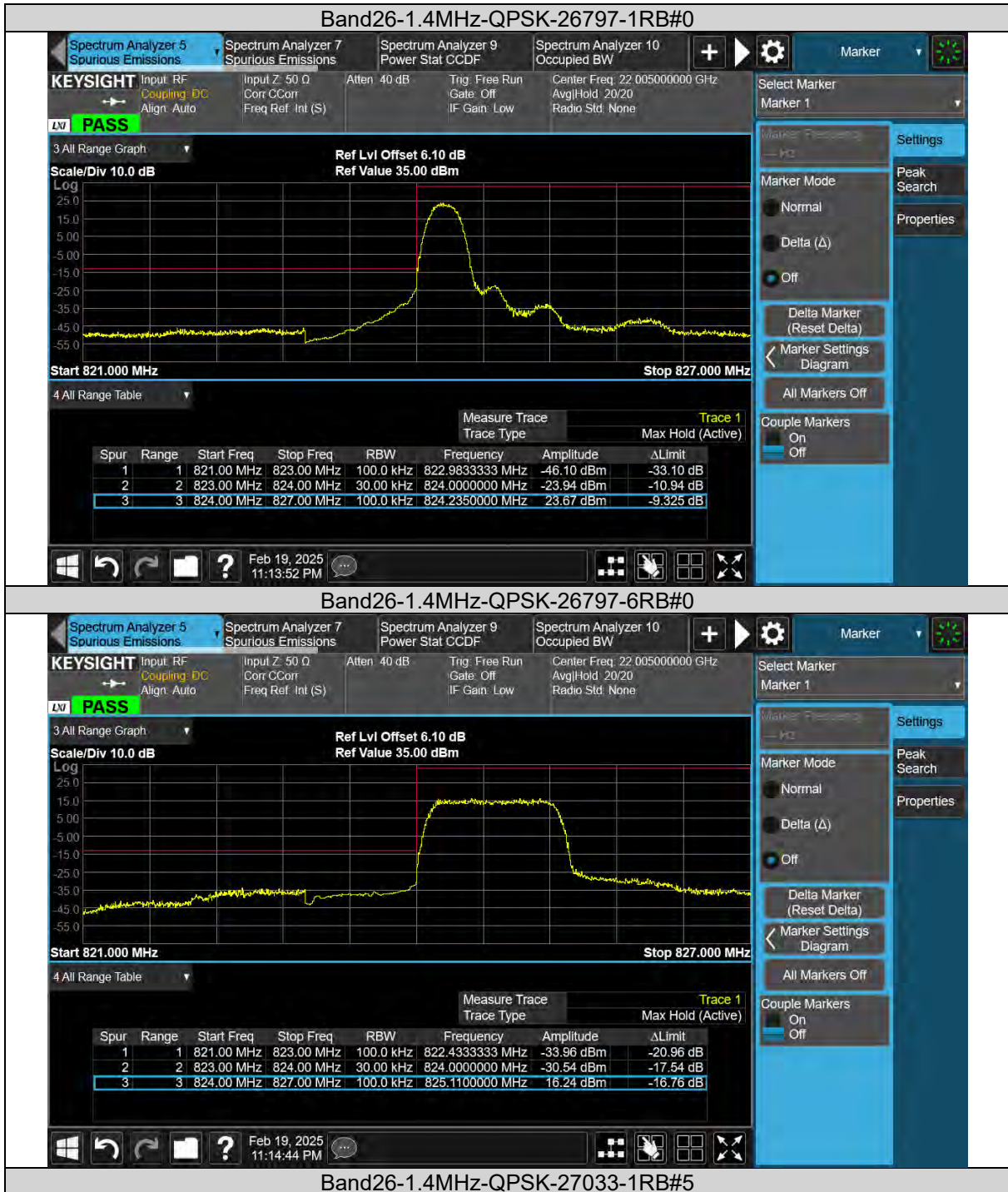



**BUREAU VERITAS** Test Report No.: PSZ-NQN2412300616RF01

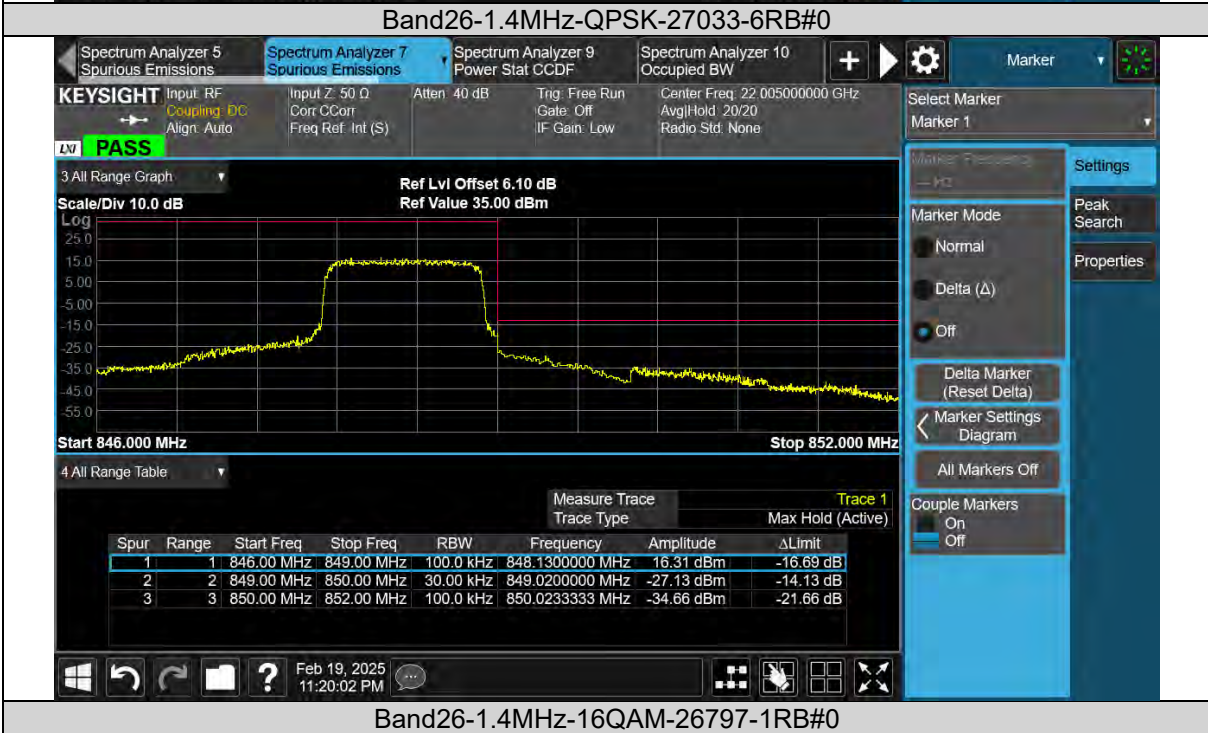
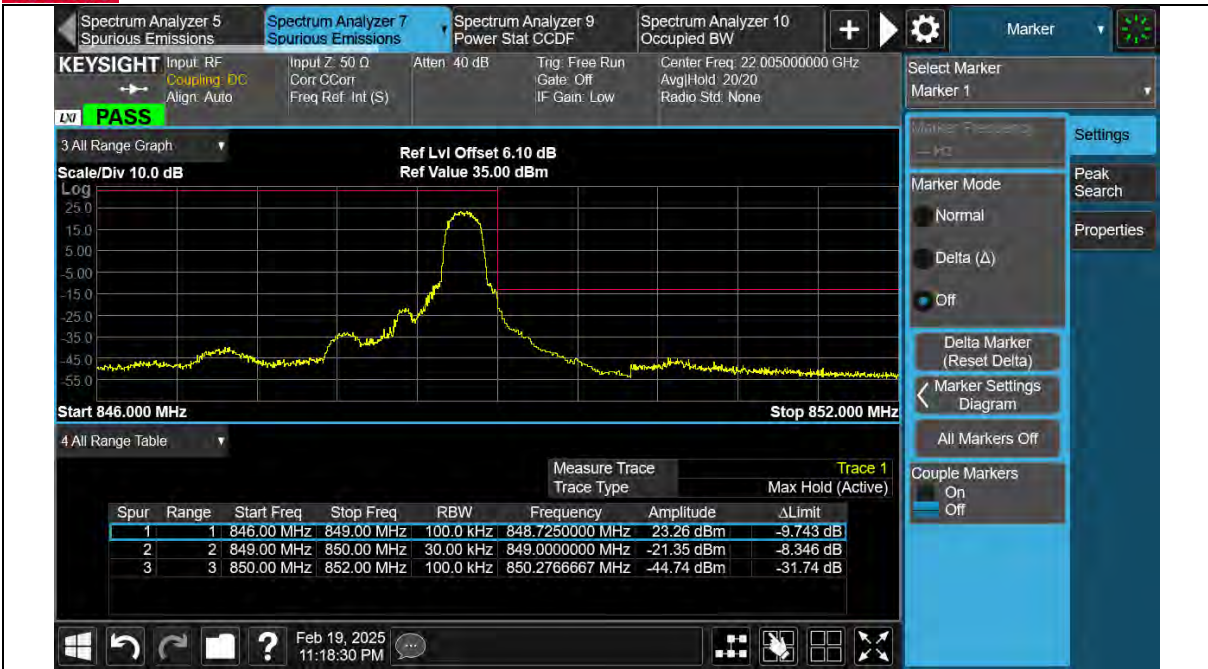



**BUREAU VERITAS** Test Report No.: PSZ-NQN2412300616RF01

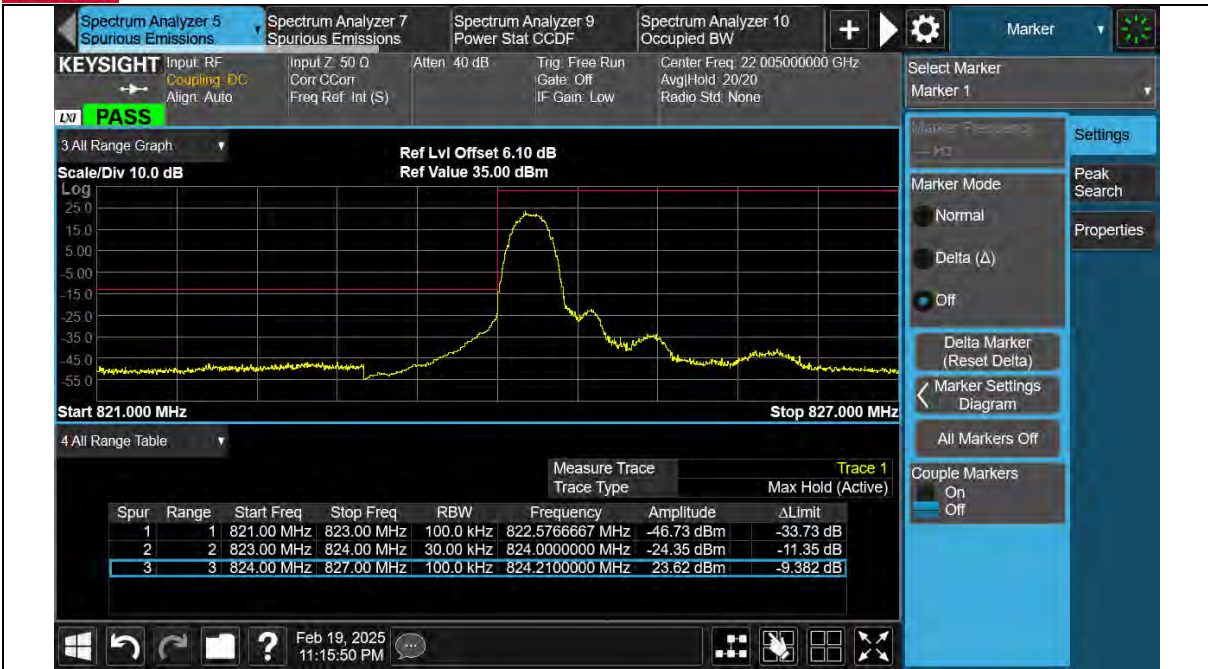

Band26-1.4MHz-16QAM-26797-6RB#0

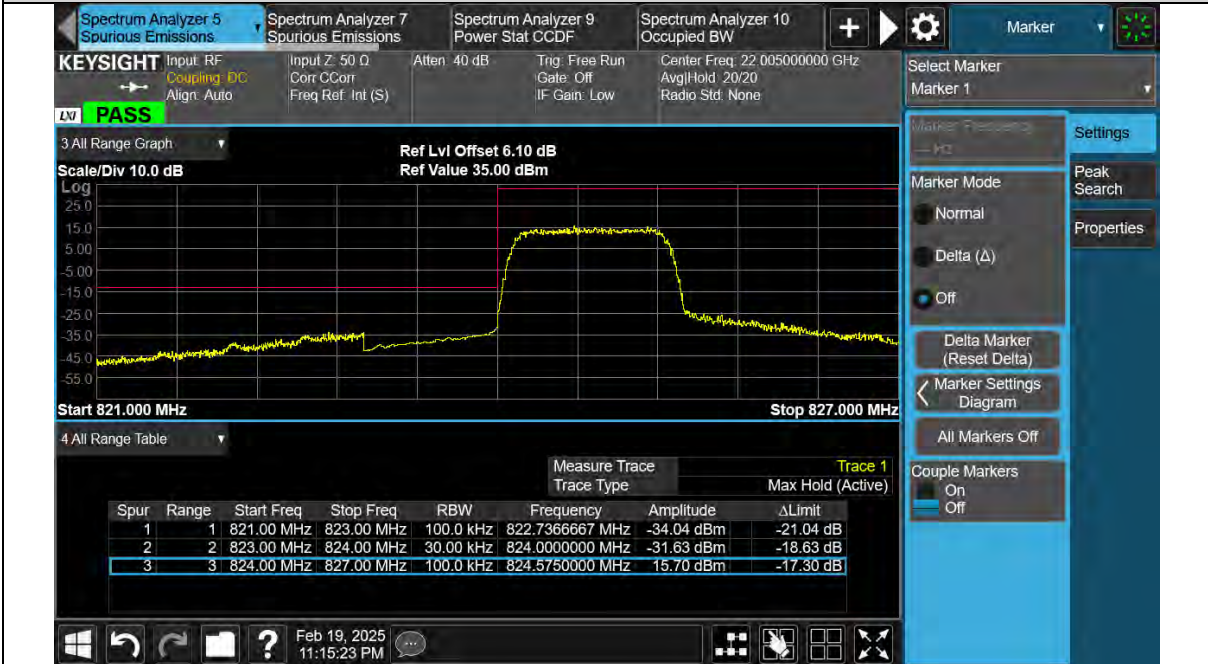

Band26-1.4MHz-16QAM-27033-1RB#5