

# FCC SAR EVALUATION REPORT

**In accordance with the requirements of  
FCC 47 CFR Part 2(2.1093) and  
IEEE Std 1528-2013**

Product Name: Laptop

Model No.: J1

Serial Model: N/A

Brand Name: N/A

Report No.: AITSZ-241127149FW1

FCC ID: 2AQAA-J1

**Prepared for**

Shenzhen Jumper Technology Co., Ltd  
Room B601, C601, JMD Industrial Park, No. 39 Qingfeng Blvd., Baolong Community,  
Baolong Street, Longgang District, Shenzhen, China

**Prepared by**

**Guangdong Asia Hongke Test Technology Limited**  
B1/F, Building 11, Junfeng Industrial Park, Chongqing Road, Heping Community, Fuhai  
Street, Bao'an District, Shenzhen, Guangdong, China  
Tel.: +86 0755-230967639 Fax.: +86 0755-230967639

## TEST RESULT CERTIFICATION

**Applicant's name** ..... : Shenzhen Jumper Technology Co., Ltd  
Room B601, C601, JMD Industrial Park, No. 39 Qingfeng Blvd.,  
**Address** ..... : Baolong Community, Baolong Street, Longgang District,  
Shenzhen, China  
**Manufacturer's Name** ..... : Shenzhen Jumper Technology Co., Ltd  
Room B601, C601, JMD Industrial Park, No. 39 Qingfeng Blvd.,  
**Address** ..... : Baolong Community, Baolong Street, Longgang District,  
Shenzhen, China

### Product description

**Product name** ..... : Laptop  
**Trademark** ..... : N/A  
**Model and/or type reference** : J1  
**Serial Model**..... : N/A  
FCC 47 CFR Part 2(2.1093)

**Standards** ..... : IEEE Std 1528-2013  
Published RF exposure KDB procedures

This device described above has been tested by Guangdong Asia Hongke Test Technology Limited. In accordance with the measurement methods and procedures specified in IEEE Std 1528-2013 and KDB 865664 D01. Testing has shown that this device is capable of compliance with localized specific absorption rate (SAR) specified in FCC 47 CFR Part 2(2.1093). The test results in this report apply only to the tested sample of the stated device/equipment. Other similar device/equipment will not necessarily produce the same results due to production tolerance and measurement uncertainties.

This report shall not be reproduced except in full, without the written approval of Guangdong Asia Hongke Test Technology Limited, this document may be altered or revised by Guangdong Asia Hongke Test Technology Limited, personal only, and shall be noted in the revision of the document.

**Test Sample Number**..... : N/A

### Date of Test

**Date (s) of performance of tests** ..... : Nov.27, 2024 ~ Nov.29, 2024

**Date of Issue**..... : Dec.04, 2024

**Test Result**..... : **Pass**

**Reviewed by:**   
Simba Huang

**Approved by:**   
Seal.chen

**※ ※ Revision History ※ ※**

| REV.    | DESCRIPTION                 | ISSUED DATE  | REMARK    |
|---------|-----------------------------|--------------|-----------|
| Rev.1.0 | Initial Test Report Release | Dec.04, 2024 | Seal.chen |
|         |                             |              |           |
|         |                             |              |           |
|         |                             |              |           |

## TABLE OF CONTENTS

|  |    |
|--|----|
| 1. General Information .....                                 | 6  |
| 1.1. RF exposure limits .....                                | 6  |
| 1.2. Statement of Compliance.....                            | 7  |
| 1.3. EUT Description .....                                   | 8  |
| 1.4. Test specification(s) .....                             | 9  |
| 1.5. Ambient Condition.....                                  | 9  |
| 1.6. Test Facility.....                                      | 9  |
| 2. SAR Measurement System .....                              | 10 |
| 2.1. SATIMO SAR Measurement Set-up Diagram.....              | 10 |
| 2.2. Robot .....   | 11 |
| 2.3. Probe .....   | 12 |
| 2.3.1. E-Field Probe Calibration.....                        | 12 |
| 2.4. Phantoms.....   | 13 |
| 2.5. Technical Data .....                                    | 14 |
| 2.6. Device Holder .....                                     | 15 |
| 2.7. Test Equipment List .....                               | 16 |
| 3. SAR Measurement Procedures .....                          | 18 |
| 3.1. Power Reference.....                                    | 18 |
| 3.2. Area scan & Zoom scan .....                             | 18 |
| 3.3. Description of interpolation/extrapolation scheme ..... | 20 |
| 3.4. Volumetric Scan .....                                   | 20 |
| 3.5. Power Drift .....                                       | 20 |
| 4. System Verification Procedure.....                        | 21 |
| 4.1. Tissue Verification.....                                | 21 |
| 4.1.1. Tissue Dielectric Parameter Check Results .....       | 22 |
| 4.2. System Verification Procedure .....                     | 23 |
| 4.2.1. System Verification Results .....                     | 24 |
| 5. SAR measurement variability.....                          | 25 |
| 6. SAR Measurement Uncertainty.....                          | 26 |
| 7. RF Exposure Positions .....                               | 27 |
| 7.1. Generic device .....                                    | 27 |
| 8. RF Output Power .....                                     | 28 |
| 8.1. Wi-Fi & BT Output Power .....                           | 28 |
| 9. Stand-alone SAR test exclusion .....                      | 29 |
| 10. SAR Measurement Results.....                             | 31 |
| 11. Simultaneous Transmission Analysis.....                  | 32 |
| Appendix A. Photo documentation .....                        | 33 |
| Appendix B. System Check Plots .....                         | 34 |
| Appendix C. SAR Test Plots.....                              | 41 |



---

Appendix D. Calibration Certificate ..... 60

# 1. General Information

## 1.1. RF exposure limits

(A).Limits for Occupational/Controlled Exposure (W/kg)

| Whole-Body | Partial-Body | Hands, Wrists, Feet and Ankles |
|------------|--------------|--------------------------------|
| 0.4        | 8.0          | 20.0                           |

(B).Limits for General Population/Uncontrolled Exposure (W/kg)

| Whole-Body | Partial-Body | Hands, Wrists, Feet and Ankles |
|------------|--------------|--------------------------------|
| 0.08       | 1.6          | 4.0                            |

NOTE: **Whole-Body SAR** is averaged over the entire body, **partial-body SAR** is averaged over any 1 gram of tissue defined as a tissue volume in the shape of a cube. **SAR for hands, wrists, feet and ankles** is averaged over any 10 grams of tissue defined as a tissue volume in the shape of a cube.

### Occupational/Controlled Environments:

Are defined as locations where there is exposure that may be incurred by people who are aware of the potential for exposure, (i.e. as a result of employment or occupation).

### General Population/Uncontrolled Environments:

Are defined as locations where there is the exposure of individuals who have no knowledge or control of their exposure.

NOTE  
TRUNK LIMIT  
1.6 W/kg  
APPLIED TO THIS EUT

## 1.2. Statement of Compliance

The maximum results of Specific Absorption Rate (SAR) found during testing as follows.

| Band        | Max SAR Value Reported(W/kg)                         |       | Max SAR Summation |
|-------------|--|-------|-------------------|
|             | 1-g back of Keyboard<br>(Separation distance of 0mm) |       |                   |
|             | ANT1   | ANT2  |                   |
| 2.4GHz WLAN | 0.268  | 0.281 | Body: 0.750       |
| 5.2GHz WLAN | 0.549  | 0.696 |                   |
| 5.8GHz WLAN | 0.597  | 0.519 |                   |

NOTE: The Max SAR Summation is calculated based on the same configuration and test position.

This device is in compliance with Specific Absorption Rate (SAR) for general population/uncontrolled exposure limits (1.6 W/kg) specified in FCC 47 CFR Part 2(2.1093), and had been tested in accordance with the measurement methods and procedures specified in IEEE Std 1528-2013 & KDB 865664 D01.

### 1.3. EUT Description

| Device Information              |  |           |          |
|---------------------------------|--|-----------|----------|
| Product Name                    | Laptop   |           |          |
| Model Name                      | J1   |           |          |
| Family Model                    | N/A  |           |          |
| FCC ID                          | 2AQAA-J1   |           |          |
| Device Phase                    | Identical Prototype                                    |           |          |
| Exposure Category               | General population / Uncontrolled environment          |           |          |
| Antenna Type                    | FPC Antenna  |           |          |
| Battery Information             | DC 12V   |           |          |
| Hardware version                | N/A  |           |          |
| Software version                | N/A  |           |          |
| Device Operating Configurations |  |           |          |
| Supporting Mode(s)              | WLAN 2.4G/5.2G/5.8G, Bluetooth                         |           |          |
| Test Modulation                 | WLAN(DSSS/OFDM), Bluetooth(GFSK, $\pi/4$ DQPSK, 8DPSK) |           |          |
| Device Class                    | B  |           |          |
| Operating Frequency Range(s)    | Band   | Tx (MHz)  | Rx (MHz) |
|                                 | WLAN 2.4G  | 2412-2462 |          |
|                                 | WLAN 5.2G  | 5180-5240 |          |
|                                 | WLAN 5.8G  | 5745-5825 |          |
|                                 | Bluetooth  | 2402-2480 |          |



#### 1.4. Test specification(s)

|  |
|--|
| FCC 47 CFR Part 2(2.1093)                        |
| IEEE Std 1528-2013                               |
| KDB 865664 D01 SAR measurement 100 MHz to 6 GHz  |
| KDB 865664 D02 RF Exposure Reporting             |
| KDB 447498 D01 General RF Exposure Guidance      |
| KDB 616217 D04 SAR for laptop and tablets v01r02 |
| KDB 248227 D01 802.11 Wi-Fi SAR                  |

#### 1.5. Ambient Condition

|                     |             |
|---------------------|-------------|
| Ambient temperature | 20°C – 24°C |
| Relative Humidity   | 30% – 70%   |

#### 1.6. Test Facility

**Test Laboratory:**

**Guangdong Asia Hongke Test Technology Limited**

B1/F, Building 11, Junfeng Industrial Park, Chongqing Road, Heping Community, Fuhai Street, Bao'an District, Shenzhen, Guangdong, China

The test facility is recognized, certified or accredited by the following organizations:

**FCC-Registration No.: 251906 Designation Number: CN1376**

Guangdong Asia Hongke Test Technology Limited has been registered and fully described in a report filed with the (FCC) Federal Communications Commission. The acceptance letter from the FCC is maintained in our files.

**IC —Registration No.: 31737 CAB identifier: CN0165**

The 3m Semi-anechoic chamber of Guangdong Asia Hongke Test Technology Limited has been registered by Certification and Engineering Bureau of Industry Canada for radio equipment testing with Registration No.: 31737

**A2LA-Lab Cert. No.: 7133.01**

Guangdong Asia Hongke Test Technology Limited has been accredited by A2LA for technical competence in the field of electrical testing, and proved to be in compliance with ISO/IEC 17025: 2017 General Requirements for the Competence of Testing and Calibration Laboratories and any additional program requirements in the identified field of testing.

## 2. SAR Measurement System

### 2.1. SATIMO SAR Measurement Set-up Diagram

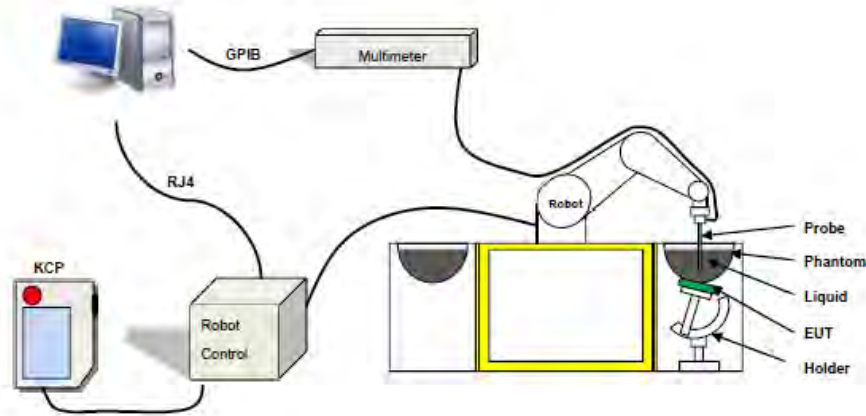

These measurements were performed with the automated near-field scanning system OPENSAR from SATIMO. The system is based on a high precision robot (working range: 901 mm), which positions the probes with a positional repeatability of better than  $\pm 0.03$  mm. The SAR measurements were conducted with dosimetric probe (manufactured by SATIMO), designed in the classical triangular configuration and optimized for dosimetric evaluation.

The first step of the field measurement is the evaluation of the voltages induced on the probe by the device under test. Probe diode detectors are nonlinear. Below the diode compression point, the output voltage is proportional to the square of the applied E-field; above the diode compression point, it is linear to the applied E-field. The compression point depends on the diode, and a calibration procedure is necessary for each sensor of the probe.

The Keithley multimeter reads the voltage of each sensor and send these three values to the PC. The corresponding E field value is calculated using the probe calibration factors, which are stored in the working directory. This evaluation includes linearization of the diode characteristics. The field calculation is done separately for each sensor. Each component of the E field is displayed on the "Dipole Area Scan Interface" and the total E field is displayed on the "3D Interface"

## 2.2. Robot

The SATIMO SAR system uses the high precision robots from KUKA. For the 6-axis controller system, the robot controller version (KUKA) from KUKA is used. The KUKA robot series have many features that are important for our application:



- High precision (repeatability  $\pm 0.03$  mm)
- High reliability (industrial design)
- Jerk-free straight movements
- Low ELF interference (the closed metallic construction shields against motor control fields)

## 2.3. Probe

This E-field detection probe is composed of three orthogonal dipoles linked to special Schottky diodes with low detection thresholds. The probe allows the measurement of electric fields in liquids such as the one defined in the IEEE and CENELEC standards.

For the measurements the Specific Dosimetric E-Field Probe EPGO 0523-403 with following specifications is used.



- Probe Length: 330 mm
- Length of Individual Dipoles: 2 mm
- Maximum external diameter: 8 mm
- Probe Tip External Diameter: 2.5 mm
- Distance between dipole/probe extremity: 1 mm
- Dynamic range: 0.01-100 W/kg
- Probe linearity: 3%
- Axial Isotropy: < 0.10 dB
- Spherical Isotropy: < 0.10 dB
- Calibration range: 150 MHz to 6 GHz for head & body simulating liquid.
- Angle between probe axis (evaluation axis) and surface normal line: less than 30°

### 2.3.1. E-Field Probe Calibration

Each probe needs to be calibrated according to a dosimetric assessment procedure with accuracy better than  $\pm 10\%$ . The spherical isotropy shall be evaluated and within  $\pm 0.25\text{dB}$ . The sensitivity parameters (Norm X, Norm Y, and Norm Z), the diode compression parameter (DCP) and the conversion factor (Conv F) of the probe are tested. The calibration data can be referred to appendix D of this report.

## 2.4. Phantoms

For the measurements the Specific Anthropomorphic Mannequin (SAM) defined by the IEEE SCC-34/SC2 group is used. The phantom is a polyurethane shell integrated in a wooden table. The thickness of the phantom amounts to 2mm +/- 0.2mm. It enables the dosimetric evaluation of left and right phone usage and includes an additional flat phantom part for the simplified performance check. The phantom set-up includes a cover, which prevents the evaporation of the liquid.



SAM

### 2.5. Technical Data

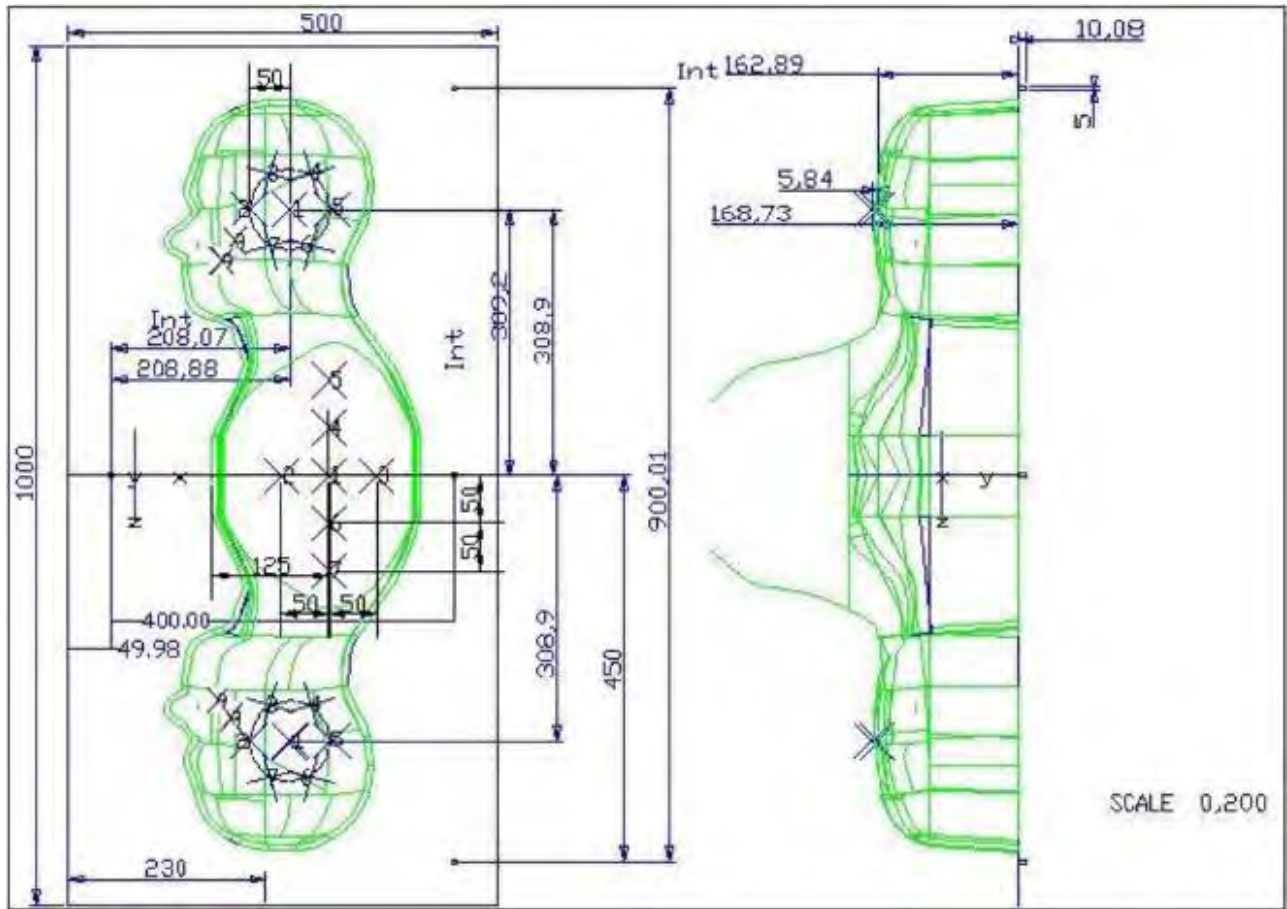

| Left Head(mm) |      | Right Head(mm) |      | Flat Part(mm) |      |
|---------------|------|----------------|------|---------------|------|
| 2             | 2.02 | 2              | 2.08 | 1             | 2.09 |
| 3             | 2.05 | 3              | 2.06 | 2             | 2.06 |
| 4             | 2.07 | 4              | 2.07 | 3             | 2.08 |
| 5             | 2.08 | 5              | 2.08 | 4             | 2.10 |
| 6             | 2.05 | 6              | 2.07 | 5             | 2.10 |
| 7             | 2.05 | 7              | 2.05 | 6             | 2.07 |
| 8             | 2.07 | 8              | 2.06 | 7             | 2.07 |
| 9             | 2.08 | 9              | 2.06 | -             | -    |

The test, based on ultrasonic system, allows measuring the thickness with an accuracy of 10 µm.

## 2.6. Device Holder

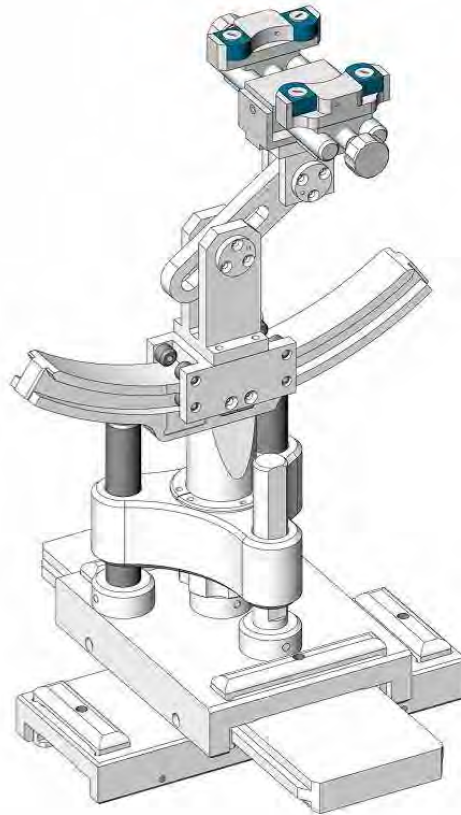

The SAR in the phantom is approximately inversely proportional to the square of the distance between the source and the liquid surface. For a source at 5 mm distance, a positioning uncertainty of  $\pm 0.5$  mm would produce a SAR uncertainty of  $\pm 20$  %. Accurate device positioning is therefore crucial for accurate and repeatable measurements. The positions in which the devices must be measured are defined by the standards.



## 2.7. Test Equipment List

This table gives a complete overview of the SAR measurement equipment.

Devices used during the test described are marked

|                                     | Manufacturer | Name of Equipment                    | Type/Model | Serial Number              | Calibration   |               |
|-------------------------------------|--------------|--------------------------------------|------------|----------------------------|---------------|---------------|
|                                     |              |                                      |            |                            | Last Cal.     | Due Date      |
| <input checked="" type="checkbox"/> | MVG          | E FIELD PROBE                        | SSE2       | EPGO 0523-403              | Sep. 11, 2024 | Sep. 10, 2025 |
| <input type="checkbox"/>            | MVG          | 750 MHz Dipole                       | SID750     | SN 03/15 DIP<br>0G750-355  | Feb. 21, 2024 | Feb. 20, 2027 |
| <input type="checkbox"/>            | MVG          | 835 MHz Dipole                       | SID835     | SN 03/15 DIP<br>0G835-347  | Feb. 21, 2024 | Feb. 20, 2027 |
| <input type="checkbox"/>            | MVG          | 900 MHz Dipole                       | SID900     | SN 03/15 DI P<br>0G900-348 | Feb. 21, 2024 | Feb. 20, 2027 |
| <input type="checkbox"/>            | MVG          | 1800 MHz Dipole                      | SID1800    | SN 03/15 DIP<br>1G800-349  | Feb. 21, 2024 | Feb. 20, 2027 |
| <input type="checkbox"/>            | MVG          | 1900 MHz Dipole                      | SID1900    | SN 03/15 DIP<br>1G900-350  | Feb. 21, 2024 | Feb. 20, 2027 |
| <input type="checkbox"/>            | MVG          | 2000 MHz Dipole                      | SID2000    | SN 03/15 DIP<br>2G000-351  | Feb. 21, 2024 | Feb. 20, 2027 |
| <input type="checkbox"/>            | MVG          | 2300 MHz Dipole                      | SID2300    | SN 03/16 DIP<br>2G300-358  | Feb. 21, 2024 | Feb. 20, 2027 |
| <input checked="" type="checkbox"/> | MVG          | 2450 MHz Dipole                      | SID2450    | SN 03/15 DIP<br>2G450-352  | Feb. 21, 2024 | Feb. 20, 2027 |
| <input type="checkbox"/>            | MVG          | 2600 MHz Dipole                      | SID2600    | SN 03/15 DIP<br>2G600-356  | Feb. 21, 2024 | Feb. 20, 2027 |
| <input checked="" type="checkbox"/> | MVG          | 5000 MHz Dipole                      | SWG5500    | SN 13/14 WGA 33            | Feb. 21, 2024 | Feb. 20, 2027 |
| <input checked="" type="checkbox"/> | MVG          | Liquid measurement Kit               | SCLMP      | SN 21/15 OCPG 72           | Jul. 01, 2024 | Jun. 30, 2025 |
| <input checked="" type="checkbox"/> | MVG          | Power Amplifier                      | N.A        | AMPLISAR_28/14_003         | NCR           | NCR           |
| <input checked="" type="checkbox"/> | KEITHLEY     | Millivoltmeter                       | 2000       | 4072790                    | Jul. 01, 2024 | Jun. 30, 2025 |
| <input type="checkbox"/>            | R&S          | Universal radio communication tester | CMU200     | 117858                     | Jul. 01, 2024 | Jun. 30, 2025 |
| <input type="checkbox"/>            | R&S          | Wideband radio communication tester  | CMW500     | 116581                     | Jul. 01, 2024 | Jun. 30, 2025 |
| <input checked="" type="checkbox"/> | HP           | Network Analyzer                     | 8753D      | 3410J01136                 | Jul. 01, 2024 | Jun. 30, 2025 |



|                                     |          |                             |         |                |               |               |
|-------------------------------------|----------|-----------------------------|---------|----------------|---------------|---------------|
| <input checked="" type="checkbox"/> | Agilent  | PSG Analog Signal Generator | E8257D  | MY51110112     | Jul. 01, 2024 | Jun. 30, 2025 |
| <input checked="" type="checkbox"/> | Agilent  | Power meter                 | E4419B  | MY45102538     | Jul. 01, 2024 | Jun. 30, 2025 |
| <input checked="" type="checkbox"/> | Agilent  | Power sensor                | E9301A  | MY41495644     | Jul. 01, 2024 | Jun. 30, 2025 |
| <input checked="" type="checkbox"/> | Agilent  | Power sensor                | E9301A  | US39212148     | Jul. 01, 2024 | Jun. 30, 2025 |
| <input checked="" type="checkbox"/> | MCLI/USA | Directional Coupler         | CB11-20 | 0D2L51502      | Jul. 17, 2024 | Jul. 16, 2027 |
| <input checked="" type="checkbox"/> | MVG      | SAR Phantom                 | SSM2    | SN 24/11 SAM87 | NCR           | NCR           |
| <input checked="" type="checkbox"/> | MVG      | Device Holder               | SMPPD   | SN 24/11 MSH73 | NCR           | NCR           |

### 3. SAR Measurement Procedures

The measurement procedures are as follows:

<Conducted power measurement>

- (a) For WWAN power measurement, use base station simulator to configure EUT WWAN transmission in conducted connection with RF cable, at maximum power in each supported wireless interface and frequency band.
- (b) Read the WWAN RF power level from the base station simulator.
- (c) For Wi-Fi/BT power measurement, use engineering software to configure EUT Wi-Fi/BT continuously transmission, at maximum RF power in each supported wireless interface and frequency band.
- (d) Connect EUT RF port through RF cable to the power meter, and measure Wi-Fi/BT output power.

<SAR measurement>

- (a) Use base station simulator to configure EUT WWAN transmission in radiated connection, and engineering software to configure EUT Wi-Fi/BT continuously transmission, at maximum RF power, in the highest power channel.
- (b) Place the EUT in the positions as Appendix A demonstrates.
- (c) Set scan area, grid size and other setting on the OPENSAR software.
- (d) Measure SAR results for the highest power channel on each testing position.
- (e) Find out the largest SAR result on these testing positions of each band.
- (f) Measure SAR results for other channels in worst SAR testing position if the reported SAR of highest power channel is larger than 0.8 W/kg.

According to the test standard, the recommended procedure for assessing the peak spatial-average SAR value consists of the following steps:

- (a) Power reference measurement
- (b) Area scan
- (c) Zoom scan
- (d) Power drift measurement

#### 3.1. Power Reference

The Power Reference Measurement and Power Drift Measurements are for monitoring the power drift of the device under test in the batch process. The minimum distance of probe sensors to surface determines the closest measurement point to phantom surface. This distance cannot be smaller than the distance of sensor calibration points to probe tip as defined in the probe properties.

#### 3.2. Area scan & Zoom scan

The area scan is a 2D scan to find the hot spot location on the DUT. The zoom scan is a 3D scan

above the hot spot to calculate the 1g and 10g SAR value.

Measurement of the SAR distribution with a grid of 8 to 16 mm \* 8 to 16 mm and a constant distance to the inner surface of the phantom. Since the sensors cannot directly measure at the inner phantom surface, the values between the sensors and the inner phantom surface are extrapolated. With these values the area of the maximum SAR is calculated by an interpolation scheme. Around this point, a cube of 30 \* 30 \* 30 mm or 32 \* 32 \* 32 mm is assessed by measuring 5 or 8 \* 5 or 8 \* 4 or 5 mm. With these data, the peak spatial-average SAR value can be calculated.

From the scanned SAR distribution, identify the position of the maximum SAR value, in addition identify the positions of any local maxima with SAR values within 2 dB of the maximum value that will not be within the zoom scan of other peaks; additional peaks shall be measured only when the primary peak is within 2 dB of the SAR compliance limit (e.g., 1 W/kg for 1,6 W/kg 1 g limit, or 1,26 W/kg for 2 W/kg, 10 g limit).

Area scan & Zoom scan scan parameters extracted from FCC KDB 865664 D01 SAR measurement 100 MHz to 6 GHz.

|   |                                    | ≤ 3 GHz   | > 3 GHz   |
|---|------------------------------------|---|---|
| Maximum distance from closest measurement point (geometric center of probe sensors) to phantom surface  |                                    | 5 ± 1 mm  | $\frac{1}{2} \cdot \delta \cdot \ln(2) \pm 0.5$ mm                          |
| Maximum probe angle from probe axis to phantom surface normal at the measurement location   |                                    | 30° ± 1°  | 20° ± 1°  |
| Maximum area scan spatial resolution: $\Delta x_{Area}$ , $\Delta y_{Area}$   |                                    | ≤ 2 GHz: ≤ 15 mm<br>2 – 3 GHz: ≤ 12 mm  | 3 – 4 GHz: ≤ 12 mm<br>4 – 6 GHz: ≤ 10 mm                                    |
|   |                                    | When the x or y dimension of the test device, in the measurement plane orientation, is smaller than the above, the measurement resolution must be ≤ the corresponding x or y dimension of the test device with at least one measurement point on the test device. |   |
| Maximum zoom scan spatial resolution: $\Delta x_{Zoom}$ , $\Delta y_{Zoom}$   |                                    | ≤ 2 GHz: ≤ 8 mm<br>2 – 3 GHz: ≤ 5 mm*   | 3 – 4 GHz: ≤ 5 mm*<br>4 – 6 GHz: ≤ 4 mm*                                    |
| Maximum zoom scan spatial resolution, normal to phantom surface   | uniform grid: $\Delta z_{Zoom}(n)$ | ≤ 5 mm  | 3 – 4 GHz: ≤ 4 mm<br>4 – 5 GHz: ≤ 3 mm<br>5 – 6 GHz: ≤ 2 mm                 |
|   | graded grid                        | $\Delta z_{Zoom}(1)$ : between 1 <sup>st</sup> two points closest to phantom surface  | ≤ 4 mm<br><br>3 – 4 GHz: ≤ 3 mm<br>4 – 5 GHz: ≤ 2.5 mm<br>5 – 6 GHz: ≤ 2 mm |
|   |                                    | $\Delta z_{Zoom}(n>1)$ : between subsequent points  | ≤ 1.5 · $\Delta z_{Zoom}(n-1)$  |
| Minimum zoom scan volume  | x, y, z                            | ≥ 30 mm   | 3 – 4 GHz: ≥ 28 mm<br>4 – 5 GHz: ≥ 25 mm<br>5 – 6 GHz: ≥ 22 mm              |
| Note: $\delta$ is the penetration depth of a plane-wave at normal incidence to the tissue medium; see draft standard IEEE P1528-2011 for details.   |                                    |   |   |
| * When zoom scan is required and the <i>reported</i> SAR from the <i>area scan based 1-g SAR estimation</i> procedures of KDB 447498 is ≤ 1.4 W/kg, ≤ 8 mm, ≤ 7 mm and ≤ 5 mm zoom scan resolution may be applied, respectively, for 2 GHz to 3 GHz, 3 GHz to 4 GHz and 4 GHz to 6 GHz. |                                    |   |   |

### **3.3. Description of interpolation/extrapolation scheme**

The local SAR inside the phantom is measured using small dipole sensing elements inside a probe body. The probe tip must not be in contact with the phantom surface in order to minimise measurements errors, but the highest local SAR will occur at the surface of the phantom.

An extrapolation is used to determine these highest local SAR values. The extrapolation is based on a fourth-order least-square polynomial fit of measured data. The local SAR value is then extrapolated from the liquid surface with a 1 mm step.

The measurements have to be performed over a limited time (due to the duration of the battery) so the step of measurement is high. It could vary between 5 and 8 mm. To obtain an accurate assessment of the maximum SAR averaged over 10 grams and 1 gram requires a very fine resolution in the three dimensional scanned data array.

### **3.4. Volumetric Scan**

The volumetric scan consists of a full 3D scan over a specific area. This 3D scan is useful for multi Tx SAR measurement. Indeed, it is possible with OpenSAR to add, point by point, several volumetric scans to calculate the SAR value of the combined measurement as it is defined in the standard IEEE1528 and IEC62209.

### **3.5. Power Drift**

All SAR testing is under the EUT with a full charged battery and transmit maximum output power. In OpenSAR measurement software, the power reference measurement and power drift measurement procedures are used for monitoring the power drift of EUT during SAR test. Both these procedures measure the field at a specified reference position before and after the SAR testing. The software will calculate the field difference in V/m. If the power drifts more than  $\pm 5\%$ , the SAR will be retested.

## 4. System Verification Procedure

### 4.1. Tissue Verification

The following tissue formulations are provided for reference only as some of the parameters have not been thoroughly verified. The composition of ingredients may be modified accordingly to achieve the desired target tissue parameters required for routine SAR evaluation.

| Ingredients (% of weight) | Head Tissue |       |       |       |       |       |       |       |       |       |
|---------------------------|-------------|-------|-------|-------|-------|-------|-------|-------|-------|-------|
|                           | 750         | 835   | 900   | 1800  | 1900  | 2000  | 2450  | 2600  | 5200  | 5800  |
| Frequency Band (MHz)      | 750         | 835   | 900   | 1800  | 1900  | 2000  | 2450  | 2600  | 5200  | 5800  |
| Water                     | 34.40       | 34.40 | 34.40 | 55.36 | 55.36 | 57.87 | 57.87 | 57.87 | 65.53 | 65.53 |
| NaCl                      | 0.79        | 0.79  | 0.79  | 0.35  | 0.35  | 0.16  | 0.16  | 0.16  | 0.00  | 0.00  |
| 1,2-Propanediol           | 64.81       | 64.81 | 64.81 | 0.00  | 0.00  | 0.00  | 0.00  | 0.00  | 0.00  | 0.00  |
| Triton X-100              | 0.00        | 0.00  | 0.00  | 30.45 | 30.45 | 19.97 | 19.97 | 19.97 | 24.24 | 24.24 |
| DGBE                      | 0.00        | 0.00  | 0.00  | 13.84 | 13.84 | 22.00 | 22.00 | 22.00 | 10.23 | 10.23 |

For SAR measurement of the field distribution inside the phantom, the phantom must be filled with homogeneous tissue simulating liquid to a depth of at least 15 cm. For head SAR testing, the liquid depth from the ear reference point (ERP) of the phantom to the liquid top surface is larger than 15 cm.



**4.1.1. Tissue Dielectric Parameter Check Results**

The simulating liquids should be checked at the beginning of a series of SAR measurements to determine of the dielectric parameter are within the tolerances of the specified target values. The measured conductivity and relative permittivity should be within  $\pm 5\%$  of the target values.

| Tissue Type | Measured Frequency (MHz) | Target Tissue              |                              | Measured Tissue |                | Liquid Temp. | Test Date     |
|-------------|--------------------------|----------------------------|------------------------------|-----------------|----------------|--------------|---------------|
|             |                          | $\epsilon_r$ ( $\pm 5\%$ ) | $\sigma$ (S/m) ( $\pm 5\%$ ) | $\epsilon_r$    | $\sigma$ (S/m) |              |               |
| Head 2450   | 2450                     | 39.20<br>(37.24~41.16)     | 1.80<br>(1.71~1.89)          | 40.41           | 1.82           | 21.4 °C      | Nov. 27, 2024 |
| Head 5200   | 5200                     | 36.00<br>(34.20~37.80)     | 4.66<br>(4.43~4.89)          | 37.40           | 4.66           | 21.3 °C      | Nov. 28, 2024 |
| Head 5800   | 5800                     | 35.30<br>(33.54~37.07)     | 5.27<br>(5.01~5.53)          | 35.30           | 5.27           | 21.2 °C      | Nov. 29, 2024 |

NOTE: The dielectric parameters of the tissue-equivalent liquid should be measured under similar ambient conditions and within 2 °C of the conditions expected during the SAR evaluation to satisfy protocol requirements.

## 4.2. System Verification Procedure

The system verification is performed for verifying the accuracy of the complete measurement system and performance of the software. The dipole is connected to the signal source consisting of signal generator and amplifier via a directional coupler, N-connector cable and adaption to SMA. It is fed with a power of 100mW (below 5GHz) or 100mW (above 5GHz). To adjust this power a power meter is used. The power sensor is connected to the cable before the system verification to measure the power at this point and do adjustments at the signal generator. At the outputs of the directional coupler both return loss as well as forward power are controlled during the system verification to make sure that emitted power at the dipole is kept constant. This can also be checked by the power drift measurement after the test (result on plot).

The system verification is shown as below picture:

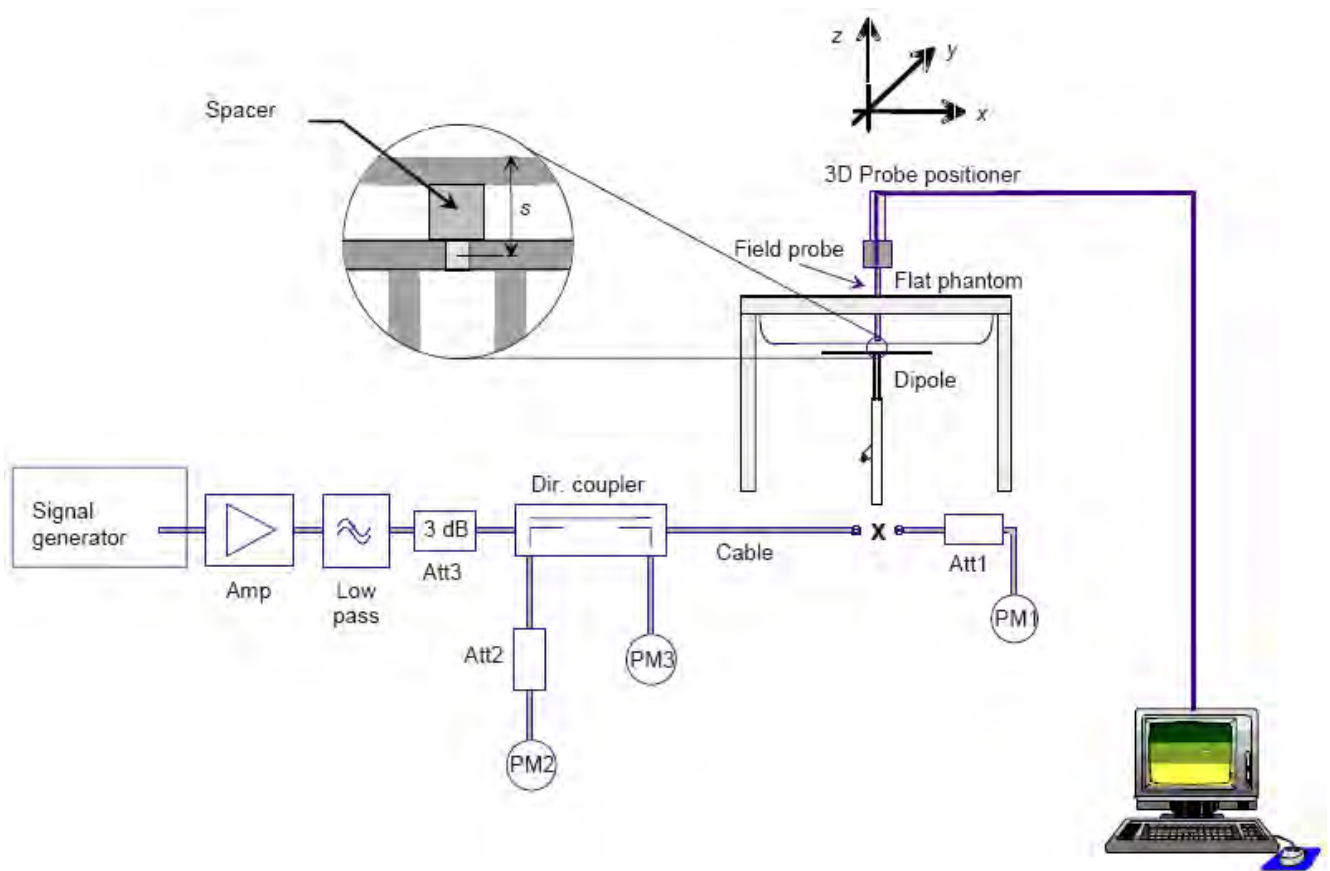

#### 4.2.1. System Verification Results

Comparing to the original SAR value provided by SATIMO, the verification data should be within its specification of  $\pm 10\%$ . Below table shows the target SAR and measured SAR after normalized to 1W input power. The table below indicates the system performance verification can meet the variation criterion and the plots can be referred to Appendix B of this report.

| System Verification | Target SAR (1W)<br>( $\pm 10\%$ ) |                        | Measured SAR<br>(Normalized to 1W) |             | Liquid Temp. | Test Date     |
|---------------------|-----------------------------------|------------------------|------------------------------------|-------------|--------------|---------------|
|                     | 1-g (W/Kg)                        | 10-g (W/Kg)            | 1-g (W/Kg)                         | 10-g (W/Kg) |              |               |
| 2450MHz             | 53.69<br>(48.33~59.05)            | 23.94<br>(21.55~26.33) | 51.84                              | 23.59       | 21.4 °C      | Nov. 27, 2024 |
| 5200MHz             | 162.59<br>(146.33~178.85)         | 56.21<br>(50.59~61.83) | 147.12                             | 52.12       | 21.3 °C      | Nov. 28, 2024 |
| 5800MHz             | 182.20<br>(163.98~200.42)         | 61.32<br>(55.19~67.45) | 164.21                             | 56.23       | 21.2 °C      | Nov. 29, 2024 |



## 5. SAR measurement variability

Per KDB865664 D01 SAR measurement 100 MHz to 6 GHz, SAR measurement variability must be assessed for each frequency band, which is determined by the SAR probe calibration point and tissue-equivalent medium used for the device measurements. The additional measurements are repeated after the completion of all measurements requiring the same head or body tissue-equivalent medium in a frequency band. The test device should be returned to ambient conditions (normal room temperature) with the battery fully charged before it is re-mounted on the device holder for the repeated measurement(s) to minimize any unexpected variations in the repeated results.

1) Repeated measurement is not required when the original highest measured SAR is  $< 0.80$  W/kg; steps 2) through 4) do not apply.

2) When the original highest measured SAR is  $\geq 0.80$  W/kg, repeat that measurement once.

3) Perform a second repeated measurement only if the ratio of largest to smallest SAR for the original and first repeated measurements is  $> 1.20$  or when the original or repeated measurement is  $\geq 1.45$  W/kg (~ 10% from the 1-g SAR limit).

4) Perform a third repeated measurement only if the original, first or second repeated measurement is  $\geq 1.5$  W/kg and the ratio of largest to smallest SAR for the original, first and second repeated measurements is  $> 1.20$ .

## **6. SAR Measurement Uncertainty**

Per KDB865664 D01 SAR Measurement 100 MHz to 6 GHz, when the highest measured 1-g SAR within a frequency band is  $< 1.5$  W/kg, the extensive SAR measurement uncertainty analysis described in IEEE Std 1528-2013 is not required in SAR reports submitted for equipment approval. The equivalent ratio (1.5/1.6) is applied to extremity and occupational exposure conditions.

## 7. RF Exposure Positions

### 7.1. Generic device

A typical example of a body supported device is a wireless enabled laptop device that among other orientations may be supported on the thighs of a sitting user. To represent this orientation, the device shall be positioned with its base against the flat phantom. Other orientations may be specified by the manufacturer in the user instructions. If the intended use is not specified, the device shall be tested directly against the flat phantom in all usable orientations.

The screen portion of the device shall be in an open position at a 90° angle as seen in Figure 7.1 (left side), or at an operating angle specified for intended use by the manufacturer in the operating instructions. Where a body supported device has an integral screen required for normal operation, then the screen-side will not need to be tested if the antenna(s) integrated in it ordinarily remain(s) 200 mm from the body. Where a screen mounted antenna is present, the measurement shall be performed with the screen against the flat phantom as shown in Figure 7.1) (right side), if operating the screen against the body is consistent with the intended use.

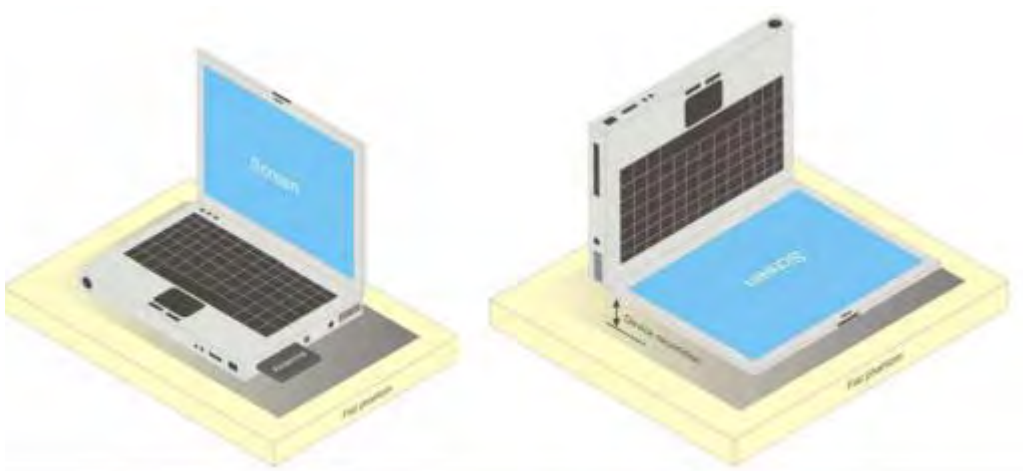

Figure 7.1 – Test positions for generic device

## 8. RF Output Power

### 8.1. Wi-Fi & BT Output Power

| Mode            | Channel | Frequency (MHz) | Output Power (dBm)ANT1 | Tune-Up | Output Power (dBm)ANT2 | Tune-Up | Output Power (dBm)MIMO | Tune-Up |
|-----------------|---------|-----------------|------------------------|---------|------------------------|---------|------------------------|---------|
| 802.11b         | 1       | 2412            | 16.92                  | 16±1    | 15.98                  | 15±1    | /                      | /       |
|                 | 6       | 2437            | 16.57                  | 16±1    | 16.50                  | 16±1    | /                      | /       |
|                 | 11      | 2462            | 16.93                  | 16±1    | 16.70                  | 16±1    | /                      | /       |
| 802.11g         | 1       | 2412            | 16.43                  | 16±1    | 14.95                  | 14±1    | /                      | /       |
|                 | 6       | 2437            | 16.95                  | 16±1    | 15.11                  | 15±1    | /                      | /       |
|                 | 11      | 2462            | 16.57                  | 16±1    | 14.97                  | 14±1    | /                      | /       |
| 802.11n (HT20)  | 1       | 2412            | 16.13                  | 16±1    | 14.39                  | 14±1    | 18.36                  | 18±1    |
|                 | 6       | 2437            | 15.86                  | 15±1    | 16.91                  | 16±1    | 19.43                  | 19±1    |
|                 | 11      | 2462            | 15.51                  | 15±1    | 16.55                  | 16±1    | 19.07                  | 19±1    |
| 802.11n (H40)   | 3       | 2422            | 15.37                  | 15±1    | 14.87                  | 14±1    | 18.14                  | 18±1    |
|                 | 6       | 2437            | 15.14                  | 15±1    | 14.84                  | 14±1    | 18.00                  | 18±1    |
|                 | 9       | 2452            | 14.87                  | 14±1    | 14.78                  | 14±1    | 17.84                  | 17±1    |
| 802.11ax (HT20) | 1       | 2412            | 16.25                  | 16±1    | 16.84                  | 16±1    | 19.57                  | 19±1    |
|                 | 6       | 2437            | 16.56                  | 16±1    | 17.10                  | 17±1    | 19.85                  | 19±1    |
|                 | 11      | 2462            | 15.86                  | 15±1    | 17.45                  | 17±1    | 19.74                  | 19±1    |
| 802.11ax (HT40) | 3       | 2422            | 15.75                  | 15±1    | 15.64                  | 15±1    | 18.71                  | 18±1    |
|                 | 6       | 2437            | 15.44                  | 15±1    | 15.50                  | 15±1    | 18.48                  | 18±1    |
|                 | 9       | 2452            | 15.43                  | 15±1    | 15.56                  | 15±1    | 18.51                  | 18±1    |

| Mode           | Frequency (MHz) | Output Power (dBm)ANT1 | Tune-Up | Output Power (dBm)ANT2 | Tune-Up | Output Power (dBm)MIMO | Tune-Up |
|----------------|-----------------|------------------------|---------|------------------------|---------|------------------------|---------|
| 802.11A        | 5180            | 12.66                  | 12±1    | 13.14                  | 13±1    | /                      | /       |
|                | 5200            | 12.58                  | 12±1    | 12.25                  | 12±1    | /                      | /       |
|                | 5240            | 11.95                  | 11±1    | 11.39                  | 11±1    | /                      | /       |
| 802.11N20SISO  | 5180            | 12.48                  | 12±1    | 12.40                  | 12±1    | 15.45                  | 15±1    |
|                | 5200            | 12.44                  | 12±1    | 12.21                  | 12±1    | 15.34                  | 15±1    |
|                | 5240            | 11.72                  | 11±1    | 11.25                  | 11±1    | 14.50                  | 14±1    |
| 802.11N40SISO  | 5190            | 12.35                  | 12±1    | 12.19                  | 12±1    | 15.28                  | 15±1    |
|                | 5230            | 11.95                  | 11±1    | 11.39                  | 11±1    | 14.69                  | 14±1    |
| 802.11AC20SISO | 5180            | 12.38                  | 12±1    | 12.36                  | 12±1    | 15.38                  | 15±1    |
|                | 5200            | 12.38                  | 12±1    | 12.31                  | 12±1    | 15.36                  | 15±1    |
|                | 5240            | 11.71                  | 11±1    | 11.40                  | 11±1    | 14.57                  | 14±1    |
| 802.11AC40SISO | 5190            | 12.41                  | 12±1    | 12.23                  | 12±1    | 15.33                  | 15±1    |
|                | 5230            | 11.93                  | 11±1    | 11.42                  | 11±1    | 14.69                  | 14±1    |
| 802.11AC80SISO | 5210            | 11.98                  | 11±1    | 11.64                  | 11±1    | 14.82                  | 14±1    |
| 802.11AX20SISO | 5180            | 11.25                  | 11±1    | 11.34                  | 11±1    | 14.31                  | 14±1    |
|                | 5200            | 10.99                  | 10±1    | 11.04                  | 11±1    | 14.03                  | 14±1    |
|                | 5240            | 11.47                  | 11±1    | 10.09                  | 10±1    | 13.84                  | 13±1    |
| 802.11AX40SISO | 5190            | 12.24                  | 12±1    | 11.02                  | 11±1    | 14.68                  | 14±1    |
|                | 5230            | 11.50                  | 11±1    | 10.31                  | 10±1    | 13.96                  | 13±1    |
| 802.11AX80SISO | 5210            | 11.82                  | 11±1    | 10.73                  | 10±1    | 14.32                  | 14±1    |

| Mode          | Frequency (MHz) | Output Power (dBm)ANT1 | Tune-Up | Output Power (dBm)ANT2 | Tune-Up | Output Power (dBm)MIMO | Tune-Up |
|---------------|-----------------|------------------------|---------|------------------------|---------|------------------------|---------|
| 802.11A       | 5745            | 11.82                  | 11±1    | 10.85                  | 10±1    | /                      | /       |
|               | 5785            | 12.46                  | 12±1    | 11.76                  | 11±1    | /                      | /       |
|               | 5825            | 11.92                  | 11±1    | 11.47                  | 11±1    | /                      | /       |
| 802.11N20SISO | 5745            | 11.78                  | 11±1    | 11.08                  | 11±1    | 14.45                  | 14±1    |
|               | 5785            | 12.41                  | 12±1    | 11.62                  | 11±1    | 15.04                  | 15±1    |
|               | 5825            | 11.97                  | 11±1    | 11.30                  | 11±1    | 14.66                  | 14±1    |

|                |      |       |      |       |      |       |      |
|----------------|------|-------|------|-------|------|-------|------|
| 802.11N40SISO  | 5755 | 11.86 | 11±1 | 11.05 | 11±1 | 14.48 | 14±1 |
|                | 5795 | 12.27 | 12±1 | 11.54 | 11±1 | 14.93 | 14±1 |
| 802.11AC20SISO | 5745 | 11.84 | 11±1 | 11.15 | 11±1 | 14.52 | 14±1 |
|                | 5785 | 12.41 | 12±1 | 11.67 | 11±1 | 15.07 | 15±1 |
|                | 5825 | 11.98 | 11±1 | 11.36 | 11±1 | 14.69 | 14±1 |
| 802.11AC40SISO | 5755 | 11.94 | 11±1 | 11.06 | 11±1 | 14.53 | 14±1 |
|                | 5795 | 12.30 | 12±1 | 11.51 | 11±1 | 14.93 | 14±1 |
| 802.11AC80SISO | 5775 | 11.53 | 11±1 | 10.73 | 10±1 | 14.16 | 14±1 |
| 802.11AX20SISO | 5745 | 11.87 | 11±1 | 11.08 | 11±1 | 14.50 | 14±1 |
|                | 5785 | 12.32 | 12±1 | 11.58 | 11±1 | 14.98 | 14±1 |
|                | 5825 | 11.93 | 11±1 | 11.32 | 11±1 | 14.65 | 14±1 |
| 802.11AX40SISO | 5755 | 11.79 | 11±1 | 10.97 | 10±1 | 14.41 | 14±1 |
|                | 5795 | 12.36 | 12±1 | 11.45 | 11±1 | 14.94 | 14±1 |
| 802.11AX80SISO | 5775 | 11.59 | 11±1 | 10.94 | 10±1 | 14.29 | 14±1 |

| Mode  | Channel | Output Power (dBm) | Tune-up |
|-------|---------|--------------------|---------|
| DH5   | Hop     | 3.81               | 3±1     |
| 2DH5  | Hop     | 6.22               | 6±1     |
| 3DH5  | Hop     | 6.80               | 6±1     |
| BLE1M | CH00    | 3.10               | 3±1     |
|       | CH19    | 4.34               | 4±1     |
|       | CH39    | 4.05               | 4±1     |

### 9. Stand-alone SAR test exclusion

Refer to FCC KDB 447498D01, the 1-g SAR and 10-g SAR test exclusion thresholds for 100 MHz to 6 GHz at test separation distances ≤ 50 mm are determined by:

$$[(\text{max. power of channel, including tune-up tolerance, mW}) / (\text{min. test separation distance, mm})] \cdot [\sqrt{f(\text{GHZ})}] \leq 3.0 \text{ for 1-g SAR and } \leq 7.5 \text{ for 10-g extremity SAR, where:}$$

- f(GHZ) is the RF channel transmit frequency in GHz
- Power and distance are rounded to the nearest mW and mm before calculation
- The result is rounded to one decimal place for comparison

When the minimum test separation distance is < 5 mm, a distance of 5 mm is applied to determine SAR test exclusion.

| Mode      | Pmax (dBm) | Pmax (mW) | Distance (mm) | f (GHz) | Calculation Result | SAR Exclusion threshold | SAR test exclusion |
|-----------|------------|-----------|---------------|---------|--------------------|-------------------------|--------------------|
| Bluetooth | 7.00       | 5.01      | 5             | 2.480   | 1.6                | 3                       | Yes                |

NOTE: Standalone SAR test exclusion for Bluetooth.

When standalone SAR test exclusion applies to an antenna that transmits simultaneously with other antennas, the standalone SAR must be estimated according to following to determine simultaneous transmission SAR test exclusion:

$$[(\text{max. power of channel, including tune-up tolerance, mW}) / (\text{min. test separation distance, mm})] \cdot [\sqrt{f(\text{GHZ})} / x] \text{ W/kg for test separation distances } \leq 50\text{mm, where } x = 7.5 \text{ for 1-g SAR and } x = 18.75 \text{ for}$$

10-g SAR.

When the minimum test separation distance is < 5 mm, a distance of 5 mm is applied to determine SAR test exclusion.

| Mode      | Position | Pmax (dBm) | Pmax (mW) | Distance (mm) | f (GHz) | x   | Estimated SAR (W/kg) |
|-----------|----------|------------|-----------|---------------|---------|-----|----------------------|
| Bluetooth | Body     | 7.00       | 5.01      | 5             | 2.48    | 7.5 | 0.210                |

NOTE: Estimated SAR calculation for Bluetooth

## 10. SAR Measurement Results

### < WIFI 2.4G >

| Test Position    | Test channel /Freq. | Test Mode       | Separation distance (mm) | SAR Value (W/kg) |       | Power Drift (±5%) | Conducted power (dBm) | Tune-up power (dBm) | Scaled SAR 1g (W/Kg) | Date       | Plot |
|------------------|---------------------|-----------------|--------------------------|------------------|-------|-------------------|-----------------------|---------------------|----------------------|------------|------|
|                  |                     |                 |                          | 1g               | 10g   |                   |                       |                     |                      |            |      |
| back of Keyboard |                     |                 |                          |                  |       |                   |                       |                     |                      |            |      |
| ANT1             | 11/2462             | 802.11b         | 0                        | 0.264            | 0.179 | -1.74             | 16.93                 | 17.00               | 0.268                | 2024/11/27 | 7#   |
| ANT1             | 6/2437              | 802.11g         | 0                        | 0.245            | 0.154 | 1.02              | 16.95                 | 17.00               | 0.248                | 2024/11/27 |      |
| ANT2             | 11/2462             | 802.11b         | 0                        | 0.262            | 0.179 | -3.85             | 16.70                 | 17.00               | 0.281                | 2024/11/27 | 8#   |
| ANT2             | 11/2462             | 802.11ax (HT20) | 0                        | 0.242            | 0.150 | 1.20              | 17.45                 | 18.00               | 0.275                | 2024/11/27 |      |
| MIMO             | 6/2437              | 802.11ax (HT20) | 0                        | 0.293            | 0.190 | -1.28             | 19.85                 | 20.00               | 0.303                | 2024/11/27 | 9#   |

### < WIFI 5.2G >

| Test Position    | Test channel /Freq. | Test Mode | Separation distance (mm) | SAR Value (W/kg) |       | Power Drift (±5%) | Conducted power (dBm) | Tune-up power (dBm) | Scaled SAR 1g (W/Kg) | Date       | Plot |
|------------------|---------------------|-----------|--------------------------|------------------|-------|-------------------|-----------------------|---------------------|----------------------|------------|------|
|                  |                     |           |                          | 1g               | 10g   |                   |                       |                     |                      |            |      |
| back of Keyboard |                     |           |                          |                  |       |                   |                       |                     |                      |            |      |
| ANT1             | 36/5180             | 802.11a   | 0                        | 0.508            | 0.396 | 3.36              | 12.66                 | 13.00               | 0.549                | 2024/11/28 | 1#   |
| ANT2             | 36/5180             | 802.11a   | 0                        | 0.641            | 0.493 | -1.68             | 13.14                 | 13.50               | 0.696                | 2024/11/28 | 2#   |
| MIMO             | 36/5180             | 802.11n20 | 0                        | 0.661            | 0.479 | -4.52             | 15.45                 | 16.00               | 0.750                | 2024/11/28 | 3#   |

### < WIFI 5.8G >

| Test Position    | Test channel /Freq. | Test Mode  | Separation distance (mm) | SAR Value (W/kg) |       | Power Drift (±5%) | Conducted power (dBm) | Tune-up power (dBm) | Scaled SAR 1g (W/Kg) | Date       | Plot |
|------------------|---------------------|------------|--------------------------|------------------|-------|-------------------|-----------------------|---------------------|----------------------|------------|------|
|                  |                     |            |                          | 1g               | 10g   |                   |                       |                     |                      |            |      |
| back of Keyboard |                     |            |                          |                  |       |                   |                       |                     |                      |            |      |
| ANT1             | 157/5785            | 802.11a    | 0                        | 0.527            | 0.429 | 1.15              | 12.46                 | 13.00               | 0.597                | 2024/11/29 | 4#   |
| ANT2             | 157/5785            | 802.11a    | 0                        | 0.491            | 0.410 | -2.31             | 11.76                 | 12.00               | 0.519                | 2024/11/29 | 5#   |
| MIMO             | 157/5785            | 802.11ac20 | 0                        | 0.566            | 0.435 | 0.00              | 15.07                 | 16.00               | 0.701                | 2024/11/29 | 6#   |

## 11. Simultaneous Transmission Analysis

Per KDB 447498 D01, simultaneous transmission SAR is compliant if,

1) Scalar SAR summation < 1.6W/kg.

2) SPLSR =  $(SAR_1 + SAR_2)^{1.5} / (min. \text{ separation distance, mm})$ , and the peak separation distance is

determined from the square root of  $[(x_1 - x_2)^2 + (y_1 - y_2)^2 + (z_1 - z_2)^2]$ , where

$(x_1, y_1, z_1)$  and  $(x_2, y_2, z_2)$  are the coordinates of the extrapolated peak SAR locations in the zoom scan.

If SPLSR  $\leq$  0.04, simultaneously transmission SAR measurement is not necessary.

| Exposure Position |                  | ANT1      | ANT2      | Simultaneous Tx SAR(W/Kg) |
|-------------------|------------------|-----------|-----------|---------------------------|
|                   |                  | SAR(W/Kg) | SAR(W/Kg) |                           |
| Body              | back of Keyboard | 0.597     | 0.696     | 0.750                     |

Note : The Simultaneous Tx is calculated based on the same configuration and test position.



## **Appendix A. Photo documentation**

Refer to appendix Test Setup photo---SAR

## Appendix B. System Check Plots

| Table of contents                                       |
|---|
| <b>MEASUREMENT 1 System Performance Check - 2450MHz</b> |
| <b>MEASUREMENT 2 System Performance Check - 5200MHz</b> |
| <b>MEASUREMENT 3 System Performance Check - 5800MHz</b> |

# MEASUREMENT 1

Date of measurement: 27/11/2024

## A. Experimental conditions.

|                        |                                    |
|------------------------|------------------------------------|
| <b>Area Scan</b>       | <u>dx=12mm dy=12mm, h= 5.00 mm</u> |
| <b>ZoomScan</b>        | <u>7x7x7,dx=5mm dy=5mm dz=5mm</u>  |
| <b>Phantom</b>         | <u>Validation plane</u>            |
| <b>Device Position</b> | <u>Dipole</u>                      |
| <b>Band</b>            | <u>CW2450</u>                      |
| <b>Channels</b>        | <u>Middle</u>                      |
| <b>Signal</b>          | <u>CW (Crest factor: 1.0)</u>      |
| <b>ConvF</b>           | <u>2.38</u>                        |

## B. SAR Measurement Results

|   |             |
|---|-------------|
| <b>Frequency (MHz)</b>                        | 2450.000000 |
| <b>Relative permittivity (real part)</b>      | 40.408511   |
| <b>Relative permittivity (imaginary part)</b> | 13.399264   |
| <b>Conductivity (S/m)</b>                     | 1.823789    |
| <b>Variation (%)</b>                          | -1.250000   |

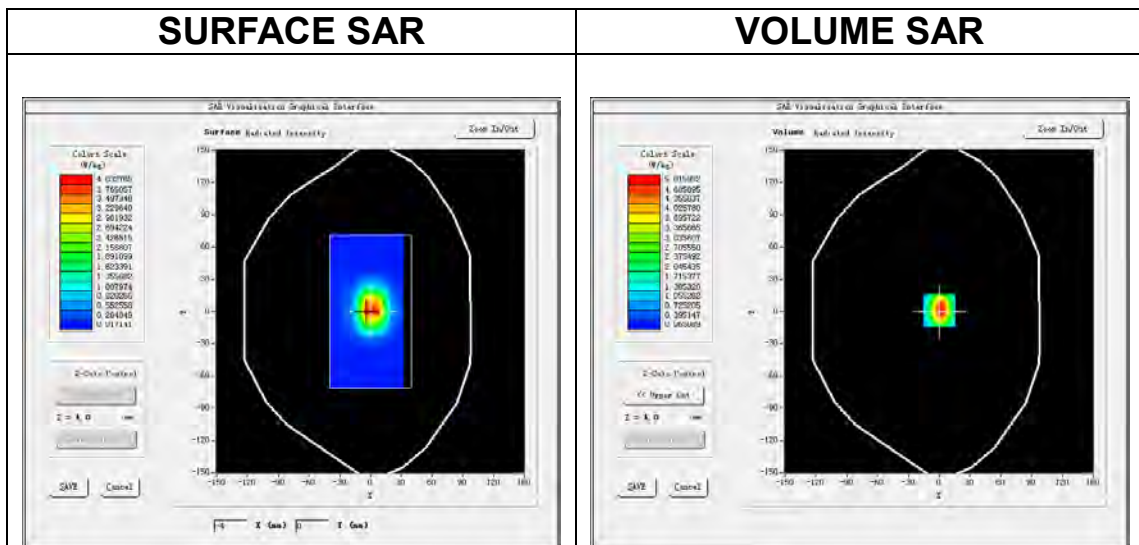

**Maximum location: X=0.00, Y=1.00**  
**SAR Peak: 8.14 W/kg**

|                       |          |
|-----------------------|----------|
| <b>SAR 10g (W/Kg)</b> | 2.359425 |
| <b>SAR 1g (W/Kg)</b>  | 5.183642 |

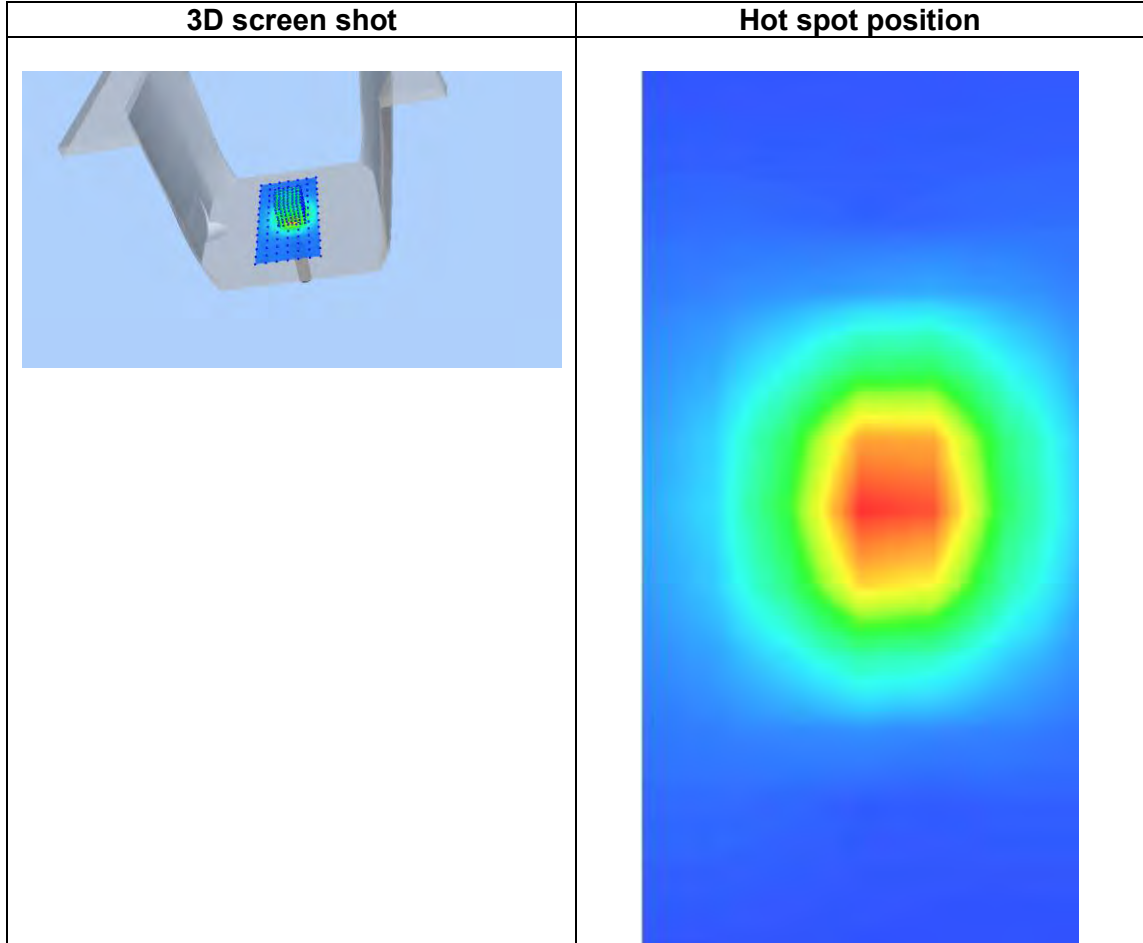

# MEASUREMENT 2

Date of measurement: 28/11/2024

## A. Experimental conditions.

|                        |                                    |
|------------------------|------------------------------------|
| <b>Area Scan</b>       | <u>dx=10mm dy=10mm, h= 2.00 mm</u> |
| <b>ZoomScan</b>        | <u>7x7x12,dx=4mm dy=4mm dz=2mm</u> |
| <b>Phantom</b>         | <u>Validation plane</u>            |
| <b>Device Position</b> | <u>Dipole</u>                      |
| <b>Band</b>            | <u>CW5200</u>                      |
| <b>Channels</b>        | <u>Middle</u>                      |
| <b>Signal</b>          | <u>CW (Crest factor: 1.0)</u>      |
| <b>ConvF</b>           | <u>2.30</u>                        |

## B. SAR Measurement Results

|   |             |
|---|-------------|
| <b>Frequency (MHz)</b>                        | 5200.000000 |
| <b>Relative permittivity (real part)</b>      | 37.400000   |
| <b>Relative permittivity (imaginary part)</b> | 16.129999   |
| <b>Conductivity (S/m)</b>                     | 4.659777    |
| <b>Variation (%)</b>                          | -4.570000   |

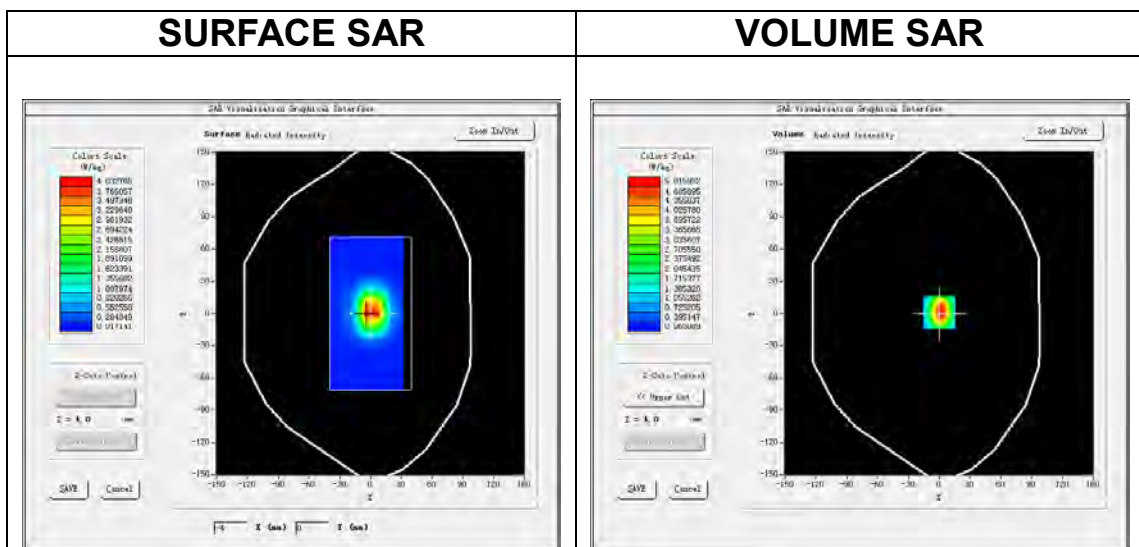

**Maximum location: X=0.00, Y=1.00**

**SAR Peak: 15.14 W/kg**

|                       |           |
|-----------------------|-----------|
| <b>SAR 10g (W/Kg)</b> | 5.212361  |
| <b>SAR 1g (W/Kg)</b>  | 14.712032 |

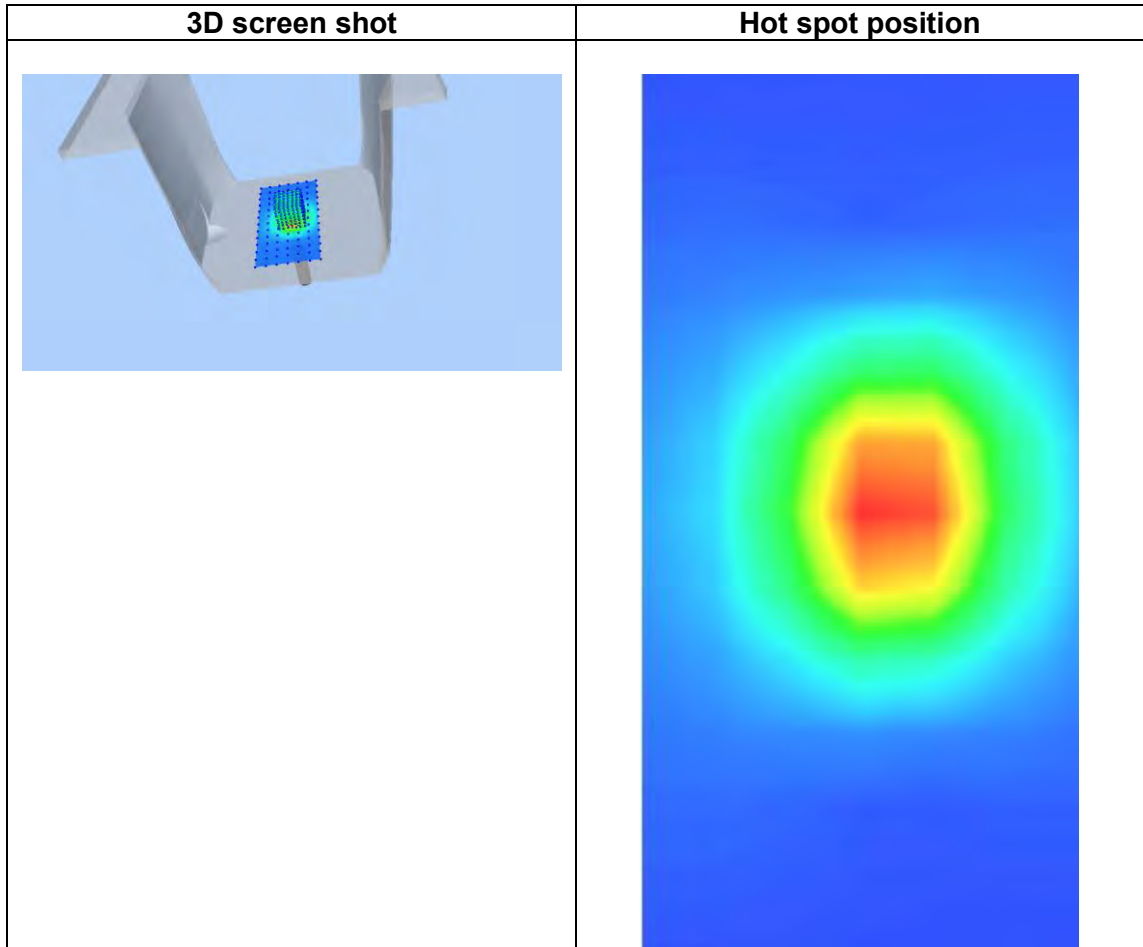

# MEASUREMENT 3

Date of measurement: 29/11/2024

## A. Experimental conditions.

|                        |                                    |
|------------------------|------------------------------------|
| <b>Area Scan</b>       | <u>dx=10mm dy=10mm, h= 2.00 mm</u> |
| <b>ZoomScan</b>        | <u>7x7x12,dx=4mm dy=4mm dz=2mm</u> |
| <b>Phantom</b>         | <u>Validation plane</u>            |
| <b>Device Position</b> | <u>Dipole</u>                      |
| <b>Band</b>            | <u>CW5800</u>                      |
| <b>Channels</b>        | <u>Middle</u>                      |
| <b>Signal</b>          | <u>CW (Crest factor: 1.0)</u>      |
| <b>ConvF</b>           | <u>2.27</u>                        |

## B. SAR Measurement Results

|   |            |
|---|------------|
| <b>Frequency (MHz)</b>                        | 5800.00000 |
| <b>Relative permittivity (real part)</b>      | 35.299999  |
| <b>Relative permittivity (imaginary part)</b> | 16.360001  |
| <b>Conductivity (S/m)</b>                     | 5.271556   |
| <b>Variation (%)</b>                          | -2.480000  |

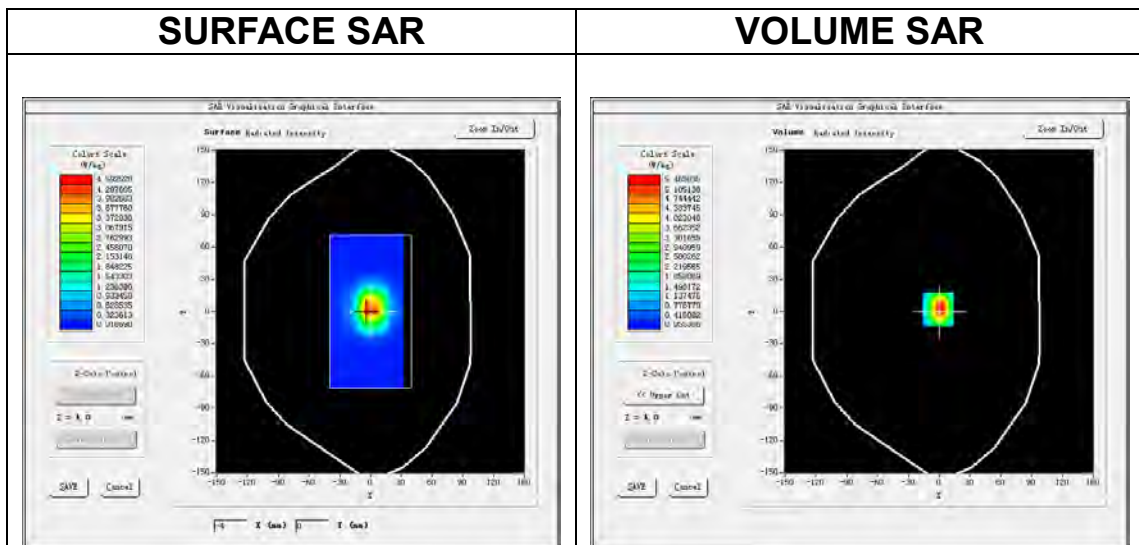

**Maximum location: X=-1.00, Y=2.00**  
**SAR Peak: 17.07 W/kg**

|                       |           |
|-----------------------|-----------|
| <b>SAR 10g (W/Kg)</b> | 5.623106  |
| <b>SAR 1g (W/Kg)</b>  | 16.421035 |

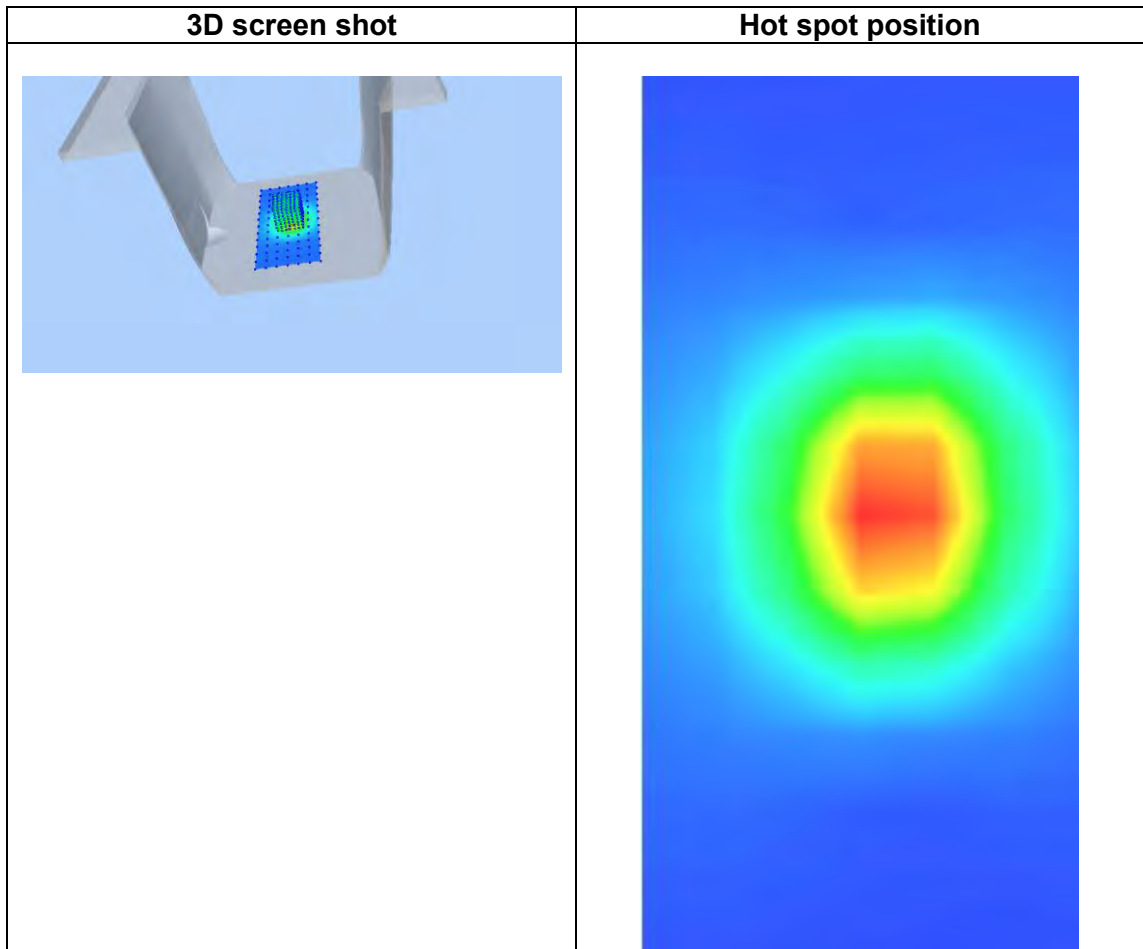



## Appendix C. SAR Test Plots

| Table of contents                 |
|-----------------------------------|
| MEASUREMENT 1 WLAN 5.2G Body ANT1 |
| MEASUREMENT 2 WLAN 5.2G Body ANT2 |
| MEASUREMENT 3 WLAN 5.2G Body MIMO |
| MEASUREMENT 4 WLAN 5.8G Body ANT1 |
| MEASUREMENT 5 WLAN 5.8G Body ANT2 |
| MEASUREMENT 6 WLAN 5.8G Body MIMO |
| MEASUREMENT 7 WLAN 2.4G Body ANT1 |
| MEASUREMENT 8 WLAN 2.4G Body ANT2 |
| MEASUREMENT 9 WLAN 2.4G Body MIMO |

# MEASUREMENT 1

Date of measurement: 28/11/2024

## A. Experimental conditions.

|                               |                                      |
|-------------------------------|--------------------------------------|
| <b><u>Area Scan</u></b>       | <u>dx=10mm dy=10mm, h= 2.00 mm</u>   |
| <b><u>ZoomScan</u></b>        | <u>7x7x12,dx=4mm dy=4mm dz=2mm</u>   |
| <b><u>Phantom</u></b>         | <u>Validation plane</u>              |
| <b><u>Device Position</u></b> | <u>Body</u>                          |
| <b><u>Band</u></b>            | <u>IEEE 802.11a U-NII</u>            |
| <b><u>Channels</u></b>        | <u>Low</u>                           |
| <b><u>Signal</u></b>          | <u>IEEE802.a (Crest factor: 1.0)</u> |
| <b><u>ConvF</u></b>           | <u>2.30</u>                          |

## B. SAR Measurement Results

|   |             |
|---|-------------|
| <b>Frequency (MHz)</b>                        | 5180.000000 |
| <b>Relative permittivity (real part)</b>      | 36.000000   |
| <b>Relative permittivity (imaginary part)</b> | 16.129912   |
| <b>Conductivity (S/m)</b>                     | 4.641830    |
| <b>Variation (%)</b>                          | 3.360001    |

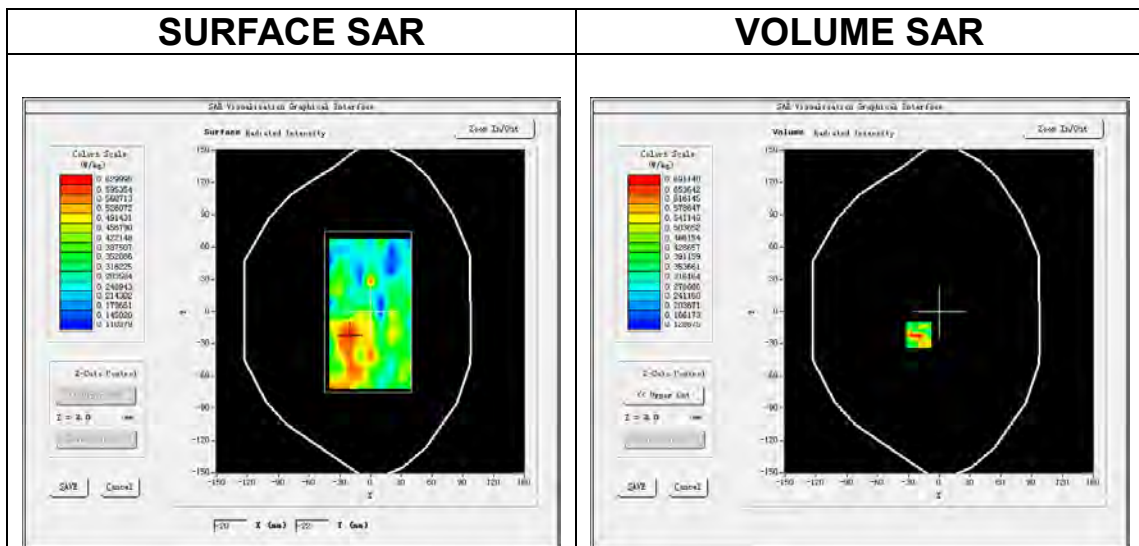

**Maximum location: X=-20.00, Y=-22.00**  
**SAR Peak: 1.20 W/kg**

|                       |          |
|-----------------------|----------|
| <b>SAR 10g (W/Kg)</b> | 0.395775 |
| <b>SAR 1g (W/Kg)</b>  | 0.507993 |

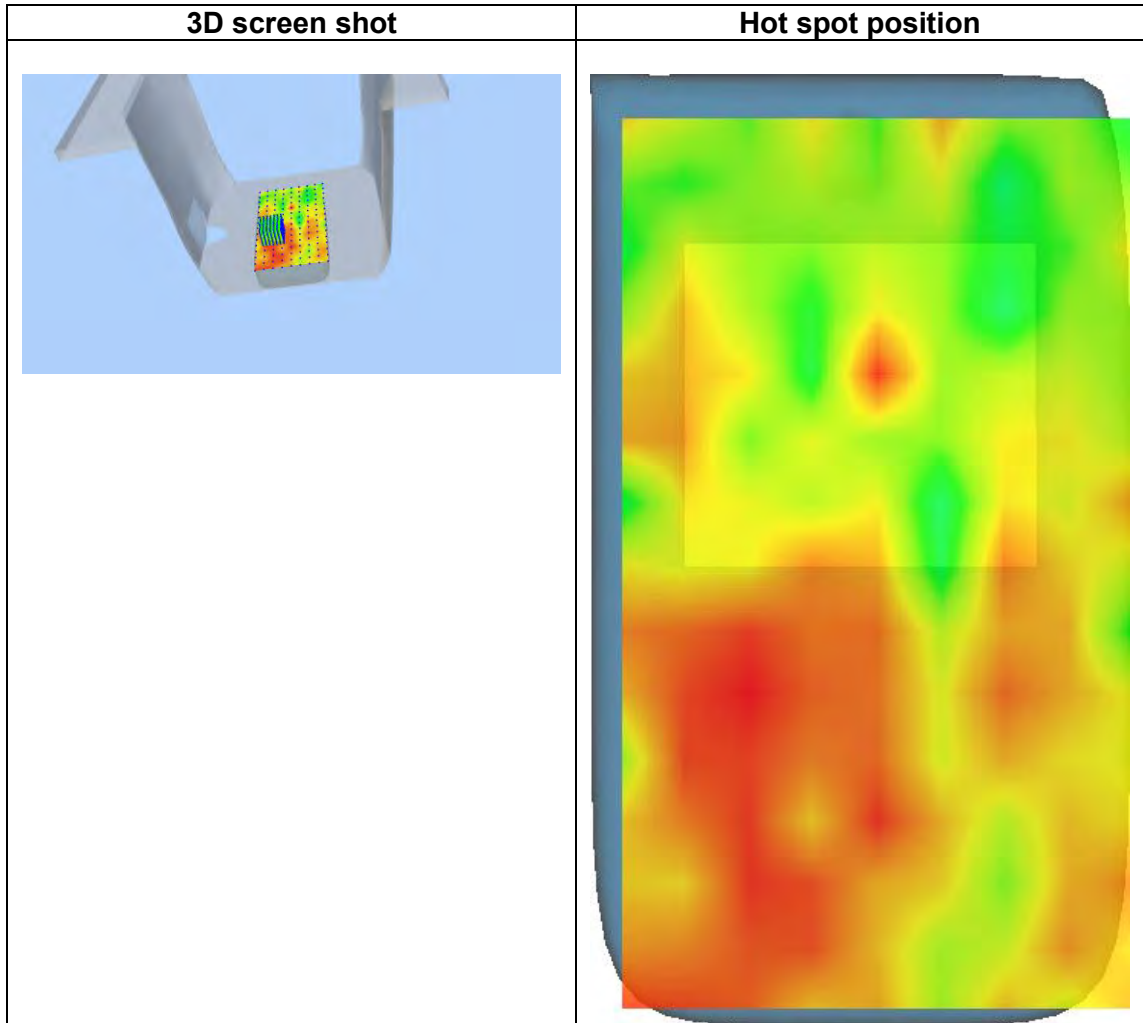

# MEASUREMENT 2

Date of measurement: 28/11/2024

## A. Experimental conditions.

|                        |                                      |
|------------------------|--------------------------------------|
| <b>Area Scan</b>       | <u>dx=10mm dy=10mm, h= 2.00 mm</u>   |
| <b>ZoomScan</b>        | <u>7x7x12,dx=4mm dy=4mm dz=2mm</u>   |
| <b>Phantom</b>         | <u>Validation plane</u>              |
| <b>Device Position</b> | <u>Body</u>                          |
| <b>Band</b>            | <u>IEEE 802.11a U-NII</u>            |
| <b>Channels</b>        | <u>Low</u>                           |
| <b>Signal</b>          | <u>IEEE802.a (Crest factor: 1.0)</u> |
| <b>ConvF</b>           | <u>2.30</u>                          |

## B. SAR Measurement Results

|   |             |
|---|-------------|
| <b>Frequency (MHz)</b>                        | 5180.000000 |
| <b>Relative permittivity (real part)</b>      | 36.000000   |
| <b>Relative permittivity (imaginary part)</b> | 16.129912   |
| <b>Conductivity (S/m)</b>                     | 4.641830    |
| <b>Variation (%)</b>                          | -1.680000   |

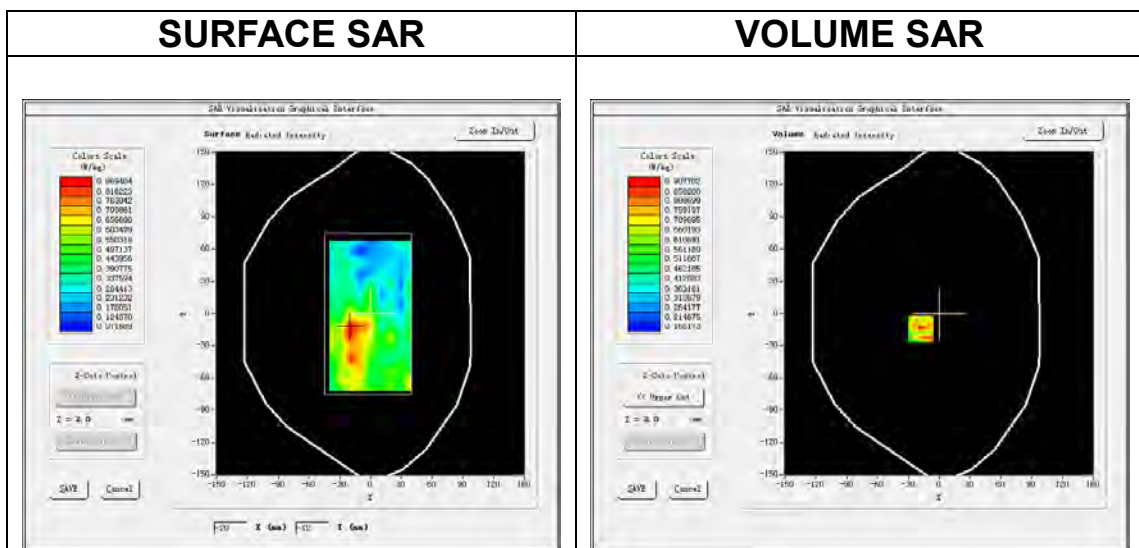

**Maximum location: X=-18.00, Y=-14.00**  
**SAR Peak: 1.35 W/kg**

|                       |          |
|-----------------------|----------|
| <b>SAR 10g (W/Kg)</b> | 0.492895 |
| <b>SAR 1g (W/Kg)</b>  | 0.640702 |

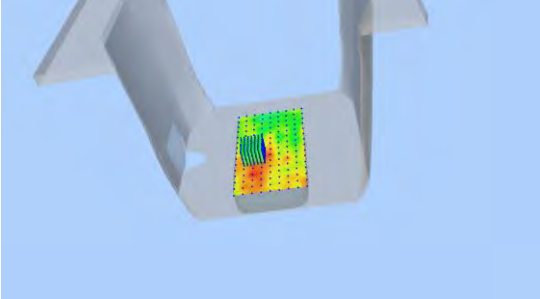
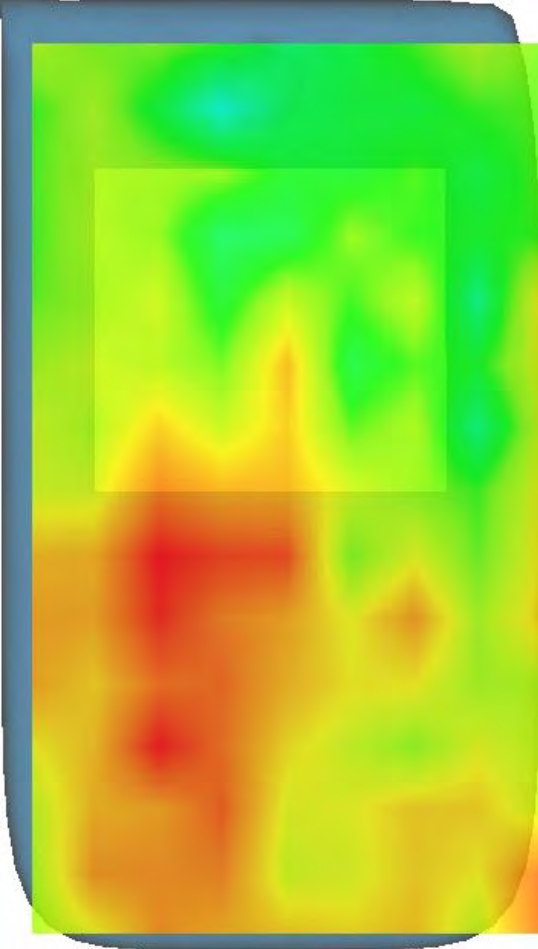
| 3D screen shot  | Hot spot position   |
|---|---|
|  |  |

# MEASUREMENT 3

Date of measurement: 28/11/2024

## A. Experimental conditions.

|                        |                                      |
|------------------------|--------------------------------------|
| <b>Area Scan</b>       | <u>dx=10mm dy=10mm, h= 2.00 mm</u>   |
| <b>ZoomScan</b>        | <u>7x7x12,dx=4mm dy=4mm dz=2mm</u>   |
| <b>Phantom</b>         | <u>Validation plane</u>              |
| <b>Device Position</b> | <u>Body</u>                          |
| <b>Band</b>            | <u>IEEE 802.11n U-NII</u>            |
| <b>Channels</b>        | <u>Low</u>                           |
| <b>Signal</b>          | <u>IEEE802.n (Crest factor: 1.0)</u> |
| <b>ConvF</b>           | <u>2.30</u>                          |

## B. SAR Measurement Results

|   |             |
|---|-------------|
| <b>Frequency (MHz)</b>                        | 5180.000000 |
| <b>Relative permittivity (real part)</b>      | 36.000000   |
| <b>Relative permittivity (imaginary part)</b> | 16.129912   |
| <b>Conductivity (S/m)</b>                     | 4.641830    |
| <b>Variation (%)</b>                          | -4.520000   |

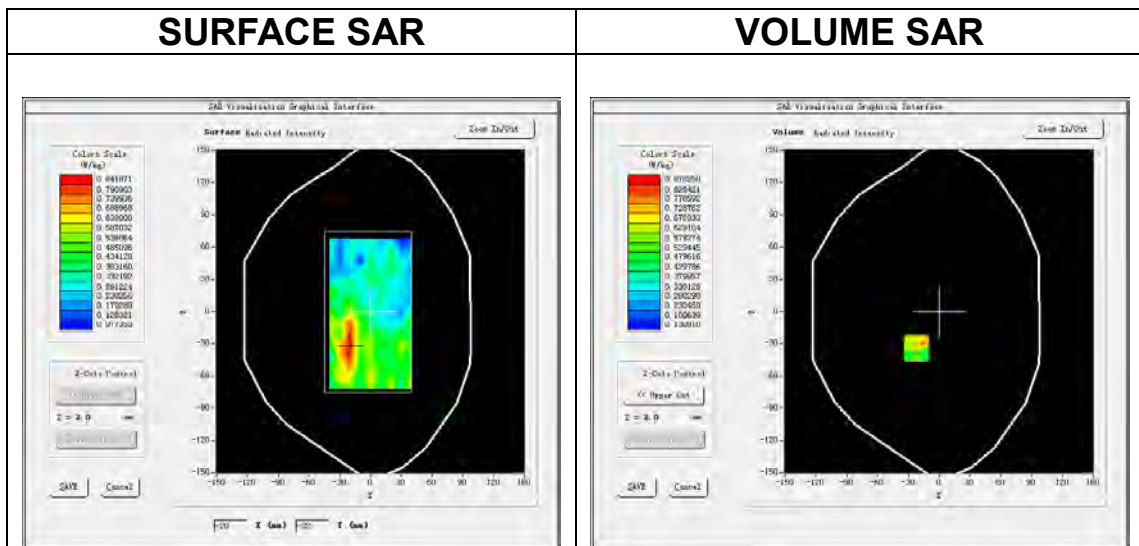

**Maximum location: X=-22.00, Y=-34.00**  
**SAR Peak: 1.38 W/kg**

|                       |          |
|-----------------------|----------|
| <b>SAR 10g (W/Kg)</b> | 0.478891 |
| <b>SAR 1g (W/Kg)</b>  | 0.661473 |

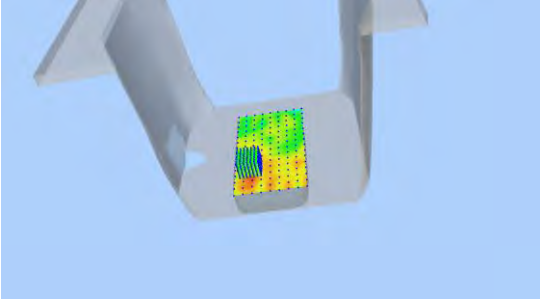
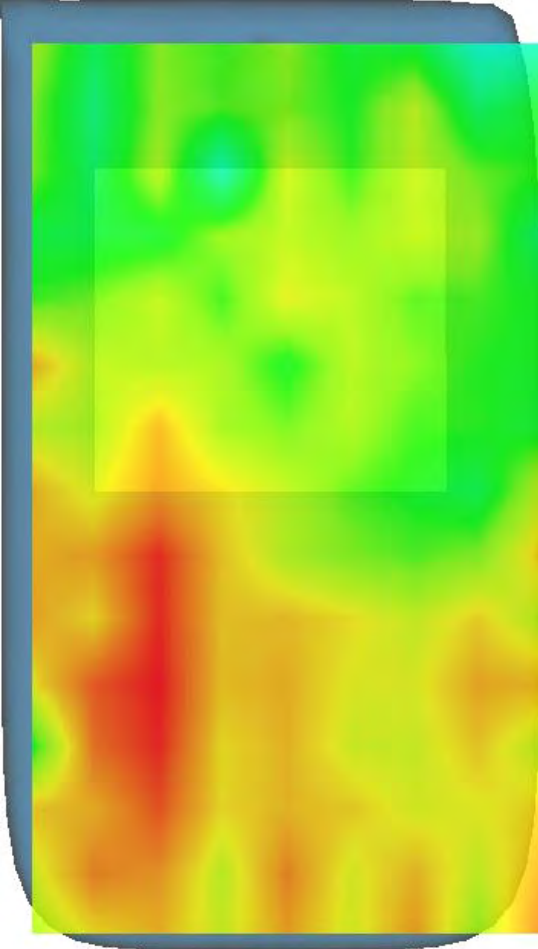
| 3D screen shot  | Hot spot position   |
|---|---|
|  |  |

# MEASUREMENT 4

Date of measurement: 29/11/2024

## A. Experimental conditions.

|                               |                                      |
|-------------------------------|--------------------------------------|
| <b><u>Area Scan</u></b>       | <u>dx=10mm dy=10mm, h= 2.00 mm</u>   |
| <b><u>ZoomScan</u></b>        | <u>7x7x12,dx=4mm dy=4mm dz=2mm</u>   |
| <b><u>Phantom</u></b>         | <u>Validation plane</u>              |
| <b><u>Device Position</u></b> | <u>Body</u>                          |
| <b><u>Band</u></b>            | <u>IEEE 802.11a U-NII</u>            |
| <b><u>Channels</u></b>        | <u>Middle</u>                        |
| <b><u>Signal</u></b>          | <u>IEEE802.a (Crest factor: 1.0)</u> |
| <b><u>ConvF</u></b>           | <u>2.27</u>                          |

## B. SAR Measurement Results

|   |             |
|---|-------------|
| <b>Frequency (MHz)</b>                        | 5785.000000 |
| <b>Relative permittivity (real part)</b>      | 35.314999   |
| <b>Relative permittivity (imaginary part)</b> | 16.355499   |
| <b>Conductivity (S/m)</b>                     | 5.256476    |
| <b>Variation (%)</b>                          | 1.150000    |

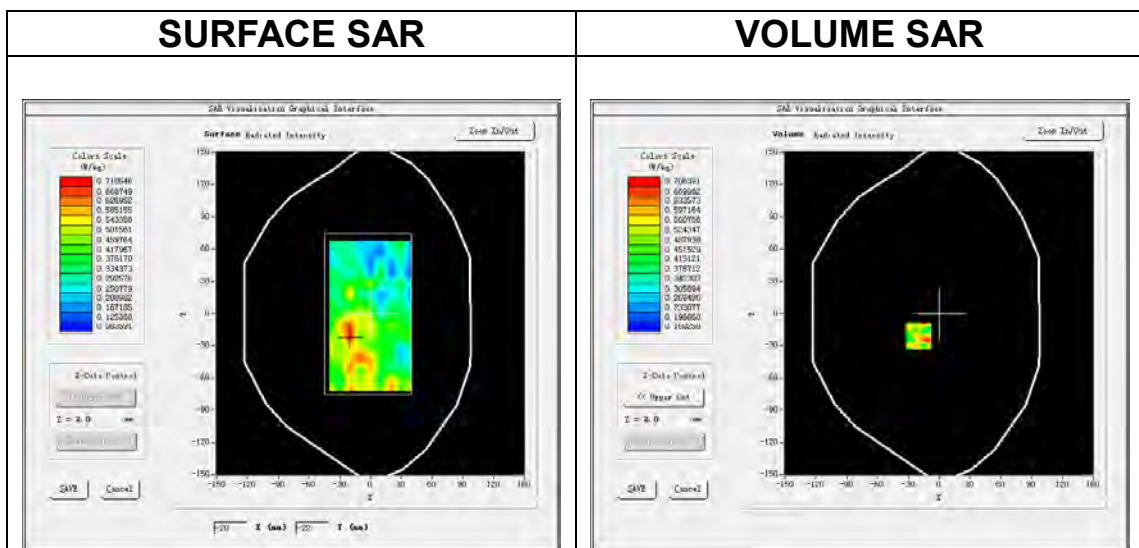

**Maximum location: X=-20.00, Y=-21.00**  
**SAR Peak: 1.25 W/kg**

|                       |          |
|-----------------------|----------|
| <b>SAR 10g (W/Kg)</b> | 0.428944 |
| <b>SAR 1g (W/Kg)</b>  | 0.526769 |

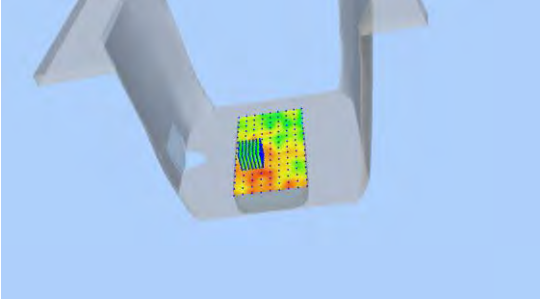
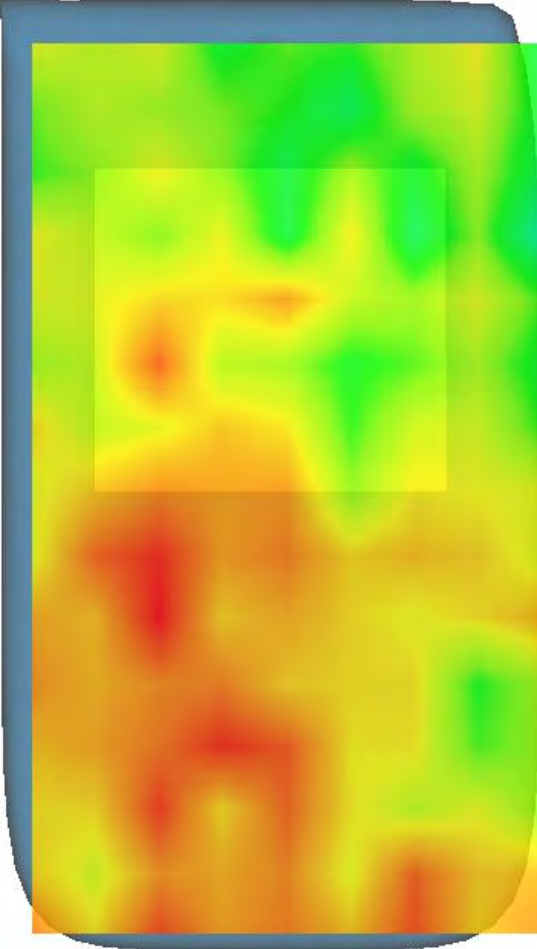

| 3D screen shot  | Hot spot position   |
|---|---|
|  |  |

# MEASUREMENT 5

Date of measurement: 29/11/2024

## A. Experimental conditions.

|                        |                                      |
|------------------------|--------------------------------------|
| <b>Area Scan</b>       | <u>dx=10mm dy=10mm, h= 2.00 mm</u>   |
| <b>ZoomScan</b>        | <u>7x7x12,dx=4mm dy=4mm dz=2mm</u>   |
| <b>Phantom</b>         | <u>Validation plane</u>              |
| <b>Device Position</b> | <u>Body</u>                          |
| <b>Band</b>            | <u>IEEE 802.11a U-NII</u>            |
| <b>Channels</b>        | <u>Middle</u>                        |
| <b>Signal</b>          | <u>IEEE802.a (Crest factor: 1.0)</u> |
| <b>ConvF</b>           | <u>2.27</u>                          |

## B. SAR Measurement Results

|   |             |
|---|-------------|
| <b>Frequency (MHz)</b>                        | 5785.000000 |
| <b>Relative permittivity (real part)</b>      | 35.314999   |
| <b>Relative permittivity (imaginary part)</b> | 16.355499   |
| <b>Conductivity (S/m)</b>                     | 5.256476    |
| <b>Variation (%)</b>                          | -2.310000   |

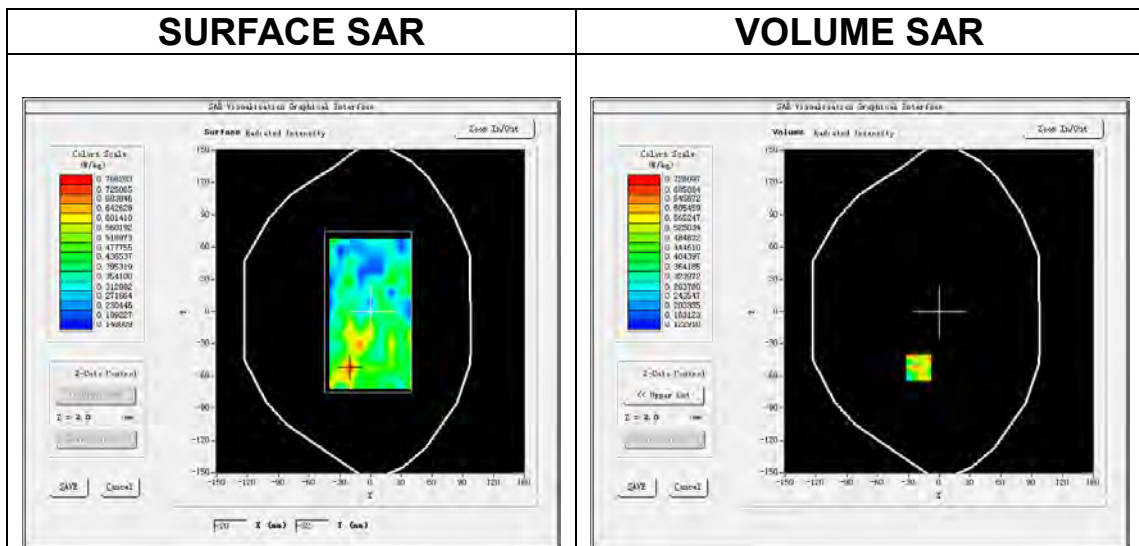

**Maximum location: X=-20.00, Y=-52.00**  
**SAR Peak: 1.19 W/kg**

|                       |          |
|-----------------------|----------|
| <b>SAR 10g (W/Kg)</b> | 0.410335 |
| <b>SAR 1g (W/Kg)</b>  | 0.491157 |

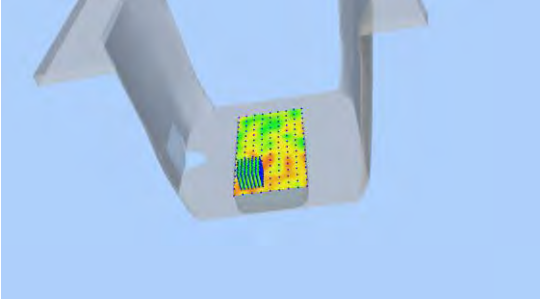
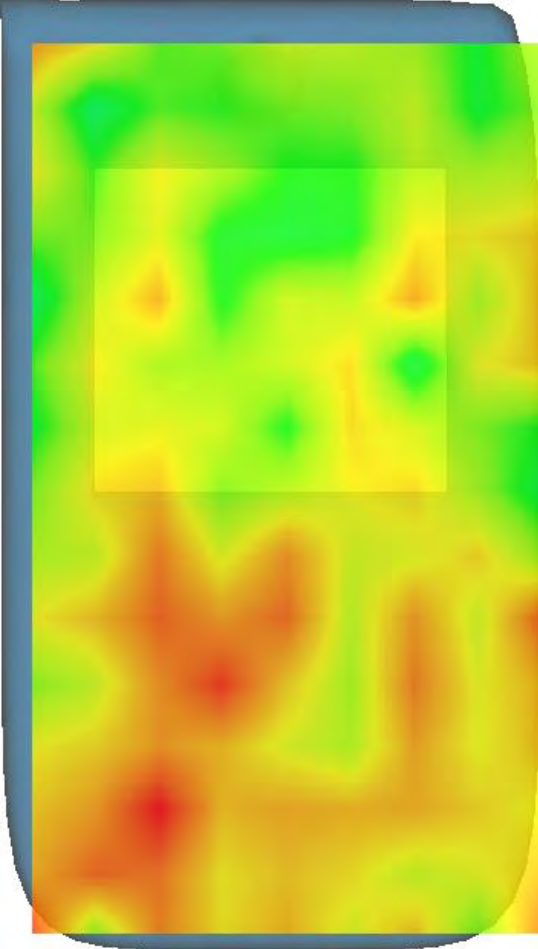
| 3D screen shot  | Hot spot position   |
|---|---|
|  |  |

# MEASUREMENT 6

Date of measurement: 29/11/2024

## A. Experimental conditions.

|                        |                                       |
|------------------------|---------------------------------------|
| <b>Area Scan</b>       | <u>dx=10mm dy=10mm, h= 2.00 mm</u>    |
| <b>ZoomScan</b>        | <u>7x7x12,dx=4mm dy=4mm dz=2mm</u>    |
| <b>Phantom</b>         | <u>Validation plane</u>               |
| <b>Device Position</b> | <u>Body</u>                           |
| <b>Band</b>            | <u>IEEE 802.11ac U-NII</u>            |
| <b>Channels</b>        | <u>Middle</u>                         |
| <b>Signal</b>          | <u>IEEE802.ac (Crest factor: 1.0)</u> |
| <b>ConvF</b>           | <u>2.27</u>                           |

## B. SAR Measurement Results

|   |             |
|---|-------------|
| <b>Frequency (MHz)</b>                        | 5785.000000 |
| <b>Relative permittivity (real part)</b>      | 35.314999   |
| <b>Relative permittivity (imaginary part)</b> | 16.355499   |
| <b>Conductivity (S/m)</b>                     | 5.256476    |
| <b>Variation (%)</b>                          | 0.000000    |

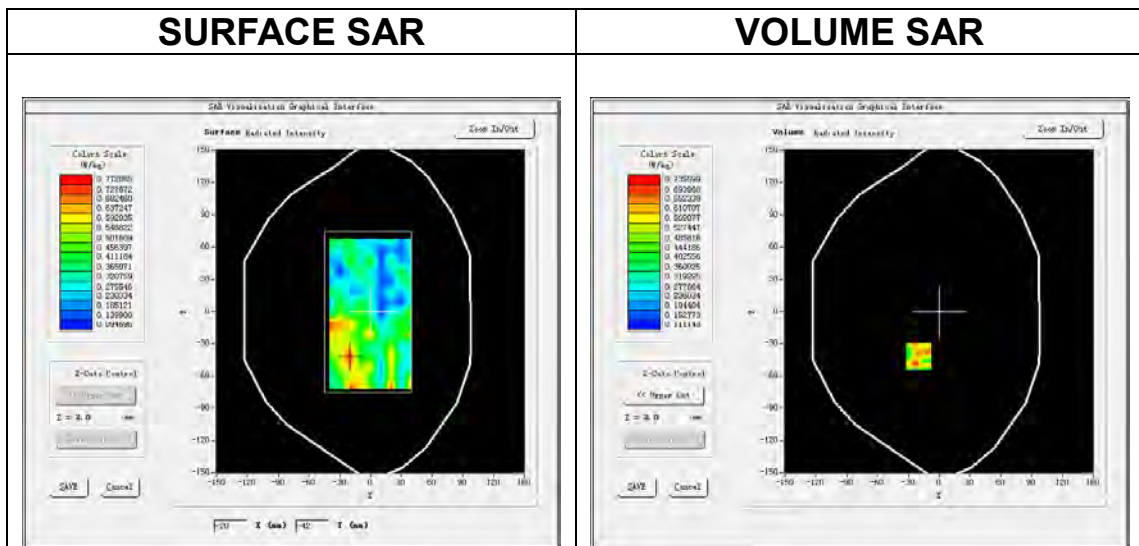

**Maximum location: X=-20.00, Y=-42.00**  
**SAR Peak: 1.51 W/kg**

|                       |          |
|-----------------------|----------|
| <b>SAR 10g (W/Kg)</b> | 0.435027 |
| <b>SAR 1g (W/Kg)</b>  | 0.565708 |

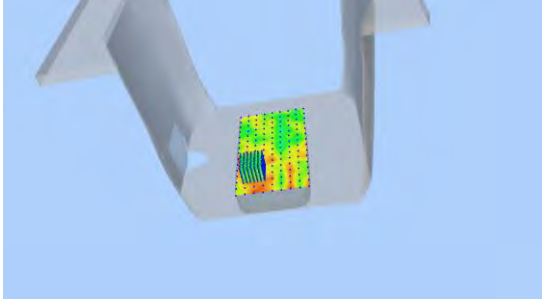
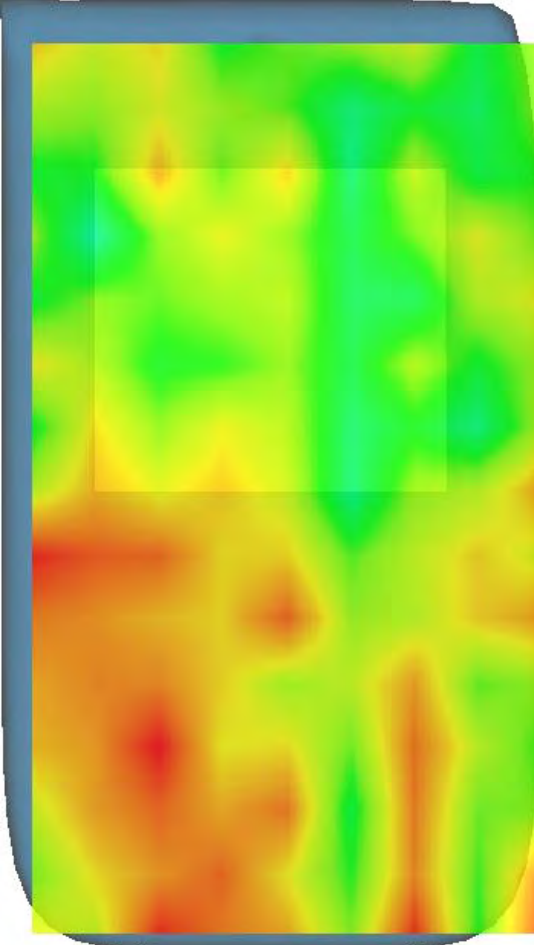
| 3D screen shot  | Hot spot position   |
|---|---|
|  |  |

# MEASUREMENT 7

Date of measurement: 27/11/2024

## A. Experimental conditions.

|                        |                                      |
|------------------------|--------------------------------------|
| <b>Area Scan</b>       | <u>dx=12mm dy=12mm, h= 5.00 mm</u>   |
| <b>ZoomScan</b>        | <u>7x7x7, dx=5mm dy=5mm dz=5mm</u>   |
| <b>Phantom</b>         | <u>Validation plane</u>              |
| <b>Device Position</b> | <u>Body</u>                          |
| <b>Band</b>            | <u>IEEE 802.11b ISM</u>              |
| <b>Channels</b>        | <u>High</u>                          |
| <b>Signal</b>          | <u>IEEE802.b (Crest factor: 1.0)</u> |
| <b>ConvF</b>           | <u>2.38</u>                          |

## B. SAR Measurement Results

|   |             |
|---|-------------|
| <b>Frequency (MHz)</b>                        | 2462.000000 |
| <b>Relative permittivity (real part)</b>      | 39.227045   |
| <b>Relative permittivity (imaginary part)</b> | 13.207032   |
| <b>Conductivity (S/m)</b>                     | 1.806428    |
| <b>Variation (%)</b>                          | -1.740000   |

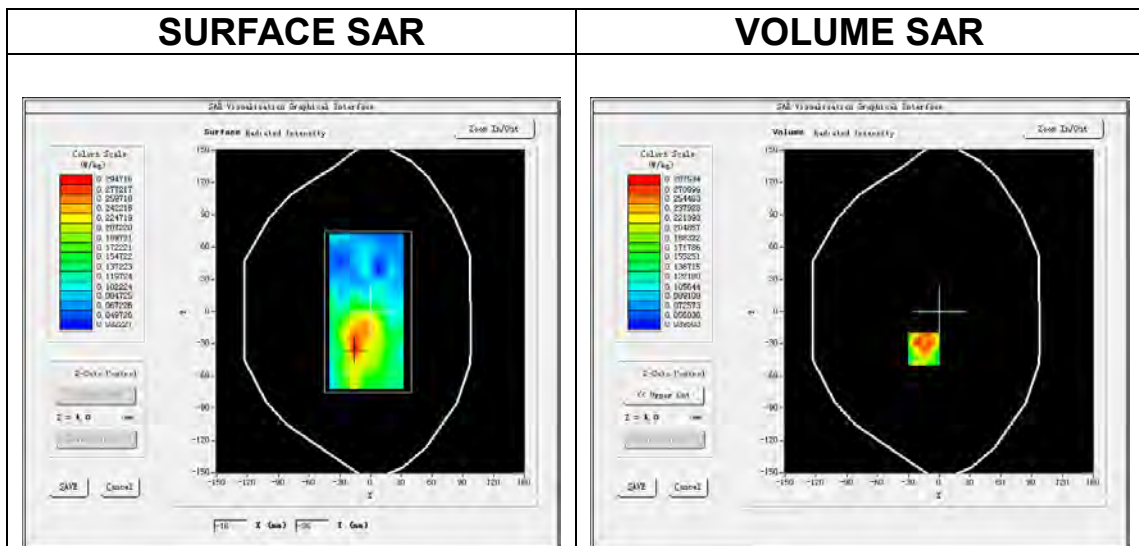

**Maximum location: X=-15.00, Y=-35.00**  
**SAR Peak: 0.47 W/kg**

|                       |          |
|-----------------------|----------|
| <b>SAR 10g (W/Kg)</b> | 0.178790 |
| <b>SAR 1g (W/Kg)</b>  | 0.264242 |

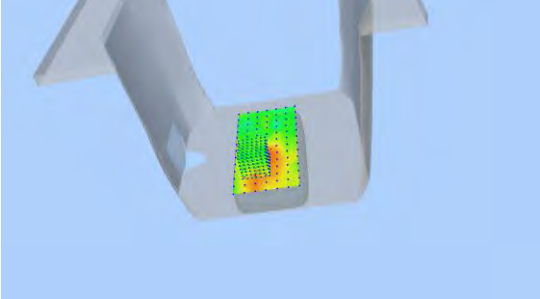
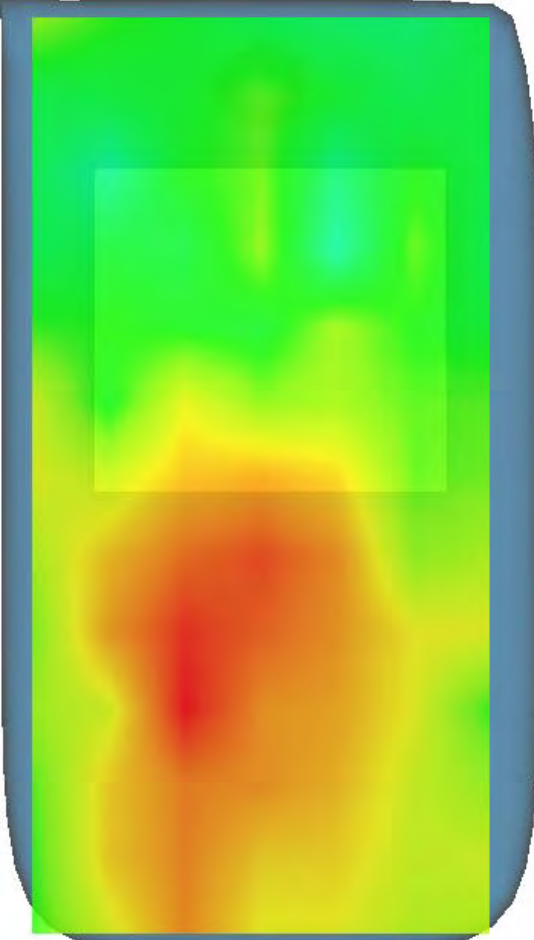
| 3D screen shot  | Hot spot position   |
|---|---|
|  |  |



# MEASUREMENT 8

Date of measurement: 27/11/2024

## A. Experimental conditions.

|                               |                                      |
|-------------------------------|--------------------------------------|
| <b><u>Area Scan</u></b>       | <u>dx=12mm dy=12mm, h= 5.00 mm</u>   |
| <b><u>ZoomScan</u></b>        | <u>7x7x7, dx=5mm dy=5mm dz=5mm</u>   |
| <b><u>Phantom</u></b>         | <u>Validation plane</u>              |
| <b><u>Device Position</u></b> | <u>Body</u>                          |
| <b><u>Band</u></b>            | <u>IEEE 802.11b ISM</u>              |
| <b><u>Channels</u></b>        | <u>High</u>                          |
| <b><u>Signal</u></b>          | <u>IEEE802.b (Crest factor: 1.0)</u> |
| <b><u>ConvF</u></b>           | <u>2.38</u>                          |

## B. SAR Measurement Results

|   |             |
|---|-------------|
| <b>Frequency (MHz)</b>                        | 2462.000000 |
| <b>Relative permittivity (real part)</b>      | 39.227045   |
| <b>Relative permittivity (imaginary part)</b> | 13.207032   |
| <b>Conductivity (S/m)</b>                     | 1.806428    |
| <b>Variation (%)</b>                          | -3.850000   |

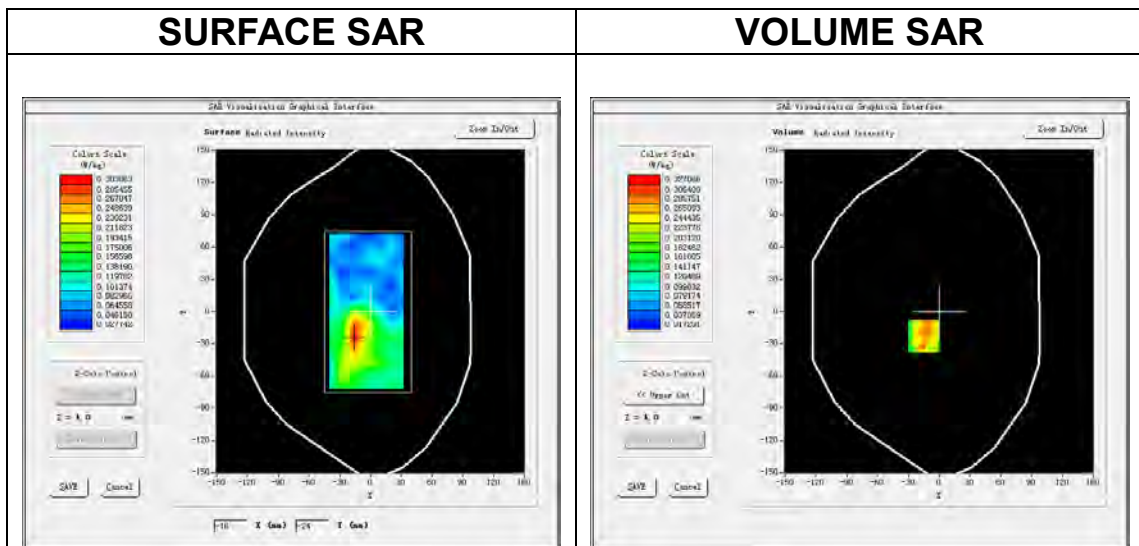

**Maximum location: X=-15.00, Y=-23.00**  
**SAR Peak: 0.60 W/kg**

|                       |          |
|-----------------------|----------|
| <b>SAR 10g (W/Kg)</b> | 0.179423 |
| <b>SAR 1g (W/Kg)</b>  | 0.262071 |

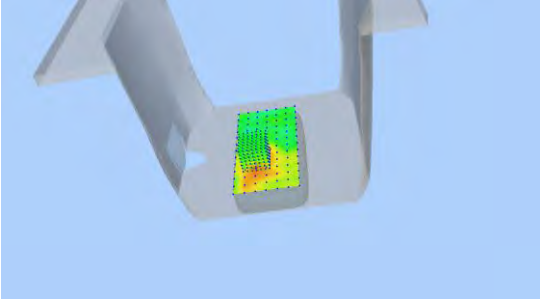
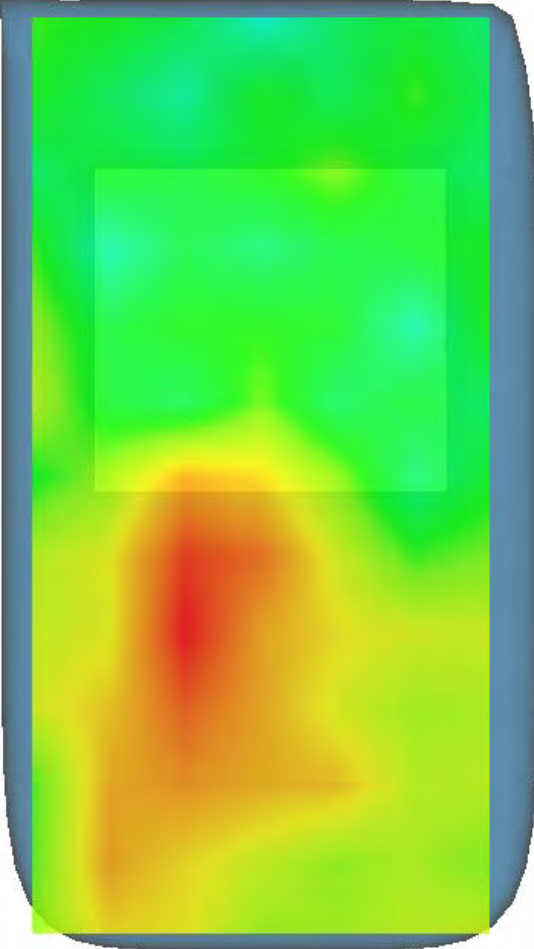

| 3D screen shot  | Hot spot position   |
|---|---|
|  |  |

# MEASUREMENT 9

Date of measurement: 27/11/2024

## A. Experimental conditions.

|                        |                                       |
|------------------------|---------------------------------------|
| <b>Area Scan</b>       | <u>dx=12mm dy=12mm, h= 5.00 mm</u>    |
| <b>ZoomScan</b>        | <u>7x7x7, dx=5mm dy=5mm dz=5mm</u>    |
| <b>Phantom</b>         | <u>Validation plane</u>               |
| <b>Device Position</b> | <u>Body</u>                           |
| <b>Band</b>            | <u>IEEE 802.11ax ISM</u>              |
| <b>Channels</b>        | <u>Middle</u>                         |
| <b>Signal</b>          | <u>IEEE802.ax (Crest factor: 1.0)</u> |
| <b>ConvF</b>           | <u>2.38</u>                           |

## B. SAR Measurement Results

|   |             |
|---|-------------|
| <b>Frequency (MHz)</b>                        | 2437.000000 |
| <b>Relative permittivity (real part)</b>      | 39.226002   |
| <b>Relative permittivity (imaginary part)</b> | 13.207000   |
| <b>Conductivity (S/m)</b>                     | 1.788081    |
| <b>Variation (%)</b>                          | -1.280000   |

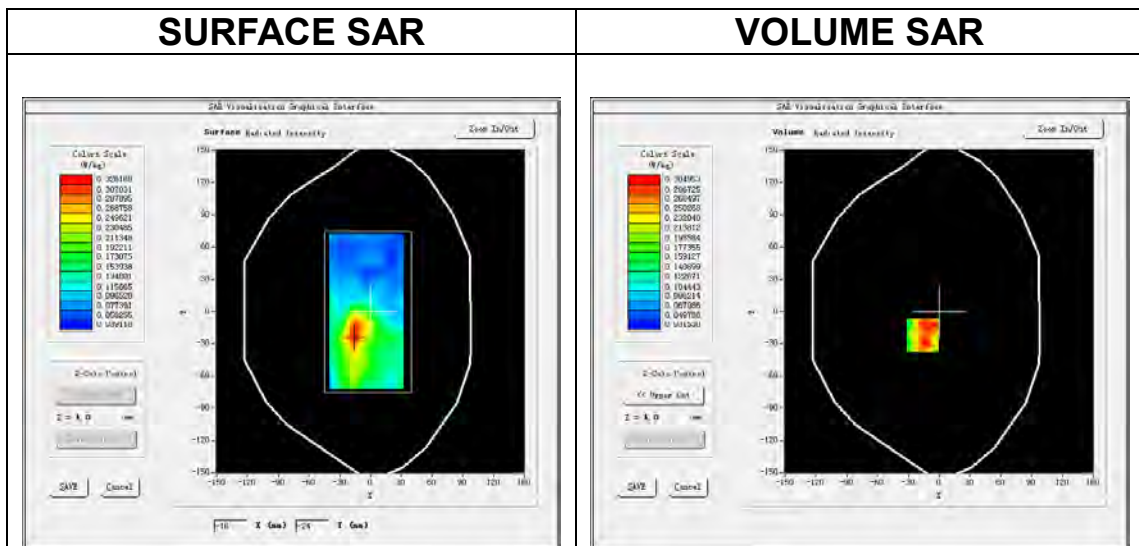

**Maximum location: X=-16.00, Y=-22.00**  
**SAR Peak: 0.55 W/kg**

|                       |          |
|-----------------------|----------|
| <b>SAR 10g (W/Kg)</b> | 0.189585 |
| <b>SAR 1g (W/Kg)</b>  | 0.293224 |

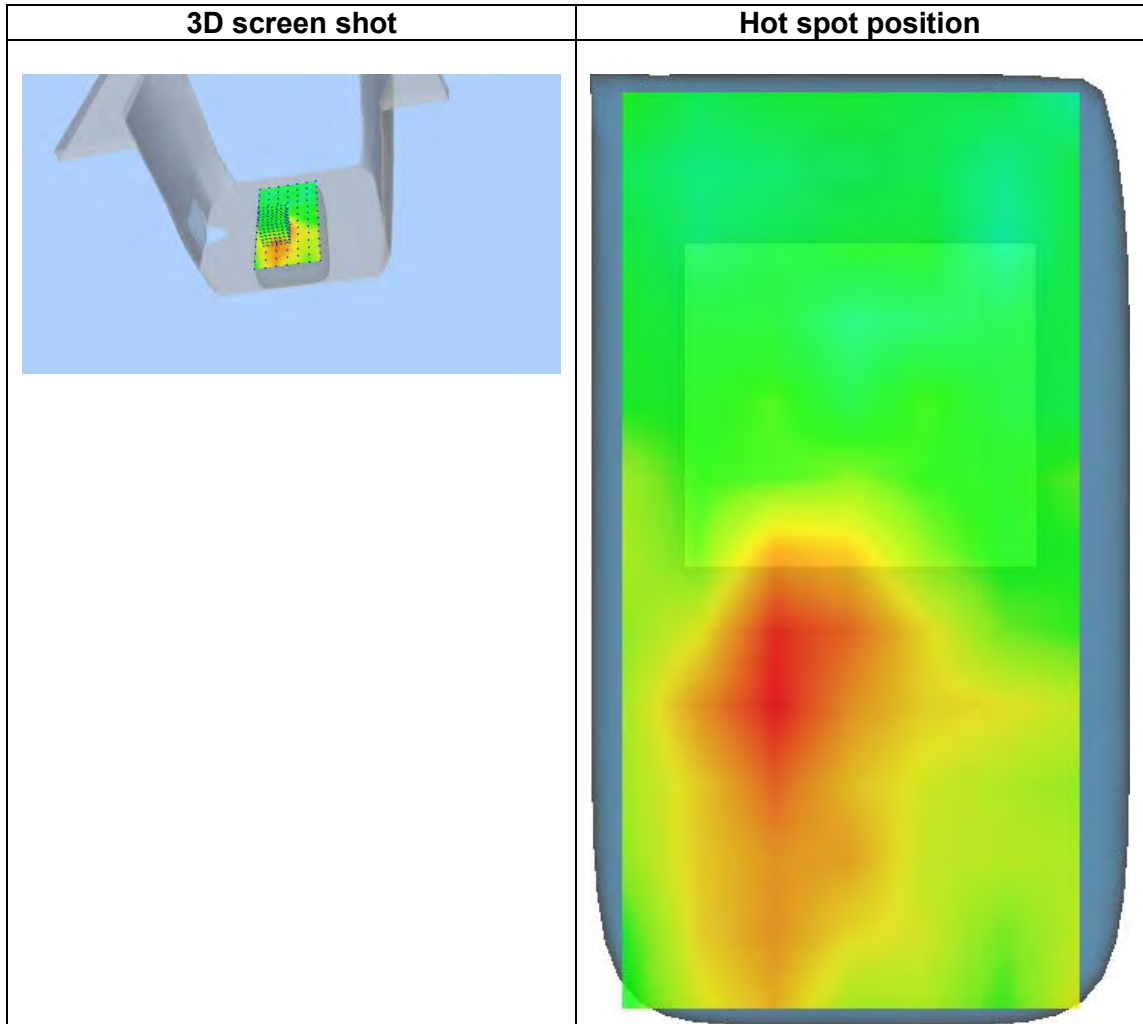

## Appendix D. Calibration Certificate

| Table of contents                        |
|--|
| E Field Probe - EPGO0523-403             |
| 2450 MHz Dipole - SN 03/15 DIP 2G450-352 |
| 5000-6000 MHz Dipole - SN 03/14 WGA33    |



## COMOSAR E-Field Probe Calibration Report

Ref : ACR.307.3.24.BES.A

**GUANGDONG ASIA HONGKE TEST  
TECHNOLOGY CO., LTD**  
NO.1/F,BUILDING B1, JUNFENG INDUSTRIAL PARK,  
CHONGQING ROAD, HEPING COMMUNITY,  
FUHAIHAI STREET, BAO'AN DISTRICT,SHENZHEN,  
GUANGDONG 518055, P.R.CHINA  
**MVG COMOSAR DOSIMETRIC E-FIELD PROBE**  
SERIAL NO.: SN 39/21 EPGO0523-403

**Calibrated at MVG**

**Z.I. de la pointe du diable**

**Technopôle Brest Iroise – 295 avenue Alexis de Rochon  
29280 PLOUZANE - FRANCE**

**Calibration date: 09/11/2024**



Accreditations #2-6789  
Scope available on [www.cofrac.fr](http://www.cofrac.fr)

**The use of the Cofrac brand and the accreditation references is prohibited from any reproduction.**



### *Summary:*

This document presents the method and results from an accredited COMOSAR E-Field Probe calibration performed at MVG, using the CALIPROBE test bench, for use with a MVG COMOSAR system only. The test results covered by accreditation are traceable to the International System of Units (SI).



COMOSAR E-FIELD PROBE CALIBRATION REPORT

Ref: ACR.307.3.24.BES.A

|                      | <i>Name</i>    | <i>Function</i>         | <i>Date</i> | <i>Signature</i>  |
|----------------------|----------------|-------------------------|-------------|---|
| <i>Prepared by :</i> | Jérôme Le Gall | Measurement Responsible | 09/10/2024  |  |
| <i>Checked by :</i>  | Jérôme Luc     | Technical Manager       | 09/10/2024  |  |
| <i>Approved by :</i> | Yann Toutain   | Laboratory Director     | 09/11/2024  |  |

|                       | <i>Customer Name</i>    |
|-----------------------|-------------------------|
| <i>Distribution :</i> | Shenzhen<br>Asia Hongke |

| <i>Issue</i> | <i>Name</i> | <i>Date</i> | <i>Modifications</i> |
|--------------|-------------|-------------|----------------------|
| A            | Jérôme Luc  | 9/11/2024   | Initial release      |
|              |             |             |                      |
|              |             |             |                      |
|              |             |             |                      |



## COMOSAR E-FIELD PROBE CALIBRATION REPORT

Ref: ACR.307.3.24.BES.A

## TABLE OF CONTENTS

|     |                                       |    |
|-----|---------------------------------------|----|
| 1   | Device Under Test .....               | 4  |
| 2   | Product Description .....             | 4  |
| 2.1 | General Information .....             | 4  |
| 3   | Measurement Method .....              | 4  |
| 3.1 | Linearity .....                       | 4  |
| 3.2 | Sensitivity .....                     | 4  |
| 3.3 | Lower Detection Limit .....           | 5  |
| 3.4 | Isotropy .....                        | 5  |
| 3.1 | Boundary Effect .....                 | 5  |
| 4   | Measurement Uncertainty .....         | 6  |
| 5   | Calibration Measurement Results ..... | 6  |
| 5.1 | Sensitivity in air .....              | 6  |
| 5.2 | Linearity .....                       | 7  |
| 5.3 | Sensitivity in liquid .....           | 8  |
| 5.4 | Isotropy .....                        | 9  |
| 6   | List of Equipment .....               | 10 |





**1 DEVICE UNDER TEST**

| Device Under Test                        |   |
|--|---|
| Device Type                              | COMOSAR DOSIMETRIC E FIELD PROBE  |
| Manufacturer                             | MVG   |
| Model                                    | SSE2  |
| Serial Number                            | SN 39/21 EPG00523-403   |
| Product Condition (new / used)           | New   |
| Frequency Range of Probe                 | 0.15 GHz-6GHz   |
| Resistance of Three Dipoles at Connector | Dipole 1: R1=0.199 MΩ<br>Dipole 2: R2=0.218 MΩ<br>Dipole 3: R3=0.210 MΩ |

**2 PRODUCT DESCRIPTION**

2.1 GENERAL INFORMATION

MVG's COMOSAR E field Probes are built in accordance to the IEC/IEEE 62209-1528 and FCC KDB865664 D01 standards.



**Figure 1 – MVG COMOSAR Dosimetric E field Probe**

|  |        |
|--|--------|
| Probe Length                               | 330 mm |
| Length of Individual Dipoles               | 2 mm   |
| Maximum external diameter                  | 8 mm   |
| Probe Tip External Diameter                | 2.5 mm |
| Distance between dipoles / probe extremity | 1 mm   |

**3 MEASUREMENT METHOD**

The IEC/IEEE 62209-1528 and FCC KDB865664 D01 standards provide recommended practices for the probe calibrations, including the performance characteristics of interest and methods by which to assess their affect. All calibrations / measurements performed meet the fore mentioned standards.

3.1 LINEARITY

The evaluation of the linearity was done in free space using the waveguide, performing a power sweep to cover the SAR range 0.01W/kg to 100W/kg.

3.2 SENSITIVITY

The sensitivity factors of the three dipoles were determined using a two step calibration method (air and tissue simulating liquid) using waveguides as outlined in the standards.





### 3.3 LOWER DETECTION LIMIT

The lower detection limit was assessed using the same measurement set up as used for the linearity measurement. The required lower detection limit is 10 mW/kg.

### 3.4 ISOTROPY

The axial isotropy was evaluated by exposing the probe to a reference wave from a standard dipole with the dipole mounted under the flat phantom in the test configuration suggested for system validations and checks. The probe was rotated along its main axis from 0 to 360 degrees in 15-degree steps. The hemispherical isotropy is determined by inserting the probe in a thin plastic box filled with tissue-equivalent liquid, with the plastic box illuminated with the fields from a half wave dipole. The dipole is rotated about its axis (0°–180°) in 15° increments. At each step the probe is rotated about its axis (0°–360°).

### 3.1 BOUNDARY EFFECT

The boundary effect is defined as the deviation between the SAR measured data and the expected exponential decay in the liquid when the probe is oriented normal to the interface. To evaluate this effect, the liquid filled flat phantom is exposed to fields from either a reference dipole or waveguide. With the probe normal to the phantom surface, the peak spatial average SAR is measured and compared to the analytical value at the surface.

The boundary effect uncertainty can be estimated according to the following uncertainty approximation formula based on linear and exponential extrapolations between the surface and  $d_{be} + d_{step}$  along lines that are approximately normal to the surface:

$$SAR_{uncertainty} [\%] = \Delta SAR_{be} \frac{(d_{be} + d_{step})^2}{2d_{step}} \frac{(e^{-\alpha_{be}(\delta/2)})}{\delta/2} \text{ for } (d_{be} + d_{step}) < 10 \text{ mm}$$

where

- $SAR_{uncertainty}$  is the uncertainty in percent of the probe boundary effect
- $d_{be}$  is the distance between the surface and the closest *zoom-scan* measurement point, in millimetre
- $\Delta_{step}$  is the separation distance between the first and second measurement points that are closest to the phantom surface, in millimetre, assuming the boundary effect at the second location is negligible
- $\delta$  is the minimum penetration depth in millimetres of the head tissue-equivalent liquids defined in this standard, i.e.,  $\delta \approx 14$  mm at 3 GHz;
- $\Delta SAR_{be}$  in percent of SAR is the deviation between the measured SAR value, at the distance  $d_{be}$  from the boundary, and the analytical SAR value.

The measured worst case boundary effect SARuncertainty[%] for scanning distances larger than 4mm is 1.0% Limit (2%).



#### 4 MEASUREMENT UNCERTAINTY

The guidelines outlined in the IEC/IEEE 62209-1528 and FCC KDB865664 D01 standards were followed to generate the measurement uncertainty associated with an E-field probe calibration using the waveguide technique. All uncertainties listed below represent an expanded uncertainty expressed at approximately the 95% confidence level using a coverage factor of k=2, traceable to the Internationally Accepted Guides to Measurement Uncertainty.

| Uncertainty analysis of the probe calibration in waveguide |                       |                          |         |    |                          |
|--|-----------------------|--------------------------|---------|----|--------------------------|
| ERROR SOURCES  | Uncertainty value (%) | Probability Distribution | Divisor | ci | Standard Uncertainty (%) |
| Expanded uncertainty<br>95 % confidence level k = 2        |                       |                          |         |    | 14 %                     |

#### 5 CALIBRATION MEASUREMENT RESULTS

| Calibration Parameters |             |
|------------------------|-------------|
| Liquid Temperature     | 20 +/- 1 °C |
| Lab Temperature        | 20 +/- 1 °C |
| Lab Humidity           | 30-70 %     |

##### 5.1 SENSITIVITY IN AIR

| Normx dipole<br>1 (µV/(V/m) <sup>2</sup> ) | Normy dipole<br>2 (µV/(V/m) <sup>2</sup> ) | Normz dipole<br>3 (µV/(V/m) <sup>2</sup> ) |
|--|--|--|
| 1.26                                       | 0.87                                       | 0.77                                       |

| DCP dipole 1<br>(mV) | DCP dipole 2<br>(mV) | DCP dipole 3<br>(mV) |
|----------------------|----------------------|----------------------|
| 113                  | 108                  | 113                  |

Calibration curves  $e_i=f(V)$  (i=1,2,3) allow to obtain E-field value using the formula:

$$E = \sqrt{E_1^2 + E_2^2 + E_3^2}$$



COMOSAR E-FIELD PROBE CALIBRATION REPORT

Ref: ACR.307.3.24.BES.A

Calibration curves

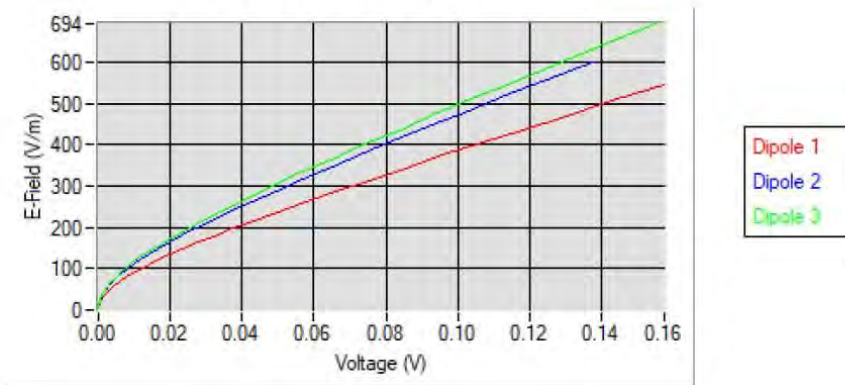

5.2 LINEARITY

Linearity

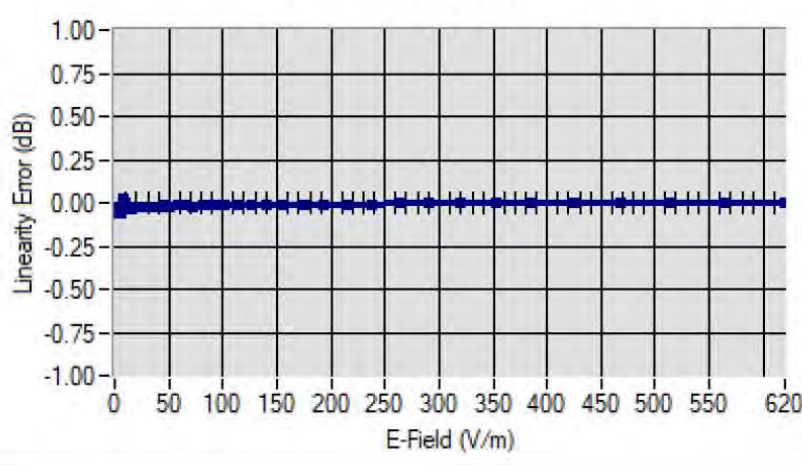

Linearity: +/-1.42% (+/-0.06dB)





COMOSAR E-FIELD PROBE CALIBRATION REPORT

Ref: ACR 307 3 24 BES A

5.3 SENSITIVITY IN LIQUID

| <u>Liquid</u> | <u>Frequency<br/>(MHz +/-<br/>100MHz)</u> | <u>ConvF</u> |
|---------------|---|--------------|
| HL600         | 600                                       | 1.62         |
| HL750         | 750                                       | 1.65         |
| HL850         | 835                                       | 1.66         |
| HL900         | 900                                       | 1.77         |
| HL1500        | 1500                                      | 2.09         |
| HL1750        | 1750                                      | 2.09         |
| HL1800        | 1800                                      | 2.05         |
| HL1900        | 1900                                      | 2.05         |
| HL2000        | 2000                                      | 2.41         |
| HL2100        | 2100                                      | 2.36         |
| HL2300        | 2300                                      | 2.55         |
| HL2450        | 2450                                      | 2.38         |
| HL2600        | 2600                                      | 2.35         |
| HL3300        | 3300                                      | 2.04         |
| HL3500        | 3500                                      | 1.98         |
| HL3700        | 3700                                      | 2.11         |
| HL3900        | 3900                                      | 2.54         |
| HL4200        | 4200                                      | 2.22         |
| HL4600        | 4600                                      | 2.40         |
| HL4900        | 4900                                      | 2.33         |
| HL5200        | 5200                                      | 2.30         |
| HL5400        | 5400                                      | 2.30         |
| HL5600        | 5600                                      | 2.29         |
| HL5800        | 5800                                      | 2.27         |

LOWER DETECTION LIMIT: 8mW/kg



#### 5.4 ISOTROPY

##### HL1800 MHz

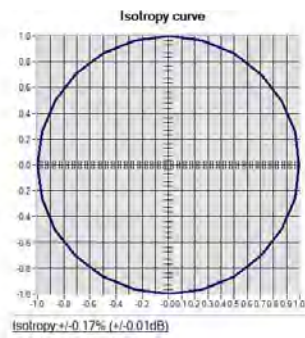



**6 LIST OF EQUIPMENT**

| Equipment Summary Sheet            |                         |                         |   |   |
|------------------------------------|-------------------------|-------------------------|---|---|
| Equipment Description              | Manufacturer / Model    | Identification No.      | Current Calibration Date                      | Next Calibration Date                         |
| CALIPROBE Test Bench               | Version 2               | NA                      | Validated. No cal required.                   | Validated. No cal required.                   |
| Network Analyzer                   | Rohde & Schwarz ZVM     | 100203                  | 08/2024                                       | 08/2027                                       |
| Network Analyzer                   | Agilent 8753ES          | MY40003210              | 10/2021                                       | 10/2024                                       |
| Network Analyzer – Calibration kit | Rohde & Schwarz ZV-Z235 | 101223                  | 05/2024                                       | 05/2027                                       |
| Network Analyzer – Calibration kit | HP 85033D               | 3423A08186              | 06/2021                                       | 06/2027                                       |
| Multimeter                         | Keithley 2000           | 1160271                 | 02/2024                                       | 02/2027                                       |
| Signal Generator                   | Rohde & Schwarz SMB     | 106589                  | 04/2024                                       | 04/2027                                       |
| Amplifier                          | MVG                     | MODU-023-C-0002         | Characterized prior to test. No cal required. | Characterized prior to test. No cal required. |
| Power Meter                        | NI-USB 5680             | 170100013               | 06/2024                                       | 06/2027                                       |
| Power Meter                        | Rohde & Schwarz NRVD    | 832839-056              | 11/2021                                       | 11/2024                                       |
| Directional Coupler                | Krytar 158020           | 131467                  | Characterized prior to test. No cal required. | Characterized prior to test. No cal required. |
| Waveguide                          | MVG                     | SN 32/16 WG4_1          | Validated. No cal required.                   | Validated. No cal required.                   |
| Liquid transition                  | MVG                     | SN 32/16 WGLIQ_0G900_1  | Validated. No cal required.                   | Validated. No cal required.                   |
| Waveguide                          | MVG                     | SN 32/16 WG6_1          | Validated. No cal required.                   | Validated. No cal required.                   |
| Liquid transition                  | MVG                     | SN 32/16 WGLIQ_1G500_1  | Validated. No cal required.                   | Validated. No cal required.                   |
| Waveguide                          | MVG                     | SN 32/16 WG8_1          | Validated. No cal required.                   | Validated. No cal required.                   |
| Liquid transition                  | MVG                     | SN 32/16 WGLIQ_1G800B_1 | Validated. No cal required.                   | Validated. No cal required.                   |
| Liquid transition                  | MVG                     | SN 32/16 WGLIQ_1G800H_1 | Validated. No cal required.                   | Validated. No cal required.                   |
| Waveguide                          | MVG                     | SN 32/16 WG10_1         | Validated. No cal required.                   | Validated. No cal required.                   |
| Liquid transition                  | MVG                     | SN 32/16 WGLIQ_3G500_1  | Validated. No cal required.                   | Validated. No cal required.                   |



COMOSAR E-FIELD PROBE CALIBRATION REPORT

Ref: ACR.307.3.24.BES.A

|                               |              |                        |                             |                             |
|-------------------------------|--------------|------------------------|-----------------------------|-----------------------------|
| Waveguide                     | MVG          | SN 32/16 WG12_1        | Validated. No cal required. | Validated. No cal required. |
| Liquid transition             | MVG          | SN 32/16 WGLIQ_5G000_1 | Validated. No cal required. | Validated. No cal required. |
| Temperature / Humidity Sensor | Testo 184 H1 | 44225320               | 06/2024                     | 06/2027                     |



## SAR Reference Dipole Calibration Report

Ref: ACR\_53.29.24.BES.A

**GUANGDONG ASIA HONGKE TEST  
TECHNOLOGY CO., LTD**  
NO.1/F,BUILDING B1, JUNFENG INDUSTRIAL PARK,  
CHONGQING ROAD, HEPING COMMUNITY ,  
FUHAIHAI STREET, BAO'AN DISTRICT, SHENZHEN,  
GUANGDONG 518055, P.R.CHINA  
**MVG COMOSAR REFERENCE DIPOLE**  
FREQUENCY: 2450MHZ  
SERIAL NO.: SN 03/15 DIP2G450-352

Calibrated at MVG  
Z.I. de la pointe du diable  
Technopôle Brest Iroise – 295 avenue Alexis de Rochon  
29280 PLOUZANE - FRANCE

Calibration date: 02/21/2024



Accreditations #2-6789 and #2-6814  
Scope available on [www.cofrac.fr](http://www.cofrac.fr)

The use of the Cofrac brand and the accreditation references is prohibited from any reproduction.

### Summary:



This document presents the method and results from an accredited SAR reference dipole calibration performed in MVG using the COMOSAR test bench. All calibration results are traceable to national metrology institutions.



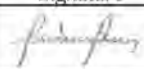

SAR REFERENCE DIPOLE CALIBRATION REPORT

Ref: ACR-31 2024 BESA

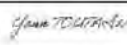
|                        | Name         | Function                | Date      | Signature   |
|------------------------|--------------|-------------------------|-----------|---|
| Prepared by :          | Pedro Ruiz   | Measurement Responsible | 2/22/2024 |  |
| Checked & approved by: | Jérôme Luc   | Technical Manager       | 2/22/2024 |  |
| Authorized by:         | Yann Toutain | Laboratory Director     | 2/27/2024 |  |

Yann Toutain ID  
 Signature numérique de Yann Toutain ID  
 Date : 2024.02.27 08:57:39 +01'00'

|                | Customer Name        |
|----------------|----------------------|
| Distribution : | Shenzhen Asia Hongke |

| Issue | Name       | Date      | Modifications   |
|-------|------------|-----------|-----------------|
| A     | Pedro Ruiz | 2/22/2024 | Initial release |
|       |            |           |                 |
|       |            |           |                 |



TABLE OF CONTENTS

|     |                                 |   |
|-----|---------------------------------|---|
| 1   | Introduction.....               | 4 |
| 2   | Device Under Test.....          | 4 |
| 3   | Product Description.....        | 4 |
| 3.1 | General Information.....        | 4 |
| 4   | Measurement Method.....         | 5 |
| 4.1 | Mechanical Requirements.....    | 5 |
| 4.2 | S11 parameter Requirements..... | 5 |
| 4.3 | SAR Requirements.....           | 5 |
| 5   | Measurement Uncertainty.....    | 5 |
| 5.1 | Mechanical dimensions.....      | 5 |
| 5.2 | S11 Parameter.....              | 5 |
| 5.3 | SAR.....                        | 5 |
| 6   | Calibration Results.....        | 6 |
| 6.1 | Mechanical Dimensions.....      | 6 |
| 6.2 | S11 parameter.....              | 6 |
| 6.3 | SAR.....                        | 6 |
| 7   | List of Equipment.....          | 8 |



**1 INTRODUCTION**

This document contains a summary of the requirements set forth by the IEC/IEEE 62209-1528 and FCC KDB865664 D01 standards for reference dipoles used for SAR measurement system validations and the measurements that were performed to verify that the product complies with the fore mentioned standards.

**2 DEVICE UNDER TEST**

| Device Under Test              |                                   |
|--------------------------------|-----------------------------------|
| Device Type                    | COMOSAR 2450 MHz REFERENCE DIPOLE |
| Manufacturer                   | MVG                               |
| Model                          | SID2450                           |
| Serial Number                  | SN 03/15DIP2G450-352              |
| Product Condition (new / used) | Used                              |

**3 PRODUCT DESCRIPTION**

**3.1 GENERAL INFORMATION**

MVG’s COMOSAR Validation Dipoles are built in accordance to the IEC/IEEE 62209-1528 and FCC KDB865664 D01 standards. The product is designed for use with the COMOSAR test bench only.



**Figure 1 – MVG COMOSAR Validation Dipole**



## 4 MEASUREMENT METHOD

### 4.1 MECHANICAL REQUIREMENTS

The IEC/IEEE 62209-1528 and FCC KDB865664 D01 standards specify the mechanical components and dimensions of the validation dipoles, with the dimension's frequency and phantom shell thickness dependent. The COMOSAR test bench employs a 2 mm phantom shell thickness therefore the dipoles sold for use with the COMOSAR test bench comply with the requirements set forth for a 2 mm phantom shell thickness. A direct method is used with a ISO17025 calibrated caliper.

### 4.2 S11 PARAMETER REQUIREMENTS

The dipole used for SAR system validation measurements and checks must have a S11 of -20 dB or better. The S11 measurement shall be performed against a liquid filled flat phantom, with the phantom constructed as outlined in the fore mentioned standards. A direct method is used with a network analyser and its calibration kit, both with a valid ISO17025 calibration.

### 4.3 SAR REQUIREMENTS

The IEC/IEEE 62209-1528 and FCC KDB865664 D01 standards provide requirements for reference dipoles used for system validation measurements. The following measurements were performed to verify that the product complies with the fore-mentioned standards.

## 5 MEASUREMENT UNCERTAINTY

### 5.1 MECHANICAL DIMENSIONS

For the measurement in the range 0-300mm, the estimated expanded uncertainty (k=2) in calibration for the dimension measurement in mm is +/-0.20 mm with respect to measurement conditions.

For the measurement in the range 300-450mm, the estimated expanded uncertainty (k=2) in calibration for the dimension measurement in mm is +/-0.44 mm with respect to measurement conditions.

### 5.2 S11 PARAMETER

The estimated expanded uncertainty (k=2) in calibration for the S11 parameter in linear is +/-0.08 with respect to measurement conditions.

### 5.3 SAR

The guidelines outlined in the IEC/IEEE 62209-1528 and FCC KDB865664 D01 standards were followed to generate the measurement uncertainty for validation measurements.

The estimated expanded uncertainty (k=2) in calibration for the 1g and 10g SAR measurement in W/kg is +/-19% with respect to measurement conditions.



**6 CALIBRATION RESULTS**

**6.1 MECHANICAL DIMENSIONS**

| L mm     |              | h mm     |              | d mm     |             |
|----------|--------------|----------|--------------|----------|-------------|
| Measured | Required     | Measured | Required     | Measured | Required    |
| -        | 51.50 +/- 2% | -        | 30.40 +/- 2% | -        | 3.60 +/- 2% |

**6.2 S11 PARAMETER**

**6.2.1 S11 parameter in Head Liquid**

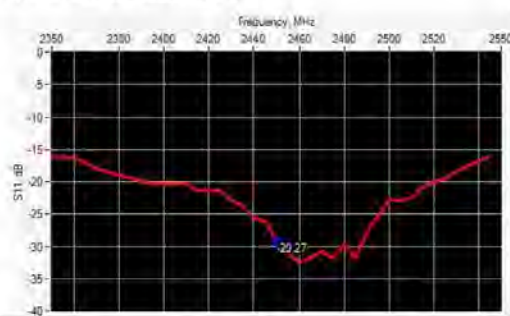

| Frequency (MHz) | S11 parameter (dB) | Requirement (dB) | Impedance     |
|-----------------|--------------------|------------------|---------------|
| 2450            | -29.27             | -20              | 53.6Ω + 0.1jΩ |

**6.3 SAR**

The IEC/IEEE 62209-1528 and FCC KDB865664 D01 standards state that the system validation measurements must be performed using a reference dipole meeting the fore mentioned return loss and mechanical dimension requirements. The validation measurement must be performed against a liquid filled flat phantom, with the phantom constructed as outlined in the fore mentioned standards. Per the standards, the dipole shall be positioned below the bottom of the phantom, with the dipole length centered and parallel to the longest dimension of the flat phantom, with the top surface of the dipole at the described distance from the bottom surface of the phantom.

**6.3.1 SAR with Head Liquid**

The IEC/IEEE 62209-1528 and FCC KDB865664 D01 standards state that the system validation measurements should produce the SAR values shown below (for phantom thickness of 2 mm), within the uncertainty for the system validation. All SAR values are normalized to 1 W forward power. In bracket, the measured SAR is given with the used input power:





SAR REFERENCE DIPOLE CALIBRATION REPORT

Ref: ACR 33.2924.BES.A

|   |  |
|---|--|
| Software                                  | OPENSAR V5   |
| Phantom                                   | SN 13/09 SAM68   |
| Probe                                     | 3523-EPGO-429  |
| Liquid                                    | Head Liquid Values: $\epsilon_p'$ : 42.1 $\sigma$ : 1.83 |
| Distance between dipole center and liquid | 10.0 mm  |
| Area scan resolution                      | $dx=8mm/dy=8mm$  |
| Zoon Scan Resolution                      | $dx=5mm/dy=5mm/dz=5mm$                                   |
| Frequency                                 | 2450 MHz   |
| Input power                               | 20 dBm   |
| Liquid Temperature                        | 20 +/- 1 °C  |
| Lab Temperature                           | 20 +/- 1 °C  |
| Lab Humidity                              | 30-70 %  |

| Frequency | 1g SAR (W/kg) |                           |                         | 10g SAR (W/kg) |                           |                         |
|-----------|---------------|---------------------------|-------------------------|----------------|---------------------------|-------------------------|
|           | Measured      | Measured normalized to 1W | Target normalized to 1W | Measured       | Measured normalized to 1W | Target normalized to 1W |
| 2450 MHz  | 5.00          | 50.05                     | 52.40                   | 2.38           | 23.80                     | 24.00                   |

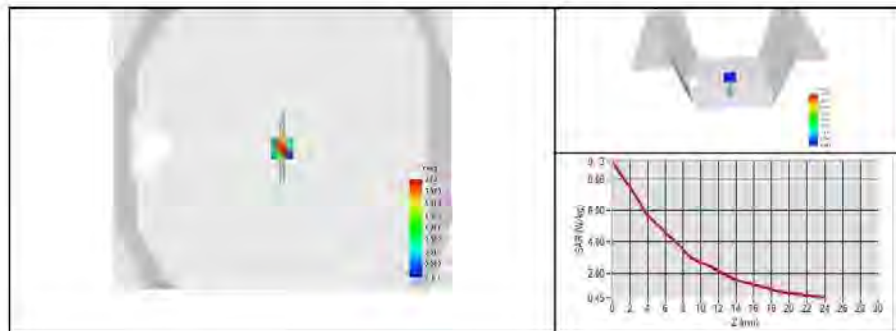



7 LIST OF EQUIPMENT

| Equipment Summary Sheet            |                         |                    |   |   |
|------------------------------------|-------------------------|--------------------|---|---|
| Equipment Description              | Manufacturer / Model    | Identification No. | Current Calibration Date                      | Next Calibration Date                         |
| SAM Phantom                        | MVG                     | SN 13/09 SAM68     | Validated. No cal required.                   | Validated. No cal required.                   |
| COMOSAR Test Bench                 | Version 3               | NA                 | Validated. No cal required.                   | Validated. No cal required.                   |
| Network Analyzer                   | Rohde & Schwarz ZVM     | 100203             | 08/2021                                       | 08/2024                                       |
| Network Analyzer – Calibration kit | Rohde & Schwarz ZV-Z235 | 101223             | 07/2022                                       | 07/2025                                       |
| Calipers                           | Mitutoyo                | SN 0009732         | 11/2022                                       | 11/2025                                       |
| Reference Probe                    | MVG                     | 3523-EPGO-429      | 11/2023                                       | 11/2024                                       |
| Multimeter                         | Keithley 2000           | 4013982            | 02/2023                                       | 02/2026                                       |
| Signal Generator                   | Rohde & Schwarz SMB     | 106589             | 03/2022                                       | 03/2025                                       |
| Amplifier                          | MVG                     | MODU-023-C-0002    | Characterized prior to test. No cal required. | Characterized prior to test. No cal required. |
| Power Meter                        | NI-USB 5880             | 170100013          | 06/2021                                       | 06/2024                                       |
| Power Meter                        | Keysight U2000A         | SN: MY62340002     | 10/2022                                       | 10/2025                                       |
| Directional Coupler                | Krytar 158020           | 131467             | Characterized prior to test. No cal required. | Characterized prior to test. No cal required. |
| Temperature / Humidity Sensor      | Testo 184 H1            | 44225320           | 06/2021                                       | 06/2024                                       |



## SAR Reference Waveguide Calibration Report

Ref : ACR 53 31 24.BES.A

### **GUANGDONG ASIA HONGKE TEST TECHNOLOGY CO., LTD**

**NO.1/F,BUILDING B1, JUNFENG INDUSTRIAL PARK,  
CHONGQING ROAD, HEPING COMMUNITY ,  
FUHAIHAI STREET, BAO'AN DISTRICT,SHENZHEN,  
GUANGDONG 518055, P.R.CHINA**

**MVG COMOSAR REFERENCE WAVEGUIDE  
FREQUENCY: 5000-6000 MHZ  
SERIAL NO.: SN 13/14 WGA33**

Calibrated at MVG

Z.I. de la pointe du diable

Technopôle Brest Iroise – 295 avenue Alexis de Rochon  
29280 PLOUZANE - FRANCE

Calibration date: 02/21/2024



Accreditations #2-6789 and #2-6814  
Scope available on [www.cofrac.fr](http://www.cofrac.fr)

The use of the Cofrac brand and the accreditation references is prohibited from any reproduction.

#### *Summary:*



This document presents the method and results from an accredited SAR reference waveguide calibration performed at MVG, using the COMOSAR test bench. The test results covered by accreditation are traceable to the International System of Units (SI).



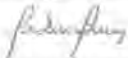

SAR REFERENCE WAVEGUIDE CALIBRATION REPORT

Ref: ACF-53 3124 BBS A

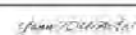
|                                   | <i>Name</i>  | <i>Function</i>         | <i>Date</i> | <i>Signature</i>  |
|-----------------------------------|--------------|-------------------------|-------------|---|
| <i>Prepared by:</i>               | Pedro Ruiz   | Measurement Responsible | 2/22/2024   |  |
| <i>Checked &amp; approved by:</i> | Jérôme Luc   | Technical Manager       | 2/22/2024   |  |
| <i>Authorized by:</i>             | Yann Toutain | Laboratory Director     | 2/27/2024   |  |

Yann  
Toutain ID

Signature numérique de Yann Toutain ID  
Date : 2024.02.27  
08:58:45 +0100

|                       | <i>Customer Name</i>    |
|-----------------------|-------------------------|
| <i>Distribution :</i> | Shenzhen<br>Asia Hongke |

| <i>Issue</i> | <i>Name</i> | <i>Date</i> | <i>Modifications</i> |
|--------------|-------------|-------------|----------------------|
| A            | Pedro Ruiz  | 2/22/2024   | Initial release      |
|              |             |             |                      |
|              |             |             |                      |



## TABLE OF CONTENTS

|     |                                 |   |
|-----|---------------------------------|---|
| 1   | Introduction.....               | 4 |
| 2   | Device Under Test.....          | 4 |
| 3   | Product Description.....        | 4 |
| 3.1 | General Information.....        | 4 |
| 4   | Measurement Method.....         | 4 |
| 4.1 | Mechanical Requirements.....    | 4 |
| 4.2 | S11 parameter Requirements..... | 4 |
| 4.3 | SAR Requirements.....           | 5 |
| 5   | Measurement Uncertainty.....    | 5 |
| 5.1 | Mechanical dimensions.....      | 5 |
| 5.2 | S11 Parameter.....              | 5 |
| 5.3 | SAR.....                        | 5 |
| 6   | Calibration Results.....        | 5 |
| 6.1 | Mechanical Dimensions.....      | 5 |
| 6.2 | S11 parameter.....              | 6 |
| 6.3 | SAR.....                        | 6 |
| 7   | List of Equipment.....          | 9 |



**1 INTRODUCTION**

This document contains a summary of the requirements set forth by the IEC/IEEE 62209-1528 and FCC KDB865664 D01 standards for reference waveguides used for SAR measurement system validations and the measurements that were performed to verify that the product complies with the fore mentioned standards.

**2 DEVICE UNDER TEST**

| Device Under Test              |   |
|--------------------------------|---|
| Device Type                    | COMOSAR 5000-6000 MHz REFERENCE WAVEGUIDE |
| Manufacturer                   | MVG                                       |
| Model                          | SWG5500                                   |
| Serial Number                  | SN 13/14 WGA 33                           |
| Product Condition (new / used) | Used                                      |

**3 PRODUCT DESCRIPTION**

**3.1 GENERAL INFORMATION**

MVG's COMOSAR Validation Waveguides are built in accordance to the IEC/IEEE 62209-1528 and FCC KDB865664 D01 standards.

**4 MEASUREMENT METHOD**

**4.1 MECHANICAL REQUIREMENTS**

The IEC/IEEE 62209-1528 and FCC KDB865664 D01 standards specify the mechanical components and dimensions of the validation dipoles, with the dimension's frequency and phantom shell thickness dependent. The COMOSAR test bench employs a 2 mm phantom shell thickness therefore the dipoles sold for use with the COMOSAR test bench comply with the requirements set forth for a 2 mm phantom shell thickness. A direct method is used with a ISO17025 calibrated caliper.

**4.2 S11 PARAMETER REQUIREMENTS**

The dipole used for SAR system validation measurements and checks must have a S11 of -8 dB or better. The S11 measurement shall be performed against a liquid filled flat phantom, with the phantom constructed as outlined in the fore mentioned standards. A direct method is used with a network analyser and its calibration kit, both with a valid ISO17025 calibration.



4.3 SAR REQUIREMENTS

The IEC/IEEE 62209-1528 and FCC KDB865664 D01 standards provide requirements for reference dipoles used for system validation measurements. The following measurements were performed to verify that the product complies with the fore-mentioned standards.

5 MEASUREMENT UNCERTAINTY

5.1 MECHANICAL DIMENSIONS

The estimated expanded uncertainty (k=2) in calibration for the dimension measurement in mm is +/- 0.20 mm with respect to measurement conditions.

5.2 S11 PARAMETER

The estimated expanded uncertainty (k=2) in calibration for the S11 parameter in linear is +/-0.08 with respect to measurement conditions.

5.3 SAR

The guidelines outlined in the IEC/IEEE 62209-1528 and FCC KDB865664 D01 standards were followed to generate the measurement uncertainty for validation measurements.

The estimated expanded uncertainty (k=2) in calibration for the 1g and 10g SAR measurement in W/kg is +/-19% with respect to measurement conditions.

6 CALIBRATION RESULTS

6.1 MECHANICAL DIMENSIONS

| Frequency (MHz) | L (mm)       |          | W (mm)       |          | Lr (mm)      |          | Wr (mm)      |          |
|-----------------|--------------|----------|--------------|----------|--------------|----------|--------------|----------|
|                 | Required     | Measured | Required     | Measured | Required     | Measured | Required     | Measured |
| 5800            | 40.39 ± 0.13 | -        | 20.19 ± 0.13 | -        | 81.03 ± 0.13 | -        | 61.98 ± 0.13 | -        |

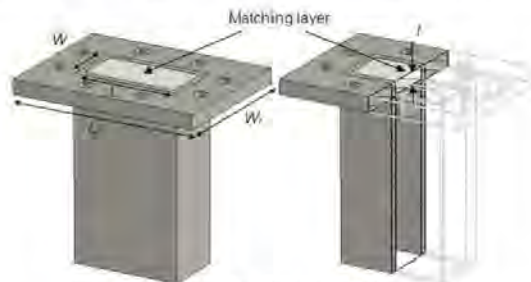
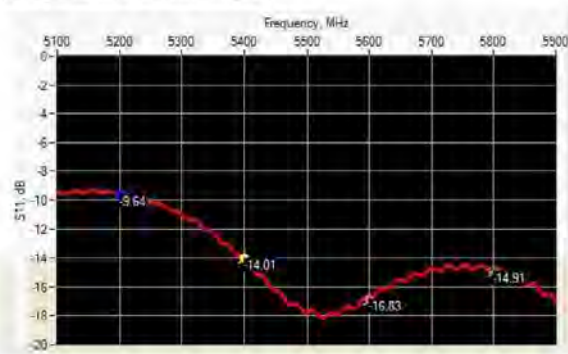

Figure 1: Validation Waveguide Dimensions



6.2 S11 PARAMETER

6.2.1 S11 parameter In Head Liquid



| Frequency (MHz) | S11 parameter (dB) | Requirement (dB) | Impedance          |
|-----------------|--------------------|------------------|--------------------|
| 5200            | -9.64              | -8               | 25.80 Ω - 6.58 jΩ  |
| 5400            | -14.01             | -8               | 51.53 Ω + 20.60 jΩ |
| 5600            | -16.83             | -8               | 44.12 Ω - 12.35 jΩ |
| 5800            | -14.91             | -8               | 38.53 Ω + 11.21 jΩ |

6.3 SAR

The IEC/IEEE 62209-1528 and FCC KDB865664 D01 standards state that the system validation measurements must be performed using a reference waveguide meeting the fore mentioned return loss and mechanical dimension requirements. The validation measurement must be performed with the matching layer placed in the open end of the waveguide, with the waveguide and matching layer in direct contact with the phantom shell.

6.3.1 SAR With Head Liquid

At those frequencies, the target SAR value can not be generic. Hereunder is the target SAR value defined by MVG, within the uncertainty for the system validation. All SAR values are normalized to 1 W net power. In bracket, the measured SAR is given with the used input power.





SAR REFERENCE WAVEGUIDE CALIBRATION REPORT

Ref: ACR-53-31-24-BES-A

|  |  |
|--|--|
| Software                                     | OPENSAR V5   |
| Phantom                                      | SN 13/09 SAM68   |
| Probe  | 3523-EPGO-429  |
| Liquid                                       | Head Liquid Values 5200 MHz: eps' :34.16 sigma : 4.42<br>Head Liquid Values 5400 MHz: eps' :33.63 sigma : 4.64<br>Head Liquid Values 5600 MHz: eps' :33.12 sigma : 4.87<br>Head Liquid Values 5800 MHz: eps' :32.57 sigma : 5.12 |
| Distance between dipole waveguide and liquid | 0 mm   |
| Area scan resolution                         | dx=8mm/dy=8mm  |
| Zoon Scan Resolution                         | dx=4mm/dy=4m/dz=2mm  |
| Frequency                                    | 5200 MHz<br>5400 MHz<br>5600 MHz<br>5800 MHz   |
| Input power                                  | 20 dBm   |
| Liquid Temperature                           | 20 +/- 1 °C  |
| Lab Temperature                              | 20 +/- 1 °C  |
| Lab Humidity                                 | 30-70 %  |

| Frequency (MHz) | 1 g SAR (W/kg) |                           |                         | 10 g SAR (W/kg) |                           |                         |
|-----------------|----------------|---------------------------|-------------------------|-----------------|---------------------------|-------------------------|
|                 | Measured       | Measured normalized to 1W | Target normalized to 1W | Measured        | Measured normalized to 1W | Target normalized to 1W |
| 5200            | 16.26          | 162.59                    | 159.00                  | 5.62            | 56.21                     | 56.90                   |
| 5400            | 15.98          | 159.81                    | 166.40                  | 5.50            | 55.00                     | 58.43                   |
| 5600            | 17.91          | 179.15                    | 173.80                  | 6.10            | 61.01                     | 59.97                   |
| 5800            | 18.22          | 182.20                    | 181.20                  | 6.13            | 61.32                     | 61.50                   |

SAR MEASUREMENT PLOTS @ 5200 MHz

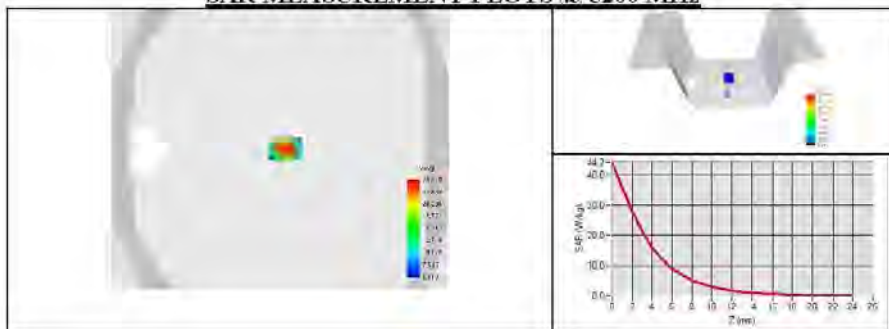



SAR REFERENCE WAVEGUIDE CALIBRATION REPORT

Ref: ACR\_53.31.24.BES.A

**SAR MEASUREMENT PLOTS @ 5400 MHz**

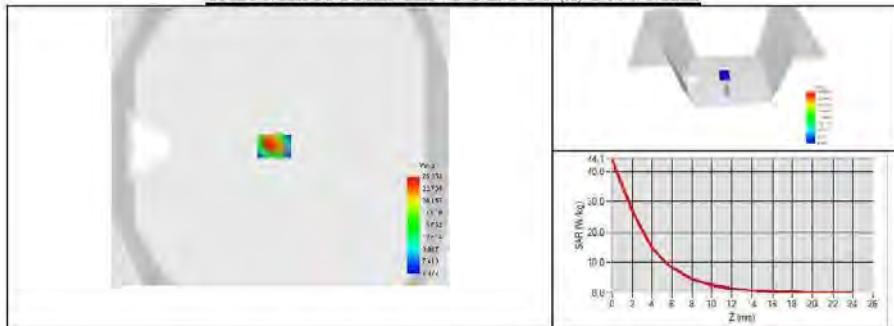

**SAR MEASUREMENT PLOTS @ 5600 MHz**

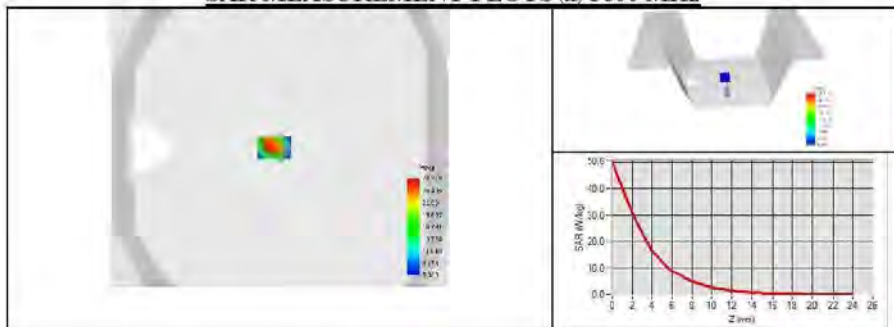

**SAR MEASUREMENT PLOTS @ 5800 MHz**

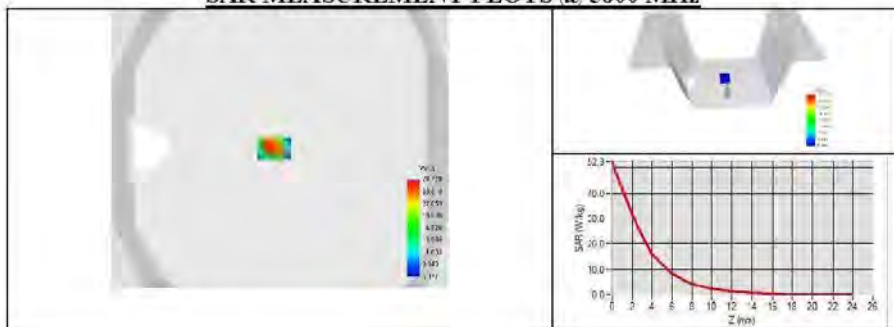



7 LIST OF EQUIPMENT

| Equipment Summary Sheet            |                         |                    |   |   |
|------------------------------------|-------------------------|--------------------|---|---|
| Equipment Description              | Manufacturer / Model    | Identification No. | Current Calibration Date                      | Next Calibration Date                         |
| SAM Phantom                        | MVG                     | SN 13/09 SAM68     | Validated. No cal required.                   | Validated. No cal required.                   |
| COMOSAR Test Bench                 | Version 3               | NA                 | Validated. No cal required.                   | Validated. No cal required.                   |
| Network Analyzer                   | Rohde & Schwarz ZVM     | 100203             | 08/2021                                       | 08/2024                                       |
| Network Analyzer – Calibration kit | Rohde & Schwarz ZV-Z235 | 101223             | 07/2022                                       | 07/2025                                       |
| Calipers                           | Mitutoyo                | SN 0009732         | 11/2022                                       | 11/2025                                       |
| Reference Probe                    | MVG                     | 3623-EPGO-431      | 11/2023                                       | 11/2024                                       |
| Multimeter                         | Keithley 2000           | 4013982            | 02/2023                                       | 02/2026                                       |
| Signal Generator                   | Rohde & Schwarz SMB     | 106589             | 03/2022                                       | 03/2025                                       |
| Amplifier                          | MVG                     | MODU-023-C-0002    | Characterized prior to test. No cal required. | Characterized prior to test. No cal required. |
| Power Meter                        | NI-USB 5680             | 170100013          | 06/2021                                       | 06/2024                                       |
| Power Meter                        | Keysight U2000A         | SN: MY62340002     | 10/2022                                       | 10/2025                                       |
| Directional Coupler                | Krytar 158020           | 131467             | Characterized prior to test. No cal required. | Characterized prior to test. No cal required. |
| Temperature / Humidity Sensor      | Testo 184 H1            | 44225320           | 06/2021                                       | 06/2024                                       |