

## TEST REPORT

Test report no.: 1-3720/20-01-02-B

BNetzA-CAB-02/21-102

### Testing laboratory

**CTC advanced GmbH**  
Untertuerkheimer Strasse 6 – 10  
66117 Saarbruecken / Germany  
Phone: + 49 681 5 98 - 0  
Fax: + 49 681 5 98 - 9075  
Internet: <http://www.ctcadvanced.com>  
e-mail: [mail@ctcadvanced.com](mailto:mail@ctcadvanced.com)

### Applicant

**Acconeer AB**  
Västra Varvsgatan 19  
211 77 Malmö / SWEDEN  
Phone: +46 72 5838428  
Fax:  
Contact: Mikael Egard  
e-mail: [Mikael.egard@aconeer.com](mailto:Mikael.egard@aconeer.com)  
Phone: +46 72 5838428

### Manufacturer

**Acconeer AB**  
Västra Varvsgatan 19  
211 77 Malmö / SWEDEN

### Test standard/s

47 CFR Part 15 Title 47 of the Code of Federal Regulations; Chapter I; Part 15 - Radio frequency devices

For further applied test standards please refer to section 3 of this test report.

### Test Item

**Kind of test item:** Module for SRD radar 60 GHz  
**Model name:** XR112 - LH112 - A111-003 Pulsed Coherent Radar  
**FCC ID:** 2AQ6KA1003  
**Frequency:** 57 GHz – 71 GHz  
**Antenna:** 2 embedded Dipole Antennas dielectric Lens LH112  
**Power supply:** 1.71 V to 1.89 V DC  
**Temperature range:** -40°C to +85°C



This test report is electronically signed and valid without handwritten signature. For verification of the electronic signatures, the public keys can be requested at the testing laboratory.

### Test report authorized:

p.o.

Meheza Walla  
Lab Manager  
Radio Communications & EMC

### Test performed:

Thomas Vogler  
Lab Manager  
Radio Communications & EMC

**1 Table of contents**

**1 Table of contents ..... 2**

**2 General information ..... 3**

**2.1 Notes and disclaimer ..... 3**

**2.2 Application details ..... 3**

**2.3 Test laboratories sub-contracted ..... 3**

**3 Test standard/s and references ..... 4**

**4 Reporting statements of conformity – decision rule ..... 5**

**5 Test environment ..... 6**

**6 Test item ..... 6**

**6.1 General description ..... 6**

**6.2 Additional information ..... 6**

**7 Description of the test setup ..... 7**

**7.1 Shielded semi anechoic chamber ..... 8**

**7.3 Radiated measurements, 18 GHz – 50 GHz ..... 10**

**7.4 Radiated measurements > 50 GHz ..... 10**

**7.5 Radiated measurements > 50 GHz ..... 11**

**8 Sequence of testing ..... 13**

**8.1 Sequence of testing radiated spurious 9 kHz to 30 MHz ..... 13**

**8.2 Sequence of testing radiated spurious 30 MHz to 1 GHz ..... 14**

**8.3 Sequence of testing radiated spurious 1 GHz to 18 GHz ..... 15**

**8.4 Sequence of testing radiated spurious above 18 GHz ..... 16**

**8.5 Sequence of testing radiated spurious above 50 GHz with external mixers ... 17**

**9 Measurement uncertainty ..... 18**

**10 Far field consideration for measurements above 18 GHz ..... 18**

**11 Summary of measurement results ..... 19**

**12 Measurement results ..... 20**

**12.1 Occupied bandwidth ..... 20**

**12.2 Maximum E.I.R.P. / Transmitter Output Power ..... 22**

        12.2.1 Set-up of radiated RF-detector- and power measurement: ..... 24

**12.3 Spurious emissions radiated ..... 30**

**12.4 Frequency Stability ..... 39**

**13 Glossary ..... 43**

**14 Document history ..... 44**

**15 Accreditation Certificate – D-PL-12076-01-05 ..... 44**

## 2 General information

### 2.1 Notes and disclaimer

The test results of this test report relate exclusively to the test item specified in this test report. CTC advanced GmbH does not assume responsibility for any conclusions and generalizations drawn from the test results with regard to other specimens or samples of the type of the equipment represented by the test item.

The test report may only be reproduced or published in full. Reproduction or publication of extracts from the report requires the prior written approval of CTC advanced GmbH.

The testing service provided by CTC advanced GmbH has been rendered under the current "General Terms and Conditions for CTC advanced GmbH".

CTC advanced GmbH will not be liable for any loss or damage resulting from false, inaccurate, inappropriate or incomplete product information provided by the customer.

Under no circumstances does the CTC advanced GmbH test report include any endorsement or warranty regarding the functionality, quality or performance of any other product or service provided.

Under no circumstances does the CTC advanced GmbH test report include or imply any product or service warranties from CTC advanced GmbH, including, without limitation, any implied warranties of merchantability, fitness for purpose, or non-infringement, all of which are expressly disclaimed by CTC advanced GmbH.

All rights and remedies regarding vendor's products and services for which CTC advanced GmbH has prepared this test report shall be provided by the party offering such products or services and not by CTC advanced GmbH. In no case this test report can be considered as a Letter of Approval.

This test report is electronically signed and valid without handwritten signature. For verification of the electronic signatures, the public keys can be requested at the testing laboratory.

**This test report replaces test report 1-3720/21-01-02-A dated from January 24, 2022.**

### 2.2 Application details

Date of receipt of order:	2021-12-13
Date of receipt of test item:	2021-12-13
Start of test:	2022-01-03
End of test:	2022-01-06
Person(s) present during the test:	-/-

### 2.3 Test laboratories sub-contracted

None

### 3 Test standard/s and references

Test standard	Date	Description
47 CFR Part 15		Title 47 of the Code of Federal Regulations; Chapter I; Part 15 - Radio frequency devices

Guidance	Version	Description
ANSI C63.4-2014	-/-	American national standard for methods of measurement of radio-noise emissions from low-voltage electrical and electronic equipment in the range of 9 kHz to 40 GHz
ANSI C63.10-2013	-/-	American national standard of procedures for compliance testing of unlicensed wireless devices
FCC Waiver DA21-814	-/-	FCC waiver for Acconeer pulse coherent radar
KDB publication 502150	D01	Certification Under Waiver v01
KDB guidance 996369	D01	Module Certification Guide v02

#### 4 Reporting statements of conformity – decision rule

Only the measured values related to their corresponding limits will be used to decide whether the equipment under test meets the requirements of the test standards listed in chapter 3.

The measurement uncertainty is mentioned in this test report, see chapter 9, but is not taken into account - neither to the limits nor to the measurement results. Measurement results with a smaller margin to the corresponding limits than the measurement uncertainty have a potential risk of more than 5% that the decision might be wrong."

measured value, measurement uncertainty, verdict

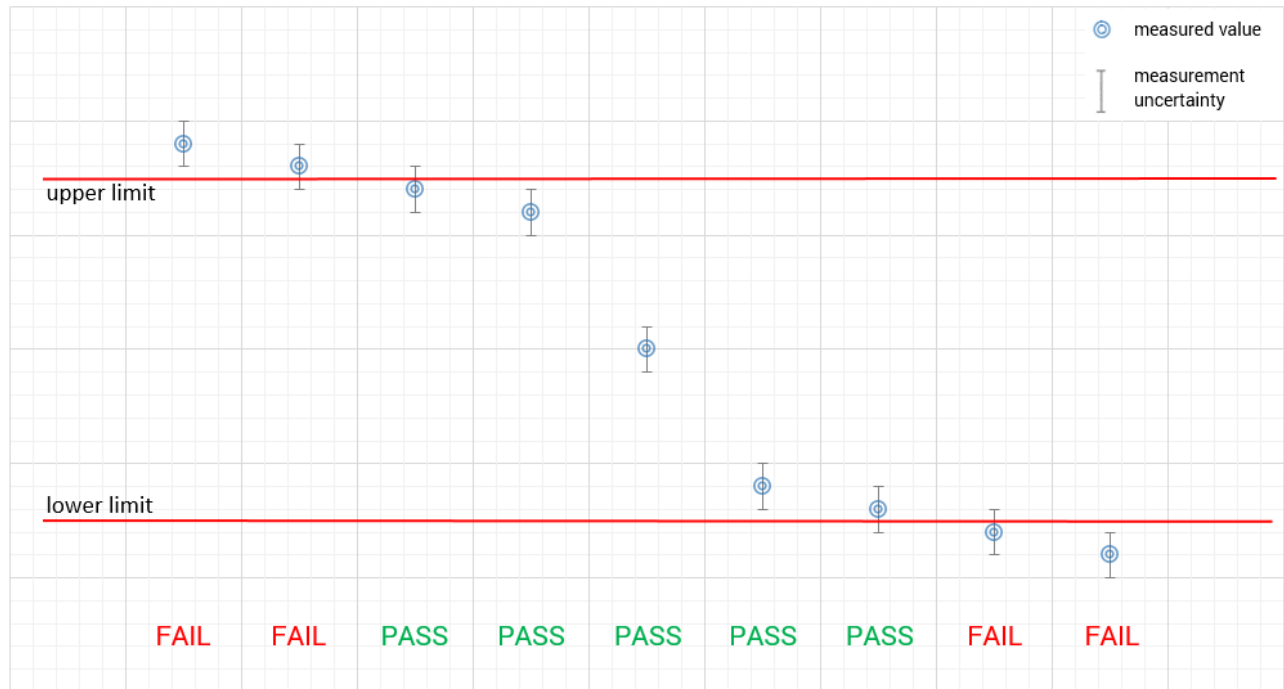

## 5 Test environment

Temperature	:	$T_{nom}$ $T_{max}$ $T_{min}$	+22 °C during room temperature tests +85 °C during high temperature tests -40 °C during low temperature tests
Relative humidity content	:		50 %
Barometric pressure	:		1010 hpa
Power supply	:	$V_{nom}$ $V_{max}$ $V_{min}$	1.8 V DC by external power supply 1.89 V 1.71 V

## 6 Test item

### 6.1 General description

Kind of test item	:	Module for SRD radar 60 GHz
Type identification	:	XR112 - LH112 - A111-003 Pulsed Coherent Radar
S/N serial number	:	10408
HW hardware status	:	A111-003
SW software status	:	2.8.3
Frequency band	:	57 GHz – 71 GHz
Type of modulation	:	Pulse Modulation
Number of channels	:	1
Antenna	:	2 embedded Dipole Antennas dielectric lens LH112
Power supply	:	1.71 V to 1.89 V DC
Auxiliary equipment	:	Raspberry Pi with connector board
Temperature range	:	-40°C to +85°C

### 6.2 Additional information

The content of the following annexes is defined in the QA. It may be that not all of the listed annexes are necessary for this report, thus some values in between may be missing.

Test setup- and EUT-photos are included in test report:

- 1-3720/21-01-01\_AnnexA
- 1-3720/21-01-01\_AnnexB
- 1-3720/21-01-01\_AnnexD

## 7 Description of the test setup

Typically, the calibrations of the test apparatus are commissioned to and performed by an accredited calibration laboratory. The calibration intervals are determined in accordance with the DIN EN ISO/IEC 17025. In addition to the external calibrations, the laboratory executes comparison measurements with other calibrated test systems or effective verifications. Weekly chamber inspections and range calibrations are performed. Where possible, RF generating and signaling equipment as well as measuring receivers and analyzers are connected to an external high-precision 10 MHz reference (GPS-based or rubidium frequency standard).

In order to simplify the identification of the equipment used at some special tests, some items of test equipment and ancillaries can be provided with an identifier or number in the equipment list below (Lab/Item).

### **Agenda:** Kind of Calibration

k	calibration / calibrated	EK	limited calibration
ne	not required (k, ev, izw, zw not required)	zw	cyclical maintenance (external cyclical maintenance)
ev	periodic self verification	izw	internal cyclical maintenance
Ve	long-term stability recognized	g	blocked for accredited testing
vlk!	Attention: extended calibration interval		
NK!	Attention: not calibrated	*)	next calibration ordered / currently in progress

### 7.1 Shielded semi anechoic chamber

The radiated measurements are performed in vertical and horizontal plane in the frequency range from 30 MHz to 1 GHz in semi-anechoic chambers. The EUT is positioned on a non-conductive support with a height of 0.80 m above a conductive ground plane that covers the whole chamber. The receiving antennas are conform to specifications ANSI C63. These antennas can be moved over the height range between 1.0 m and 4.0 m in order to search for maximum field strength emitted from EUT. The measurement distances between EUT and receiving antennas are indicated in the test setups for the various frequency ranges. For each measurement, the EUT is rotated in all three axes until the maximum field strength is received. The wanted and unwanted emissions are received by spectrum analyzers where the detector modes and resolution bandwidths over various frequency ranges are set according to requirement ANSI C63.

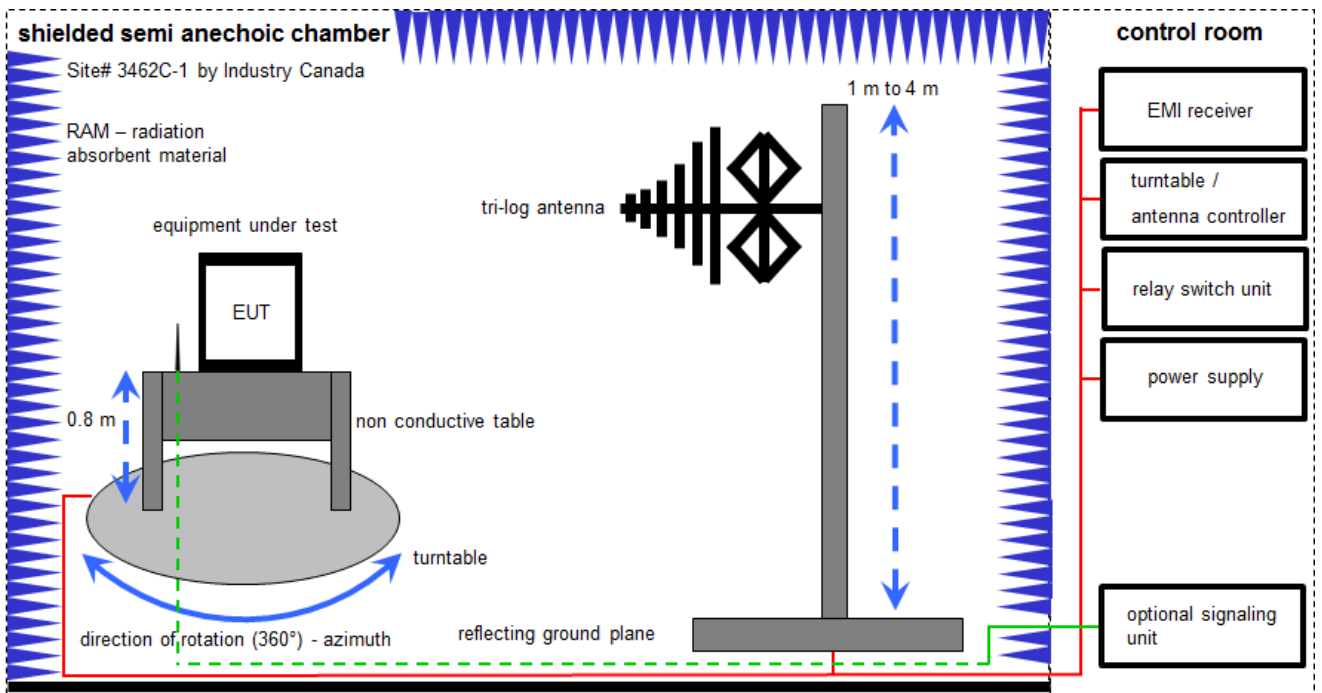

Measurement distance: tri-log antenna 10 meter  
EMC32 software version: 10.30.0

FS = UR + CL + AF  
(FS-field strength; UR-voltage at the receiver; CL-loss of the cable; AF-antenna factor)

Example calculation:  
FS [dBµV/m] = 12.35 [dBµV/m] + 1.90 [dB] + 16.80 [dB/m] = 31.05 [dBµV/m] (35.69 µV/m)

**Equipment table:**

No.	Lab / Item	Equipment	Type	Manufacturer	Serial No.	INV. No.	Kind of Calibration	Last Calibration	Next Calibration
1	n. a.	Switch-Unit	3488A	HP	2719A14505	300000368	ev	-/-	-/-
2	n. a.	DC power supply, 60Vdc, 50A, 1200 W	6032A	HP	2920A04466	300000580	ne	-/-	-/-
3	n. a.	Meßkabine 1	HF-Absorberhalle	MWB AG 300023		300000551	ne	-/-	-/-
4	n. a.	EMI Test Receiver	ESR3	Rohde & Schwarz	102587	300005771	k	08.12.2021	31.12.2022
5	n. a.	Antenna Tower	Model 2175	ETS-Lindgren	64762	300003745	izw	-/-	-/-
6	n. a.	Positioning Controller	Model 2090	ETS-Lindgren	64672	300003746	izw	-/-	-/-
7	n. a.	Turntable Interface-Box	Model 105637	ETS-Lindgren	44583	300003747	izw	-/-	-/-
8	n. a.	TRILOG Broadband Test-Antenna 30 MHz - 3 GHz	VULB9163	Schwarzbeck Mess - Elektronik	318	300003696	vKII	30.09.2021	29.09.2023



## 7.2 Shielded fully anechoic chamber

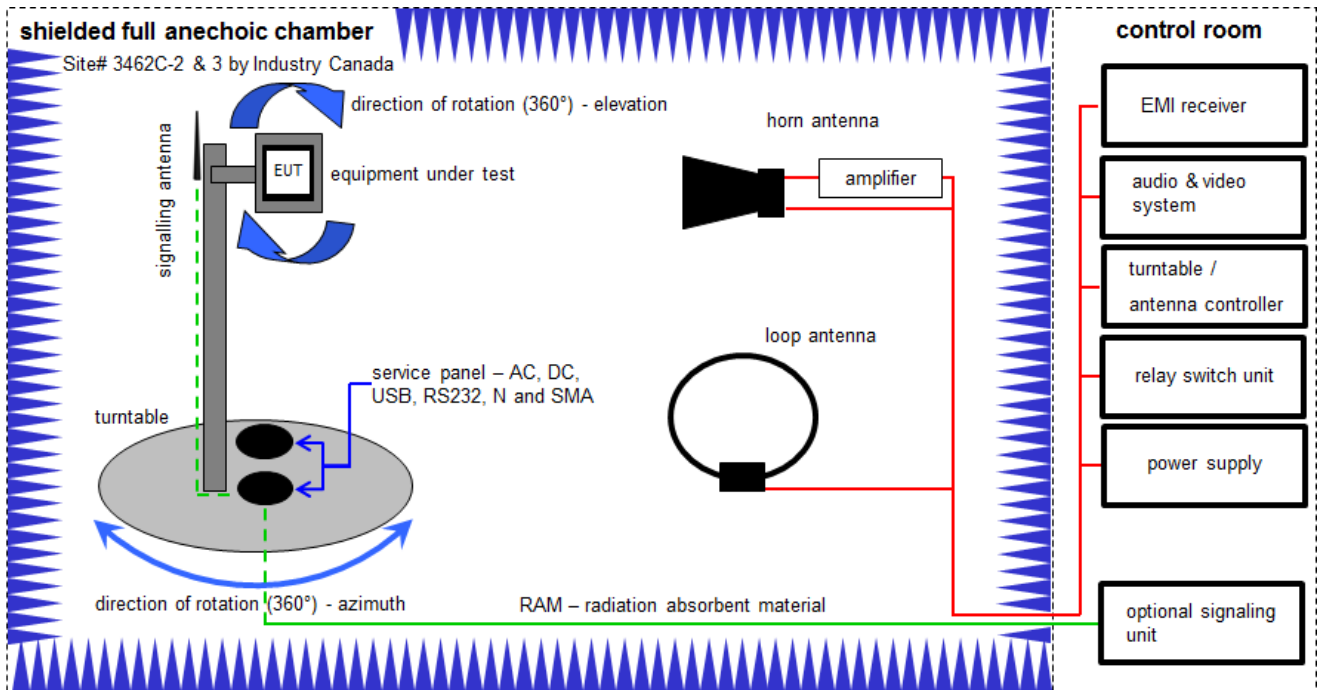

Measurement distance: horn antenna 3 meter; loop antenna 3 meter / 1 meter

$$FS = UR + CA + AF$$

(FS-field strength; UR-voltage at the receiver; CA-loss of the signal path; AF-antenna factor)

Example calculation:

$$FS [dB\mu V/m] = 40.0 [dB\mu V/m] + (-35.8) [dB] + 32.9 [dB/m] = 37.1 [dB\mu V/m] (71.61 \mu V/m)$$

### Equipment table:

No.	Lab / Item	Equipment	Type	Manufacturer	Serial No.	INV. No.	Kind of Calibration	Last Calibration	Next Calibration
1	n. a.	DC power supply, 60Vdc, 50A, 1200 W	6032A	HP	2818A03450	300001040	vKI!	09.12.2020	08.12.2023
2	n. a.	Active Loop Antenna 9 kHz to 30 MHz	6502	EMCO	2210	300001015	vKI!	13.06.2019	12.06.2022
3	n. a.	Anechoic chamber	FAC 3/5m	MWB / TDK	87400/02	300000996	ev	-/-	-/-
4	n. a.	TRILOG Broadband Test-Antenna 30 MHz - 3 GHz	VULB9163	Schwarzbeck Mess - Elektronik	371	300003854	vKI!	14.01.2020	13.01.2022
5	n. a.	Double-Ridged Waveguide Horn Antenna 1-18.0GHz	3115	EMCO	9107-3697	300001605	vKI!	12.03.2021	11.03.2023
6	n. a.	Switch / Control Unit	3488A	HP	*	300000199	ne	-/-	-/-
7	n. a.	Variable isolating transformer	MPL IEC625 Bus Variable isolating transformer	Erfi	91350	300001155	ne	-/-	-/-
8	n. a.	EMI Test Receiver 20Hz- 26,5GHz	ESU26	R&S	100037	300003555	k	09.12.2021	08.12.2022
9	n. a.	Highpass Filter	WHKX7.0/18G-8SS	Wainwright	19	300003790	ne	-/-	-/-
10	n. a.	Broadband Amplifier 0.5-18 GHz	CBLU5184540	CERNEX	22049	300004481	ev	-/-	-/-
11	n. a.	Broadband Amplifier 5-13 GHz	CBLU5135235	CERNEX	22010	300004491	ev	-/-	-/-
12	n. a.	4U RF Switch Platform	L4491A	Agilent Technologies	MY50000037	300004509	ne	-/-	-/-
13	n. a.	NEXIO EMV-Software	BAT EMC V3.16.0.49	EMCO		300004682	ne	-/-	-/-
14	n. a.	PC	ExOne	F+W		300004703	ne	-/-	-/-
15	n. a.	RF-Amplifier	AMF-6F06001800-30-10P-R	NARDA-MITEQ Inc	2011572	300005241	ev	-/-	-/-

### 7.3 Radiated measurements, 18 GHz – 50 GHz

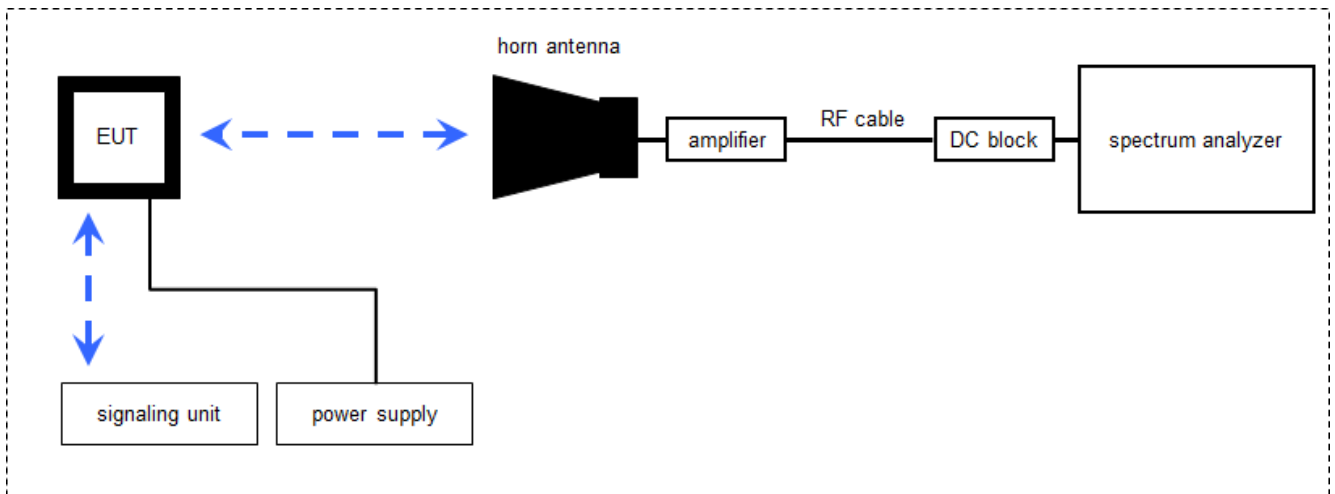

### 7.4 Radiated measurements > 50 GHz

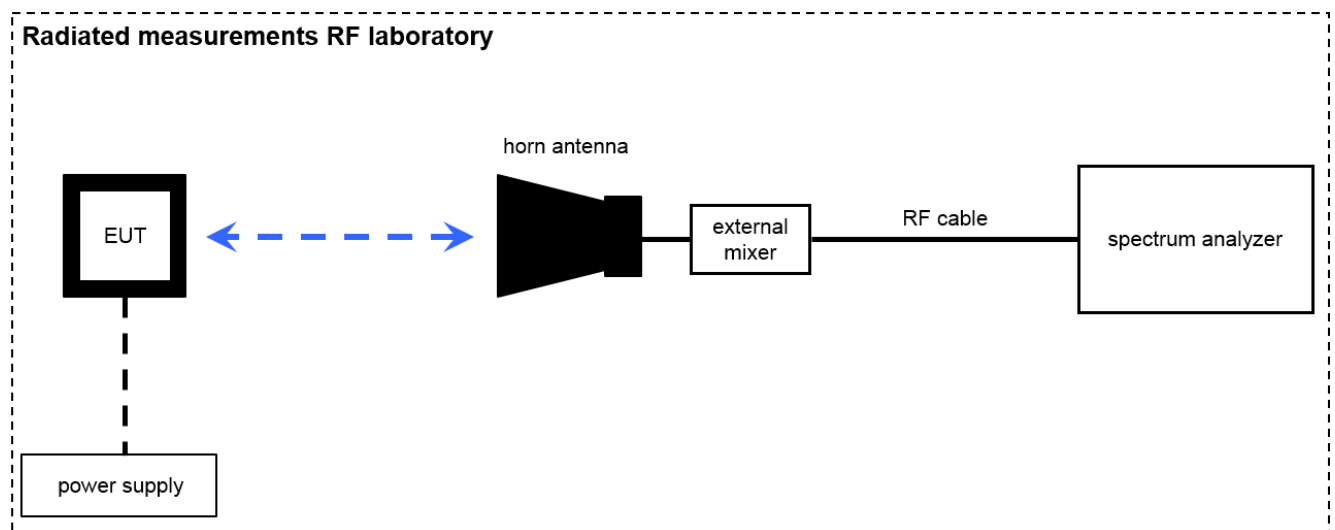

$$OP = AV + D - G$$

(OP-rad. output power; AV-analyzer value; D-free field attenuation of measurement distance; G-antenna gain)

Example calculation:

$$OP \text{ [dBm]} = -54.0 \text{ [dBm]} + 64.0 \text{ [dB]} - 20.0 \text{ [dBi]} = -10 \text{ [dBm]} \text{ (100 } \mu\text{W)}$$

Note: conversion loss of mixer is already included in analyzer value.

## 7.5 Radiated measurements > 50 GHz

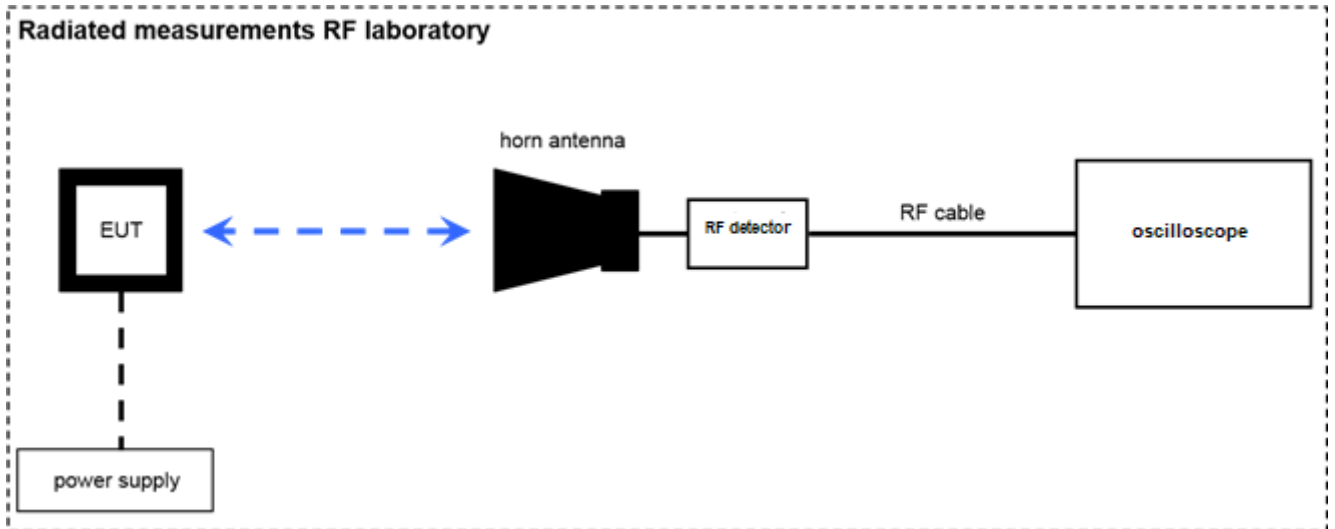

Note: EUT is replaced by reference source for substitution measurement

**Equipment table:**

No.	Lab / Item	Equipment	Type	Manufacturer	Serial No.	INV. No.	Kind of Calibration	Last Calibration	Next Calibration
1	n.a.	Horn Antenna 18.0-40.0 GHz	LHAF180	Microw.Devel	39180-103-021	300001747	√KII	18.02.2019	17.02.2022
2	n. a.	Std. Gain Horn Antenna 18.0-26.5 GHz	638	Narda		300000486	√KII	21.01.2020	20.01.2022
3	n. a.	Std. Gain Horn Antenna 26.5-40.0 GHz	V637	Narda	82-16	300000510	√KII	23.01.2020	22.01.2022
4	n.a.	Std. Gain Horn Antenna 33.0-50.1 GHz	2324-20	Flann	57	400000683	ne	-/-	-/-
5	n. a.	Std. Gain Horn Antenna 49.9-75.8 GHz	2524-20	Flann	*	300001983	ne	-/-	-/-
6	n. a.	Std. Gain Horn Antenna 60-90 GHz	COR 60_90	Thomson CSF		300000814	ev	-/-	-/-
7	n. a.	Std. Gain Horn Antenna 73.8-112 GHz	2724-20	Flann	*	300001988	ne	-/-	-/-
8	n.a.	Std. Gain Horn Antenna 92.3-140 GHz	2824-20	Flann		300001993	ne	-/-	-/-
9	n. a.	Std. Gain Horn Antenna 114-173 GHz	2924-20	Flann	*	300001999	ne	-/-	-/-
10	n. a.	Std. Gain Horn Antenna 145-220 GHz	3024-20	Flann	*	300002000	ne	-/-	-/-
11	n. a.	Broadband LNA 18-50 GHz	CBL18503070PN	CERNEX	25240	300004948	ev	09.03.2020	08.03.2022
12	n. a.	Harmonic Mixer 3-Port, 60-90 GHz	FS-Z90	R&S	102152	300006202	k	21.01.2021	20.01.2022
13	n.a.	Harmonic Mixer 3-port, 90-140 GHz	FS-Z140	Rohde & Schwarz	101119	300005581	k	22.07.2021	21.07.2022
14	n.a.	Harmonic Mixer 3-port, 75-110 GHz	FS-Z110	Rohde & Schwarz	101411	300004959	k	15.06.2021	14.06.2022
15	n.a.	Harmonic Mixer 3-port, 110-170 GHz	FS-Z170	Rohde & Schwarz	100014	300004156	k	11.06.2021	10.06.2022
16	n. a.	Harmonic Mixer 3-Port, 140-220 GHz	SAM-220	Radiometer Physics GmbH	200001	300004157	k	22.07.2021	21.07.2022
17	n.a.	Spectrum Analyzer 2 Hz - 85 GHz	FSW85	R&S	101333	300005568	k	30.06.2021	29.06.2022
18	n. a.	Climatic box	VT 4002	Heraeus Vötsch	58566046820010	300003019	ev	08.05.2020	07.05.2022
19	n.a.	Waveguide amplifier 50 to 75 GHz 30 dB Gain	AFB-V30LN-02	Ducommun	2K1701116	300005899	ev	-/-	-/-
20	n.a.	Thermal Power Sensor, DC-110GHz, 300nW-100mW	NRP-Z58	Rohde & Schwarz	100913	300004808	k	04.01.2022	31.01.2024
21	n.a.	SG Extension Module 50 – 75 GHz	E8257DV15	VDI	US54250124	300005541	ev	-/-	-/-
22	n.a.	Std. Gain Horn Antenna 50-75 GHz	COR 50_75	Thomson CSF		300000813	ev	-/-	-/-
23	n.a.	Std. Gain Horn Antenna 50-75 GHz	COR 50_75	Thomson CSF		300000813 -0001	ev	-/-	-/-
24	n.a.	RF Detector	SFD-503753- 15SF-P1	Eravant	07353-1	300006118	ev	-/-	-/-
25	n.a.	Oscilloscope	DPO5054	Tektronix	C010174	300004169	k	07.12.2021	31.12.2022
26	n.a.	Signal Generator	83640A	HP	3119A00458	300002266	√KII	10.12.2021	09.12.2022

## 8 Sequence of testing

### 8.1 Sequence of testing radiated spurious 9 kHz to 30 MHz

#### Setup

- The equipment is set up to simulate normal operation mode as described in the user manual or defined by the manufacturer.
- If the EUT is a tabletop system, it is placed on a table with 0.8 m height.
- If the EUT is a floor standing device, it is placed directly on the turn table.
- Auxiliary equipment and cables are positioned to simulate normal operation conditions as described in ANSI C 63.4.
- The AC power port of the EUT (if available) is connected to a power outlet below the turntable.
- Measurement distance is 3 m (see ANSI C 63.4) – see test details.
- EUT is set into operation.

#### Premeasurement\*

- The turntable rotates from 0° to 315° using 45° steps.
- The antenna height is 1 m.
- At each turntable position the analyzer sweeps with positive-peak detector to find the maximum of all emissions.

#### Final measurement

- Identified emissions during the pre-measurement are maximized by the software by rotating the turntable from 0° to 360°.
- Loop antenna is rotated about its vertical axis for maximum response at each azimuth about the EUT. (For certain applications, the loop antenna plane may also need to be positioned horizontally at the specified distance from the EUT)
- The final measurement is done in the position (turntable and elevation) causing the highest emissions with quasi-peak (as described in ANSI C 63.4).
- Final levels, frequency, measuring time, bandwidth, turntable position, correction factor, margin to the limit and limit will be recorded. A plot with the graph of the premeasurement and the limit is stored.

\*)Note: The sequence will be repeated three times with different EUT orientations.

## 8.2 Sequence of testing radiated spurious 30 MHz to 1 GHz

### Setup

- The equipment is set up to simulate normal operation mode as described in the user manual or defined by the manufacturer.
- If the EUT is a tabletop system, a table with 0.8 m height is used, which is placed on the ground plane.
- If the EUT is a floor standing device, it is placed on the ground plane with insulation between both.
- Auxiliary equipment and cables are positioned to simulate normal operation conditions as described in ANSI C 63.4.
- The AC power port of the EUT (if available) is connected to a power outlet below the turntable.
- Measurement distance is 10 m or 3 m (see ANSI C 63.4) – see test details.
- EUT is set into operation.

### Premeasurement

- The turntable rotates from 0° to 315° using 45° steps.
- The antenna is polarized vertical and horizontal.
- The antenna height changes from 1 m to 3 m.
- At each turntable position, antenna polarization and height the analyzer sweeps three times in peak to find the maximum of all emissions.

### Final measurement

- The final measurement is performed for at least six highest peaks according to the requirements of the ANSI C63.4.
- Based on antenna and turntable positions at which the peak values are measured the software maximize the peaks by changing turntable position  $\pm 45^\circ$  and antenna height between 1 and 4 m.
- The final measurement is done with quasi-peak detector (as described in ANSI C 63.4).
- Final levels, frequency, measuring time, bandwidth, antenna height, antenna polarization, turntable angle, correction factor, margin to the limit and limit are recorded. A plot with the graph of the premeasurement with marked maximum final results and the limit is stored.

### 8.3 Sequence of testing radiated spurious 1 GHz to 18 GHz

#### Setup

- The equipment is set up to simulate normal operation mode as described in the user manual or defined by the manufacturer.
- If the EUT is a tabletop system, a 2-axis positioner with 1.5 m height is used.
- If the EUT is a floor standing device, it is placed directly on the turn table.
- Auxiliary equipment and cables are positioned to simulate normal operation conditions as described in ANSI C 63.4.
- The AC power port of the EUT (if available) is connected to a power outlet below the turntable.
- Measurement distance is 3 m (see ANSI C 63.4) – see test details.
- EUT is set into operation.

#### Premeasurement

- The turntable rotates from 0° to 315° using 45° steps.
- The antenna is polarized vertical and horizontal.
- The antenna height is 1.5 m.
- At each turntable position and antenna polarization the analyzer sweeps with positive peak detector to find the maximum of all emissions.

#### Final measurement

- The final measurement is performed for at least six highest peaks according to the requirements of the ANSI C63.4.
- Based on antenna and turntable positions at which the peak values are measured the software maximizes the peaks by rotating the turntable from 0° to 360°. This measurement is repeated for different EUT-table positions (0° to 150° in 30°-steps) and for both antenna polarizations.
- The final measurement is done in the position (turntable, EUT-table and antenna polarization) causing the highest emissions with Peak and RMS detector (as described in ANSI C 63.4).
- Final levels, frequency, measuring time, bandwidth, turntable position, EUT-table position, antenna polarization, correction factor, margin to the limit and limit are recorded. A plot with the graph of the premeasurement with marked maximum final results and the limit is stored.

## 8.4 Sequence of testing radiated spurious above 18 GHz

### Setup

- The equipment is set up to simulate normal operation mode as described in the user manual or defined by the manufacturer.
- Auxiliary equipment and cables are positioned to simulate normal operation conditions as described in ANSI C 63.4.
- The AC power port of the EUT (if available) is connected to a power outlet.
- The measurement distance is as appropriate (e.g. 0.5 m).
- The EUT is set into operation.

### Premeasurement

- The test antenna is handheld and moved carefully over the EUT to cover the EUT's whole sphere and different polarizations of the antenna.

### Final measurement

- The final measurement is performed at the position and antenna orientation causing the highest emissions with Peak and RMS detector (as described in ANSI C 63.4).
- Final levels, frequency, measuring time, bandwidth, correction factor, margin to the limit and limit are recorded. A plot with the graph of the premeasurement and the limit is stored.



## 8.5 Sequence of testing radiated spurious above 50 GHz with external mixers

### Setup

- The equipment is set up to simulate normal operation mode as described in the user manual or defined by the manufacturer.
- Auxiliary equipment and cables are positioned to simulate normal operation conditions as described in ANSI C 63.4.
- The AC power port of the EUT (if available) is connected to a power outlet.
- The measurement distance is as appropriate for far field (e.g. 0.25 m).
- The EUT is set into operation.

### Premeasurement

- The test antenna with external mixer is handheld and moved carefully over the EUT to cover the EUT's whole sphere and different polarizations of the antenna.
- Caution is taken to reduce the possible overloading of the external mixer.

### Final measurement

- The final measurement is performed at the position and antenna orientation causing the highest emissions with Peak and RMS detector (as described in ANSI C 63.4).
- As external mixers may generate false images care is taken to ensure that any emission measured by the spectrum analyzer does indeed originate in the EUT. Signal identification feature of spectrum analyzer is used to eliminate false mixer images (i.e., it is not the fundamental emission or a harmonic falling precisely at the measured frequency).
- Final levels, frequency, measuring time, bandwidth, correction factor, margin to the limit and limit are recorded. A plot with the graph of the premeasurement and the limit is stored.

## 9 Measurement uncertainty

Test case	Uncertainty
Permitted range of operating frequencies	± 100 kHz
Conducted unwanted emissions in the spurious domain (up to 40 GHz)	± 1 dB
Radiated unwanted emissions in the spurious domain (up to 40 GHz)	± 3 dB
Conducted unwanted emissions in the spurious domain (40 to 50 GHz)	± 4 dB
Radiated unwanted emissions in the spurious domain (40 to 50 GHz)	± 4 dB
Conducted unwanted emissions in the spurious domain (50 to 300 GHz)	± 5 dB
Radiated unwanted emissions in the spurious domain (50 to 300 GHz)	± 5 dB
DC and low frequency voltages	± 3 %
Temperature	± 1 °C
Humidity	± 3 %

## 10 Far field consideration for measurements above 18 GHz

### Far field distance calculation:

$$D_{ff} = 2 \times D^2 / \lambda$$

with

$D_{ff}$  Far field distance  
 $D$  Antenna dimension  
 $\lambda$  wavelength

### Spurious emission measurements:

Antenna frequency range in GHz	Highest measured frequency in GHz	D in cm	$\lambda$ in cm	$D_{ff}$ in cm
18-26	26	3.4	1.15	20.04
26-40	40	2.2	0.75	12.91
40-50	50	2.77	0.60	25.58
50-75	75	1.85	0.40	17.11
75-110	110	1.24	0.27	11.28
110-170	170	0.85	0.18	8.19
170-220	220	0.68	0.14	6.78

### In band measurement (EIRP, OBW):

Antenna frequency range in GHz	Highest measured frequency in GHz	Antenna dimension in cm	Wavelength in cm	far field distance in cm
50-75	64	1.85	0.47	14.6

## 11 Summary of measurement results

<input checked="" type="checkbox"/>	No deviations from the technical specifications were ascertained
<input type="checkbox"/>	There were deviations from the technical specifications ascertained

TC Identifier	Description	Verdict	Date	Remark
RF-Testing	FCC 47 CFR Part 15	Passed	2022-01-28	-/-

Test specification clause	Test case	Temperature conditions	Power supply	Pass	Fail	NA	NP	Results (max.)
§15.215(c)	Occupied bandwidth (20dB bandwidth)	Nominal	Nominal	<input checked="" type="checkbox"/>	<input type="checkbox"/>	<input type="checkbox"/>	<input type="checkbox"/>	complies
§15.255(c)(3) waived by DA21-814	Maximum E.I.R.P.	Nominal	Nominal	<input checked="" type="checkbox"/>	<input type="checkbox"/>	<input type="checkbox"/>	<input type="checkbox"/>	complies
§15.255(d)	Spurious Emissions	Nominal	Nominal	<input checked="" type="checkbox"/>	<input type="checkbox"/>	<input type="checkbox"/>	<input type="checkbox"/>	complies
§15.255(f)	Frequency stability	Nominal	Nominal	<input checked="" type="checkbox"/>	<input type="checkbox"/>	<input type="checkbox"/>	<input type="checkbox"/>	complies

**Note:** NA = Not Applicable; NP = Not Performed

## 12 Measurement results

### 12.1 Occupied bandwidth

**Description:**

Measurement of the Bandwidth of the wanted signal.

**Measurement:**

Measurement parameter	
Detector:	Peak
Sweep time:	10 s
Resolution bandwidth:	50 MHz
Video bandwidth:	80 MHz
Span:	9 GHz
Trace-Mode:	Max Hold

**Limits:**

FCC
CFR Part 15.255
The occupied bandwidth from intentional radiators operated within the specified frequency band shall comply with the following:
Frequency range
57 GHz – 71 GHz 57 GHz – 64 GHz according to FCC Waiver DA 21-814

**Measurement results:**

Test condition $T_{nom} / V_{nom}$	$F_L$ in GHz	$F_H$ in GHz	Occupied bandwidth in GHz
99% OBW	59.580010	62.74292	3.162
20 dB OBW	59.723080	62.27620	2.550
Measurement uncertainty	± span/1000		

**Result:** The measurement is passed.

Plot 1: 99% OBW

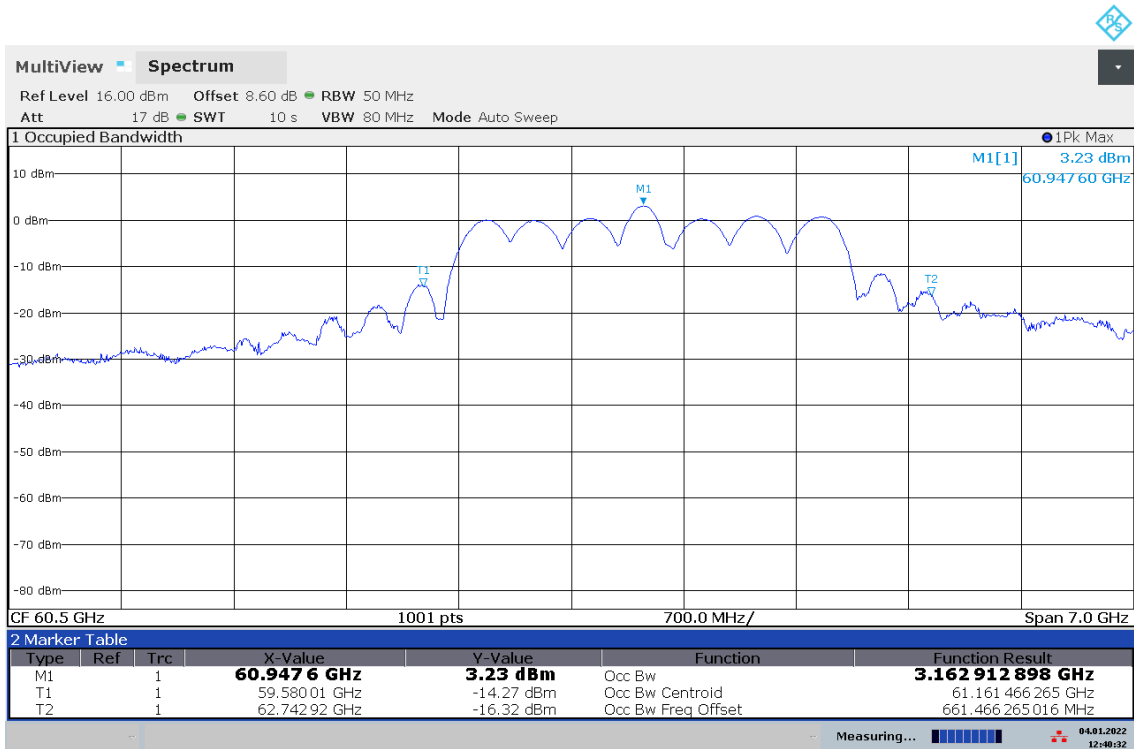

12:40:33 04.01.2022

Plot 2: 20 dB OBW

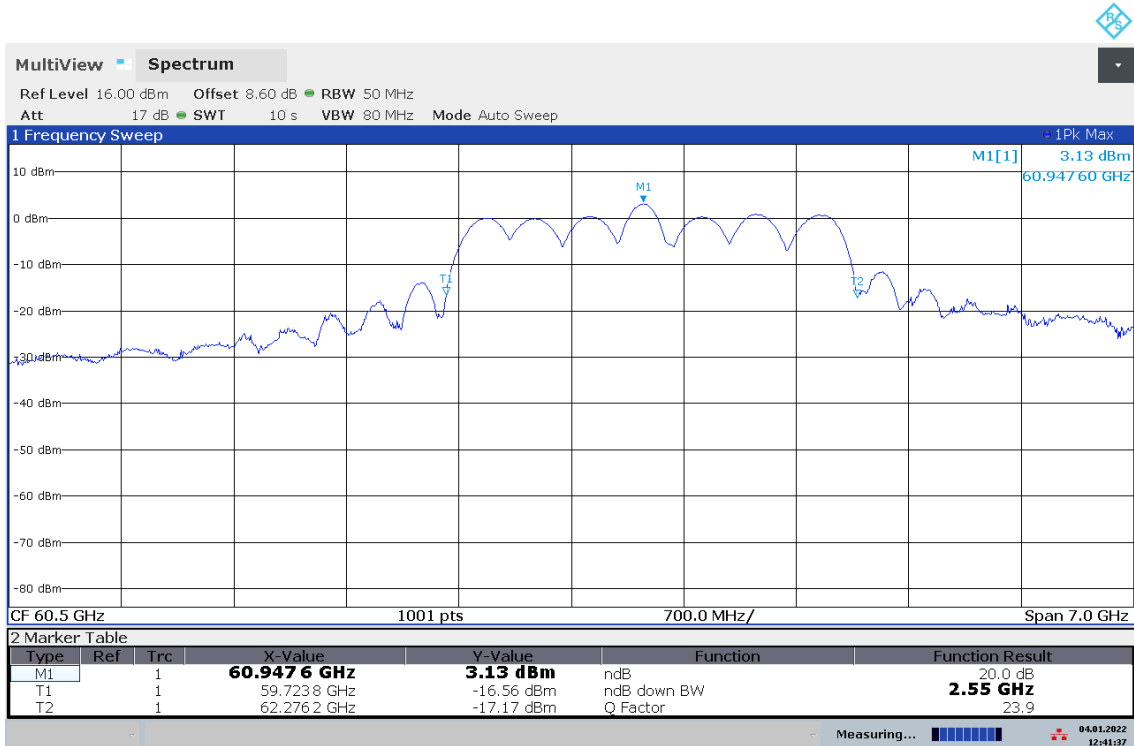

12:41:37 04.01.2022

## 12.2 Maximum E.I.R.P. / Transmitter Output Power

### Description:

Measurement of the maximum radiated e.i.r.p. of the wanted signal.

### Limits:

**FCC Part 15.255**

The requirements of Part 15.255 for field disturbance sensors have been waived by waiver DA21-814 as follows:

- 5% duty cycle, evaluated in 0.125  $\mu$ s time-averaged windows
- 3 dBm average EIRP evaluated in 0.125  $\mu$ s time-averaged windows
- Pulse duration not to exceed 6 ns

### Measurement:

Measurement parameter	
Detector:	Pos-Peak (RF-Detector)
Video bandwidth:	10 MHz
Trace-Mode:	Max Hold

### Measurement results:

Test condition	Average E.I.R.P. 10 MHz VBW
T <sub>nom</sub> / V <sub>nom</sub>	with Lens: 2.7 dBm
T <sub>nom</sub> / V <sub>nom</sub>	without Lens: -2.5 dBm
Measurement uncertainty	$\pm$ 3 dB

**Result: The measurement is passed.**

**Determination of longest pulse duration:**

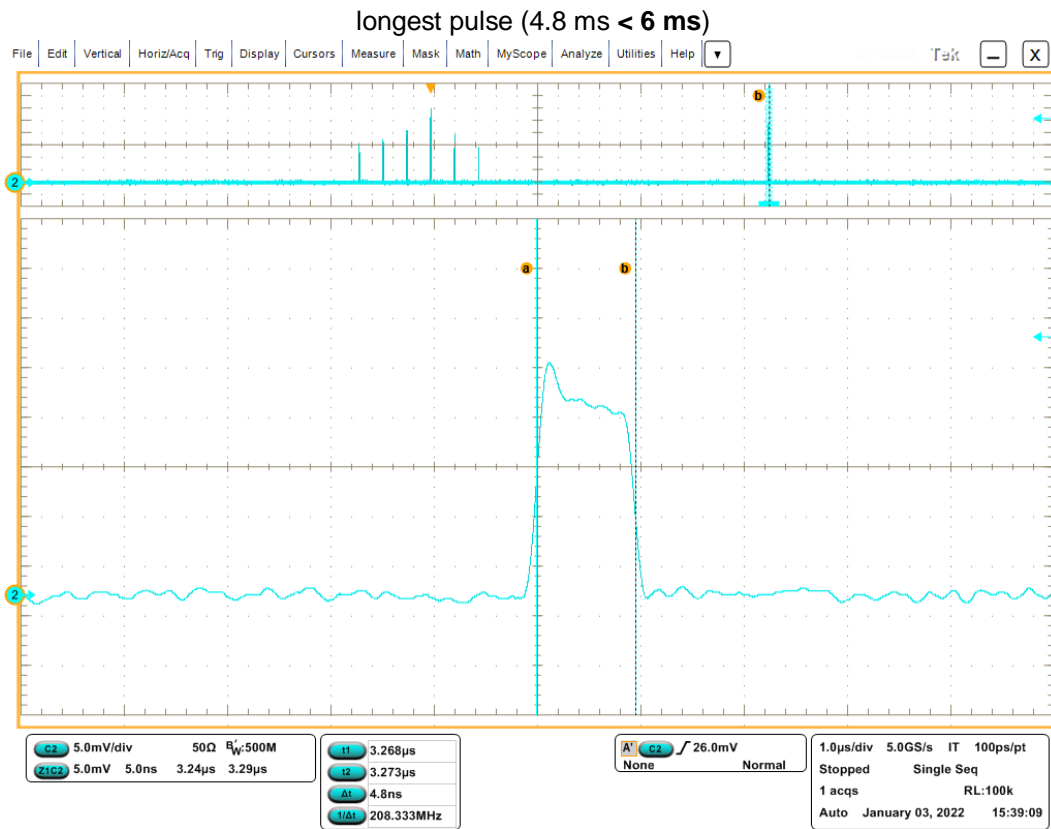

**Note:**

longest pulse duration: 4.8 ns (< 6 ns)

duty cycle within 125 ns:  $4.8 \text{ ns} / 125 \text{ ns} = 3.84\%$

### 12.2.1 Set-up of radiated RF-detector- and power measurement:

RF-detector with V-band amplifier (measured peak value at 1 m: approx. 100 mV)

EUT position:

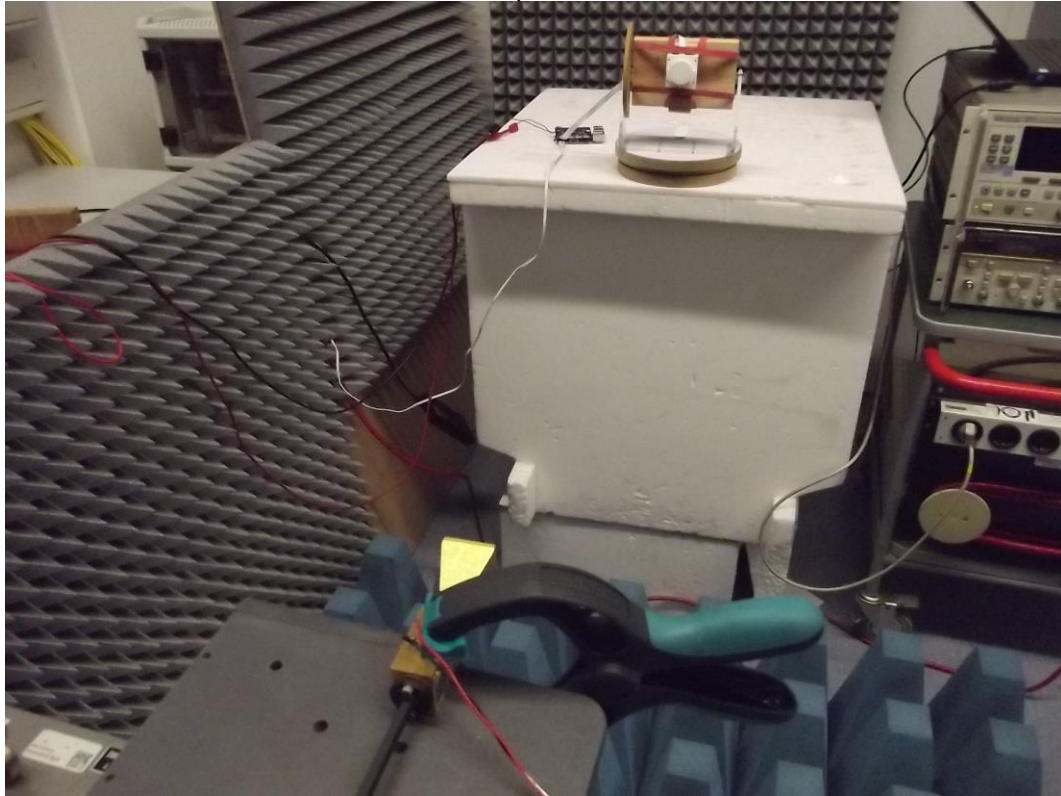



Result with lens:

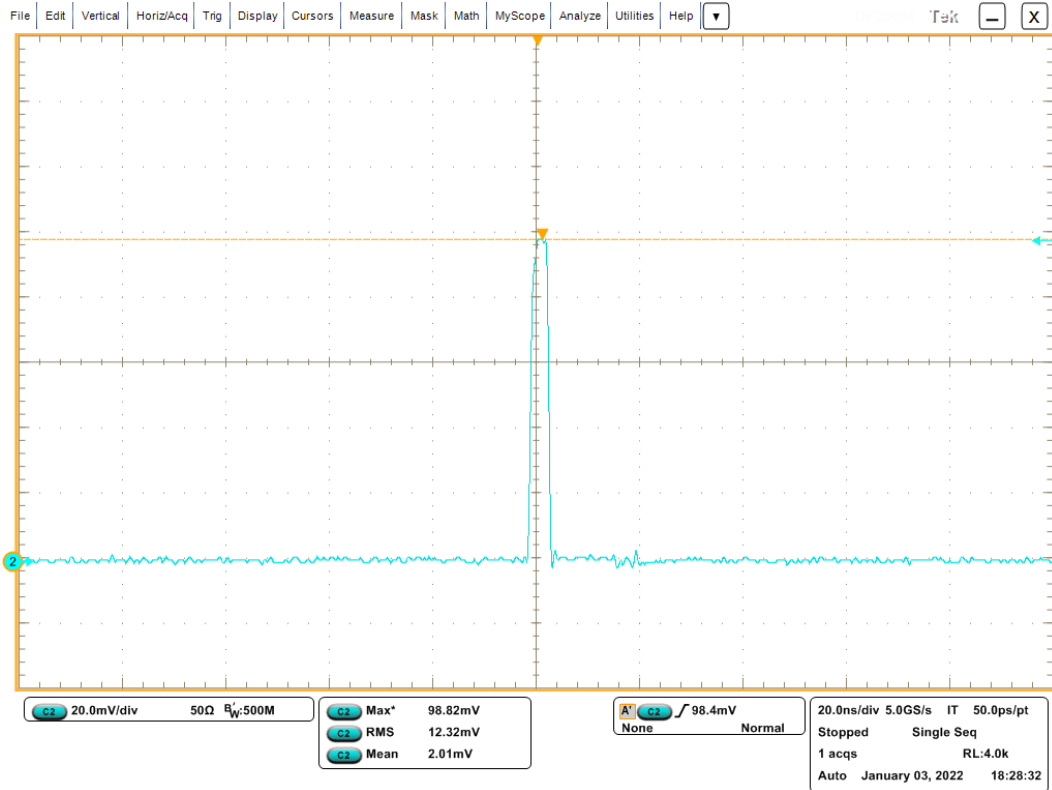

Result without lens:

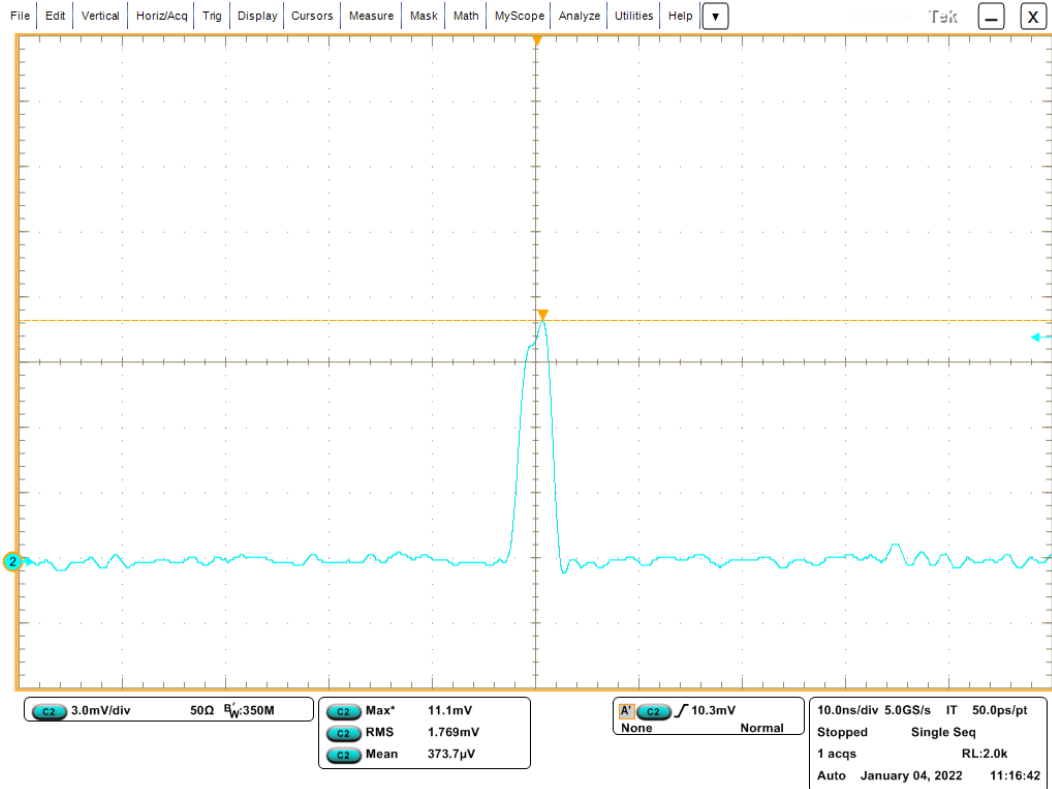

Replacement of EUT by reference source:

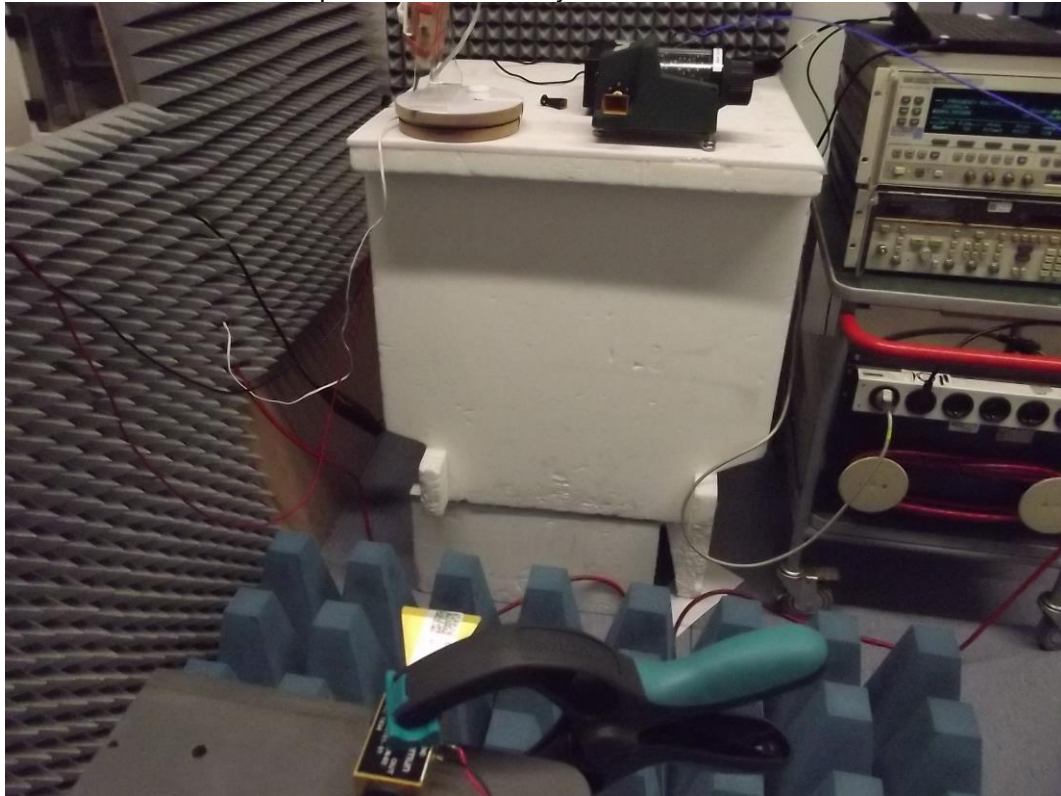

Substitution (average value with lens)

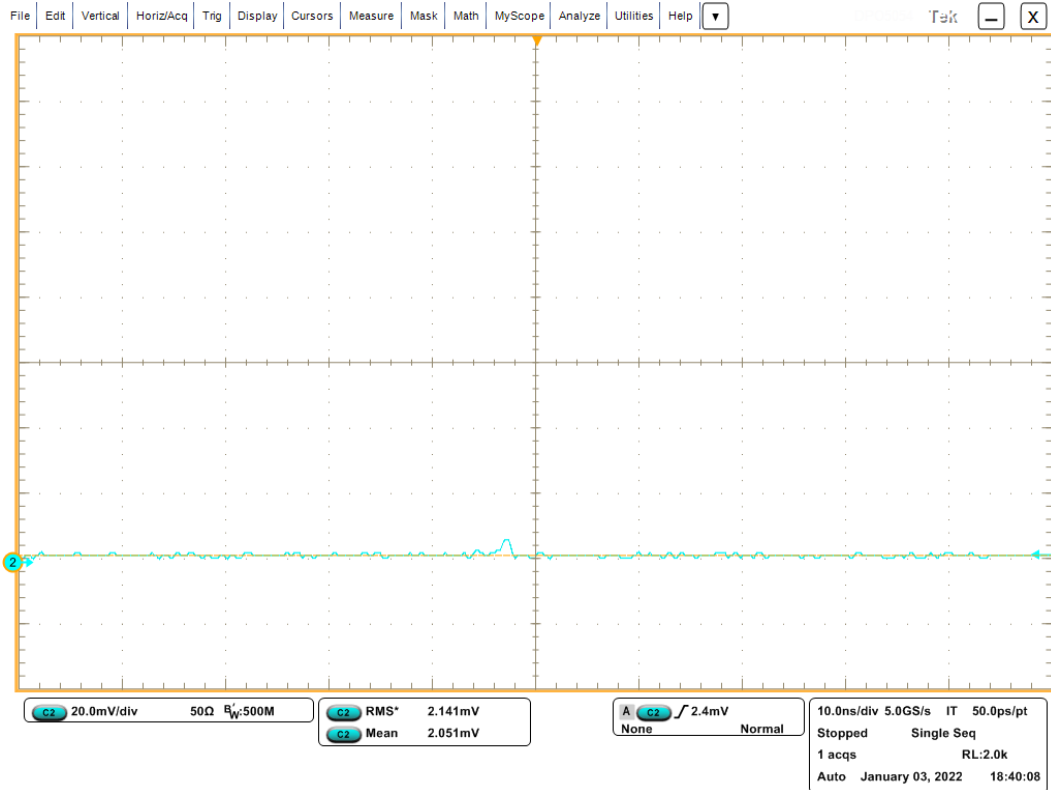

Substitution (average value without lens)

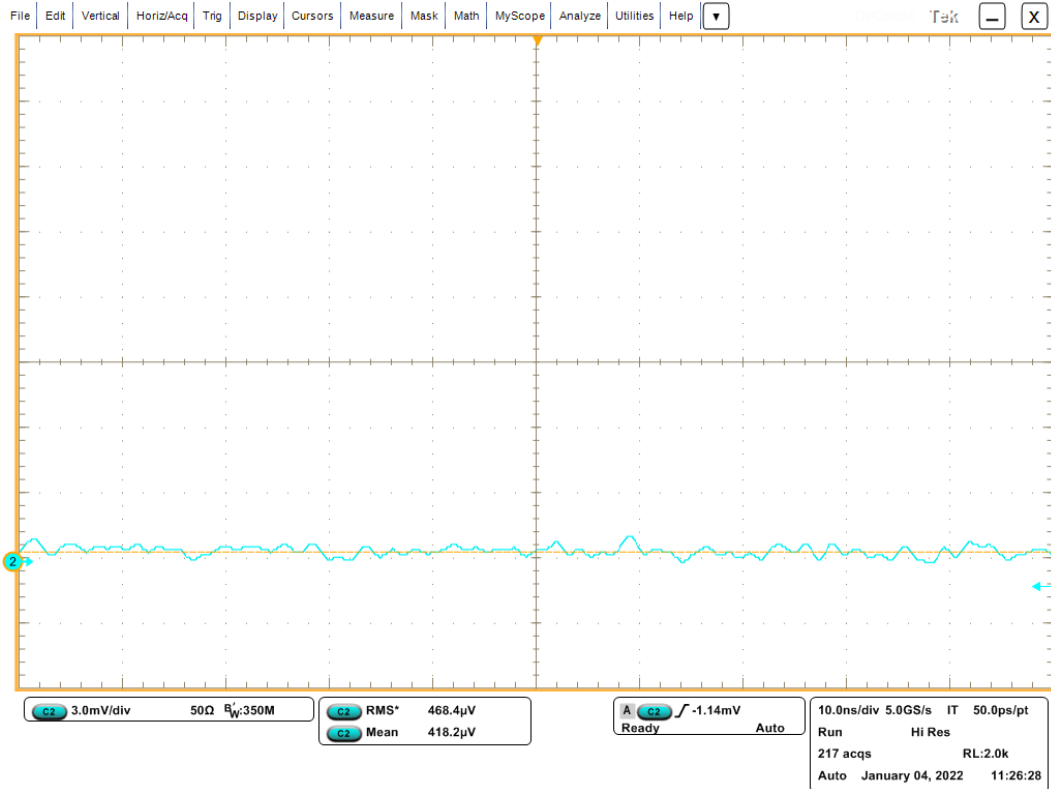

Attenuation of rotary attenuator to align voltage levels at oscilloscope:

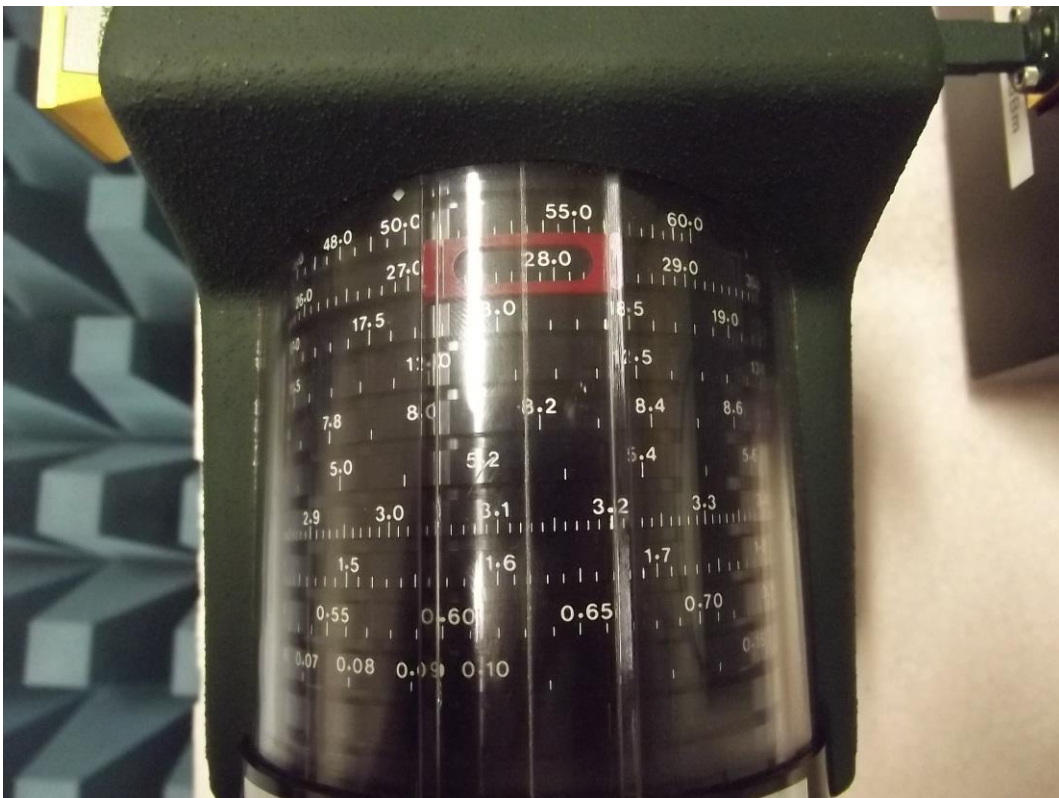
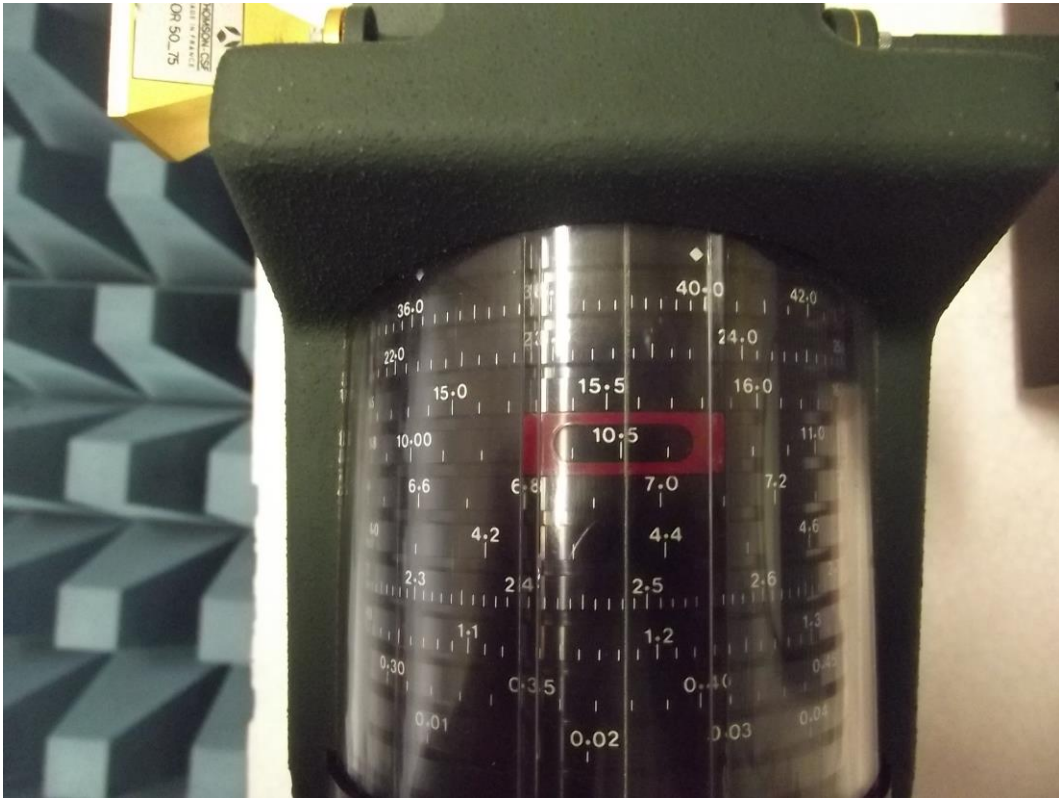

EIRP substitution measurement for determining average EIRP:

Measurement:	with Lens	Note:
Readout average (mean) value of oscilloscope at 1 m with EUT	2 mV	
EIRP of reference source at 1 m	40.5 dBm	Multiplier: ~20 dB; Horn 20.4 dBi Readout value of power sensor adjusted by far field attenuation
fix attenuation added	-10 dB	
rotary attenuator setting to reach peak voltage value of EUT with detector	-27.8 dB	adjusted to oscilloscope readout value of EUT
Average EIRP of EUT	<b>2.7 dBm</b>	

Readout average (mean) value of oscilloscope at 1 m with EUT	0.4 mV	
EIRP of reference source at 1 m	40.5 dBm	Multiplier: ~20 dB; Horn 20.4 dBi Readout value of power sensor adjusted by far field attenuation
fix attenuation added	-10 dB	
rotary attenuator setting to reach peak voltage value of EUT with detector	-33 dB	adjusted to oscilloscope readout value of EUT
Average EIRP of EUT	<b>-2.5 dBm</b>	

## 12.3 Spurious emissions radiated

### Description:

Measurement of the radiated spurious emissions in transmit mode.

### Limits:

**FCC Part 15.255**

(c) Limits on spurious emissions:

- (1) The power density of any emissions outside the 57-71 GHz band shall consist solely of spurious emissions.
- (2) Radiated emissions below 40 GHz shall not exceed the general limits in §15.209.
- (3) Between 40 GHz and 200 GHz, the level of these emissions shall not exceed 90 pW/cm<sup>2</sup> (-10dBm) at a distance of 3 meters.
- (4) The levels of the spurious emissions shall not exceed the level of the fundamental emission.

FCC		
CFR Part 15.209(a)		
Radiated Spurious Emissions		
Frequency (MHz)	Field Strength (dBµV/m)	Measurement distance
0.009 – 0.490	2400/F(kHz)	300
0.490 – 1.705	24000/F(kHz)	30
1.705 – 30.0	30	30
30 – 88	30.0	10
88 – 216	33.5	10
216 – 960	36.0	10
Above 960	54.0	3

**Limit conversion:**

$$P[\text{dBm}] = 10 \times \log(4 \times \pi \times d^2 \times P[\text{W}/\text{m}^2])$$

d = distance of the limit defined in W/m<sup>2</sup>

With this calculation an emission limit of 90 pW/cm<sup>2</sup> corresponds to -10 dBm.

**Measurement:**

Measurement parameter	
Detector:	Peak / Quasi Peak
Sweep time:	Auto
Resolution bandwidth:	F < 1 GHz: 100 kHz F > 1 GHz: 1 MHz
Video bandwidth:	Auto
Frequency range:	30 MHz to 100 GHz
Trace-Mode:	Max Hold

Measurement distance for measurements above 18 GHz	
Frequency range in GHz	Distance in m
18-26.5	0.2
26.5-40	0.2
40-50	0.2
50-75	0.2
75-110	0.1
110-170	0.1
170-220	0.1

**Result:** The measurement is passed.

Plot 3: 9 kHz – 30 MHz, horizontal / vertical polarization

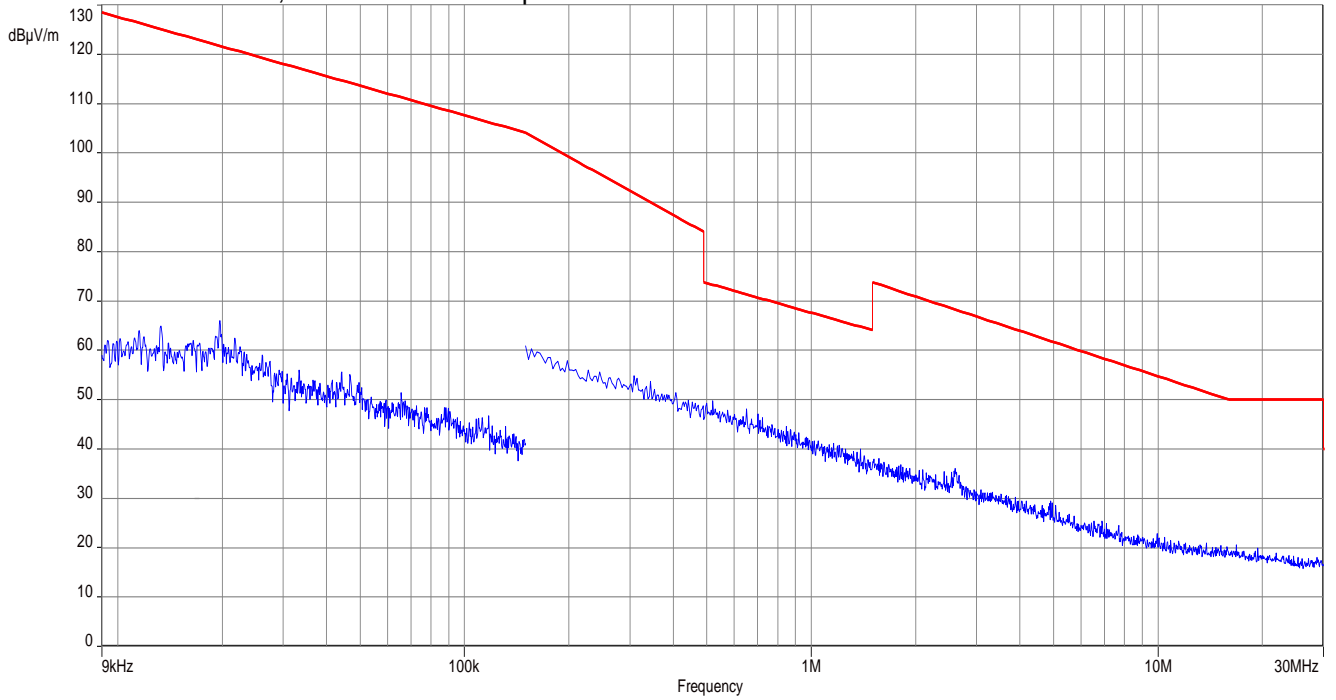



Plot 4: 30 MHz – 1 GHz, horizontal / vertical polarization

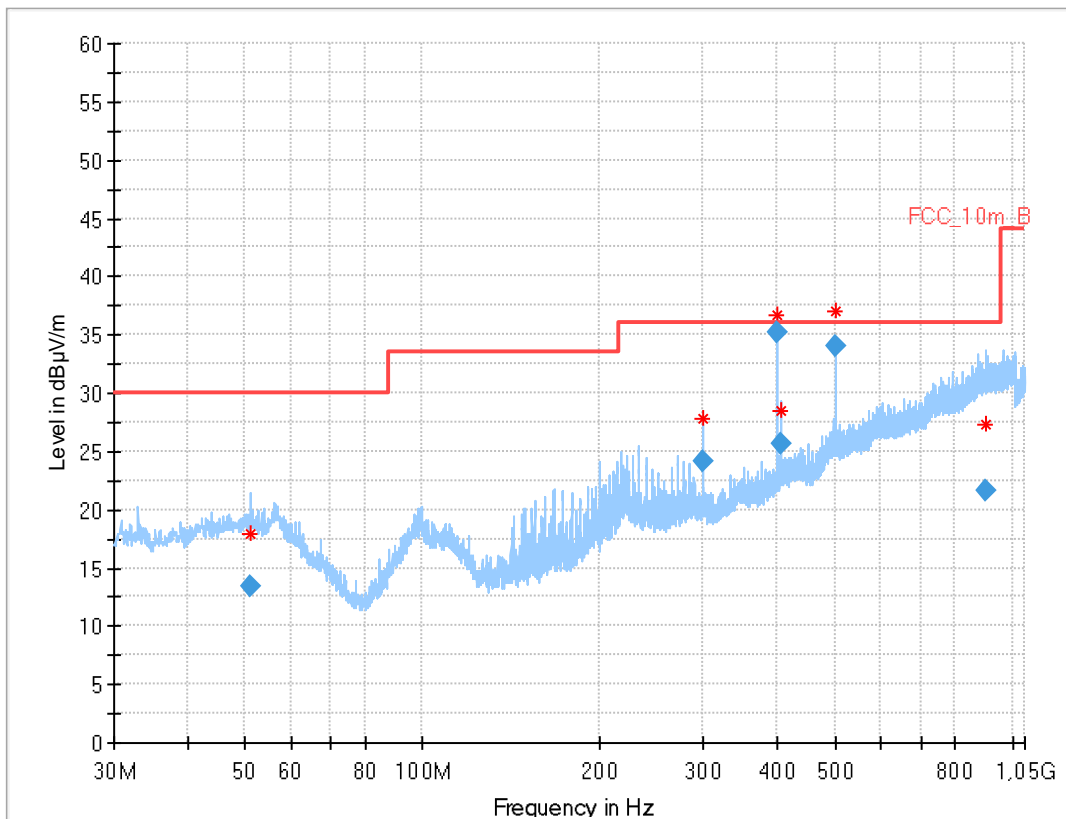

## Final Result

Frequency (MHz)	QuasiPeak (dBµV/m)	Limit (dBµV/m)	Margin (dB)	Meas. Time (ms)	Bandwidth (kHz)	Height (cm)	Pol	Azimuth (deg)	Corr. (dB/m)
51.144	13.40	30.0	16.6	1000	120.0	206.0	V	215	15
299.994	24.16	36.0	11.8	1000	120.0	118.0	V	-14	15
400.007	35.26	36.0	0.7	1000	120.0	104.0	V	326	18
403.999	25.64	36.0	10.4	1000	120.0	100.0	V	193	18
499.996	34.08	36.0	1.9	1000	120.0	200.0	H	131	20
901.603	21.57	36.0	14.4	1000	120.0	400.0	H	90	26

Plot 5: 1 GHz – 18 GHz, horizontal / vertical polarization

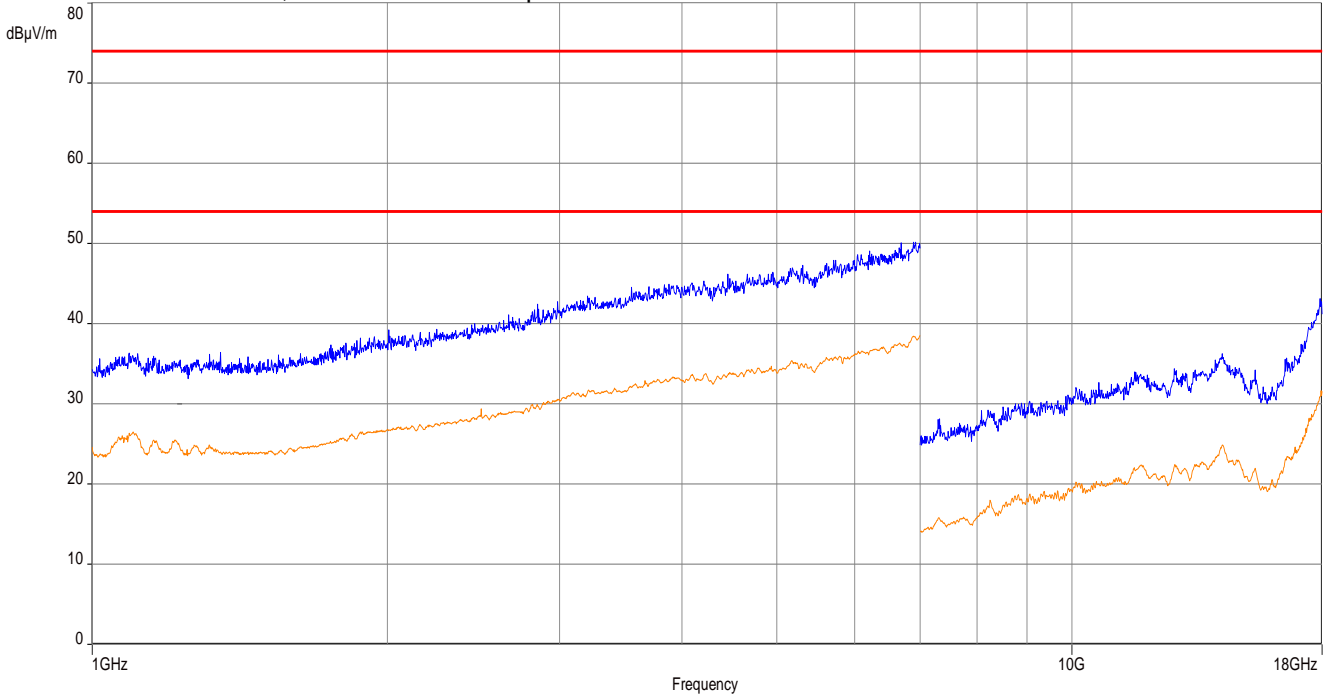

Plot 6: 18 GHz – 40 GHz, horizontal / vertical polarization

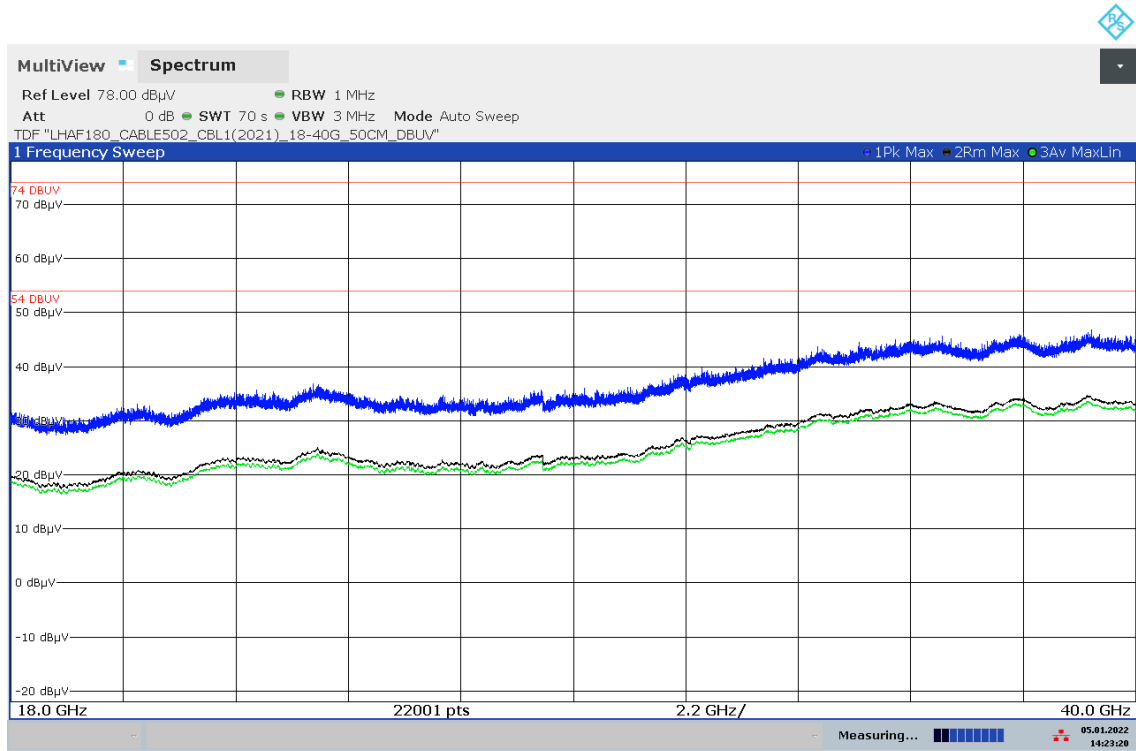

14:23:20 05.01.2022

Plot 7: 40 GHz – 50 GHz, antenna vertical / horizontal

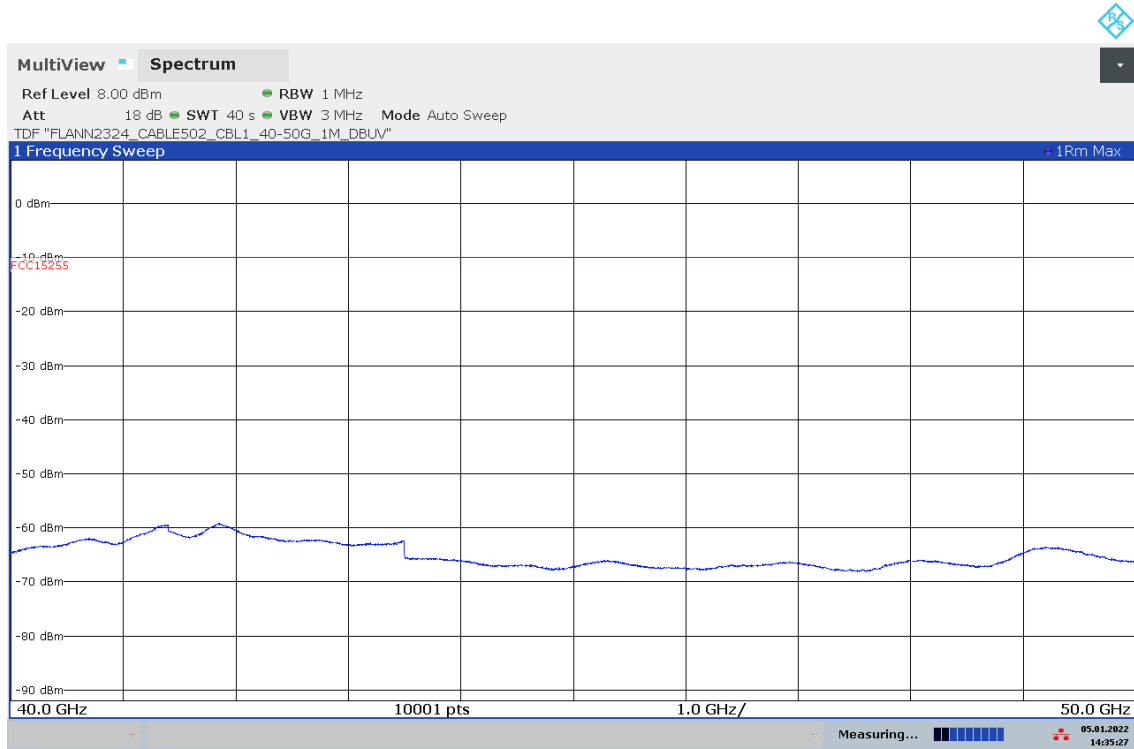

14:35:27 05.01.2022

Plot 8: Out of Band 50 GHz – 57 GHz, antenna vertical / horizontal.

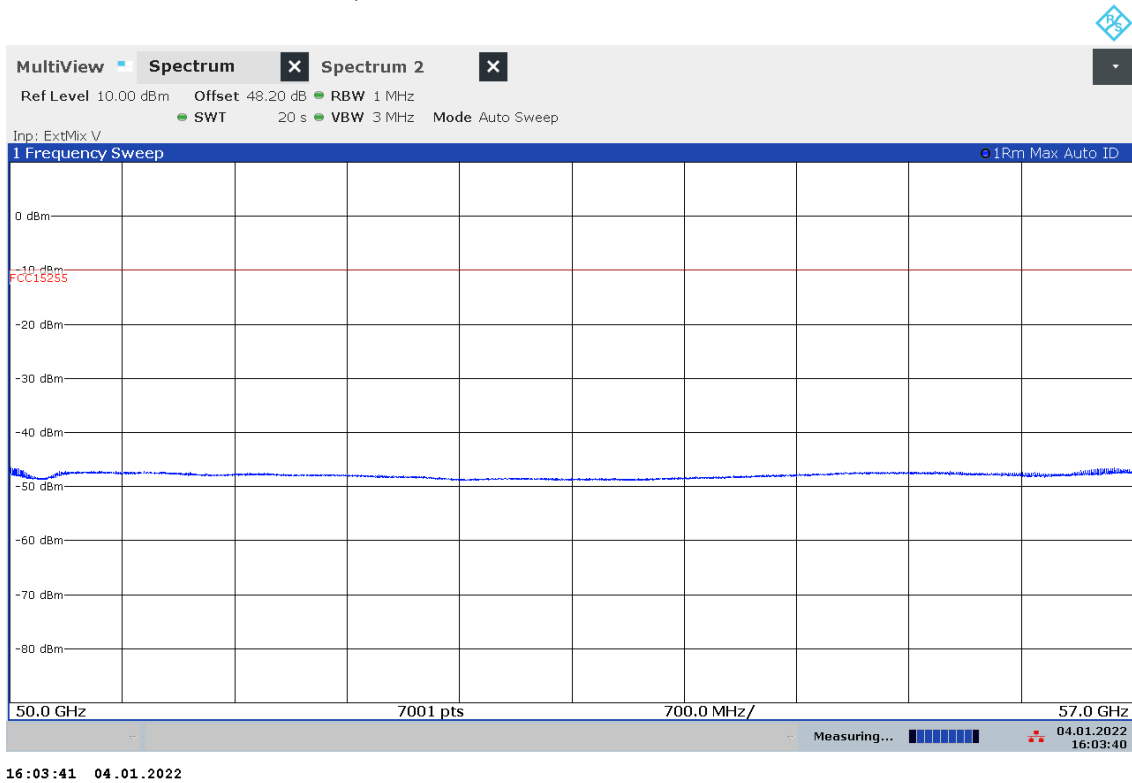

Plot 9: Out of Band 64 GHz – 75 GHz, antenna vertical / horizontal.

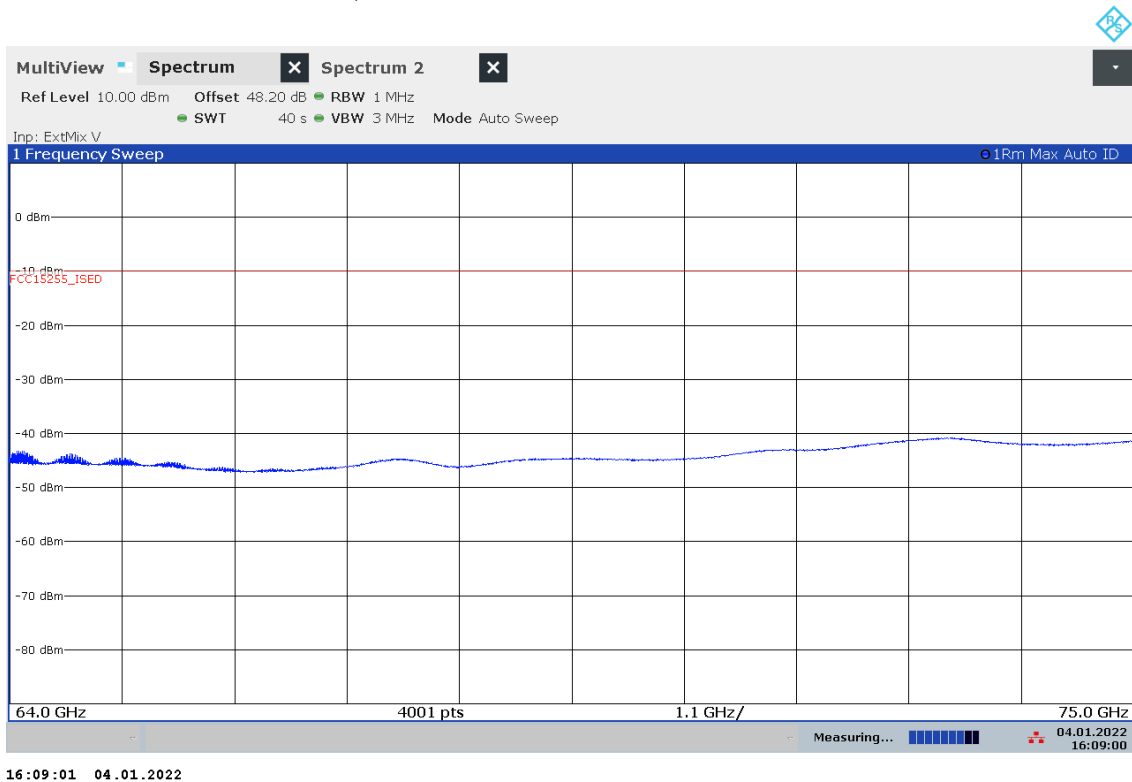

Plot 10: 75 GHz – 110 GHz, antenna vertical / horizontal

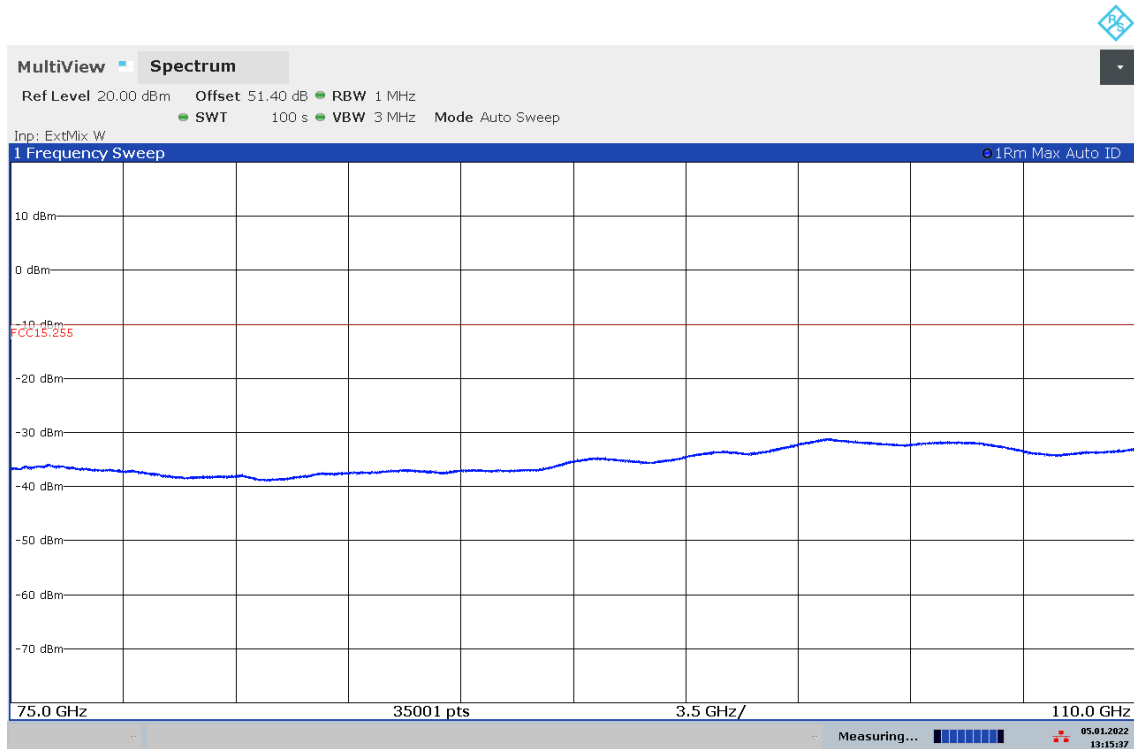

13:15:38 05.01.2022

Plot 11: 110 GHz – 140 GHz, antenna vertical / horizontal

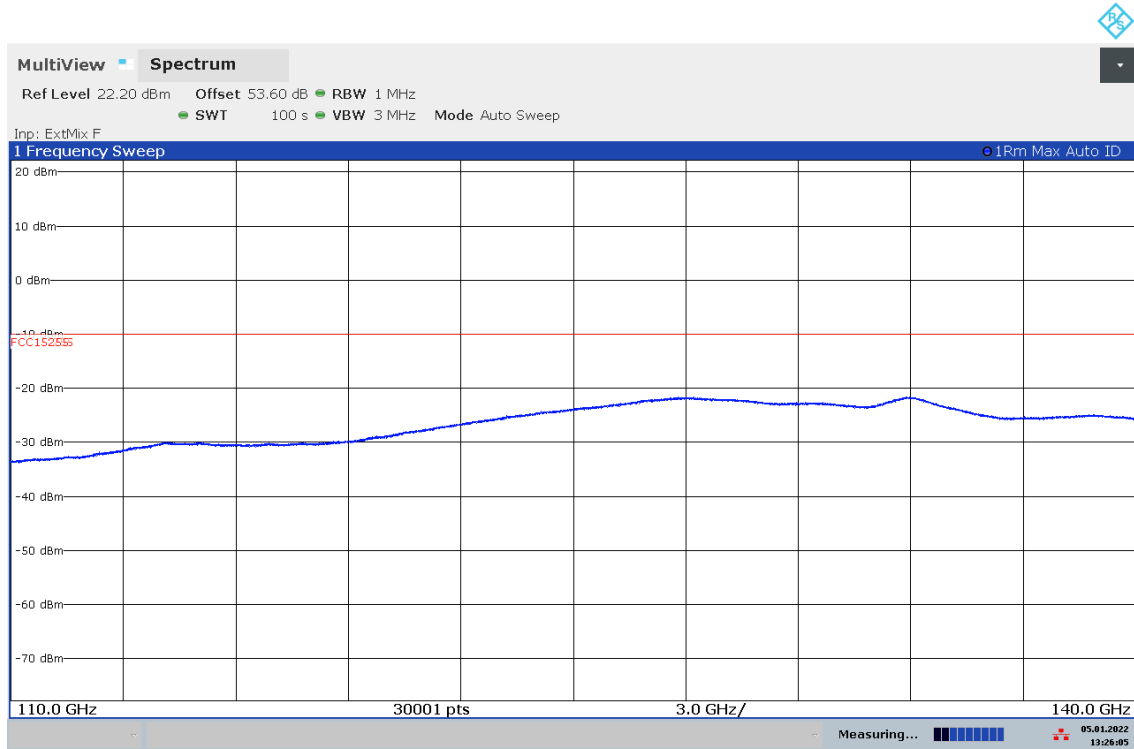

13:26:05 05.01.2022

Plot 12: 140 GHz – 220 GHz, antenna vertical / horizontal

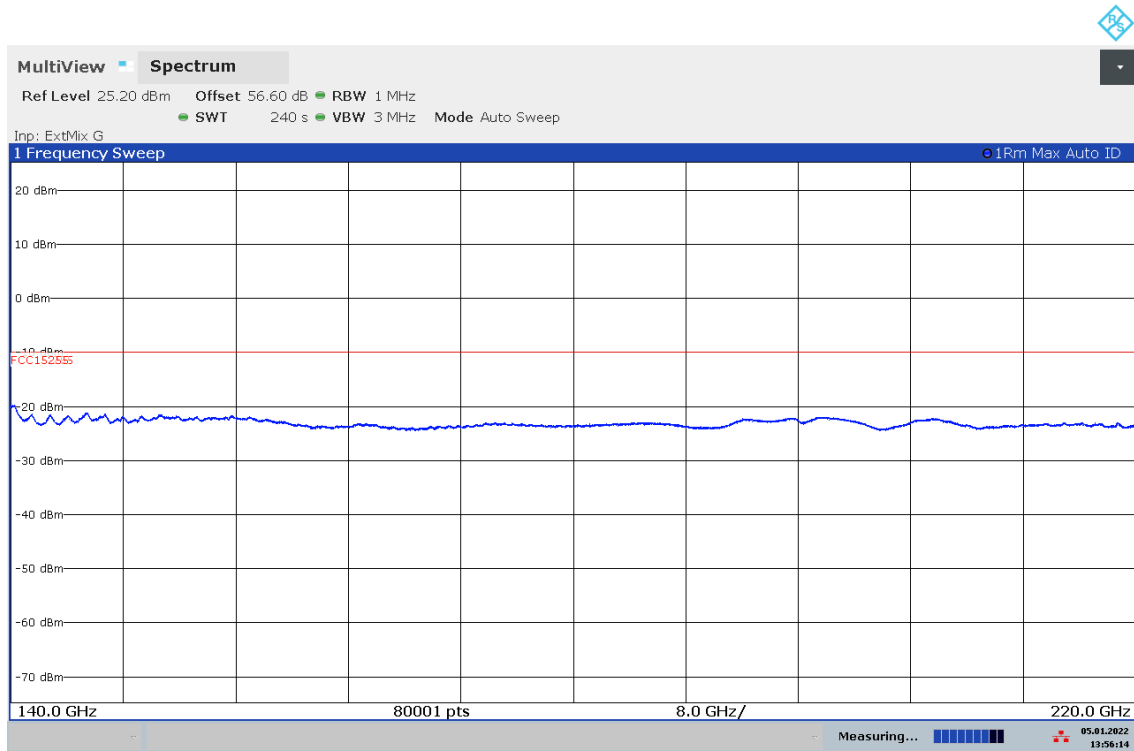

13:56:15 05.01.2022

## 12.4 Frequency Stability

### Description:

Measurement of the radiated spurious emissions in transmit mode.

### Limits:

(e) *Frequency stability.* Fundamental emissions must be contained within the frequency bands specified in this section during all conditions of operation. Equipment is presumed to operate over the temperature range -20 to + 50 degrees Celsius with an input voltage variation of 85% to 115% of rated input voltage, unless justification is presented to demonstrate otherwise.

FCC
CFR Part 15.255
The occupied bandwidth from intentional radiators operated within the specified frequency band shall comply with the following:
Frequency range
57 GHz – 71 GHz

### Measurement:

Measurement parameter	
Detector:	Peak
Sweep time:	10 s
Resolution bandwidth:	1 MHz
Video bandwidth:	3 MHz
Span:	11 GHz
Trace-Mode:	Max Hold
Temperature:	-40 °C / +85 °C

**Measurement Results:**

Temperature in °C	Voltage	f <sub>L</sub> in GHz	f <sub>H</sub> in GHz
-40	V <sub>nom</sub>	59.852	62.456
-20	V <sub>nom</sub>	59.808	62.390
-10	V <sub>nom</sub>	59.797	62.397
0	V <sub>nom</sub>	59.841	62.357
10	V <sub>nom</sub>	59.665	62.357
20	V <sub>nom</sub>	59.654	62.354
20	V <sub>min</sub>	59.819	62.313
20	V <sub>max</sub>	59.808	62.313
30	V <sub>nom</sub>	59.709	62.291
40	V <sub>nom</sub>	59.643	62.258
50	V <sub>nom</sub>	59.643	62.247
85	V <sub>nom</sub>	59.720	62.214

**Note:** The corresponding plots show a Max-Hold trace over 10 minutes after the EUT is powered on at the corresponding Temperature/Voltage. Set-up with climatic box is different from the nominal OBW measurement.

**Result:** The measurement is passed.



Plot 13: 20 dB-Bandwidth at  $T_{min}$

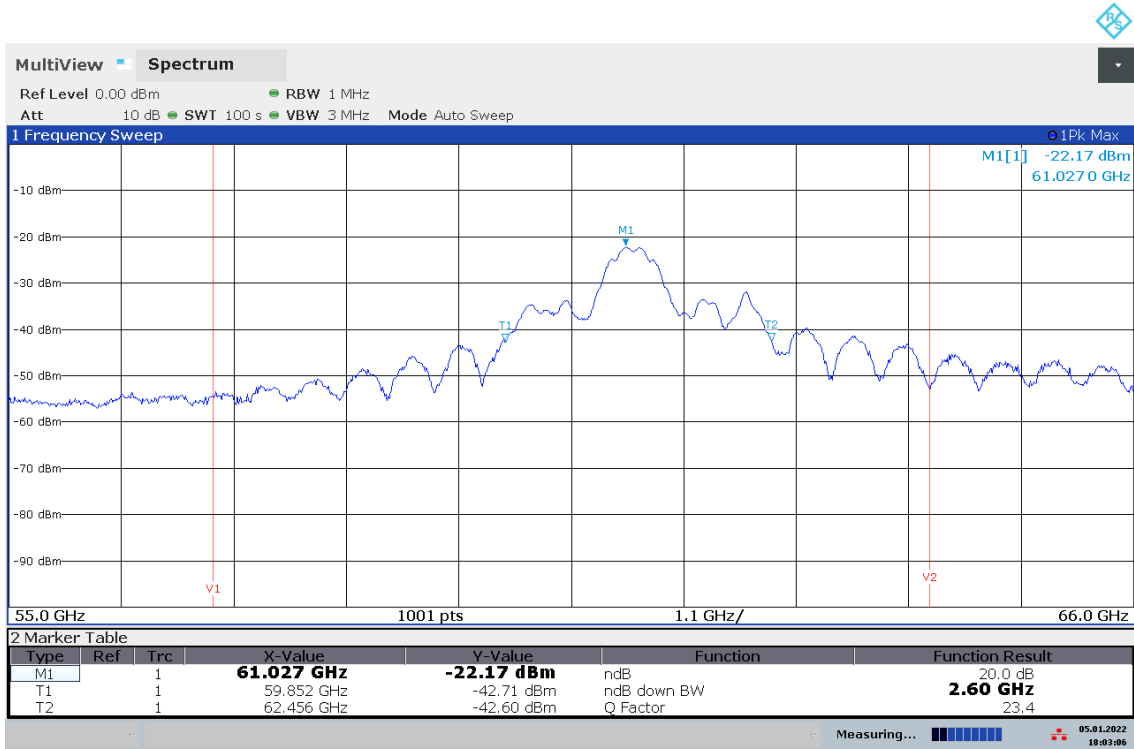

18:03:06 05.01.2022

Plot 14: 20 dB Bandwidth at  $T_{max}$

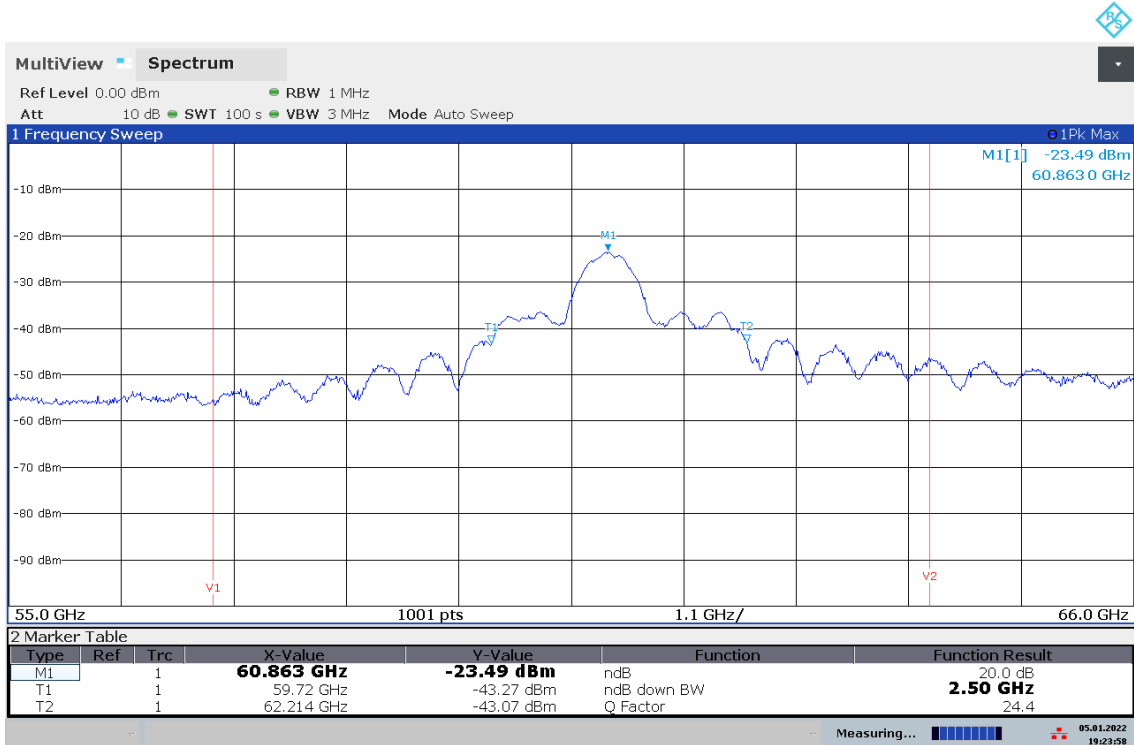

19:23:58 05.01.2022

Plot 15: 20 dB-Bandwidth at  $V_{min}$

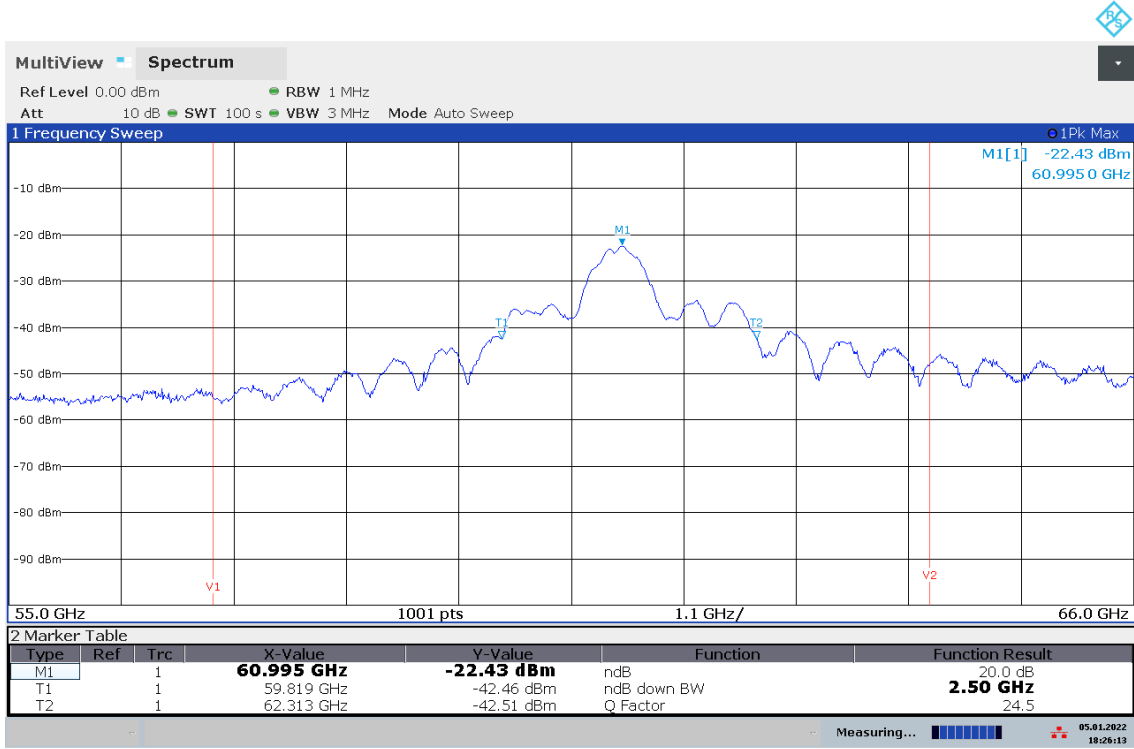

18:26:13 05.01.2022

Plot 16: 20 dB Bandwidth at  $V_{max}$

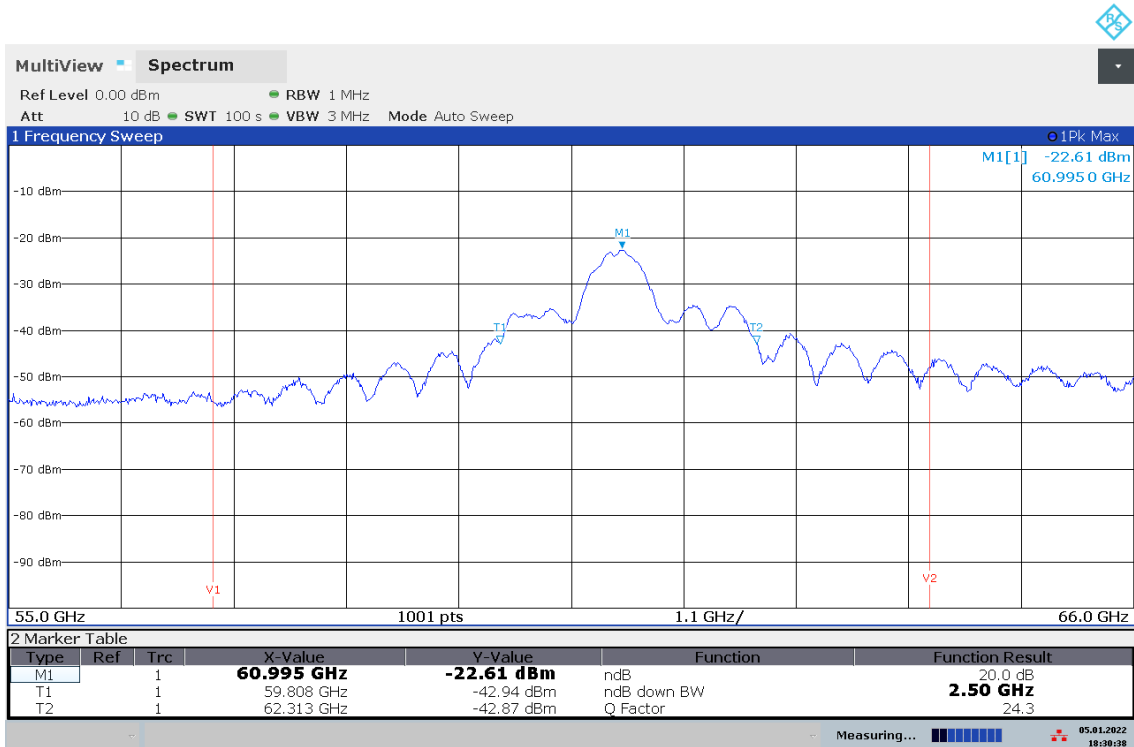

18:30:39 05.01.2022

### 13 Glossary

<b>EUT</b>	Equipment under test
<b>DUT</b>	Device under test
<b>UUT</b>	Unit under test
<b>GUE</b>	GNSS User Equipment
<b>ETSI</b>	European Telecommunications Standards Institute
<b>EN</b>	European Standard
<b>FCC</b>	Federal Communications Commission
<b>FCC ID</b>	Company Identifier at FCC
<b>IC</b>	Industry Canada
<b>PMN</b>	Product marketing name
<b>HMN</b>	Host marketing name
<b>HVIN</b>	Hardware version identification number
<b>FVIN</b>	Firmware version identification number
<b>EMC</b>	Electromagnetic Compatibility
<b>HW</b>	Hardware
<b>SW</b>	Software
<b>Inv. No.</b>	Inventory number
<b>S/N or SN</b>	Serial number
<b>C</b>	Compliant
<b>NC</b>	Not compliant
<b>NA</b>	Not applicable
<b>NP</b>	Not performed
<b>PP</b>	Positive peak
<b>QP</b>	Quasi peak
<b>AVG</b>	Average
<b>OC</b>	Operating channel
<b>OCW</b>	Operating channel bandwidth
<b>OBW</b>	Occupied bandwidth
<b>OOB</b>	Out of band
<b>DFS</b>	Dynamic frequency selection
<b>CAC</b>	Channel availability check
<b>OP</b>	Occupancy period
<b>NOP</b>	Non occupancy period
<b>DC</b>	Duty cycle
<b>PER</b>	Packet error rate
<b>CW</b>	Clean wave
<b>MC</b>	Modulated carrier
<b>WLAN</b>	Wireless local area network
<b>RLAN</b>	Radio local area network
<b>DSSS</b>	Dynamic sequence spread spectrum
<b>OFDM</b>	Orthogonal frequency division multiplexing
<b>FHSS</b>	Frequency hopping spread spectrum
<b>GNSS</b>	Global Navigation Satellite System
<b>C/N<sub>0</sub></b>	Carrier to noise-density ratio, expressed in dB-Hz

**14 Document history**

Version	Applied changes	Date of release
-/-	Initial release – DRAFT	2022-01-05
-/-	Initial release DRAFT2	2022-01-12
	Initial release	2022-01-13
A	KDB Publication 502150 D01 added	2022-01-24
B	KDB guidance 996369 D01 added, model name updated	2022-01-31

**15 Accreditation Certificate – D-PL-12076-01-05**

first page	last page
 <p>Deutsche Akkreditierungsstelle GmbH</p> <p>Entrusted according to Section 8 subsection 1 AkkStelleG in connection with Section 1 subsection 1 AkkStelleGBV Signatory to the Multilateral Agreements of EA, ILAC and IAF for Mutual Recognition</p> <p><b>Accreditation</b> </p> <p>The Deutsche Akkreditierungsstelle GmbH attests that the testing laboratory <b>CTC advanced GmbH</b> Untertürkheimer Straße 6-10, 66117 Saarbrücken is competent under the terms of DIN EN ISO/IEC 17025:2018 to carry out tests in the following fields: <b>Telecommunication (FCC Requirements)</b></p> <p>The accreditation certificate shall only apply in connection with the notice of accreditation of 09.06.2020 with the accreditation number D-PL-12076-01. It comprises the cover sheet, the reverse side of the cover sheet and the following annex with a total of 05 pages.</p> <p>Registration number of the certificate: <b>D-PL-12076-01-05</b></p> <p>Frankfurt am Main, 09.06.2020</p> <p>by  <b>Frank Egnor</b> Head of Division</p> <p><small>The certificate together with its annex reflects the status at the time of the date of issue. The current status of the scope of accreditation can be found in the database of accredited bodies of Deutsche Akkreditierungsstelle GmbH. <a href="https://www.dakks.de/en/content/accredited-bodies-dakks">https://www.dakks.de/en/content/accredited-bodies-dakks</a> See notes overleaf.</small></p>	<p>Deutsche Akkreditierungsstelle GmbH</p> <p>Office Berlin Spittelmarkt 10 10117 Berlin</p> <p>Office Frankfurt am Main Europa-Allee 52 60327 Frankfurt am Main</p> <p>Office Braunschweig Bundesallee 100 38116 Braunschweig</p> <p>The publication of extracts of the accreditation certificate is subject to the prior written approval by Deutsche Akkreditierungsstelle GmbH (DAkKS). Exempted is the unchanged form of separate disseminations of the cover sheet by the conformity assessment body mentioned overleaf.</p> <p>No impression shall be made that the accreditation also extends to fields beyond the scope of accreditation attested by DAkKS.</p> <p>The accreditation was granted pursuant to the Act on the Accreditation Body (AkkStelleG) of 31 July 2009 (Federal Law Gazette I p. 2625) and the Regulation (EC) No 765/2008 of the European Parliament and of the Council of 9 July 2008 setting out the requirements for accreditation and market surveillance relating to the marketing of products [Official Journal of the European Union L 218 of 9 July 2008, p. 30]. DAkKS is a signatory to the Multilateral Agreements for Mutual Recognition of the European co-operation for Accreditation (EA), International Accreditation Forum (IAF) and International Laboratory Accreditation Cooperation (ILAC). The signatories to these agreements recognise each other's accreditations.</p> <p>The up-to-date state of membership can be retrieved from the following websites: EA: <a href="http://www.european-accreditation.org">www.european-accreditation.org</a> ILAC: <a href="http://www.ilac.org">www.ilac.org</a> IAF: <a href="http://www.iaf.nu">www.iaf.nu</a></p>

**Note: The current certificate annex is published on the websites (link see below).**

<https://www.dakks.de/files/data/as/pdf/D-PL-12076-01-05e.pdf>

OR

[https://ctcadvanced.com/app/uploads/2020/06/D-PL-12076-01-05\\_TCB\\_USA.pdf](https://ctcadvanced.com/app/uploads/2020/06/D-PL-12076-01-05_TCB_USA.pdf)

##### END OF TEST REPORT #####