IOT-800N-G350

8" Risc-based Panel PC

User's Manual

Version 1.3



2022.10

This page is intentionally left blank.

Revision History

Version	Release Date	Description
		<ul style="list-style-type: none">
		<ul style="list-style-type: none">
		<ul style="list-style-type: none">

Copyright

Copyright © 2020 ARBOR Technology Corp. All Rights Reserved.

This document contains proprietary information protected by copyright. No part of this manual may be reproduced by any mechanical, electronic, or other means in any form without prior written permission of the manufacturer.

Disclaimer

The information in this document is subject to change without prior notice in order to improve the reliability, design and function. It does not represent a commitment on the part of the manufacturer.

Under no circumstances will the manufacturer be liable for any direct, indirect, special, incidental, or consequential damages arising from the use or inability to use the product or documentation, even if advised of the possibility of such damages.

About This Manual

This user's manual provides the general information and installation instructions for the product. The manual is meant for the experienced users and integrators with hardware knowledge of personal computers. If you are not sure about any description in this manual, consult your vendor before further handling.

We recommend that you keep one copy of this manual for the quick reference for any necessary maintenance in the future. Thank you for choosing ARBOR products.

Contents

Preface	v
Declaration of Conformity	v
CE	v
FCC Class B	v
RoHS	vi
SVHC / REACH	vi
Safety Symbols	vii
Important Safety Instructions	vii
General Cleaning Tips	ix
Cleaning Tools	ix
Recommended Cleaning Procedures	x
Disposing of the Equipment	xi
Additional Information & Technical Support	xii
Warranty	xii
Chapter 1 Introduction	1
1.1 Product Highlights	2
1.2 Package Contents	2
1.3 Optional Accessories	3
1.4 Specifications	4
1.5 System View	6
1.6 Dimension	8
1.7 Pin Out Definition	8
1.7.1 RS-232 Port (COM2)	8
1.7.2 RS-232/422/485 (COM3)	9
1.7.3 DI/DO and CAN Bus	10
1.7.4 RS-232	11
Chapter 2 Getting Started	13
2.1 SIM Card Installation (for IOT-800N LTE Only)	14
2.2 microSD Card Installation	15
2.3 Antenna Installation	16
2.4 Power Connection	17
2.4.1 Power Connector	17
2.4.2 Wiring Cables to 3-pin Terminal Block	17
2.4.3 Using Power Adapter (Optional)	19
2.5 Configuring COM Port	19
2.6 Mounting the Device	21

- Chapter 3 Using the Device..... 23**
 - 3.1 Power On/Off and Sleep Options.....24
 - 3.2 Home Screen 25
 - 3.2.1 Status Bar 27
 - 3.2.2 Using the Quick Settings Panel..... 27
 - 3.2.3 Viewing Power Voltage 28
 - 3.3 Configuring Your SIM Card (for IOT-800N LTE Only)29
 - 3.3.1 Enabling Data Access Over Mobile Network 29
 - 3.3.2 Using a Locked SIM Card..... 30
 - 3.3.3 Disabling SIM Card Lock..... 31
 - 3.3.4 Configuring APN Settings32
 - 3.4 Enabling Wi-Fi and Connecting to a WLAN..... 33
 - 3.5 Enabling Bluetooth and Pairing with Bluetooth Device 34
 - 3.6 Connecting to a Network via LAN Port..... 36
 - 3.7 Using the GPS Feature (For IOT-800N LTE)..... 38
 - 3.8 Enabling and Using the NFC Features..... 40
 - 3.9 Using the Camera Feature 41
 - 3.10 Ignition Management..... 43

- Chapter 4 Troubleshooting..... 45**

Declaration of Conformity

CE

The CE symbol on your product indicates that it is in compliance with the directives of the Union European (EU). A Certificate of Compliance is available by contacting Technical Support.

This product has passed the CE test for environmental specifications when shielded cables are used for external wiring. We recommend the use of shielded cables. This kind of cable is available from ARBOR. Please contact your local supplier for ordering information.

FCC Class B

This device complies with Part 15 of the FCC Rules. Operation is subject to the following two conditions:

1. This device may not cause harmful interference, and
2. This device must accept any interference received, including interference that may cause undesired operation.

Any changes or modifications not expressly approved by the guarantee of this device could void the user's authority to operate the equipment.

This equipment has been tested and found to comply with the limits for a Class B digital device, pursuant to Part 15 of the FCC Rules. These limits are designed to provide reasonable protection against harmful interference in a residential installation. This equipment generates, uses and can radiate radio frequency energy and, if not installed and used in accordance with the instructions, may cause harmful interference to radio communications.

However, there is no guarantee that interference will not occur in a particular installation. If this equipment does cause harmful interference to radio or television reception, which can be determined by turning the equipment off and on, the user is encouraged to try to correct the interference by one or more of the following measures:

- Reorient or relocate the receiving antenna.
- Increase the separation between the equipment and receiver.

- Connect the equipment into an outlet on a circuit different from that to which the receiver is connected.
- Consult the dealer or an experienced radio/TV technician for help.

FCC Radiation Exposure Statement

This equipment complies with FCC radiation exposure limits set forth for an uncontrolled environment. This equipment should be installed and operated with minimum distance 20 cm between the radiator and your body.

ARBOR Solution Inc.

Address: 46653 Fremont Blvd. Fremont, CA 94538, USA
TEL: 1 408 452 8900

RoHS

ARBOR Technology Corp. certifies that all components in its products are in compliance and conform to the European Union's Restriction of Use of Hazardous Substances in Electrical and Electronic Equipment (RoHS) Directive 2002/95/EC.

The above mentioned directive was published on 2/13/2003. The main purpose of the directive is to prohibit the use of lead, mercury, cadmium, hexavalent chromium, polybrominated biphenyls (PBB), and polybrominated diphenyl ethers (PBDE) in electrical and electronic products. Member states of the EU are to enforce by 7/1/2006.

ARBOR Technology Corp. hereby states that the listed products do not contain unintentional additions of lead, mercury, hex chrome, PBB or PBDB that exceed a maximum concentration value of 0.1% by weight or for cadmium exceed 0.01% by weight, per homogenous material. Homogenous material is defined as a substance or mixture of substances with uniform composition (such as solders, resins, plating, etc.). Lead-free solder is used for all terminations (Sn(96-96.5%), Ag(3.0-3.5%) and Cu(0.5%)).

SVHC / REACH

To minimize the environmental impact and take more responsibility to the

earth we live, ARBOR hereby confirms all products comply with the restriction of SVHC (Substances of Very High Concern) in (EC) 1907/2006 (REACH --Registration, Evaluation, Authorization, and Restriction of Chemicals) regulated by the European Union.

All substances listed in SVHC < 0.1 % by weight (1000 ppm)

Safety Symbols



This symbol of “CAUTION” indicates that there is a danger of injury to the user or a risk of damage to the product, should warning notices be disregarded.



This symbol indicates electrical warning.

Important Safety Instructions

Read these safety instructions carefully:

1. Read all cautions and warnings on the equipment.
2. Place this equipment on a reliable surface when installing. Dropping it or letting it fall may cause damage
3. Make sure the correct voltage is connected to the equipment.
4. For pluggable equipment, the socket outlet should be near the equipment and should be easily accessible.
5. Keep this equipment away from humidity.
6. Disconnect this equipment from the A/C outlet before cleaning it. Use a moist cloth. Do not use liquid or sprayed detergent for cleaning.
7. To fully disengage the power to the unit, please disconnect the power from the AC outlet.
8. Do not scratch or rub the screen with a hard object.
9. Never use any of the solvents, such as Thinner Spray-type cleaner, Wax, Benzene, Abrasive cleaner, Acid or Alkaline solvent, on the display. Harsh chemicals may cause damage to the cabinet and the touch sensor.
10. Remove dirt with a lightly moistened cloth and a mild solvent detergent. Then wipe the cabinet with a soft dry cloth.
11. The openings on the enclosure are for air convection and protect the equipment from overheating. **DO NOT COVER THE OPENINGS.**
12. Position the power cord so that people cannot step on it. Do not place anything over the power cord.

13. If the equipment will not be used for a long time, disconnect it from the power source to avoid damage by transient overvoltage.
14. Never pour any liquid into openings. This may cause fire or electrical shock.
15. Never open the equipment. For safety reasons, the equipment should be opened only by qualified service personnel.
16. If one of the following situations arises, get the equipment checked by service personnel:
 - a. The power cord or plug is damaged.
 - b. Liquid has penetrated into the equipment.
 - c. The equipment has been exposed to moisture.
 - d. The equipment does not work well, or you cannot get it to work according to the user's manual.
 - e. The equipment has been dropped or damaged.
 - f. The equipment has obvious signs of breakage.
17. The sound pressure level at the operator's position, according to IEC 704-1:1982, is no more than 70dB(A).
18. Keep this User's Manual for later reference.
19. **DO NOT LEAVE THIS EQUIPMENT IN AN UNCONTROLLED ENVIRONMENT WHERE THE STORAGE IS BELOW -20° C (-4° F) OR ABOVE 70° C (158° F). THIS MAY DAMAGE THE EQUIPMENT.**



Do not use the power adapter that isn't made for the equipment. Supplying the equipment with inappropriate voltage may cause harm to or burn the equipment.



To prevent possible hearing damage, do not listen at high volume levels for long periods

General Cleaning Tips

You may need the following precautions before you begin to clean the device. When you clean any single part or component for the device, please thoroughly read and understand the details below.

1. We strongly recommended that you should shut down the system before you start to clean any single components.
2. When you need to clean the device, please rub it with a piece of dry cloth.
3. Be cautious of the tiny removable components when you use a vacuum cleaner to absorb the dirt on the floor.
4. Never drop the components inside the device or get circuit board damp or wet.
5. Be cautious of all kinds of cleaning solvents or chemicals when you use it for the sake of cleaning. Some individuals may be allergic to the ingredients.
6. Try not to put any food, drink or cigarette around the device.

Cleaning Tools

Although many companies have created products to help improve the process of cleaning your devices and peripherals, users can also use household items to clean their devices and peripherals. Below is a listing of items you may need or want to use while cleaning your devices or peripherals. Keep in mind that some components in your device may only be able to be cleaned using a product designed for cleaning that component, if this is the case it will be mentioned in the cleaning.

- **Cloth:** A piece of cloth is the best tool to use when rubbing up a component. Although paper towels or tissues can be used on most hardware as well, we still recommend you to rub it with a piece of cloth.
- **Water or rubbing alcohol:** You may moisten a piece of cloth a bit with some water or rubbing alcohol and rub it on the device. Unknown solvents may be harmful to the plastics parts.
- **Vacuum cleaner:** Absorb the dust, dirt, hair, cigarette particles, and other particles out of the device can be one of the best cleaning methods. Over time, these items can restrict the airflow in a device and cause circuitry to corrode.
- **Cotton swabs:** Cotton swabs moistened with rubbing alcohol or water are excellent tools for wiping hard to reach areas in your keyboard, mouse, and other locations.
- **Foam swabs:** Whenever possible, it is better to use lint-free swabs such as foam swabs.

Recommended Cleaning Procedures

1. Close all application programs
2. Close operating software
3. Turn off the equipment
4. Remove all peripherals
5. Disconnect the power cable
6. Proceed to clean.

Disposing of the Equipment

- **Within the European Union**



EU-wide legislation, as implemented in each Member State, requires that waste electrical and electronic products carrying the mark (left) must be disposed of separately from normal household waste.

This includes monitors and electrical accessories, such as signal cables or power cords. When you need to dispose of your display products, please follow the guidance of your local authority, or ask the shop where you purchased the product, or if applicable, follow any agreements made between yourself. The mark on electrical and electronic products only applies to the current European Union Member States.

- **Outside the European Union**

If you wish to dispose of used electrical and electronic products outside the European Union, please contact your local authority so as to comply with the correct disposal method.

Additional Information & Technical Support

You can download the related technical documents such as datasheet and user's manual as well as driver on our website.

Please do not hesitate to call or e-mail our customer service when you still cannot get the information you need.

<http://www.arbor-technology.com>

E-mail: info@arbor.com.tw

Warranty

This product is warranted to be in good working order during the warranty period. Should this product fail to be in good working order at any time during this period, we will, at our option, replace or repair it at no additional charge except as set forth in the following terms. This warranty does not apply to products damaged by misuse, modifications, accident or disaster.

Vendor assumes no liability for any damages, lost profits, lost savings or any other incidental or consequential damage resulting from the use, misuse of, or inability to use this product. Vendor will not be liable for any claim made by any other related party.

Vendors disclaim all other warranties, either expressed or implied, including but not limited to implied warranties of merchantability and fitness for a particular purpose, with respect to the hardware, the accompanying product's manual(s) and written materials, and any accompanying hardware. This limited warranty gives you specific legal rights.

Return authorization must be obtained from the vendor before returned merchandise will be accepted. Authorization can be obtained by calling or faxing the vendor and requesting a Return Merchandise Authorization (RMA) number. Returned goods should always be accompanied by a clear problem description.

Chapter 1

Introduction

1.1 Product Highlights

- Rockchip PX30, ARM Quad-core Cortex-A35, 64-bit low-power processor, up to 1.5GHz
- Built-in Can BUS, OBD-II for fleet management applications
- 8M front camera for in-vehicle surveillance
- Multiple I/O including LAN, USB 2.0, and RS-232 support
- Global band LTE module; a single module for different countries and supporting positioning simultaneously
- Support Android 8.1



1.2 Package Contents

Upon opening the package, carefully inspect the contents. If any of the items is missing or appears damaged, contact your local dealer or distributor. The package should contain the following items:

1 x 8" Risc-Based Panel PC



1 x Bottom Rubber Case



1 x Accessory Kit

1 x Wi-Fi Antenna



1 x 3-pin DC Terminal Block Plug with screws





1 x 10-pin Terminal Block Plug



1 x 4G Antenna (for IOT-800N LTE only)



1.3 Optional Accessories

GPS Antenna	GPS Antenna, SMA Plug Male, 1600mm (for IOT-800N LTE only)	
AC-DC Power Adapter (US)	Input : 100V-240V, Output : 12V/1.5A; W/3-pin Terminal Block with screws, US Plug	
AC-DC Power Adapter (EU)	Input : 100V-240V, Output : 12V/1.5A; W/3-pin Terminal Block with screws, EU Plug	

1.4 Specifications

System	
CPU	ARM Quad-core Cortex-A35
OS	Android 8.1
Memory	2GB DDR4 memory soldered on board
Flash	16GB eMMC flash soldered on board
Peripherals and Devices	
Front Camera	1 x 8MP resolution CMOS MIPI-CSI Type AF camera module
Audio	1 x built-in speaker (1W) 1 x built-in microphone
Wireless	
WWAN	WCDMA / LTE, Mini PCIE interface (optional)
WLAN	IEEE 802.11 a/b/g/n/ac
Bluetooth	Bluetooth 4.2, low power BLE
NFC	1 x 13.56MHz RFID & NFC reader with ISO 14443A/14443B/15693 & mifare
GPS	Supporting GPS / Galileo / Glonass / BeiDou / QZSS (optional)
I/O Interface	
SD Card	1 x microSDHC/microSDXC/ microSD (Max. 128GB) card socket
USB	2 x USB 2.0 Type-A port 1 x micro USB 2.0
Speaker	1 x 8Ω/1W
DB9 Interface	1 x RS-232/422/485 COM port; 1 x RS-232 COM port
LAN	1 x RJ-45 Ethernet, 10/100Mbps
Power	Tact switch
CAN	Built-in Can Bus, OBD-II, supports: ISO 15765 id 11bits 500kb ISO 15765 id 29bits 500kb ISO 15765 id 11bits 250kb ISO 15765 id 29bits 250kb

DIO	3 x DI, 3 x DO (dry contract)
Expansion	Mini PCIE interface (USB signal only)
LCD Display	
Size/Type	8" TFT LCD
Resolution	1024 x 600
Technology	High definition
Brightness (cd/m²)	500 cd/m ²
Contrast Ratio	700:1(Typ.)
Interface	LVDS Type
View Angel (A/B/R/L)	70°/75°/75°/75° typ.
Touch Screen	
Type	5-point projected capacitive multi-touch
Interface	I2C
Power Input	
Power Input	Built-in ignition detection
DC Input	3-pin terminal block 9V~36V auto-detection
Mechanical & Environmental	
Operating Temp.	-5°C ~ 60°C (23°F~140°F)
Storage Temp.	-20°C ~ 70°C (-4°F~158°F)
Protection level	Front bezel design compliant with IP-54 & IK-05
Operating Humidity	5~90% RH@ 50°C (non-condensing)
Dimensions (W x H x D)	218.16 x 162.67 x 46.5mm (W x H x D)
Weight	940g (2.07lb)
Regulatory	CE, FCC, E-Mark
Installation	
VESA Mount	75mm x 75mm

1.5 System View



No.	Item	Descriptions
1	Camera	8MP auto focus camera
2	Microphone	Built-in microphone
3	Touch screen	5-point projected capacitive touch screen
4	Speaker	Integrated 8Ω/1W speaker
5	NFC antenna area	13.56MHz RFID & NFC reader with ISO 14443A/14443B/15693 & mifare
6	DIO & CAN connector	3 x dry contact DI, 3 x dry contact DO, 1 x CAN, OBD-II See 1.7.3 DI/DO and CAN Bus on page 10 for pin definitions.
7	DC In	3-pin DC terminal, 9V~36V auto-detection
8	microSD card slot	microSD card slot
9	micro SIM	Nano SIM (4FF) slot
10	RS-232 connector	4-pin RS-232 connector See 1.7.4 RS-232 on page 11 for pin definitions.
11	Mounting holes	Panel mounting holes
12	LAN port	10/100 Mbps RJ-45 LAN port
13	USB ports	USB 2.0 type-A ports
14	USB ports	USB 2.0 type-A ports
15	USB ports	USB 2.0 type-A ports
16	USB ports	USB 2.0 type-A ports
17	USB ports	USB 2.0 type-A ports

14	COM port (COM3)	DB-9 RS-232/422/485 port, default: RS-232 Selectable via provided Serial Port API App. See 2.5 Configuring COM Port for details See 1.7.2 RS-232/422/485 (COM3) on page 9 for pin definitions.
15	COM port (COM2)	DB-9 RS-232 port. To configure COM port settings, see 2.5 Configuring COM Port for details. See 1.7.1 RS-232 Port (COM2) on page 8 for pin definitions.
16	micro USB port	micro USB 2.0 port for Android Debug Bridge (ADB) use
17	Power button	<ul style="list-style-type: none">• When the device is turned off, press once to turn on the device.• In operation mode:<ul style="list-style-type: none">• Press once to enter standby mode.• Press and hold to display Power off / Restart menu.• In standby mode, press once to resume operation.
18	GPS antenna connector	SMA connector for connecting to optional GPS antenna.
19	Wi-Fi antenna connector	SMA connector for connecting to Wi-Fi / Bluetooth antenna
20	4G antenna connector	For IOT-800N LTE only. SMA connector for connecting to 4G antenna.
21	Mounting holes	VESA 75 mounting holes (M3 size)

1.6 Dimension

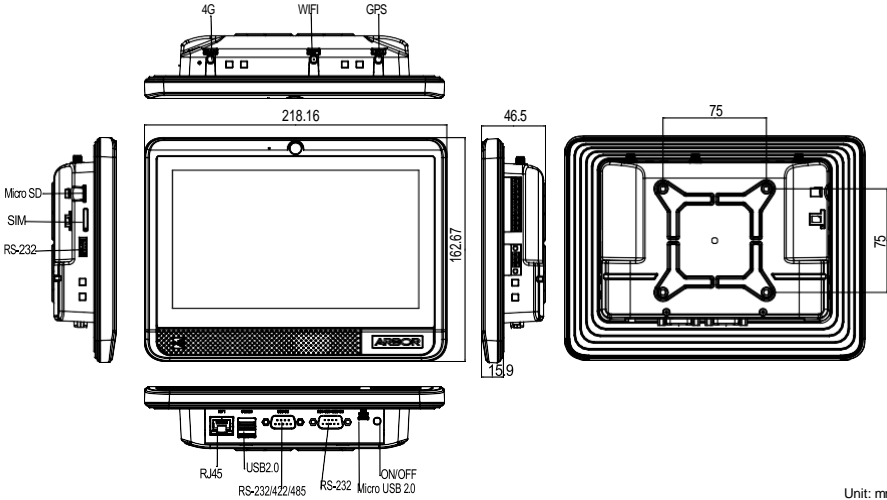

Unit: mm

1.7 Pin Out Definition

Power Connector

Description: Power Input Connector

Connector Type: 3-pin Terminal Block

Pin	Description
1	Power_GND
2	+12V-
3	S

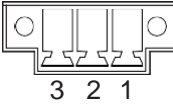

1.7.1 RS-232 Port (COM2)

Description: RS-232 COM Port

Connector type: Male type DB9 Connector

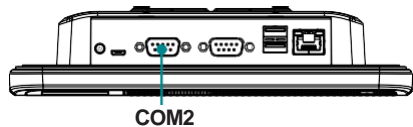

Pin	Desc.	Pin	Desc.
1	N/C	2	RXD
3	TXD	4	N/C
5	GND	6	N/C
7	N/C	8	N/C
9	N/C		

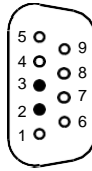

1.7.2 RS-232/422/485 (COM3)

Description: RS-232/422/485 Selectable COM Port (Configuration via App)

Connector type: Male type DB9 Combo Connector

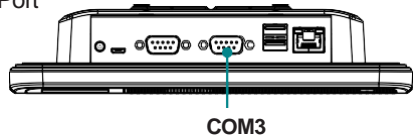

Mode 01: RS-232

Pin	Desc.	Pin	Desc.
1	N/C	2	RXD
3	TXD	4	N/C
5	GND	6	N/C
7	RTS	8	CTS
9	N/C		

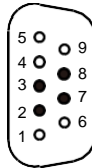

Mode 10/11: RS-485

Pin	Desc.	Pin	Desc.
1	D-	2	D+
3	N/C	4	N/C
5	GND	6	N/C
7	N/C	8	N/C
9	N/C		

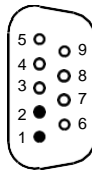

Mode 00: RS-422

Pin	Desc.	Pin	Desc.
1	TX-	2	TX+
3	RX-	4	RX+
5	GND	6	N/C
7	N/C	8	N/C
9	N/C		

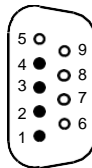

To configure the COM ports via provided **Serial Port API App**, see [2.5 Configuring COM Port](#) for details.

1.7.3 DI/DO and CAN Bus

- **Description:** Digi
-
- tal Input/Output and CAN Bus Connector

Connector Type: 3 x dry contact DI, 3 x dry contact DIO, 1 x CAN, OBD-II

Pin	Description
1	DI PWR Supply
2	DI 0
3	DI 1
4	DI 2
5	DO 0
6	DO 1
7	DO 2
8	GND
9	CAN L
10	CAN H

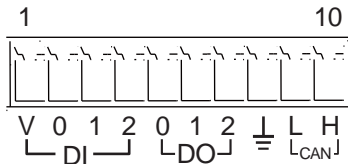

OBD-II Supported Protocols

- ISO 15765 id 11bits 500kb
- ISO 15765 id 29bits 500kb
- ISO 15765 id 11bits 250kb
- ISO 15765 id 29bits 250kb

DI Example Circuit

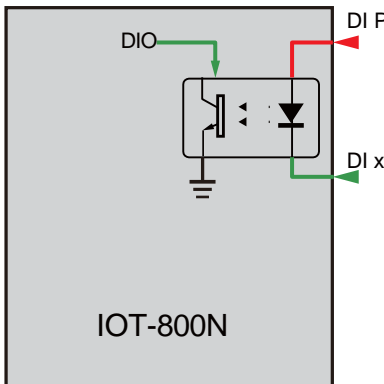

- External Device Power supply (DI VCC) = 9V~32V
- Input = DI VCC = 1
- Input = External Device GND = 0

DO Example Circuit

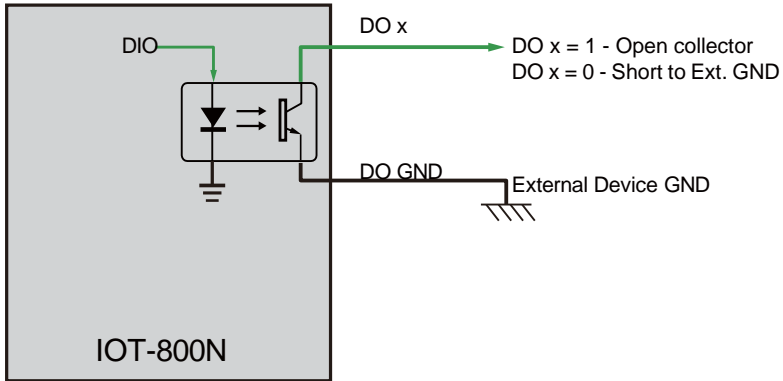

1.7.4 RS-232

Description: RS-232 Connector

Connector type: 1x 4-pin connector

Pin	Description
1	PWR, 5V
2	RX
3	TX
4	GND

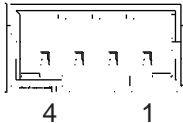

This page is intentionally left blank.

Chapter 2

Getting Started

2.1 SIM Card Installation (for IOT-800N LTE Only)

This section is applicable to IOT-800N LTE only. If your model doesn't support 4G, please ignore this section.

The IOT-800N LTE is capable of accessing 4G network. To use the 4G network functions, you have to insert a nano SIM (4FF) card and antenna to the IOT-800N.

Caution: The IOT-800N SIM module **doesn't support hot-pluggable** feature. Before inserting or removing SIM card, always power off the IOT-800N LTE.

Warning: Use only a nano SIM (4FF) card.

To install a SIM card to the device:

1. Make sure the IOT-800N LTE is powered off.
2. Locate the SIM card slot on the side. To pop open the SIM tray, insert a paper clip or a SIM-eject tool into the hole beside the tray.



3. After ejecting the SIM card tray, place your SIM card into the tray. Note that there is notch in one corner to ensure the SIM card is placed correctly.

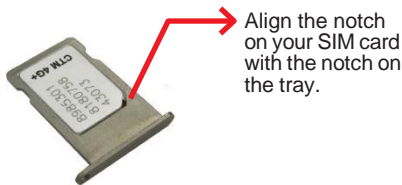

- Place the device on a flat surface with the panel side facing down. Insert the tray into the device completely and in the same orientation that you removed it. The tray also fits only one way.

Warning: Inserting the SIM tray in a wrong way will cause damage to the device and void your warranty.

Caution: While inserting the SIM tray, DO NOT place the device vertically or at an angle to prevent the SIM card from falling into the device.



Make sure to align the hole on the tray with the hole in the device.

To use the 4G function, you will also need to:

- Install the 4G antenna - Refer to [2.3 Antenna Installation](#) on page [16](#)
- Activate and configure the SIM card account - Refer to [3.3 Configuring Your SIM Card \(for IOT-800N LTE Only\)](#) on page [29](#).

To remove the SIM card, insert a paper clip or a SIM-eject tool into the hole beside the tray to pop open the tray and then remove the card.

2.2 microSD Card Installation

To install a microSD card to the device, locate the microSD card slot on the side and insert the card following the direction as shown in the figure. Push the card into the slot until you hear a click indicating locks into place.



If the card is successfully inserted, a notification will appear.

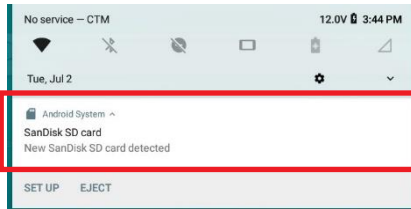

To remove the microSD card, just push the microSD card in to eject it from its slot.

2.3 Antenna Installation

According to your IOT-800N model and requirements, you will need to install the following antennas:

- Wi-Fi/Bluetooth antenna included in the accessory kit.
- 4G antenna included in the accessory kit (for IOT-800N LTE only).
- Optional GPS antenna

To install the antenna(s), refer to the picture below to install the antenna to the corresponding jack on the top side of the device.

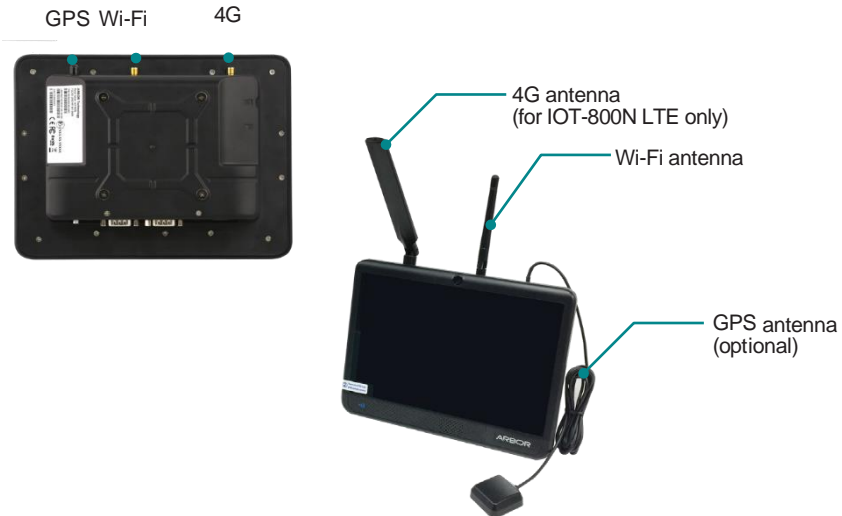

2.4 Power Connection

2.4.1 Power Connector

The device requires a 9~36V DC power supply. A 3-pin terminal block receptacle is located on the side of the device for DC power connection.

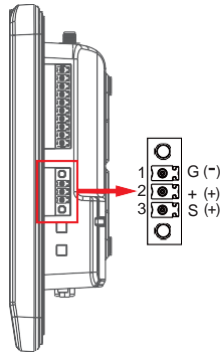

2.4.2 Wiring Cables to 3-pin Terminal Block

For Vehicle Application

For vehicle usage, please use the provided 3-pin terminal block with the screws to wire the power cable first.

1. Wire your power cable and insert the cable to the terminal block as shown below:

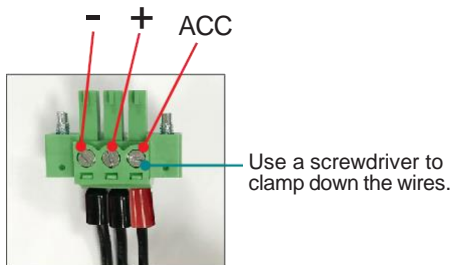

2. Plug the terminal block into the power connector and then tighten the screws to secure the terminal block in place.



For Non-Vehicle Application

For non-vehicle usage, please use the provided 3-pin terminal block with the screws to wire the power cable first.

1. Wire your power cable and insert the cable to the terminal block as shown below:

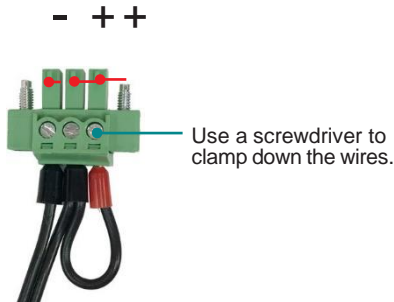

2. Plug the terminal block into the power connector and then tighten the screws to secure the terminal block in place.



2.4.3 Using Power Adapter (Optional)

If your IOT-800N comes with the optional AC-DC power adapter:

1. Connect the 3-pin terminal block of the power adapter to the DC terminal block receptacle on the device. Then tighten the screws to secure the terminal block in place.



2. Then connect the adapter to a power source.

Upon power supply, the device will be automatically turned on.

2.5 Configuring COM Port

The IOT-800N comes with two COM ports as shown below:

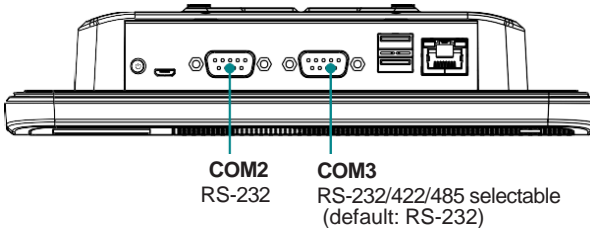

To configure the mode of COM3 or the settings like baud rate of COM2 & COM3, you have to use the **SerialPort API** as described below:

1. Launch the **Serial Port API** App by tapping the **Serial Port API** icon in the Apps section.



Getting Started

- Tap **Setup** > **Device** and then select the COM port you want to configure. To configure the mode of RS-232/422/485 COM port, select **COM3**.

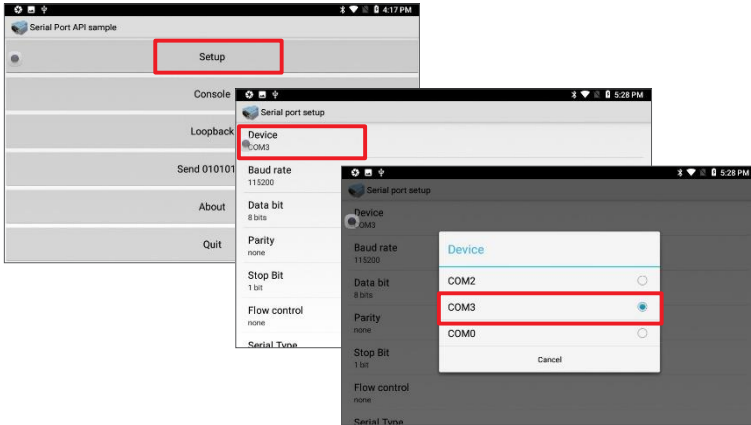

- You will return to the previous screen. Select the settings you want to configure and proceed. To configure the mode of RS-232/422/485 COM port, select **Serial Type** and then select the mode you want to use.

Indicates the port to be configured:
/dev/ttyS3: COM3 (RS-232/422/485)
/dev/ttyS2: COM2 (RS-232)
/dev/ttyS0: COM0 (Reserved)

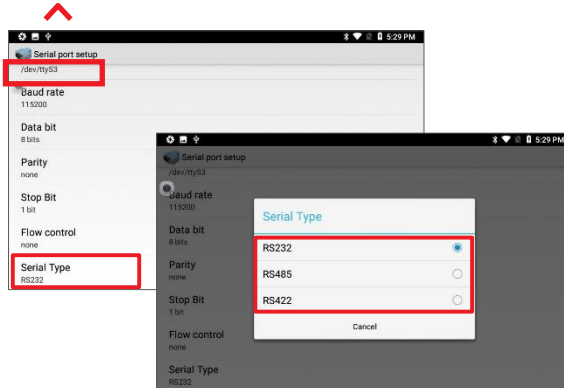

- The setting will apply immediately upon your selection.

2.6 Mounting the Device

The device is VESA 75-compliant and can be mounted on a VESA 75-compliant mounting kit using M3 screws. Or you can use the mounting holes on either side of the device to mount it.

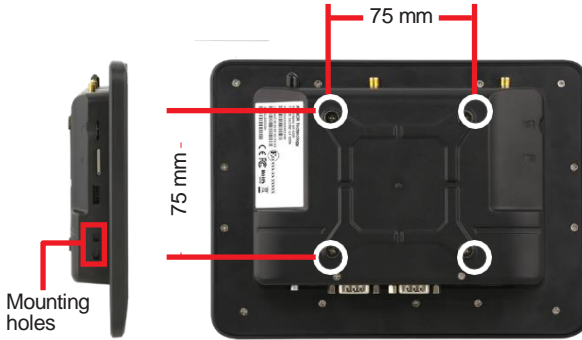

This page is intentionally left blank.

Chapter 3

Using the Device

3.1 Power On/Off and Sleep Options

Turning On the Device

Once the device is connected to a power supply, it will be automatically turned on. If the device is turned off, press the **Power** button to turn on the device.

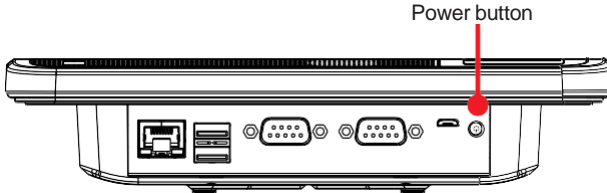

Turning Off / Restarting the Device

1. Long press the device's **Power** button or tap and hold the power button on the home screen until the power option menu appears.

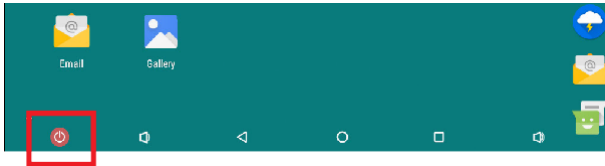

2. To turn off the device, tap the **Power Off** option. To restart the device, tap the **Restart** option.

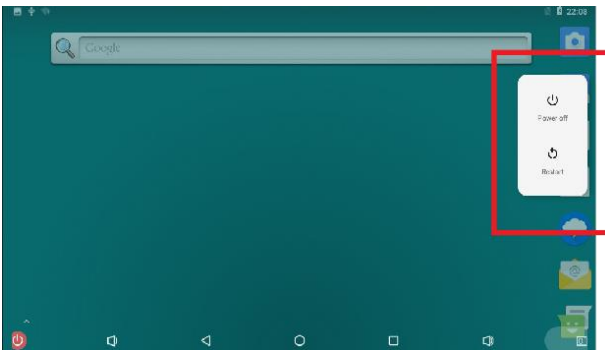

Entering/Resume From Standby Mode

To enter or resume from standby mode, just tap the power button on the home screen, or briefly press the **Power** button on the bottom side of the device.

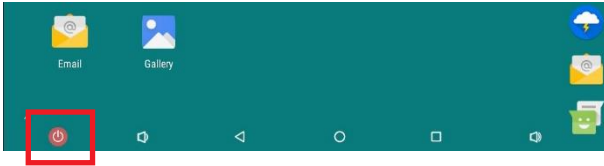

3.2 Home Screen

The **Home** screen provides you with an instant access to device status, notifications, application shortcuts, folders and widgets. Simply tap an item and you can launch the associated application. You can also add desired items to the **Home** screen, extend the **Home** screen or personalize the wallpaper to tailor it to your personal needs.



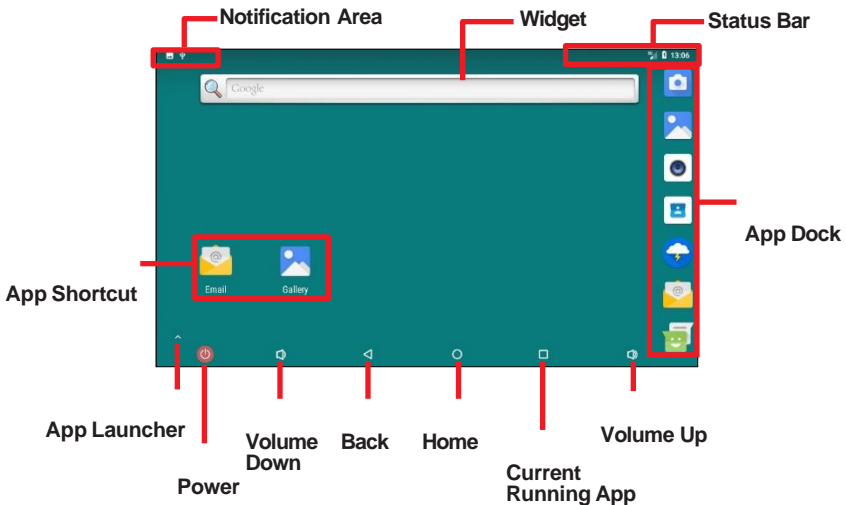







When you power on the device for the first time, a typical **Home** screen looks like the example below.



The table below describes the elements on a typical **Home** screen:

Element	Descriptions
Home Screen	<ul style="list-style-type: none">• Tap an item on this screen to launch that item.• To delete an icon or widget, tap and hold that item until the remove symbol X appears on the top left of the screen. Then move the icon to the X symbol.• Tap and hold any empty spot on this screen to customize your home screen.
Status Bar	The Status Bar displays the information such as the system time, Wi-Fi signal strength, Ethernet connection status and Bluetooth connection status.
Notification Area	The Notifications Area informs you of new messages, events, alarms, and activities in progress. Applications you install on your device may show their own icons or messages in the area. You can view the notification details by swiping down the top of the screen.
Widget	The miniature of an application that functions directly on the Home screen.
App Launcher	Tap it to open the " App Launcher " where all applications installed on the device can be viewed and launched.
App shortcut	To add an App shortcut, tap and hold the target App icon and then drag it to the Home screen area.
App Dock	The dock is visible across the home screens. It shows the most commonly used App icons for quick access. You can change the icons as needed.
Back Button	Tap to go to the previous screen.
Home Button	Tap to return to Home screen.
Current Running App Button	Tap to view show your current running Apps and touch an App to open it. To remove an App from the list, swipe it left or right.
Volume Up/Down Button	Tap to adjust the speaker volume.

3.2.1 Status Bar

Icon	Descriptions
	Bluetooth enabled
	Wi-Fi enabled
	LAN port is connected. A wired Ethernet connection will override a Wi-Fi connection.
	No SIM card installed in the device.
	Connected to a 4G network.
	"Access data using mobile network" not enabled
	SIM card is locked.
	Cellular network icon when Wi-Fi is enabled
	Roaming on a service provider's partner network.
	Power icon. Swipe down and you can see the voltage information. Note: The device doesn't come with a battery inside. It always has to be connected to a power source for power supply.

3.2.2 Using the Quick Settings Panel

Swiping down the top of the screen will bring up a **Quick Settings** panel where you can quickly access some most commonly used settings and features. To enable/disable a feature or switch between available options, simply tap the intended icon. It appears dimmed when disabled and brightened when enabled.

For some features such as Wi-Fi, Bluetooth, location, mobile data, you can also tap and hold the tile to directly access the settings page.

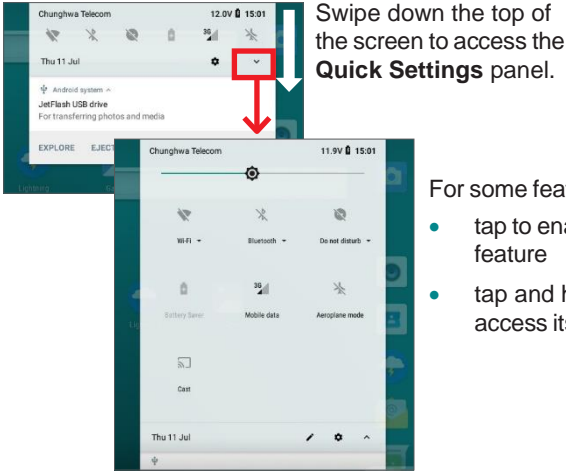

For some feature tiles, you can

- tap to enable/disable a feature
- tap and hold to quickly access its settings page

3.2.3 Viewing Power Voltage

To view the voltage of the power supplied to the IOT-800N, swipe down the top of the screen to access the **Quick Settings** panel and you can see the voltage information displaying next to the battery icon.

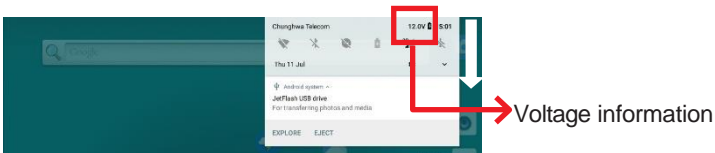

You can also configure the IOT-800N to show voltage information in the status bar. To do so, tap **Settings** | **Battery** and turn on the **Battery Voltage** option.

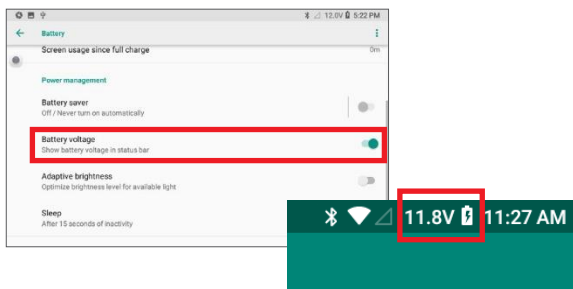



3.3 Configuring Your SIM Card (for IOT-800N LTE Only)

Before proceeding, make sure you have inserted a SIM card to the device and installed the 4G antenna properly.

After you insert the SIM card to the device for the first time and power on the device, the device will detect the SIM card and a cellular network icon will be displayed in the status bar. Possible icon status include:



Icon	Descriptions
	The device is successfully connected to a 4G network but "Access data using mobile network" not enabled. See 3.3.1 Enabling Data Access Over Mobile Network on page 29 to enable the function.
	The SIM card is locked and you need to enter the PIN code to use it. See 3.3.2 Using a Locked SIM Card on page 30 for more information.
	The device is successfully connected to a cellular network and you can access data using the cellular network

3.3.1 Enabling Data Access Over Mobile Network

To access data using your mobile network, make sure you have enabled data access over mobile network.

Data access over mobile network not enabled



Data access over mobile network enabled



Using the Device

To enable mobile data access function, tap **Settings | Mobile data is off** and then turn on the function.

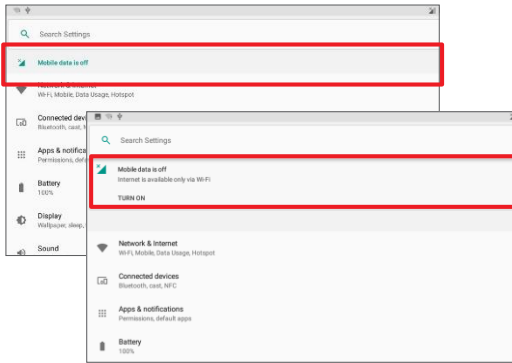

You can also tap **Settings | Network & Internet | Mobile Network** and enable **Mobile Data** option. At this page, you can also configure other settings like data roaming or preferred networks.

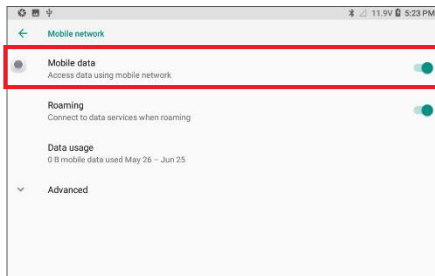

3.3.2 Using a Locked SIM Card

If you are using a locked SIM card:

- The cellular network icon will appear as  in the status bar until you enter a PIN code to unlock it.
- Each time you power on the device, a PIN code prompt will appear (if the prompt doesn't appear, wait a while for the system to show the prompt).
- You can't proceed to use the device unless the PIN code is correctly entered.

- If you don't know the PIN code, contact your cellular network carrier for the information.
- If you enter the PIN incorrectly three times, the SIM card will be blocked. Please contact your cellular network carrier for a personal unblocking code to unblock the card.
- To eliminate the need of entering PIN code each time you power on the device, refer to [3.3.3 Disabling SIM Card Lock on page 31](#) to disable the SIM card PIN.

After entering the PIN code, tap ✓ . If the PIN code is correct, then the SIM card will be unlocked and you can proceed to use the device.

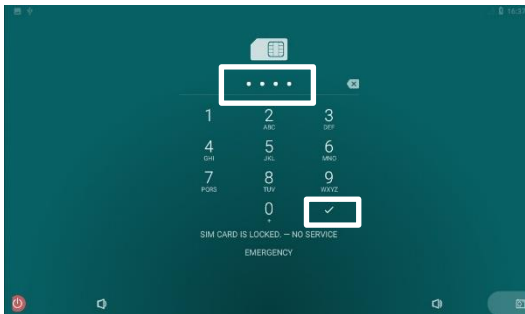

3.3.3 Disabling SIM Card Lock

If you are using a locked SIM card, you can disable the SIM PIN by the steps below:

1. Tap **Settings | Security & Location | SIM card lock**.
2. Toggle the **Lock SIM card** option and then enter the PIN code when prompted.

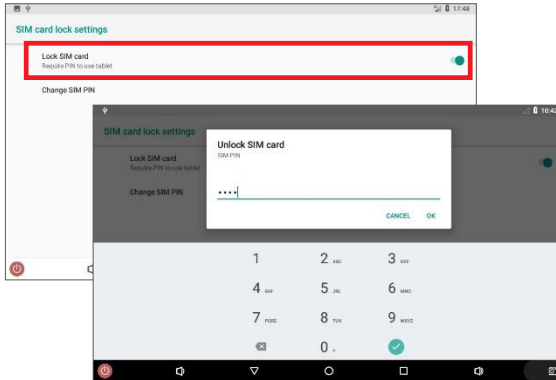

3. The following screen indicates the SIM card lock is disabled.

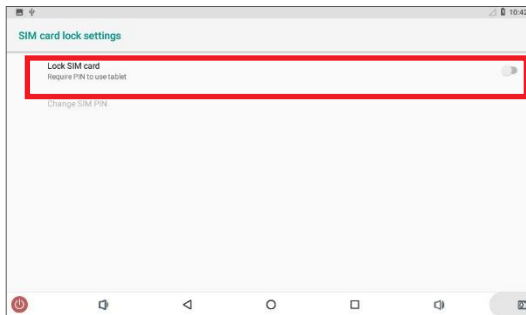

3.3.4 Configuring APN Settings

In case you need to configure APN (Access Point Name) settings: tap **Settings | Network & Internet | Mobile network | Advanced | Access Point Names** and then select the target APN option. If you don't know which APN to use, please contact your cellular carrier to obtain the information.

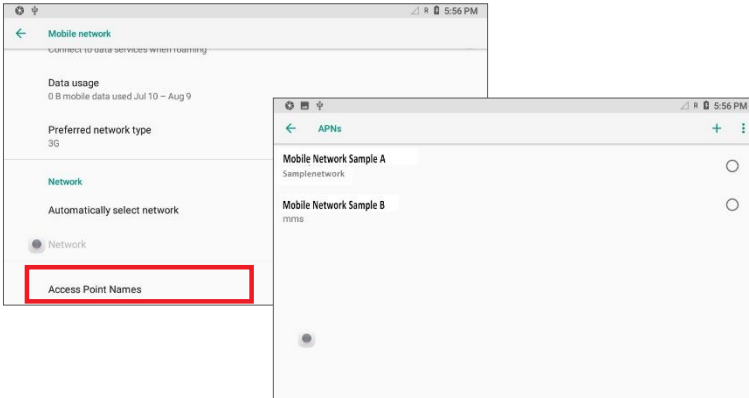

3.4 Enabling Wi-Fi and Connecting to a WLAN

Before using the Wi-Fi feature, make sure your device is connected with the Wi-Fi antenna.



To use the Wi-Fi feature, switch on the Wi-Fi function on the **Settings** page. Then tap a network to connect to it. To connect to a secured network, you will be prompted to enter a password or other credentials.

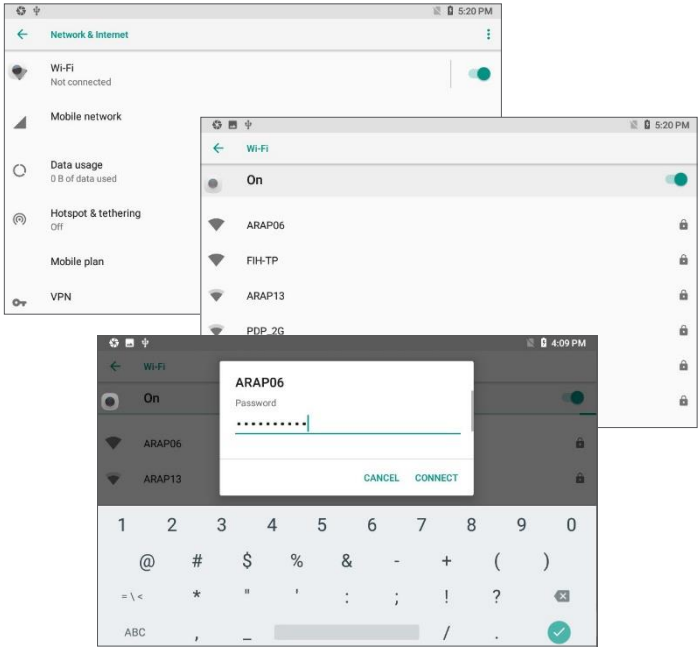

3.5 Enabling Bluetooth and Pairing with Bluetooth Device

The Wi-Fi antenna supplied with the device is a hybrid antenna for both Wi-Fi and Bluetooth signals. Before using the Bluetooth feature, make sure your device is connected with the Wi-Fi (Bluetooth) antenna.



1. Switch on the Bluetooth feature on the **Settings** page. Then tap **Pair new device**.

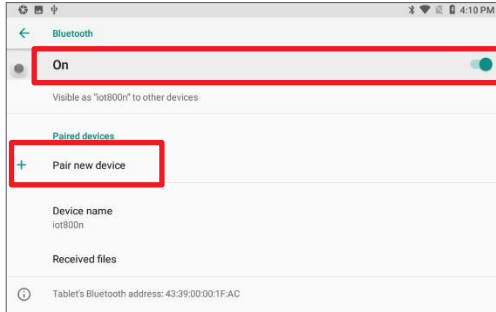

2. The IOT-800N proceeds to scan for any Bluetooth device in range. Then it displays the names of the device(s) found. Tap the device you want to pair with.

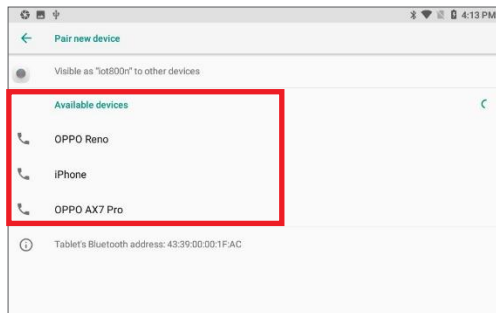

3. When a pairing code dialog box appears, tap **Pair**. The IOT-800N will then send a connection request to the device you want to pair with.

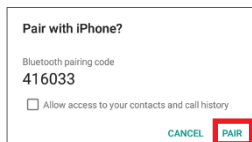

On the device to pair with, a dialog box appears requesting to enter or verify the pairing code. The passkey entered or shown on the IOT-800N and the Bluetooth device must be the same.

Then the devices proceed to pair with each other.

3.6 Connecting to a Network via LAN Port

To use the LAN port to connect to your local network, you will need to configure the network settings according to your network environment. To configure the network settings:

1. Tap **Settings | Network & Internet | Ethernet**. Scroll the page down to locate the **Ethernet IP mode** option.

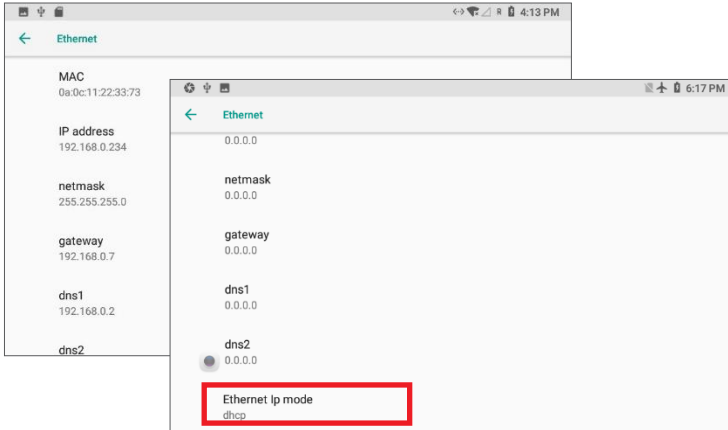

2. Tap **Ethernet IP mode** and select a IP mode according to your network environment.

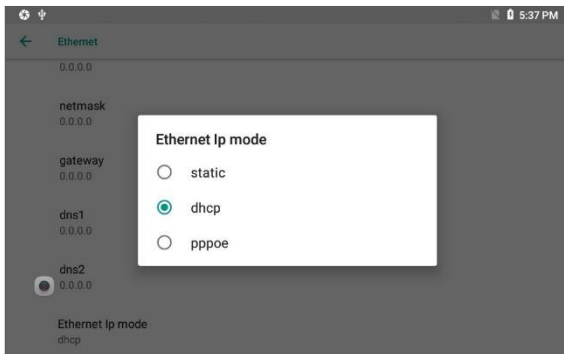

To use a static IP address, tap **static** and then configure the required settings. When you're done with the settings, tap **CONNECT**.

Scroll down to configure more settings such as gateway, netmask, etc.

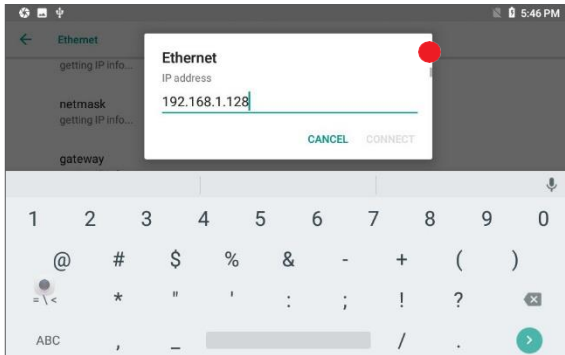

To obtain a dynamic IP address from a DHCP server, select **dhcp**. Then you will be taken back to the previous screen.

To use PPPoE mode, select **pppoe**. Then you will be taken back to the previous screen.

3. When a wired LAN connection is established, the Wi-Fi connection will be disconnected and an wired network icon will be displayed in the status bar.

A wired Ethernet connection is established



Wi-Fi connection will be terminated

3.7 Using the GPS Feature (For IOT-800N LTE)

The IOT-800N LTE features GPS positioning function to identify its location. It allows location-based Apps to collect and use your location information to provide location-related service.

To use the GPS function:

1. Make sure your device is connected with the GPS antenna.



2. Turn on the location service by tapping **Settings | Security & location | Location** and turn on the service.

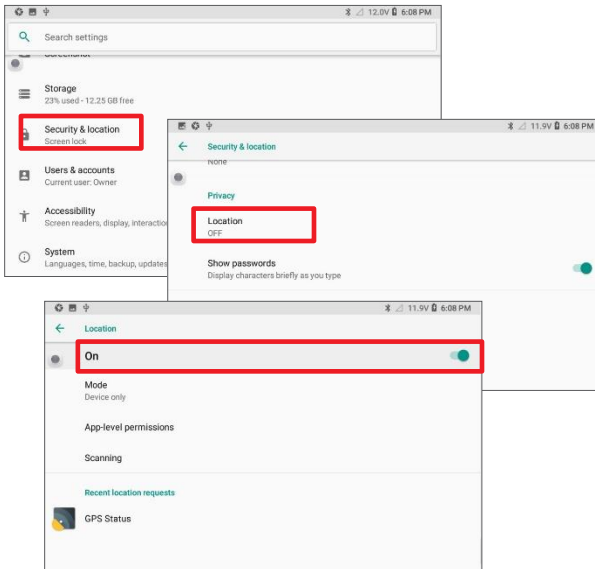

To test the GPS function, you can use the provided **GPS Status** App:

1. As the positioning must be done outdoor to receive satellite signal, please place the device outdoor or in an environment close to outdoor.
2. Launch the **GPS Status** App by tapping the **GPS Status** icon in the Apps section.

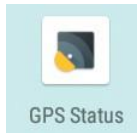

3. Wait for the GPS to get the positioning information. It takes a while (about 180 seconds) to get the positioning to work for the very first time.

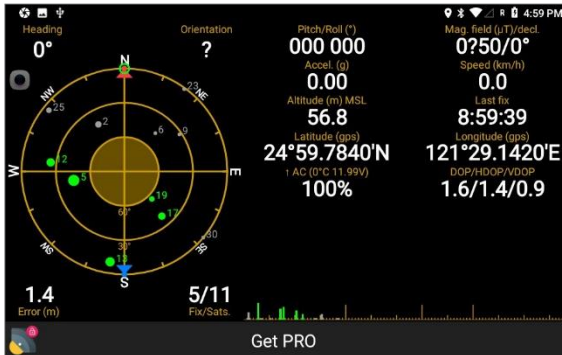

Note: The GPS Status App is provided for basic GPS positioning. To get more accurate information about the location, please use other third-party positioning App.

3.8 Enabling and Using the NFC Features

To use the NFC feature, you need to enable the data exchange function. Tap **Settings | Connected devices** and turn on the "**Allow data exchange when the tablet touches another device**" function. You can also enable the **Android Beam** function as needed.

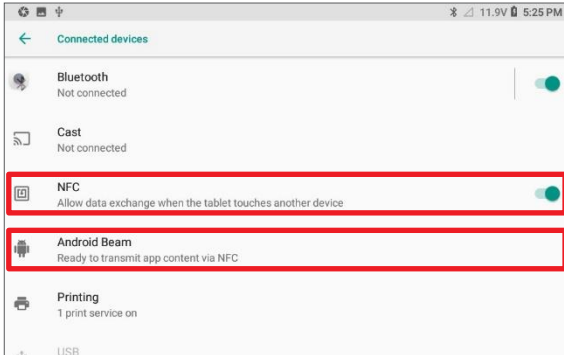

The NFC reader is at the lower left corner of the IOT-800N. When you tap other NFC devices, tags, or readers, the NFC areas of both devices should be close to one another so that the connection can be established.

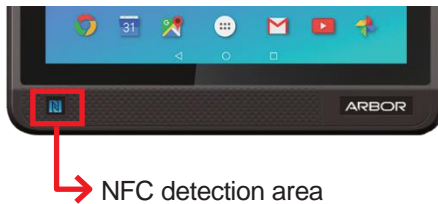

To test the NFC function, you can use the provided **NFC SmartCard Info** App to test the NFC.

1. Launch the **NFC SmartCard Info** App by tapping the **NFC SmartCard Info** icon in the Apps section.



2. Bring your NFC device close to the NFC detection area on the IOT-800N. Then the information of the device's tag will be displayed.

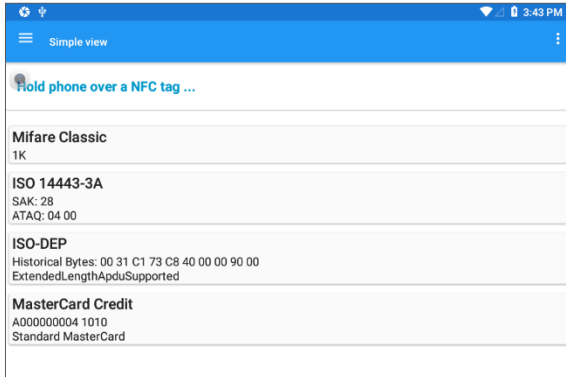

3.9 Using the Camera Feature

The device is equipped with a front-facing camera. This section describes how to take pictures or videos using the native camera App.

1. Launch the camera App by the **Camera** icon in the Apps section.
2. The camera application then opens. A typical screen is as shown as below:

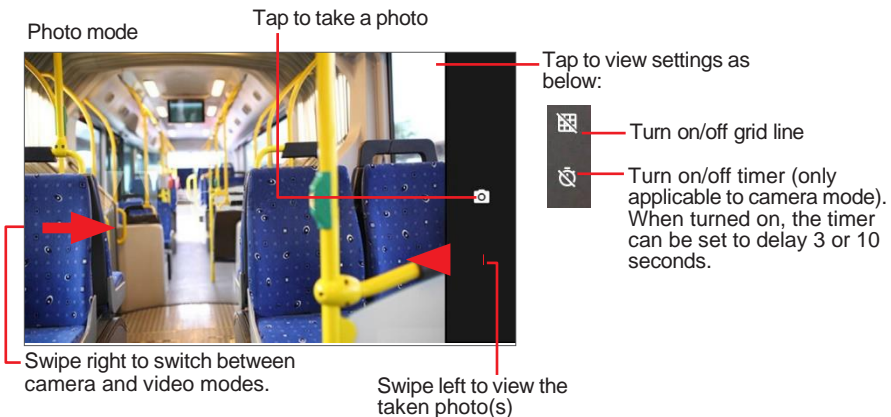

3. If needed, you can move two fingers apart to zoom in or move two fingers closer together to zoom out.
4. To configure advanced settings, swipe the screen right and then tap the **Settings** icon in the upper right corner.



Tap to configure advanced settings

In the **Settings** screen, you can configure the image resolution & quality, saved location, and advanced settings.

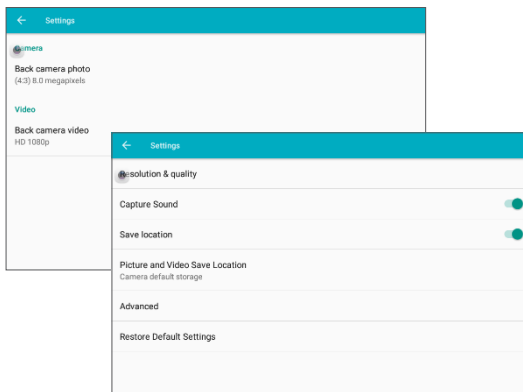

5. To take a photo, tap the camera icon.
6. To view the photo(s) just taken, swipe left the screen.

3.10 Ignition Management

For vehicle usage, please refer to the diagram below for the IOT-800N's ignition management.

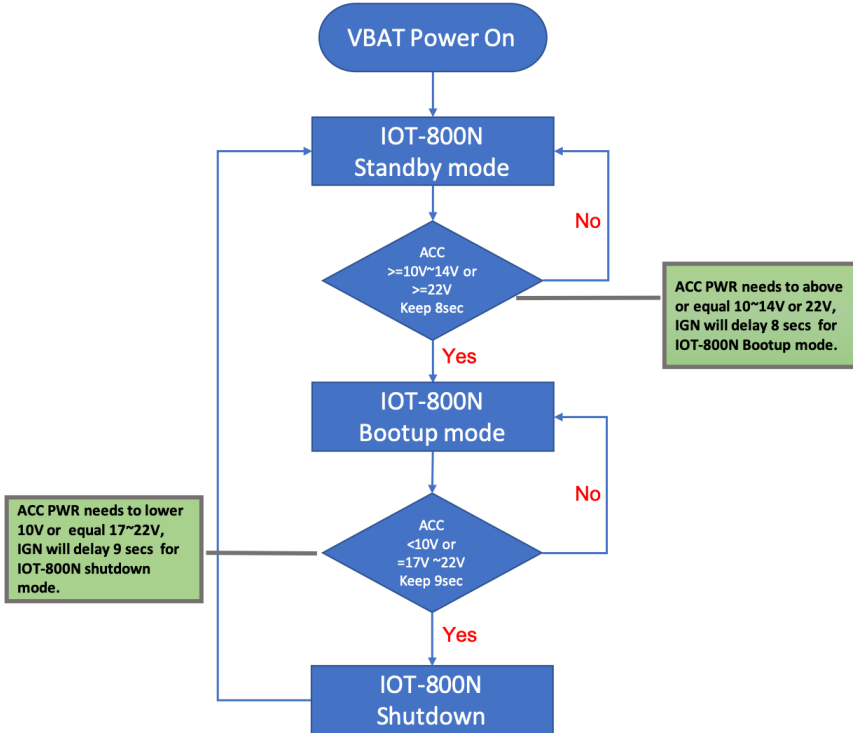

This page is intentionally left blank.



Chapter 4



Troubleshooting

1. 4G connection cannot be established.

Make sure your SIM card is inserted correctly.

Make sure the device is connected to the 4G antenna (provided with IOT-800N LTE) and the antenna is connected to correct connector.

2. Cannot access data using cellular network.

Make sure you have enabled data access using mobile network. To enable the setting, tap **Settings | Network & Internet | Mobile Network** and toggle the **Mobile Data** option to ON.

3. SIM card is locked.

If using a locked SIM card, you need to enter the PIN code to unlock it. If you don't know the PIN code, contact your cellular network carrier for the information.

4. Is the SIM card slot hot pluggable?

The SIM card slot is not hot-pluggable. Before inserting or removing a SIM card, always power off the IOT-800N first.

5. No microSD card is detected after I inserted a microSD card

The microSD card slot is not hot-pluggable. If an inserted microSD card is not detected, restart the device and you should be able to see the card detected.