

# User Manual

Body Fat Analyzer

GBF-1714-F

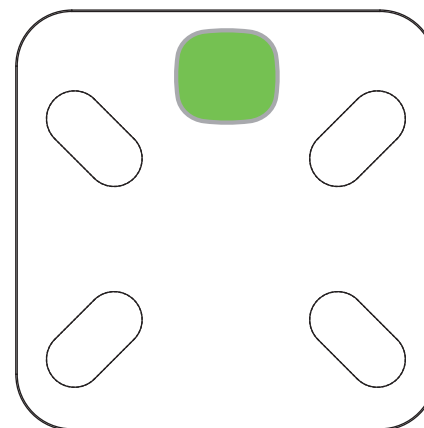

- Thank you very much for selecting the Transtek Body Fat Analyzer GBF-1714-F.
- Please do read the user manual carefully and thoroughly so as to ensure the safe usage of this product, and keep the manual well for further reference in case you have problems.









# Table of Contents

- Safety Information**
- Safety and Usage Information ..... 2
- Tips ..... 3
- Overview**
- Device Components ..... 4
- List ..... 4
- LCD Display ..... 5
- Initial Start-Up**
- General Instructions ..... 6
- Insert the Batteries ..... 6
- Select Measurement unit ..... 7
- Configure the Wi-Fi Password ..... 7
- Start Measuring**
- Start Measuring ..... 9
- Daily Measurement ..... 10
- Weight Only Operation ..... 10
- Data Management**
- Data Transmission ..... 11
- Troubleshooting**
- Error Prompt ..... 12
- When Measuring ... ..... 12
- When Data Transmitting ... ..... 13
- Specifications** ..... 14
- Maintenance** ..... 15
- Warranty** ..... 15
- Appendix**
- Health Tips - About Body Fat ..... 16
- Health Tips - About Body Water ..... 17
- Health Tips - About Muscle Mass ..... 18
- Health Tips - About Bone Mass ..... 18
- Health Tips - About BMI ..... 19
- FCC Regulations ..... 20
- Warning ..... 21

♥ Safety and Usage Information

The warning signs and symbols are essential to ensure your correct and safe use of this product and protect you and others from injury. Please kindly find the meanings of the warning signs and symbols, which you may encounter in the label and user manual, as follows:

	Symbol for "THE OPERATION GUIDE MUST BE READ"		Symbol for "MANUFACTURER"
	Symbol for "DIRECT CURRENT"		Symbol for "TYPE BF APPLIED PARTS"
	Symbol for "MANUFACTURE DATE"		Symbol for "ENVIRONMENT PROTECTION – Waste electrical products should not be disposed of with household waste. Please recycle where facilities exist. Check with your local authority or retailer for recycling advice"
<b>SN</b>	Symbol for "SERIAL NUMBER"		

 CAUTION

Transtek's Body Fat Analyzer GBF-1714-F offers you a seamless way to manage your health. Please be aware that this device is designed for healthy population over 10 years old self-measuring and self-monitoring body compositions. Any information provided by this device is in no way meant to treat, cure or prevent any disease or illness from happening. If in doubt, contact your physician.

This device is contraindicated for any female subject who may be suspected of, or is pregnant. Otherwise, the effects of this device on the fetus are unknown.

This device is contraindicated for any person who is connected to a wearable or implantable electronic device or instrument such as a pacemaker or defibrillator.

This device should not be used for anyone who is acutely or chronically ill because of suffering from a disease or taking medications that affect your water levels. The accuracy of readings for these patients has not been verified. Specific medical advice should be obtained from a physician.

Manufacturer will make available on request circuit diagrams, component parts list, etc.

**WARNING:**No modifications of this equipment is allowed. This may result in increased EMISSIONS or decreased IMMUNITY of GBF-1714-F.

Please use the device according to the user manual. Any misuse can cause electric shock, burns, fire and other unexpected hazards.

Please use and storage the device under the environment which was provided in the user manual. Don't expose the device to extreme temperatures, direct sunlight, moist or corrosive environment. Do not step on the scale when your body or feet are wet, especially after bathing or showering to prevent slipping.

Please keep the device out of reach of infants, children or pets, since inhalation or swallowing of small parts is dangerous or even fatal.

Please don't use the device out of lifetime any more because degraded sensors and electrodes, or loosened electrodes can degrade performance or cause other problems.

If you have an allergy to stainless steel, please avoid to contact to the electrodes of the device. The patient is an intended operator. The patient can measure, and charge battery under normal circumstances and maintain the device and its accessories according to the user manual.

INDICATIONS FOR USE

- The Transtek Body Fat Analyzer measures weight and estimate BMI and calories, and uses bio-electrical impedance analysis (BIA) technology to estimate body fat, total body water percentage, bone mass, and muscle mass in generally healthy children 10-17 years old and healthy adults.
- It is intended for use in the domestic setting only.

CONTRAINDICATIONS

1. This device is contraindicated for any female subject who may be suspected of, or is pregnant. Besides provided inaccurate readings, the affects of this device on the fetus are unknown.
2. This device is contraindicated for any person who is connected to a wearable or implantable electronic device or instrument such as a pacemaker or defibrillator.

♥ Your Scale and Its Environment

**To ensure your safety as well as the service life of your scale, please avoid using the scale under the following circumstances:**

- Slippery floor such as tile floor
- Jumping onto the platform immediately after bath or with wet feet
- Near a cell phone or microwave oven

**Avoid storage in the following locations:**

- Where there is water
- Where the device may be exposed to extreme temperatures, humidity, moisture, direct sunlight, dust, or salt air
- Where there is risk of shock or drop
- Where you store chemicals or full of corrosive gases
- Where in reach of the infants or children

♥ Efficient Use of Your Scale

**To ensure the accuracy of measurement, please follow below instructions when you start measurement.**

- Place the scale on a flat, hard surface. Soft surface such as carpet will affect the performance of the scale.
- Step onto the platform with bare feet. Stand still and keep full contact with the scale until the measurement is complete.
- Start measurement at least two hours after Getting up or Dining.
- Avoid measurement immediately after strenuous exercise, sauna or bath, drinking, and dining.
- Always start measurement in the same time slot and on the same scale located on the same flat, hard surface.

♥ Device Components

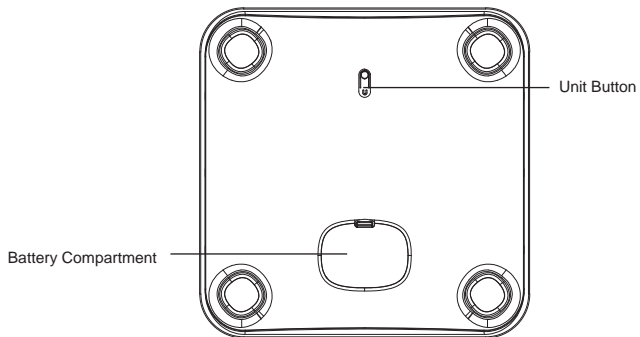
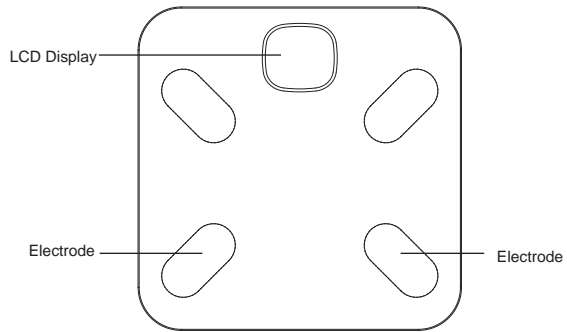



♥ List

1. Body Fat Analyzer GBF-1714-F
2. Three AAA-size Batteries (1.5V per each)
3. User Manual

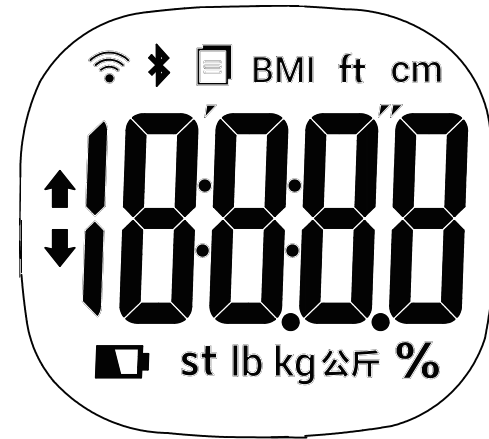
♥ LCD Display



<b>kg</b>	Kilogram		Wifi Connection
<b>st lb</b>	Stone		Data pending to transmit to smartphone
<b>lb</b>	Pound		Low Battery

## ♥ General Instructions

Transtek Body Fat Analyzer GBF-1714-F applies BIA (Bio-impedance Analysis) technology. A small amount of weak current flows through the human body so as to detect the bio-impedance and estimate BMI, body fat, body water, muscle mass, bone mass and BMR. The electrical current is small and may not be felt.

This BIA technology is cheap, safe, non-invasive, toxic-free and harmless. It also possesses the characteristics of simple operation and abundant information.

The current mentioned above is less than 0.5mA. However, please be aware that anyone with an wearable or implantable medical electronic instrument, such as a pacemaker, must avoid using this device.

The intended use of this device is for healthy children 10-17 years old and healthy adults.

## ♥ Insert the Batteries

- Open the battery door in the back of the scale.
- Remove insulating strip from beneath the battery (if fitted) or insert batteries (3 x 1.5V AAA) observing the polarity signs (+ and -) inside the battery compartment.

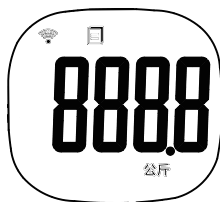

- Close the battery door and wait until the digits "0.0kg" are shown on the LCD.

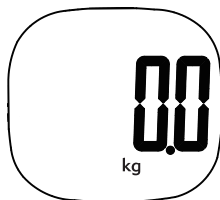

### ⚠ CAUTION

- When the symbol "🔋" appears, the device will power off in about 4s. Then you shall replace with a new set of batteries. Please replace all three batteries at the same time. Do NOT mix the old batteries with the new one.
- Worn batteries are hazardous waste. Do NOT dispose of them together with the household garbage.
- Please refer to the local ordinances and recycling instructions regarding disposal of the worn batteries and scrapped device.
- If you do not intend to use this unit for a prolonged period of time, it is advisable to remove the batteries before storing.

## ♥ Select Measurement Unit

After the Wi-Fi password is configured successfully, you can select measurement unit through pressing the unit button back of the scale. You can choose kilogram, pound and stone as your measurement unit.

## ♥ Configure the Wi-Fi Password

1. Install the App "Smart Life". This App could be freely downloaded at the APP Store, you may search and install it in your smartphone.

2. Register an account. Then follow these steps:

Note: Take the latest version of APP as the criterion.



3. Then long press the button in the back of the scale, the icon  $0^{\square}$  and icon  $0^{\square} 0$  will be shown on the LCD alternatively, and the Wi-Fi icon  $\text{Wi-Fi}$  blinks as well, indicating configuration is proceeding.

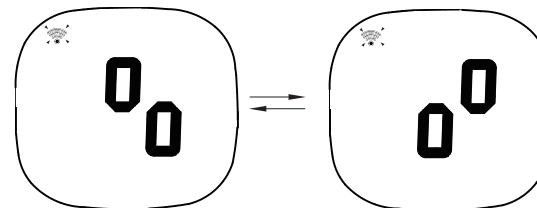

4. Then you can pair up your scale with your smartphone through the following steps:



Note: If the Wi-Fi icon  blinks slowly on the LCD, you can click the top right corner "AP Mode" to pair up your scale.

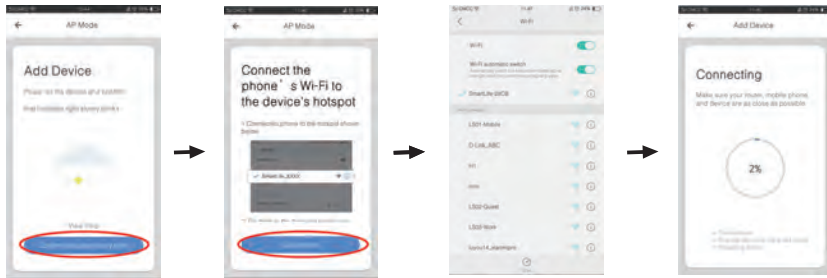

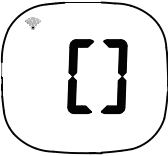
• If SUCCEED, icon  will be shown on the LCD, and the Wi-Fi icon will stop blinking and keep on.

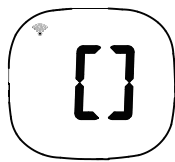

• If FAIL, symbol "Conf" will be shown on the LCD. (Please refer to [Troubleshooting](#) for more)



## ♥ Start Measuring

STEP 1: Step on the platform barefooted.



STEP 2: Make sure your Wi-Fi is connecting, the results will send to the phone's APP.

STEP 3: Set your personal information at the APP, and click latest measurement record to distribute your User ID.



Note: You can also click lower right corner "Setting" to open "Distribute Automatically", after opening, data will be automatically allocated according to body weight deviation (within +/-2 kg). This is an automatic and manual allocation scheme.

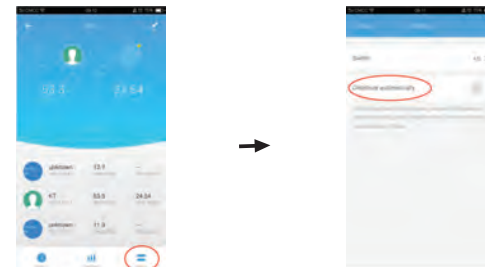

♥ Daily Measurement

- With original SENSE ON patent technology, GBF-1714-F will automatically switch on as you step on the platform barefooted.
- Stand still and keep full contact with the electrodes until the LCD displays the weight.

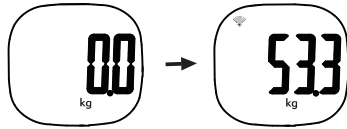

- Make sure your Wi-Fi is connecting, the analysis results will automatically identify the User ID which you had set. The results are also sent to the phone's APP.

♥ Weight Only Operation

Your TRANSTEK Body Fat Analyzer will operate as a conventional weight - reading scale. No special programming steps are required.

Once the scale is initialized, as previously described, you may simply step on the scale to measure your current weight. For only weight reading.

1. Position the scale on a flat, hard surface. Carpeted or uneven floors may affect accuracy.
2. Step onto the scale platform and remain still while the scale computes your weight.
3. The scale will display your weight value.

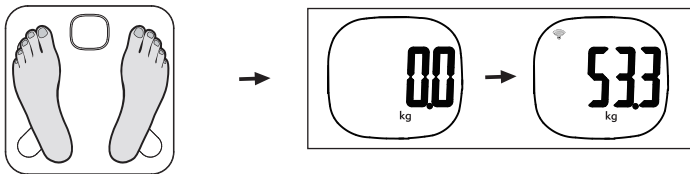





4. The scale will automatically turn off after a few seconds.

♥ Data Transmission

- Please open the App and turn on your Wi-Fi, so that the Body Scale GBF-1714-F can successfully connected to your smartphone. Keep smartphone and scale in transmission distance. Step on the scale and take a measurement. Once the measurement is finished the data is automatically transferred to the app.



- If the data transmission fails, the symbol  will remain. The pending measurement data will be temporarily kept in the scale and transmitted to your smartphone when next measurement is complete.
- The symbol  will disappear after successful data transmission, and you may check your personal health data stored in your smartphone.

	Successful Wi-Fi Connection
	Data ready to transmit to the App: -If SUCCEEDED, the symbol disappears; -If FAIL, the symbol remains.



 CAUTION

- Interference may occur in the vicinity of equipment marked with the following symbol . And the Analyzer may interfere vicinity electrical equipment.
- To enable the data transmission function, only 2.4G WI-FI network is supported.

**How to mitigate possible interference?**

1. The range between the Analyzer and the Wi-Fi end should be reasonably close, from 1 meter to 10 meters. Please ensure no obstacles between the Analyzer and the Wi-Fi end so as to obtain quality connection.
2. To avoid interference, other electronic devices (particularly those with Wi-Fi transmission / Transmitter) should be kept at least 1 meter away from the Analyzer.

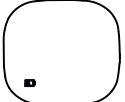
♥ Error Prompt

Error	Description	Solution
	Overload. The device will power off.	Stop using this scale for measurement.
	Low Battery. The device will power off in four seconds.	Replace all three batteries at the same time. Please purchase the authorized batteries for replacement.
	Wi-Fi connection fail.	Rejoin Wi-Fi network.

♥ When Measuring ...

Problem	Root Cause	Solution
Abnormal measuring results: - Too high; OR - Too low; OR - Huge difference between two recent measurement.	Incorrect posture	Please step on the platform barefooted and stand still.
	The device is located on the soft ground such as a carpet OR on a rugged surface.	Please place the device on a flat, hard surface.
	Cold body that may results in bad blood circulation.	Warm up your hands and feet to resume blood circulation and then measure again.
Abnormal measuring results: - Too high; OR - Too low; OR - Huge difference between two recent measurement.	Cold Electrodes.	Place the device in a warm room for a while and then measure again.
	Your feet are too dry.	Wipe your feet with a damp cloth, keeping them slightly damp when starting measurement.

Problem	Root Cause	Solution
No display on LCD when the device powers on.	Batteries not yet installed.	Install the batteries. (Please refer to <a href="#">Insert the Batteries</a> )
	Worn batteries.	Replace all three batteries at the same time. Please purchase the authorized batteries for replacement.
CANNOT proceed to analyze BMI, body fat, total body water, muscle mass and bone mass.	Step onto the platform wearing socks or shoes.	Please keep barefooted during the measurement, and keep full contact with the electrodes as well.
	The user fails to select the User ID from what the system found.	Please assign a User ID.
The device powers off automatically.	Low battery.	Replace all three batteries at the same time. Please purchase the authorized batteries for replacement.

♥ When Data Transmitting ...

Problem	Root Cause	Solution
Data transmission failed.	Wi-Fi is OFF.	Open the Wi-Fi.
	The App is OFF.	Press the icon to turn ON your app.
	Out of range of Wi-Fi transmission.	Place your smartphone closer to the scale.
	None of the user ID is assigned.	Please assign a User ID.



## ♥ Specifications

<b>Product Name</b>	Body Fat Analyzer
<b>Dimension</b>	Scale: 300x300x28mm (Approximately)
<b>Net Weight</b>	Approximately 1.77kg
<b>Display</b>	Digital LCD
<b>Measurement Unit</b>	Kilogram / Stone/ Pound
<b>Measurement Range</b>	5kg to 180kg / 0st: 11lb to 28st: 5lb / 11lb to 397lb
<b>Division</b>	0.1kg; 0.2 <sup>st</sup> / <sub>lb</sub> ; 0.2lb
<b>Accuracy</b>	50kg: ±0.3kg;                      100kg: ±0.4kg; 150kg: ±0.5kg;                      180kg: ±0.7kg
<b>Working Environment</b>	Temperature: 5°C to 40°C    Relative Humidity: ≤90% RH Atmospheric pressure: 86kPa to 106kPa
<b>Storage Environment</b>	Temperature: -20°C to 60°C    Relative Humidity: ≤90% RH Atmospheric pressure: 50kPa to 106kPa
<b>Power Source</b>	4.5V (Three AAA-size Batteries)
<b>Auto-ON</b>	SENSE ON technology / Power on
<b>Auto-OFF</b>	The scale will turn off after about 10s if there is no operation.
<b>Accessories</b>	1. Three AAA Size Batteries 2. User Manual
<b>Mode of Operation</b>	Continuous Operation
<b>WLAN Frequency Range</b>	2.412-2.462GHz
<b>Antenna Gain</b>	0 dBi
<b>Module No</b>	TYWE3S
<b>WLAN Supply Voltage</b>	3.0-3.6V
<b>Software Version</b>	A04
<b>Service Life</b>	About 5 years

**About the Accuracy of This Product**

• This product passes strict inspection before delivery and therefore its accuracy is guaranteed by the manufacturer. Please refer to the above table for the descriptions on accuracy.

• This product is specially designed for body fat analysis as well as weight measurement. It should NOT be used by anyone during the process of transaction for verification of goods' weight.

## ♥ Maintenance

When carrying out usual maintenance, please ensure practice of the following Do's and Don'ts:

- DO use a dry soft cloth to wipe the dust.
- DO use a wet soft cloth, dipped into water and wrung out, to wipe the dirt. Then use a dry soft cloth to dry up the device.
- DON'T wash the device with water or immerse it in water.
- DON'T use propellant, abrasive or other chemicals to wipe the dirt in avoidance of discolor or malfunction.
- DON'T disassemble this device. If you have any problems, please contact Transtek.  
(Please refer to Warranty for contact information)

## ♥ Warranty

- Transtek warrants its products free of defects in materials and workmanship in normal use for a period of FIVE years from the date of retail purchase.
- This warranty does NOT cover damages caused by misuse or abuse, including but not limited to:
  - Failure caused by unauthorized repairs or modifications;
  - Damage caused by shock or drop during transportation;
  - Failure caused by improper operation inconsistent with the instructions stated in this user manual;
  - Malfunction or damage from failure to provide the recommended maintenance;
  - Damage caused by improper use of power supply.
- Should this device require maintenance (or replacement at our option) under warranty, please deliver the original package to ZHONGSHAN TRANSTEK ELECTRONICS CO., LTD prepaid. Please return the store receipt (with the retail purchase date) and a note with reasons to return on it as well.

ZHONGSHAN TRANSTEK ELECTRONICS CO., LTD  
No.23,Jin'an Road, Minzhong, Zhongshan, 528441, Guangdong, China  
Tel: 86-760-88282982  
Website: <http://www.transtek.cn>

## ♥ Health Tips - About Body Fat

Human body is made up of, amongst other things, a percentage of fat. Body fat is vital for a healthy, functioning body, protects vital organs, helps regulate body temperature, stores vitamins and helps the body sustain itself when food is scarce. However, too much body fat or indeed too little body fat will damage to your health. It is difficult to gauge how much body fat we have in our bodies simply by looking at ourselves in the mirror.

This is why it is important to measure and monitor your body fat percentage. Body fat percentage gives you a better measure of fitness than weight alone—the composition of your weight loss could mean you are losing muscle mass rather than fat—you could still have a high percentage of fat even when a scale indicates 'normal weight'.

The table as follows may be used as a guide:

Table of Body Fat Level (Unit: %)

a) The body fat percentage (%): 5%-60%/0.1%

### Standard for Men

Rating	Age				
	20-29	30-39	40-49	50-59	60+
low	<13	<14	<16	<17	<18
Normal	13-20	14-21	16-23	17-24	18-25
Moderately High	20.1-23	21.1-24	23.1-26	24.1-27	25.1-28
High	>23	>24	>26	>27	>28

### Standard for Women

Rating	Age				
	20-29	30-39	40-49	50-59	60+
low	<19	<20	<21	<22	<23
Normal	19-28	20-29	21-30	22-31	23-32
Moderately High	28.1-31	29.1-32	30.1-33	31.1-34	32.1-35
High	>31	>32	>33	>34	>35

Source: University of Illinois Department of Food Science and Human Nutrition. Body Fat Percentage Calculator.

[www.ag.uiuc.edu/~food-lab/ai/bfc.html](http://www.ag.uiuc.edu/~food-lab/ai/bfc.html)

## ♥ Health Tips - About Body Water

Body water is the single most important component of body weight. It represents over half of your total weight and almost two thirds of your lean body mass (predominantly muscle). Water performs a number of important roles in the body:

All the cells in the body, whether in the skin, glands, muscles, brain or anywhere else, can only function properly if they have enough water. Water also plays a vital part in regulating the body's temperature balance, particularly through perspiration.

The combination of your weight and fat measurement could appear to be 'normal' but your body hydration level could be insufficient for healthy living.

The table as follows may be used as a guide:

Table of Body Water Level (Unit: %)

b) The body water percentage (%): 43%-73%/0.1%

Source: Derived from Wang & Deurenberg: "Hydration of fat-free body mass". American Journal Clin Nutr 1999,69:833-841.

	BF % RANGE	OPTIMAL TBW % RANGE
Men	4 to 14%	70 to 63%
	15 to 21%	63 to 57%
	22 to 24%	57 to 55%
	25 and over	55 to 37%
Women	4 to 20%	70 to 58%
	21 to 29%	58 to 52%
	30 to 32%	52 to 49%
	33 and over	49 to 37%

♥ Health Tips - About Muscle Mass

According to the American College of Sports Medicine (ACSM), lean muscle mass may decrease by nearly 50 percent between the age of 20 and 90. If you do nothing with it you're losing muscle and increasing fat. It is also important to know your muscle mass % during weight reduction. At rest, the body burns approximately 110 additional calories for each kilo of muscle gained. Benefits of gaining muscle mass include:

- Reversing the decline in strength, bone density and muscle mass with aging
- Maintenance of flexible joints
- Guide weight reduction when combined with a healthy diet.

The table as follows may be used as a guide:

Muscle Mass Percentage

(Source: International Commission on Radiological Protection,1975)

<b>Men</b>	<b>Approximately 40% of total body weight</b>
<b>Women</b>	<b>Approximately 30% of total body weight</b>

♥ Health Tips - About Bone Mass

Regular exercise and a balanced diet can help maintain healthy bones. Like muscle, bone is a living tissue that can respond to exercise by becoming stronger. For most people, bone mass peaks in their thirties. Then people begin to lose bone. Regular exercise can help prevent that loss.

Calcium and vitamin D, good sources of which are dairy products, green leafy vegetables and fish, contribute to healthy bones.

The bone mass readings given by this product are an estimation of the amount of bone in your body. Those with osteoporosis or low bone densities may not get accurate estimations. If you have any concern regarding your bones please consult your doctor timely.

The table as follows may be used as a guide:

Bone Mass Percentage

(Source: Rico et al.1993)

**The average bone mass percentage for both men and women is between 4 to 5%.**

♥ Health Tips - About BMI

Maintaining proper weight is essential to healthy living. Obesity has been linked to a higher risk of heart disease, diabetes and some forms of cancer. The Body Mass Index (BMI) is the most widely accepted measurement of weight according to health professionals. The Analyzer will calculate your BMI on your height and weight.

The table as follows may be used as a guide:

Height (inches)	Normal						Overweight						Obese					
	Body Weight (pounds)																	
	91	96	100	105	110	115	119	124	129	134	138	143	148	153	158	162	167	
58	94	99	104	109	114	119	124	128	133	138	143	148	153	158	163	168	173	
59	97	102	107	112	118	123	128	133	138	143	148	153	158	163	168	174	179	
60	100	106	111	116	122	127	132	137	143	148	153	158	164	169	174	180	185	
61	104	109	115	120	126	131	136	142	147	153	158	164	169	175	180	186	191	
62	107	113	118	124	130	135	141	146	152	158	163	169	175	180	186	191	197	
63	110	116	122	128	134	140	145	151	157	163	169	174	180	186	192	197	204	
64	114	120	126	132	138	144	150	156	162	168	174	180	186	192	198	204	210	
65	118	124	130	136	142	148	155	161	167	173	179	186	192	198	204	210	216	
66	121	127	134	140	146	153	159	166	172	178	185	191	198	204	211	217	223	
67	125	131	138	144	151	158	164	171	177	184	190	197	203	210	216	223	230	
68	128	135	142	149	155	162	169	176	182	189	196	203	209	216	223	230	236	
69	132	139	146	153	160	167	174	181	188	195	202	209	216	222	229	236	243	
70	136	143	150	157	165	172	179	186	193	200	208	215	222	229	236	243	250	
71	140	147	154	162	169	177	184	191	199	206	213	221	228	235	242	250	258	
72	144	151	159	166	174	182	189	197	204	212	219	227	235	242	250	257	265	
73	148	155	163	171	179	186	194	202	210	218	225	233	241	249	256	264	272	
74	152	160	168	176	184	192	200	208	216	224	232	240	248	256	264	272	279	
75	156	164	172	180	189	197	205	213	221	230	238	246	254	263	271	279	287	
76	<b>19</b>	<b>20</b>	<b>21</b>	<b>22</b>	<b>23</b>	<b>24</b>	<b>25</b>	<b>26</b>	<b>27</b>	<b>28</b>	<b>29</b>	<b>30</b>	<b>31</b>	<b>32</b>	<b>33</b>	<b>34</b>	<b>35</b>	

## ♥ FCC Regulations

### FCC User Guide Information

#### Radio Frequency Interface Requirements - FCC

Note: This equipment has been tested and found to comply with the limits for a Class B digital device, pursuant to Part 15 of the FCC rules. These limits are designed to provide reasonable protection against harmful interference in a residential installation. This equipment generates, uses and can radiate radio frequency energy and, if not installed and used in accordance with the instructions, may cause harmful interference to radio communications. However there is no guarantee that interference will not occur in a particular installation. If this equipment does cause harmful interference to radio or television reception, which can be determined by turning the equipment off and on, the user is encouraged to try to correct the interference by one or more of the following measures:

- Reorient or relocate the receiving antenna;
- Increase the separation between the equipment and receiver;
- Connect the equipment into an outlet on a circuit different from that to which the receiver is connected;
- Consult the dealer or an experienced radio / TV technician for help.

#### Radio Transmitters (Part 15)

This device complies with Part 15 of the FCC Rules. Operation is subject to the following two conditions: (1) this device may not cause harmful interference, and (2) this device must accept any interference received, including interference that may cause undesired operation.

Changes or modifications not expressly approved by the party responsible for compliance could void the user's authority to operate the equipment.

### FCC RF Exposure Guidelines

#### Safety Information

##### Reducing RF Exposure - Use Properly

Only operate the device in accordance with the instructions supplied.

This device complies with FCC radiation exposure limits set forth for an uncontrolled environment.

## ♥ Warning

\* a warning statement to the effect that "WARNING: Use of this equipment adjacent to or stacked with other equipment should be avoided because it could result in improper operation. If such use is necessary, this equipment and the other equipment should be observed to verify that they are operating normally."

The MANUFACTURER of the ME EQUIPMENT or ME SYSTEM may provide a description or list of equipment with which the ME EQUIPMENT or ME SYSTEM has been tested in a stacked or adjacent configuration and with which stacked or adjacent use resulted in normal operation.

\* a warning statement to the effect that "WARNING: Use of accessories, transducers and cables other than those specified or provided by the manufacturer of this equipment could result in increased electromagnetic emissions or decreased electromagnetic immunity of this equipment and result in improper operation."

\* a warning statement to the effect that: "WARNING: Portable RF communications equipment (including peripherals such as antenna cables and external antennas) should be used no closer than 30 cm (12 inches) to any part of the [ME EQUIPMENT or ME SYSTEM], including cables specified by the manufacturer. Otherwise, degradation of the performance of this equipment could result."