



TEST REPORT	
Report Number.....:	90181-25-72-25-PP001
Date of issue	2025.04.27
Prepared by (+signature)	Pale 
Reviewer (+signature)	Duke 
Approved by (+signature)	Jason 
Testing Laboratory name	SLG-CPC Testlaboratory Co., Ltd.
Address.....:	No. 11, Wu Song Road, Dongcheng District Dongguan, Guangdong Province, 523117, People's Republic of China
Applicant's name	MOKO TECHNOLOGY LIMITED
Address.....:	Factory 201, 107 Pinshun Rd Guixiang community, Guanlan Street, Longhua, Shenzhen, China 518110
Manufacturer's name	MOKO TECHNOLOGY LIMITED
Address.....:	Factory 201, 107 Pinshun Rd Guixiang community, Guanlan Street, Longhua, Shenzhen, China 518110
Factory's name	MOKO TECHNOLOGY LIMITED
Address.....:	Factory 201, 107 Pinshun Rd Guixiang community, Guanlan Street, Longhua, Shenzhen, China 518110
Standard(s)	FCC 47 CFR Part 15, Subpart C
EUT.....:	Smart Tracker
Trade Mark.....:	MOKO SMART
Model/Type reference	LW001-BGE、 LW001-BGE-B(L76K)、 LW001-BGE-C(AT6558)
FCC ID	2A094-LW001-BGE
Date of receipt of test item.....:	2025.02.24
Date (s) of performance of test:	2025.02.24- 2025.03.17
Test Report Form No.....:	FCC CFR Part 15C_B1
Master TRF	Dated 2021-09
Summary of Test Results	Pass
The Summary of Test Results based on a technical opinion belongs to the standard(s).	
General disclaimer:	
This report shall not be reproduced except in full, without the written approval of SLG-CPC Testlaboratory Co., Ltd. The test results in the report only apply to the tested sample.	



TABLE OF CONTENTS

1	EUT TECHNICAL DESCRIPTION	4
2	SUMMARY OF TEST RESULT	5
3	TEST METHODOLOGY	6
3.1	GENERAL DESCRIPTION OF APPLIED STANDARDS	6
3.2	MEASUREMENT EQUIPMENT USED	6
3.3	DESCRIPTION OF TEST MODES	7
4	FACILITIES AND ACCREDITATIONS	8
4.1	FACILITIES	8
4.2	LABORATORY ACCREDITATIONS AND LISTINGS	8
5	TEST SYSTEM UNCERTAINTY	9
6	SETUP OF EQUIPMENT UNDER TEST	10
6.1	RADIO FREQUENCY TEST SETUP 1	10
6.2	RADIO FREQUENCY TEST SETUP 2	10
6.3	CONDUCTED EMISSION TEST SETUP	12
6.4	BLOCK DIAGRAM CONFIGURATION OF TEST SYSTEM	13
6.5	SUPPORT EQUIPMENT	13
7	TEST REQUIREMENTS	14
7.1	20dB EMISSION BANDWIDTH	14
7.2	RADIATED SPURIOUS EMISSION	16

Modified Information

Report No.	Revision Data	Summary
90181-25-72-25-PP001	2025.04.27	Original Version

1 EUT TECHNICAL DESCRIPTION

Characteristics	Description
Product:	Smart Tracker
Model Number:	LW001-BGE、LW001-BGE-B(L76K)、LW001-BGE-C(AT6558)
Modulation:	LoRa
Operating Frequency Range(s):	915MHz
Number of Channels:	1
Antenna Type :	FPC Antenna
Antenna Gain:	0.8dBi
Power supply:	<input checked="" type="checkbox"/> DC 3.6V
	<input type="checkbox"/> Adapter supply:

Note: for more details, please refer to the User's manual of the EUT.

2 SUMMARY OF TEST RESULT

FCC Part Clause	Test Parameter	Verdict	Remark
15.249	20dB Emission Bandwidth	PASS	
15.209 & 15.249	Radiated Emissions	PASS	
15.203	Antenna Requirement	PASS	
15.207	Conducted Emission	N/A	
NOTE1: N/A (Not Applicable)			

RELATED SUBMITTAL(S) / GRANT(S):

This submittal(s) (test report) is intended for 2AO94-LW001-BGE filing to comply with Section 15.249 of the FCC Part 15, Subpart C Rules

3 TEST METHODOLOGY

3.1 GENERAL DESCRIPTION OF APPLIED STANDARDS

According to its specifications, the EUT must comply with the requirements of the following standards:
 FCC 47 CFR Part 15, Subpart C, Section 15.249

3.2 MEASUREMENT EQUIPMENT USED

Equipment	Model	Manufacturer	S/N	Last Cal.	DUE Cal.
RF Connected Test					
Vector Signal Generator	Rohde & Schwarz	SMBV100B(6G)	101166	2024/05/14	1 year
Analog Signal Generator	Rohde & Schwarz	SMB100A(40G)	181333	2024/07/25	1 year
Signal Analyzer	Rohde & Schwarz	FSV40	101527	2024/04/02	1 year
Power Analyzer	Rohde & Schwarz	OSP-B157W8	N/A	2024/05/14	1 year
Wideband Radio Communication Tester	R&S	CMW270	101985	2024/05/14	1 year
Wideband Radio Communication Tester	Rohde & Schwarz	CMW500	166898	2024/05/14	1 year
Spectrum Analyzer	Agilent	E4408B	MY44211139	2024/11/05	1 year
Temperature&Humidity test chamber	ESPEC	VC 4018	/	2025/03/26	1 year
Radiated Emission Test					
EMI Test Receiver	KEYSIGHT	N9010A	MY56070465	2024/12/05	1 year
EMI Test Receiver	Rohde & Schwarz	FSV40	101511	2025/01/10	1 year
Bilog Antenna	Schwarzbeck	VULB 9163	01335	2023/04/21	3 year
Power Amplifier	EMEC	EM330	060676	2022/12/07	3 year
Cable	Tuyue	F4309	L-400-NmNm-12000	2024/12/05	1 year
Horn Antenna	Schwarzbeck	BBHA9120D	1779	2022/04/21	3 year
Horn Antenna	Schwarzbeck	BBHA9170	00954	2022/09/13	3 year
Power Amplifier	Rohde & Schwarz	SCU08F2	08400019	2025/03/24	3 year
Power Amplifier	Rohde & Schwarz	SCU-18F	180118	2025/03/24	3 year
Power Amplifier	Rohde & Schwarz	SCU40A	100499	2023/06/21	3 year
Active Loop Antenna	ETS LINDGREN	6512	41623	2025/03/19	3 year
Test Software	Farad	EZ-EMC	Ver.CPC-3A1	/	/
Conducted Emission Test					
LISN	Schwarzbeck	NSLK 8127	8127-892	2025/03/17	1 year
LISN	Schwarzbeck	NSLK 8127	8127-437	2024/07/02	1 year
EMI Test Receiver	R&S	ESR3	102124	2024/12/05	1 year
Pulse Limiter	R&S	ESH3-Z2	357.8810.52	2024/12/05	1 year
Test Software	Farad	EZ-EMC	Ver.CPC-3A1	/	/

3.3 DESCRIPTION OF TEST MODES

The EUT has been tested under its typical operating condition.

The EUT configuration for testing is installed on RF field strength measurement to meet the Commissions requirement and operating in a manner which intends to maximize its emission characteristics in a continuous normal application.

The Transmitter was operated in the normal operating mode. The TX frequency was fixed which was for the purpose of the measurements.

The following test modes were performed for test:915MHz

4 FACILITIES AND ACCREDITATIONS

4.1 FACILITIES

All measurement facilities used to collect the measurement data are located at

No. 11, Wu Song Road, Dongcheng District Dongguan, Guangdong Province, 523117, People's Republic of China

The sites are constructed in conformance with the requirements of ANSI C63.7, ANSI C63.4 and CISPR Publication 32.

4.2 LABORATORY ACCREDITATIONS AND LISTINGS

Site Description

EMC Lab. : Accredited by ISED, October 31 2023
CAB identifier: CN0126
Company Number: 27767

Accredited by A2LA, October 31 2023
The Certificate Registration Number is 6325.01

Accredited by FCC
Designation Number: CN1287
Test Firm Registration Number: 394054

Name of Firm : SLG-CPC Testlaboratory Co., Ltd.
Site Location : No. 11, Wu Song Road, Dongcheng District Dongguan,
Guangdong Province, 523117, People's Republic of China

5 TEST SYSTEM UNCERTAINTY

The following measurement uncertainty levels have been estimated for tests performed on the apparatus:

Parameter	Uncertainty
Radio Frequency	$\pm 1 \times 10^{-5}$
Maximum Peak Output Power Test	$\pm 1.0\%$
Conducted Emissions Test	3.68dB
Radiated Emission Test	4.80dB (below 1G) 3.26dB (above 1GHz)
Occupied Bandwidth Test	$\pm 0.9\%$
Band Edge Test	$\pm 2.3\%$
All emission, radiated	$\pm 1.2\%$
Antenna Port Emission	$\pm 3\text{dB}$
Temperature	$\pm 3.2\%$
Humidity	$\pm 2.5\%$

Measurement Uncertainty for a level of Confidence of 95%

6 SETUP OF EQUIPMENT UNDER TEST

6.1 RADIO FREQUENCY TEST SETUP 1

The component's antenna ports(s) of the EUT are connected to the measurement instrument per an appropriate attenuator. The EUT is controlled by PC/software to emit the specified signals for the purpose of measurements.

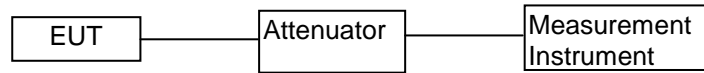

6.2 RADIO FREQUENCY TEST SETUP 2

The test site semi-anechoic chamber has met the requirement of NSA tolerance 4 dB according to the standards: ANSI C63.10. The test distance is 3m. The setup is according to the requirements in Section 13.1.4.1 of ANSI C63.10-2020 and CAN/CSA-CEI/IEC CISPR 32.

The maximal emission value is acquired by adjusting the antenna height, polarisation and turntable azimuth. Normally, the height range of antenna is 1 m to 4 m, the azimuth range of turntable is 0° to 360°, and the receive antenna has two polarizations Vertical (V) and Horizontal (H).

Below 30MHz:

The EUT is placed on a turntable 0.8 meters above the ground in the chamber, 3 meter away from the antenna (loop antenna). The Antenna should be positioned with its plane vertical at the specified distance from the EUT and rotated about its vertical axis for maximum response at each azimuth about the EUT. The center of the loop shall be 1 m above the ground. For certain applications, the loop antenna plane may also need to be positioned horizontally at the specified distance from the EUT.

Above 30MHz:

The EUT is placed on a turntable 0.8 meters above the ground in the chamber, 3 meter away from the antenna. The maximal emission value is acquired by adjusting the antenna height, polarisation and turntable azimuth. Normally, the height range of antenna is 1 m to 4 m, the azimuth range of turntable is 0° to 360°, and the receive antenna has two polarizations Vertical (V) and Horizontal (H).

Above 1GHz:

(Note: the FCC's permission to use 1.5m as an alternative per TCBC Conf call of Dec. 2, 2014.)

The EUT is placed on a turntable 1.5 meters above the ground in the chamber, 3 meter away from the antenna. The maximal emission value is acquired by adjusting the antenna height, polarisation and turntable azimuth. Normally, the height range of antenna is 1 m to 4 m, the azimuth range of turntable is 0° to 360°, and the receive antenna has two polarizations Vertical (V) and Horizontal (H).

(a) Radiated Emission Test Set-Up, Frequency Below 30MHz

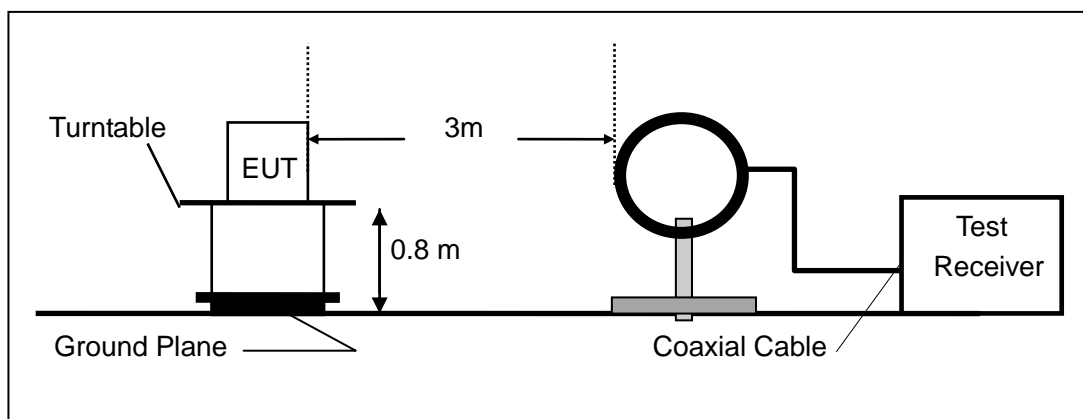

(b) Radiated Emission Test Set-Up, Frequency Below 1000MHz

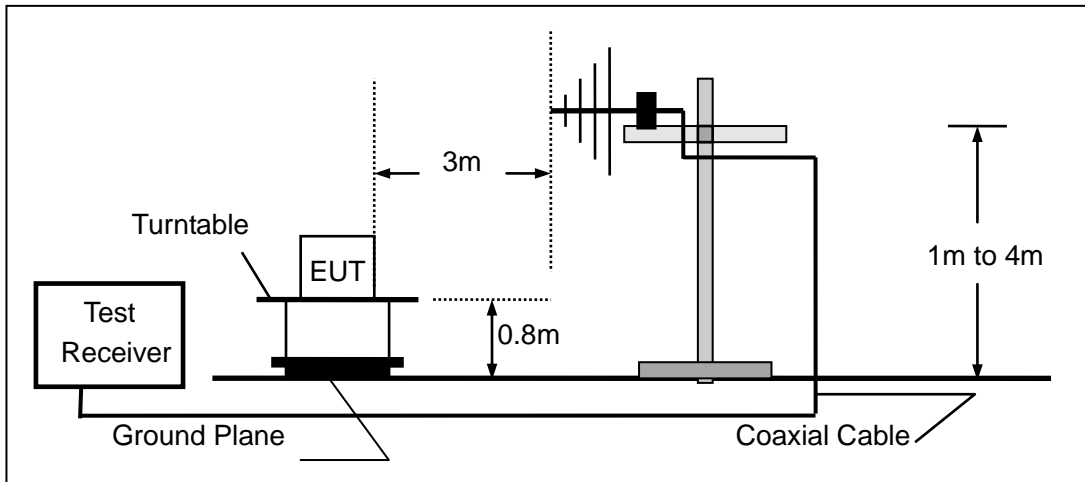

(c) Radiated Emission Test Set-Up, Frequency above 1000MHz

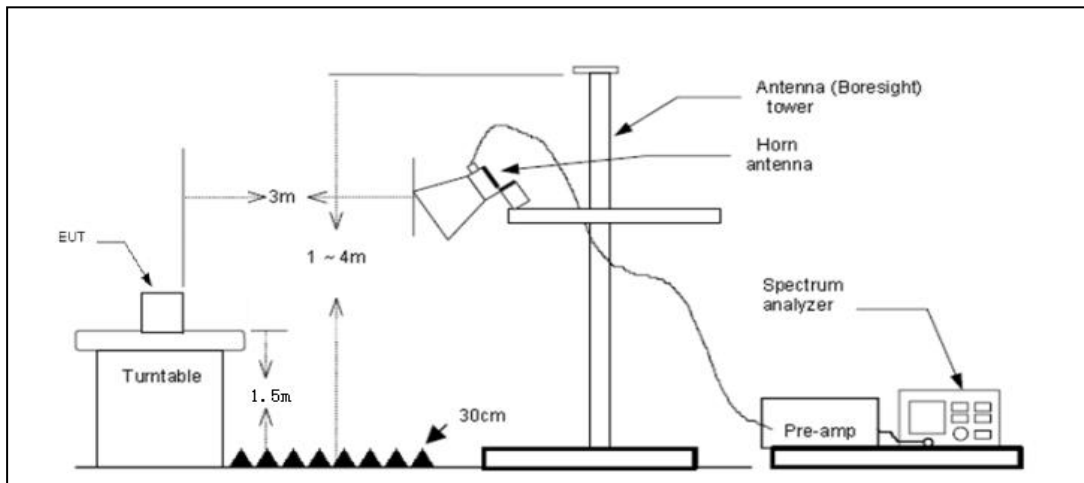

6.3 CONDUCTED EMISSION TEST SETUP

The mains cable of the EUT (maybe per AC/DC Adapter) must be connected to LISN. The LISN shall be placed 0.8 m from the boundary of EUT and bonded to a ground reference plane for LISN mounted on top of the ground reference plane. This distance is between the closest points of the LISN and the EUT. All other units of the EUT and associated equipment shall be at least 0.8m from the LISN.

Ground connections, where required for safety purposes, shall be connected to the reference ground point of the LISN and, where not otherwise provided or specified by the manufacturer, shall be of same length as the mains cable and run parallel to the mains connection at a separation distance of not more than 0.8 m.

According to the requirements in ANSI C63.10-2020 Conducted emissions from the EUT measured in the frequency range between 0.15 MHz and 30 MHz using CISPR Quasi-Peak and average detector mode.

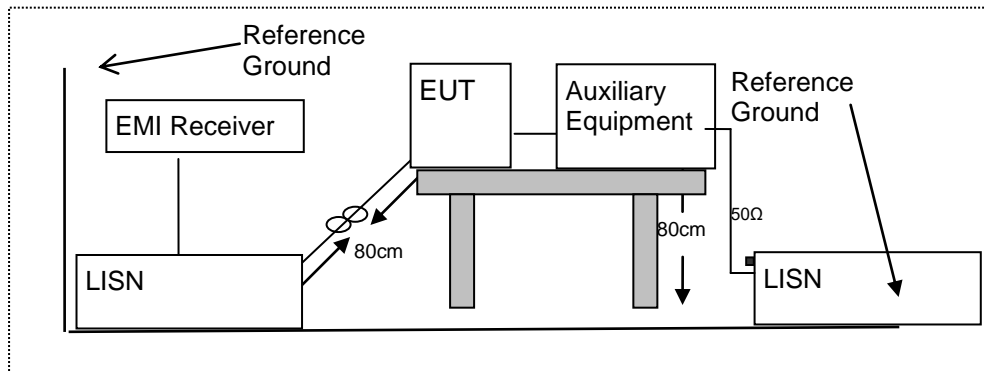

6.4 BLOCK DIAGRAM CONFIGURATION OF TEST SYSTEM

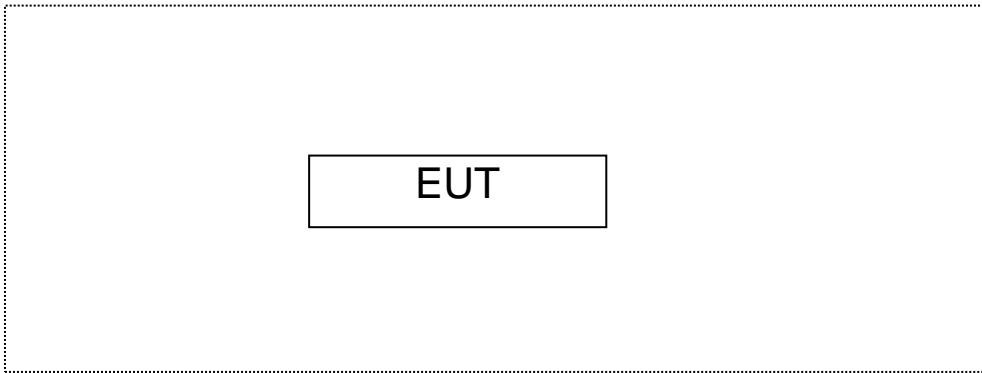

6.5 SUPPORT EQUIPMENT

Product name	M/N:	Manufacturer	
Notebook PC	13IML	Lenovo	

Auxiliary Cable List and Details			
Cable Description	Length (m)	Shielded/Unshielded	With / Without Ferrite
/	/	/	/

Auxiliary Equipment List and Details			
Description	Manufacturer	Model	Serial Number
/	/	/	/

Notes:

1. All the equipment/cables were placed in the worst-case configuration to maximize the emission during the test.
2. Grounding was established in accordance with the manufacturer’s requirements and conditions for the intended use.

7 TEST REQUIREMENTS

7.1 20dB EMISSION BANDWIDTH

7.1.1 Applicable Standard
According to FCC part 15.249

7.1.2 Conformance Limit
No deviation.

7.1.3 Test Configuration
Test according to clause 6.1 radio frequency test setup 1

7.1.4 Test Procedure
The EUT was operating in transmit mode and controlled its channel. Printed out the test result from the spectrum by hard copy function.
The RF output of EUT was connected to the spectrum analyzer by RF cable and attenuator. The path loss was compensated to the results for each measurement.
The EUT should be transmitting at its maximum data rate. Allow the trace to stabilize. Use the marker-to-peak function to set the marker to the peak of the emission. Use the marker-delta function to measure 20 dB down one side of the emission. Reset the markerdelta function, and move the marker to the other side of the emission, until it is (as close as possible to) even with the reference marker level. The marker-delta reading at this point is the 20 dB bandwidth of the emission.
If this value varies with different modes of operation (e.g., data rate, modulation format, etc.), repeat this test for each variation.
Measure and record the results in the test report.

Test Results

Temperature:	20° C
Relative Humidity:	54%
ATM Pressure:	1011 mbar

Modulation Mode	Channel Number	Channel Frequency (MHz)	Measurement Bandwidth (MHz)
LORA	1	915	0.934
Note:			

Test Model Occupied Bandwidth LORA Modulation
Channel 1: 915MHz

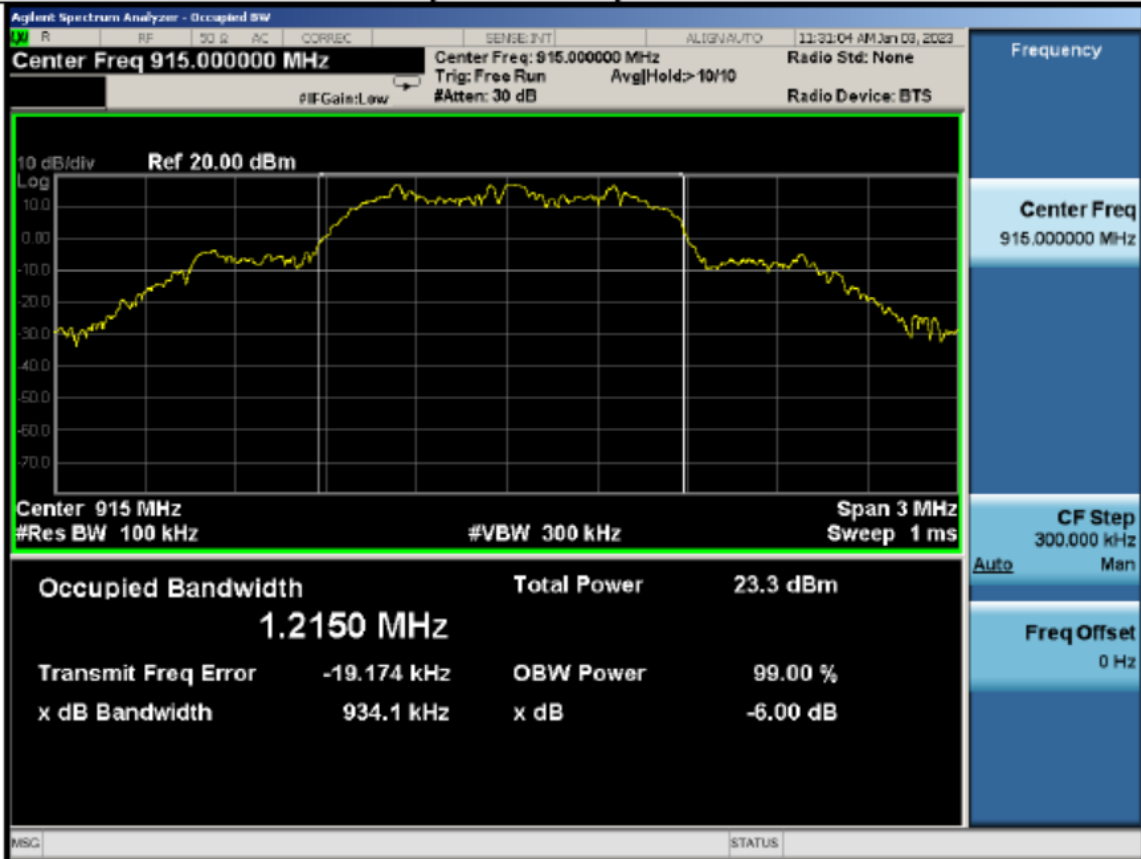

7.2 RADIATED SPURIOUS EMISSION

7.2.1 Applicable Standard

According to FCC Part 15.249 and 15.209

7.2.2 Limit

According to FCC Part 15.205, the level of any transmitter spurious emission in Restricted bands shall not exceed the level of the emission specified in the following table

Restricted Frequency(MHz)	Field Strength (μV/m)	Field Strength (dBμV/m)	Measurement Distance
0.009~0.490	2400/F(KHz)	300	See the remark
0.490~1.705	24000/F(KHz)	30	
1.705~30.0	30	30	
30-88	100	40	3
88-216	150	43.5	3
216-960	200	46	3
960-1000	500	54	3

Remark :1. Emission level in dBuV/m=20 log (uV/m)
 2. Measurement was performed at an antenna to the closed point of EUT distance of meters.
 3. Distance extrapolation factor =40log(Specific distance/ test distance)(dB);
 Limit line=Specific limits(dBuV) + distance extrapolation factor.
 for the frequency ranges below 30 MHz, a narrower RBW is used for these ranges but the measured value should add a RBW correction factor (RBWCF) where RBWCF [dB] =10*lg(100 [kHz]/narrower RBW [kHz]). , the narrower RBW is 1 kHz and RBWCF is 20 dB for the frequency 9 kHz to 150 kHz, and the narrower RBW is 10 kHz and RBWCF is 10 dB for the frequency 150 kHz to 30 MHz.

LIMITS OF RADIATED EMISSION MEASUREMENT (FCC 15.249)

Restricted Frequency(MHz)	Field Strength of fundamental((millivolts /meter)	Field Strength of Harmonics (microvolts/meter)
902-928	50	500

Notes:(1) Emissions radiated outside of the specified frequency bands, except for harmonics, shall be attenuated by at least 50 dB below the level of the fundamental or to the general radiated emission limits in Section 15.209, whichever is the lesser attenuation.

7.2.3 Test Configuration

Test according to clause 6.2 radio frequency test setup 2

7.2.4 Test Procedure

This test is required for any spurious emission that falls in a Restricted Band, as defined in Section 15.205. It must be performed with the highest gain of each type of antenna proposed for use with the EUT. Use the following spectrum analyzer settings:

The EUT was placed on a turn table which is 0.8m above ground plane.

Maximum procedure was performed on the highest emissions to ensure EUT compliance.

Span = wide enough to fully capture the emission being measured

RBW = 100 kHz for $f < 1$ GHz(30MHz to 1GHz), 200Hz for $f < 150$ KHz(9KHz to 150KHz), 9KHz for $f < 30$ MHz(150KHz to 30MHz), 1MHz for $f < 5$ GHz

VBW \geq RBW Sweep = auto

Detector function = peak

Trace = max hold

Follow the guidelines in ANSI C63.10-2020 with respect to maximizing the emission by rotating the EUT, measuring the emission while the EUT is situated in three orthogonal planes (if appropriate), adjusting the measurement antenna height and polarization, etc. A pre-amp and a high pass filter are required for this test, in order to provide the measuring system with sufficient sensitivity. Allow the trace to stabilize. The peak reading of the emission, after being corrected by the antenna factor, cable loss, pre-amp gain, etc., is the peak field strength, which must comply with the limit specified in Section 15.35(b). Submit this data.

Now set the VBW to 10 Hz, while maintaining all of the other instrument settings. This peak level, once corrected, must comply with the limit specified in Section 15.209. If the dwell time per channel of the hopping signal is less than 100 ms, then the reading obtained with the 10 Hz VBW may be further adjusted by a "duty cycle correction factor", derived from $20\log(\text{dwell time}/100 \text{ ms})$, in an effort to demonstrate compliance with the 15.209 limit. Submit this data.

- Calculation of Average factor

The output field strengths of specification in accordance with the FCC rules specify measurements with an average detector. During the test, a spectrum analyzer incorporating a peak detector was used. Therefore, a reduction factor can be applied to the resultant peak signal level and compared to the limit for measurement instrumentation incorporating an average detector.

The duty cycle is measured in 100ms or the repetition cycle period, whichever is a shorter time frame, the duty cycle is measured by placing the spectrum analyzer to set zero span at 100kHz resolution bandwidth.

Averaging factor in dB=20log (duty cycle)

Repeat above procedures until all frequency measured was complete.

Temperature:	26° C
Relative Humidity:	54%
ATM Pressure:	1011 mbar

7.2.5 Test Results

■ Duty cycle measure

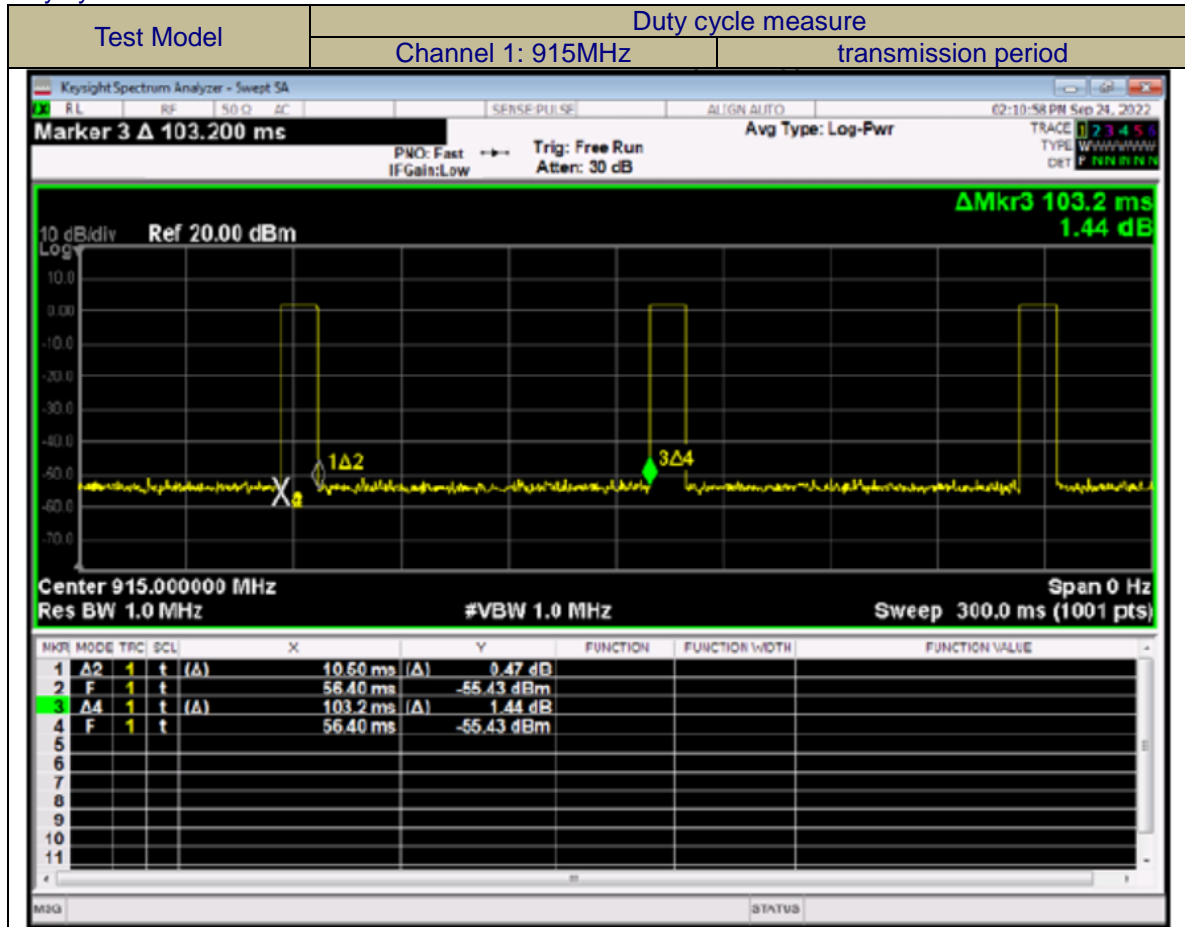

Duty Cycle:	$(1.046 \times 10 + 0.28 \times 15) \text{ms} / 47.30 = 14.66 \text{ms} / 47.30 \text{ms} = 0.3099$
Duty Cycle Correction Factor:	$20 \lg(0.3099) = -10.18$
Calculate Average value based on Duty Cycle correction factor: Ton=10.5ms	
Duty Cycle-Ton/(Ton+Toff)=10.5/103.2=0.1017=10.17%	
Duty Cycle factor= $20 \lg(\text{Duty Cycle}) = 20 \lg(10.17\%) = -19.85$	
Average=Peak+ Duty Cycle factor= Peak-19.85	

■ TEST RESULTS (RESTRICTED BANDS REQUIREMENTS)

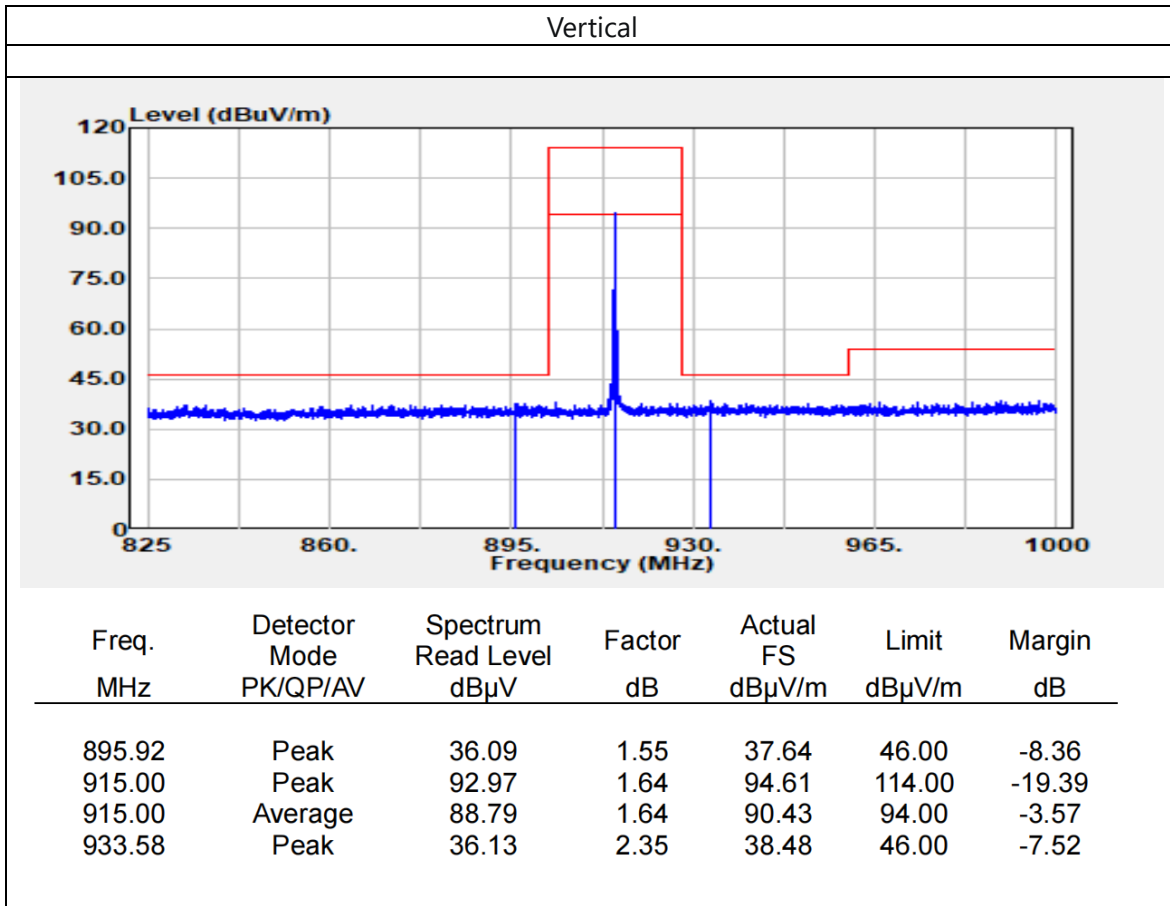

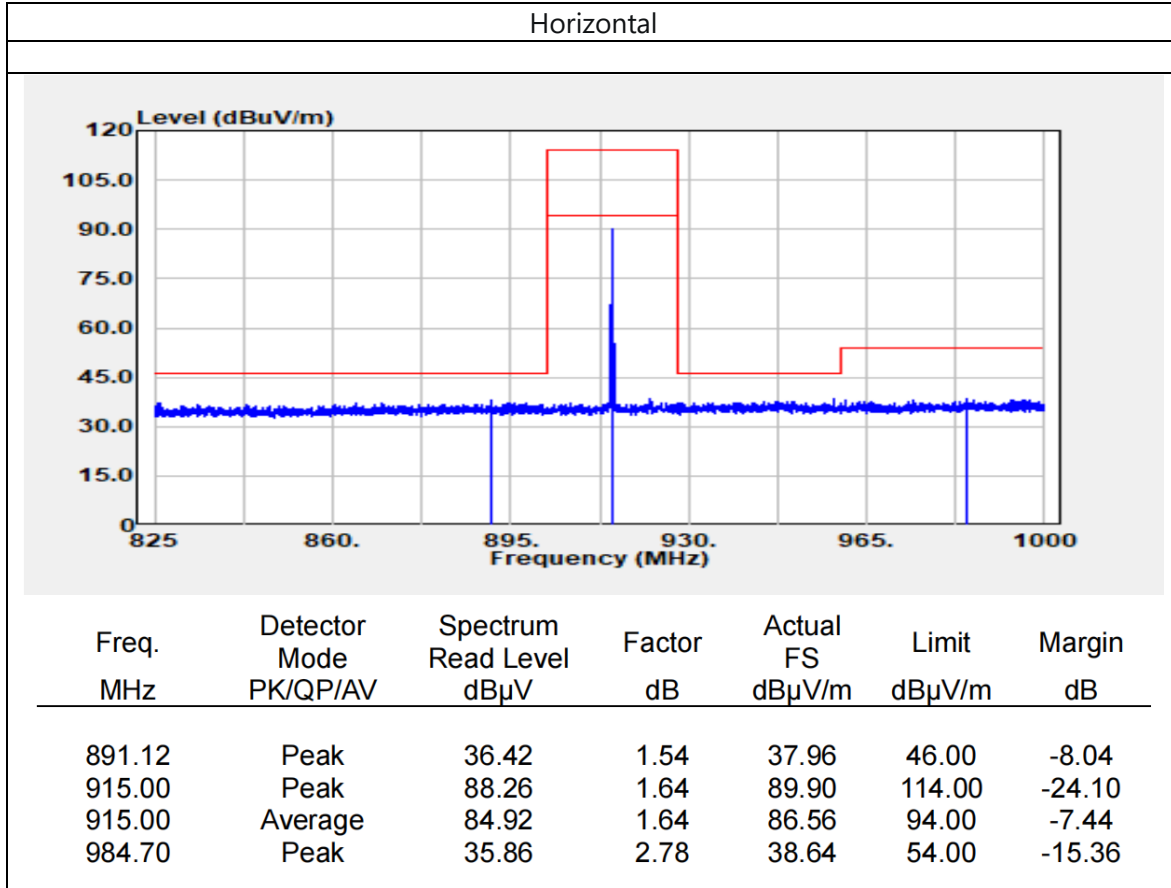

■ Radiated spurious emission (30MHz ~ 1GHz, worst emissions found)

Operation Mode: 915MHz; Horizontal

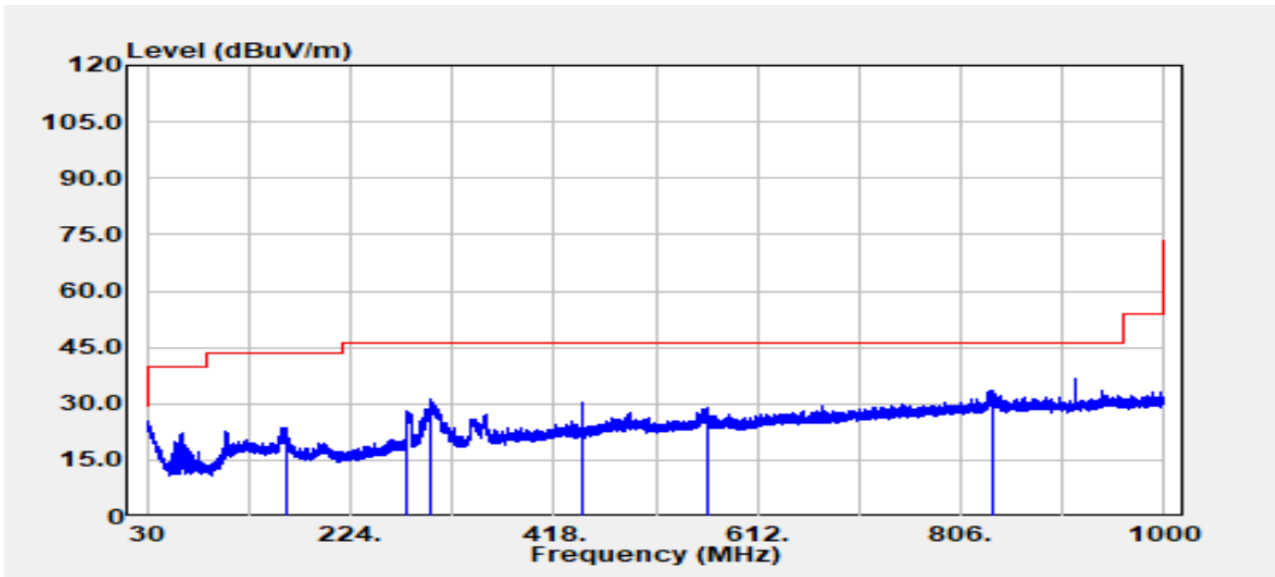

Freq. MHz	Detector Mode PK/QP/AV	Spectrum Read Level dB μ V	Factor dB	Actual FS dB μ V/m	Limit dB μ V/m	Margin dB
162.10	Peak	35.00	-11.26	23.74	43.50	-19.76
277.00	Peak	37.66	-9.56	28.10	46.00	-17.90
301.10	Peak	40.75	-9.31	31.44	46.00	-14.56
445.50	Peak	35.95	-5.39	30.56	46.00	-15.44
563.60	Peak	32.61	-3.45	29.16	46.00	-16.84
836.70	Peak	32.29	1.13	33.42	46.00	-12.58

Operation Mode: 915MHz; Vertical

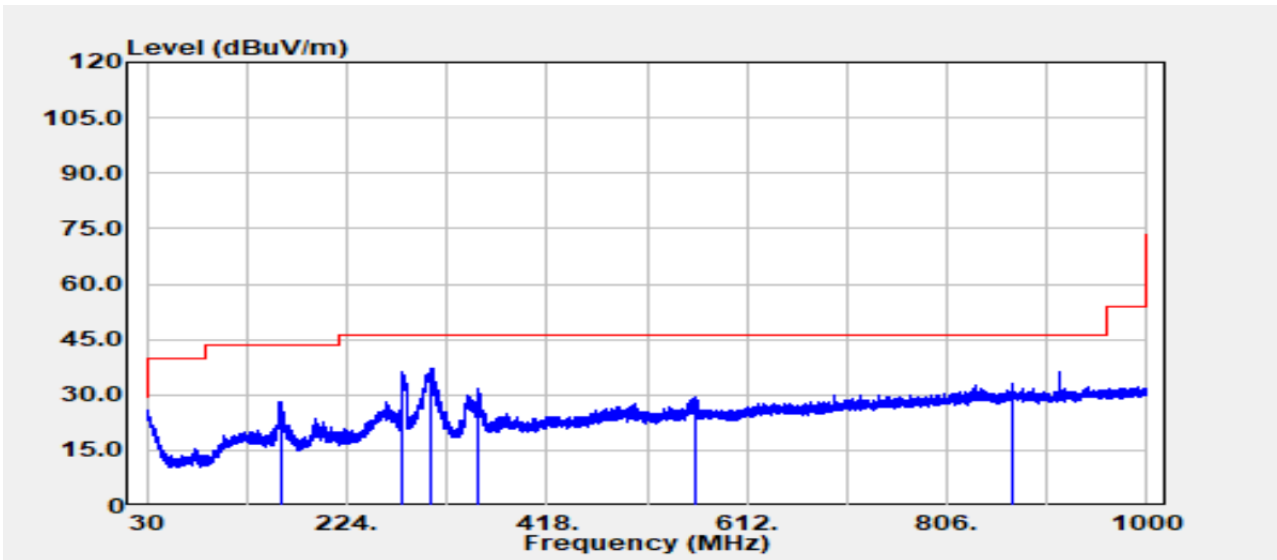

Freq. MHz	Detector Mode PK/QP/AV	Spectrum Read Level d μ V	Factor dB	Actual FS d μ V/m	Limit d μ V/m	Margin dB
159.80	Peak	39.13	-11.04	28.09	43.50	-15.41
277.60	Peak	45.59	-9.57	36.02	46.00	-9.98
306.20	Peak	46.27	-9.21	37.06	46.00	-8.94
351.90	Peak	39.70	-8.19	31.52	46.00	-14.48
562.50	Peak	33.07	-3.48	29.59	46.00	-16.41
870.50	Peak	31.45	1.50	32.95	46.00	-13.05

■ Test Result and Data (Above 1GHz)

Operation Mode: TX Mode

Frequency (MHz)	Meter Reading (dB μ V)	Factor (dB)	Emission Level (dB μ V/m)	Limits (dB μ V/m)	Over (dB)	Detector Type	Ant. Pol. H/V
1830.000	63.33	-4.26	59.07	74	-14.93	peak	H
1830.000	53.40	-4.26	49.14	54	-4.86	AVG	H
2745.000	62.52	-4.26	58.26	74	-15.74	peak	H
2745.000	53.01	-4.26	48.75	54	-5.25	AVG	H
3660.000	59.69	1.18	60.87	74	-13.13	peak	H
3660.000	46.30	1.18	47.48	54	-6.52	AVG	H
4575.000	58.31	1.18	59.49	74	-14.51	peak	H
4575.000	44.76	1.18	45.94	54	-8.06	AVG	H
1830.000	64.52	-4.26	60.26	74	-13.74	peak	V
1830.000	51.85	-4.26	47.59	54	-6.41	AVG	V
2745.000	62.41	-4.26	58.15	74	-15.85	peak	V
2745.000	51.63	-4.26	47.37	54	-6.63	AVG	V
3660.000	61.23	1.18	62.41	74	-11.59	peak	V
3660.000	42.60	1.18	43.78	54	-10.22	AVG	V
4575.000	50.96	1.18	52.14	74	-21.86	peak	V
4575.000	41.23	1.18	42.41	54	-11.59	AVG	V

Antenna Application

7.2.6 Antenna Requirement

Standard	Requirement
FCC CRF Part 15.203	An intentional radiator shall be designed to ensure that no antenna other than that furnished by the responsible party shall be used with the device. The use of a permanently attached antenna or of an antenna that uses a unique coupling to the intentional radiator shall be considered sufficient to comply with the provisions of this section. The manufacturer may design the unit so that a broken antenna can be replaced by the user, but the use of a standard antenna jack or electrical connector is prohibited. This requirement does not apply to carrier current devices or to devices operated under the provisions of §15.211, §15.213, §15.217, §15.219, or §15.221. Further, this requirement does not apply to intentional radiators that must be professionally installed, such as perimeter protection systems and some field disturbance sensors, or to other intentional radiators which, in accordance with §15.31(d), must be measured at the installation site. However, the installer shall be responsible for ensuring that the proper antenna is employed so that the limits in this part are not exceeded.

For intentional device, according to FCC 47 CFR Section 15.203, an intentional radiator shall be designed to ensure that no antenna other than that furnished by the responsible party shall be used with the device.

7.2.7 Result

PASS.

The EUT has 1 antenna: a FPC Antenna for LORA model, the gain is 0.8dBi;

- Note:
- Antenna use a permanently attached antenna which is not replaceable.
 - Not using a standard antenna jack or electrical connector for antenna replacement
 - The antenna has to be professionally installed (please provide method of installation)

which in accordance to section 15.203, please refer to the internal photos.

*** End of Report ***

声明 Statement

1. 本报告无授权批准人签字及盖章无效;

This report is invalid without the signature and seal of the authorized approver.

2. 未经许可本报告不得部分复制;

This report shall not be copied partly without authorization.

3. 本报告的检测结果仅对送测样品有效, 委托方对样品的代表性和资料的真实性负责;

The test results or observations are applicable only to tested sample. Client shall be responsible for representativeness of the sample and authenticity of the material.

4. 本检测报告中检测项目标注有特殊符号则该项目不在资质认定范围内, 仅作为客户委托、科研、教学或内部质量控制等目的使用;

The observations or tests with special mark fall outside the scope of accreditation, and are only used for purpose of commission, research, training, internal quality control etc.

5. 本检测报告以实测值进行符合性判定, 未考虑不确定度所带来的风险, 本实验室不承担相关责任, 特别约定、标准或规范中有明确规定的除外;

The test results or observations are provided in accordance with measured value, without taking risks caused by uncertainty into account. Without explicit stipulation in special agreements, standards or regulations, SLG-CPC shall not assume any responsibility.

6. 对本检测报告若有异议, 请于收到报告之日起 20 日内提出;

Objections shall be raised within 20 days from the date receiving the report.