



DFS PORTION of FCC 47 CFR PART 15 SUBPART E

CERTIFICATION TEST REPORT

FOR

GENERAL CONSUMER HOME REBOT

MODEL NUMBER: AHR-M8T

FCC ID: 2AN44-AHR-M8T

REPORT NUMBER: 11988903-E4V4

ISSUE DATE: June 13, 2018

Prepared for
MAYFIELD ROBOTICS
400 CONVENTION WAY
REDWOOD CITY, CA 94063, U.S.A.

Prepared by
UL VERIFICATION SERVICES INC.
47173 BENICIA STREET
FREMONT, CA 94538, U.S.A.
TEL: (510) 771-1000
FAX: (510) 661-0888



Revision History

<u>Rev.</u>	<u>Issue Date</u>	<u>Revisions</u>	<u>Revised By</u>
V1	12/15/17	Initial Issue	Michael Heckrotte
V2	1/11/18	Correction to FCC ID and EUT Description	Grace Rincand
V3	6/11/18	Updated Antenna Gains & EIRP – Section 6.1.6	Henry Lau
V4	6/13/18	Removed IC reference in section 6.1.6	Edgard Rincand

TABLE OF CONTENTS

1. ATTESTATION OF TEST RESULTS	4
2. TEST METHODOLOGY	5
3. REFERENCE DOCUMENTS	5
4. FACILITIES AND ACCREDITATION	5
5. CALIBRATION AND UNCERTAINTY	5
5.1. <i>MEASURING INSTRUMENT CALIBRATION</i>	<i>5</i>
5.2. <i>MEASUREMENT UNCERTAINTY</i>	<i>5</i>
6. DYNAMIC FREQUENCY SELECTION.....	6
6.1. <i>OVERVIEW</i>	<i>6</i>
6.1.1. <i>LIMITS</i>	<i>6</i>
6.1.2. <i>TEST AND MEASUREMENT SYSTEM</i>	<i>10</i>
6.1.3. <i>TEST AND MEASUREMENT SOFTWARE</i>	<i>12</i>
6.1.4. <i>TEST ROOM ENVIRONMENT</i>	<i>12</i>
6.1.5. <i>SETUP OF EUT.....</i>	<i>13</i>
6.1.6. <i>DESCRIPTION OF EUT</i>	<i>14</i>
6.2. <i>RESULTS FOR 20 MHz BANDWIDTH</i>	<i>16</i>
6.2.1. <i>TEST CHANNEL</i>	<i>16</i>
6.2.2. <i>RADAR WAVEFORM AND TRAFFIC</i>	<i>16</i>
6.2.3. <i>OVERLAPPING CHANNEL TESTS.....</i>	<i>19</i>
6.2.4. <i>MOVE AND CLOSING TIME</i>	<i>19</i>
6.3. <i>RESULTS FOR 40 MHz BANDWIDTH</i>	<i>23</i>
6.3.1. <i>TEST CHANNEL</i>	<i>23</i>
6.3.2. <i>RADAR WAVEFORM AND TRAFFIC</i>	<i>23</i>
6.3.3. <i>OVERLAPPING CHANNEL TESTS.....</i>	<i>26</i>
6.3.4. <i>MOVE AND CLOSING TIME</i>	<i>26</i>
6.3.5. <i>30-MINUTE NON-OCCUPANCY PERIOD.....</i>	<i>30</i>
7. SETUP PHOTOS.....	31

1. ATTESTATION OF TEST RESULTS

COMPANY NAME: MAYFIELD ROBOTICS
400 CONVENTION WAY
REDWOOD CITY, CA 94063, U.S.A.

EUT DESCRIPTION: GENERAL CONSUMER DEVICE

MODEL: AHR-M8T

SERIAL NUMBER: KR017420000002

DATE TESTED: NOVEMBER 17. 2017

APPLICABLE STANDARDS	
STANDARD	TEST RESULTS
DFS Portion of CFR 47 Part 15 Subpart E	Complies

UL Verification Services Inc. tested the above equipment in accordance with the requirements set forth in the above standards. All indications of Pass/Fail in this report are opinions expressed by UL Verification Services Inc. based on interpretations and/or observations of test results. Measurement Uncertainties were not taken into account and are published for informational purposes only. The test results show that the equipment tested is capable of demonstrating compliance with the requirements as documented in this report.

Note: The results documented in this report apply only to the tested sample, under the conditions and modes of operation as described herein. This document may not be altered or revised in any way unless done so by UL Verification Services Inc. and all revisions are duly noted in the revisions section. Any alteration of this document not carried out by UL Verification Services Inc. will constitute fraud and shall nullify the document. This report must not be used by the client to claim product certification, approval, or endorsement by NVLAP, NIST, any agency of the Federal Government, or any agency of any government.

Approved & Released For
UL Verification Services Inc. By:

Prepared By:



MICHAEL HECKROTTE
PRINCIPAL ENGINEER
UL Verification Services Inc.



HENRY LAU
EMC ENGINEER
UL Verification Services Inc.

2. TEST METHODOLOGY

The tests documented in this report were performed in accordance with the DFS portion of FCC CFR 47 Part 2, FCC CFR 47 Part 15, FCC 06-96, FCC KDB 789033, KDB 905462 D02 and D03.

3. REFERENCE DOCUMENTS

Measurements of transmitter parameters as referenced in this report are documented in UL Report number 11988903-E5V1 FCC IC UNII WLAN REPORT.

4. FACILITIES AND ACCREDITATION

The test sites and measurement facilities used to collect data are located at 47173 Benicia Street, Fremont, California, USA.

UL Verification Services, Inc. is accredited by NVLAP, Laboratory Code 200065-0. The full scope of accreditation can be viewed at <http://ts.nist.gov/standards/scopes/2000650.htm>.

5. CALIBRATION AND UNCERTAINTY

5.1. MEASURING INSTRUMENT CALIBRATION

The measuring equipment utilized to perform the tests documented in this report has been calibrated in accordance with the manufacturer's recommendations, and is traceable to recognized national standards.

5.2. MEASUREMENT UNCERTAINTY

Where relevant, the following measurement uncertainty level has been estimated for tests performed on the apparatus:

PARAMETER	UNCERTAINTY
Time	$\pm 0.02 \%$

The Uncertainty figure is valid to a confidence level of 95%.

6. DYNAMIC FREQUENCY SELECTION

6.1. OVERVIEW

6.1.1. LIMITS

FCC

§15.407 (h), FCC KDB 905462 D02 “COMPLIANCE MEASUREMENT PROCEDURES FOR UNLICENSED-NATIONAL INFORMATION INFRASTRUCTURE DEVICES OPERATING IN THE 5250-5350 MHz AND 5470-5725 MHz BANDS INCORPORATING DYNAMIC FREQUENCY SELECTION” and KDB 905462 D03 “U-NII CLIENT DEVICES WITHOUT RADAR DETECTION CAPABILITY”.

Table 1: Applicability of DFS requirements prior to use of a channel

Requirement	Operational Mode		
	Master	Client (without radar detection)	Client (with radar detection)
Non-Occupancy Period	Yes	Not required	Yes
DFS Detection Threshold	Yes	Not required	Yes
Channel Availability Check Time	Yes	Not required	Not required
U-NII Detection Bandwidth	Yes	Not required	Yes

Table 2: Applicability of DFS requirements during normal operation

Requirement	Operational Mode		
	Master	Client (without DFS)	Client (with DFS)
DFS Detection Threshold	Yes	Not required	Yes
Channel Closing Transmission Time	Yes	Yes	Yes
Channel Move Time	Yes	Yes	Yes
U-NII Detection Bandwidth	Yes	Not required	Yes

Additional requirements for devices with multiple bandwidth modes	Master Device or Client with Radar DFS	Client (without DFS)
<i>U-NII Detection Bandwidth and Statistical Performance Check</i>	All BW modes must be tested	Not required
<i>Channel Move Time and Channel Closing Transmission Time</i>	Test using widest BW mode available	Test using the widest BW mode available for the link
<i>All other tests</i>	Any single BW mode	Not required
Note: Frequencies selected for statistical performance check (Section 7.8.4) should include several frequencies within the radar detection bandwidth and frequencies near the edge of the radar detection bandwidth. For 802.11 devices it is suggested to select frequencies in all 20 MHz channel blocks and a null frequency between the bonded 20 MHz channel blocks.		

Table 3: Interference Threshold values, Master or Client incorporating In-Service Monitoring

Maximum Transmit Power	Value (see notes)
E.I.R.P. \geq 200 mill watt	-64 dBm
E.I.R.P. < 200 mill watt and power spectral density < 10 dBm/MHz	-62 dBm
E.I.R.P. < 200 mill watt that do not meet power spectral density requirement	-64 dBm
<p>Note 1: This is the level at the input of the receiver assuming a 0 dBi receive antenna Note 2: Throughout these test procedures an additional 1 dB has been added to the amplitude of the test transmission waveforms to account for variations in measurement equipment. This will ensure that the test signal is at or above the detection threshold level to trigger a DFS response. Note 3: E.I.R.P. is based on the highest antenna gain. For MIMO devices refer to KDB publication 662911 D01.</p>	

Table 4: DFS Response requirement values

Parameter	Value
<i>Non-occupancy period</i>	30 minutes
<i>Channel Availability Check Time</i>	60 seconds
<i>Channel Move Time</i>	10 seconds (See Note 1)
<i>Channel Closing Transmission Time</i>	200 milliseconds + approx. 60 milliseconds over remaining 10 second period. (See Notes 1 and 2)
<i>U-NII Detection Bandwidth</i>	Minimum 100% of the U-NII 99% transmission power bandwidth. (See Note 3)
<p>Note 1: <i>Channel Move Time</i> and the <i>Channel Closing Transmission Time</i> should be performed with Radar Type 0. The measurement timing begins at the end of the Radar Type 0 burst. Note 2: The <i>Channel Closing Transmission Time</i> is comprised of 200 milliseconds starting at the beginning of the <i>Channel Move Time</i> plus any additional intermittent control signals required to facilitate a <i>Channel</i> move (an aggregate of 60 milliseconds) during the remainder of the 10 second period. The aggregate duration of control signals will not count quiet periods in between transmissions. Note 3: During the <i>U-NII Detection Bandwidth</i> detection test, radar type 0 should be used. For each frequency step the minimum percentage of detection is 90 percent. Measurements are performed with no data traffic.</p>	

Table 5 – Short Pulse Radar Test Waveforms

Radar Type	Pulse Width (usec)	PRI (usec)	Pulses	Minimum Percentage of Successful Detection	Minimum Trials
0	1	1428	18	See Note 1	See Note 1
1	1	Test A: 15 unique PRI values randomly selected from the list of 23 PRI values in table 5a	Roundup: $\{(1/360) \times (19 \times 10^6 \text{ PRI}_{\text{usec}})\}$	60%	30
		Test B: 15 unique PRI values randomly selected within the range of 518-3066 usec. With a minimum increment of 1 usec, excluding PRI values selected in Test A			
2	1-5	150-230	23-29	60%	30
3	6-10	200-500	16-18	60%	30
4	11-20	200-500	12-16	60%	30
Aggregate (Radar Types 1-4)				80%	120
Note 1: Short Pulse Radar Type 0 should be used for the <i>Detection Bandwidth</i> test, <i>Channel Move Time</i> , and <i>Channel Closing Time</i> tests.					

Table 6 – Long Pulse Radar Test Signal

Radar Waveform Type	Pulse Width (µsec)	Chirp Width (MHz)	PRI (µsec)	Pulses per Burst	Number of Bursts	Minimum Percentage of Successful Detection	Minimum Trials
5	50-100	5-20	1000-2000	1-3	8-20	80%	30

Table 7 – Frequency Hopping Radar Test Signal

Radar Waveform Type	Pulse Width (µsec)	PRI (µsec)	Pulses per Hop	Hopping Rate (kHz)	Hopping Sequence Length (msec)	Minimum Percentage of Successful Detection	Minimum Trials
6	1	333	9	0.333	300	70%	30

6.1.2. TEST AND MEASUREMENT SYSTEM

RADIATED METHOD SYSTEM BLOCK DIAGRAM

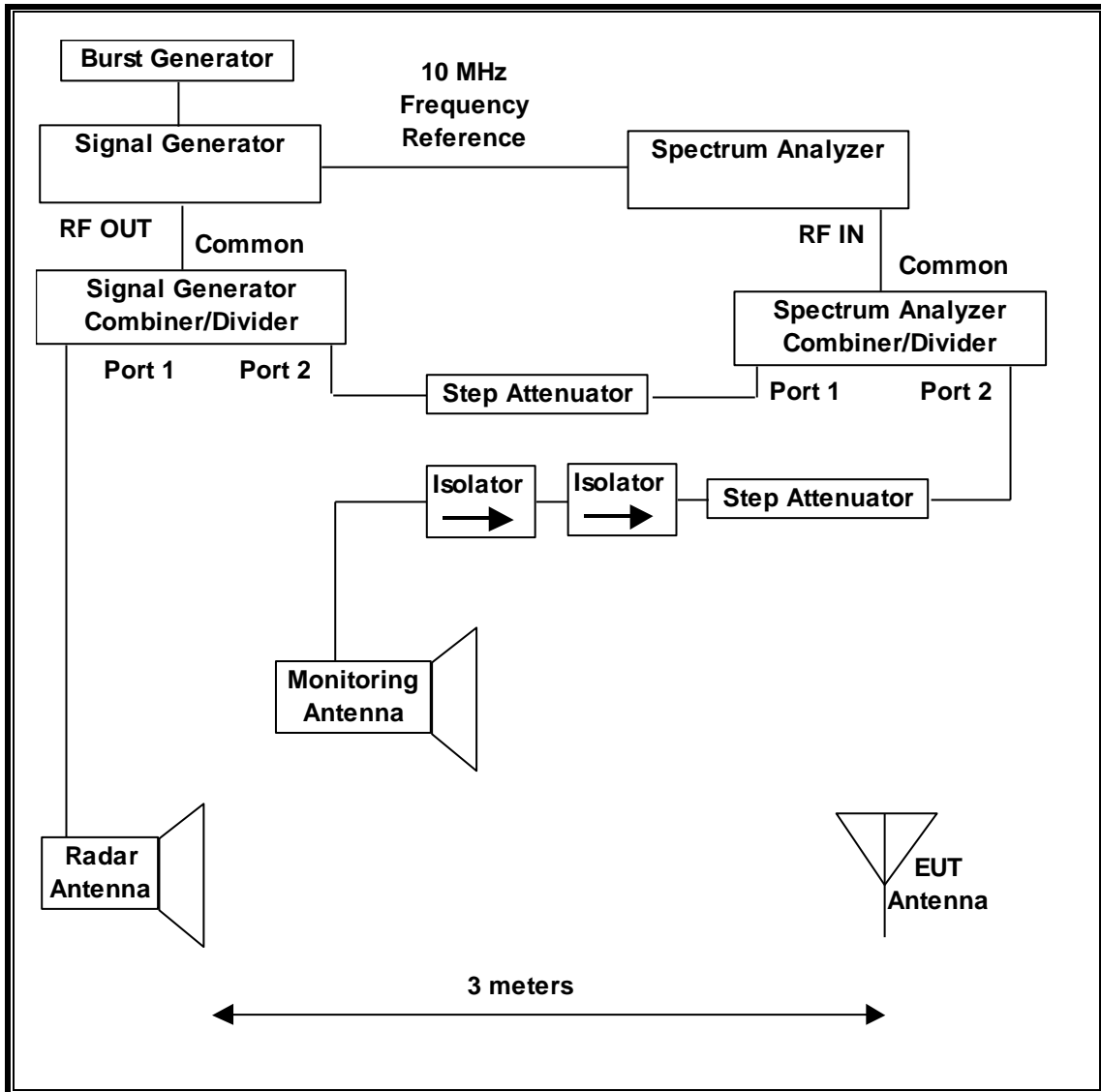

SYSTEM OVERVIEW

The short pulse and long pulse signal generating system utilizes the NTIA software. The Vector Signal Generator has been validated by the NTIA. The hopping signal generating system utilizes the CCS simulated hopping method and system, which has been validated by the DoD, FCC and NTIA. The software selects waveform parameters from within the bounds of the signal type on a random basis using uniform distribution.

The short pulse types 1, 2, 3 and 4, and the long pulse type 5 parameters are randomized at run-time.

The hopping type 6 pulse parameters are fixed while the hopping sequence is based on the August 2005 NTIA Hopping Frequency List. The initial starting point randomized at run-time and each subsequent starting point is incremented by 475. Each frequency in the 100-length segment is compared to the boundaries of the EUT Detection Bandwidth and the software creates a hopping burst pattern in accordance with Section 7.4.1.3 Method #2 Simulated Frequency Hopping Radar Waveform Generating Subsystem of KDB 905462 D02. The frequency of the signal generator is incremented in 1 MHz steps from F_L to F_H for each successive trial. This incremental sequence is repeated as required to generate a minimum of 30 total trials and to maintain a uniform frequency distribution over the entire Detection Bandwidth.

The signal monitoring equipment consists of a spectrum analyzer. The aggregate ON time is calculated by multiplying the number of bins above a threshold during a particular observation period by the dwell time per bin, with the analyzer set to peak detection and max hold.

SYSTEM CALIBRATION

A 50-ohm load is connected in place of the spectrum analyzer, and the spectrum analyzer is connected to a horn antenna via a coaxial cable, with the reference level offset set to (horn antenna gain – coaxial cable loss). The signal generator is set to CW mode. The amplitude of the signal generator is adjusted to yield a level of –64 dBm as measured on the spectrum analyzer.

Without changing any of the instrument settings, the spectrum analyzer is reconnected to the Common port of the Spectrum Analyzer Combiner/Divider. The Reference Level Offset of the spectrum analyzer is adjusted so that the displayed amplitude of the signal is –64 dBm.

The spectrum analyzer displays the level of the signal generator as received at the antenna ports of the Master Device. The interference detection threshold may be varied from the calibrated value of –64 dBm and the spectrum analyzer will still indicate the level as received by the Master Device.

ADJUSTMENT OF DISPLAYED TRAFFIC LEVEL

A link is established between the Master and Slave and the distance between the units is adjusted as needed to provide a suitable received level at the Master and Slave devices. Iperf is utilized to generate WLAN traffic. The monitoring antenna is adjusted so that the WLAN traffic level, as displayed on the spectrum analyzer, is at lower amplitude than the radar detection threshold.

TEST AND MEASUREMENT EQUIPMENT

The following test and measurement equipment was utilized for the DFS tests documented in this report:

TEST EQUIPMENT LIST				
Description	Manufacturer	Model	Serial Number	Cal Due
Spectrum Analyzer, PXA, 3Hz to 44GHz	Keysight	N9030A	US51350187	06/22/18
Signal Generator, MXG X-Series RF Vector	Agilent	N5182B	MY51350337	04/21/18

6.1.3. TEST AND MEASUREMENT SOFTWARE

The following test and measurement software was utilized for the tests documented in this report:

TEST SOFTWARE LIST		
Name	Version	Test / Function
Aggregate Time-PXA	3.0	Channel Loading and Aggregate Closing Time
PXA Read	3.0.0.9	Signal Generator Screen Capture
SGXProject.exe	1.7	Radar Waveform Generation and Download

6.1.4. TEST ROOM ENVIRONMENT

The test room temperature and humidity shall be maintained within normal temperature of 15~35 °C and normal humidity 20~75% (relative humidity).

ENVIRONMENT CONDITION

Parameter	Value
Temperature	24.9 °C
Humidity	29 %

6.1.5. SETUP OF EUT

RADIATED METHOD EUT TEST SETUP

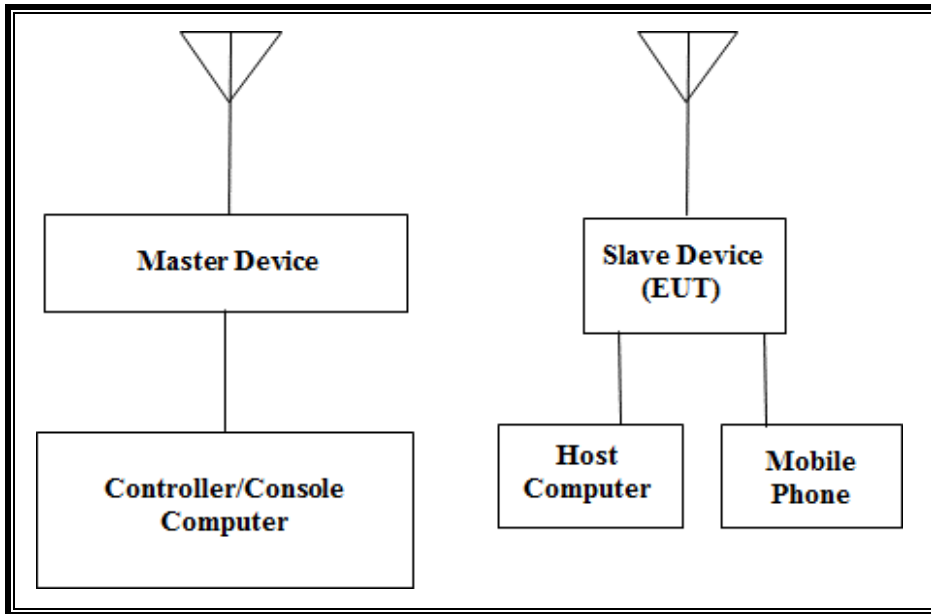

SUPPORT EQUIPMENT

The following support equipment was utilized for the DFS tests documented in this report:

PERIPHERAL SUPPORT EQUIPMENT LIST				
Description	Manufacturer	Model	Serial Number	FCC ID
802.11ac Dual Band Wireless Access Point (Master)	Cisco	AIR-CAP3702E-A-K9	FTX181570A6	LDK102087
P.O.E. Injector	Phihong	POE30U-560(G)	PHI170102N2	DoC
Notebook PC (Master)	Lenovo	Type 4236-B92	PB-HEXC4 12/05	DoC
AC Adapter (Master PC)	Lenovo	42T4418	11S42T4418Z1ZGWG08R90M	DoC
Power Dock	Mayfield Robotics	AHR-M8D	Cert Dock 4	DoC
AC Adapter (Dock)	Dongguan Dongsong Electronic Co.	DYS902-190473W	DYS902-190473-17502	DoC
Notebook PC(EUT Console)	Dell	P54G	G07HW A03	PPD-QCNFA364AH
AC Adapter (EUT PC)	Lite-On Technology Co.	LA4SNM131	CN-0CDF57-LOC00	DoC
Mobile Phone	Apple	A1660	F4GTD115HG6Y	BCG-3085A
Ac Adapter(Phone)	Apple	A1385	E199967	DoC

Mobile phone was used to connect the EUT to the AP via “Gizmo Edge” App.

6.1.6. DESCRIPTION OF EUT

For FCC the EUT operates over the 5250-5350 MHz and 5470-5725 MHz ranges.

The EUT is a Slave Device without Radar Detection.

The highest power level within these bands is 15.93 dBm EIRP in the 5250-5350 MHz band and 18.85 dBm EIRP in the 5470-5725 MHz band.

The only antenna assembly utilized with the EUT has a gain of 2.6 dBi in the 5250-5350 MHz band and 3.3 dBi in the 5470-5725 MHz band.

Two integrated antennas are utilized to meet the diversity and MIMO operational requirements.

The rated output power of the Master unit is > 23dBm (EIRP). Therefore the required interference threshold level is -64 dBm. After correction for procedural adjustments, the required radiated threshold at the antenna port is $-64 + 1 = -63$ dBm.

The calibrated radiated DFS Detection Threshold level is set to -64 dBm. The tested level is lower than the required level hence it provides a margin to the limit.

The EUT uses two transmitter/receiver chains, each connected to an antenna to perform radiated tests.

WLAN traffic that meets or exceeds the minimum required loading was generated by transferring a data stream from the Master Device to the Slave Device using iPerf version 2.0.5 software package.

TPC is not required since the maximum EIRP is less than 500 mW (27 dBm).

The EUT utilizes the 802.11a/n architecture. Two nominal channel bandwidths are implemented: 20 MHz and 40 MHz.

The software installed in the EUT is Ralink RT5x7xQA.exe with revisions RT5x7x_V1.0.8.0.

The software installed in the access point is AP3G2-K9W7-M Version 15.3(3)JAB.

UNIFORM CHANNEL SPREADING

This is requirement not applicable to Slave Devices.

OVERVIEW OF MASTER DEVICE WITH RESPECT TO §15.407 (h) REQUIREMENTS

The Master Device is a Cisco Access Point, FCC ID: LDK102087. The minimum antenna gain for the Master Device is 6 dBi.

The rated output power of the Master unit is > 23dBm (EIRP). Therefore the required interference threshold level is -64 dBm. After correction for procedural adjustments, the required radiated threshold at the antenna port is $-64 + 1 = -63$ dBm.

The calibrated radiated DFS Detection Threshold level is set to -64 dBm. The tested level is lower than the required level hence it provides a margin to the limit.

6.2. RESULTS FOR 20 MHz BANDWIDTH

6.2.1. TEST CHANNEL

All tests were performed at a channel center frequency of 5500 MHz.

6.2.2. RADAR WAVEFORM AND TRAFFIC

RADAR WAVEFORM

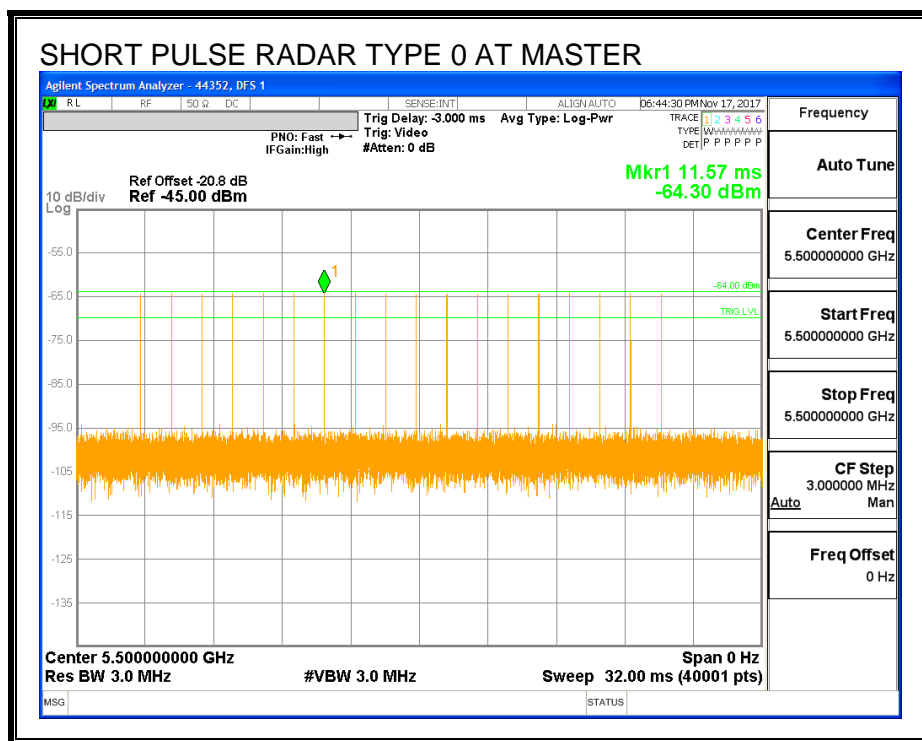

TRAFFIC

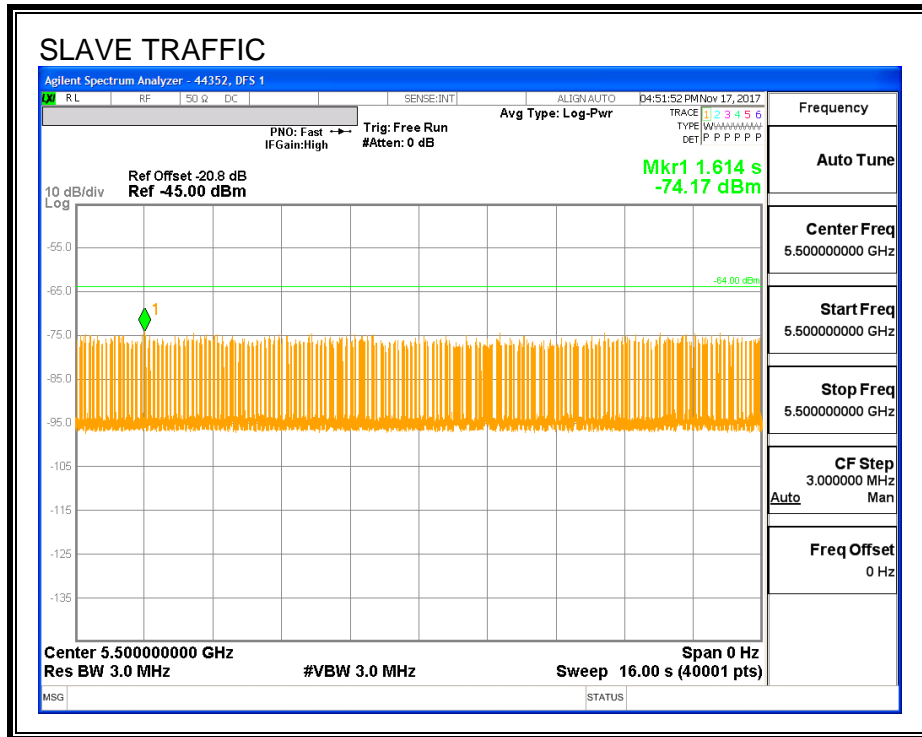

CHANNEL LOADING

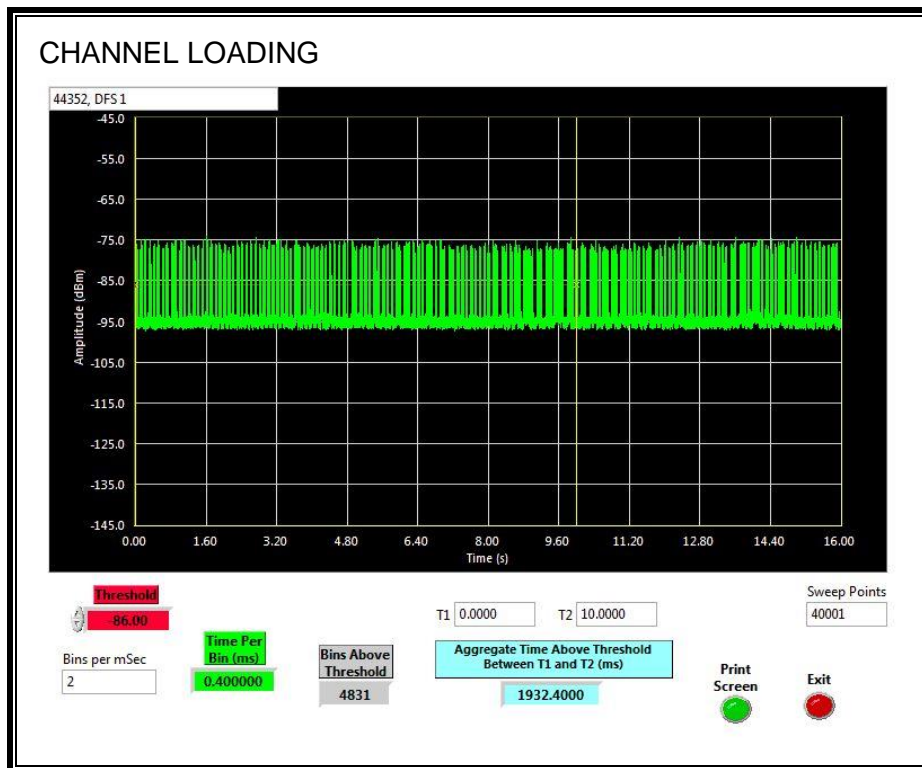

The level of traffic loading on the channel by the EUT is 19.324%.

6.2.3. OVERLAPPING CHANNEL TESTS

RESULTS

These tests are not applicable.

6.2.4. MOVE AND CLOSING TIME

REPORTING NOTES

The reference marker is set at the end of last radar pulse.

The delta marker is set at the end of the last WLAN transmission following the radar pulse. This delta is the channel move time.

The aggregate channel closing transmission time is calculated as follows:

Aggregate Transmission Time =
(Number of analyzer bins showing transmission) * (dwell time per bin)

The observation period over which the aggregate time is calculated begins at (Reference Marker + 200 msec) and ends no earlier than (Reference Marker + 10 sec).

RESULTS

Channel Move Time (sec)	Limit (sec)
0.054	10

Aggregate Channel Closing Transmission Time (msec)	Limit (msec)
0.0	60

MOVE TIME

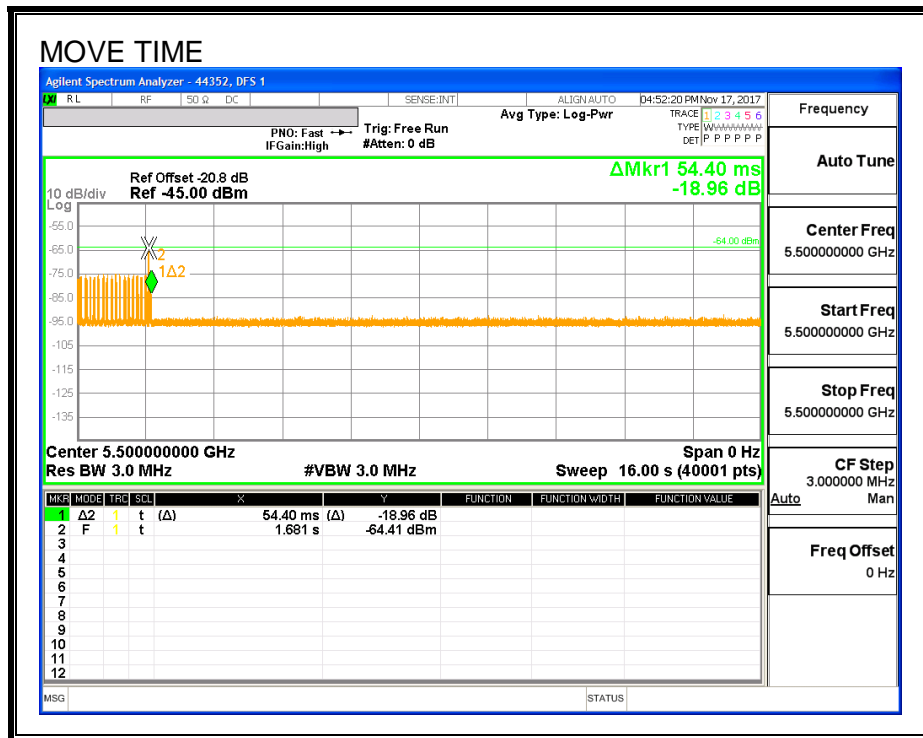

CHANNEL CLOSING TIME

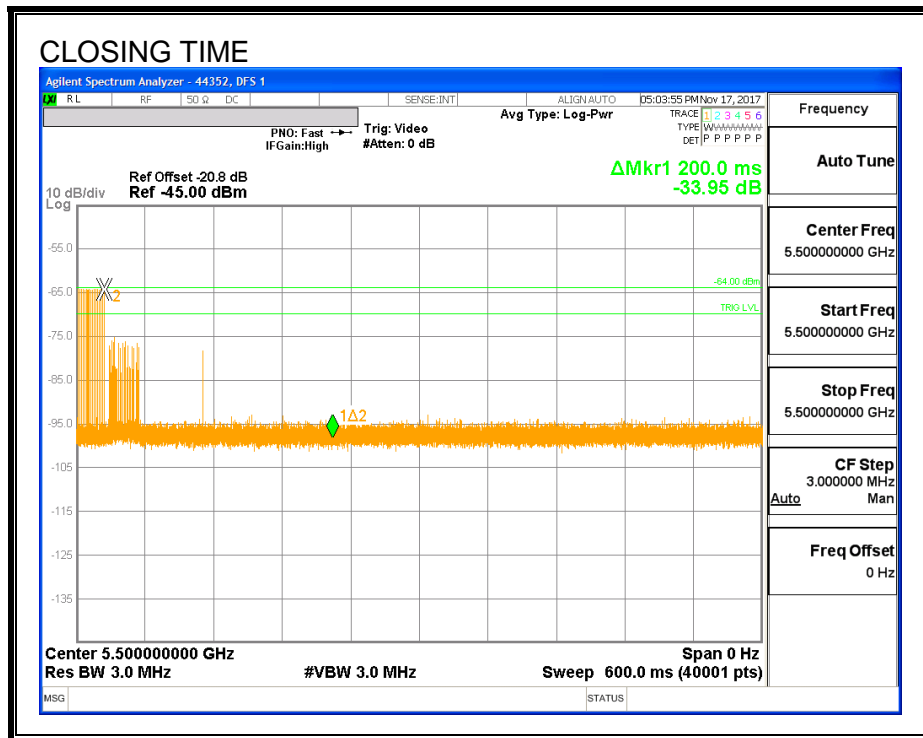

AGGREGATE CHANNEL CLOSING TRANSMISSION TIME

No transmissions are observed during the aggregate monitoring period.

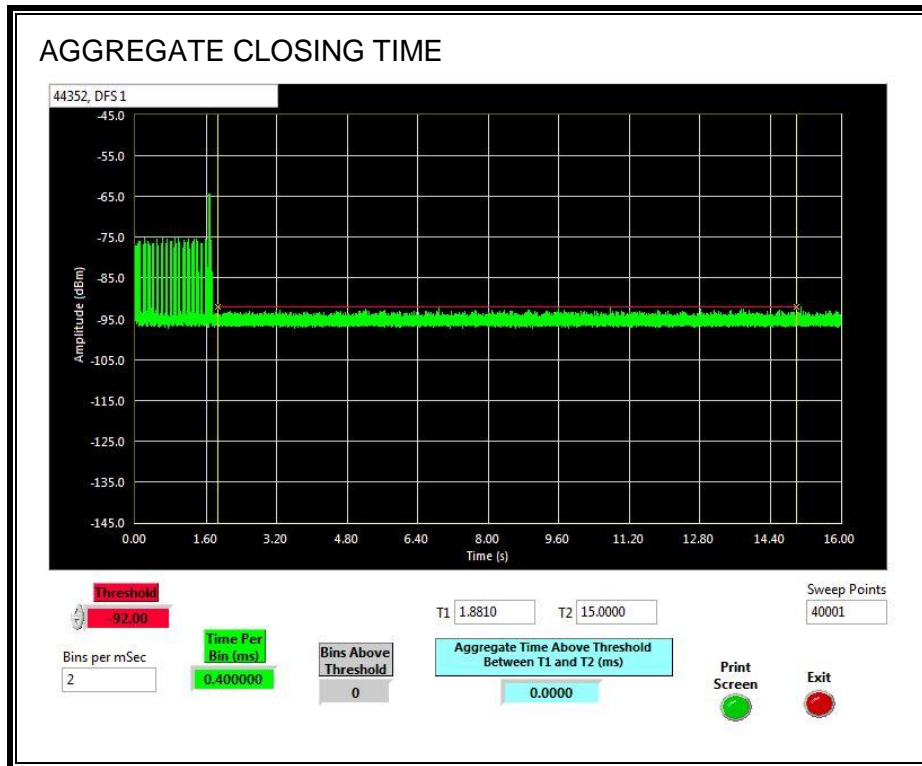

6.3. RESULTS FOR 40 MHz BANDWIDTH

6.3.1. TEST CHANNEL

All tests were performed at a channel center frequency of 5510 MHz.

6.3.2. RADAR WAVEFORM AND TRAFFIC

RADAR WAVEFORM

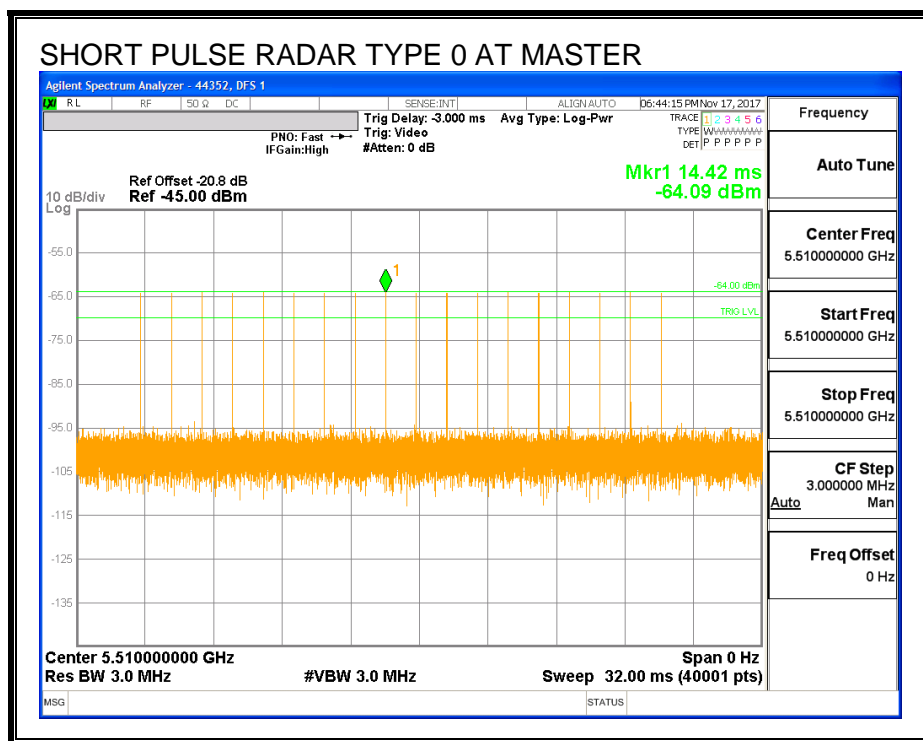

TRAFFIC

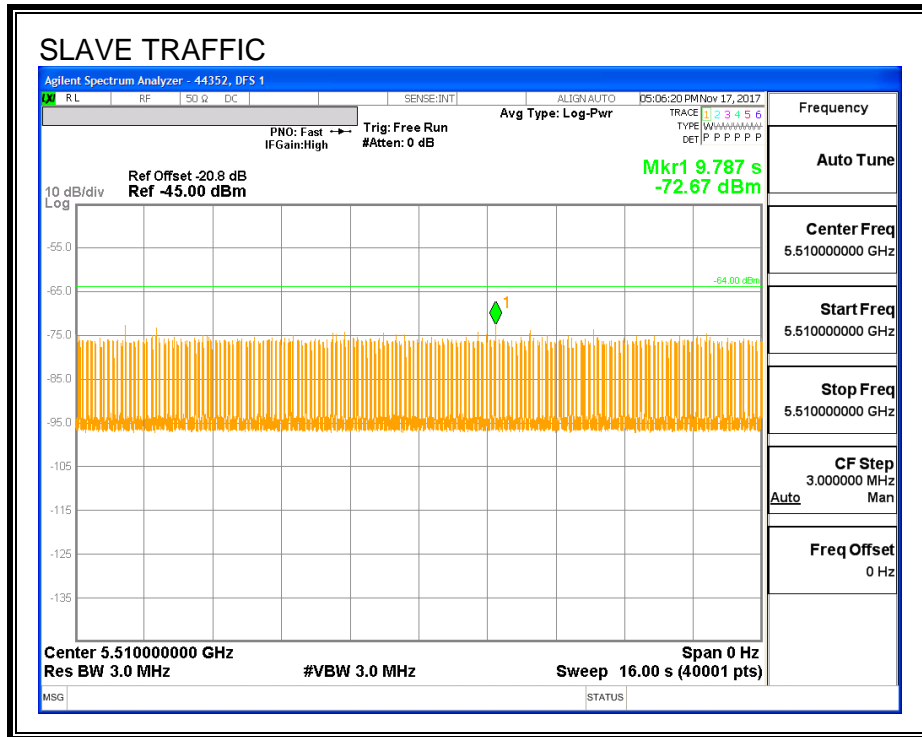

CHANNEL LOADING

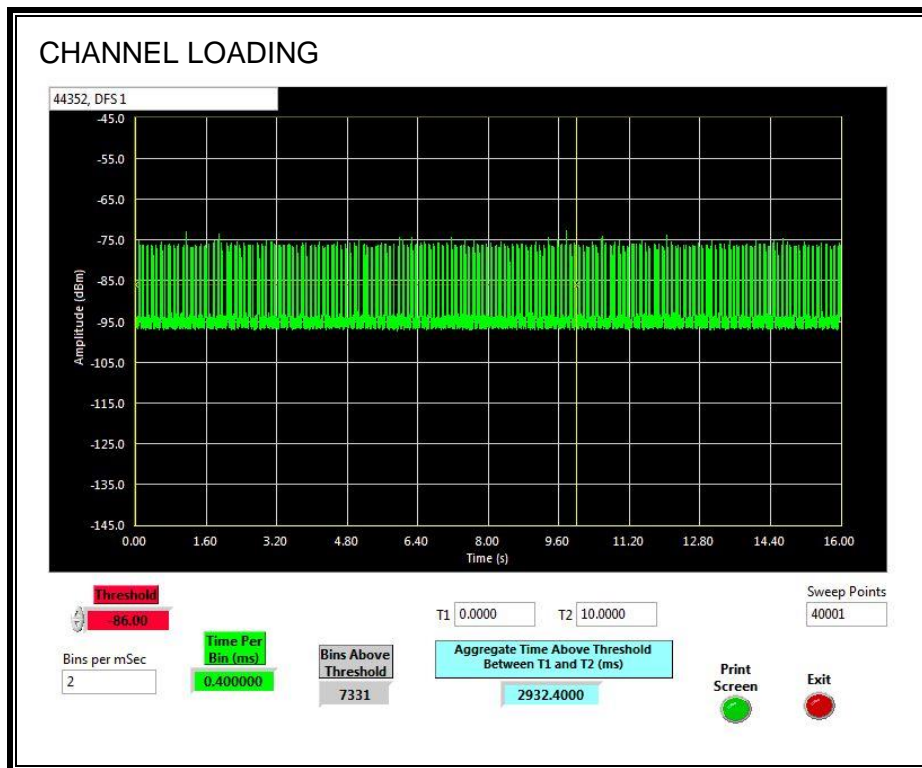

The level of traffic loading on the channel by the EUT is 29.324%.

6.3.3. OVERLAPPING CHANNEL TESTS

RESULTS

These tests are not applicable.

6.3.4. MOVE AND CLOSING TIME

REPORTING NOTES

The reference marker is set at the end of last radar pulse.

The delta marker is set at the end of the last WLAN transmission following the radar pulse. This delta is the channel move time.

The aggregate channel closing transmission time is calculated as follows:

Aggregate Transmission Time =
(Number of analyzer bins showing transmission) * (dwell time per bin)

The observation period over which the aggregate time is calculated begins at (Reference Marker + 200 msec) and ends no earlier than (Reference Marker + 10 sec).

RESULTS

Channel Move Time (sec)	Limit (sec)
0.029	10

Aggregate Channel Closing Transmission Time (msec)	Limit (msec)
0.0	60

MOVE TIME

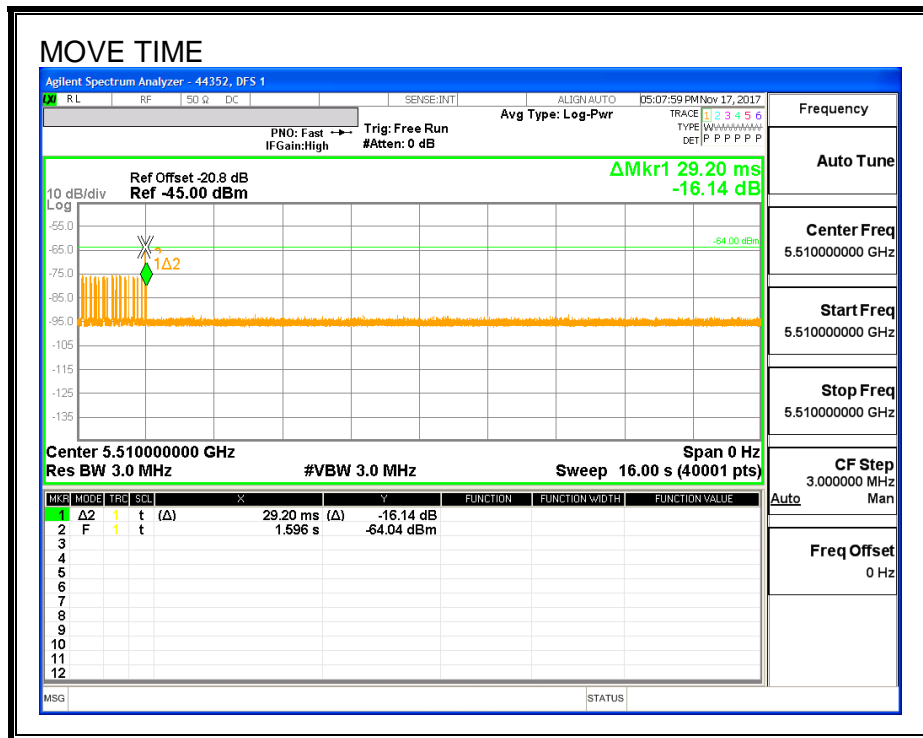

CHANNEL CLOSING TIME

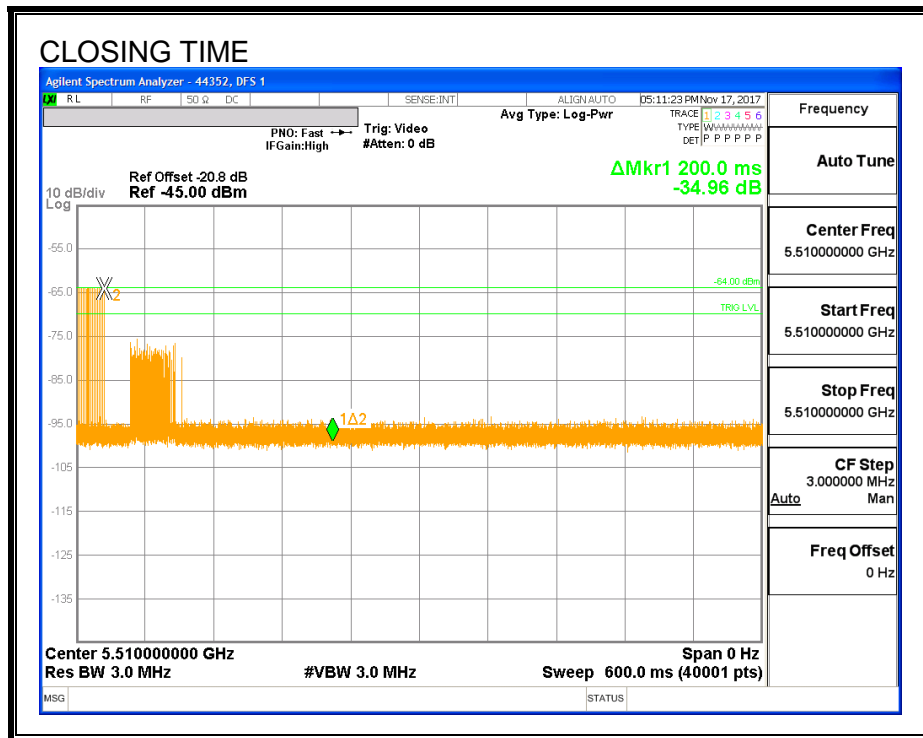

AGGREGATE CHANNEL CLOSING TRANSMISSION TIME

No transmissions are observed during the aggregate monitoring period.

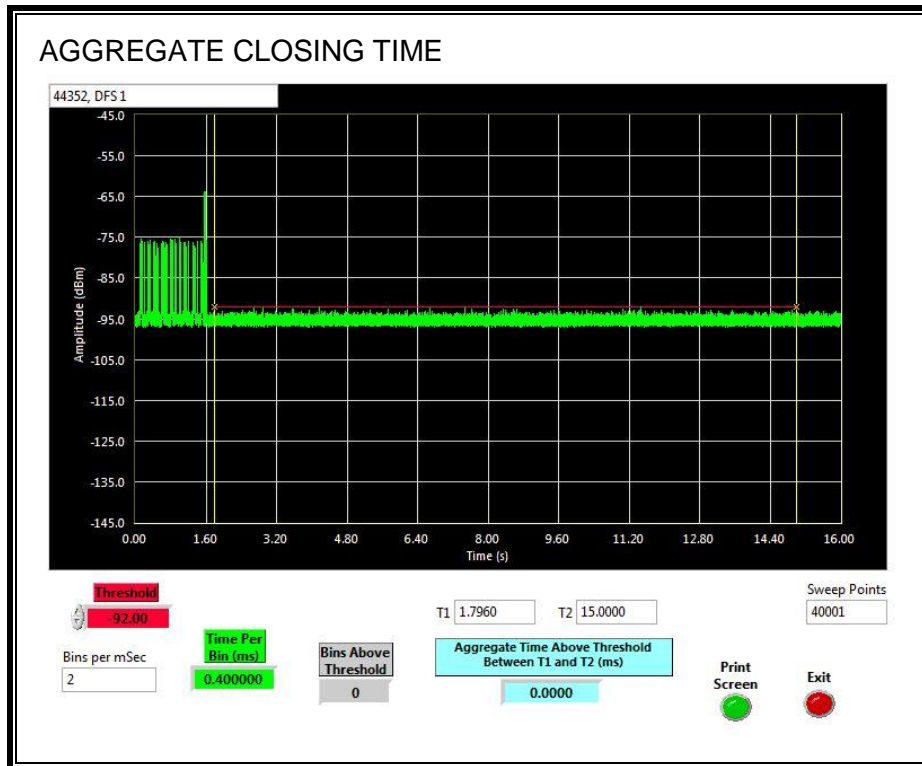

6.3.5. 30-MINUTE NON-OCCUPANCY PERIOD

RESULTS

No EUT transmissions were observed on the test channel during the 30-minute observation time.

