

## SAR TEST REPORT

**Report Reference No.**.....: **LCS180323004AEB**

**FCC ID**.....: **2AMY3-ACERONE74G**

**Testing Laboratory Name** .....: **Shenzhen LCS Compliance Testing Laboratory Ltd.**

Address .....: 1/F., Xingyuan Industrial Park, Tongda Road, Bao'an Avenue, Bao'an District, Shenzhen, Guangdong, China

**Applicant's name**.....: **Acer India Pvt Ltd.**

Address .....: Embassy Heights 6th Floor, No.13, Magrath Road, (Next to Hosmat Hospital) Bangalore, 560025, India

**Test specification** .....

**IEEE 1528:2013**

Standard .....: **47CFR §2.1093**

**KDB 865664**

Test Report Form No .....: LCSEMC-1.0

TRF Originator.....: Shenzhen LCS Compliance Testing Laboratory Ltd.

Master TRF.....: Dated 2011-03

**Shenzhen LCS Compliance Testing Laboratory Ltd. All rights reserved.**

This publication may be reproduced in whole or in part for non-commercial purposes as long as the Shenzhen LCS Compliance Testing Laboratory Ltd. is acknowledged as copyright owner and source of the material. Shenzhen LCS Compliance Testing Laboratory Ltd. takes no responsibility for and will not assume liability for damages resulting from the reader's interpretation of the reproduced material due to its placement and context.

**Test item description** .....: **Tablet PC**

Trade Mark .....: Acer

Model/Type reference.....: ACER ONE 7 4G

Listed Models .....: Acer one 8 T4-82L

Ratings .....: DC 3.8V by Li-ion battery(3500mAh)  
Recharged by DC 5V/1500mA Adapter

Hardware version .....: L706BA\_V1\_20170902

Software version .....: full\_elink8735b\_f3h-user.2018031215

EUT Type .....: Production Unit

Exposure category.....: General population / Uncontrolled environment

Device type.....: Portable device

Result.....: **PASS**

**Compiled by:**



Aking Jin/ File administrators

**Supervised by:**



Dick Su/ Technique principal

**Approved by:**

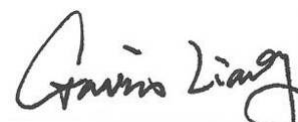

Gavin Liang/ Manager

## TEST REPORT

<b>Test Report No. :</b> <b>LCS180323004AEB</b>	July 12, 2018 ----- Date of issue
---	---

Equipment under Test        :    Tablet PC

Model /Type                    :    ACER ONE 7 4G

Listed Models                 :    Acer one 8 T4-82L

**Applicant**                    :    **Acer India Pvt Ltd.**

Address                         :    Embassy Heights 6th Floor, No.13, Magrath Road, (Next to Hosmat Hospital) Bangalore, 560025, India

**Manufacturer**             :    **Yuko Technology Co., Ltd**

Address                         :    6th Floor, A9 building, TianRui Industrial Park, FuYuan 1st Road, FuYong Town, Bao'an District, ShenZhen, China

**Factory**                      :    **Yuko Technology Co., Ltd**

Address                         :    6th Floor, A9 building, TianRui Industrial Park, FuYuan 1st Road, FuYong Town, Bao'an District, ShenZhen, China

<b>Test Result:</b>	<b>PASS</b>
---------------------	-------------

The test report merely corresponds to the test sample.  
 It is not permitted to copy extracts of these test result without the written permission of the test laboratory.

## Modified History

Revision	Issue Date	Revisions	Revised By
00	May 07, 2018	Initial Issue	Gavin Liang
01	July 12, 2018	a. Additional model number Acer one 8 T4-82L based on original model: Acer One 7 4G. b. Change power adapter charging current from 5V/2000mA into 5V/1500mA as provided incorrect information by power adapter manufacturer	Gavin Liang

## Contents

<b>1.</b>	<b><u>TEST STANDARDS</u></b>	<b>6</b>
<b>2.</b>	<b><u>SUMMARY</u></b>	<b>7</b>
2.1.	General Remarks	7
2.2.	Summary SAR Results	7
2.3.	Equipment under Test	7
2.4.	EUT operation mode	7
2.5.	Internal Identification of AE used during the test	8
2.6.	Product Description	8
<b>3.</b>	<b><u>TEST ENVIRONMENT</u></b>	<b>9</b>
3.1.	Address of the test laboratory	9
3.2.	Test Facility	9
3.3.	Environmental conditions	9
3.4.	SAR Limits	9
3.5.	Equipments Used during the Test	10
<b>4.</b>	<b><u>SAR MEASUREMENTS SYSTEM CONFIGURATION</u></b>	<b>11</b>
4.1.	SAR Measurement Set-up	11
4.2.	DASY5 E-field Probe System	12
4.3.	Phantoms Description	13
4.4.	Device Holder	14
4.5.	Scanning Procedure	14
4.6.	Data Storage and Evaluation	15
4.7.	SAR Measurement System	17
4.8.	Dielectric Performance	17
4.9.	System Check	18
4.10.	Measurement Procedures	19
4.11.	Operational Conditions during Test	23
4.12.	Position of the wireless device in relation to the phantom	23
4.13.	Test Configuration	24
4.14.	Power Drift	30
4.15.	Power Reduction	30
<b>5.</b>	<b><u>TEST CONDITIONS AND RESULTS</u></b>	<b>31</b>
5.1.	Conducted Power Results	31
5.2.	Transmit Antennas Position	35
5.3.	Standalone SAR Test Exclusion Considerations	36
5.4.	Standalone Estimated SAR	36
5.5.	SAR Measurement Results	37
5.6.	SAR Reporting Results	38
5.7.	Simultaneous TX SAR Considerations	43
5.8.	SAR Measurement Variability	46
5.9.	Measurement Uncertainty	47
5.10.	System Check Results	48
5.11.	SAR Test Graph Results	58
<b>6.</b>	<b><u>CALIBRATION CERTIFICATE</u></b>	<b>72</b>
6.1.	Probe Calibration Certificate	72
6.2.	D900V2 Dipole Calibration Certificate	83
6.3.	D1900V2 Dipole Calibration Certificate	91
6.4.	D2450V2 Dipole Calibration Certificate	99
6.5.	D5GHzV2 Dipole Calibration Certificate	107
6.6.	DAE4 Calibration Certificate	123
<b>7.</b>	<b><u>TEST SETUP PHOTOS</u></b>	<b>127</b>

**8. EXTERNAL PHOTOS OF THE EUT**

---

# **1. TEST STANDARDS**

The tests were performed according to following standards:

[IEEE 1528-2013 \(2014-06\)](#): Recommended Practice for Determining the Peak Spatial-Average Specific Absorption Rate (SAR) in the Human Head from Wireless Communications Devices: Measurement Techniques

[IEEE Std. C95-3 \(2002\)](#): IEEE Recommended Practice for the Measurement of Potentially Hazardous Electromagnetic Fields – RF and Microwave

[IEEE Std. C95-1 \(1991\)](#): IEEE Standard for Safety Levels with Respect to Human Exposure to Radio Frequency Electromagnetic Fields, 3 kHz to 300 GHz.

[KDB 865664D01v01r04 \(August 7, 2015\)](#): SAR Measurement Requirements for 100 MHz to 6 GHz

[KDB 865664D02v01r02 \(October 23, 2015\)](#): RF Exposure Compliance Reporting and Documentation Considerations

[KDB 447498 D01 General RF Exposure Guidance v06 \(October 23, 2015\)](#): Mobile and Portable Devices RF Exposure Procedures and Equipment Authorization Policies

[KDB 447498 D03 Supplement C Cross-Reference v01 \(January 17, 2014\)](#): Mobile and Portable Device RF Exposure Procedures and Equipment Authorization Policies

[KDB 248227 D01 802.11 Wi-Fi SAR v02r02](#): SAR GUIDANCE FOR IEEE 802.11 (Wi-Fi) TRANSMITTERS

[KDB 941225 D01 3G SAR Procedures v03r01](#): 3G SAR Measurement Procedures

[KDB 941225 D05 SAR for LTE Devices v02r05](#): SAR EVALUATION CONSIDERATIONS FOR LTE DEVICES

[KDB 616217 D04 SAR for laptop and tablets v01r02](#): SAR Evaluation Considerations for Laptop, Netbook, Netbook and Tablet Computers

## 2. SUMMARY

### 2.1. General Remarks

Date of receipt of test sample	:	April 20, 2018
Testing commenced on	:	April 20, 2018
Testing concluded on	:	May 04, 2018

### 2.2. Summary SAR Results

The maximum of results of SAR found during testing for Acer One 7 4G are follows:

<Highest Reported standalone SAR Summary>

Classment Class	Frequency Band	Head (Report SAR <sub>1-g</sub> (W/Kg))	Body-worn (Report SAR <sub>1-g</sub> (W/Kg))
PCE	GSM 850	0.123	<b>1.282</b>
	GSM1900	0.200	0.677
	WCDMA Band V	0.145	0.657
	WCDMA Band II	0.133	0.507
	LTE Band 5	0.165	0.779
DTS	2.4GWLAN	<b>0.956</b>	0.279
NII	5GWLAN	0.433	0.093

This device is in compliance with Specific Absorption Rate (SAR) for general population/uncontrolled exposure limits (1.6 W/kg) specified in FCC 47 CFR part 2 (2.1093) and IEEE C95.1-1991, and had been tested in accordance with the measurement methods and procedures specified in IEEE 1528-2013;

<Highest Reported simultaneous SAR Summary>

Exposure Position	Frequency Band	Classment Class	Highest Reported Simultaneous Transmission SAR <sub>1-g</sub> (W/kg)
Head	LTE Band 5	PCE	<b>1.121</b>
	2.4GWLAN	DTS	
Body	GSM 850	PCE	<b>1.561</b>
	2.4GWLAN	DTS	

### 2.3. Equipment under Test

#### Power supply system utilised

Power supply voltage	:	<input type="radio"/> 120V / 60 Hz	<input type="radio"/> 115V / 60Hz
		<input type="radio"/> 12 V DC	<input type="radio"/> 24 V DC
		<input checked="" type="radio"/> Other (specified in blank below)	

DC 3.80 V

### 2.4. EUT operation mode

Acer One 7 4G is subscriber equipment in the WCDMA/GSM/LTE system. The HSPA/UMTS frequency band is Band II/V, LTE frequency band is band 5. The GSM/GPRS/EDGE frequency band includes GSM850 and GSM900 and DCS1800 and PCS1900, but only Band II and Band V and GSM850 and PCS1900 bands test data included in this report. The Terminal implements such functions as RF signal receiving/transmitting, HSPA/UMTS and GPRS/EDGE protocol processing, video MMS service and etc. Externally it provides micro SD card interface and SIM card interface.

NOTE: Unless otherwise noted in the report, the functional boards installed in the units shall be selected from the below list, but not means all the functional boards listed below shall be installed in one unit.

## 2.5. Internal Identification of AE used during the test

AE ID*	Description
AE1	Battery
AE2	Charger

AE2

Model: HJ-0502000

INPUT: AC100-240V 50/60Hz 0.3A

OUTPUT: DC 5.0V 1500mA

\*AE ID: is used to identify the test sample in the lab internally.

## 2.6. Product Description

Name of EUT	Tablet PC
Model Number	Acer One 7 4G, Acer one 8 T4-82L
Modulation Type	GMSK for GSM/GPRS, 8-PSK for EDGE,QPSK for UMTS, QPSK/16QAM for LTE
Hardware version	L706BA_V1_20170902
Software version	full_elink8735b_f3h-user.2018031215
GSM/EDGE/GPRS Operation Frequency Band	GSM850/PCS1900/GPRS850/GPRS1900/EDGE850/EDGE1900
UMTS Operation Frequency Band	UMTS FDD Band II/V
LTE Operation Frequency Band	LTE Band 5
GSM/EDGE/GPRS	Supported GSM/GPRS/EDGE
GSM Release Version	R99
GSM/EDGE/GPRS Power Class	GSM850:Power Class 4/ PCS1900:Power Class 1
GPRS/EDGE Multislot Class	GPRS/EDGE: Multi-slot Class 12
GPRS operation mode	Class B
WCDMA Release Version	R8
HSDPA Release Version	Release 7
HSUPA Release Version	Release 6
DC-HSUPA Release Version	Not Supported
LTE Release Version	R9
LTE/UMTS Power Class	Class 3
WLAN FCC Modulation Type	IEEE 802.11b: DSSS(CCK,DQPSK,DBPSK) IEEE 802.11g: OFDM(64QAM, 16QAM, QPSK, BPSK) IEEE 802.11n HT20:OFDM (64QAM, 16QAM, QPSK,BPSK) IEEE 802.11n HT40:OFDM (64QAM, 16QAM, QPSK,BPSK) IEEE 802.11a: OFDM(64QAM, 16QAM, QPSK, BPSK)
WLAN FCC Operation frequency	IEEE 802.11b:2412-2462MHz IEEE 802.11g:2412-2462MHz IEEE 802.11n HT20:2412-2462MHz,5180-5240MHz,5745-5825MHz IEEE 802.11n HT40:2422-2452MHz,5190-5230MHz,5755-5795MHz IEEE 802.11a:5180-5240MHz, 5745-5825MHz
Antenna Type	PIFA Antenna, 0.5dBi(Max.) for BT/WIFI/2G/3G/4G
BT Modulation Type	GFSK,8-DPSK, $\pi/4$ -DQPSK(BT V4.0)
Extreme temp. Tolerance	-20°C to +45°C
GPS function	Support and only RX
FM function	Support and only RX
Extreme vol. Limits	3.30VDC to 4.35VDC (nominal: 3.80VDC)



### 3. TEST ENVIRONMENT

#### 3.1. Address of the test laboratory

##### Shenzhen LCS Compliance Testing Laboratory Ltd

1/F., Xingyuan Industrial Park, Tongda Road, Bao'an Avenue, Bao'an District, Shenzhen, Guangdong, China  
 The sites are constructed in conformance with the requirements of ANSI C63.4 (2014) and CISPR Publication 22.

#### 3.2. Test Facility

The test facility is recognized, certified, or accredited by the following organizations:

- CNAS Registration Number. is L4595.
- FCC Registration Number. is 899208.
- Industry Canada Registration Number. is 9642A-1.
- VCCI Registration Number. is C-4260 and R-3804.
- ESMD Registration Number. is ARCB0108.
- UL Registration Number. is 100571-492.
- TUV SUD Registration Number. is SCN1081.
- TUV RH Registration Number. is UA 50296516-001
- NVLAP Registration Code is 600167-0

#### 3.3. Environmental conditions

During the measurement the environmental conditions were within the listed ranges:

Temperature:	18-25 ° C
Humidity:	40-65 %
Atmospheric pressure:	950-1050mbar

#### 3.4. SAR Limits

Exposure Limits	FCC Limit (1g Tissue)	
	SAR (W/kg)	
	(General Population / Uncontrolled Exposure Environment)	(Occupational / Controlled Exposure Environment)
Spatial Average (averaged over the whole body)	0.08	0.4
Spatial Peak (averaged over any 1 g of tissue)	1.60	8.0
Spatial Peak (hands/wrists/feet/ankles averaged over 10 g)	4.0	20.0

Population/Uncontrolled Environments are defined as locations where there is the exposure of individual who have no knowledge or control of their exposure.

Occupational/Controlled Environments are defined as locations where there is exposure that may be incurred by people who are aware of the potential for exposure (i.e. as a result of employment or occupation).

### 3.5. Equipments Used during the Test

Test Equipment	Manufacturer	Type/Model	Serial Number	Calibration	
				Last Calibration	Calibration Interval
Data Acquisition Electronics DAEx	SPEAG	DAE4	1315	2017/08/15	1
E-field Probe	SPEAG	EX3DV4	3842	2017/08/15	1
System Validation Dipole D835V2	SPEAG	D900V2	1d141	2016/10/11	3
System Validation Dipole 1900V2	SPEAG	D1900V2	5d162	2015/09/16	3
System Validation Dipole D2450V2	SPEAG	D2450V2	818	2015/09/14	3
System Validation Dipole D5GV2	SPEAG	D5GHzV2	1040	2016/06/17	3
Network analyzer	Agilent	8753E	US37390562	2017/02/26	1
Dielectric Probe Kit	Agilent	85070E	US44020288	/	/
Power meter	Agilent	E4417A	GB41292254	2017/10/09	1
Power sensor	Agilent	8481H	MY41095360	2017/10/09	1
Power sensor	Agilent	8481H	MY41095361	2017/10/09	1
Signal generator	IFR	2032	203002/100	2017/10/09	1
Amplifier	AR	75A250	302205	2017/10/09	1

Note:

- 1) Per KDB865664D01 requirements for dipole calibration, the test laboratory has adopted three year extended calibration interval. Each measured dipole is expected to evaluate with following criteria at least on annual interval.
  - a) There is no physical damage on the dipole;
  - b) System check with specific dipole is within 10% of calibrated values;
  - c) The most recent return-loss results,measured at least annually,deviates by no more than 20% from the previous measurement;
  - d) The most recent measurement of the real or imaginary parts of the impedance, measured at least annually is within 50  $\Omega$  from the previous measurement.
- 2) Network analyzer probe calibration against air, distilled water and a shorting block performed before measuring liquid parameters.

## 4. SAR Measurements System configuration

### 4.1. SAR Measurement Set-up

The DASY5 system for performing compliance tests consists of the following items:

A standard high precision 6-axis robot (Stäubli RX family) with controller and software. An arm extension for accommodating the data acquisition electronics (DAE).

A dosimetric probe, i.e. an isotropic E-field probe optimized and calibrated for usage in tissue simulating liquid. The probe is equipped with an optical surface detector system.

A data acquisition electronic (DAE) which performs the signal amplification, signal multiplexing, AD-conversion, offset measurements, mechanical surface detection, collision detection, etc. The unit is battery powered with standard or rechargeable batteries. The signal is optically transmitted to the EOC.

A unit to operate the optical surface detector which is connected to the EOC.

The Electro-Optical Coupler (EOC) performs the conversion from the optical into a digital electric signal of the DAE. The EOC is connected to the DASY5 measurement server.

The DASY5 measurement server, which performs all real-time data evaluation for field measurements and surface detection, controls robot movements and handles safety operation. A computer operating Windows 2003.

DASY5 software and SEMCAD data evaluation software.

Remote control with teach panel and additional circuitry for robot safety such as warning lamps, etc.

The generic twin phantom enabling the testing of left-hand and right-hand usage.

The device holder for handheld Mobile Phones.

Tissue simulating liquid mixed according to the given recipes.

System validation dipoles allowing to validate the proper functioning of the system.

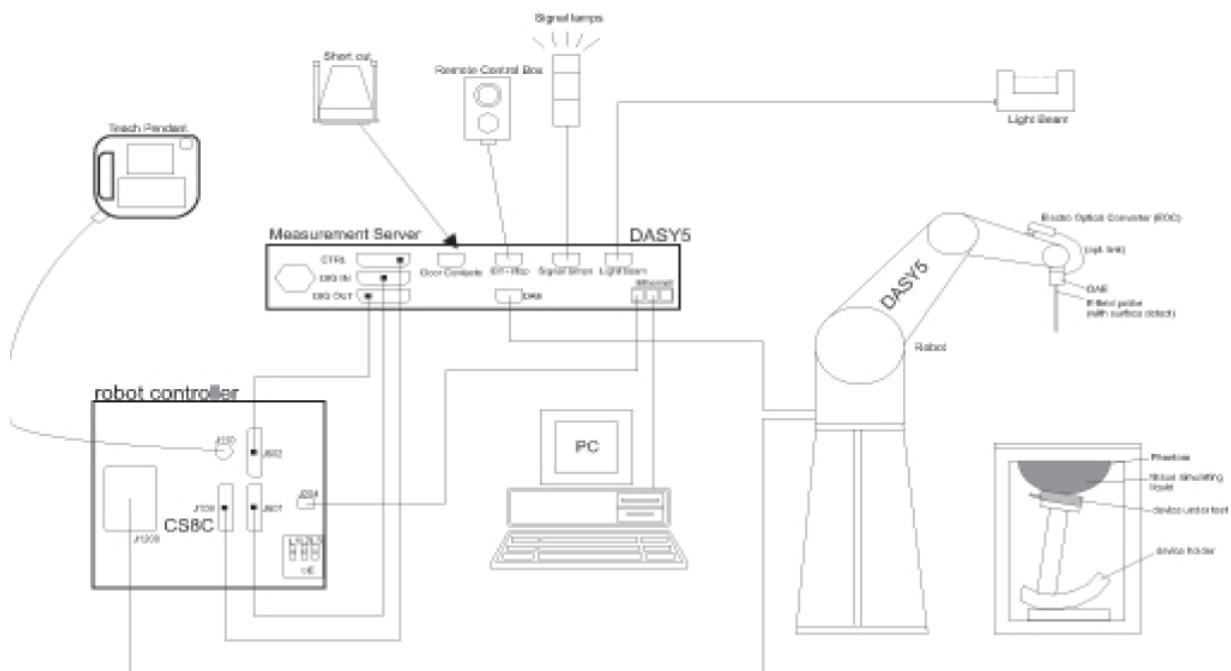

## 4.2. DASY5 E-field Probe System

The SAR measurements were conducted with the dosimetric probe EX3DV4 (manufactured by SPEAG), designed in the classical triangular configuration and optimized for dosimetric evaluation.

### Probe Specification

Construction	Symmetrical design with triangular core Interleaved sensors Built-in shielding against static charges PEEK enclosure material (resistant to organic solvents, e.g., DGBE)
Calibration	ISO/IEC 17025 calibration service available.
Frequency	10 MHz to 6 GHz; Linearity: $\pm 0.2$ dB (30 MHz to 6 GHz)
Directivity	$\pm 0.2$ dB in HSL (rotation around probe axis) $\pm 0.3$ dB in tissue material (rotation normal to probe axis)
Dynamic Range	$5 \mu\text{W/g}$ to $> 100 \text{ mW/g}$ ; Linearity: $\pm 0.2$ dB
Dimensions	Overall length: 337 mm (Tip: 20 mm) Tip diameter: 3.9 mm (Body: 12 mm) Distance from probe tip to dipole centers: 2.0 mm
Application	General dosimetry up to 6 GHz Dosimetry in strong gradient fields Compliance tests of Mobile Phones
Compatibility	DASY3, DASY4, DASY52 SAR and higher, EASY4/MRI



### Isotropic E-Field Probe

The isotropic E-Field probe has been fully calibrated and assessed for isotropicity, and boundary effect within a controlled environment. Depending on the frequency for which the probe is calibrated the method utilized for calibration will change.

The E-Field probe utilizes a triangular sensor arrangement as detailed in the diagram below:

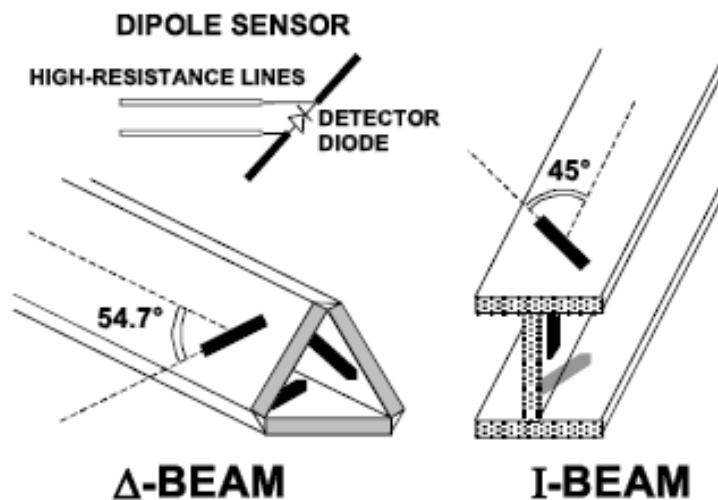

### 4.3. Phantoms Description

#### SAM Twin Phantom

The phantom used for all tests i.e. for both system checks and device testing, was the twin-headed "SAM Phantom", manufactured by SPEAG. The SAM twin phantom is a fiberglass shell phantom with 2mm shell thickness (except the ear region, where shell thickness increases to 6mm).

System checking was performed using the flat section, whilst Head SAR tests used the left and right head profile sections. Body SAR testing also used the flat section between the head profiles.

Shell Thickness	2mm +/- 0.2 mm; The ear region: 6mm	
Filling Volume	Approximately 25 liters	
Dimensions	Major axis:600mm; Minor axis:400mm;	
Measurement Areas	Left hand Right hand Flat phantom	

The bottom plate contains three pairs of bolts for locking the device holder. The device holder positions are adjusted to the standard measurement positions in the three sections.

A white cover is provided to cover the phantom during off-periods to prevent water evaporation and changes in the liquid parameters. Free space scans of devices on top of this phantom cover are possible. Three reference marks are provided on the phantom counter. These reference marks are used to teach the absolute phantom position relative to the robot.

The following figure shows the definition of reference point:

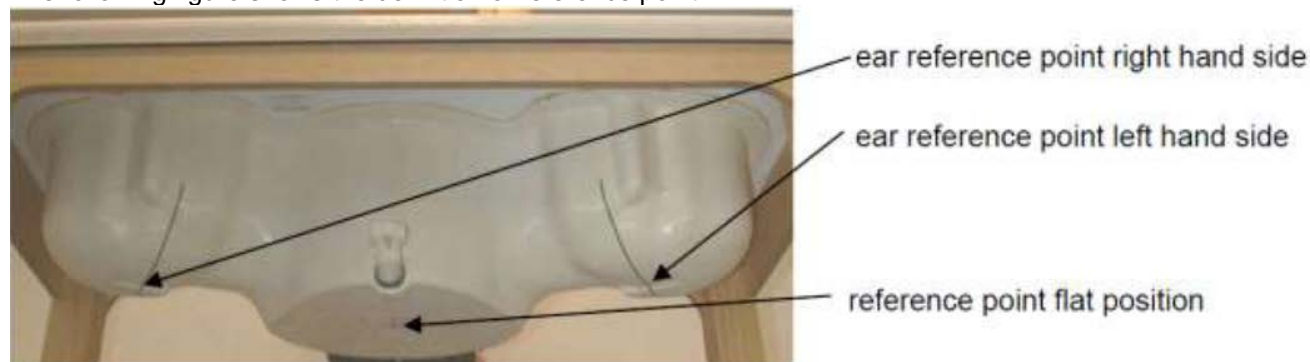

#### ELI4 Phantom

Phantom for compliance testing of handheld and body-mounted wireless devices in the frequency range of 30 MHz to 6 GHz. ELI is fully compatible with the IEC 62209-2 standard and all known tissue simulating liquids. ELI has been optimized regarding its performance and can be integrated into our standard phantom tables. A cover prevents evaporation of the liquid. Reference markings on the phantom allow installation of the complete setup, including all predefined phantom positions and measurement grids, by teaching three points. The phantom is compatible with all SPEAG dosimetric probes and dipoles.

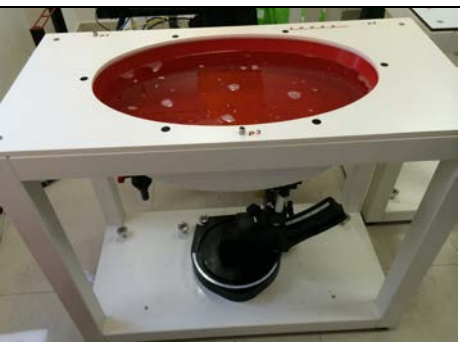
Shell Thickness	2mm +/- 0.2 mm	
Filling Volume	Approximately 30 liters	
Dimensions	Major axis:600mm; Minor axis:400mm;	
Measurement Areas	Flat phantom	

The ELI4 phantom is intended for compliance testing of handheld and body-mounted wireless devices in the frequency range of 30MHz to 6GHz. ELI4 is fully compatible with the latest draft of the standard IEC 62209-2 and all known tissue simulating liquids.

The phantom shell material is resistant to all ingredients used in the tissue-equivalent liquid recipes. The shell of the phantom including ear spacers is constructed from low permittivity and low loss material, with a relative permittivity  $\leq 5$  and a loss tangent  $\leq 0.05$ .

#### 4.4. Device Holder

The device was placed in the device holder (illustrated below) that is supplied by SPEAG as an integral part of the DASY system.

The DASY device holder is designed to cope with the different positions given in the standard. It has two scales for device rotation (with respect to the body axis) and device inclination (with respect to the line between the ear reference points). The rotation centers for both scales is the ear reference point (ERP). Thus the device needs no repositioning when changing the angles.

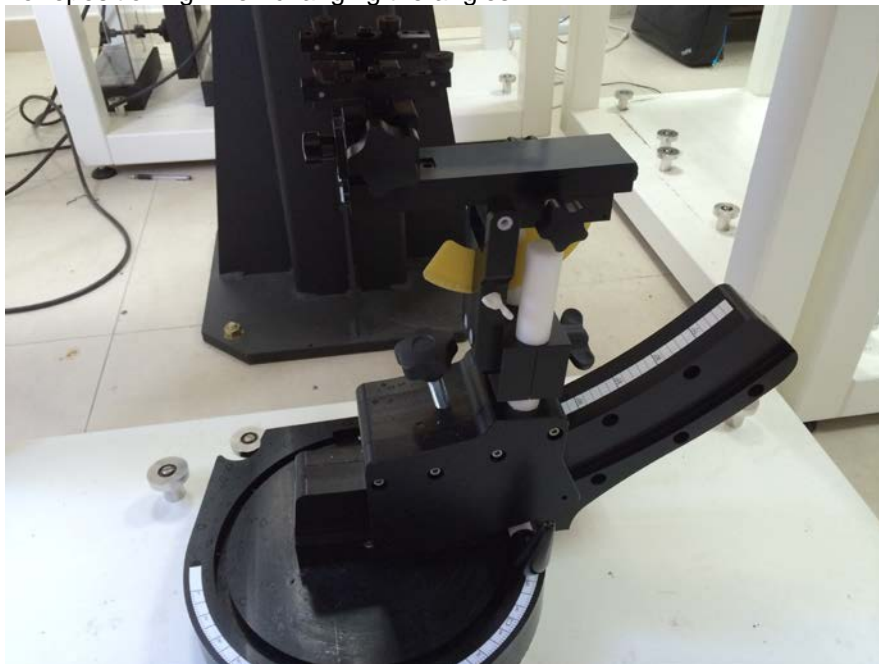

Device holder supplied by SPEAG

#### 4.5. Scanning Procedure

The DASY5 installation includes predefined files with recommended procedures for measurements and validation. They are read-only document files and destined as fully defined but unmeasured masks. All test positions (head or body-worn) are tested with the same configuration of test steps differing only in the grid definition for the different test positions.

The “reference” and “drift” measurements are located at the beginning and end of the batch process. They measure the field drift at one single point in the liquid over the complete procedure. The indicated drift is mainly the variation of the DUT’s output power and should vary max.  $\pm 5\%$ .

The “surface check” measurement tests the optical surface detection system of the DASY5 system by repeatedly detecting the surface with the optical and mechanical surface detector and comparing the results. The output gives the detecting heights of both systems, the difference between the two systems and the standard deviation of the detection repeatability. Air bubbles or refraction in the liquid due to separation of the sugar-water mixture gives poor repeatability (above  $\pm 0.1\text{mm}$ ). To prevent wrong results tests are only executed when the liquid is free of air bubbles. The difference between the optical surface detection and the actual surface depends on the probe and is specified with each probe (It does not depend on the surface reflectivity or the probe angle to the surface within  $\pm 30^\circ$ .)

##### Area Scan

The Area Scan is used as a fast scan in two dimensions to find the area of high field values before running a detailed measurement around the hot spot. Before starting the area scan a grid spacing of 15 mm x 15 mm is set. During the scan the distance of the probe to the phantom remains unchanged. After finishing area scan, the field maxima within a range of 2 dB will be ascertained.

##### Zoom Scan

Zoom Scans are used to estimate the peak spatial SAR values within a cubic averaging volume containing 1 g and 10 g of simulated tissue. The default Zoom Scan is done by 7x7x7 points within a cube whose base is centered around the maxima found in the preceding area scan.

##### Spatial Peak Detection

The procedure for spatial peak SAR evaluation has been implemented and can determine values of masses of 1g and 10g, as well as for user-specific masses. The DASY5 system allows evaluations that combine measured data and robot positions, such as: • maximum search • extrapolation • boundary correction • peak search for averaged SAR. During a maximum search, global and local maxima searches are automatically

performed in 2-D after each Area Scan measurement with at least 6 measurement points. It is based on the evaluation of the local SAR gradient calculated by the Quadratic Shepard's method. The algorithm will find the global maximum and all local maxima within -2 dB of the global maxima for all SAR distributions.

Extrapolation routines are used to obtain SAR values between the lowest measurement points and the inner phantom surface. The extrapolation distance is determined by the surface detection distance and the probe sensor offset. Several measurements at different distances are necessary for the extrapolation. Extrapolation routines require at least 10 measurement points in 3-D space. They are used in the Zoom Scan to obtain SAR values between the lowest measurement points and the inner phantom surface. The routine uses the modified Quadratic Shepard's method for extrapolation. For a grid using 7x7x7 measurement points with 5mm resolution amounting to 343 measurement points, the uncertainty of the extrapolation routines is less than 1% for 1g and 10g cubes.

A Z-axis scan measures the total SAR value at the x-and y-position of the maximum SAR value found during the cube 7x7x7 scan. The probe is moved away in z-direction from the bottom of the SAM phantom in 5mm steps.

The following table summarizes the area scan and zoom scan resolutions:

		≤ 3 GHz	> 3 GHz	
Maximum distance from closest measurement point (geometric center of probe sensors) to phantom surface		5 mm ± 1 mm	$\frac{1}{2} \cdot \delta \cdot \ln(2)$ mm ± □ 0.5 mm	
Maximum probe angle from probe axis to phantom surface normal at the measurement location		30° ± 1°	20° ± 1°	
Maximum area scan spatial resolution: $\Delta x_{Area}, \Delta y_{Area}$		≤ 2 GHz: ≤ 15 mm 2 – 3 GHz: ≤ 12 mm	3 – 4 GHz: ≤ 12 mm 4 – 6 GHz: ≤ 10 mm	
		When the x or y dimension of the test device, in the measurement plane orientation, is smaller than the above, the measurement resolution must be ≤ the corresponding x or y dimension of the test device with at least one measurement point on the test device.		
Maximum zoom scan spatial resolution: $\Delta x_{Zoom}, \Delta y_{Zoom}$		≤ 2 GHz: ≤ 8 mm 2 – 3 GHz: ≤ 5 mm*	3 – 4 GHz: ≤ 5 mm* 4 – 6 GHz: ≤ 4 mm*	
Maximum zoom scan spatial resolution, normal to phantom surface	uniform grid: $\Delta z_{Zoom}(n)$	≤ 5 mm	3 – 4 GHz: ≤ 4 mm 4 – 5 GHz: ≤ 3 mm 5 – 6 GHz: ≤ 2 mm	
	graded grid	$\Delta z_{Zoom}(1)$ : between 1 <sup>st</sup> two points closest to phantom surface	≤ 4 mm	3 – 4 GHz: ≤ 3 mm 4 – 5 GHz: ≤ 2.5 mm 5 – 6 GHz: ≤ 2 mm
		$\Delta z_{Zoom}(n>1)$ : between subsequent points	≤ 1.5 · $\Delta z_{Zoom}(n-1)$ mm	
Minimum zoom scan volume	x, y, z	≥ 30 mm	3 – 4 GHz: ≥ 28 mm 4 – 5 GHz: ≥ 25 mm 5 – 6 GHz: ≥ 22 mm	
Note: $\delta$ is the penetration depth of a plane-wave at normal incidence to the tissue medium; see IEEE Std 1528-2013 for details.				
* When zoom scan is required and the reported SAR from the area scan based 1-g SAR estimation procedures of KDB Publication 447498 is ≤ 1.4 W/kg, ≤ 8 mm, ≤ 7 mm and ≤ 5 mm zoom scan resolution may be applied, respectively, for 2 GHz to 3 GHz, 3 GHz to 4 GHz and 4 GHz to 6 GHz.				

## 4.6. Data Storage and Evaluation

### Data Storage

The DASY5 software stores the acquired data from the data acquisition electronics as raw data (in microvolt readings from the probe sensors), together with all necessary software parameters for the data evaluation (probe calibration data, liquid parameters and device frequency and modulation data) in measurement files with the extension “.DA4”. The software evaluates the desired unit and format for output each time the data is visualized or exported. This allows verification of the complete software setup even after the measurement and allows correction of incorrect parameter settings. For example, if a measurement has been performed with a wrong crest factor parameter in the device setup, the parameter can be corrected afterwards and the data can be re-evaluated.

The measured data can be visualized or exported in different units or formats, depending on the selected probe type ([V/m], [A/m], [°C], [mW/g], [mW/cm<sup>2</sup>], [dBrel], etc.). Some of these units are not available in certain

situations or show meaningless results, e.g., a SAR output in a lossless media will always be zero. Raw data can also be exported to perform the evaluation with other software packages.

### Data Evaluation

The SEMCAD software automatically executes the following procedures to calculate the field units from the microvolt readings at the probe connector. The parameters used in the evaluation are stored in the configuration modules of the software:

Probe parameters:	- Sensitivity	Normi, ai0, ai1, ai2
	- Conversion factor	ConvFi
	- Diode compression point	Dcpi
Device parameters:	- Frequency	f
	- Crest factor	cf
Media parameters:	- Conductivity	$\sigma$
	- Density	$\rho$

These parameters must be set correctly in the software. They can be found in the component documents or they can be imported into the software from the configuration files issued for the DASY5 components. In the direct measuring mode of the multimeter option, the parameters of the actual system setup are used. In the scan visualization and export modes, the parameters stored in the corresponding document files are used.

The first step of the evaluation is a linearization of the filtered input signal to account for the compression characteristics of the detector diode. The compensation depends on the input signal, the diode type and the DC-transmission factor from the diode to the evaluation electronics. If the exciting field is pulsed, the crest factor of the signal must be known to correctly compensate for peak power. The formula for each channel can be given as:

$$V_i = U_i + U_i^2 \cdot \frac{cf}{dcp_i}$$

With	$V_i$	= compensated signal of channel i	(i = x, y, z)
	$U_i$	= input signal of channel i	(i = x, y, z)
	cf	= crest factor of exciting field	(DASY parameter)
	dcp <sub>i</sub>	= diode compression point	(DASY parameter)

From the compensated input signals the primary field data for each channel can be evaluated:

$$\text{E - fieldprobes : } E_i = \sqrt{\frac{V_i}{Norm_i \cdot ConvF}}$$

$$\text{H - fieldprobes : } H_i = \sqrt{V_i} \cdot \frac{a_{i0} + a_{i1}f + a_{i2}f^2}{f}$$

With	$V_i$	= compensated signal of channel i	(i = x, y, z)
	Norm <sub>i</sub>	= sensor sensitivity of channel i	(i = x, y, z)
		[mV/(V/m) <sup>2</sup> ] for E-field Probes	
	ConvF	= sensitivity enhancement in solution	
	a <sub>ij</sub>	= sensor sensitivity factors for H-field probes	
	f	= carrier frequency [GHz]	
	$E_i$	= electric field strength of channel i in V/m	
	$H_i$	= magnetic field strength of channel i in A/m	

The RSS value of the field components gives the total field strength (Hermitian magnitude):

$$E_{tot} = \sqrt{E_x^2 + E_y^2 + E_z^2}$$

The primary field data are used to calculate the derived field units.

$$SAR = E_{tot}^2 \cdot \frac{\sigma}{\rho \cdot 1'000}$$

with	SAR	= local specific absorption rate in mW/g
	$E_{tot}$	= total field strength in V/m
	$\sigma$	= conductivity in [mho/m] or [Siemens/m]
	$\rho$	= equivalent tissue density in g/cm <sup>3</sup>

Note that the density is normally set to 1 (or 1.06), to account for actual brain density rather than the density of the simulation liquid.



## 4.7. SAR Measurement System

The SAR measurement system being used is the DASY5 system, the system is controlled remotely from a PC, which contains the software to control the robot and data acquisition equipment. The software also displays the data obtained from test scans.

In operation, the system first does an area (2D) scan at a fixed depth within the liquid from the inside wall of the phantom. When the maximum SAR point has been found, the system will then carry out a 3D scan centred at that point to determine volume averaged SAR level.

### 4.7.1 Tissue Dielectric Parameters for Head and Body Phantoms

The liquid is consisted of water,salt,Glycol,Sugar,Preventol and Cellulose and DGBE.The liquid has previously been proven to be suited for worst-case. It's satisfying the latest tissue dielectric parameters requirements proposed by the KDB865664.

Target Frequency (MHz)	Head		Body	
	$\epsilon_r$	$\sigma$ (S/m)	$\epsilon_r$	$\sigma$ (S/m)
150	52.3	0.76	61.9	0.80
300	45.3	0.87	58.2	0.92
450	43.5	0.87	56.7	0.94
835	41.5	0.90	55.2	0.97
900	41.5	0.97	55.0	1.05
915	41.5	0.98	55.0	1.06
1450	40.5	1.20	54.0	1.30
1610	40.3	1.29	53.8	1.40
1800-2000	40.0	1.40	53.3	1.52
2450	39.2	1.80	52.7	1.95
3000	38.5	2.40	52.0	2.73
5800	35.3	5.27	48.2	6.00

( $\epsilon_r$  = relative permittivity,  $\sigma$  = conductivity and  $\rho = 1000 \text{ kg/m}^3$ )

## 4.8. Dielectric Performance

Dielectric performance of Head and Body tissue simulating liquid.

Ingredient (% Weight)	750MHz		835MHz		1900MHz		1750 MHz		2450MHz		2600MHz	
	Head	Body	Head	Body	Head	Body	Head	Body	Head	Body	Head	Body
Water	39.2	50.3	41.45	52.5	55.242	69.91	55.782	69.82	62.7	73.2	62.3	72.6
Salt	2.70	1.6	1.45	1.40	0.306	0.13	0.401	0.12	0.50	0.10	0.20	0.10
Sugar	57.0	47.0	56	45.0	0.00	0.00	0.00	0.00	0.00	0.00	0.00	0.00
Preventol	0.0	0.0	0.10	0.10	0.00	0.00	0.00	0.00	0.00	0.00	0.00	0.00
HEC	0.0	0.0	1.00	1.00	0.00	0.00	0.00	0.00	0.00	0.00	0.00	0.00
DGBE	0.0	0.0	0.00	0.00	44.452	29.96	43.817	30.06	36.8	26.7	37.5	27.3

HSL5GHz is composed of the following ingredients:

Water: 50-65%

Mineral oil: 10-30%

Emulsifiers: 8-25%

Sodium salt: 0-1.5%

MSL5GHz is composed of the following ingredients:

Water: 64-78%

Mineral oil: 11-18%

Emulsifiers: 9-15%

Sodium salt: 2-3%

Measurement for Tissue Simulate Liquid							
Tissue Type	Measured Frequency (MHz)	Target Tissue ( $\pm 5\%$ )		Measured Tissue		Liquid Temp. ( $^{\circ}\text{C}$ )	Measured Date
		$\epsilon_r$	$\sigma(\text{S/m})$	$\epsilon_r$	$\sigma(\text{S/m})$		
835 Head	835	41.5 (39.43~43.58)	0.9 (0.86~0.95)	40.953	0.926	22.1	4/20/2018
835 Body	835	55.2 (52.44~57.96)	0.97 (0.92~1.02)	55.669	1.004	22.1	4/21/2018
1900 Head	1900	40 (38.00~42.00)	1.4 (1.33~1.47)	40.578	1.437	22.3	4/24/2018
1900 Body	1900	53.3 (50.64~55.97)	1.52 (1.44~1.60)	52.205	1.523	22.3	4/25/2018
2450 Head	2450	39.20 (37.24~41.15)	1.80 (1.71~1.88)	38.561	1.781	22	4/26/2018
2450 Body	2450	52.70 (50.07~55.34)	1.95 (1.85~2.05)	51.68	1.951	22	4/27/2018
5250 Head	5250	35.9 (34.11~37.70)	4.71 (4.47~4.95)	36.011	4.721	22.2	4/28/2018
5250 Body	5250	48.9 (46.46~51.35)	5.36 (5.09~5.63)	48.122	5.426	22.2	5/2/2018
5750 Head	5750	35.4 (33.63~37.17)	5.22 (4.96~5.48)	34.695	5.279	22.2	5/2/2018
5750 Body	5750	48.3 (45.89~50.72)	5.94 (5.64~6.24)	46.85	6.017	22.2	5/3/2018

### 4.9. System Check

The purpose of the system check is to verify that the system operates within its specifications at the device test frequency. The system check is simple check of repeatability to make sure that the system works correctly at the time of the compliance test;

System check results have to be equal or near the values determined during dipole calibration with the relevant liquids and test system ( $\pm 10\%$ ).

System check is performed regularly on all frequency bands where tests are performed with the DASY5 system. The output power on dipole port must be calibrated to 24 dBm (250mW) for below 5GHz and 20 dBm (100mW) for above 5GHz before dipole is connected.

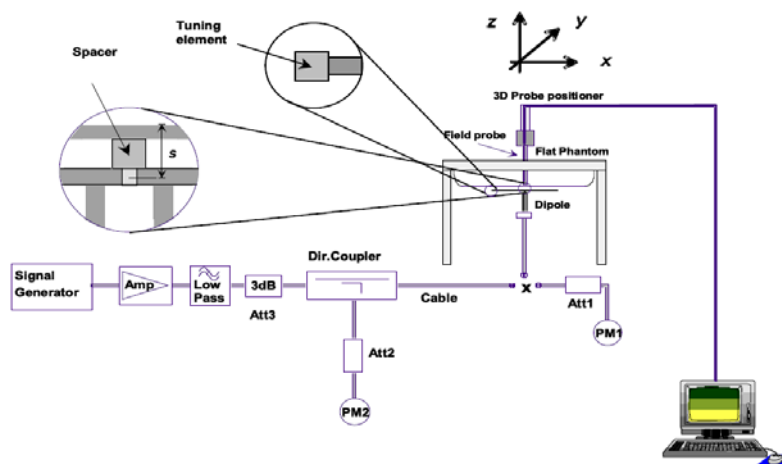

Validation Kit		Measured SAR 250mW	Measured SAR (normalized to 1w)	Target SAR (normalized to 1w) ( $\pm 10\%$ )	Liquid Temp. ( $^{\circ}\text{C}$ )	Measured Date
		1g (W/kg)	1g (W/kg)	1-g(W/kg)		
D835V2	Head	2.3	9.2	9.44 (8.496~10.384)	22.1	4/20/2018
	Body	2.32	9.28	9.64 (8.676~10.604)	22.1	4/21/2018
D1900V2	Head	10	40	39.3 (35.37~43.23)	22.3	4/24/2018
	Body	11.1	44.4	40.5 (36.45~44.55)	22.3	4/25/2018
D2450V2	Head	13.3	53.2	52.4 (47.16~57.64)	22	4/26/2018
	Body	11.6	46.4	51.3 (46.17~56.43)	22	4/27/2018
Validation Kit		Measured SAR 100mW	Measured SAR (normalized to 1w)	Target SAR (normalized to 1w) ( $\pm 10\%$ )	Liquid Temp. ( $^{\circ}\text{C}$ )	Measured Date
		1g (W/kg)	1g (W/kg)	1-g(W/kg)		
D5GHzV2	Head(5.25GHz)	7.1	71	76.6 (68.94~84.26)	22.2	4/28/2018
	Body(5.25GHz)	7.16	71.6	75.6 (68.04~83.16)	22.2	5/2/2018
	Head(5.75GHz)	7.74	77.4	80 (72~88)	22.2	5/2/2018
	Body(5.75GHz)	7.74	77.4	74.8 (67.32~82.28)	22.2	5/3/2018

#### 4.10. Measurement Procedures

##### Tests to be performed

In order to determine the highest value of the peak spatial-average SAR of a handset, all device positions, configurations and operational modes shall be tested for each frequency band according to steps 1 to 3 below. A flowchart of the test process is shown in Picture 11

Step 1: The tests described in 11.2 shall be performed at the channel that is closest to the centre of the transmit frequency band ( $f_c$ ) for:

- all device positions (cheek and tilt, for both left and right sides of the SAM phantom, as described in Chapter 8),
- all configurations for each device position in a), e.g., antenna extended and retracted, and
- all operational modes, e.g., analogue and digital, for each device position in a) and configuration in b) in each frequency band.
- If more than three frequencies need to be tested according to 11.1 (i.e.,  $N_c > 3$ ), then all frequencies, configurations and modes shall be tested for all of the above test conditions.

Step 2: For the condition providing highest peak spatial-average SAR determined in Step 1, perform all tests described in 11.2 at all other test frequencies, i.e., lowest and highest frequencies. In addition, for all other conditions (device position, configuration and operational mode) where the peak spatial-average SAR value determined in Step 1 is within 3 dB of the applicable SAR limit, it is recommended that all other test frequencies shall be tested as well.

Step 3: Examine all data to determine the highest value of the peak spatial-average SAR found in Steps 1 to 2.

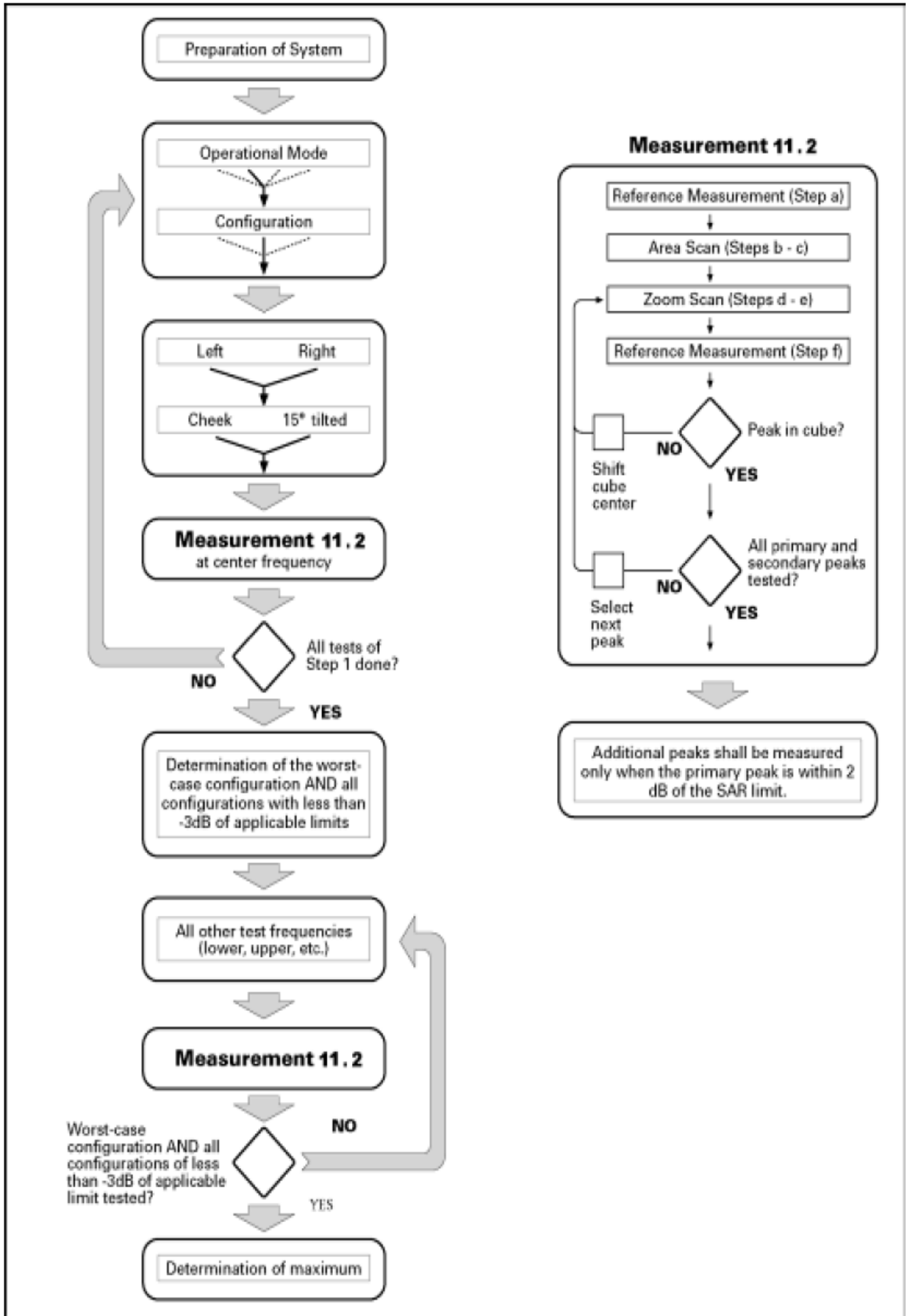

Picture 11 Block diagram of the tests to be performed

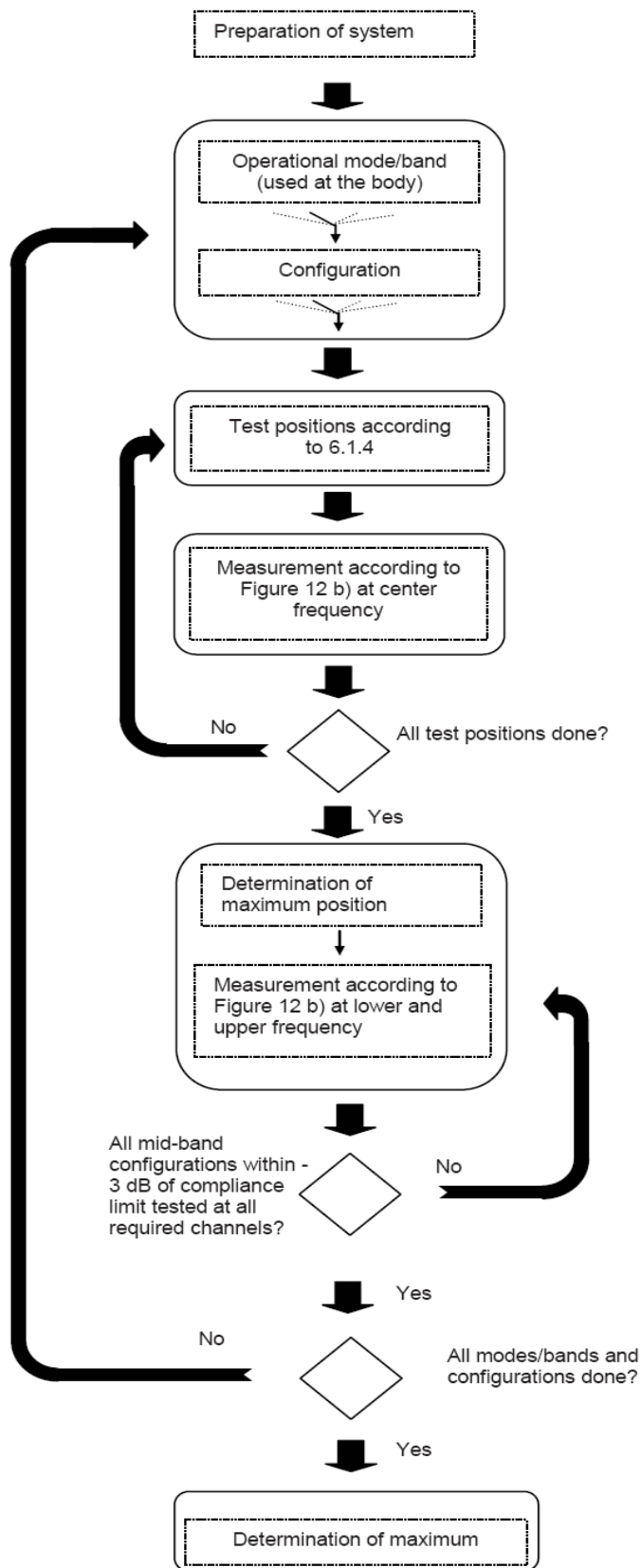

Figure 12a – Tests to be performed

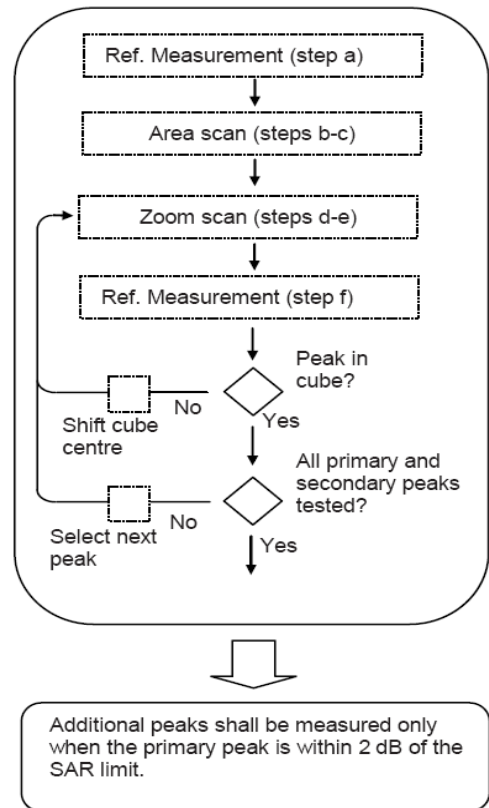

Figure 12b – General procedure

Picture 12 Block diagram of the tests to be performed

**Measurement procedure**

The following procedure shall be performed for each of the test conditions (see Picture 11) described in 11.1:

- a) Measure the local SAR at a test point within 8 mm or less in the normal direction from the inner surface of the phantom.
- b) Measure the two-dimensional SAR distribution within the phantom (area scan procedure). The boundary of the measurement area shall not be closer than 20 mm from the phantom side walls. The distance between the measurement points should enable the detection of the location of local maximum with an

- accuracy of better than half the linear dimension of the tissue cube after interpolation. A maximum grip spacing of 20 mm for frequencies below 3 GHz and  $(60/f \text{ [GHz]})$  mm for frequencies of 3GHz and greater is recommended. The maximum distance between the geometrical centre of the probe detectors and the inner surface of the phantom shall be 5 mm for frequencies below 3 GHz and  $\delta \ln(2)/2$  mm for frequencies of 3 GHz and greater, where  $\delta$  is the plane wave skin depth and  $\ln(x)$  is the natural logarithm. The maximum variation of the sensor-phantom surface shall be  $\pm 1$  mm for frequencies below 3 GHz and  $\pm 0.5$  mm for frequencies of 3 GHz and greater. At all measurement points the angle of the probe with respect to the line normal to the surface should be less than  $5^\circ$ . If this cannot be achieved for a measurement distance to the phantom inner surface shorter than the probe diameter, additional measurement distance to the phantom inner surface shorter than the probe diameter, additional
- c) From the scanned SAR distribution, identify the position of the maximum SAR value, in addition identify the positions of any local maxima with SAR values within 2 dB of the maximum value that are not within the zoom-scan volume; additional peaks shall be measured only when the primary peak is within 2 dB of the SAR limit. This is consistent with the 2 dB threshold already stated;
  - d) Measure the three-dimensional SAR distribution at the local maxima locations identified in step
  - e) The horizontal grid step shall be  $(24 / f[\text{GHz}])$  mm or less but not more than 8 mm. The minimum zoom size of 30 mm by 30 mm and 30 mm for frequencies below 3 GHz. For higher frequencies, the minimum zoom size of 22 mm by 22 mm and 22 mm. The grip step in the vertical direction shall be  $(8-f[\text{GHz}])$  mm or less but not more than 5 mm, if uniform spacing is used. If variable spacing is used in the vertical direction, the maximum spacing between the two closest measured points to the phantom shell shall be  $(12 / f[\text{GHz}])$  mm or less but not more than 4 mm, and the spacing between father points shall increase by an incremental factor not exceeding 1.5. When variable spacing is used, extrapolation routines shall be tested with the same spacing as used in measurements. The maximum distance between the geometrical centre of the probe detectors and the inner surface of the phantom shall be 5 mm for frequencies below 3 GHz and  $\delta \ln(2)/2$  mm for frequencies of 3 GHz and greater, where  $\delta$  is the plane wave skin depth and  $\ln(x)$  is the natural logarithm. Separate grids shall be centered on each of the local SAR maxima found in step c). Uncertainties due to field distortion between the media boundary and the dielectric enclosure of the probe should also be minimized, which is achieved is the distance between the phantom surface and physical tip of the probe is larger than probe tip diameter. Other methods may utilize correction procedures for these boundary effects that enable high precision measurements closer than half the probe diameter. For all measurement points, the angle of the probe with respect to the flat phantom surface shall be less than  $5^\circ$ . If this cannot be achieved an additional uncertainty evaluation is needed.
  - f) Use post processing( e.g. interpolation and extrapolation ) procedures to determine the local SAR values at the spatial resolution needed for mass averaging.

### Measurement procedure

The following procedure shall be performed for each of the test conditions (see Picture 11) described in 11.1:

- g) Measure the local SAR at a test point within 8 mm or less in the normal direction from the inner surface of the phantom.
- h) Measure the two-dimensional SAR distribution within the phantom (area scan procedure). The boundary of the measurement area shall not be closer than 20 mm from the phantom side walls. The distance between the measurement points should enable the detection of the location of local maximum with an accuracy of better than half the linear dimension of the tissue cube after interpolation. A maximum grip spacing of 20 mm for frequencies below 3 GHz and  $(60/f \text{ [GHz]})$  mm for frequencies of 3GHz and greater is recommended. The maximum distance between the geometrical centre of the probe detectors and the inner surface of the phantom shall be 5 mm for frequencies below 3 GHz and  $\delta \ln(2)/2$  mm for frequencies of 3 GHz and greater, where  $\delta$  is the plane wave skin depth and  $\ln(x)$  is the natural logarithm. The maximum variation of the sensor-phantom surface shall be  $\pm 1$  mm for frequencies below 3 GHz and  $\pm 0.5$  mm for frequencies of 3 GHz and greater. At all measurement points the angle of the probe with respect to the line normal to the surface should be less than  $5^\circ$ . If this cannot be achieved for a measurement distance to the phantom inner surface shorter than the probe diameter, additional measurement distance to the phantom inner surface shorter than the probe diameter, additional
- i) From the scanned SAR distribution, identify the position of the maximum SAR value, in addition identify the positions of any local maxima with SAR values within 2 dB of the maximum value that are not within the zoom-scan volume; additional peaks shall be measured only when the primary peak is within 2 dB of the SAR limit. This is consistent with the 2 dB threshold already stated;
- j) Measure the three-dimensional SAR distribution at the local maxima locations identified in step
- k) The horizontal grid step shall be  $(24 / f[\text{GHz}])$  mm or less but not more than 8 mm. The minimum zoom size of 30 mm by 30 mm and 30 mm for frequencies below 3 GHz. For higher frequencies, the minimum zoom size of 22 mm by 22 mm and 22 mm. The grip step in the vertical direction shall be  $(8-f[\text{GHz}])$  mm or less but not more than 5 mm, if uniform spacing is used. If variable spacing is used in the vertical direction, the maximum spacing between the two closest measured points to the phantom shell shall be  $(12 / f[\text{GHz}])$  mm or less but not more than 4 mm, and the spacing between father points shall increase by an incremental factor not exceeding 1.5. When variable spacing is used, extrapolation routines shall be tested with the same spacing as used in measurements. The maximum distance between the geometrical

centre of the probe detectors and the inner surface of the phantom shall be 5 mm for frequencies below 3 GHz and  $\delta \ln(2)/2$  mm for frequencies of 3 GHz and greater, where  $\delta$  is the plane wave skin depth and  $\ln(x)$  is the natural logarithm. Separate grids shall be centered on each of the local SAR maxima found in step c). Uncertainties due to field distortion between the media boundary and the dielectric enclosure of the probe should also be minimized, which is achieved is the distance between the phantom surface and physical tip of the probe is larger than probe tip diameter. Other methods may utilize correction procedures for these boundary effects that enable high precision measurements closer than half the probe diameter. For all measurement points, the angle of the probe with respect to the flat phantom surface shall be less than 5. If this cannot be achieved an additional uncertainty evaluation is needed.

- l) Use post processing( e.g. interpolation and extrapolation ) procedures to determine the local SAR values at the spatial resolution needed for mass averaging.

## 4.11. Operational Conditions during Test

### 4.11.1. General Description of Test Procedures

The sample enter into maximal duty cycle continuous transmit controlled by engineer mode provided by application.

For WWAN power measurement, use base station simulator connection with RF cable, at maximum power in each supported wireless interface and frequency band.

Read the WWAN RF power level from the base station simulator.

Connect EUT RF port through RF cable to the power meter, and measure WLAN/BT output power.

## 4.12. Position of the wireless device in relation to the phantom

### 4.12.2 Body Configuration

The overall diagonal dimension of the display section of a tablet is > 20 cm, Per FCC KDB 616217 Tablet host platform test requirements, the back surface and edges of the tablet should be tested for SAR compliance with the tablet touching the phantom. Exposures from antennas through the front (top) surface of the display section of a full-size tablet, away from the edges, are generally limited to the user's hands. Exposures to hands for typical consumer transmitters used in tablets are not expected to exceed the extremity SAR limit; therefore, SAR evaluation for the front surface of tablet display screens are generally not necessary, except for tablets that are designed to require continuous operations with the hand(s) next to the antenna(s).

Per KDB 648474 SAR Evaluation Considerations for Wireless Handsets, when the over diagonal dimension of the device is > 20.0 cm. Hotspot mode SAR is not required when normal tablet procedures are applied.

Extremity 10-g SAR is also not required for the front (top) surface of large form factor full size tablets. The more conservative tablet SAR results can be used to supported the 10-g extremity SAR for phablet mode.

### 4.12.3 SAM Phantom Limitations Configuration

The antennas of recent generation phones are typically incorporated near the sides and along edges of the phone. Occasionally, a phone with antennas located near the bottom or lower side edges may have peak SAR locations near the mouth and jaw regions or along the steep curved surfaces of the SAM phantom where SAR probe access is not feasible with a horizontally configured SAM phantom. It has been known for some time that there are also other SAR measurement difficulties in the tight regions of the SAM phantom with no easy solution. SAR probes are calibrated in tissue-equivalent medium with sufficient separation between the probe sensors and nearby physical boundaries to ensure field scattering does not affect the probe calibration. When the probe tip is positioned in tight areas, such as in the mouth and jaw regions of the SAM phantom, with multiple boundaries surrounding the probe sensors, the probe calibration and measurement accuracy can become questionable. In addition, measurements near these locations with steep curvatures may require a probe to be tilted at steep angles that may no longer comply with the required calibration requirements and measurement protocols for maintaining measurement accuracy and uncertainty. For some situations, it is just not feasible to tilt the probe without using a rotated SAM phantom that are specifically constructed to enable probe access below the cheek and near the jaw area.<sup>11</sup> When a rotated SAM phantom is not used, the measured SAR distribution is often clipped and showing only part of the SAR distribution under consideration.

## 4.13. Test Configuration

### 4.13.1 GSM Test Configuration

SAR tests for GSM 850 and GSM 1900, a communication link is set up with a System Simulator (SS) by air link. Using CMU200 the power level is set to “5” for GSM 850, set to “0” for GSM 1900. Since the GPRS class is 12 for this EUT, it has at most 4 timeslots in uplink and at most 4 timeslots in downlink, the maximum total timeslots is 5. the EGPRS class is 12 for this EUT, it has at most 4 timeslots in uplink and at most 4 timeslots in downlink, the maximum total timeslots is 5.

SAR test reduction for GPRS and EDGE modes is determined by the source-based time-averaged output power specified for production units, including tune-up tolerance. The data mode with highest specified time-averaged output power should be tested for SAR compliance in the applicable exposure conditions. For modes with the same specified maximum output power and tolerance, the higher number time-slot configuration should be tested. GSM voice and GPRS data use GMSK, which is a constant amplitude modulation with minimal peak to average power difference within the time-slot burst. For EDGE, GMSK is used for MCS 1 – MCS 4 and 8-PSK is used for MCS 5 – MCS 9; where 8-PSK has an inherently higher peak-to-average power ratio. The GMSK and 8-PSK EDGE configurations are considered separately for SAR compliance. The GMSK EDGE configurations are grouped with GPRS and considered with respect to time-averaged maximum output power to determine compliance. The 3G SAR test reduction procedure is applied to 8-PSK EDGE with GMSK GPRS/EDGE as the primary mode.

According to specification 3GPP TS 51.010, the maximum power of the GSM can do the power reduction for the multi-slot. The allowed power reduction in the multi-slot configuration is as following: Output power of reductions:

The allowed power reduction in the multi-slot configuration

Number of timeslots in uplink assignment	Permissible nominal reduction of maximum output power,(dB)
1	0
2	0 to 3.0
3	1.8 to 4.8
4	3.0 to 6.0

### 4.13.2. UMTS Test Configuration

#### 4.13.2.1. Output power Verification

Maximum output power is verified on the High, Middle and Low channel according to the procedures described in section 5.2 of 3GPP TS 34. 121, using the appropriate RMC or AMR with TPC(transmit power control) set to all up bits for WCDMA/HSDPA or applying the required inner loop power control procedures to the maximum output power while HSUPA is active. Results for all applicable physical channel configuration (DPCCCH, DPDCH<sub>n</sub> and spreading codes, HSDPA, HSPA) should be tabulated in the SAR report. All configuration that are not supported by the DUT or can not be measured due to technical or equipment limitations should be clearly identified.

#### 4.13.2.2. Body SAR Measurements

SAR for body exposure configurations in voice and data modes is measured using 12.2kbps RMC with TPC bits configured to all up bits. SAR for other spreading codes and multiple DPDCH<sub>n</sub>, when supported by the DUT, are not required when the maximum average output of each RF channel, for each spreading code and DPDCH<sub>n</sub> configuration, are less than 1/4 dB higher than those measured in 12.2kbps RMC. Otherwise, SAR is measured on the maximum output channel with an applicable RMC configuration for the corresponding spreading code or DPDCH<sub>n</sub> using the exposure configuration that results in the highest SAR with 12.2 kbps RMC. When more than 2 DPDCH<sub>n</sub> are supported by the DUT, it may be necessary to configure additional DPDCH<sub>n</sub> for a DUT using FTM (Factory Test Mode) or other chipset based test approaches with parameters similar to those used in 384 kbps and 768 kbps RMC.

#### 4.13.2.3 Handsets with Release 5 HSDPA

The 3G SAR test reduction procedure is applied to HSDPA body-worn accessory configurations with 12.2 kbps RMC as the primary mode. Otherwise, SAR is measured for HSDPA using the HSDPA body SAR procedures in the “Release 5 HSDPA Data Devices” section of this document, for the highest reported SAR body-worn accessory exposure configuration in 12.2 kbps RMC. Handsets with both HSDPA and HSUPA are tested according to Release 6 HSPA test procedures.



HSDPA should be configured according to the UE category of a test device. The number of HSDSCH/ HS-PDSCHs, HARQ processes, minimum inter-TTI interval, transport block sizes and RV coding sequence are defined by the H-set. To maintain a consistent test configuration and stable transmission conditions, QPSK is used in the H-set for SAR testing. HS-DPCCH should be configured with a CQI feedback cycle of 4 ms with a CQI repetition factor of 2 to maintain a constant rate of active CQI slots. DPCCH and DPDCH gain factors ( $\beta_c$ ,  $\beta_d$ ), and HS-DPCCH power offset parameters ( $\Delta_{ACK}$ ,  $\Delta_{NACK}$ ,  $\Delta_{CQI}$ ) should be set according to values indicated in the Table below. The CQI value is determined by the UE category, transport block size, number of HS-PDSCHs and modulation used in the H-set.

**Table 2: Subtests for UMTS Release 5 HSDPA**

Sub-set	$\beta_c$	$\beta_d$	$\beta_d$ (SF)	$\beta_c/\beta_d$	$\beta_{hs}$ (note 1, note 2)	CM(dB) (note 3)	MPR(dB)
1	2/15	15/15	64	2/15	4/15	0.0	0.0
2	12/15 (note 4)	15/15 (note 4)	64	12/15 (note 4)	24/15	1.0	0.0
3	15/15	8/15	64	15/8	30/15	1.5	0.5
4	15/15	4/15	64	15/4	30/15	1.5	0.5

Note1:  $\Delta_{ACK}$ ,  $\Delta_{NACK}$  and  $\Delta_{CQI} = 8 \Leftrightarrow A_{hs} = \beta_{hs}/\beta_c = 30/15 \Leftrightarrow \beta_{hs} = 30/15 * \beta_c$   
 Note2: CM=1 for  $\beta_c/\beta_d = 12/15$ ,  $\beta_{hs}/\beta_c = 24/15$ .  
 Note3: For subtest 2 the  $\beta_c/\beta_d$  ratio of 12/15 for the TFC during the measurement period (TF1, TF0) is achieved by setting the signaled gain factors for the reference TFC (TFC1, TF1) to  $\beta_c = 11/15$  and  $\beta_d = 15/15$ .

**4.13.2.4 HSUPA Test Configuration**

The 3G SAR test reduction procedure is applied to HSPA (HSUPA/HSDPA with RMC) body-worn accessory configurations with 12.2 kbps RMC as the primary mode. Otherwise, SAR is measured for HSPA using the HSPA body SAR procedures in the "Release 6 HSPA Data Devices" section of this document, for the highest reported body-worn accessory exposure SAR configuration in 12.2 kbps RMC. When VOIP is applicable for next to the ear head exposure in HSPA, the 3G SAR test reduction procedure is applied to HSPA with 12.2 kbps RMC as the primary mode; otherwise, the same HSPA configuration used for body-worn accessory measurements is tested for next to the ear head exposure.

Due to inner loop power control requirements in HSPA, a communication test set is required for output power and SAR tests. The 12.2 kbps RMC, FRC H-set 1 and E-DCH configurations for HSPA are configured according to the  $\beta$  values indicated in Table 2 and other applicable procedures described in the 'WCDMA Handset' and 'Release 5 HSDPA Data Devices' sections of this document

**Table 3: Sub-Test 5 Setup for Release 6 HSUPA**

Sub-set	$\beta_c$	$\beta_d$	$\beta_d$ (SF)	$\beta_c/\beta_d$	$\beta_{hs}^{(1)}$	$\beta_{ec}$	$\beta_{ed}$	$\beta_{ed}$ (SF)	$\beta_{ed}$ (codes)	CM <sup>(2)</sup> (dB)	MPR (dB)	AG <sup>(4)</sup> Index	E-TFCI
1	11/15 <sup>(3)</sup>	15/15 <sup>(3)</sup>	64	11/15 <sup>(3)</sup>	22/15	209/225	1039/225	4	1	1.0	0.0	20	75
2	6/15	15/15	64	6/15	12/15	12/15	94/75	4	1	3.0	2.0	12	67
3	15/15	9/15	64	15/9	30/15	30/15	$\beta_{ed1}: 47/15$ $\beta_{ed2}: 47/15$	4	2	2.0	1.0	15	92
4	2/15	15/15	64	2/15	4/15	2/15	56/75	4	1	3.0	2.0	17	71
5	15/15 <sup>(4)</sup>	15/15 <sup>(4)</sup>	64	15/15 <sup>(4)</sup>	30/15	24/15	134/15	4	1	1.0	0.0	21	81

Note 1:  $\Delta_{ACK}$ ,  $\Delta_{NACK}$  and  $\Delta_{CQI} = 8 \Leftrightarrow A_{hs} = \beta_{hs}/\beta_c = 30/15 \Leftrightarrow \beta_{hs} = 30/15 * \beta_c$ .  
 Note 2: CM = 1 for  $\beta_c/\beta_d = 12/15$ ,  $\beta_{hs}/\beta_c = 24/15$ . For all other combinations of DPDCH, DPCCH, HS-DPCCH, E-DPDCH and E-DPCCH the MPR is based on the relative CM difference.  
 Note 3: For subtest 1 the  $\beta_c/\beta_d$  ratio of 11/15 for the TFC during the measurement period (TF1, TF0) is achieved by setting the signaled gain factors for the reference TFC (TF1, TF1) to  $\beta_c = 10/15$  and  $\beta_d = 15/15$ .  
 Note 4: For subtest 5 the  $\beta_c/\beta_d$  ratio of 15/15 for the TFC during the measurement period (TF1, TF0) is achieved by setting the signaled gain factors for the reference TFC (TF1, TF1) to  $\beta_c = 14/15$  and  $\beta_d = 15/15$ .  
 Note 5: Testing UE using E-DPDCH Physical Layer category 1 Sub-test 3 is not required according to TS 25.306 Figure 5.1g.  
 Note 6:  $\beta_{ed}$  can not be set directly; it is set by Absolute Grant Value.

**Table 4: HSUPA UE category**

UE E-DCH Category	Maximum E-DCH Codes Transmitted	Number of HARQ Processes	E-DCH TTI (ms)	Minimum Spreading Factor	Maximum E-DCH Transport Block Bits	Max Rate (Mbps)
1	1	4	10	4	7110	0.7296
2	2	8	2	4	2798	1.4592
	2	4	10	4	14484	
3	2	4	10	4	14484	1.4592
4	2	8	2	2	5772	2.9185
	2	4	10	2	20000	2.00
5	2	4	10	2	20000	2.00
6 (No DPDCH)	4	8	2	2 SF2 & 2 SF4	11484	5.76
	4	4	10		20000	2.00
7 (No DPDCH)	4	8	2	2 SF2 & 2 SF4	22996	?
	4	4	10		20000	?

NOTE: When 4 codes are transmitted in parallel, two codes shall be transmitted with SF2 and two with SF4. UE Categories 1 to 6 supports QPSK only. UE Category 7 supports QPSK and 16QAM. (TS25.306-7.3.0)

#### 4.13.2.5 HSPA, HSPA+ and DC-HSDPA Test Configuration

measurement is required for HSPA, HSPA+ or DC-HSDPA, a KDB inquiry is required to confirm that the wireless mode configurations in the test setup have remained stable throughout the SAR measurements.<sup>35</sup> Without prior KDB confirmation to determine the SAR results are acceptable, a PBA is required for TCB approval.

SAR test exclusion for HSPA, HSPA+ and DC-HSDPA is determined according to the following:

- 1) The HSPA procedures are applied to configure 3GPP Rel. 6 HSPA devices in the required sub-test mode(s) to determine SAR test exclusion.
- 2) SAR is required for Rel. 7 HSPA+ when SAR is required for Rel. 6 HSPA; otherwise, the 3G SAR test reduction procedure is applied to (uplink) HSPA+ with 12.2 kbps RMC as the primary mode.<sup>36</sup> Power is measured for HSPA+ that supports uplink 16 QAM according to configurations in Table C.11.1.4 of 3GPP TS 34.121-1 to determine SAR test reduction.
- 3) SAR is required for Rel. 8 DC-HSDPA when SAR is required for Rel. 5 HSDPA; otherwise, the 3G SAR test reduction procedure is applied to DC-HSDPA with 12.2 kbps RMC as the primary mode. Power is measured for DC-HSDPA according to the H-Set 12, FRC configuration in Table C.8.1.12 of 3GPP TS 34.121-1 to determine SAR test reduction. A primary and a secondary serving HS-DSCH Cell are required to perform the power measurement and for the results to be acceptable.
- 4) Regardless of whether a PBA is required, the following information must be verified and included in the SAR report for devices supporting HSPA, HSPA+ or DC-HSDPA: a) The output power measurement results and applicable release version(s) of 3GPP TS 34.121.

i) Power measurement difficulties due to test equipment setup or availability must be resolved between the grantee and its test lab.

b) The power measurement results are in agreement with the individual device implementation and specifications. When Enhanced MPR (E-MPR) applies, the normal MPR targets may be modified according to the Cubic Metric (CM) measured by the device, which must be taken into consideration.

c) The UE category, operating parameters, such as the  $\beta$  and  $\Delta$  values used to configure the device for testing, power setback procedures described in 3GPP TS 34.121 for the power measurements, and HSPA/HSPA+ channel conditions (active and stable) for the entire duration of the measurement according to the required E-TFCI and AG index values.

5) When SAR measurement is required, the test configurations, procedures and power measurement results must be clearly described to confirm that the required test parameters are used, including E-TFCI and AG index stability and output power conditions.

**Table 5: HS-DSCH UE category****Table 5.1a: FDD HS-DSCH physical layer categories**

HS-DSCH category	Maximum number of HS-DSCH codes received	Minimum inter-TTI interval	Maximum number of bits of an HS-DSCH transport block received within an HS-DSCH TTI NOTE 1	Total number of soft channel bits	Supported modulations without MIMO operation or dual cell operation	Supported modulations with MIMO operation and without dual cell operation	Supported modulations with dual cell operation	
Category 1	5	3	7298	19200	QPSK, 16QAM	Not applicable (MIMO not supported)	Not applicable (dual cell operation not supported)	
Category 2	5	3	7298	28800				
Category 3	5	2	7298	28800				
Category 4	5	2	7298	38400				
Category 5	5	1	7298	57600				
Category 6	5	1	7298	67200				
Category 7	10	1	14411	115200				
Category 8	10	1	14411	134400				
Category 9	15	1	20251	172800				
Category 10	15	1	27952	172800				
Category 11	5	2	3630	14400				QPSK
Category 12	5	1	3630	28800				QPSK, 16QAM, 64QAM
Category 13	15	1	35280	259200				
Category 14	15	1	42192	259200				QPSK, 16QAM
Category 15	15	1	23370	345600				
Category 16	15	1	27952	345600	QPSK, 16QAM, 64QAM	-		
Category 17 NOTE 2	15	1	35280	259200			-	QPSK, 16QAM
			23370	345600	-	QPSK, 16QAM		
Category 18 NOTE 3	15	1	42192	259200	QPSK, 16QAM, 64QAM	-		
			27952	345600	-	QPSK, 16QAM		
Category 19	15	1	35280	518400	QPSK, 16QAM, 64QAM			
Category 20	15	1	42192	518400				
Category 21	15	1	23370	345600	-	-	QPSK, 16QAM	
Category 22	15	1	27952	345600				
Category 23	15	1	35280	518400				
Category 24	15	1	42192	518400			QPSK, 16QAM, 64QAM	

#### 4.13.2.6 HSPA, HSPA+ and DC-HSDPA Test Configuration

##### 4.13.2.6.1 Frequency range and channel bandwidth

The frequency range and channel bandwidths (1.4 MHz, 3 MHz, 5 MHz, 10 MHz, 15 MHz, and 20 MHz) used in each LTE band must be listed. When multiple channel bandwidths are available in a frequency band and if the channel selection is unclear, a KDB inquiry may be necessary. If a transmission band is > 100 MHz, the channel selection criteria in 4.1 g) of KDB Publication 447498 D01 must be applied; otherwise, the high, middle, and low (H, M, L) channel should be used.<sup>3</sup> These are referred to in this document as the required test channels. The channel numbers and channel frequencies for each channel bandwidth configuration and frequency band must be clearly identified in the test report.

##### 4.13.3. WLAN Test Configuration

For WiFi SAR testing, WiFi engineering testing software installed on the DUT can provide continuous transmitting RF signal. This RF signal utilized in SAR measurement has almost 100% duty cycle and its crest factor is 1.

The SAR measurement and test reduction procedures are structured according to either the DSSS or OFDM transmission mode configurations used in each standalone frequency band and aggregated band. For devices that operate in exposure configurations that require multiple test positions, additional SAR test reduction may be applied. The maximum output power specified for production units, including tune-up tolerance, are used to determine initial SAR test requirements for the 802.11 transmission modes in a frequency band. SAR is measured using the highest measured maximum output power channel for the initial test configuration. SAR measurement and test reduction for the remaining 802.11 modes and test channels are determined according to measured or specified maximum output power and reported SAR of the initial measurements. The general test reduction and SAR measurement approaches are summarized in the following:

1. The maximum output power specified for production units are determined for all applicable 802.11 transmission modes in each standalone and aggregated frequency band. Maximum output power is measured for the highest maximum output power configuration(s) in each frequency band according to the default power measurement procedures.

2. For OFDM transmission configurations in the 2.4 GHz and 5 GHz bands, an “initial test configuration” is first determined for each standalone and aggregated frequency band according to the maximum output power and tune-up tolerance specified for production units.
  - a. When the same maximum power is specified for multiple transmission modes in a frequency band, the largest channel bandwidth, lowest order modulation, lowest data rate and lowest order 802.11a/g/n/ac mode is used for SAR measurement, on the highest measured output power channel in the initial test configuration, for each frequency band.
  - b. SAR is measured for OFDM configurations using the initial test configuration procedures. Additional frequency band specific SAR test reduction may be considered for individual frequency bands
  - c. Depending on the reported SAR of the highest maximum output power channel tested in the initial test configuration, SAR test reduction may apply to subsequent highest output channels in the initial test configuration to reduce the number of SAR measurements.
3. The Initial test configuration does not apply to DSSS. The 2.4 GHz band SAR test requirements and 802.11b DSSS procedures are used to establish the transmission configurations required for SAR measurement.
4. An “initial test position” is applied to further reduce the number of SAR tests for devices operating in next to the ear, UMPC mini-tablet mode exposure configurations that require multiple test positions .
  - a. SAR is measured for 802.11b according to the 2.4 GHz DSSS procedure using the exposure condition established by the initial test position.
  - b. SAR is measured for 2.4 GHz and 5 GHz OFDM configurations using the initial test configuration. 802.11b/g/n operating modes are tested independently according to the service requirements in each frequency band. 802.11b/g/n modes are tested on the maximum average output channel.
5. The Initial test position does not apply to devices that require a fixed exposure test position. SAR is measured in a fixed exposure test position for these devices in 802.11b according to the 2.4 GHz DSSS procedure or in 2.4 GHz and 5 GHz OFDM configurations using the initial test configuration procedures .
6. The “subsequent test configuration” procedures are applied to determine if additional SAR measurements are required for the remaining OFDM transmission modes that have not been tested in the initial test configuration. SAR test exclusion is determined according to reported SAR in the initial test configuration and maximum output power specified or measured for these other OFDM configurations.

#### SAR Procedures

Separate SAR procedures are applied to DSSS and OFDM configurations in the 2.4 GHz band to simplify DSSS test requirements. For 802.11b DSSS SAR measurements, DSSS SAR procedure applies to fixed exposure test position and initial test position procedure applies to multiple exposure test positions. When SAR measurement is required for an OFDM configuration, the initial test configuration, subsequent test configuration and initial test position procedures are applied. The SAR test exclusion requirements for 802.11g/n OFDM configurations are described in section 5.2.2.

##### 1. 802.11b DSSS SAR Test Requirements

SAR is measured for 2.4 GHz 802.11b DSSS using either a fixed test position or, when applicable, the initial test position procedure. SAR test reduction is determined according to the following:

- a. When the reported SAR of the highest measured maximum output power channel (section 3.1) for the exposure configuration is  $\leq 0.8$  W/kg, no further SAR testing is required for 802.11b DSSS in that exposure configuration.
- b. When the reported SAR is  $> 0.8$  W/kg, SAR is required for that exposure configuration using the next highest measured output power channel. When any reported SAR is  $> 1.2$  W/kg, SAR is required for the third channel; i.e., all channels require testing.

##### 1. 2.4 GHz 802.11g/n OFDM SAR Test Exclusion Requirements

When SAR measurement is required for 2.4 GHz 802.11g/n OFDM configurations, the measurement and test reduction procedures for OFDM are applied (section 5.3). SAR is not required for the following 2.4 GHz OFDM conditions.

- a. When KDB Publication 447498 SAR test exclusion applies to the OFDM configuration
- b. When the highest reported SAR for DSSS is adjusted by the ratio of OFDM to DSSS specified maximum output power and the adjusted SAR is  $\leq 1.2$  W/kg.

##### 2. SAR Test Requirements for OFDM Configurations

When SAR measurement is required for 802.11 a/g/n/ac OFDM configurations, each standalone and frequency aggregated band is considered separately for SAR test reduction. When the same transmitter and antenna(s) are used for U-NII-1 and U-NII-2A bands, additional SAR test reduction applies. When band gap channels between U-NII-2C band and 5.8 GHz U-NII-3 or §15.247 band are supported, the highest maximum output power transmission mode configuration and maximum output power channel across the bands must be used to determine SAR test reduction, according to the initial test configuration and subsequent test configuration requirements.<sup>20</sup> In applying the initial test configuration and subsequent test configuration procedures, the 802.11 transmission configuration with the highest specified maximum output power and the channel within a test configuration with the highest measured maximum output power should be clearly distinguished to apply the procedures.

##### 3. OFDM Transmission Mode SAR Test Configuration and Channel Selection Requirements

The initial test configuration for 2.4 GHz and 5 GHz OFDM transmission modes is determined by the 802.11 configuration with the highest maximum output power specified for production units, including tune-up tolerance, in each standalone and aggregated frequency band. SAR for the initial test configuration is measured using the highest maximum output power channel determined by the default power measurement procedures (section 4). When multiple configurations in a frequency band have the same specified maximum output power, the initial test configuration is determined according to the following steps applied sequentially.

- a. The largest channel bandwidth configuration is selected among the multiple configurations with the same specified maximum output power.
- b. If multiple configurations have the same specified maximum output power and largest channel bandwidth, the lowest order modulation among the largest channel bandwidth configurations is selected.
- c. If multiple configurations have the same specified maximum output power, largest channel bandwidth and lowest order modulation, the lowest data rate configuration among these configurations is selected.
- d. When multiple transmission modes (802.11a/g/n/ac) have the same specified maximum output power, largest channel bandwidth, lowest order modulation and lowest data rate, the lowest order 802.11 mode is selected; i.e., 802.11a is chosen over 802.11n then 802.11ac or 802.11g is chosen over 802.11n. After an initial test configuration is determined, if multiple test channels have the same measured maximum output power, the channel chosen for SAR measurement is determined according to the following. These channel selection procedures apply to both the initial test configuration and subsequent test configuration(s), with respect to the default power measurement procedures or additional power measurements required for further SAR test reduction. The same procedures also apply to subsequent highest output power channel(s) selection.
  - a. When there are multiple test channels with the same measured maximum output power, the channel closest to mid-band frequency is selected for SAR measurement.
  - b. When there are multiple test channels with the same measured maximum output power and equal separation from mid-band frequency; for example, high and low channels or two mid-band channels, the higher frequency (number) channel is selected for SAR measurement.

#### Initial Test Configuration Procedures

An initial test configuration is determined for OFDM transmission modes according to the channel bandwidth, modulation and data rate combination(s) with the highest maximum output power specified for production units in each standalone and aggregated frequency band. SAR is measured using the highest measured maximum output power channel. For configurations with the same specified or measured maximum output power, additional transmission mode and test channel selection procedures are required (see section 5.3.2). SAR test reduction of subsequent highest output test channels is based on the reported SAR of the initial test configuration.

For next to the ear and UMC mini-tablet exposure configurations where multiple test positions are required, the initial test position procedure is applied to minimize the number of test positions required for SAR measurement using the initial test configuration transmission mode. For fixed exposure conditions that do not have multiple SAR test positions, SAR is measured in the transmission mode determined by the initial test configuration. When the reported SAR of the initial test configuration is  $> 0.8$  W/kg, SAR measurement is required for the subsequent next highest measured output power channel(s) in the initial test configuration until the reported SAR is  $\leq 1.2$  W/kg or all required channels are tested.

#### 4. Subsequent Test Configuration Procedures

SAR measurement requirements for the remaining 802.11 transmission mode configurations that have not been tested in the initial test configuration are determined separately for each standalone and aggregated frequency band, in each exposure condition, according to the maximum output power specified for production units. The initial test position procedure is applied to next to the ear, UMPC mini-tablet mode configurations. When the same maximum output power is specified for multiple transmission modes, the procedures in section 5.3.2 are applied to determine the test configuration. Additional power measurements may be required to determine if SAR measurements are required for subsequent highest output power channels in a subsequent test configuration. The subsequent test configuration and SAR measurement procedures are described in the following.

- a. When SAR test exclusion provisions of KDB Publication 447498 are applicable and SAR measurement is not required for the initial test configuration, SAR is also not required for the next highest maximum output power transmission mode subsequent test configuration(s) in that frequency band or aggregated band and exposure configuration.
- b. When the highest reported SAR for the initial test configuration (when applicable, include subsequent highest output channels), according to the initial test position or fixed exposure position requirements, is adjusted by the ratio of the subsequent test configuration to initial test configuration specified maximum output power and the adjusted SAR is  $\leq 1.2$  W/kg, SAR is not required for that subsequent test configuration.
- c. The number of channels in the initial test configuration and subsequent test configuration can be different due to differences in channel bandwidth. When SAR measurement is required for a subsequent test configuration and the channel bandwidth is smaller than that in the initial test configuration, all channels in the subsequent test configuration that overlap with the larger bandwidth channel tested in the initial test

configuration should be used to determine the highest maximum output power channel. This step requires additional power measurement to identify the highest maximum output power channel in the subsequent test configuration to determine SAR test reduction.

- 1). SAR should first be measured for the channel with highest measured output power in the subsequent test configuration.
- 2). SAR for subsequent highest measured maximum output power channels in the subsequent test configuration is required only when the reported SAR of the preceding higher maximum output power channel(s) in the subsequent test configuration is  $> 1.2$  W/kg or until all required channels are tested.
  - a) For channels with the same measured maximum output power, SAR should be measured using the channel closest to the center frequency of the larger channel bandwidth channel in the initial test configuration.
- D. SAR measurements for the remaining highest specified maximum output power OFDM transmission mode configurations that have not been tested in the initial test configuration (highest maximum output) or subsequent test configuration(s) (subsequent next highest maximum output power) is determined by applying the subsequent test configuration procedures in this section to the remaining configurations according to the following:
  - 1) replace "subsequent test configuration" with "next subsequent test configuration" (i.e., subsequent next highest specified maximum output power configuration)
  - 2) replace "initial test configuration" with "all tested higher output power configurations."

#### **4.14. Power Drift**

To control the output power stability during the SAR test, DASY5 system calculates the power drift by measuring the E-field at the same location at the beginning and at the end of the measurement for each test position. These drift values can be found in Table 14.1 to Table 14.11 labeled as: (Power Drift [dB]). This ensures that the power drift during one measurement is within 5%.

#### **4.15. Power Reduction**

The product without any power reduction.

## 5. TEST CONDITIONS AND RESULTS

### 5.1. Conducted Power Results

According KDB 447498 D01 General RF Exposure Guidance v06 Section 4.1 2) states that "Unless it is specified differently in the published RF exposure KDB procedures, these requirements also apply to test reduction and test exclusion considerations. Time-averaged maximum conducted output power applies to SAR and, as required by § 2.1091(c), time-averaged ERP applies to MPE. When an antenna port is not available on the device to support conducted power measurement, such as FRS and certain Part 15 transmitters with built-in integral antennas, the maximum output power allowed for production units should be used to determine RF exposure test exclusion and compliance."

#### Conducted Power Measurement Results (GSM850/1900)

GSM 850										
		Burst Output Power(dBm)				Division Factors	Frame-Average Output Power(dBm)			
Channel		128	190	251	Tune up		128	190	251	Tune up
GSM(GMSK)	GSM	32.58	32.70	32.65	33	-9.19	23.39	23.51	23.46	23.81
GPRS/EGPRS (GMSK)	1 TX Slot	32.63	32.57	32.56	33	-9.19	23.40	23.44	23.38	23.81
	2 TX Slots	30.49	30.53	30.50	31	-6.18	24.31	24.35	24.32	24.82
	3 TX Slots	28.97	29.01	28.97	30	-4.42	24.55	24.59	24.55	25.58
	4 TX Slots	28.49	28.51	28.49	29	-3.17	25.32	25.34	25.32	<b>25.83</b>
EGPRS(8PSK)	1 TX Slot	27.99	27.97	27.97	28	-9.19	18.80	18.78	18.78	18.81
	2 TX Slots	26.02	26.01	25.99	27	-6.18	19.84	19.83	19.81	20.82
	3 TX Slots	24.52	24.53	24.48	25	-4.42	20.10	20.11	20.06	20.58
	4 TX Slots	23.02	23.01	22.99	24	-3.17	19.85	19.84	19.82	20.83
GSM 1900										
		Burst Output Power(dBm)				Division Factors	Frame-Average Output Power(dBm)			
Channel		512	661	810	Tune up		512	661	810	Tune up
GSM(GMSK)	GSM	29.51	29.63	29.52	30	-9.19	20.32	20.44	20.33	20.81
GPRS/EGPRS (GMSK)	1 TX Slot	29.58	29.61	29.58	30	-9.19	20.39	20.42	20.39	20.81
	2 TX Slots	27.48	27.53	27.47	28	-6.18	23.30	23.35	23.29	21.82
	3 TX Slots	26.02	26.02	26.03	27	-4.42	23.60	23.60	23.61	<b>22.58</b>
	4 TX Slots	24.51	24.47	24.52	25	-3.17	23.34	23.30	23.35	21.83
EGPRS(8PSK)	1 TX Slot	25.02	24.98	25.03	26	-9.19	15.83	15.79	15.84	16.81
	2 TX Slots	24.51	24.51	24.49	25	-6.18	18.33	18.33	18.31	18.82
	3 TX Slots	23.02	23.01	23.01	24	-4.42	19.60	19.59	19.59	19.58
	4 TX Slots	22.49	22.48	22.52	23	-3.17	19.32	19.31	19.35	19.83

Notes:

#### 1) Division Factors

To average the power, the division factor is as follows:

1TX-slot = 1 transmit time slot out of 8 time slots=> conducted power divided by  $(25/26*8/1)$  => -9.20dB

2TX-slots = 2 transmit time slots out of 8 time slots=> conducted power divided by  $(25/26*8/18/2)$  => -6.1dB

3TX-slots = 3 transmit time slots out of 8 time slots=> conducted power divided by  $(25/26*8/18/3)$  => -4.42dB

4TX-slots = 4 transmit time slots out of 8 time slots=> conducted power divided by  $(25/26*8/18/4)$  => -3.17dB

**<UMTS Conducted Power>**

The following tests were conducted according to the test requirements outlines in 3GPP TS 34.121 specification. A summary of these settings are illustrated below:

**General Note**

1. Per KDB 941225 D01, RMC 12.2kbps setting is used to evaluate SAR. If AMR 12.2kbps power is < 0.25dB higher than RMC 12.2kbps, SAR tests with AMR 12.2kbps can be excluded.
2. By design, AMR and HSDPA/HSUPA RF power will not be larger than RMC 12.2kbps, detailed information is included in Tune-up Procure exhibit.
3. It is expected by the manufacturer that MPR for some HSDPA/HSUPA subtests may differ from the specification of 3GPP, according to the chipset implementation in this model. The implementation and expected deviation are detailed in tune-up procedure exhibit.

**Conducted Power Measurement Results (WCDMA Band V/II)**

Item	band	WCDMA Band II result (dBm)			WCDMA Band V result (dBm)		
		Channel/Frequency(MHz)			Channel/Frequency(MHz)		
	sub-test	9262/ 1852.4	9400/ 1880	9538/ 1907.6	4132/ 826.4	4183/ 836.6	4233/ 846.6
RMC	12.2kbps RMC	23.54	23.49	23.55	23.54	23.59	23.49
HSDPA	Sub –Test 1	23.42	23.28	23.43	23.48	23.33	23.55
	Sub –Test 2	23.50	23.12	23.36	23.52	23.12	23.14
	Sub –Test 3	23.50	23.40	23.31	23.53	23.45	23.34
	Sub –Test 4	22.75	22.50	22.31	22.72	22.58	22.41
HSUPA	Sub –Test 1	21.56	22.08	21.38	21.72	22.11	21.36
	Sub –Test 2	21.05	20.87	21.25	21.03	20.91	21.09
	Sub –Test 3	23.40	23.30	23.40	23.43	23.33	23.25
	Sub –Test 4	22.19	22.42	22.35	22.16	22.43	22.45
	Sub –Test 5	21.42	21.54	21.91	21.52	21.45	21.87

**Conducted Power Measurement Results (LTE Band 5)**

BW (MHz)	Frequency (MHz)	RB Configuration		Average Power [dBm]		
		Size	Offset	QPSK	16QAM	
1.4	824.70	1	0	23.06	22.07	
		1	3	23.29	21.45	
		1	5	22.31	22.12	
		3	0	22.42	21.96	
		3	2	22.62	21.29	
		3	3	22.42	21.26	
		6	0	22.50	22.00	
	836.50	1	0	22.46	22.17	
		1	3	22.54	21.52	
		1	5	22.52	21.66	
		3	0	22.65	22.12	
		3	2	22.35	22.07	
		3	3	22.65	21.45	
		6	0	22.74	21.83	
	848.30	1	0	22.89	21.50	
		1	3	22.37	21.89	
		1	5	22.10	21.63	
		3	0	22.57	21.59	
		3	2	22.08	21.56	
		3	3	22.57	21.45	
		6	0	22.63	20.97	
	3	825.50	1	0	22.55	21.65
			1	7	22.55	21.24
			1	14	21.93	21.48
8			0	22.77	20.92	
8			4	22.45	21.67	
8			7	22.24	21.75	
15			0	22.42	21.85	
836.50		1	0	22.65	21.67	



		1	7	22.04	21.56	
		1	14	22.07	21.52	
		8	0	22.17	21.25	
		8	4	22.35	21.03	
		8	7	22.16	21.43	
		15	0	22.85	21.57	
	847.50	1	0	21.94	21.77	
		1	7	22.77	21.06	
		1	14	22.70	20.95	
		8	0	22.82	21.57	
		8	4	22.32	21.41	
		8	7	22.04	20.74	
	5	826.50	1	0	22.20	20.73
			1	12	21.84	20.70
1			24	21.70	20.60	
12			0	22.30	20.66	
12			6	21.79	20.98	
12			13	22.25	21.30	
836.50		25	0	22.22	21.07	
		1	0	22.37	21.72	
		1	12	21.88	21.78	
		1	24	21.61	21.87	
		12	0	21.74	21.73	
		12	6	21.53	21.77	
846.50		12	13	22.11	21.64	
		25	0	22.25	21.94	
	1	0	21.73	20.73		
	1	12	21.86	21.35		
	1	24	22.22	20.63		
	12	0	22.34	20.83		
10	829.00	12	6	21.88	21.04	
		12	13	21.58	20.60	
		25	0	21.32	20.73	
		1	0	22.40	21.13	
		1	24	21.72	20.87	
		1	49	21.94	20.95	
	836.50	25	0	21.70	21.35	
		25	12	21.62	20.68	
		25	25	21.79	21.19	
		50	0	21.99	21.03	
		1	0	21.74	20.98	
		1	24	22.10	21.17	
	844.00	1	49	22.04	21.38	
		25	0	<b>22.22</b>	21.26	
25		12	21.72	21.05		
25		25	21.84	21.05		
50		0	21.90	21.15		
1		0	<b>22.50</b>	21.16		
	1	24	22.45	20.66		
	1	49	22.39	20.65		
	25	0	21.56	20.54		
	25	12	22.14	20.99		
	25	25	21.37	20.51		
	50	0	21.16	20.26		

<WLAN 2.4GHz Conducted Power>

Mode	Channel	Frequency (MHz)	Data rate (Mbps)	Average Output Power (dBm)
IEEE 802.11b	1	2412	1	11.60
	6	2437	1	12.36
	11	2462	1	11.54
IEEE 802.11g	1	2412	6	12.04
	6	2437	6	12.09
	11	2462	6	10.95
IEEE 802.11n HT20	1	2412	MCS0	11.21
	6	2437	MCS0	12.86
	11	2462	MCS0	10.20
IEEE 802.11n HT40	3	2422	MCS0	11.21
	6	2437	MCS0	9.80
	9	2452	MCS0	12.05

**Note:** SAR is not required for the following 2.4 GHz OFDM conditions as the highest reported SAR for DSSS is adjusted by the ratio of OFDM to DSSS specified maximum output power and the adjusted SAR is ≤ 1.2 W/kg.

<WLAN 5GHz U-NI-1 Conducted Power>

Test Mode	Channel	Frequency (MHz)	AVG Conducted Power (dBm)
IEEE 802.11a	36	5180	14.48
	40	5200	14.44
	48	5240	14.96
IEEE 802.11n HT20	36	5180	14.37
	40	5200	14.51
	48	5240	15.16
IEEE 802.11n HT40	38	5190	15.28
	46	5230	15.35

<WLAN 5GHz U-NI-3 Conducted Power>

Test Mode	Channel	Frequency (MHz)	AVG Conducted Power (dBm)
IEEE 802.11a	149	5745	13.45
	157	5785	13.69
	165	5825	14.02
IEEE 802.11n HT20	149	5745	13.61
	157	5785	13.70
	165	5825	14.15
IEEE 802.11n HT40	151	5755	13.99
	159	5795	14.36

<Bluetooth Conducted Power>

Mode	Channel	Frequency (MHz)	Conducted Average Power (dBm)
BLE-GFSK	0	2402	-1.44
	19	2440	-3.02
	39	2480	-4.33
GFSK	0	2402	-1.39
	39	2441	-2.16
	78	2480	-4.22
π/4DQPSK	0	2402	-3.15
	39	2441	-3.58
	78	2480	-5.06
8DPSK	0	2402	-3.07
	39	2441	-3.52
	78	2480	-4.98

## 5.2. Transmit Antennas Position

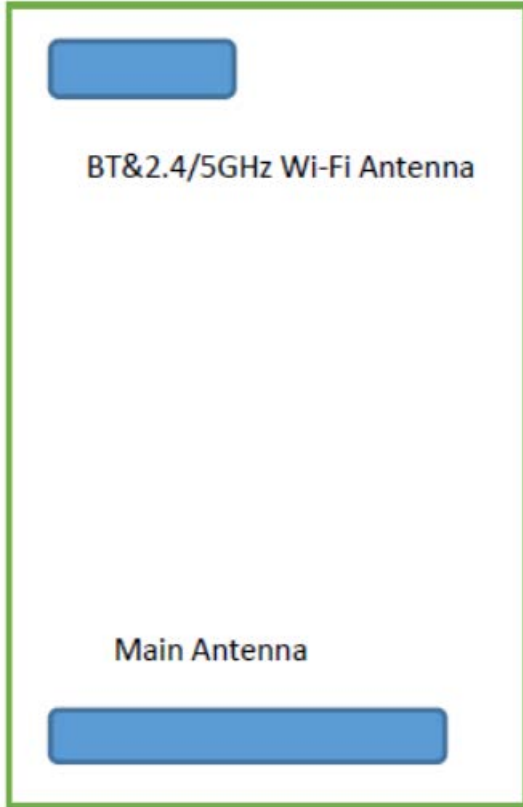

### Back View

Antenna information:

WWAN	GSM/UMTS/LTE TX/RX Antenna
WLAN/GPS/BT	WLAN/BT TX/RX Antenna

Distance of The Antenna to the EUT surface and edge						
Antennas	Front	Back	Top	Bottom	Left	Right
WWAN	<5mm	<5mm	158mm	<5mm	<5mm	<5mm
BT/WLAN	<5mm	<5mm	<5mm	162mm	65mm	<5mm

### 5.3. Standalone SAR Test Exclusion Considerations

Per KDB447498 for standalone 1-g head or body SAR evaluation by measurement or numerical simulation is not required when the corresponding SAR Exclusion Threshold condition, listed below, is satisfied.

a) The 1-g and 10-g SAR test exclusion thresholds for 100 MHz to 6 GHz at test separation distances  $\leq 50$  mm are determined by:

$[(\text{max. power of channel, including tune-up tolerance, mW}) / (\text{min. test separation distance, mm})] \cdot [\sqrt{f(\text{GHz})}] \leq 3.0$  for 1-g SAR and  $\leq 7.5$  for 10-g extremity SAR, where

- f(GHz) is the RF channel transmit frequency in GHz
- Power and distance are rounded to the nearest mW and mm before calculation
- The result is rounded to one decimal place for comparison
- 3.0 and 7.5 are referred to as the numeric thresholds in the step 2 below

b) For 100 MHz to 6 GHz and test separation distances  $> 50$  mm, the 1-g and 10-g SAR test exclusion thresholds are determined by the following (also illustrated in Appendix B):

1)  $\{[\text{Power allowed at numeric threshold for 50 mm in step a)}] + [(\text{test separation distance} - 50 \text{ mm}) \cdot (f(\text{MHz})/150)]\}$  mW, for 100 MHz to 1500 MHz

2)  $\{[\text{Power allowed at numeric threshold for 50 mm in step a)}] + [(\text{test separation distance} - 50 \text{ mm}) \cdot 10]\}$  mW, for  $> 1500$  MHz and  $\leq 6$  GHz.

Standalone SAR test exclusion considerations							
Modulation	Frequency (MHz)	Configuration	Maximum Average Power (dBm)	Separation Distance (mm)	Calculation Result	SAR Exclusion Thresholds	Standalone SAR Exclusion
IEEE 802.11b	2450	Front	13	<5mm	N/A	N/A	yes
		Back	13	<5mm	6.2	3.0	no
		Left	13	65mm	12.5	3.0	no
		Right	13	<5mm	13 dBm	23.9 dBm	yes
		Top	13	<5mm	6.2	3.0	no
		Bottom	13	162mm	13 dBm	30.85 dBm	yes
Bluetooth*	2450	Front	0	<5mm	N/A	N/A	yes
		Back	0	<5mm	0.3	3.0	yes
		Left	0	65mm	0.3	3.0	yes
		Right	0	<5mm	0 dBm	23.9 dBm	yes
		Top	0	<5mm	0.3	3.0	yes
		Bottom	0	162mm	0 dBm	30.85 dBm	yes
IEEE 802.11a	5800	Front	16	<5mm	N/A	N/A	yes
		Back	16	<5mm	19.2	3.0	no
		Left	16	65mm	16 dBm	23.27 dBm	no
		Right	16	<5mm	19.2	3.0	yes
		Top	16	<5mm	19.2	3.0	no
		Bottom	16	162mm	16.00 dBm	30.73 dBm	yes

Remark:

1. Maximum average power including tune-up tolerance;
2. When the minimum test separation distance is  $< 5$  mm, a distance of 5 mm is applied to determine SAR test exclusion
3. Per KDB 648474, if overall diagonal dimension of the display section of a tablet larger than 20 cm, no need consider Hotspot mode.
4. Body as body use distance is 0mm from manufacturer declaration of user manual.

### 5.4. Standalone Estimated SAR

Per KDB447498 requires when the standalone SAR test exclusion of section 4.3.1 is applied to an antenna that transmits simultaneously with other antennas, the standalone SAR must be estimated according to the following to determine simultaneous transmission SAR test exclusion;

•  $(\text{max. power of channel, including tune-up tolerance, mW}) / (\text{min. test separation distance, mm}) \cdot [\sqrt{f(\text{GHz})/x}]$  W/kg for test separation distances  $\leq 50$  mm;

Where  $x = 7.5$  for 1-g SAR, and  $x = 18.75$  for 10-g SAR.

• 0.4 W/kg for 1-g SAR and 1.0 W/kg for 10-g SAR, when the test separation distances is  $> 50$  mm

Per FCC KD B447498 D01, simultaneous transmission SAR test exclusion may be applied when the sum of the 1-g SAR for the entire transmitting antenna in a specific a physical test configuration is  $\leq 1.6$  W/Kg. When

the sum is greater than the SAR limit, AR test exclusion is determined by the SAR to peak location separation ratio.

$$\text{Ratio} = \frac{(\text{SAR}_1 + \text{SAR}_2)^{1.5}}{(\text{peak location separation, mm})} < 0.04$$

### 5.5. SAR Measurement Results

The calculated SAR is obtained by the following formula:

$$\text{Reported SAR} = \text{Measured SAR} * 10^{(P_{\text{target}} - P_{\text{measured}})/10}$$

$$\text{Scaling factor} = 10^{(P_{\text{target}} - P_{\text{measured}})/10}$$

$$\text{Reported SAR} = \text{Measured SAR} * \text{Scaling factor}$$

Where  $P_{\text{target}}$  is the power of manufacturing upper limit;

$P_{\text{measured}}$  is the measured power;

Measured SAR is measured SAR at measured power which including power drift)

Reported SAR which including Power Drift and Scaling factor

Duty Cycle	
Test Mode	Duty Cycle
GSM (Voice)	1:8
GPRS850	1:2.67
GPRS1900	1:2.67
UMTS Band IV	1:1
UMTS Band II	1:1
LTE Band 5	1:1
2.4GWLAN	1:1
5GWLAN	1:1

### 5.6. SAR Reporting Results

<Standalone SAR >

**Table 7: SAR Values [GSM850 (GSM/GPRS/EGPRS)]**

Test position	Test mode	Test Ch./Freq.	Duty Cycle	SAR (W/kg) 1-g	Power Drift(dB)	Conducted Power(dBm)	Tune up Limit(dBm)	Scaled factor	Scaled SAR(W/kg)	Liquid Temp	SAR limit (W/kg)
Head Test data											
Left touch cheek	GSM	190/836.6	1:8.3	0.109	-0.2	32.7	33	1.072	0.117	22.1	1.6
Left tilted 15 degree	GSM	190/836.6	1:8.3	0.084	0.02	32.7	33	1.072	0.090	22.1	1.6
Right touch cheek	GSM	190/836.6	1:8.3	0.115	0.07	32.7	33	1.072	<b>0.123</b>	22.1	1.6
Right tilted 15 degree	GSM	190/836.6	1:8.3	0.062	-0.06	32.7	33	1.072	0.066	22.1	1.6
Body Test data(Separate 0mm)											
Back side	GPRS 4TS	190/836.6	1:2.075	1.02	-0.08	28.51	29	1.119	1.142	22.1	1.6
Back side	GPRS 4TS	128/824.2	1:2.075	0.865	-0.04	28.49	29	1.125	0.973	22.1	1.6
Back side	GPRS 4TS	251/848.8	1:2.075	1.13	-0.07	28.49	29	1.125	1.271	22.1	1.6
Left side	GPRS 4TS	190/836.6	1:2.075	0.827	0.03	28.51	29	1.119	0.926	22.1	1.6
Left side	GPRS 4TS	128/824.2	1:2.075	0.705	0.02	28.49	29	1.125	0.793	22.1	1.6
Left side	GPRS 4TS	251/848.8	1:2.075	0.954	0.01	28.49	29	1.125	1.073	22.1	1.6
Right side	GPRS 4TS	190/836.6	1:2.075	0.821	0.02	28.51	29	1.119	0.919	22.1	1.6
Right side	GPRS 4TS	128/824.2	1:2.075	0.701	-0.01	28.49	29	1.125	0.788	22.1	1.6
Right side	GPRS 4TS	251/848.8	1:2.075	0.977	0.07	28.49	29	1.125	1.099	22.1	1.6
Bottom side	GPRS 4TS	190/836.6	1:2.075	0.101	0.13	28.51	29	1.119	0.113	22.1	1.6
Back side-repeat	GPRS 4TS	251/848.8	1:2.075	1.14	-0.03	28.49	29	1.125	<b>1.282</b>	22.1	1.6

Remark:

1. The value with block color is the maximum SAR Value of each test band.
2. Per FCC KDB Publication 447498 D01, if the reported (scaled) SAR measured at the middle channel or highest output power channel for each test configuration is ≤ 0.8 W/kg then testing at the other channels is optional for such test configuration(s).

**Table 8: SAR Values [GSM1900 (GSM/GPRS/EGPRS)]**

Test position	Test mode	Test Ch./Freq.	Duty Cycle	SAR (W/kg) 1-g	Power Drift(dB)	Conducted Power (dBm)	Tune up Limit (dBm)	Scaled factor	Scaled SAR (W/kg)	Liquid Temp	SAR limit (W/kg)
Head Test data											
Left touch cheek	GSM	661/1880	1:8.3	0.184	0.03	29.63	30	1.089	<b>0.200</b>	22.3	1.6
Left tilted 15 degree	GSM	661/1880	1:8.3	0.103	-0.07	29.63	30	1.089	0.112	22.3	1.6
Right touch cheek	GSM	661/1880	1:8.3	0.136	-0.15	29.63	30	1.089	0.148	22.3	1.6
Right tilted 15 degree	GSM	661/1880	1:8.3	0.097	-0.03	29.63	30	1.089	0.106	22.3	1.6
Body Test data(Separate 0mm)											
Back side	GPRS 3TS	661/1880	1:2.075	0.54	-0.09	26.02	27	1.253	<b>0.677</b>	22.3	1.6
Left side	GPRS 3TS	661/1880	1:2.075	0.318	0.09	26.02	27	1.253	0.398	22.3	1.6
Right side	GPRS 3TS	661/1880	1:2.075	0.126	0	26.02	27	1.253	0.158	22.3	1.6
Bottom side	GPRS 3TS	661/1880	1:2.075	0.311	0.06	26.02	27	1.253	0.390	22.3	1.6

Remark:

1. The value with block color is the maximum SAR Value of each test band.
2. Per FCC KDB Publication 447498 D01, if the reported (scaled) SAR measured at the middle channel or highest output power channel for each test configuration is  $\leq 0.8$  W/kg then testing at the other channels is optional for such test configuration(s).

**Table 9: SAR Values [UMTS Band V (WCDMA/HSDPA/HSUPA)]**

Test position	Test mode	Test Ch./Freq.	Duty Cycle	SAR (W/kg) 1-g	Power Drift(dB)	Conducted Power (dBm)	Tune up Limit (dBm)	Scaled factor	Scaled SAR (W/kg)	Liquid Temp	SAR limit (W/kg)
Head Test data											
Left touch cheek	RMC	4182/836.6	1:1	0.132	0.03	23.59	24	1.099	<b>0.145</b>	22.1	1.6
Left tilted 15 degree	RMC	4182/836.6	1:1	0.071	0.291	23.59	24	1.099	0.078	22.1	1.6
Right touch cheek	RMC	4182/836.6	1:1	0.114	-0.04	23.59	24	1.099	0.125	22.1	1.6
Right tilted 15 degree	RMC	4182/836.6	1:1	0.081	-0.05	23.59	24	1.099	0.089	22.1	1.6
Body Test data(Separate 0mm)											
Back side	RMC	4182/836.6	1:1	0.598	0.02	23.59	24	1.099	<b>0.657</b>	22.1	1.6
Left side	RMC	4182/836.6	1:1	0.496	0.01	23.59	24	1.099	0.545	22.1	1.6
Right side	RMC	4182/836.6	1:1	0.536	0.07	23.59	24	1.099	0.589	22.1	1.6
Bottom side	RMC	4182/836.6	1:1	0.0601	0.04	23.59	24	1.099	0.066	22.1	1.6

Remark:

1. The value with block color is the maximum SAR Value of each test band.
2. Per FCC KDB Publication 447498 D01, if the reported (scaled) SAR measured at the middle channel or highest output power channel for each test configuration is  $\leq 0.8$  W/kg then testing at the other channels is optional for such test configuration(s).

**Table 10: SAR Values [UMTS Band II (WCDMA/HSDPA/HSUPA)]**

Test position	Test mode	Test Ch./Freq.	Duty Cycle	SAR (W/kg)1-g	Power Drift(dB)	Conducted Power (dBm)	Tune up Limit (dBm)	Scaled factor	Scaled SAR(W/kg)	Liquid Temp	SAR limit (W/kg)
Head Test data											
Left touch cheek	RMC	9400/1880	1:1	0.118	0.07	23.49	24	1.125	<b>0.133</b>	22.3	1.6
Left tilted 15 degree	RMC	9400/1880	1:1	0.063	0.03	23.49	24	1.125	0.071	22.3	1.6
Right touch cheek	RMC	9400/1880	1:1	0.107	0.1	23.49	24	1.125	0.120	22.3	1.6
Right tilted 15 degree	RMC	9400/1880	1:1	0.056	-0.07	23.49	24	1.125	0.063	22.3	1.6
Body Test data(Separate 0mm)											
Back side	RMC	9400/1880	1:1	0.451	0.05	23.49	24	1.125	<b>0.507</b>	22.3	1.6
Left side	RMC	9400/1880	1:1	0.293	0.06	23.49	24	1.125	0.330	22.3	1.6
Right side	RMC	9400/1880	1:1	0.133	0.05	23.49	24	1.125	0.150	22.3	1.6
Bottom side	RMC	9400/1880	1:1	0.273	0.11	23.49	24	1.125	0.307	22.3	1.6

Remark:

1. The value with block color is the maximum SAR Value of each test band.
2. Per FCC KDB Publication 447498 D01, if the reported (scaled) SAR measured at the middle channel or highest output power channel for each test configuration is ≤ 0.8 W/kg then testing at the other channels is optional for such test configuration(s).

**Table 11: SAR Values [LTE Band 5]**

Test position	Test mode	Test Ch./Freq.	Duty Cycle	SAR (W/kg) 1-g	Power Drift(dB)	Conducted power (dBm)	Tune up Limit (dBm)	Scaled factor	Scaled SAR (W/kg)	Liquid Temp.	SAR limit(W/kg)
Head Test data(1RB)											
Left touch cheek	QPSK	20600/844	1:1	0.125	-0.03	22.5	23	1.122	0.140	22.1	1.6
Left tilted 15 degree	QPSK	20600/844	1:1	0.077	-0.07	22.5	23	1.122	0.086	22.1	1.6
Right touch cheek	QPSK	20600/844	1:1	0.147	0	22.5	23	1.122	<b>0.165</b>	22.1	1.6
Right tilted 15 degree	QPSK	20600/844	1:1	0.094	-0.11	22.5	23	1.122	0.105	22.1	1.6
Head Test data(50%RB)											
Left touch cheek	QPSK	20525/836.5	1:1	0.081	-0.03	22.22	23	1.197	0.097	22.1	1.6
Left tilted 15 degree	QPSK	20525/836.5	1:1	0.064	0.09	22.22	23	1.197	0.077	22.1	1.6
Right touch cheek	QPSK	20525/836.5	1:1	0.128	0.13	22.22	23	1.197	0.153	22.1	1.6
Right tilted 15 degree	QPSK	20525/836.5	1:1	0.0711	0.01	22.22	23	1.197	0.085	22.1	1.6
Body Test data(Separate 0mm 1RB)											
Back side	QPSK	20600/844	1:1	0.694	0.02	22.5	23	1.122	<b>0.779</b>	22.1	1.6
Left side	QPSK	20600/844	1:1	0.64	0.01	22.5	23	1.122	0.718	22.1	1.6
Right side	QPSK	20600/844	1:1	0.6	0.01	22.5	23	1.122	0.673	22.1	1.6
Bottom side	QPSK	20600/844	1:1	0.0909	0.17	22.5	23	1.122	0.102	22.1	1.6
Body Test data(Separate 10mm 50%RB)											
Back side	QPSK	20600/844	1:1	0.544	0.02	22.22	23	1.197	0.651	22.1	1.6
Left side	QPSK	20600/844	1:1	0.459	0.06	22.22	23	1.197	0.549	22.1	1.6
Right side	QPSK	20600/844	1:1	0.502	0.07	22.22	23	1.197	0.601	22.1	1.6
Bottom side	QPSK	20600/844	1:1	0.0702	0.03	22.22	23	1.197	0.084	22.1	1.6

Remark:

1. The value with block color is the maximum SAR Value of each test band.
2. Per FCC KDB Publication 447498 D01, if the reported (scaled) SAR measured at the middle channel or highest output power channel for each test configuration is ≤ 0.8 W/kg then testing at the other channels is optional for such test configuration(s).



**Table 12: SAR Values [2.4GWLAN IEEE 802.11b]**

Test position	Test mode	Test Ch./Freq.	Duty Cycle	SAR (W/kg) 1-g	Power drift(dB)	Conducted power (dBm)	Tune up Limit (dBm)	Scaled factor	Scaled SAR (W/kg)	Liquid Temp.	SAR limit (W/kg)
Head Test data											
Left touch cheek	802.11b	6/2437	1:1	0.391	0.01	12.36	13	1.159	0.453	22	1.6
Left tilted 15 degree	802.11b	6/2437	1:1	0.352	-0.01	12.36	13	1.159	0.408	22	1.6
Right touch cheek	802.11b	6/2437	1:1	<b>0.825</b>	-0.01	12.36	13	1.159	<b>0.956</b>	22	1.6
Right touch cheek	802.11b	1/2412	1:1	0.663	-0.08	11.6	13	1.380	0.915	22	1.6
Right touch cheek	802.11b	11/2462	1:1	0.68	0.01	11.54	13	1.400	0.952	22	1.6
Right tilted 15 degree	802.11b	6/2437	1:1	0.688	-0.2	12.36	13	1.159	0.797	22	1.6
Right touch cheek side-repeat	802.11b	6/2437	1:1	0.74	0	12.36	13	1.159	0.857	22	1.6
Body Test data (Separate 0mm)											
Back side	802.11b	6/2437	1:1	<b>0.241</b>	-0.03	12.36	13	1.159	<b>0.279</b>	22	1.6
Left side	802.11b	6/2437	1:1	0.0462	0.05	12.36	13	1.159	0.054	22	1.6
Right side	802.11b	6/2437	1:1	0.0147	0.04	12.36	13	1.159	0.017	22	1.6
Top side	802.11b	6/2437	1:1	0.0742	0.09	12.36	13	1.159	0.086	22	1.6

**Remark:**

1. The value with block color is the maximum SAR Value of each test band.
2. Per FCC KDB Publication 447498 D01, if the reported (scaled) SAR measured at the middle channel or highest output power channel for each test configuration is ≤ 0.8 W/kg then testing at the other channels is optional for such test configuration(s).

**Table 13: SAR Values [5 GWLAN IEEE 802.11n]**

Test position	Test mode	Test Ch./Freq.	Duty Cycle	Duty Cycle Scaled factor	SAR (W/kg) 1-g	Power drift (dB)	Conducted power (dBm)	Tune up Limit (dBm)	Scaled factor	Scaled SAR (W/kg)	Liquid Temp.
Head Test data U-NII-1											
Left cheek	802.11n40	46/5230	100%	1	0.373	0.08	15.35	16	1.161	<b>0.433</b>	22
Left tilted	802.11n40	46/5230	100%	1	0.272	0.03	15.35	16	1.161	0.316	22
Right cheek	802.11n40	46/5230	100%	1	0.144	0.07	15.35	16	1.161	0.167	22
Right tilted	802.11n40	46/5230	100%	1	0.129	0.03	15.35	16	1.161	0.150	22
Head Test data U-NII-3											
Left cheek	802.11n40	159/5795	100%	1	0.281	-0.04	14.36	15	1.159	0.326	22
Left tilted	802.11n40	159/5795	100%	1	0.205	0.07	14.36	15	1.159	0.238	22
Right cheek	802.11n40	159/5795	100%	1	0.145	0	14.36	15	1.159	0.168	22
Right tilted	802.11n40	159/5795	100%	1	0.118	0.04	14.36	15	1.159	0.137	22
Body Test data U-NII-1(Separate 0mm)											
Back side	802.11n40	46/5230	100%	1	0.0804	0.04	14.36	15	1.159	0.093	22
Right side	802.11n40	46/5230	100%	1	0.0244	0.03	14.36	15	1.159	0.028	22
Top side	802.11n40	46/5230	100%	1	0.0361	0.06	14.36	15	1.159	0.042	22
Body Test data U-NII-3(Separate 0mm)											
Back side	802.11n40	159/5795	100%	1	0.0801	0.08	14.36	15	1.159	<b>0.093</b>	22
Right side	802.11n40	159/5795	100%	1	0.0284	0.03	14.36	15	1.159	0.033	22
Top side	802.11n40	159/5795	100%	1	0.0419	0.03	14.36	15	1.159	0.049	22

**Remark:**

1. The value with block color is the maximum SAR Value of each test band.
2. Per FCC KDB Publication 447498 D01, if the reported (scaled) SAR measured at the middle channel or highest output power channel for each test configuration is ≤ 0.8 W/kg then testing at the other channels is optional for such test configuration(s).

## 5.7. Simultaneous TX SAR Considerations

### 5.8.1 Introduction

The following procedures adopted from “FCC SAR Considerations for Cell Phones with Multiple Transmitters” are applicable to handsets with built-in unlicensed transmitters such as 802.11 a/b/g/n and Bluetooth devices which may simultaneously transmit with the licensed transmitter.

Application Simultaneous Transmission information:

NO.	Simultaneous Transmission Configuration	Head	Body worn
1	GSM(Voice)+ 2.4GHzWiFi	Yes	Yes
2	GSM(Voice)+ 5GHzWiFi	Yes	Yes
3	GSM(Voice) + BT	Yes	Yes
4	GPRS / EDGE(Data) +	N/A	Yes
5	GPRS / EDGE(Data) +	N/A	Yes
6	GPRS / EDGE(Data) + BT	N/A	Yes
7	WCDMA(Voice) + 2.4GHzWiFi	Yes	Yes
8	WCDMA(Voice) + 5GHzWiFi	Yes	Yes
9	WCDMA Voice) + BT	Yes	Yes
10	WCDMA(Data) + 2.4GHzWiFi	N/A	Yes
11	WCDMA(Data) + 5GHzWiFi	N/A	Yes
12	WCDMA(Data) + BT	N/A	Yes
13	LTE(Data) + 2.4GHzWiFi	Yes	Yes
14	LTE(Data) + 5GHzWiFi	Yes	Yes
15	LTE(Data) + BT	Yes	Yes
16	BT+WIFI (They share the same antenna and cannot transmit at the same time by design.)	No	No

Remark:

1. BT and WLAN can be active at the same time, but only with interleaving of packages switched on board level. That means that they don't transmit at the same time.

### 5.8.2 Evaluation of Simultaneous SAR

The following tables list information which is relevant for the decision if a simultaneous transmit evaluation is necessary according to FCC KDB 447498D01 General RF Exposure Guidance v06.

#### Head Exposure Conditions

WWAN Band	Exposure position	① MAX.WWAN SAR(W/kg)	② MAX.2.4G WLAN SAR(W/kg)	③MAX.5G WLAN SAR(W/kg)	④ MAX.BT SAR(W/kg)	Summed SAR①+②	Summed SAR①+③	Summed SAR①+④	Case NO.
GSM850	Left Touch	0.117	0.453	0.433	0.042	0.570	0.550	0.159	No
	Left Tilt	0.090	0.408	0.316	0.042	0.498	0.406	0.132	No
	Right Touch	0.123	0.956	0.168	0.042	1.079	0.291	0.165	No
	Right Tilt	0.066	0.797	0.150	0.042	0.863	0.216	0.108	No
GSM1900	Left Touch	<b>0.200</b>	0.453	0.433	0.042	0.653	0.633	0.242	No
	Left Tilt	0.112	0.408	0.316	0.042	0.520	0.428	0.154	No
	Right Touch	0.148	0.956	0.168	0.042	1.104	0.316	0.190	No
	Right Tilt	0.106	0.797	0.150	0.042	0.903	0.256	0.148	No
WCDMA 850	Left Touch	<b>0.145</b>	0.453	0.433	0.042	0.598	0.578	0.187	No
	Left Tilt	0.078	0.408	0.316	0.042	0.486	0.394	0.120	No
	Right Touch	0.125	0.956	0.168	0.042	1.081	0.293	0.167	No
	Right Tilt	0.089	0.797	0.150	0.042	0.886	0.239	0.131	No
WCDMA 1900	Left Touch	<b>0.133</b>	0.453	0.433	0.042	0.586	0.566	0.175	No
	Left Tilt	0.071	0.408	0.316	0.042	0.479	0.387	0.113	No
	Right Touch	0.120	0.956	0.168	0.042	1.076	0.288	0.162	No
	Right Tilt	0.063	0.797	0.150	0.042	0.860	0.213	0.105	No
LTE Band 5	Left Touch	0.140	0.453	0.433	0.042	0.593	0.573	0.182	No
	Left Tilt	0.086	0.408	0.316	0.042	0.494	0.402	0.128	No
	Right Touch	<b>0.165</b>	0.956	0.168	0.042	<b>1.121</b>	0.333	0.207	No
	Right Tilt	0.105	0.797	0.150	0.042	0.902	0.255	0.147	No

**Body Exposure Conditions**

WWAN Band	Exposure position	① MAX.WWAN SAR(W/kg)	② MAX.2.4G WLAN SAR(W/kg)	③ MAX.5G WLAN SAR(W/kg)	④ MAX.BT SAR(W/kg)	Summed SAR①+②	Summed SAR①+③	Summed SAR①+④	Case NO.
GSM850	Back	1.282	0.279	0.093	0.042	1.561	1.375	1.324	No
	Left	1.073	0.054	0.000	0.042	1.127	1.073	1.115	No
	Right	1.099	0.017	0.033	0.042	1.116	1.132	1.141	No
	Top	0.000	0.086	0.049	0.042	0.086	0.049	0.042	No
	Bottom	0.113	0.000	0.000	0.042	0.113	0.113	0.155	No
GSM1900	Back	0.677	0.279	0.093	0.042	0.956	0.770	0.719	No
	Left	0.398	0.054	0.000	0.042	0.452	0.398	0.440	No
	Right	0.158	0.017	0.033	0.042	0.175	0.191	0.200	No
	Top	0.000	0.086	0.049	0.042	0.086	0.049	0.042	No
	Bottom	0.390	0.000	0.000	0.042	0.390	0.390	0.432	No
WCDMA 850	Back	0.657	0.279	0.093	0.042	0.936	0.750	0.699	No
	Left	0.545	0.054	0.000	0.042	0.599	0.545	0.587	No
	Right	0.589	0.017	0.033	0.042	0.606	0.622	0.631	No
	Top	0.000	0.086	0.049	0.042	0.086	0.049	0.042	No
	Bottom	0.066	0.000	0.000	0.042	0.066	0.066	0.108	No
WCDMA 1900	Back	0.507	0.279	0.093	0.042	0.786	0.600	0.549	No
	Left	0.330	0.054	0.000	0.042	0.384	0.330	0.372	No
	Right	0.150	0.017	0.033	0.042	0.167	0.183	0.192	No
	Top	0.000	0.086	0.049	0.042	0.086	0.049	0.042	No
	Bottom	0.307	0.000	0.000	0.042	0.307	0.307	0.349	No
LTE Band 5	Back	0.779	0.279	0.093	0.042	1.058	0.872	0.821	No
	Left	0.718	0.054	0.000	0.042	0.772	0.718	0.760	No
	Right	0.718	0.017	0.033	0.042	0.735	0.751	0.760	No
	Top	0.000	0.086	0.049	0.042	0.086	0.049	0.042	No
	Bottom	0.102	0.000	0.000	0.042	0.102	0.102	0.144	No

**Remark:**

1. BT and WLAN can be active at the same time, but only with interleaving of packages switched on board level. That means that they don't transmit at the same time.
2. The value with block color is the maximum values of  $\sum SAR_{1-g}$

## 5.8. SAR Measurement Variability

SAR measurement variability must be assessed for each frequency band, which is determined by the SAR probe calibration point and tissue-equivalent medium used for the device measurements. When both head and body tissue-equivalent media are required for SAR measurements in a frequency band, the variability measurement procedures should be applied to the tissue medium with the highest measured SAR, using the highest measured SAR configuration for that tissue-equivalent medium. The following procedures are applied to determine if repeated measurements are required.

- 1) Repeated measurement is not required when the original highest measured SAR is  $< 0.80$  W/kg; steps 2) through 4) do not apply.
- 2) When the original highest measured SAR is  $\geq 0.80$  W/kg, repeat that measurement once.
- 3) Perform a second repeated measurement only if the ratio of largest to smallest SAR for the original and first repeated measurements is  $> 1.20$  or when the original or repeated measurement is  $\geq 1.45$  W/kg ( $\sim 10\%$  from the 1-g SAR limit).
- 4) Perform a third repeated measurement only if the original, first or second repeated measurement is  $\geq 1.5$  W/kg and the ratio of largest to smallest SAR for the original, first and second repeated measurements is  $> 1.20$ .

The same procedures should be adapted for measurements according to extremity and occupational exposure limits by applying a factor of 2.5 for extremity exposure and a factor of 5 for occupational exposure to the corresponding SAR thresholds.

Thus the following procedures are applied to determine if repeated measurements are required for occupational exposure.

- 5) Repeated measurement is not required when the original highest measured SAR is  $< 4.00$  W/kg; steps 6) through 8) do not apply.
- 6) When the original highest measured SAR is  $\geq 4.00$  W/kg, repeat that measurement once.
- 7) Perform a second repeated measurement only if the ratio of largest to smallest SAR for the original and first repeated measurements is  $> 6.00$  or when the original or repeated measurement is  $\geq 7.25$  W/kg ( $\sim 10\%$  from the 1-g SAR limit).
- 8) Perform a third repeated measurement only if the original, first or second repeated measurement is  $\geq 7.5$  W/kg and the ratio of largest to smallest SAR for the original, first and second repeated measurements is  $> 1.20$ .

Frequency (MHz)	Air Interface	RF Exposure Configuration	Test Position	Repeated SAR (yes/no)	Highest SAR <sub>1-g</sub> (W/Kg)	First Repeated	
						SAR <sub>1-g</sub> (W/Kg)	Largest to Smallest SAR Ratio
850	GSM850	Standalone	Back	yes	1.13	1.14	1.01

*Remark:*

1. *Second Repeated Measurement is not required since the ratio of the largest to smallest SAR for the original and first repeated measurement is not  $> 1.20$  or 3 (1-g or 10-g respectively)*

## 5.9. Measurement Uncertainty

Not required as SAR measurement uncertainty analysis is required in SAR reports only when the highest measured SAR in a frequency band is  $\geq 1.5$  W/kg for 1-g SAR according to KDB865664D01.

A	b1	c	d	e = f(d,k)	g	i = C*g/e	k
Uncertainty Component	Section in P1528	Tol (%)	Prob . Dist.	Div.	Ci (1g)	1g ui (%)	Vi (Veff)
Probe calibration	E.2.1	6.3	N	1	1	6.30	$\infty$
Axial isotropy	E.2.2	0.5	R	$\sqrt{3}$	$(1 - C_p)1/2$	0.20	$\infty$
hemispherical isotropy	E.2.2	2.6	R	$\sqrt{3}$	$\sqrt{C_p}$	1.06	$\infty$
Boundary effect	E.2.3	1.0	R	$\sqrt{3}$	1	0.58	$\infty$
Linearity	E.2.4	0.6	R	$\sqrt{3}$	1	0.35	$\infty$
System detection limit	E.2.5	0.25	R	$\sqrt{3}$	1	0.14	$\infty$
Readout electronics	E.2.6	0.3	N	1	1	0.30	$\infty$
Response time	E.2.7	0	R	$\sqrt{3}$	1	0.00	$\infty$
Integration time	E.2.8	2.6	R	$\sqrt{3}$	1	1.50	$\infty$
RF ambient Condition –Noise	E.6.1	3	R	$\sqrt{3}$	1	1.73	$\infty$
RF ambient Condition - reflections	E.6.1	3	R	$\sqrt{3}$	1	1.73	$\infty$
Probe positioning- mechanical tolerance	E.6.2	1.5	R	$\sqrt{3}$	1	0.87	$\infty$
Probe positioning- with respect to phantom	E.6.3	2.9	R	$\sqrt{3}$	1	1.67	$\infty$
Max. SAR evaluation	E.5.2	1	R	$\sqrt{3}$	1	0.58	$\infty$
Test sample positioning	E.4.2	3.7	N	1	1	3.70	9
Device holder uncertainty	E.4.1	3.6	N	1	1	3.60	$\infty$
Output power variation –SAR drift measurement	6.6.2	5	R	$\sqrt{3}$	1	2.89	$\infty$
Phantom uncertainty (shape and thickness tolerances)	E.3.1	4	R	$\sqrt{3}$	1	2.31	$\infty$
Liquid conductivity - deviation from target values	E.3.2	5	R	$\sqrt{3}$	0.64	1.85	$\infty$
Liquid conductivity - measurement uncertainty	E.3.2	5.78	N	1	0.64	3.68	5
Liquid permittivity - deviation from target values	E.3.3	5	R	$\sqrt{3}$	0.6	1.73	$\infty$
Liquid permittivity - measurement uncertainty	E.3.3	0.62	N	1	0.6	0.372	5
Combined standard uncertainty				RSS		10.80	430
Expanded uncertainty (95% CONFIDENCE INTERVAL)				K=2		<b>21.60</b>	

### 5.10. System Check Results

System Performance Check 835 MHz Head

DUT: D835V2; Type: D835V2; Serial: 4d120

Date/Time: 4/20/2018

Communication System: UID 0, CW (0); Frequency: 835 MHz;Duty Cycle: 1:1  
Medium: HSL835;Medium parameters used: f = 835 MHz;  $\sigma = 0.926$  S/m;  $\epsilon_r = 40.953$ ;  $\rho = 1000$  kg/m<sup>3</sup>  
Phantom section: Flat Section

DASY 5 Configuration:

- Probe: EX3DV4 - SN7340; ConvF(9.56, 9.56, 9.56); Calibrated: 2017/12/10;
- Sensor-Surface: 4mm (Mechanical Surface Detection), z = 1.0, 31.0
- Electronics: DAE4 Sn1454; Calibrated: 2017/12/8
- Phantom: SAM2; Type: SAM; Serial: 1640
- DASY52 52.8.8(1222); SEMCAD X 14.6.10(7331)

Body/d=15mm, Pin=250mW/Area Scan (7x13x1): Measurement grid: dx=15mm, dy=15mm

Maximum value of SAR (measured) = 2.48 W/kg

Body/d=15mm, Pin=250mW/Zoom Scan (7x7x7) (7x7x7)/Cube 0: Measurement grid:

dx=5mm, dy=5mm, dz=5mm

Reference Value = 53.38 V/m; Power Drift = -0.02 dB

Peak SAR (extrapolated) = 3.39 W/kg

SAR(1 g) = 2.3 W/kg; SAR(10 g) = 1.54 W/kg

Maximum value of SAR (measured) = 2.48 W/kg

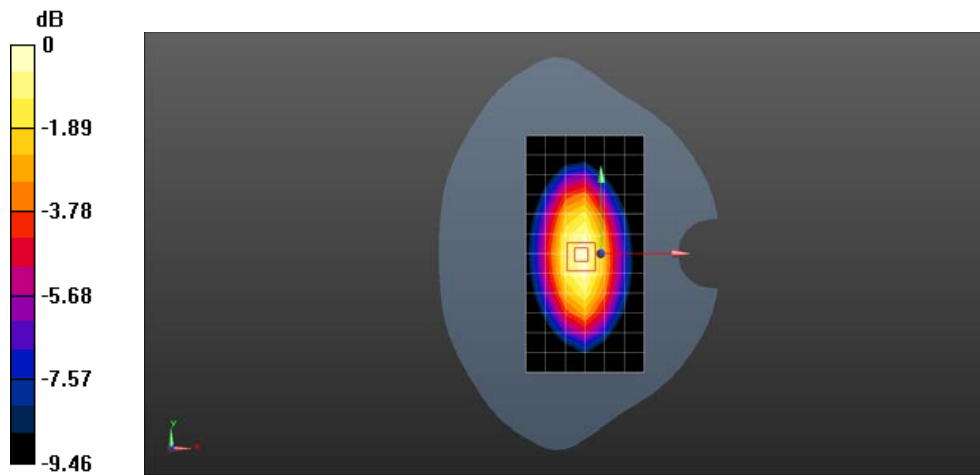

0 dB = 2.48 W/kg = 3.94 dBW/kg



**System Performance Check 835 MHz Body**

DUT: D835V2; Type: D835V2; Serial: 4d120

Date/Time: 4/21/2018

Communication System: UID 0, CW (0); Frequency: 835 MHz;Duty Cycle: 1:1  
 Medium: MSL835;Medium parameters used:  $f = 835 \text{ MHz}$ ;  $\sigma = 1.004 \text{ S/m}$ ;  $\epsilon_r = 55.669$ ;  $\rho = 1000 \text{ kg/m}^3$   
 Phantom section: Flat Section

DASY 5 Configuration:

- Probe: EX3DV4 - SN7340; ConvF(9.83, 9.83, 9.83); Calibrated: 2017/12/10;
- Sensor-Surface: 4mm (Mechanical Surface Detection),  $z = 1.0, 31.0$
- Electronics: DAE4 Sn1454; Calibrated: 2017/12/8
- Phantom: SAM2; Type: SAM; Serial: 1640
- DASY52 52.8.8(1222); SEMCAD X 14.6.10(7331)

Body/d=15mm, Pin=250mW/Area Scan (7x13x1): Measurement grid:  $dx=15\text{mm}$ ,  $dy=15\text{mm}$

Maximum value of SAR (measured) = 2.43 W/kg

Body/d=15mm, Pin=250mW/Zoom Scan (7x7x7) (7x7x7)/Cube 0: Measurement grid:  
 $dx=5\text{mm}$ ,  $dy=5\text{mm}$ ,  $dz=5\text{mm}$

Reference Value = 50.43 V/m; Power Drift = -0.08 dB

Peak SAR (extrapolated) = 3.34 W/kg

SAR(1 g) = 2.32 W/kg; SAR(10 g) = 1.57 W/kg

Maximum value of SAR (measured) = 2.50 W/kg

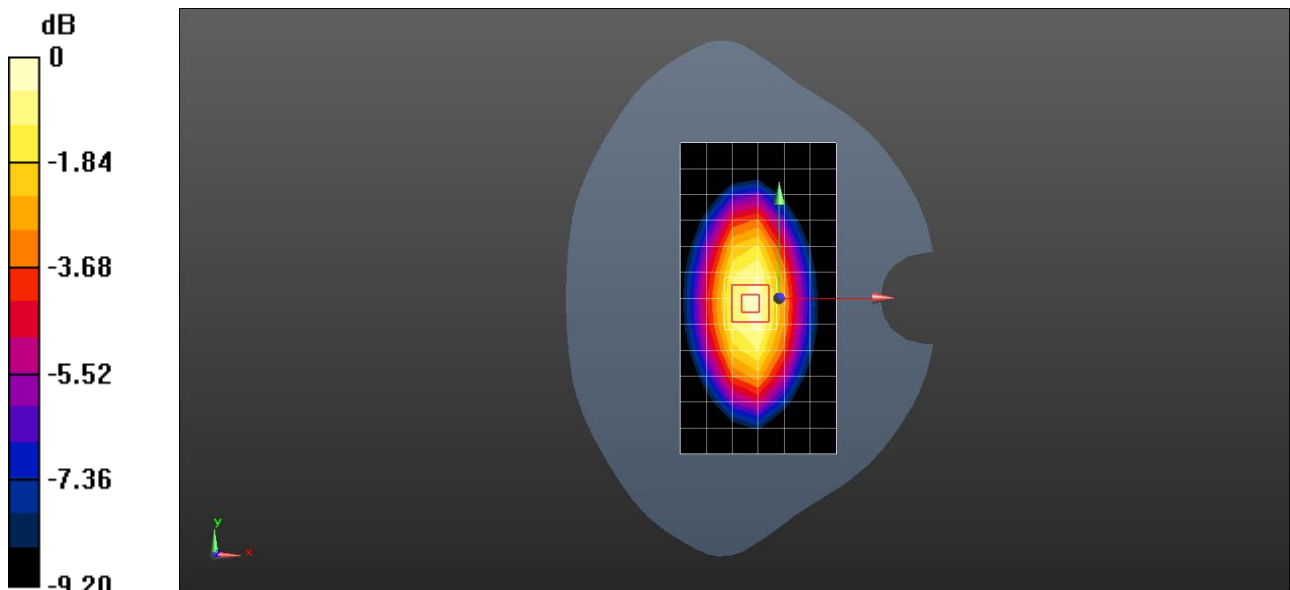

0 dB = 2.50 W/kg = 3.98 dBW/kg

### System Performance Check 1900 MHz Head

DUT: D1900V2; Type: D1900V2; Serial: 5d142  
Date/Time: 4/21/2018

Communication System: UID 0, CW (0); Frequency: 1900 MHz;Duty Cycle: 1:1  
Medium: HSL1900;Medium parameters used:  $f = 1900$  MHz;  $\sigma = 1.437$  S/m;  $\epsilon_r = 40.578$ ;  $\rho = 1000$  kg/m<sup>3</sup>  
Phantom section: Flat Section

DASY 5 Configuration:

- Probe: EX3DV4 - SN7340; ConvF(8.15, 8.15, 8.15); Calibrated: 2017/12/10;
- Sensor-Surface: 4mm (Mechanical Surface Detection),  $z = 1.0, 31.0$
- Electronics: DAE4 Sn1454; Calibrated: 2017/12/8
- Phantom: SAM2; Type: SAM; Serial: 1640
- DASY52 52.8.8(1222); SEMCAD X 14.6.10(7331)

Body/d=10mm, Pin=250mW/Area Scan (7x11x1): Measurement grid: dx=15mm, dy=15mm

Maximum value of SAR (measured) = 10.8 W/kg

Body/d=10mm, Pin=250mW/Zoom Scan (7x7x7) (7x7x7)/Cube 0: Measurement grid:  
dx=5mm, dy=5mm, dz=5mm

Reference Value = 85.19 V/m; Power Drift = -0.06 dB

Peak SAR (extrapolated) = 18.4 W/kg

SAR(1 g) = 10 W/kg; SAR(10 g) = 5.21 W/kg

Maximum value of SAR (measured) = 11.4 W/kg

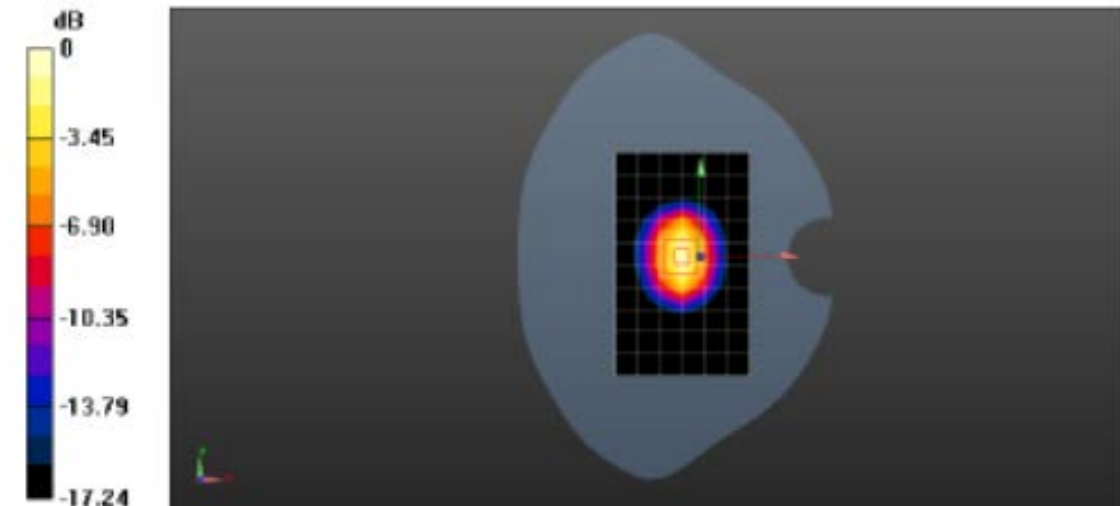

0 dB = 11.4 W/kg = 10.57 dBW/kg

**System Performance Check 1900 MHz Body**

DUT: D1900V2; Type: D1900V2; Serial: 5d142

Date/Time: 4/25/2018

Communication System: UID 0, CW (0); Frequency: 1900 MHz;Duty Cycle: 1:1

Medium: MSL1900;Medium parameters used: f = 1900 MHz;  $\sigma = 1.523$  S/m;  $\epsilon_r = 52.205$ ;  $\rho = 1000$  kg/m<sup>3</sup>

Phantom section: Flat Section

DASY 5 Configuration:

- Probe: EX3DV4 - SN7340; ConvF(7.51, 7.51, 7.51); Calibrated: 2017/12/10;

- Sensor-Surface: 4mm (Mechanical Surface Detection), z = 1.0, 31.0

- Electronics: DAE4 Sn1454; Calibrated: 2017/12/8

- Phantom: SAM2; Type: SAM; Serial: 1640

- DASY52 52.8.8(1222); SEMCAD X 14.6.10(7331)

Body/d=10mm, Pin=250mW/Area Scan (7x11x1): Measurement grid: dx=15mm, dy=15mm

Maximum value of SAR (measured) = 11.9 W/kg

Body/d=10mm, Pin=250mW/Zoom Scan (7x7x7) (7x7x7)/Cube 0: Measurement grid: dx=5mm, dy=5mm, dz=5mm

Reference Value = 89.67 V/m; Power Drift = -0.07 dB

Peak SAR (extrapolated) = 22.0 W/kg

SAR(1 g) = 10.9 W/kg; SAR(10 g) = 5.65 W/kg

Maximum value of SAR (measured) = 12.5 W/kg

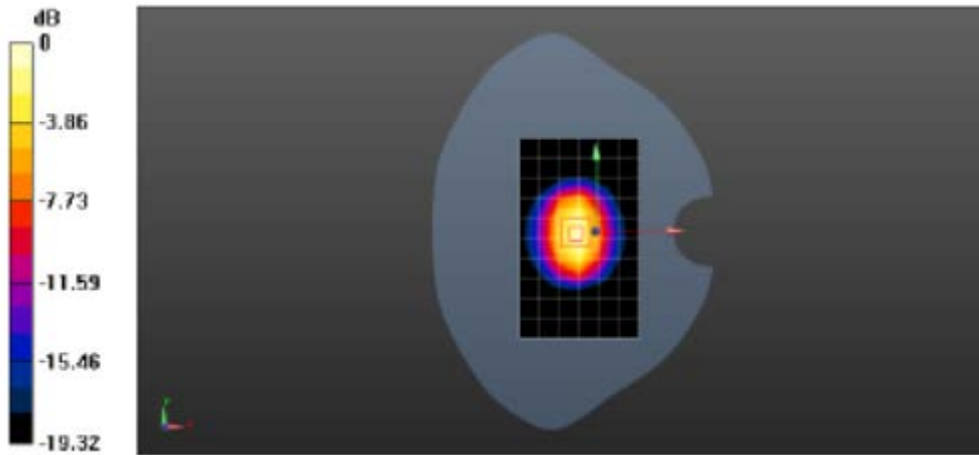

0 dB = 12.5 W/kg = 10.97 dBW/kg

### System Performance Check 2450MHz Head

DUT: D2450V2; Type: D2450V2; Serial: 869

Date/Time: 4/26/2018

Communication System: UID 0, CW; Frequency: 2450 MHz; Duty Cycle: 1:1

Medium: HSL2450; Medium parameters used:  $f = 2450$  MHz;  $\sigma = 1.781$  S/m;  $\epsilon_r = 38.561$ ;  $\rho = 1000$  kg/m<sup>3</sup>

Phantom section: Flat Section

DASY 5 Configuration:

- Probe: EX3DV4 - SN7340; ConvF(7.62, 7.62, 7.62); Calibrated: 2017/12/10;
- Sensor-Surface: 4mm (Mechanical Surface Detection),  $z = 1.0, 31.0$
- Electronics: DAE4 Sn1454; Calibrated: 2017/12/8
- Phantom: SAM1; Type: SAM; Serial: 1912
- DASY52 52.8.8(1222); SEMCAD X 14.6.10(7331)

Body/d=10mm, Pin=250mW/Area Scan (7x11x1): Measurement grid: dx=12mm, dy=12mm

Maximum value of SAR (measured) = 14.0 W/kg

Body/d=10mm, Pin=250mW/Zoom Scan (7x7x7) (7x7x7)/Cube 0: Measurement grid:

dx=5mm, dy=5mm, dz=5mm

Reference Value = 90.42 V/m; Power Drift = -0.10 dB

Peak SAR (extrapolated) = 30.2 W/kg

SAR(1 g) = 13.3 W/kg; SAR(10 g) = 5.98 W/kg

Maximum value of SAR (measured) = 14.9 W/kg

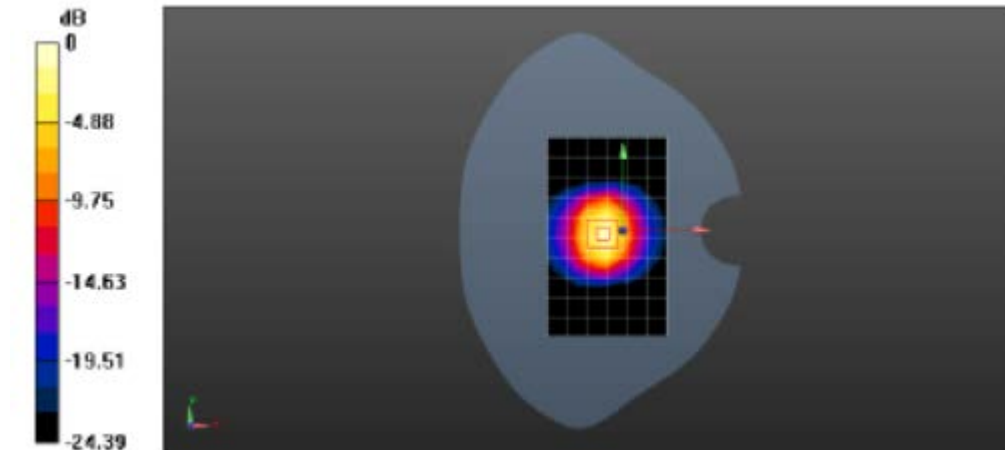

0 dB = 14.9 W/kg = 11.73 dBW/kg

**System Performance Check 2450MHz Body**

DUT: D2450V2; Type: D2450V2; Serial: 869  
Date/Time: 4/27/2018

Communication System: UID 0, CW; Frequency: 2450 MHz;Duty Cycle: 1:1  
Medium: MSL2450;Medium parameters used:  $f = 2450$  MHz;  $\sigma = 1.951$  S/m;  $\epsilon_r = 51.68$ ;  $\rho = 1000$  kg/m<sup>3</sup>  
Phantom section: Flat Section

DASY 5 Configuration:

- Probe: EX3DV4 - SN7340; ConvF(7.38, 7.38, 7.38); Calibrated: 2017/12/10;
- Sensor-Surface: 4mm (Mechanical Surface Detection), z = 1.0, 31.0
- Electronics: DAE4 Sn1454; Calibrated: 2017/12/8
- Phantom: SAM1; Type: SAM; Serial: 1912
- DASY52 52.8.8(1222); SEMCAD X 14.6.10(7331)

Body/d=10mm, Pin=250mW/Area Scan (7x11x1): Measurement grid: dx=12mm, dy=12mm

Maximum value of SAR (measured) = 12.0 W/kg

Body/d=10mm, Pin=250mW/Zoom Scan (7x7x7) (7x7x7)/Cube 0: Measurement grid:  
dx=5mm, dy=5mm, dz=5mm

Reference Value = 80.76 V/m; Power Drift = -0.03 dB

Peak SAR (extrapolated) = 25.6 W/kg

SAR(1 g) = 11.6 W/kg; SAR(10 g) = 5.25 W/kg

Maximum value of SAR (measured) = 13.1 W/kg

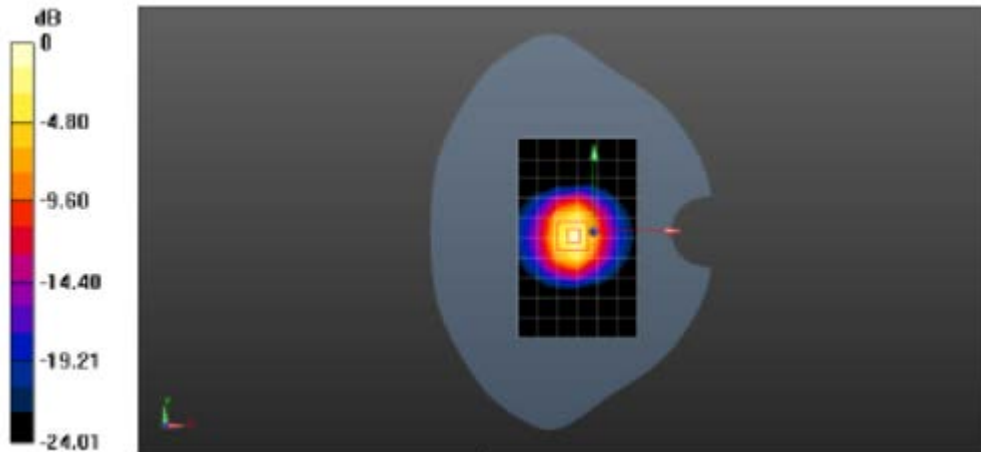

0 dB = 13.1 W/kg = 11.17 dBW/kg

### System Performance Check D5.25GHz Head

DUT: D5GHzV2; Type: D5GHzV2; Serial: 1165

Date/Time: 4/28/2018

Communication System: UID 0, CW (0); Frequency: 5250 MHz;Duty Cycle: 1:1

Medium: HSL5G;Medium parameters used:  $f = 5250$  MHz;  $\sigma = 4.721$  S/m;  $\epsilon_r = 36.011$ ;  $\rho = 1000$  kg/m<sup>3</sup>

Phantom section: Flat Section

DASY 5 Configuration:

- Probe: EX3DV4 - SN3789; ConvF(5, 5, 5); Calibrated: 2018-01-13;
- Sensor-Surface: 1.4mm (Mechanical Surface Detection),  $z = 1.0, 23.0$
- Electronics: DAE4 Sn1374; Calibrated: 2017-08-31
- Phantom: SAM2; Type: SAM; Serial: 1913
- DASY52 52.8.8(1222); SEMCAD X 14.6.10(7331)

Body/d=10mm, Pin=100mW,  $f=5250$  MHz/Area Scan (10x10x1): Measurement grid:  $dx=10$ mm,  $dy=10$ mm

Maximum value of SAR (measured) = 12.2 W/kg

Body/d=10mm, Pin=100mW,  $f=5250$  MHz/Zoom Scan (4x4x1.4mm, graded),  $dist=1.4$ mm (8x8x7)/Cube 0: Measurement grid:  $dx=4$ mm,  $dy=4$ mm,  $dz=1.4$ mm

Reference Value = 66.58 V/m; Power Drift = -0.06 dB

Peak SAR (extrapolated) = 29.3 W/kg

SAR(1 g) = 7.1 W/kg; SAR(10 g) = 2.02 W/kg

Maximum value of SAR (measured) = 16.7 W/kg

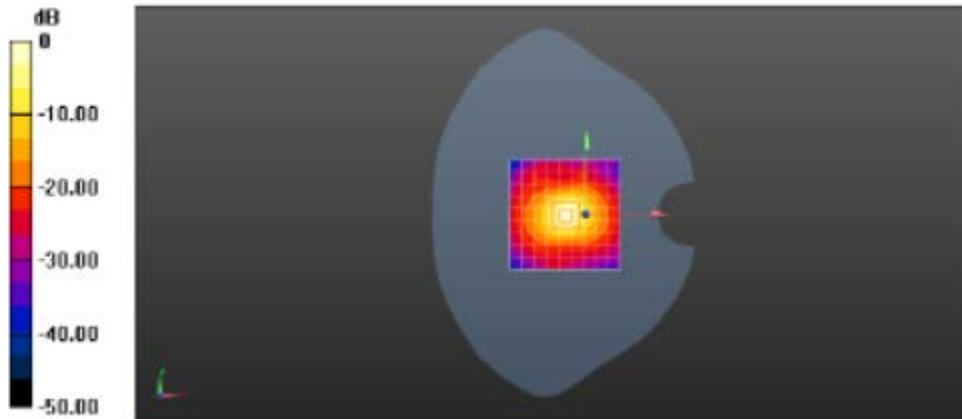

0 dB = 16.7 W/kg = 12.23 dBW/kg

### System Performance Check D5.25GHz Body

DUT: D5GHzV2; Type: D5GHzV2; Serial: 1165

Date/Time: 5/2/2018

Communication System: UID 0, CW (0); Frequency: 5250 MHz; Duty Cycle: 1:1

Medium: MSL5GHz; Medium parameters used:  $f = 5250$  MHz;  $\sigma = 5.426$  S/m;  $\epsilon_r = 48.122$ ;  $\rho = 1000$  kg/m<sup>3</sup>

Phantom section: Flat Section

DASY 5 Configuration:

- Probe: EX3DV4 - SN3789; ConvF(4.64, 4.64, 4.64); Calibrated: 2018-01-13;
- Sensor-Surface: 1.4mm (Mechanical Surface Detection),  $z = -2.0, 23.0$
- Electronics: DAE4 Sn719; Calibrated: 2017-07-06
- Phantom: SAM1; Type: SAM; Serial: 1912
- DASY52 52.8.8(1222); SEMCAD X 14.6.10(7331)

Body/d=10mm, Pin=100mW,  $f=5250$  MHz/Area Scan (10x10x1): Measurement grid:  $dx=10$ mm,  $dy=10$ mm

Maximum value of SAR (measured) = 17.4 W/kg

Body/d=10mm, Pin=100mW,  $f=5250$  MHz/Zoom Scan (4x4x1.4mm, graded),  $dist=1.4$ mm (7x7x7)/Cube 0: Measurement grid:  $dx=4$ mm,  $dy=4$ mm,  $dz=1.4$ mm

Reference Value = 55.64 V/m; Power Drift = -0.04 dB

Peak SAR (extrapolated) = 30.8 W/kg

SAR(1 g) = 7.16 W/kg; SAR(10 g) = 1.95 W/kg

Maximum value of SAR (measured) = 18.3 W/kg

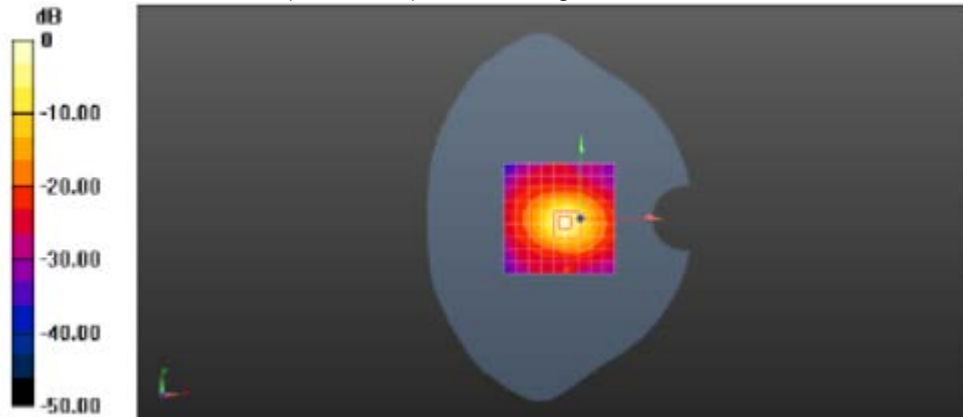

0 dB = 18.3 W/kg = 12.62 dBW/kg

### System Performance Check D5.75GHz Head

DUT: D5GHzV2; Type: D5GHzV2; Serial: 1165

Date/Time: 5/2/2018

Communication System: UID 0, CW (0); Frequency: 5750 MHz;Duty Cycle: 1:1

Medium: HSL5G;Medium parameters used:  $f = 5750$  MHz;  $\sigma = 5.279$  S/m;  $\epsilon_r = 34.695$ ;  $\rho = 1000$  kg/m<sup>3</sup>

Phantom section: Flat Section

DASY 5 Configuration:

- Probe: EX3DV4 - SN3789; ConvF(4.48, 4.48, 4.48); Calibrated: 2018-01-13;
- Sensor-Surface: 1.4mm (Mechanical Surface Detection),  $z = 1.0, 23.0$
- Electronics: DAE4 Sn1374; Calibrated: 2017-08-31
- Phantom: SAM2; Type: SAM; Serial: 1913
- DASY52 52.8.8(1222); SEMCAD X 14.6.10(7331)

Body/d=10mm, Pin=100mW,  $f=5750$  MHz/Area Scan (10x10x1): Measurement grid: dx=10mm, dy=10mm

Maximum value of SAR (measured) = 17.7 W/kg

Body/d=10mm, Pin=100mW,  $f=5750$  MHz/Zoom Scan (4x4x1.4mm, graded), dist=1.4mm (8x8x7)/Cube 0: Measurement grid: dx=4mm, dy=4mm, dz=1.4mm

Reference Value = 62.31 V/m; Power Drift = -0.08 dB

Peak SAR (extrapolated) = 35.2 W/kg

SAR(1 g) = 7.74 W/kg; SAR(10 g) = 2.21 W/kg

Maximum value of SAR (measured) = 18.9 W/kg

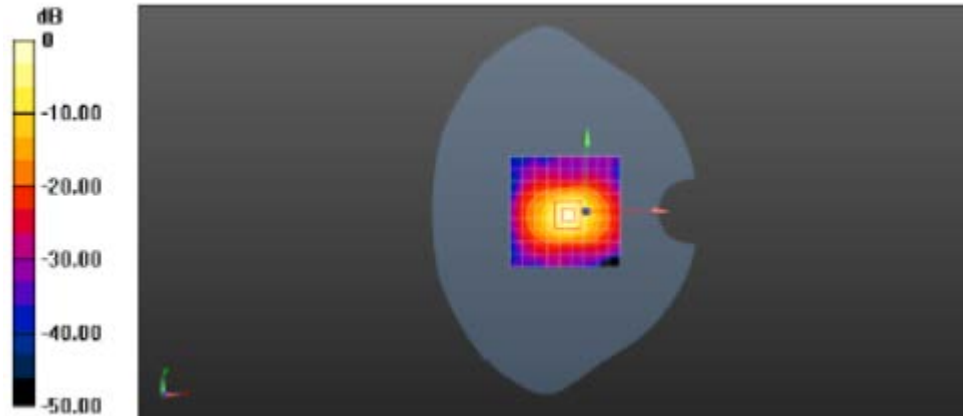

0 dB = 18.9 W/kg = 12.76 dBW/kg



**System Performance Check D5.75GHz Body**

DUT: D5GHzV2; Type: D5GHzV2; Serial: 1165

Date/Time: 5/3/2018

Communication System: UID 0, CW (0); Frequency: 5750 MHz;Duty Cycle: 1:1

Medium: MSL5G;Medium parameters used:  $f = 5750$  MHz;  $\sigma = 5.279$  S/m;  $\epsilon_r = 34.695$ ;  $\rho = 1000$  kg/m<sup>3</sup>

Phantom section: Flat Section

DASY 5 Configuration:

- Probe: EX3DV4 - SN3789; ConvF(4.48, 4.48, 4.48); Calibrated: 2018-01-13;
- Sensor-Surface: 1.4mm (Mechanical Surface Detection),  $z = 1.0, 23.0$
- Electronics: DAE4 Sn1374; Calibrated: 2017-08-31
- Phantom: SAM2; Type: SAM; Serial: 1913
- DASY52 52.8.8(1222); SEMCAD X 14.6.10(7331)

Body/d=10mm, Pin=100mW, f=5750 MHz/Area Scan (10x10x1): Measurement grid: dx=10mm, dy=10mm

Maximum value of SAR (measured) = 17.7 W/kg

Body/d=10mm, Pin=100mW, f=5750 MHz/Zoom Scan (4x4x1.4mm, graded), dist=1.4mm (8x8x7)/Cube 0: Measurement grid: dx=4mm, dy=4mm, dz=1.4mm

Reference Value = 62.31 V/m; Power Drift = -0.08 dB

Peak SAR (extrapolated) = 35.2 W/kg

SAR(1 g) = 7.74 W/kg; SAR(10 g) = 2.21 W/kg

Maximum value of SAR (measured) = 18.9 W/kg

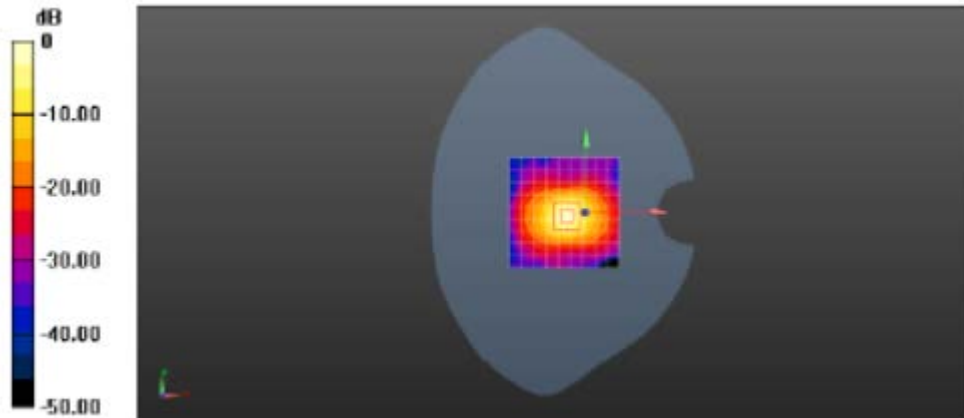

0 dB = 18.9 W/kg = 12.76 dBW/kg

### 5.11. SAR Test Graph Results

SAR plots for the highest measured SAR in each exposure configuration, wireless mode and frequency band combination according to FCC KDB 865664 D02.

#### GSM850 190CH Right touch cheek

Communication System: UID 0, GSM Only Communication System (0); Frequency: 836.6 MHz; Duty Cycle: 1:8.30042

Medium: HSL835; Medium parameters used:  $f = 837$  MHz;  $\sigma = 0.897$  S/m;  $\epsilon_r = 41.911$ ;  $\rho = 1000$  kg/m<sup>3</sup>

Phantom section: Right Section

DASY 5 Configuration:

- Probe: EX3DV4 - SN3962; ConvF(9.78, 9.78, 9.78); Calibrated: 2017-12-19;
- Sensor-Surface: 2mm (Mechanical Surface Detection),  $z = -2.0, 31.0$
- Electronics: DAE4 Sn1267; Calibrated: 2018-02-23
- Phantom: SAM 1; Type: SAM V4.0; Serial: TP-1283
- DASY52 52.8.8(1222); SEMCAD X 14.6.10(7331)

Configuration/Head/Area Scan (8x13x1): Measurement grid:  $dx=15$ mm,  $dy=15$ mm

Maximum value of SAR (measured) = 0.240 W/kg

Configuration/Head/Zoom Scan (5x5x7)/Cube 0: Measurement grid:  $dx=8$ mm,  $dy=8$ mm,  $dz=5$ mm

Reference Value = 4.360 V/m; Power Drift = 0.09 dB

Peak SAR (extrapolated) = 0.256 W/kg

SAR(1 g) = 0.115 W/kg; SAR(10 g) = 0.069 W/kg

Maximum value of SAR (measured) = 0.239 W/kg

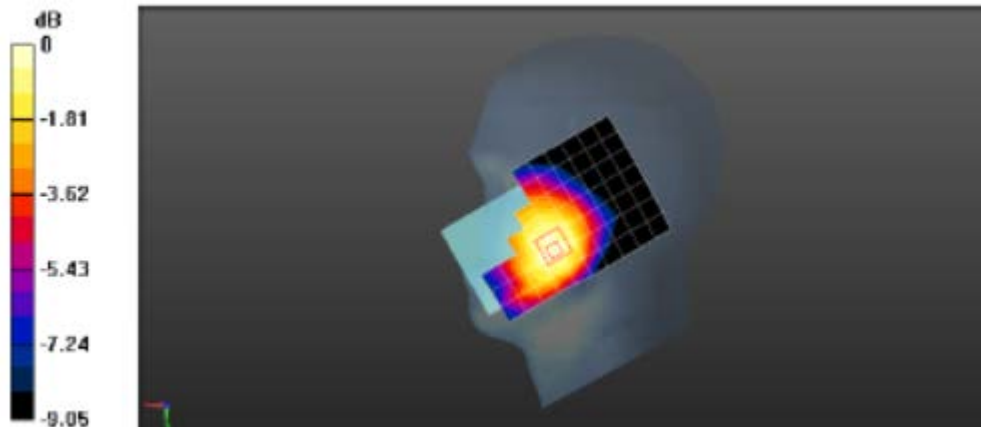

0 dB = 0.239 W/kg = -6.22 dBW/kg

### GSM850 GPRS 4TS 251CH Back side 0mm

Communication System: UID 0, GPRS/EGPRS Mode(4up) Communication System (0); Frequency: 848.6 MHz; Duty Cycle: 1:2.0797

Medium: MSL835; Medium parameters used:  $f = 849$  MHz;  $\sigma = 0.996$  S/m;  $\epsilon_r = 54.042$ ;  $\rho = 1000$  kg/m<sup>3</sup>

Phantom section: Flat Section

DASY 5 Configuration:

- Probe: ES3DV3 - SN3297; ConvF(6.08, 6.08, 6.08); Calibrated: 2017/10/14;
- Sensor-Surface: 4mm (Mechanical Surface Detection),  $z = 2.0, 32.0$
- Electronics: DAE4 Sn1267; Calibrated: 2018/2/5
- Phantom: SAM1; Type: SAM; Serial: 1912
- DASY52 52.8.8(1222); SEMCAD X 14.6.10(7331)

Configuration/Body/Area Scan (8x13x1): Measurement grid:  $dx=15$ mm,  $dy=15$ mm

Maximum value of SAR (measured) = 1.164 W/kg

Configuration/Body/Zoom Scan (5x5x7)/Cube 0: Measurement grid:  $dx=8$ mm,  $dy=8$ mm,  $dz=5$ mm

Reference Value = 30.08 V/m; Power Drift = 0.06 dB

Peak SAR (extrapolated) = 1.24 W/kg

SAR(1 g) = 1.14 W/kg; SAR(10 g) = 0.944 W/kg

Maximum value of SAR (measured) = 1.180 W/kg

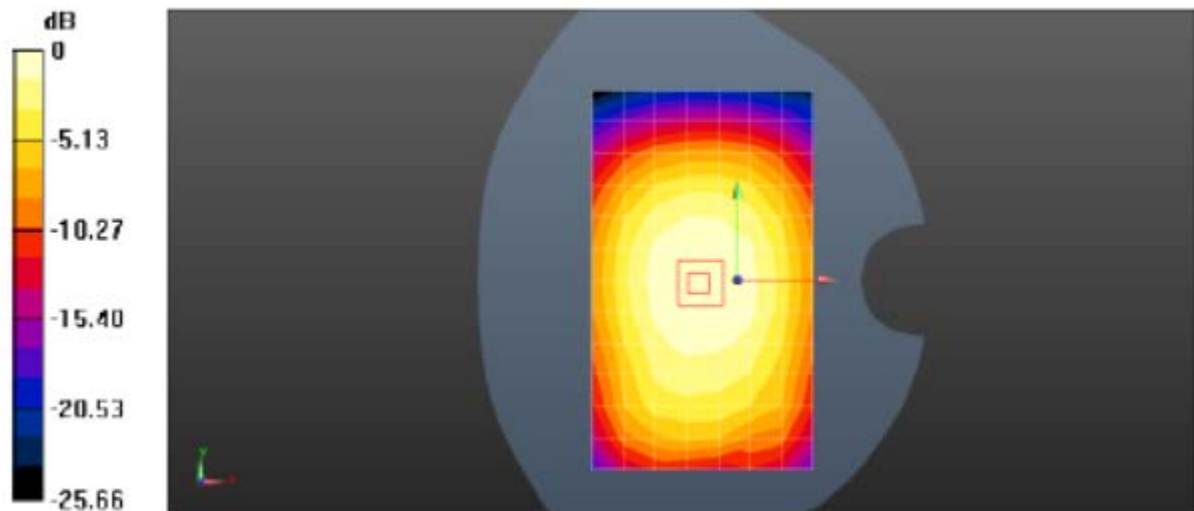

0 dB = 1.186 W/kg = 0.74 dBW/kg

### GSM1900 661CH Left touch cheek

Cycle: 1:8.30042

Medium: HSL1900; Medium parameters used:  $f = 1880$  MHz;  $\sigma = 1.353$  S/m;  $\epsilon_r = 39.559$ ;  $\rho = 1000$  kg/m<sup>3</sup>

Phantom section: Left Section

DASY 5 Configuration:

- Probe: EX3DV4 - SN7340; ConvF(8.15, 8.15, 8.15); Calibrated: 2017/12/10;
- Sensor-Surface: 4mm (Mechanical Surface Detection),  $z = 1.0, 31.0$
- Electronics: DAE4 Sn1454; Calibrated: 2017/12/8
- Phantom: SAM2; Type: SAM; Serial: 1640
- DASY52 52.8.8(1222); SEMCAD X 14.6.10(7331)

Configuration/Head/Area Scan (8x13x1): Measurement grid:  $dx=15$ mm,  $dy=15$ mm

Maximum value of SAR (measured) = 0.419 W/kg

Configuration/Head/Zoom Scan (5x5x7)/Cube 0: Measurement grid:  $dx=8$ mm,  $dy=8$ mm,  $dz=5$ mm

Reference Value = 7.829 V/m; Power Drift = 0.03 dB

Peak SAR (extrapolated) = 0.583 W/kg

SAR(1 g) = 0.184 W/kg; SAR(10 g) = 0.050 W/kg

Maximum value of SAR (measured) = 0.229 W/kg

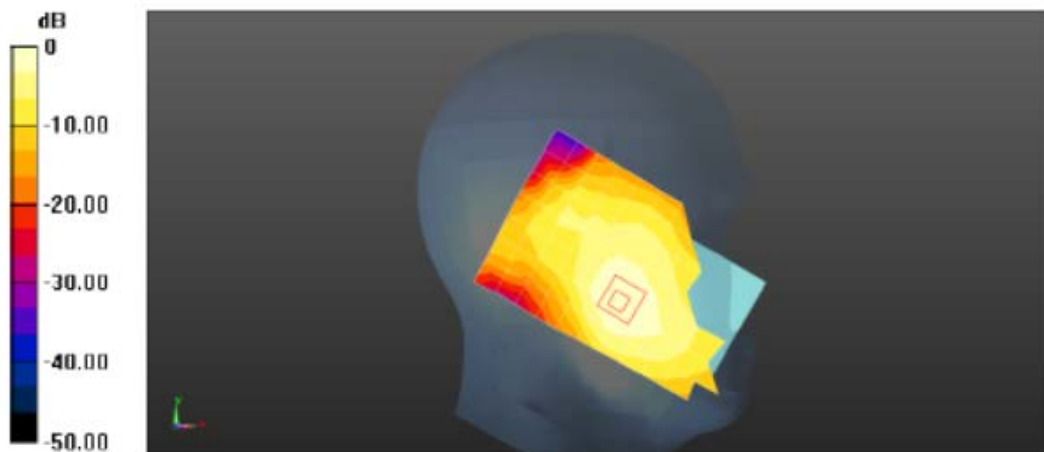

0 dB = 0.229 W/kg = -6.40 dBW/kg

**GSM1900 GPRS 3TS 661CH Back side 0mm**

Communication System: UID 0, GPRS/EGPRS Mode(3up) Communication System (0); Frequency: 1880 MHz; Duty Cycle: 1:2.77013

Medium: MSL1900; Medium parameters used:  $f = 1880$  MHz;  $\sigma = 1.493$  S/m;  $\epsilon_r = 52.273$ ;  $\rho = 1000$  kg/m<sup>3</sup>

Phantom section: Flat Section

DASY 5 Configuration:

- Probe: EX3DV4 - SN7340; ConvF(7.51, 7.51, 7.51); Calibrated: 2017/12/10;
- Sensor-Surface: 4mm (Mechanical Surface Detection),  $z = 1.0, 31.0$
- Electronics: DAE4 Sn1454; Calibrated: 2017/12/8
- Phantom: SAM2; Type: SAM; Serial: 1640
- DASY52 52.8.8(1222); SEMCAD X 14.6.10(7331)

Configuration/Body/Area Scan (8x13x1): Measurement grid:  $dx=15$ mm,  $dy=15$ mm

Maximum value of SAR (measured) = 0.449 W/kg

Configuration/Body/Zoom Scan (5x5x7)/Cube 0: Measurement grid:  $dx=8$ mm,  $dy=8$ mm,  $dz=5$ mm

Reference Value = 7.659 V/m; Power Drift = -0.09 dB

Peak SAR (extrapolated) = 0.946 W/kg

SAR(1 g) = 0.540 W/kg; SAR(10 g) = 0.295 W/kg

Maximum value of SAR (measured) = 0.595 W/kg

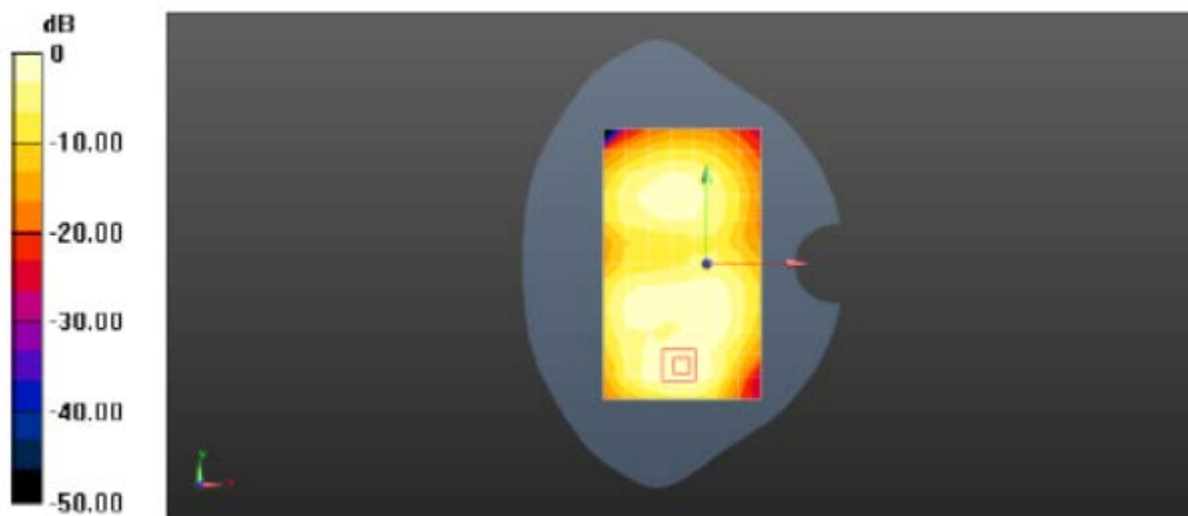

0 dB = 0.449 W/kg = -3.48 dBW/kg

### WCDMA Band5 4182CH Right touch cheek

Communication System: UID 0, WCDMA (0); Frequency: 836.4 MHz;Duty Cycle: 1:1

Medium: HSL835;Medium parameters used (interpolated):  $f = 836.4$  MHz;  $\sigma = 0.922$  S/m;  $\epsilon_r = 42.128$ ;  $\rho = 1000$  kg/m<sup>3</sup>

Phantom section: Right Section

DASY 5 Configuration:

- Probe: EX3DV4 - SN7340; ConvF(9.56, 9.56, 9.56); Calibrated: 2017/12/10;
- Sensor-Surface: 4mm (Mechanical Surface Detection),  $z = 1.0, 31.0$
- Electronics: DAE4 Sn1454; Calibrated: 2017/12/8
- Phantom: SAM2; Type: SAM; Serial: 1640
- DASY52 52.8.8(1222); SEMCAD X 14.6.10(7331)

Configuration/Head/Area Scan (8x13x1): Measurement grid:  $dx=15$ mm,  $dy=15$ mm

Info: Interpolated medium parameters used for SAR evaluation.

Maximum value of SAR (measured) = 0.189 W/kg

Configuration/Head/Zoom Scan (5x5x7)/Cube 0: Measurement grid:  $dx=8$ mm,  $dy=8$ mm,  $dz=5$ mm

Reference Value = 9.876 V/m; Power Drift = -0.04 dB

Peak SAR (extrapolated) = 0.187 W/kg

SAR(1 g) = 0.132 W/kg; SAR(10 g) = 0.051 W/kg

Info: Interpolated medium parameters used for SAR evaluation.

Maximum value of SAR (measured) = 0.188 W/kg

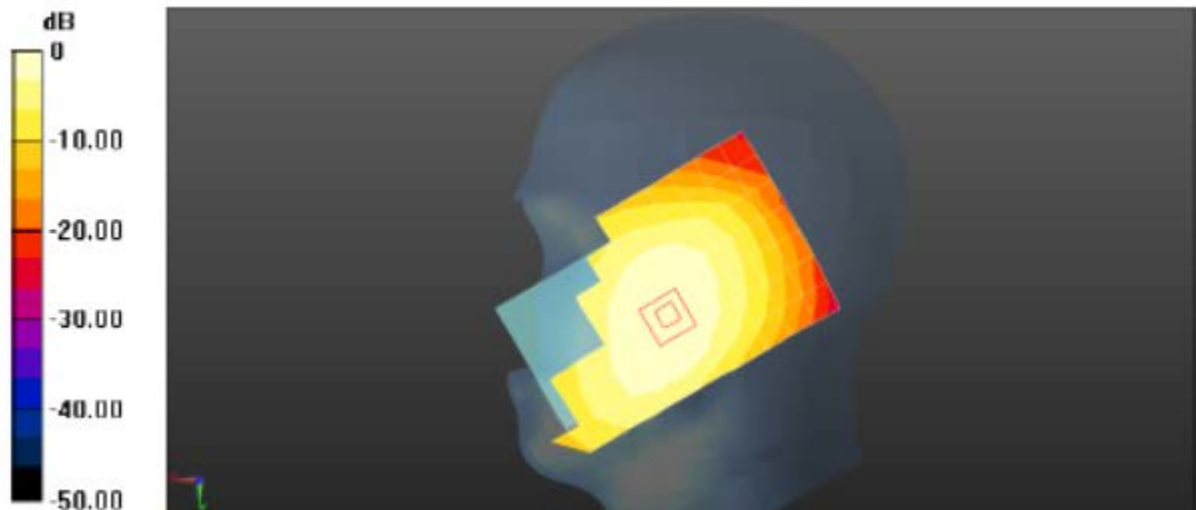

0 dB = 0.189 W/kg = -7.24 dBW/kg

### WCDMA Band5 4182CH Back side 0mm

Communication System: UID 0, WCDMA (0); Frequency: 836.4 MHz; Duty Cycle: 1:1

Medium: MSL835; Medium parameters used (interpolated):  $f = 836.4$  MHz;  $\sigma = 0.983$  S/m;  $\epsilon_r = 54.156$ ;  $\rho = 1000$  kg/m<sup>3</sup>

Phantom section: Flat Section

DASY 5 Configuration:

- Probe: EX3DV4 - SN7340; ConvF(9.83, 9.83, 9.83); Calibrated: 2017/12/10;
- Sensor-Surface: 4mm (Mechanical Surface Detection),  $z = 1.0, 31.0$
- Electronics: DAE4 Sn1454; Calibrated: 2017/12/8
- Phantom: SAM2; Type: SAM; Serial: 1640
- DASY52 52.8.8(1222); SEMCAD X 14.6.10(7331)

Configuration/Body/Area Scan (8x13x1): Measurement grid:  $dx=15$ mm,  $dy=15$ mm

Info: Interpolated medium parameters used for SAR evaluation.

Maximum value of SAR (measured) = 0.627 W/kg

Configuration/Body/Zoom Scan (5x5x7)/Cube 0: Measurement grid:  $dx=8$ mm,  $dy=8$ mm,  $dz=5$ mm

Reference Value = 25.23 V/m; Power Drift = 0.02 dB

Peak SAR (extrapolated) = 0.738 W/kg

SAR(1 g) = 0.598 W/kg; SAR(10 g) = 0.457 W/kg

Info: Interpolated medium parameters used for SAR evaluation.

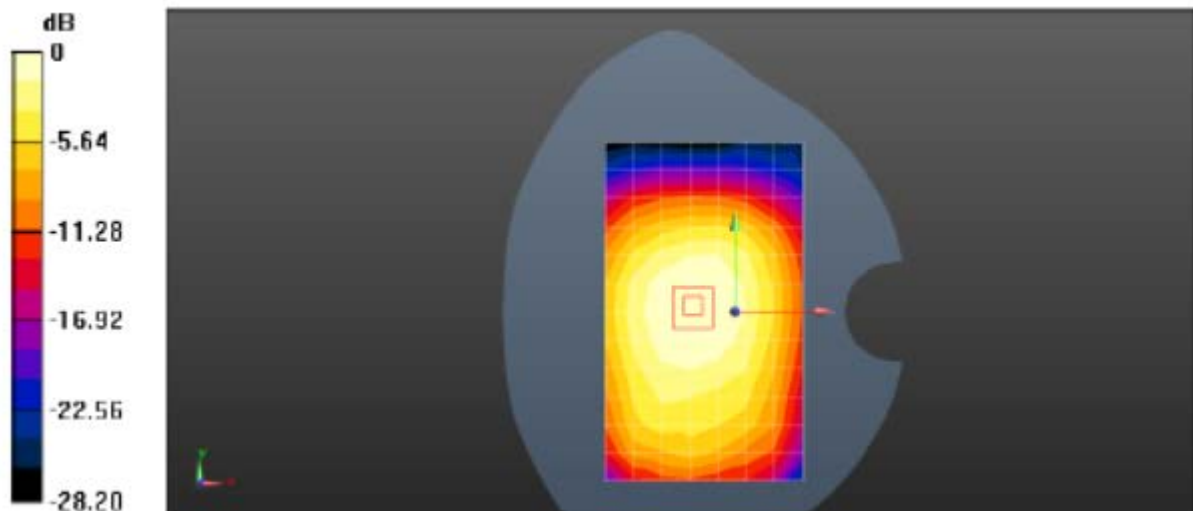

0 dB = 0.627 W/kg = -2.03 dBW/kg

### WCDMA Band2 9400CH Left touch cheek

Communication System: UID 0, WCDMA (0); Frequency: 1880 MHz;Duty Cycle: 1:1

Medium: HSL1900;Medium parameters used:  $f = 1880$  MHz;  $\sigma = 1.419$  S/m;  $\epsilon_r = 40.582$ ;  $\rho = 1000$  kg/m<sup>3</sup>

Phantom section: Left Section

DASY 5 Configuration:

- Probe: EX3DV4 - SN7340; ConvF(8.15, 8.15, 8.15); Calibrated: 2017/12/10;
- Sensor-Surface: 4mm (Mechanical Surface Detection),  $z = 1.0, 31.0$
- Electronics: DAE4 Sn1454; Calibrated: 2017/12/8
- Phantom: SAM2; Type: SAM; Serial: 1640
- DASY52 52.8.8(1222); SEMCAD X 14.6.10(7331)Configuration/Head/Area Scan (8x13x1): Measurement grid:  $dx=15$ mm,  $dy=15$ mm

Info: Interpolated medium parameters used for SAR evaluation.

Maximum value of SAR (measured) = 0.133 W/kg

Configuration/Head/Zoom Scan (5x5x7)/Cube 0: Measurement grid:  $dx=8$ mm,  $dy=8$ mm,  $dz=5$ mm

Reference Value = 5.577 V/m; Power Drift = 0.04 dB

Peak SAR (extrapolated) = 0.414 W/kg

SAR(1 g) = 0.118 W/kg; SAR(10 g) = 0.057 W/kg

Info: Interpolated medium parameters used for SAR evaluation.

Maximum value of SAR (measured) = 0.128 W/kg

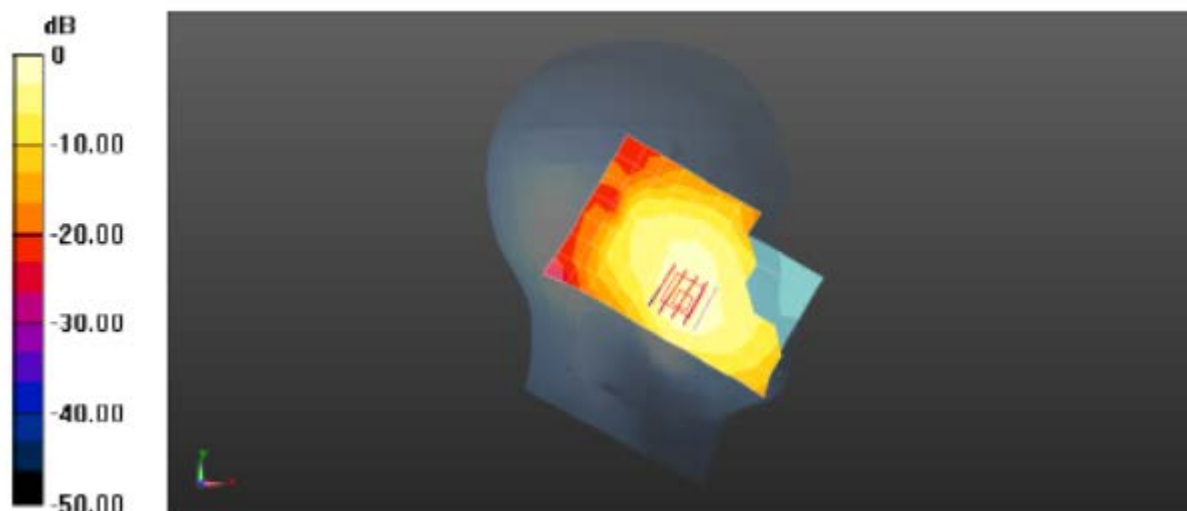

0 dB = 0.133 W/kg = -8.76 dBW/kg



### WCDMA Band2 9400CH Back side 0mm

Communication System: UID 0, WCDMA (0); Frequency: 1880 MHz; Duty Cycle: 1:1  
Medium: MSL1900; Medium parameters used:  $f = 1880$  MHz;  $\sigma = 1.493$  S/m;  $\epsilon_r = 52.273$ ;  $\rho = 1000$  kg/m<sup>3</sup>  
Phantom section: Flat Section

DASY 5 Configuration:

- Probe: EX3DV4 - SN7340; ConvF(7.51, 7.51, 7.51); Calibrated: 2017/12/10;
- Sensor-Surface: 4mm (Mechanical Surface Detection),  $z = 1.0, 31.0$
- Electronics: DAE4 Sn1454; Calibrated: 2017/12/8
- Phantom: SAM2; Type: SAM; Serial: 1640
- DASY52 52.8.8(1222); SEMCAD X 14.6.10(7331)

Configuration/Body/Area Scan (8x13x1): Measurement grid:  $dx=15$ mm,  $dy=15$ mm

Maximum value of SAR (measured) = 0.485 W/kg

Configuration/Body/Zoom Scan (5x5x7)/Cube 0: Measurement grid:  $dx=8$ mm,  $dy=8$ mm,  $dz=5$ mm

Reference Value = 9.953 V/m; Power Drift = 0.06 dB

Peak SAR (extrapolated) = 0.665 W/kg

SAR(1 g) = 0.451 W/kg; SAR(10 g) = 0.294 W/kg

Maximum value of SAR (measured) = 0.481 W/kg

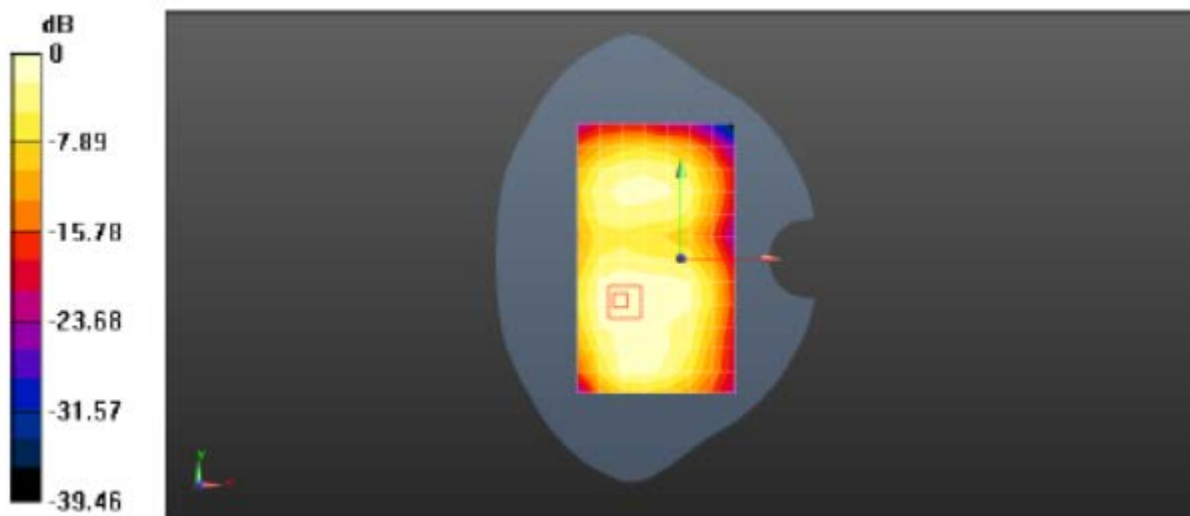

0 dB = 0.485 W/kg = -3.14 dBW/kg

**LTE Band5 10MHz bandwidth QPSK 1RB0Offset 20600CH Right touch cheek**

Communication System: UID 0, LTE-FDD BW 10MHZ (0); Frequency: 844 MHz;Duty Cycle: 1:1  
Medium: HSL835;Medium parameters used: f = 844 MHz;  $\sigma = 0.921$  S/m;  $\epsilon_r = 42.236$ ;  $\rho = 1000$  kg/m<sup>3</sup>  
Phantom section: Right Section

DASY 5 Configuration:

- Probe: EX3DV4 - SN7340; ConvF(9.56, 9.56, 9.56); Calibrated: 2017/12/10;
- Sensor-Surface: 4mm (Mechanical Surface Detection), z = 1.0, 31.0
- Electronics: DAE4 Sn1454; Calibrated: 2017/12/8
- Phantom: SAM2; Type: SAM; Serial: 1640
- DASY52 52.8.8(1222); SEMCAD X 14.6.10(7331)

Configuration/Head/Area Scan (8x13x1): Measurement grid: dx=15mm, dy=15mm

Maximum value of SAR (measured) = 0.153 W/kg

Configuration/Head/Zoom Scan (5x5x7)/Cube 0: Measurement grid: dx=8mm, dy=8mm, dz=5mm

Reference Value = 8.887 V/m; Power Drift = 0.00 dB

Peak SAR (extrapolated) = 0.672 W/kg

SAR(1 g) = 0.147 W/kg; SAR(10 g) = 0.057 W/kg

Maximum value of SAR (measured) = 0.173 W/kg

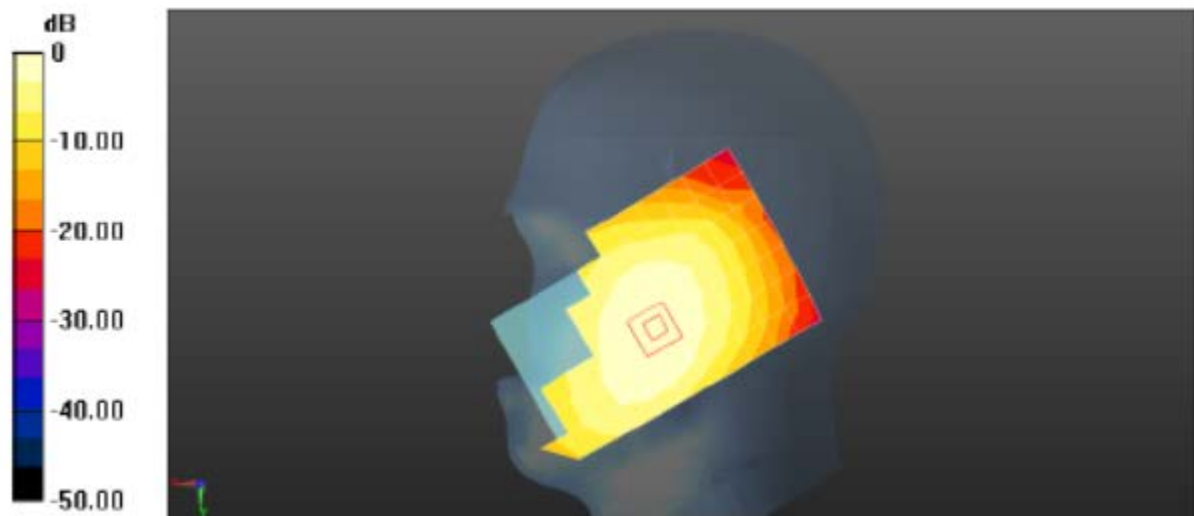

0 dB = 0.153 W/kg = -8.15 dBW/kg

### LTE Band5 10MHz bandwidth QPSK 1RB0Offset 20600CH Back side 0mm

Communication System: UID 0, LTE-FDD BW 10MHZ (0); Frequency: 844 MHz;Duty Cycle: 1:1  
Medium: HSL835;Medium parameters used:  $f = 844$  MHz;  $\sigma = 0.99$  S/m;  $\epsilon_r = 54.088$ ;  $\rho = 1000$  kg/m<sup>3</sup>

Phantom section: Flat Section

DASY 5 Configuration:

- Probe: EX3DV4 - SN7340; ConvF(9.83, 9.83, 9.83); Calibrated: 2017/12/10;
- Sensor-Surface: 4mm (Mechanical Surface Detection),  $z = 1.0, 31.0$
- Electronics: DAE4 Sn1454; Calibrated: 2017/12/8
- Phantom: SAM2; Type: SAM; Serial: 1640
- DASY52 52.8.8(1222); SEMCAD X 14.6.10(7331)

Configuration/Body/Area Scan (8x13x1): Measurement grid:  $dx=15$ mm,  $dy=15$ mm

Maximum value of SAR (measured) = 0.716 W/kg

Configuration/Body/Zoom Scan (5x5x7)/Cube 0: Measurement grid:  $dx=8$ mm,  $dy=8$ mm,  $dz=5$ mm

Reference Value = 26.61 V/m; Power Drift = 0.02 dB

Peak SAR (extrapolated) = 0.853 W/kg

SAR(1 g) = 0.694 W/kg; SAR(10 g) = 0.534 W/kg

Maximum value of SAR (measured) = 0.726 W/kg

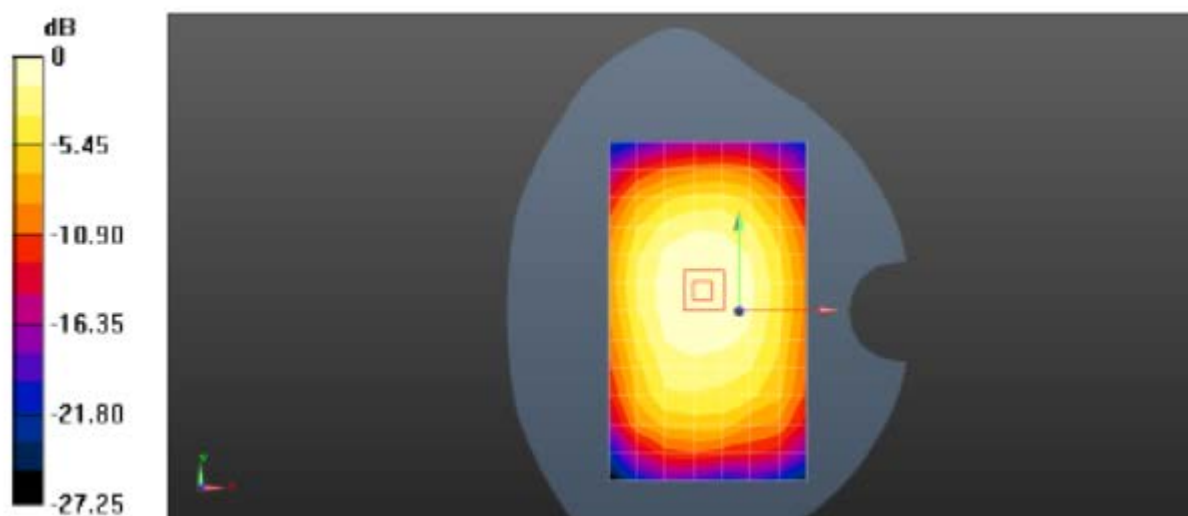

0 dB = 0.716 W/kg = -1.45 dBW/kg

### 802.11b 6CH Right touch cheek

Communication System: UID 0, WI-FI(2.4GHz) (0); Frequency: 2437 MHz;Duty Cycle: 1:1  
Medium: HSL2450;Medium parameters used: f = 2437 MHz;  $\sigma = 1.761$  S/m;  $\epsilon_r = 38.593$ ;  $\rho = 1000$  kg/m<sup>3</sup>  
Phantom section: Right Section  
DASY 5 Configuration:  
• Probe: EX3DV4 - SN7340; ConvF(7.62, 7.62, 7.62); Calibrated: 2017/12/10;  
• Sensor-Surface: 4mm (Mechanical Surface Detection), z = 1.0, 31.0  
• Electronics: DAE4 Sn1454; Calibrated: 2017/12/8  
• Phantom: SAM1; Type: SAM; Serial: 1912  
• DASY52 52.8.8(1222); SEMCAD X 14.6.10(7331)  
Configuration/Head/Area Scan (8x13x1): Measurement grid: dx=15mm, dy=15mm  
Maximum value of SAR (measured) = 0.783 W/kg  
Configuration/Head/Zoom Scan (5x5x7)/Cube 0: Measurement grid: dx=8mm, dy=8mm, dz=5mm  
Reference Value = 11.65 V/m; Power Drift = -0.01 dB  
Peak SAR (extrapolated) = 1.96 W/kg  
SAR(1 g) = 0.825 W/kg; SAR(10 g) = 0.429 W/kg  
Maximum value of SAR (measured) = 0.970 W/kg

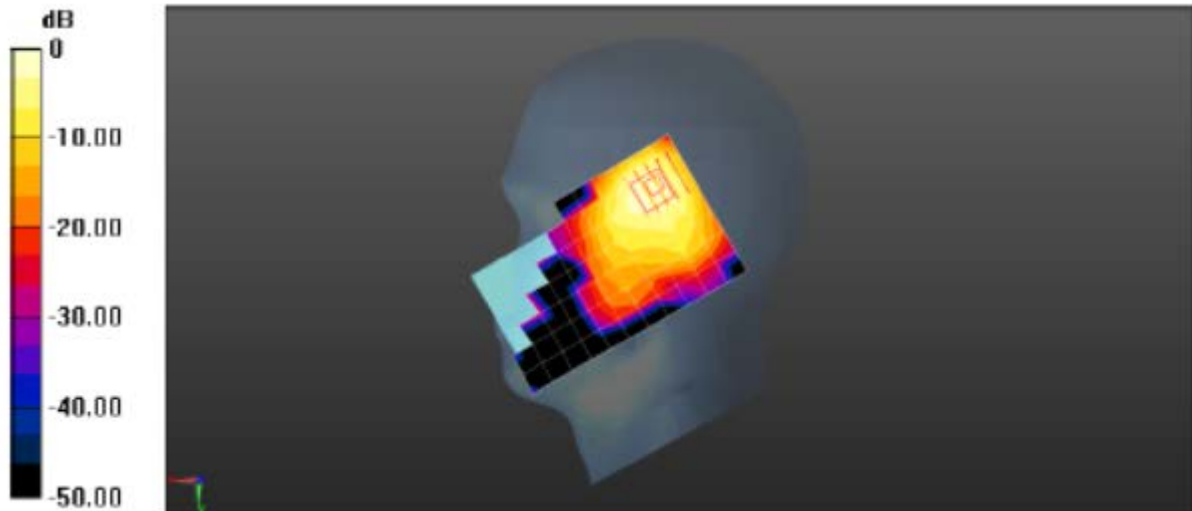

0 dB = 0.783 W/kg = -1.06 dBW/kg

### 802.11b 6CH Back side 0mm

Communication System: UID 0, WI-FI(2.4GHz) (0); Frequency: 2437 MHz;Duty Cycle: 1:1  
Medium: MSL2450;Medium parameters used:  $f = 2437$  MHz;  $\sigma = 1.934$  S/m;  $\epsilon_r = 51.752$ ;  $\rho = 1000$  kg/m<sup>3</sup>  
Phantom section: Flat Section

DASY 5 Configuration:

- Probe: EX3DV4 - SN7340; ConvF(7.38, 7.38, 7.38); Calibrated: 2017/12/10;
- Sensor-Surface: 4mm (Mechanical Surface Detection),  $z = 1.0, 31.0$
- Electronics: DAE4 Sn1454; Calibrated: 2017/12/8
- Phantom: SAM1; Type: SAM; Serial: 1912
- DASY52 52.8.8(1222); SEMCAD X 14.6.10(7331)

Configuration/Body/Area Scan (9x16x1): Measurement grid:  $dx=12$ mm,  $dy=12$ mm

Maximum value of SAR (measured) = 0.247 W/kg

Configuration/Body/Zoom Scan (7x7x7)/Cube 0: Measurement grid:  $dx=5$ mm,  $dy=5$ mm,  $dz=5$ mm

Reference Value = 2.532 V/m; Power Drift = 0.05 dB

Peak SAR (extrapolated) = 0.424 W/kg

SAR(1 g) = 0.241 W/kg; SAR(10 g) = 0.126 W/kg

Maximum value of SAR (measured) = 0.272 W/kg

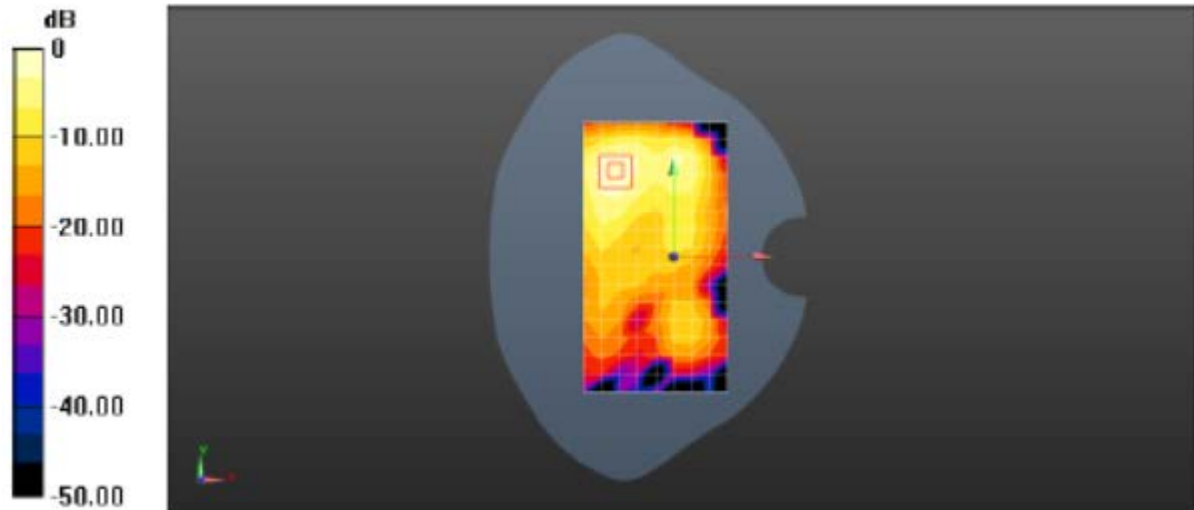

0 dB = 0.247 W/kg = -6.07 dBW/kg

### WIFI 802.11n40 46CH Left cheek

Communication System: UID 0, WI-FI(5GHz) (0); Frequency: 5230 MHz;Duty Cycle: 1:1  
Medium: HSL5G;Medium parameters used:  $f = 5230$  MHz;  $\sigma = 4.681$  S/m;  $\epsilon_r = 36.564$ ;  $\rho = 1000$  kg/m<sup>3</sup>

Phantom section: Left Section

DASY 5 Configuration:

- Probe: EX3DV4 - SN3789; ConvF(4.48, 4.48, 4.48); Calibrated: 2018-01-13;
- Sensor-Surface: 1.4mm (Mechanical Surface Detection),  $z = 1.0, 23.0$
- Electronics: DAE4 Sn1374; Calibrated: 2017-08-31
- Phantom: SAM2; Type: SAM; Serial: 1913
- DASY52 52.8.8(1222); SEMCAD X 14.6.10(7331)

Configuration/Head/Area Scan (12x19x1): Measurement grid:  $dx=10$ mm,  $dy=10$ mm

Maximum value of SAR (measured) = 0.347 W/kg

Configuration/Head/Zoom Scan (7x7x12)/Cube 0: Measurement grid:  $dx=4$ mm,  $dy=4$ mm,  $dz=2$ mm

Reference Value = 5.740 V/m; Power Drift = -0.10 dB

Peak SAR (extrapolated) = 0.756 W/kg

SAR(1 g) = 0.373 W/kg; SAR(10 g) = 0.127 W/kg

Maximum value of SAR (measured) = 0.507 W/kg

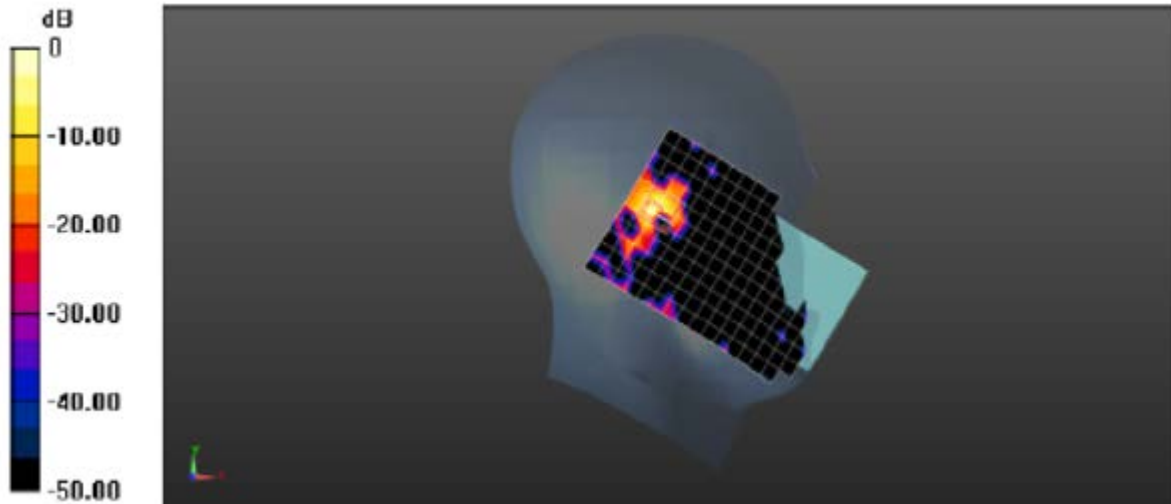

0 dB = 0.507 W/kg = -2.95 dBW/kg

### Wi-Fi 5G 802.11n40 Ch159 Back side 0mm

Communication System: UID 0, WI-FI(5GHz) (0); Frequency: 5795 MHz;Duty Cycle: 1:1  
Medium: MSL5G;Medium parameters used:  $f = 5795$  MHz;  $\sigma = 6.032$  S/m;  $\epsilon_r = 46.467$ ;  $\rho = 1000$  kg/m<sup>3</sup>

Phantom section: Flat Section

DASY 5 Configuration:

- Probe: EX3DV4 - SN3789; ConvF(4.27, 4.27, 4.27); Calibrated: 2018-01-13;
- Sensor-Surface: 1.4mm (Mechanical Surface Detection),  $z = -2.0, 23.0$
- Electronics: DAE4 Sn1374; Calibrated: 2017-08-23
- Phantom: SAM1; Type: SAM; Serial: 1912
- DASY52 52.8.8(1222); SEMCAD X 14.6.10(7331)

Configuration/Body/Area Scan (11x18x1): Measurement grid:  $dx=10$ mm,  $dy=10$ mm

Maximum value of SAR (measured) = 0.0942 W/kg

Configuration/Body/Zoom Scan (7x7x12)/Cube 0: Measurement grid:  $dx=4$ mm,  $dy=4$ mm,  $dz=2$ mm

Reference Value = 1.304 V/m; Power Drift = -0.08 dB

Peak SAR (extrapolated) = 0.193 W/kg

SAR(1 g) = 0.081 W/kg; SAR(10 g) = 0.023 W/kg

Maximum value of SAR (measured) = 0.0985 W/kg

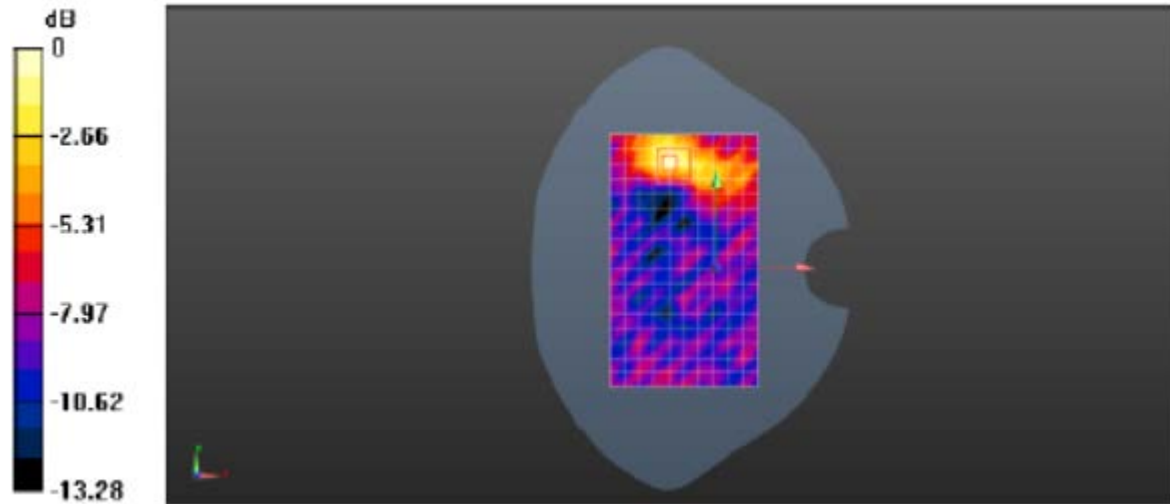

0 dB = 0.0985 W/kg = -10.07 dBW/kg

## 6. Calibration Certificate

### 6.1. Probe Calibration Certificate



In Collaboration with  
**s p e a g**  
CALIBRATION LABORATORY



中国认可  
国际互认  
校准  
CALIBRATION  
CNAS L0570

Add: No.51 Xueyuan Road, Haidian District, Beijing, 100191, China  
Tel: +86-10-62304633-2218 Fax: +86-10-62304633-2209  
E-mail: cttl@chinattl.com Http://www.chinattl.cn

Client

CIQ(Shenzhen)

Certificate No: Z17-97110

#### CALIBRATION CERTIFICATE

Object EX3DV4 - SN:3842

Calibration Procedure(s) FF-Z11-004-01  
Calibration Procedures for Dosimetric E-field Probes

Calibration date: August 15, 2017

This calibration Certificate documents the traceability to national standards, which realize the physical units of measurements(SI). The measurements and the uncertainties with confidence probability are given on the following pages and are part of the certificate.

All calibrations have been conducted in the closed laboratory facility: environment temperature(22±3)°C and humidity<70%.

Calibration Equipment used (M&TE critical for calibration)

Primary Standards	ID #	Cal Date(Calibrated by, Certificate No.)	Scheduled Calibration
Power Meter NRP2	101919	27-Jun-17 (CTTL, No.J17X05857)	Jun-18
Power sensor NRP-Z91	101547	27-Jun-17 (CTTL, No.J17X05857)	Jun-18
Power sensor NRP-Z91	101548	27-Jun-17 (CTTL, No.J17X05857)	Jun-18
Reference10dBAttenuator	18N50W-10dB	13-Mar-16(CTTL,No.J16X01547)	Mar-18
Reference20dBAttenuator	18N50W-20dB	13-Mar-16(CTTL, No.J16X01548)	Mar-18
Reference Probe EX3DV4	SN 7433	26-Sep-16(SPEAG,No.EX3-7433_Sep16)	Sep-17
DAE4	SN 549	13-Dec-16(SPEAG, No.DAE4-549_Dec16)	Dec -17
Secondary Standards	ID #	Cal Date(Calibrated by, Certificate No.)	Scheduled Calibration
SignalGeneratorMG3700A	6201052605	27-Jun-17 (CTTL, No.J17X05858)	Jun-18
Network Analyzer E5071C	MY46110673	13-Jan-17 (CTTL, No.J17X00285)	Jan -18

	Name	Function	Signature
Calibrated by:	Yu Zongying	SAR Test Engineer	
Reviewed by:	Lin Hao	SAR Test Engineer	
Approved by:	Qi Dianyuan	SAR Project Leader	

Issued: August 16, 2017

This calibration certificate shall not be reproduced except in full without written approval of the laboratory.





Add: No.51 Xueyuan Road, Haidian District, Beijing, 100191, China  
 Tel: +86-10-62304633-2218 Fax: +86-10-62304633-2209  
 E-mail: cttl@chinattl.com Http://www.chinattl.cn

### Glossary:

TSL	tissue simulating liquid
NORM <sub>x,y,z</sub>	sensitivity in free space
ConvF	sensitivity in TSL / NORM <sub>x,y,z</sub>
DCP	diode compression point
CF	crest factor (1/duty_cycle) of the RF signal
A,B,C,D	modulation dependent linearization parameters
Polarization $\Phi$	$\Phi$ rotation around probe axis
Polarization $\theta$	$\theta$ rotation around an axis that is in the plane normal to probe axis (at measurement center), $i$ $\theta=0$ is normal to probe axis

Connector Angle information used in DASY system to align probe sensor X to the robot coordinate system

### Calibration is Performed According to the Following Standards:

- IEEE Std 1528-2013, "IEEE Recommended Practice for Determining the Peak Spatial-Averaged Specific Absorption Rate (SAR) in the Human Head from Wireless Communications Devices: Measurement Techniques", June 2013
- IEC 62209-1, "Measurement procedure for the assessment of Specific Absorption Rate (SAR) from hand-held and body-mounted devices used next to the ear (frequency range of 300 MHz to 6 GHz)", July 2016
- IEC 62209-2, "Procedure to determine the Specific Absorption Rate (SAR) for wireless communication devices used in close proximity to the human body (frequency range of 30 MHz to 6 GHz)", March 2010
- KDB 865664, "SAR Measurement Requirements for 100 MHz to 6 GHz"

### Methods Applied and Interpretation of Parameters:

- NORM<sub>x,y,z</sub>**: Assessed for E-field polarization  $\theta=0$  ( $f \leq 900$  MHz in TEM-cell;  $f > 1800$  MHz: waveguide). NORM<sub>x,y,z</sub> are only intermediate values, i.e., the uncertainties of NORM<sub>x,y,z</sub> does not effect the  $E^2$ -field uncertainty inside TSL (see below ConvF).
- NORM(f)<sub>x,y,z</sub>** = NORM<sub>x,y,z</sub> \* frequency\_response (see Frequency Response Chart). This linearization is implemented in DASY4 software versions later than 4.2. The uncertainty of the frequency response is included in the stated uncertainty of ConvF.
- DCP<sub>x,y,z</sub>**: DCP are numerical linearization parameters assessed based on the data of power sweep (no uncertainty required). DCP does not depend on frequency nor media.
- PAR**: PAR is the Peak to Average Ratio that is not calibrated but determined based on the signal characteristics.
- A<sub>x,y,z</sub>; B<sub>x,y,z</sub>; C<sub>x,y,z</sub>; VR<sub>x,y,z</sub>; A,B,C** are numerical linearization parameters assessed based on the data of power sweep for specific modulation signal. The parameters do not depend on frequency nor media. VR is the maximum calibration range expressed in RMS voltage across the diode.
- ConvF and Boundary Effect Parameters**: Assessed in flat phantom using E-field (or Temperature Transfer Standard for  $f \leq 800$  MHz) and inside waveguide using analytical field distributions based on power measurements for  $f > 800$  MHz. The same setups are used for assessment of the parameters applied for boundary compensation (alpha, depth) of which typical uncertainty valued are given. These parameters are used in DASY4 software to improve probe accuracy close to the boundary. The sensitivity in TSL corresponds to NORM<sub>x,y,z</sub> \* ConvF whereby the uncertainty corresponds to that given for ConvF. A frequency dependent ConvF is used in DASY version 4.4 and higher which allows extending the validity from  $\pm 50$  MHz to  $\pm 100$  MHz.
- Spherical isotropy (3D deviation from isotropy)**: in a field of low gradients realized using a flat phantom exposed by a patch antenna.
- Sensor Offset**: The sensor offset corresponds to the offset of virtual measurement center from the probe tip (on probe axis). No tolerance required.
- Connector Angle**: The angle is assessed using the information gained by determining the NORM<sub>x</sub> (no uncertainty required).

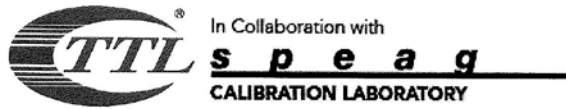

Add: No.51 Xueyuan Road, Haidian District, Beijing, 100191, China  
Tel: +86-10-62304633-2218 Fax: +86-10-62304633-2209  
E-mail: [ctl@chinattl.com](mailto:ctl@chinattl.com) [Http://www.chinattl.cn](http://www.chinattl.cn)

# Probe EX3DV4

## SN: 3842

Calibrated: August 15, 2017

Calibrated for DASY/EASY Systems

(Note: non-compatible with DASY2 system!)



Add: No.51 Xueyuan Road, Haidian District, Beijing, 100191, China  
Tel: +86-10-62304633-2218 Fax: +86-10-62304633-2209  
E-mail: cttl@chinattl.com [Http://www.chinattl.cn](http://www.chinattl.cn)

## DASY/EASY – Parameters of Probe: EX3DV4 – SN: 3842

### Basic Calibration Parameters

	Sensor X	Sensor Y	Sensor Z	Unc (k=2)
Norm( $\mu V/(V/m)^2$ ) <sup>A</sup>	0.34	0.53	0.42	±10.0%
DCP(mV) <sup>B</sup>	102.3	102.6	101.2	

### Modulation Calibration Parameters

UID	Communication System Name		A dB	B dB $\sqrt{\mu V}$	C	D dB	VR mV	Unc <sup>E</sup> (k=2)
0	CW	X	0.0	0.0	1.0	0.00	137.4	±2.1%
		Y	0.0	0.0	1.0		176.2	
		Z	0.0	0.0	1.0		153.3	

The reported uncertainty of measurement is stated as the standard uncertainty of Measurement multiplied by the coverage factor k=2, which for a normal distribution Corresponds to a coverage probability of approximately 95%.

<sup>A</sup> The uncertainties of Norm X, Y, Z do not affect the E<sup>2</sup>-field uncertainty inside TSL (see Page 5 and Page 6).

<sup>B</sup> Numerical linearization parameter: uncertainty not required.

<sup>E</sup> Uncertainty is determined using the max. deviation from linear response applying rectangular distribution and is expressed for the square of the field value.



Add: No.51 Xueyuan Road, Haidian District, Beijing, 100191, China  
 Tel: +86-10-62304633-2218 Fax: +86-10-62304633-2209  
 E-mail: cttl@chinattl.com [Http://www.chinattl.cn](http://www.chinattl.cn)

## DASY/EASY – Parameters of Probe: EX3DV4 – SN: 3842

### Calibration Parameter Determined in Head Tissue Simulating Media

f [MHz] <sup>C</sup>	Relative Permittivity <sup>F</sup>	Conductivity (S/m) <sup>F</sup>	ConvF X	ConvF Y	ConvF Z	Alpha <sup>G</sup>	Depth <sup>G</sup> (mm)	Unct. (k=2)
750	41.9	0.89	9.41	9.41	9.41	0.30	0.90	± 12.1%
900	41.5	0.97	9.15	9.15	9.15	0.16	1.37	± 12.1%
1750	40.1	1.37	7.89	7.89	7.89	0.23	1.09	± 12.1%
1900	40.0	1.40	7.58	7.58	7.58	0.20	1.19	± 12.1%
2450	39.2	1.80	6.92	6.92	6.92	0.32	1.16	± 12.1%
2600	39.0	1.96	6.78	6.78	6.78	0.40	0.93	± 12.1%

<sup>C</sup> Frequency validity above 300 MHz of ±100MHz only applies for DASY v4.4 and higher (Page 2), else it is restricted to ±50MHz. The uncertainty is the RSS of ConvF uncertainty at calibration frequency and the uncertainty for the indicated frequency band. Frequency validity below 300 MHz is ± 10, 25, 40, 50 and 70 MHz for ConvF assessments at 30, 64, 128, 150 and 220 MHz respectively. Above 5 GHz frequency validity can be extended to ± 110 MHz.

<sup>F</sup> At frequency below 3 GHz, the validity of tissue parameters ( $\epsilon$  and  $\sigma$ ) can be relaxed to ±10% if liquid compensation formula is applied to measured SAR values. At frequencies above 3 GHz, the validity of tissue parameters ( $\epsilon$  and  $\sigma$ ) is restricted to ±5%. The uncertainty is the RSS of the ConvF uncertainty for indicated target tissue parameters.

<sup>G</sup> Alpha/Depth are determined during calibration. SPEAG warrants that the remaining deviation due to the boundary effect after compensation is always less than ± 1% for frequencies below 3 GHz and below ± 2% for the frequencies between 3-6 GHz at any distance larger than half the probe tip diameter from the boundary.



Add: No.51 Xueyuan Road, Haidian District, Beijing, 100191, China  
Tel: +86-10-62304633-2218 Fax: +86-10-62304633-2209  
E-mail: cttl@chinattl.com [Http://www.chinattl.cn](http://www.chinattl.cn)

## DASY/EASY – Parameters of Probe: EX3DV4 – SN: 3842

### Calibration Parameter Determined in Body Tissue Simulating Media

f [MHz] <sup>C</sup>	Relative Permittivity <sup>F</sup>	Conductivity (S/m) <sup>F</sup>	ConvF X	ConvF Y	ConvF Z	Alpha <sup>G</sup>	Depth <sup>G</sup> (mm)	Unct. (k=2)
750	55.5	0.96	9.31	9.31	9.31	0.30	0.90	±12.1%
900	55.0	1.05	9.02	9.02	9.02	0.24	1.15	±12.1%
1750	53.4	1.49	7.57	7.57	7.57	0.23	1.12	±12.1%
1900	53.3	1.52	7.32	7.32	7.32	0.22	1.21	±12.1%
2450	52.7	1.95	7.01	7.01	7.01	0.42	1.04	±12.1%
2600	52.5	2.16	6.97	6.97	6.97	0.42	1.01	±12.1%

<sup>C</sup> Frequency validity above 300 MHz of ±100MHz only applies for DASY v4.4 and higher (Page 2), else it is restricted to ±50MHz. The uncertainty is the RSS of ConvF uncertainty at calibration frequency and the uncertainty for the indicated frequency band. Frequency validity below 300 MHz is ± 10, 25, 40, 50 and 70 MHz for ConvF assessments at 30, 64, 128, 150 and 220 MHz respectively. Above 5 GHz frequency validity can be extended to ± 110 MHz.

<sup>F</sup> At frequency below 3 GHz, the validity of tissue parameters ( $\epsilon$  and  $\sigma$ ) can be relaxed to ±10% if liquid compensation formula is applied to measured SAR values. At frequencies above 3 GHz, the validity of tissue parameters ( $\epsilon$  and  $\sigma$ ) is restricted to ±5%. The uncertainty is the RSS of the ConvF uncertainty for indicated target tissue parameters.

<sup>G</sup> Alpha/Depth are determined during calibration. SPEAG warrants that the remaining deviation due to the boundary effect after compensation is always less than ± 1% for frequencies below 3 GHz and below ± 2% for the frequencies between 3-6 GHz at any distance larger than half the probe tip diameter from the boundary.



Add: No.51 Xueyuan Road, Haidian District, Beijing, 100191, China  
Tel: +86-10-62304633-2218 Fax: +86-10-62304633-2209  
E-mail: cttl@chinattl.com [Http://www.chinattl.cn](http://www.chinattl.cn)

### Frequency Response of E-Field (TEM-Cell: ifi110 EXX, Waveguide: R22)

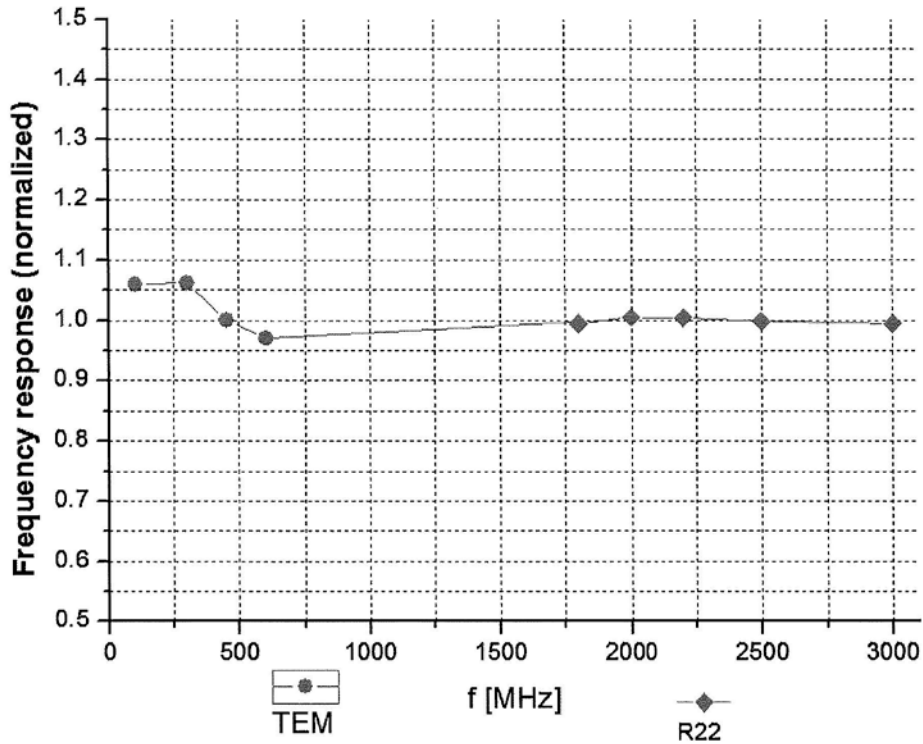

Uncertainty of Frequency Response of E-field:  $\pm 7.4\%$  (k=2)



Add: No.51 Xueyuan Road, Haidian District, Beijing, 100191, China  
Tel: +86-10-62304633-2218 Fax: +86-10-62304633-2209  
E-mail: cttl@chinattl.com [Http://www.chinattl.cn](http://www.chinattl.cn)

### Receiving Pattern ( $\Phi$ ), $\theta=0^\circ$

**f=600 MHz, TEM**

**f=1800 MHz, R22**

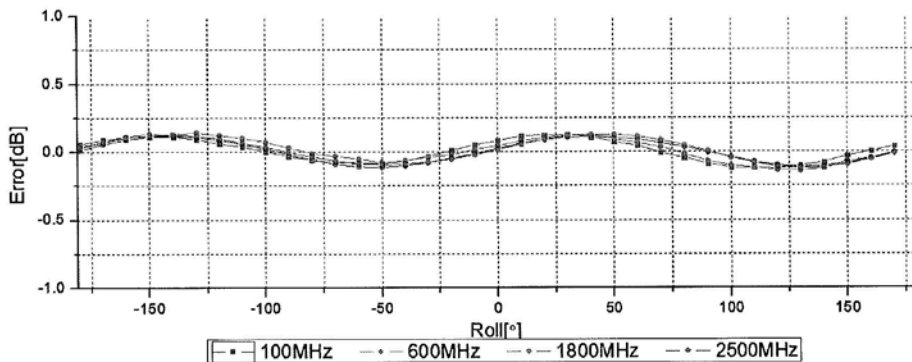
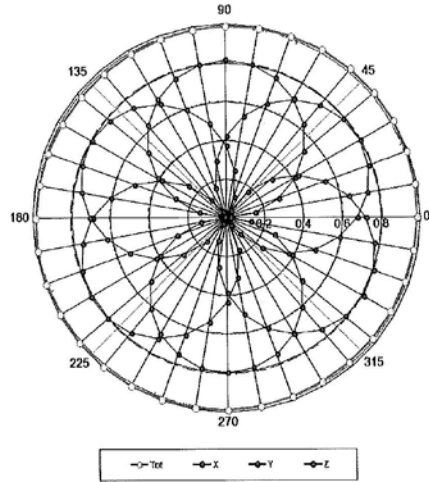
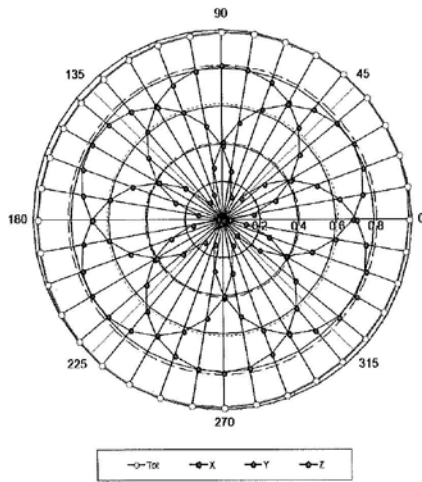

Uncertainty of Axial Isotropy Assessment:  $\pm 1.2\%$  (k=2)

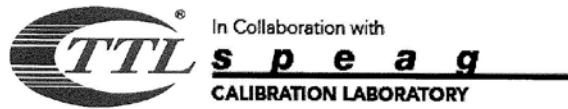

Add: No.51 Xueyuan Road, Haidian District, Beijing, 100191, China  
 Tel: +86-10-62304633-2218 Fax: +86-10-62304633-2209  
 E-mail: cttl@chinattl.com Http://www.chinattl.cn

### Dynamic Range f(SAR<sub>head</sub>) (TEM cell, f = 900 MHz)

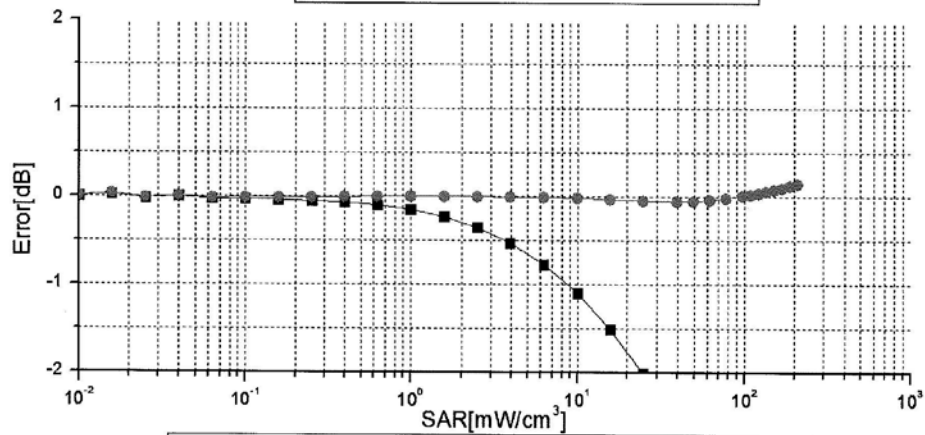
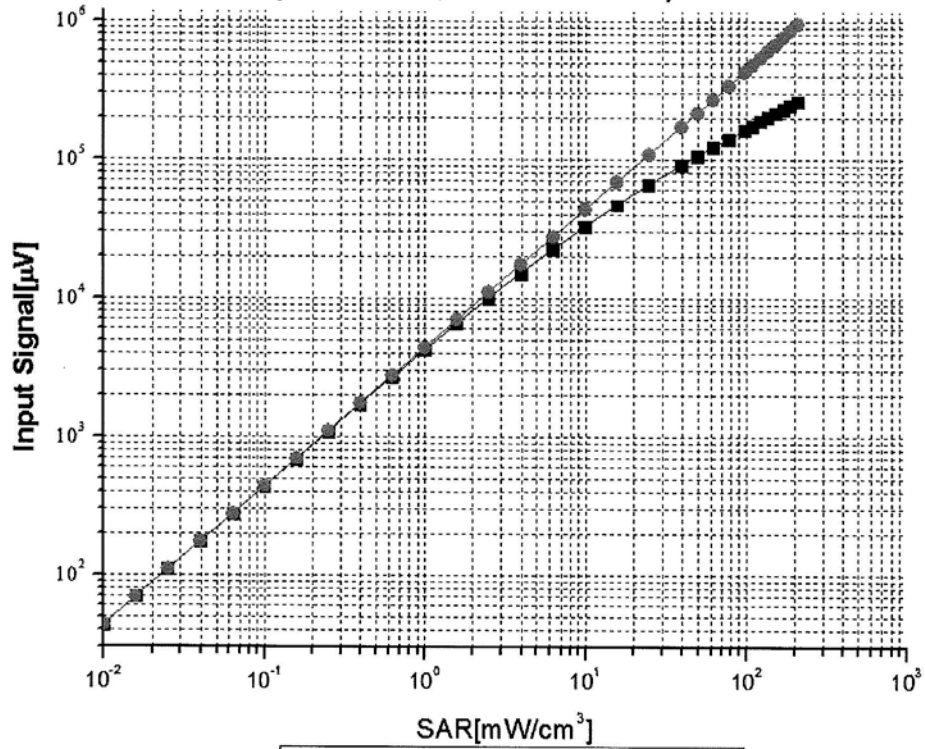

Uncertainty of Linearity Assessment: ±0.9% (k=2)



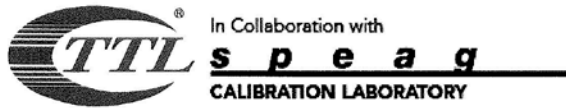

Add: No.51 Xueyuan Road, Haidian District, Beijing, 100191, China  
Tel: +86-10-62304633-2218 Fax: +86-10-62304633-2209  
E-mail: cttl@chinattl.com [Http://www.chinattl.cn](http://www.chinattl.cn)

## Conversion Factor Assessment

f=750 MHz, WGLS R9(H\_convF)

f=1750 MHz, WGLS R22(H\_convF)

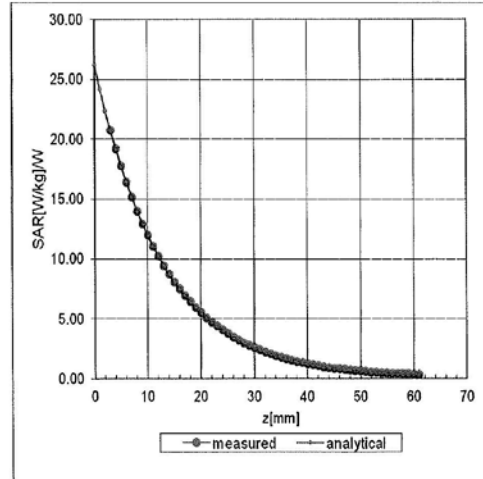
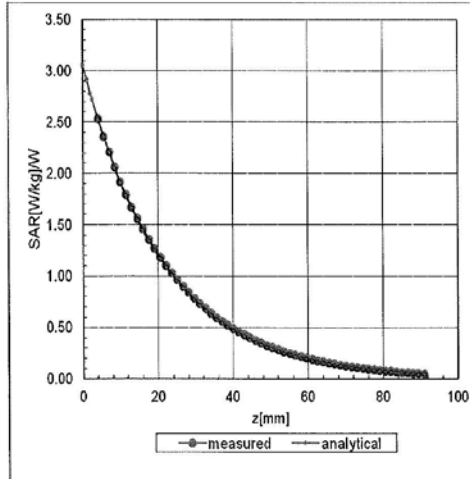

## Deviation from Isotropy in Liquid

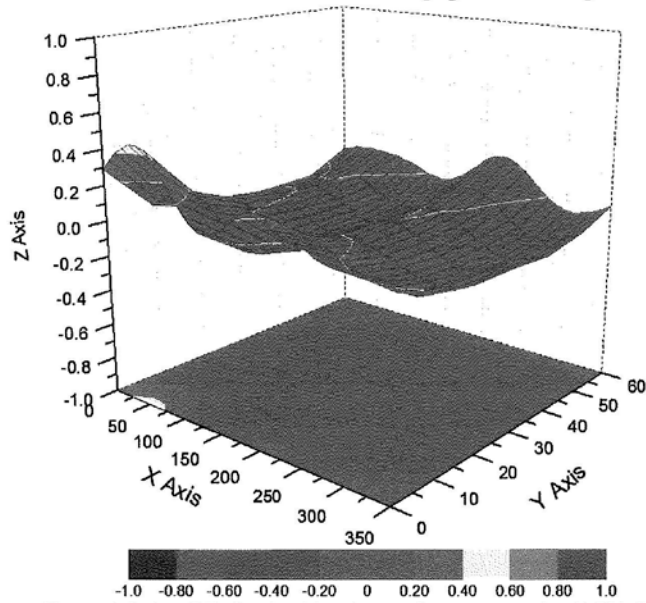

Uncertainty of Spherical Isotropy Assessment:  $\pm 3.2\%$  (K=2)



Add: No.51 Xueyuan Road, Haidian District, Beijing, 100191, China  
Tel: +86-10-62304633-2218 Fax: +86-10-62304633-2209  
E-mail: cttl@chinattl.com [Http://www.chinattl.cn](http://www.chinattl.cn)

## DASY/EASY – Parameters of Probe: EX3DV4 – SN: 3842

### Other Probe Parameters

<b>Sensor Arrangement</b>	<b>Triangular</b>
<b>Connector Angle (°)</b>	<b>67.2</b>
<b>Mechanical Surface Detection Mode</b>	<b>enabled</b>
<b>Optical Surface Detection Mode</b>	<b>disable</b>
<b>Probe Overall Length</b>	<b>337mm</b>
<b>Probe Body Diameter</b>	<b>10mm</b>
<b>Tip Length</b>	<b>9mm</b>
<b>Tip Diameter</b>	<b>2.5mm</b>
<b>Probe Tip to Sensor X Calibration Point</b>	<b>1mm</b>
<b>Probe Tip to Sensor Y Calibration Point</b>	<b>1mm</b>
<b>Probe Tip to Sensor Z Calibration Point</b>	<b>1mm</b>
<b>Recommended Measurement Distance from Surface</b>	<b>1.4mm</b>

## 6.2. D900V2 Dipole Calibration Certificate



In Collaboration with  
**s p e a g**  
CALIBRATION LABORATORY



中国认可  
国际互认  
校准  
CALIBRATION  
CNAS L0570

Add: No.51 Xueyuan Road, Haidian District, Beijing, 100191, China  
Tel: +86-10-62304633-2079 Fax: +86-10-62304633-2504  
E-mail: cttl@chinattl.com [Http://www.chinattl.cn](http://www.chinattl.cn)

Client

NTI

Certificate No: Z16-97154

### CALIBRATION CERTIFICATE

Object: D900V2 - SN: 1d141

Calibration Procedure(s):  
FD-Z11-003-01  
Calibration Procedures for dipole validation kits

Calibration date: October 11, 2016

This calibration Certificate documents the traceability to national standards, which realize the physical units of measurements(SI). The measurements and the uncertainties with confidence probability are given on the following pages and are part of the certificate.

All calibrations have been conducted in the closed laboratory facility: environment temperature(22±3)°C and humidity<70%.

Calibration Equipment used (M&TE critical for calibration)

Primary Standards	ID #	Cal Date(Calibrated by, Certificate No.)	Scheduled Calibration
Power Meter NRP2	101919	27-Jun-16 (CTTL, No.J16X04777)	Jun-17
Power sensor NRP-Z91	101547	27-Jun-16 (CTTL, No.J16X04777)	Jun-17
Reference Probe ES3DV3	SN 3149	15-Apr-16(CTTL-SPEAG,No.J16-97035)	Apr-17
DAE4	SN 777	22-Aug-16(CTTL-SPEAG,No.Z16-97138)	Aug-17
Secondary Standards	ID #	Cal Date(Calibrated by, Certificate No.)	Scheduled Calibration
Signal Generator E4438C	MY49071430	01-Feb-16 (CTTL, No.J16X00893)	Jan-17
Network Analyzer E5071C	MY46110673	26-Jan-16 (CTTL, No.J16X00894)	Jan-17

	Name	Function	Signature
Calibrated by:	Zhao Jing	SAR Test Engineer	
Reviewed by:	Qi Dianyuan	SAR Project Leader	
Approved by:	Liu Wei	Deputy Director of SEM Department	

This calibration certificate shall not be reproduced except in full without written approval of the laboratory.

Issued: October 14, 2016

Certificate No: Z16-97154

Page 1 of 8

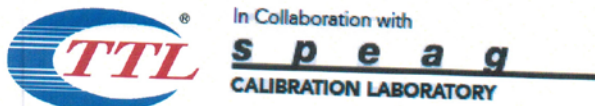

Add: No.51 Xueyuan Road, Haidian District, Beijing, 100191, China  
 Tel: +86-10-62304633-2079 Fax: +86-10-62304633-2504  
 E-mail: cttl@chinattl.com Http://www.chinattl.cn

**Glossary:**

TSL	tissue simulating liquid
ConvF	sensitivity in TSL / NORM <sub>x,y,z</sub>
N/A	not applicable or not measured

**Calibration is Performed According to the Following Standards:**

- a) IEEE Std 1528-2013, "IEEE Recommended Practice for Determining the Peak Spatial-Averaged Specific Absorption Rate (SAR) in the Human Head from Wireless Communications Devices: Measurement Techniques", June 2013
- b) IEC 62209-1, "Procedure to measure the Specific Absorption Rate (SAR) For hand-held devices used in close proximity to the ear (frequency range of 300MHz to 3GHz)", February 2005
- c) IEC 62209-2, "Procedure to measure the Specific Absorption Rate (SAR) For wireless communication devices used in close proximity to the human body (frequency range of 30MHz to 6GHz)", March 2010
- d) KDB865664, SAR Measurement Requirements for 100 MHz to 6 GHz

**Additional Documentation:**

- e) DASY4/5 System Handbook

**Methods Applied and Interpretation of Parameters:**

- *Measurement Conditions:* Further details are available from the Validation Report at the end of the certificate. All figures stated in the certificate are valid at the frequency indicated.
- *Antenna Parameters with TSL:* The dipole is mounted with the spacer to position its feed point exactly below the center marking of the flat phantom section, with the arms oriented parallel to the body axis.
- *Feed Point Impedance and Return Loss:* These parameters are measured with the dipole positioned under the liquid filled phantom. The impedance stated is transformed from the measurement at the SMA connector to the feed point. The Return Loss ensures low reflected power. No uncertainty required.
- *Electrical Delay:* One-way delay between the SMA connector and the antenna feed point. No uncertainty required.
- *SAR measured:* SAR measured at the stated antenna input power.
- *SAR normalized:* SAR as measured, normalized to an input power of 1 W at the antenna connector.
- *SAR for nominal TSL parameters:* The measured TSL parameters are used to calculate the nominal SAR result.

The reported uncertainty of measurement is stated as the standard uncertainty of Measurement multiplied by the coverage factor k=2, which for a normal distribution Corresponds to a coverage probability of approximately 95%.



Add: No.51 Xueyuan Road, Haidian District, Beijing, 100191, China  
Tel: +86-10-62304633-2079 Fax: +86-10-62304633-2504  
E-mail: cttl@chinattl.com Http://www.chinattl.cn

**Measurement Conditions**

DASY system configuration, as far as not given on page 1.

DASY Version	DASY52	52.8.8.1258
Extrapolation	Advanced Extrapolation	
Phantom	Triple Flat Phantom 5.1C	
Distance Dipole Center - TSL	15 mm	with Spacer
Zoom Scan Resolution	dx, dy, dz = 5 mm	
Frequency	900 MHz ± 1 MHz	

**Head TSL parameters**

The following parameters and calculations were applied.

	Temperature	Permittivity	Conductivity
Nominal Head TSL parameters	22.0 °C	41.5	0.97 mho/m
Measured Head TSL parameters	(22.0 ± 0.2) °C	41.3 ± 6 %	0.96 mho/m ± 6 %
Head TSL temperature change during test	<1.0 °C	----	----

**SAR result with Head TSL**

SAR averaged over 1 cm <sup>3</sup> (1 g) of Head TSL	Condition	
SAR measured	250 mW input power	2.64 mW / g
SAR for nominal Head TSL parameters	normalized to 1W	10.6 mW / g ± 20.8 % (k=2)
SAR averaged over 10 cm <sup>3</sup> (10 g) of Head TSL	Condition	
SAR measured	250 mW input power	1.70 mW / g
SAR for nominal Head TSL parameters	normalized to 1W	6.83 mW / g ± 20.4 % (k=2)

**Body TSL parameters**

The following parameters and calculations were applied.

	Temperature	Permittivity	Conductivity
Nominal Body TSL parameters	22.0 °C	55.0	1.05 mho/m
Measured Body TSL parameters	(22.0 ± 0.2) °C	55.2 ± 6 %	1.04 mho/m ± 6 %
Body TSL temperature change during test	<1.0 °C	----	----

**SAR result with Body TSL**

SAR averaged over 1 cm <sup>3</sup> (1 g) of Body TSL	Condition	
SAR measured	250 mW input power	2.69 mW / g
SAR for nominal Body TSL parameters	normalized to 1W	10.8 mW / g ± 20.8 % (k=2)
SAR averaged over 10 cm <sup>3</sup> (10 g) of Body TSL	Condition	
SAR measured	250 mW input power	1.76 mW / g
SAR for nominal Body TSL parameters	normalized to 1W	7.08 mW / g ± 20.4 % (k=2)

Certificate No: Z16-97154

Page 3 of 8



Add: No.51 Xueyuan Road, Haidian District, Beijing, 100191, China  
 Tel: +86-10-62304633-2079 Fax: +86-10-62304633-2504  
 E-mail: cttl@chinattl.com Http://www.chinattl.cn

**Appendix**

**Antenna Parameters with Head TSL**

Impedance, transformed to feed point	52.1Ω- 0.68jΩ
Return Loss	- 33.4dB

**Antenna Parameters with Body TSL**

Impedance, transformed to feed point	46.9Ω- 2.13jΩ
Return Loss	- 28.3dB

**General Antenna Parameters and Design**

Electrical Delay (one direction)	1.514 ns
----------------------------------	----------

After long term use with 100W radiated power, only a slight warming of the dipole near the feedpoint can be measured.

The dipole is made of standard semirigid coaxial cable. The center conductor of the feeding line is directly connected to the second arm of the dipole. The antenna is therefore short-circuited for DC-signals. On some of the dipoles, small end caps are added to the dipole arms in order to improve matching when loaded according to the position as explained in the "Measurement Conditions" paragraph. The SAR data are not affected by this change. The overall dipole length is still according to the Standard. No excessive force must be applied to the dipole arms, because they might bend or the soldered connections near the feedpoint may be damaged.

**Additional EUT Data**

Manufactured by	SPEAG
-----------------	-------



Add: No.51 Xueyuan Road, Haidian District, Beijing, 100191, China  
 Tel: +86-10-62304633-2079 Fax: +86-10-62304633-2504  
 E-mail: cttl@chinattl.com Http://www.chinattl.cn

**DASY5 Validation Report for Head TSL**

Date: 10.11.2016

Test Laboratory: CTTL, Beijing, China

**DUT: Dipole 900 MHz; Type: D900V2; Serial: D900V2 - SN: 1d141**

Communication System: UID 0, CW; Frequency: 900 MHz; Duty Cycle: 1:1

Medium parameters used:  $f = 900 \text{ MHz}$ ;  $\sigma = 0.962 \text{ S/m}$ ;  $\epsilon_r = 41.3$ ;  $\rho = 1000 \text{ kg/m}^3$

Phantom section: Center Section

Measurement Standard: DASY5 (IEEE/IEC/ANSI C63.19-2007)

DASY5 Configuration:

- Probe: ES3DV3 - SN3149; ConvF(6.13, 6.13, 6.13); Calibrated: 4/15/2016;
- Sensor-Surface: 3mm (Mechanical Surface Detection)
- Electronics: DAE4 Sn777; Calibrated: 2016-08-22
- Phantom: Triple Flat Phantom 5.1C; Type: QD 000 P51 CA; Serial: 1161/1
- Measurement SW: DASY52, Version 52.8 (8); SEMCAD X Version 14.6.10 (7372)

**Dipole Calibration/Zoom Scan (7x7x7) (7x7x7)/Cube 0:** Measurement grid: dx=5mm, dy=5mm, dz=5mm

Reference Value = 57.16 V/m; Power Drift = 0.02 dB

Peak SAR (extrapolated) = 3.99 W/kg

**SAR(1 g) = 2.64 W/kg; SAR(10 g) = 1.7 W/kg**

Maximum value of SAR (measured) = 3.11 W/kg

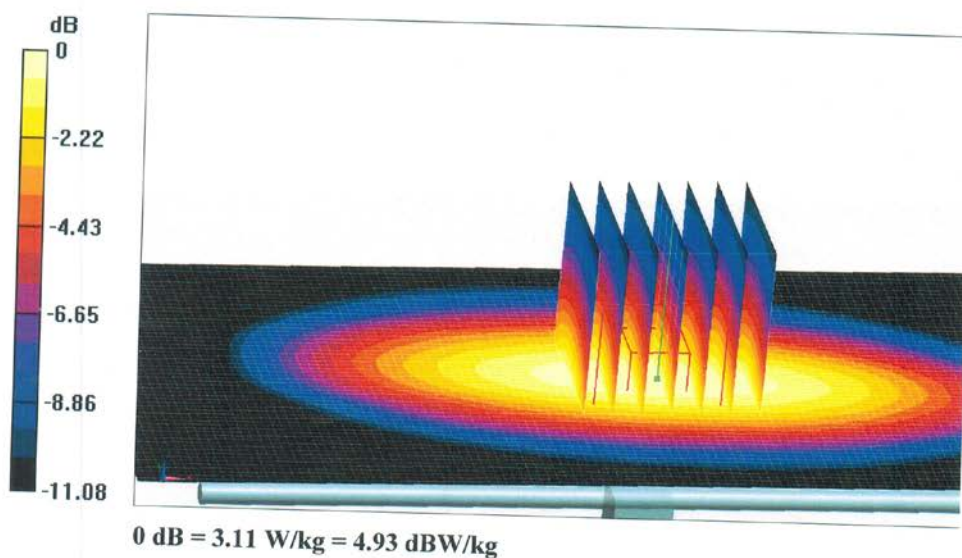



Add: No.51 Xueyuan Road, Haidian District, Beijing, 100191, China  
Tel: +86-10-62304633-2079 Fax: +86-10-62304633-2504  
E-mail: cttl@chinattl.com Http://www.chinattl.cn

### Impedance Measurement Plot for Head TSL

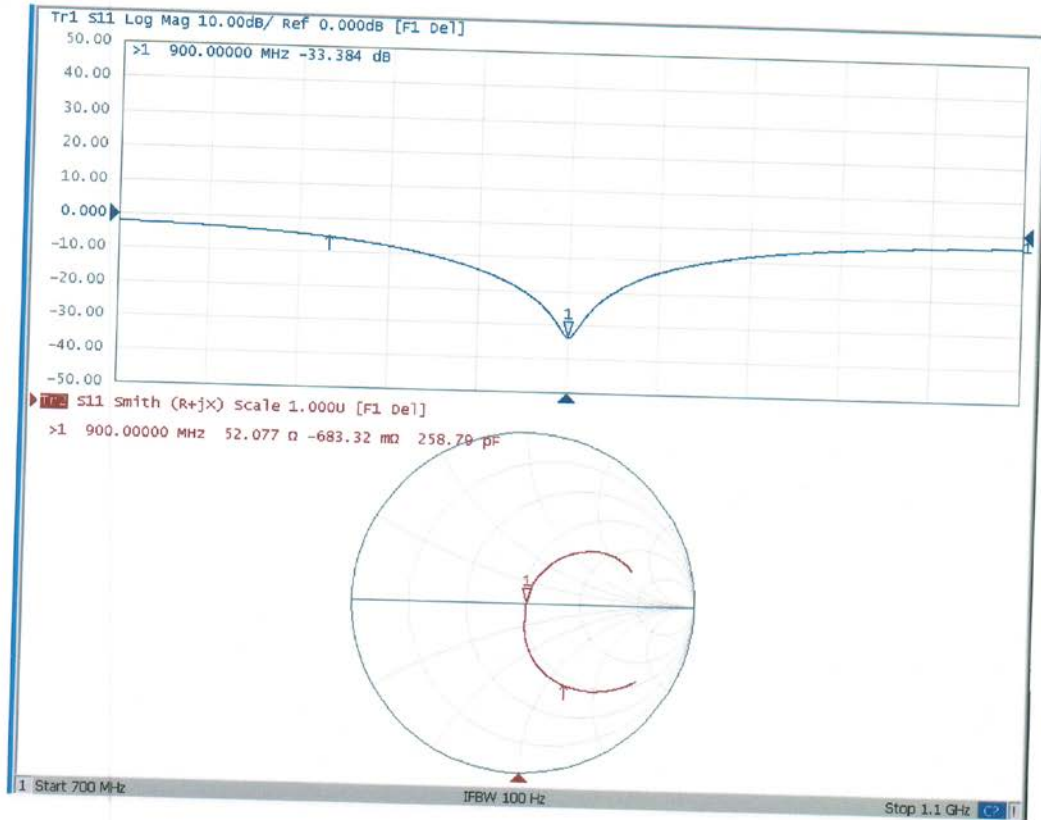





Add: No.51 Xueyuan Road, Haidian District, Beijing, 100191, China  
 Tel: +86-10-62304633-2079 Fax: +86-10-62304633-2504  
 E-mail: cttl@chinattl.com Http://www.chinattl.cn

**DASY5 Validation Report for Body TSL**

Date: 10.11.2016

Test Laboratory: CTTL, Beijing, China

**DUT: Dipole 900 MHz; Type: D900V2; Serial: D900V2 - SN: 1d141**

Communication System: UID 0, CW; Frequency: 900 MHz; Duty Cycle: 1:1

Medium parameters used:  $f = 900 \text{ MHz}$ ;  $\sigma = 1.042 \text{ S/m}$ ;  $\epsilon_r = 55.23$ ;  $\rho = 1000 \text{ kg/m}^3$

Phantom section: Left Section

Measurement Standard: DASY5 (IEEE/IEC/ANSI C63.19-2007)

DASY5 Configuration:

- Probe: ES3DV3 - SN3149; ConvF(6.13, 6.13, 6.13); Calibrated: 4/15/2016;
- Sensor-Surface: 3mm (Mechanical Surface Detection)
- Electronics: DAE4 Sn777; Calibrated: 2016-08-22
- Phantom: Triple Flat Phantom 5.1C; Type: QD 000 P51 CA; Serial: 1161/1
- Measurement SW: DASY52, Version 52.8 (8); SEMCAD X Version 14.6.10 (7372)

**Dipole Calibration/Zoom Scan (7x7x7) (7x7x7)/Cube 0:** Measurement grid:  $dx=5\text{mm}$ ,  $dy=5\text{mm}$ ,  $dz=5\text{mm}$

Reference Value = 55.36 V/m; Power Drift = -0.01 dB

Peak SAR (extrapolated) = 3.97 W/kg

**SAR(1 g) = 2.69 W/kg; SAR(10 g) = 1.76 W/kg**

Maximum value of SAR (measured) = 3.15 W/kg

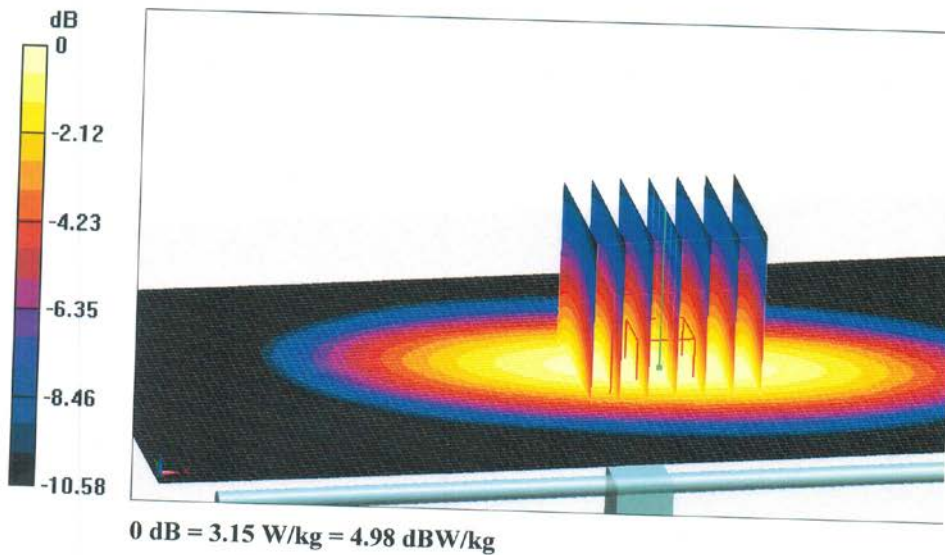



In Collaboration with  
**s p e a g**  
CALIBRATION LABORATORY

Add: No.51 Xueyuan Road, Haidian District, Beijing, 100191, China  
Tel: +86-10-62304633-2079 Fax: +86-10-62304633-2504  
E-mail: cttl@chinattl.com Http://www.chinattl.cn

### Impedance Measurement Plot for Body TSL

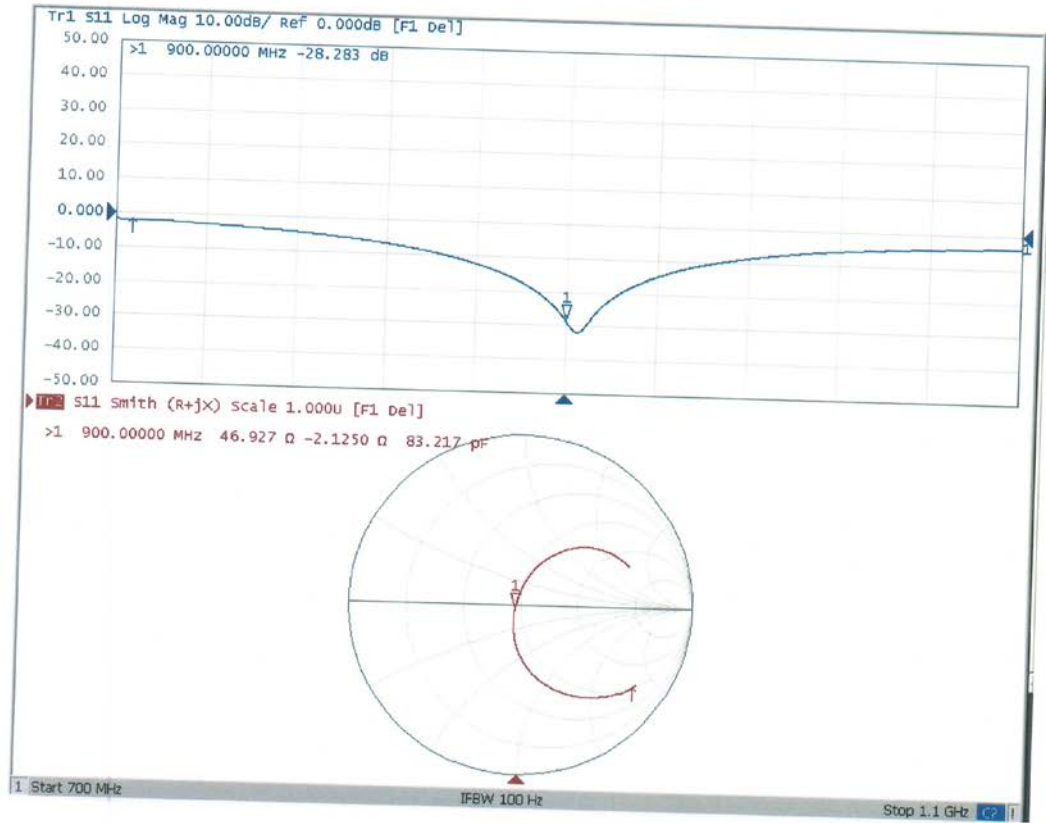

Certificate No: Z16-97154

Page 8 of 8