

承认书

SPECIFICATION FOR APPROVAL

客户名称CUSTOMER:

客户料号 CUSTOMER PARTNO:

供应厂商SUPPLIER: Shenzhen Feasycom Co.,Ltd

产品型号PRODUCT MODEL: FYT-2 (M01-0200220R0A)

产品描述PRODUCT NAME: 2.4&5.8G FPC Antenna

产品编码PRODUCT CODE: F12E00009A0

客户签名 CUSTOMER SIGNATURE:

客户盖章 CUSTOMER SEAL:

供应商签名 SUPPLIER SIGNATURE:

供应商盖章 SUPPLIER SEAL:

注意: 请将此副本作为您的批准证明回签!

NOTE: PLEASE RETURN THIS COPY AS A CERTIFICATION OF YOUR APPROVAL

编制 Prepared by:
董春玲

日期 Date:
2023.08.17

地址 Add:

Rm 508, Building A, Fenghuang Zhigu, No.50, Tiezai Road,
Xixiang, Baoan District, Shenzhen, 518102, China

电话 Tel:

0755-27924639

性能参数 PERFORMANCE PARAMETER

1.电气参数 Electrical Characteristics

1	频率范围 Frequency Range	2400-2500MHz ; 5100-5900MHz
2	驻波比 V. S. W. R	<2.2
3	最大增益 Gain	4.3dBi
4	最大效率 Efficiency	61.03%
5	阻抗 Impedence	50 Ω
6	极化方式 Polarization	Linear polarization
7	接口类型 Interface type	Primary terminal

2.机械参数 Mechanical parameters

1	尺寸 Measure	FPC:42*19.9mm/Cable: 200mm*Φ1.13mm
2	颜色 Colour	black

3.环境参数 Environment Condition

1	工作温度 Working Temp	-30℃~80℃
---	-------------------	----------

测试图表 TESTING CURVE

1.性能测试 Performance test

1.1 驻波比 V.S.W.R

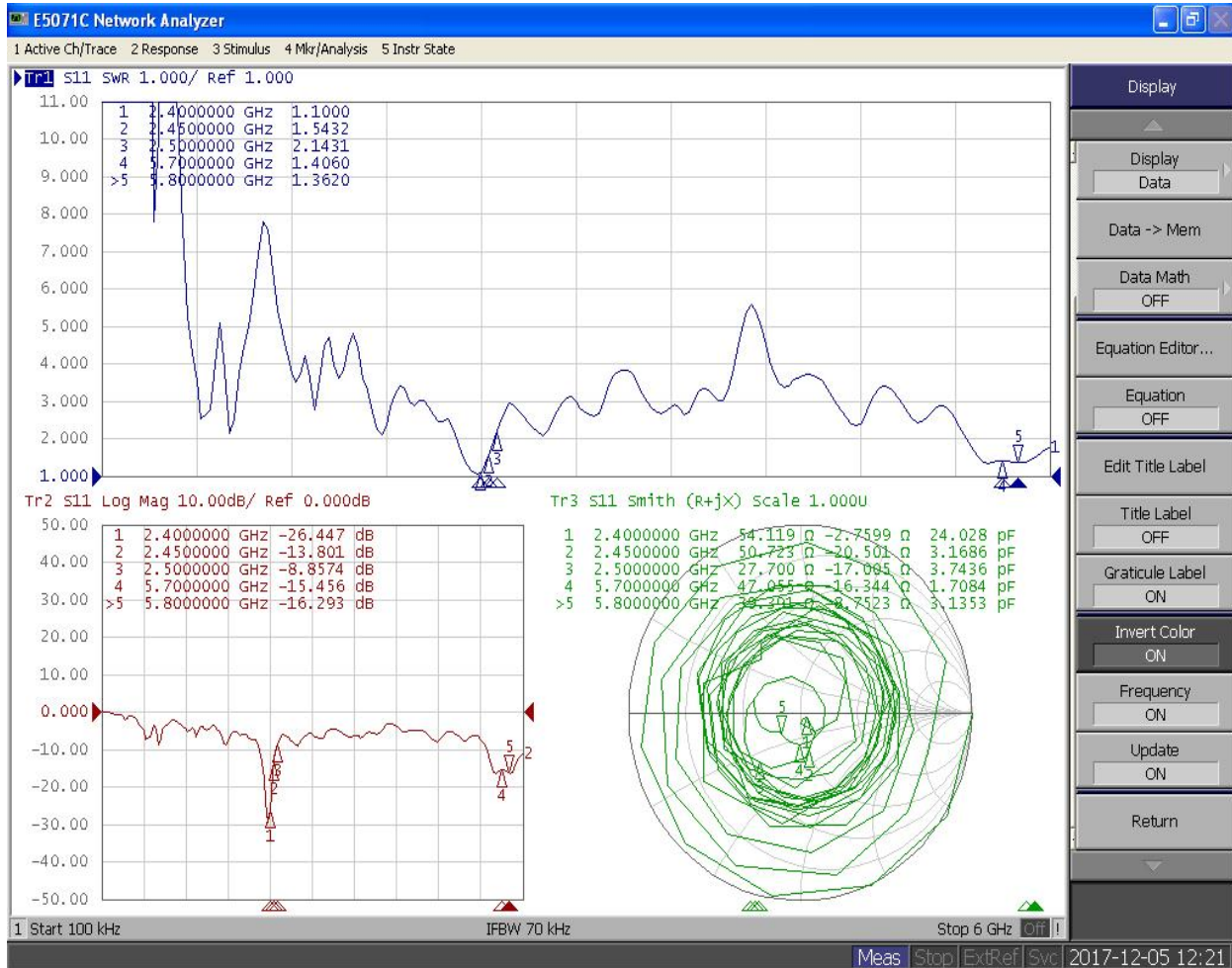

数据表 Data list

Freq	2.4	2.45	2.5	5.7	5.8
VSWR	1.1	1.5	2.1	1.4	1.4

测试图表 TESTING CURVE

2. 无源测试 Passive testing

2.1 效率及增益 Efficiency and Gain

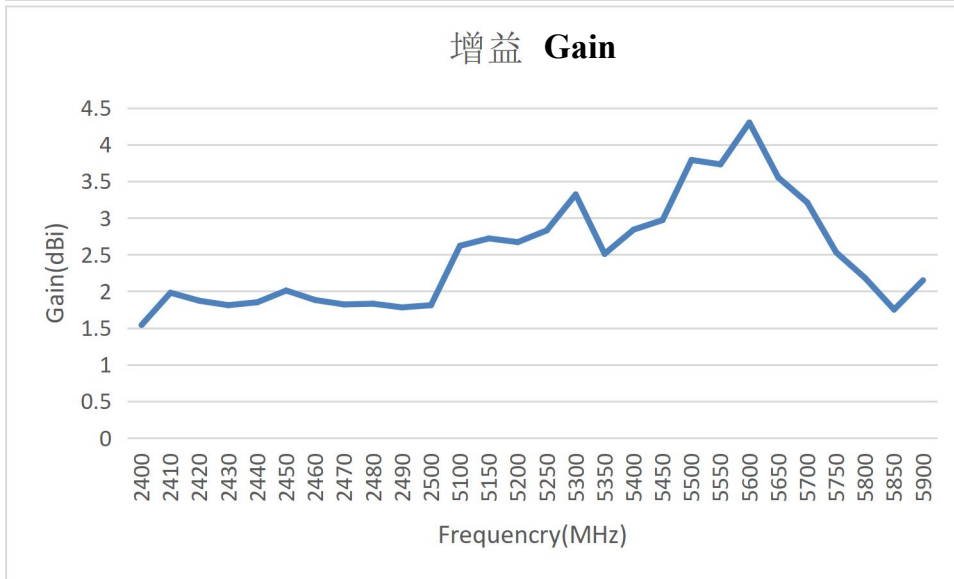
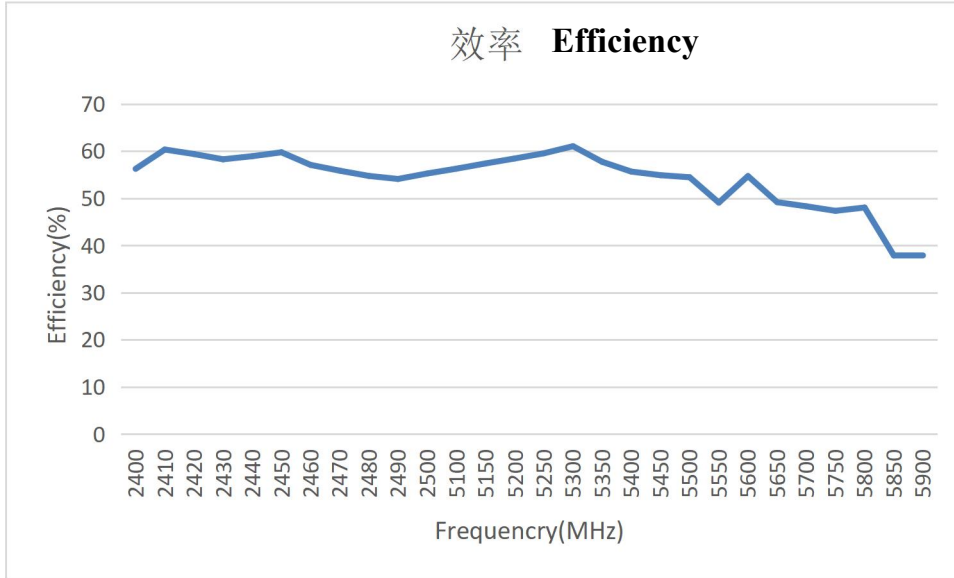

测试图表 TESTING CURVE

效率及增益数据表 Efficiency and Gain Data list

Freq(MHz)	Efficiency(%)	Gain (dBi)	Freq(MHz)	Efficiency(%)	Gain (dBi)
2400	56.23	1.54	5250	59.52	2.83
2410	60.32	1.98	5300	61.03	3.32
2420	59.37	1.87	5350	57.71	2.51
2430	58.25	1.81	5400	55.64	2.84
2440	58.91	1.85	5450	54.88	2.97
2450	59.73	2.01	5500	54.44	3.79
2460	57.06	1.88	5550	49.06	3.73
2470	55.83	1.82	5600	54.69	4.3
2480	54.72	1.83	5650	49.16	3.55
2490	54.08	1.78	5700	48.28	3.21
2500	55.24	1.81	5750	47.32	2.53
5100	56.26	2.62	5800	48.02	2.18
5150	57.37	2.72	5850	37.86	1.75
5200	58.42	2.67	5900	37.86	2.15

测试图表 TESTING CURVE

2.2 3D 图 3D Map

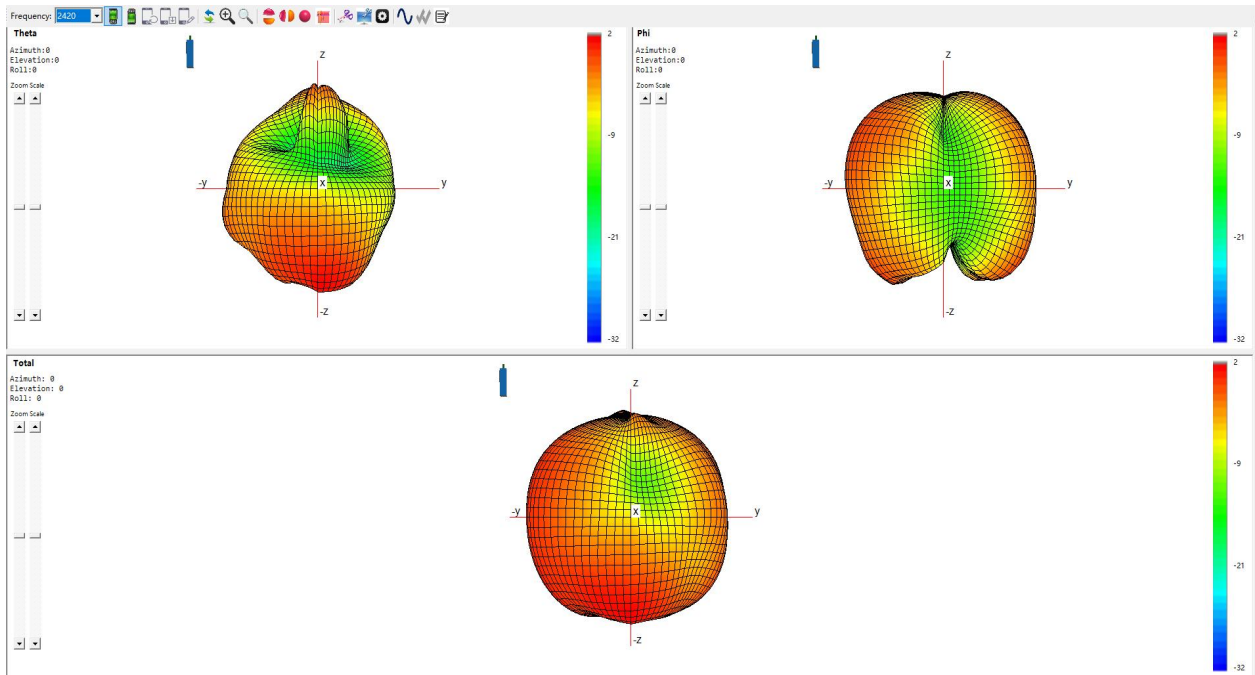

2420MHz

Gain=1.87dBi

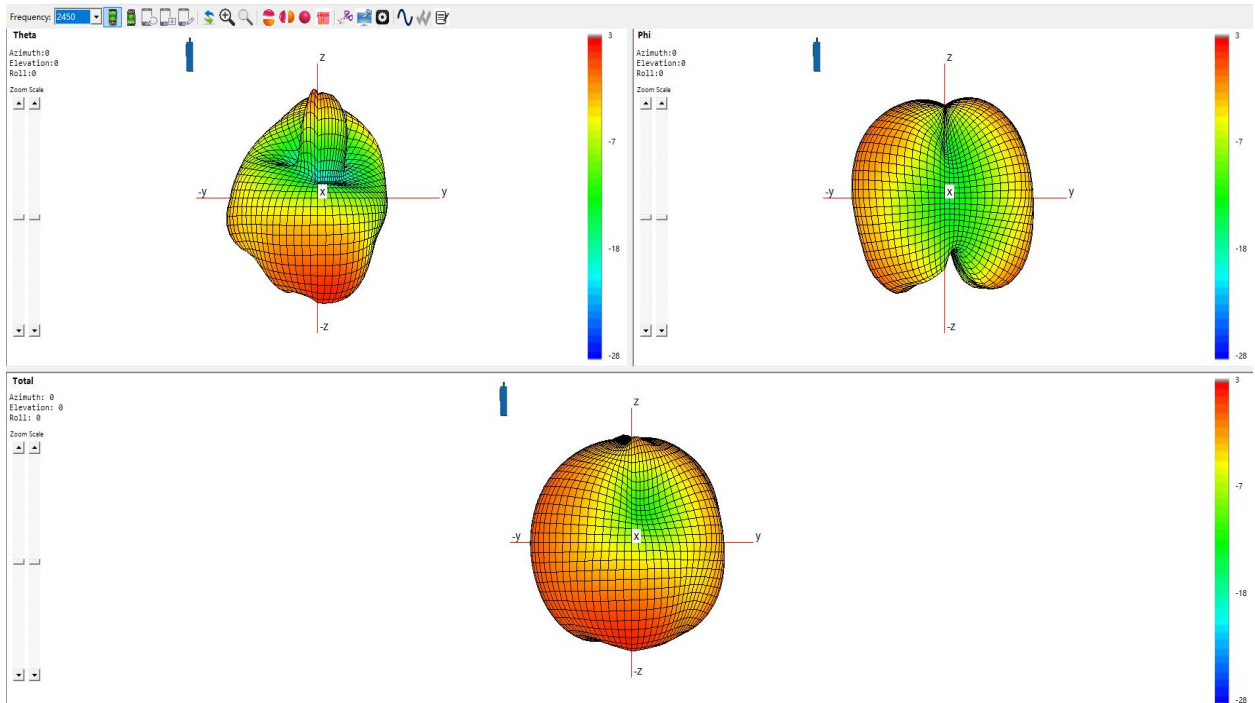

2450MHz

Gain=2.01dBi

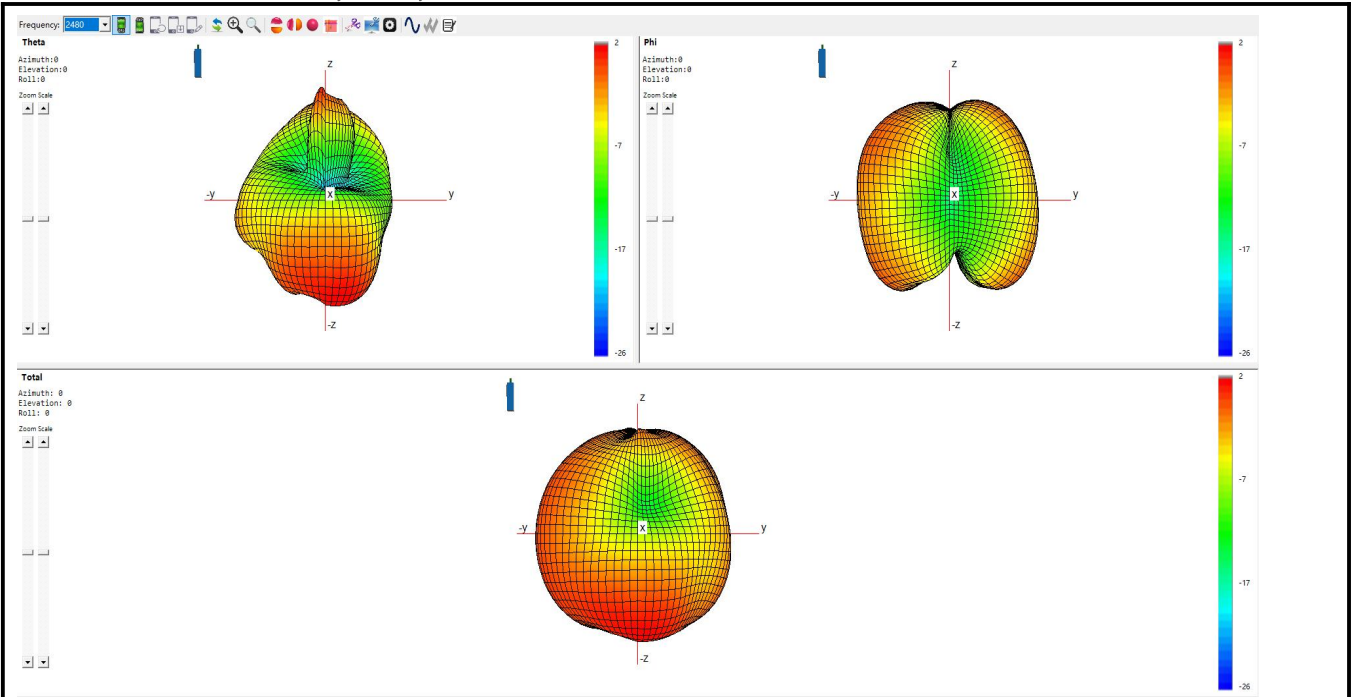

2480MHz

Gain=1.83dBi

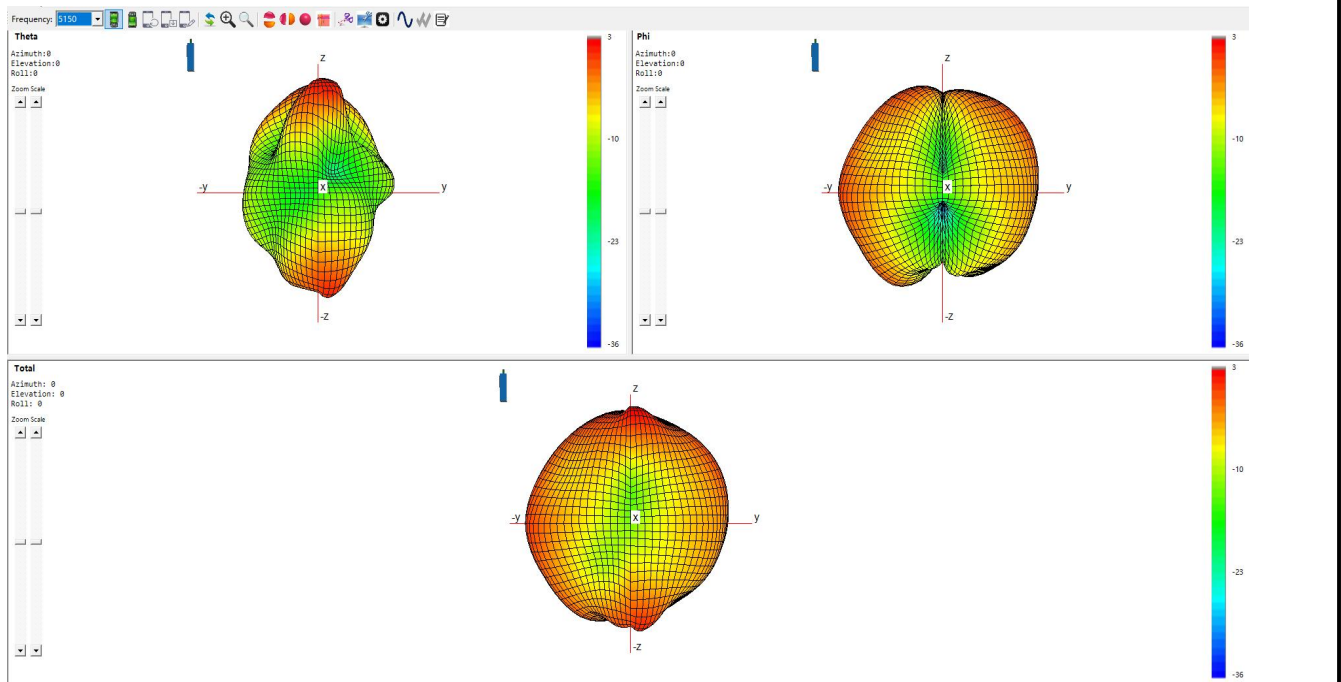

5150MHz

Gain=2.72dBi

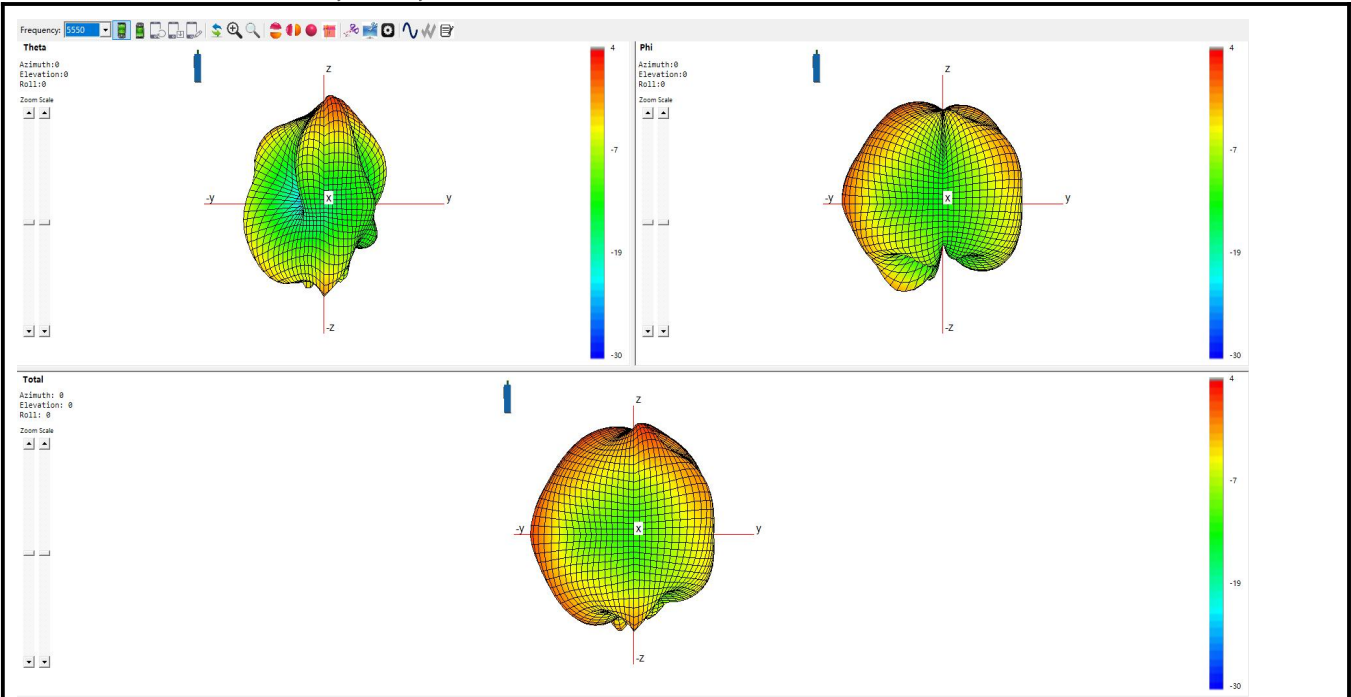

5550MHz

Gain=3.73dBi

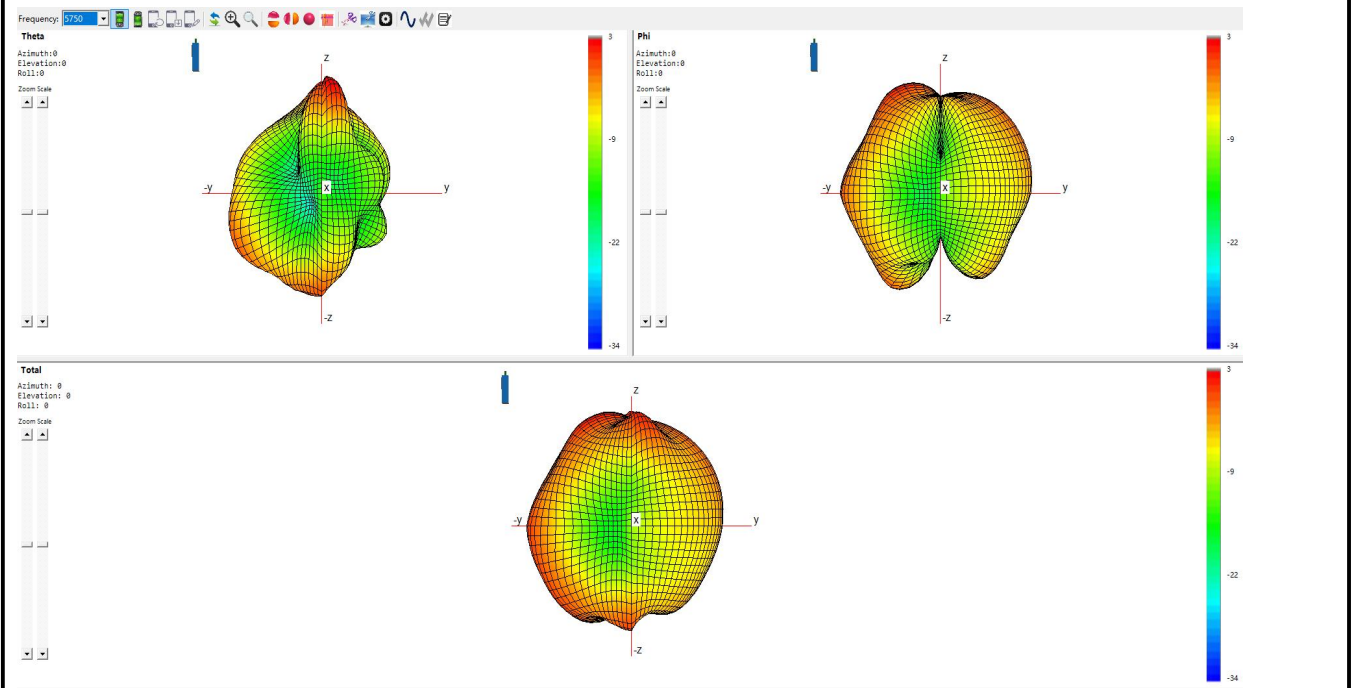

5750MHz

Gain=2.53dBi

2.3 2D 图 2D Figure

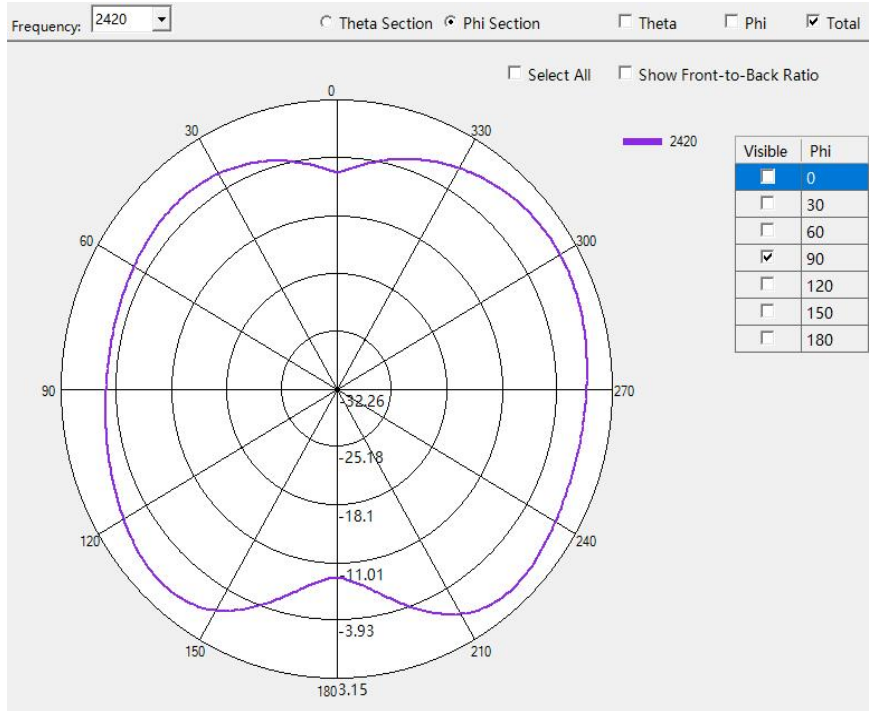

2420MHz

Gain=1.87dBi

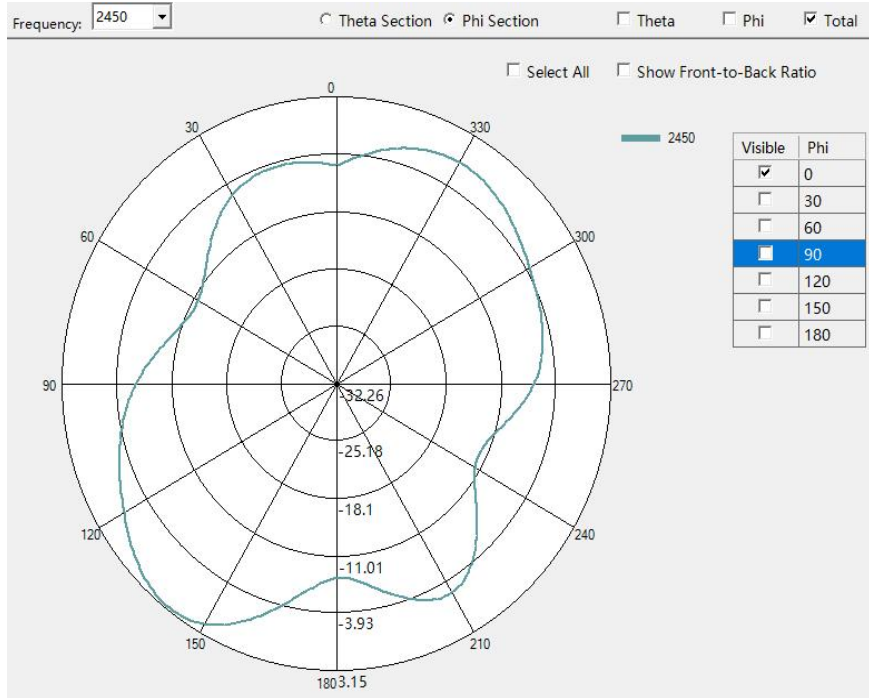

2450MHz

Gain=2.01dBi

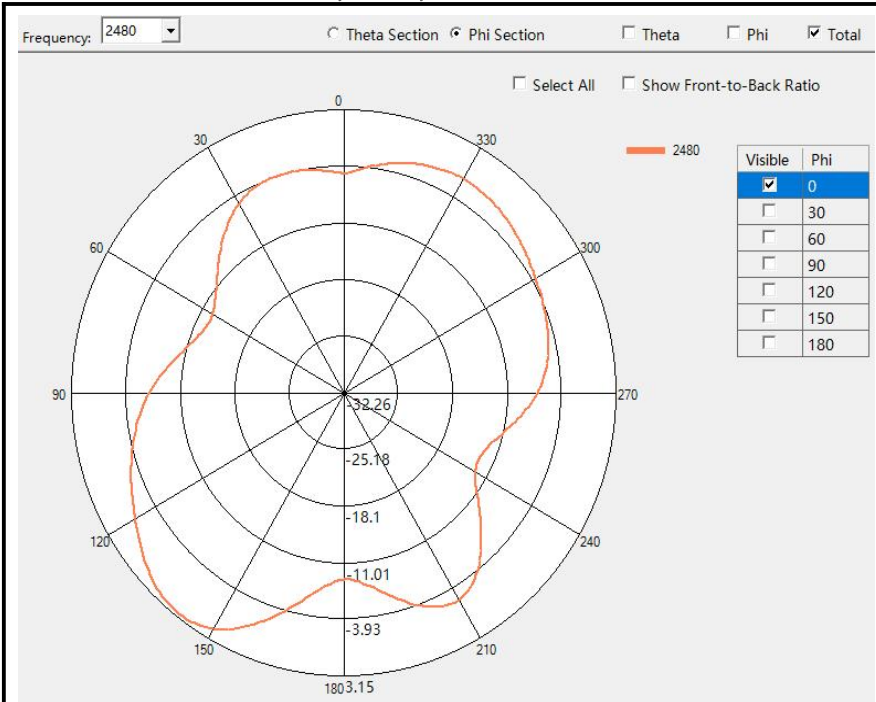

2480MHz

Gain=1.83dBi

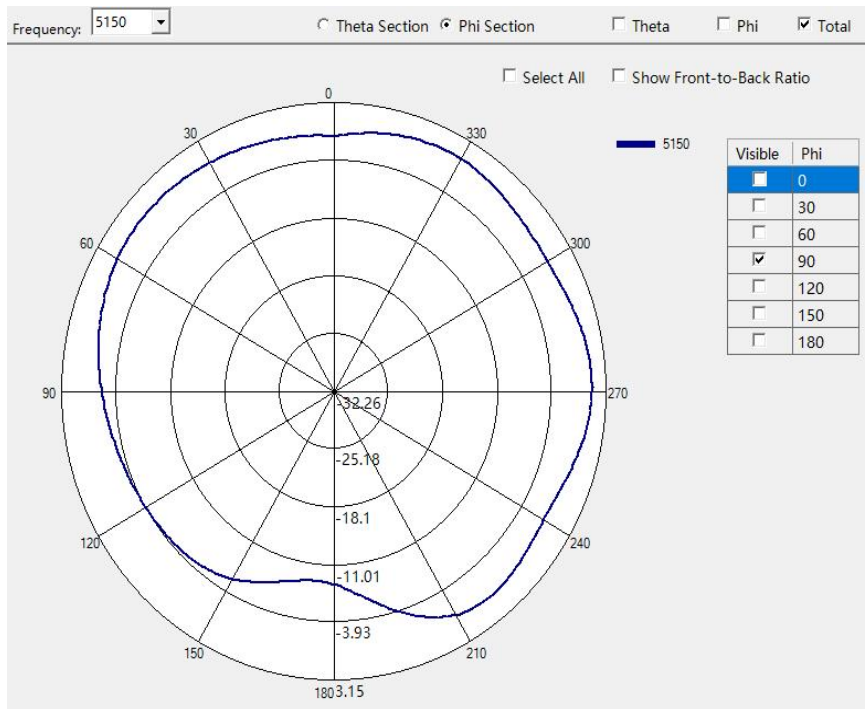

5150MHz

Gain=2.72dBi

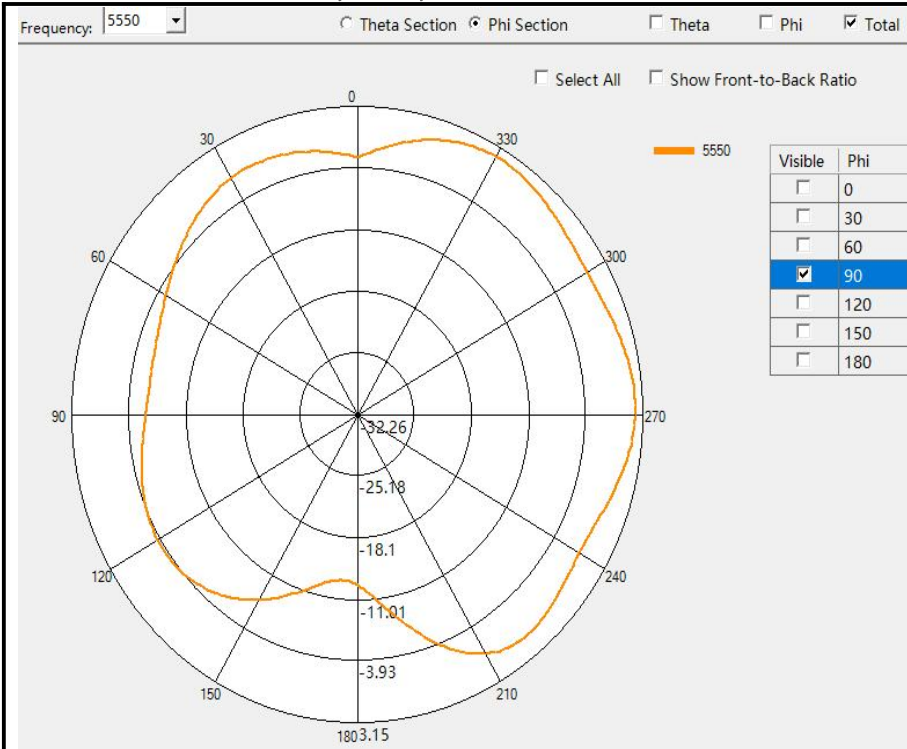

5550MHz

Gain=3.73dBi

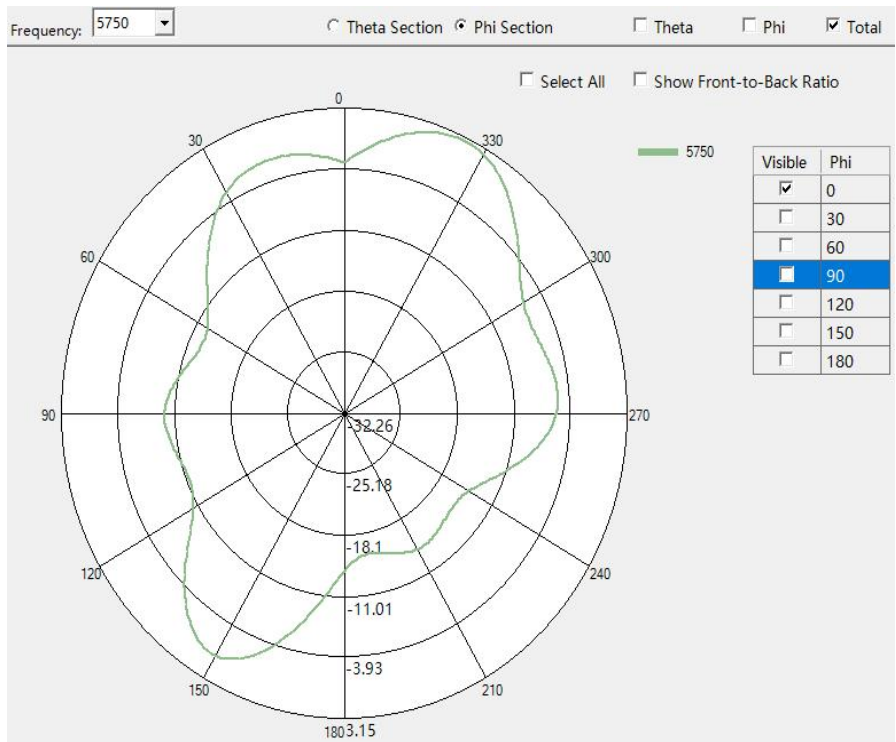

5750MHz

Gain=2.53dBi

3. 有源测试Active testing (无No)

工程图 SCHEDULE DRAWING



No.	Name	Material	Color	Treatment	Amount	Remark
1	2.4G&5.8G FPC		black		1	
2	2.4G&5.8G		black		1	

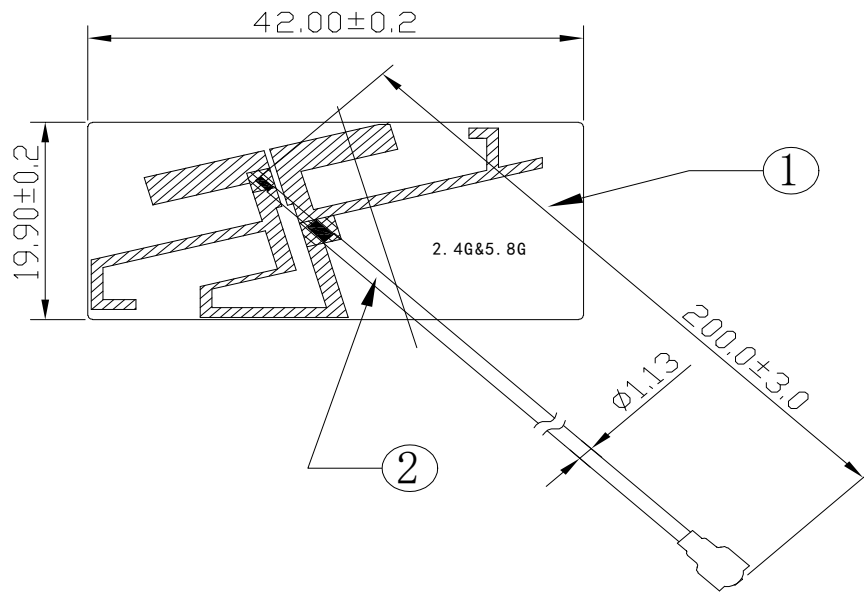

Rev	Description	Date	Remark	Location	DWG No.	Unit	mm	Scale	1:1
B	part number	20200804							
A0	New drawing	20200804							

Third Angle	Project	FYT-02	Designed by
0~10 ±0.10	Part Name	2.4G&5.8G Antenna	Date
10~18 ±0.15	Part No.	M01-0200220R0A	Checked by RF
18~30 ±0.20	Material		Date
30~40 ±0.25	DWG No.	00000080	Approved by
40~ ±0.30	Angle		Unit mm Scale 1:1

天线实物图 ANTENNA PHYSICAL DIAGRAM

