



Registration
No.788871

TEST REPORT

Report No.: SRTC2017-9003(R)-0164-1
Product Name: Charging stand
Model Name: S13
Applicant: Joy Home, Inc.
Manufacturer: Joy Home, Inc.
Specification: FCC Part 15C (2017 edition)
RSS-216 (Issue 2, January 2016)
FCC ID: 2AMPA-GC125543
IC ID: 23004-GC125543

The State Radio_monitoring_center Testing Center (SRTC)
15th Building, No.30 Shixing Street, Shijingshan District,
Beijing, China

Tel: 86-10-57996183 Fax: 86-10-57996388

CONTENTS

1. General information	3
1.1 Notes of the test report	3
1.2 Information about the testing laboratory.....	3
1.3 Applicant's details	3
1.4 Manufacturer's details.....	3
1.5 Application details	4
1.6 Reference specification.....	4
1.7 Information of EUT.....	4
1.7.1 General information.....	4
1.7.2 EUT details	4
1.7.3 Auxiliary equipment details.....	5
1.7.4 Operation Mode	5
2. Test information	6
2.1 Summary of the test results	6
2.2 Test result.....	7
2.2.1 Conducted Emissions-FCC Part15.207/RSS-216.....	7
2.2.2 Radiated Emissions-FCC Part15.209/RSS-216	13
2.2.3 20dB Bandwidth and 99% Bandwidth	20
2.3. List of test equipments	22
Appendix	23

1. General information

1.1 Notes of the test report

The test report may only be reproduced or published in full. Reproduction or publication of extracts from the report requires the prior written permission of The State Radio_monitoring_center Testing Center (SRTC).

The test results relate only to individual items of the samples which have been tested.

1.2 Information about the testing laboratory

Company: The State Radio_monitoring_center Testing Center (SRTC)
Address: 15th Building, No.30 Shixing Street, Shijingshan District
City: Beijing
Country or Region: P.R.China
Contacted person: Liu Jia
Tel: 86-10-57996183
Fax: 86-10-57996388
Email: liujiaf@srtc.org.cn

1.3 Applicant's details

Company: Joy Home, Inc. .
Address: 1388 Sutter St., San Francisco,USA
City: San Francisco
Country or Region: USA
Contacted person: Alan Chan
Tel: 646.784.1430
Fax: /
Email: Alan@joy.co

1.4 Manufacturer's details

Company: Joy Home, Inc. .
Address: 1388 Sutter St., San Francisco,USA
City: San Francisco
Country or Region: USA
Contacted person: Alan Chan
Tel: 646.784.1430
Fax: /
Email: Alan@joy.co

1.5 Application details

Date of reception of test sample: 6th Sept. 2017

Date of test: 6th Sept. 2017 to 15th Sept. 2017

1.6 Reference specification

FCC Part 15C 2017 (Certification)

RSS-216 —Wireless Power Transfer Devices (Issue 2, January 2016)

1.7 Information of EUT

1.7.1 General information

Name of EUT	Charging stand
Model of EUT	S13
Operating Frequency range	Charging stand: 111-145KHz
Power Supply	100-240VAC, 50-60Hz, 0.7Amax
Type Mode	Type 3 (According to RSS-216)
Antenna type	Internal type, Coil antenna
Test condition of declaration	Normal
Telecommunication center	<input type="checkbox"/> Yes <input checked="" type="checkbox"/> No
S/N	/

1.7.2 EUT details

Internal Control Number	DESCRIPTION	Marketing Name	Model
-------------------------	-------------	----------------	-------

EUT	Charging stand	---	S13
-----	----------------	-----	-----

1.7.3 Auxiliary equipment details

AE (Auxiliary Equipment) 1#:

Equipment	Joy Album
Manufacturer	Joy Home, Inc.
Model Number	K13
S/N	/

1.7.4 Operation Mode

Test has performed with the Charging stand combined with the Joy Album under three conditions of its battery power 0%,50% and 90% energy.The test results show it can generate the maximum output power when the Joy Album working under 0% battery power. So all the test performed when the Joy Album working with battery power is 0%.

The Charging stand has two surface zones can charge with the Joy Album but can't allow multiple client devices to be charged simultaneously.All the testing configuration is performed under the charging mode.

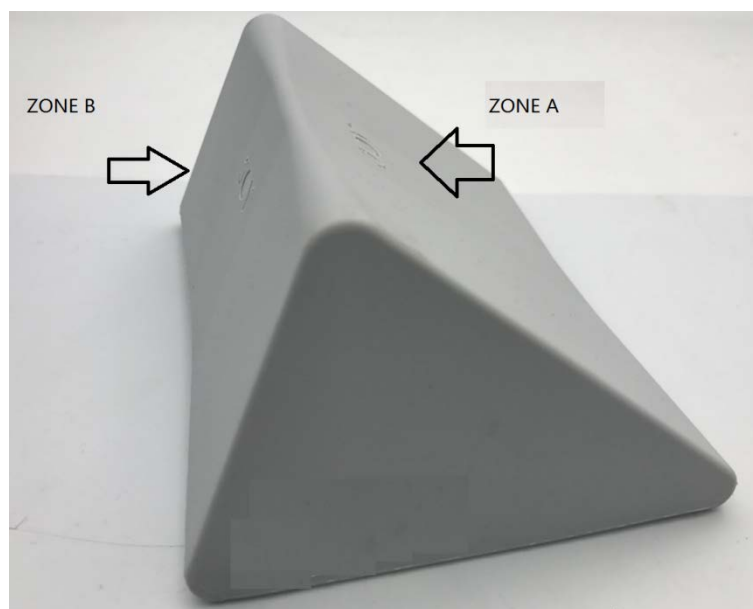

2. Test information

2.1 Summary of the test results

No.	Test case	Verdict
1	Conducted emissions	Pass
2	Radiated emissions	Pass
3	20dB Bandwidth and 99% Bandwidth	Pass

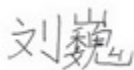
This Test Report Is Issued By: Mr. Liu Wei 	Checked By: Mr. He Jia 
Tested By: Mr. Lv Youyou 	Issued date: <p style="text-align: center;">2017.10.12</p>

2.2 Test result

2.2.1 Conducted Emissions-FCC Part15.207/RSS-216

Ambient condition:

Temperature	Relative humidity	Pressure
24.4°C	44.2%	100.9kPa

Test Setup with charger:

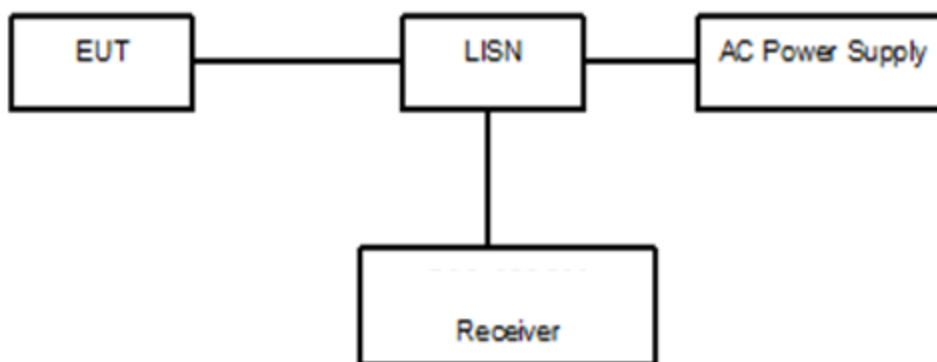

Figure 1

Test Procedure:

The EUT is placed on a non-metallic table 0.8m above the horizontal metal reference ground plane. The EUT is connected with LISN via the charger. The LISN is connected to the reference ground. The accessories of the EUT are connected with the EUT.

The test set-up and the test methods are performed according to ANSI C63.10:2013.

Then start the test software ES-K1. Sweep the whole frequency band through the range from 150 KHz to 30 MHz. The measurement should be done for both L line and N line. During pre-test, the receiver uses both peak detector and average detector. And the final test, the receiver uses both average detector and Quasi-peak detector.

The data of cable loss has been calibrated in full testing frequency range before the testing.

The RBW Configuration is 9KHz, VBW:30KHz.

Limit:

Frequency of Emission(MHz)	Limits(dB μ V)	
	Quasi-peak	Average
0.15~0.5	66 to 56*	56 to 46*
0.5~5	56	46
5~30	60	50

Note: * Decreases with the logarithm of the frequency

Test result:

Noise Level of the Measuring Instrument

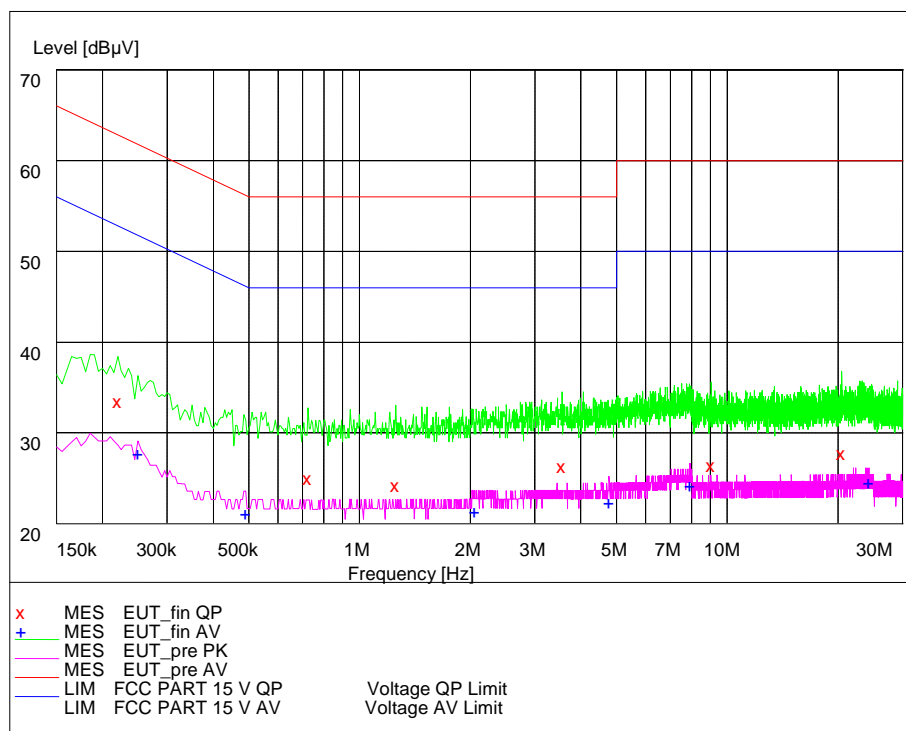

Pic1. Conducted emission L and N Line

EUT(Charged with Zone A):

Full Spectrum

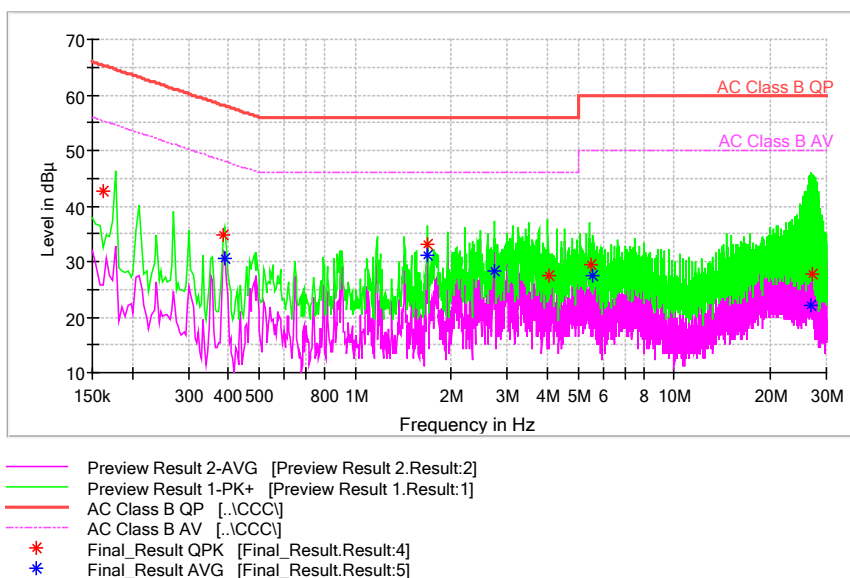

Comment

Pic2. Conducted emission L Line

MEASUREMENT RESULT: "MOBILE_fin QP"

Frequency MHz	QuasiPeak dBμV	Limit dBμV	Margin dB
0.162000	42.73	65.36	22.63
0.387000	34.89	58.13	23.24
1.683000	33.02	56.00	22.98
4.031000	27.33	56.00	28.67
5.463000	29.38	60.00	30.62
26.975000	27.86	60.00	32.14

MEASUREMENT RESULT: "MOBILE_fin AV"

Frequency MHz	Average dBμV	Limit dBμV	Margin dB
0.391000	30.55	48.04	17.49
1.687000	31.02	46.00	14.98
2.727000	28.29	46.00	17.71
5.575000	27.48	50.00	22.52
26.899000	22.15	50.00	27.85

EUT(Charged with Zone B):

Full Spectrum

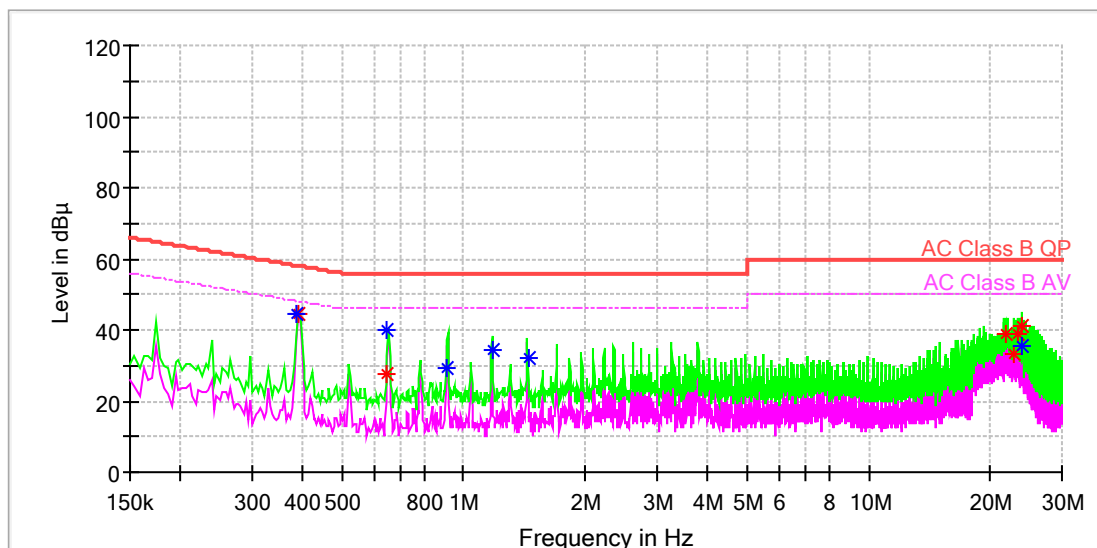

- Preview Result 2-AVG [Preview Result 2.Result:2]
- Preview Result 1-PK+ [Preview Result 1.Result:1]
- AC Class B QP [.\CCC\]
- - - AC Class B AV [.\CCC\]
- * Final_Result QPK [Final_Result.Result:4]
- * Final_Result AVG [Final_Result.Result:5]

Comment

Pic4. Conducted emission L Line

Final_Result_QPK

Frequency (MHz)	QuasiPeak (dB μ V)	Limit (dB μ V)	Margin (dB)	Meas. Time (ms)	Bandwidth (kHz)	Line	Filter	Corr. (dB)	Comment
0.391000	44.43	58.04	13.61	1000.0	9.000	L1	ON	30.1	
0.647000	27.40	56.00	28.60	1000.0	9.000	L1	ON	30.1	
21.851000	38.70	60.00	21.30	1000.0	9.000	L1	ON	30.0	
22.763000	33.49	60.00	26.51	1000.0	9.000	L1	ON	30.0	
23.343000	38.91	60.00	21.09	1000.0	9.000	L1	ON	30.0	
23.811000	41.10	60.00	18.90	1000.0	9.000	L1	ON	30.0	

Final_Result_QPK

Frequency (MHz)	QuasiPeak (dB μ V)	Limit (dB μ V)	Margin (dB)	Meas. Time (ms)	Bandwidth (kHz)	Line	Filter	Corr. (dB)	Comment
0.391000	44.43	58.04	13.61	1000.0	9.000	L1	ON	30.1	
0.647000	27.40	56.00	28.60	1000.0	9.000	L1	ON	30.1	
21.851000	38.70	60.00	21.30	1000.0	9.000	L1	ON	30.0	
22.763000	33.49	60.00	26.51	1000.0	9.000	L1	ON	30.0	
23.343000	38.91	60.00	21.09	1000.0	9.000	L1	ON	30.0	
23.811000	41.10	60.00	18.90	1000.0	9.000	L1	ON	30.0	

Full Spectrum

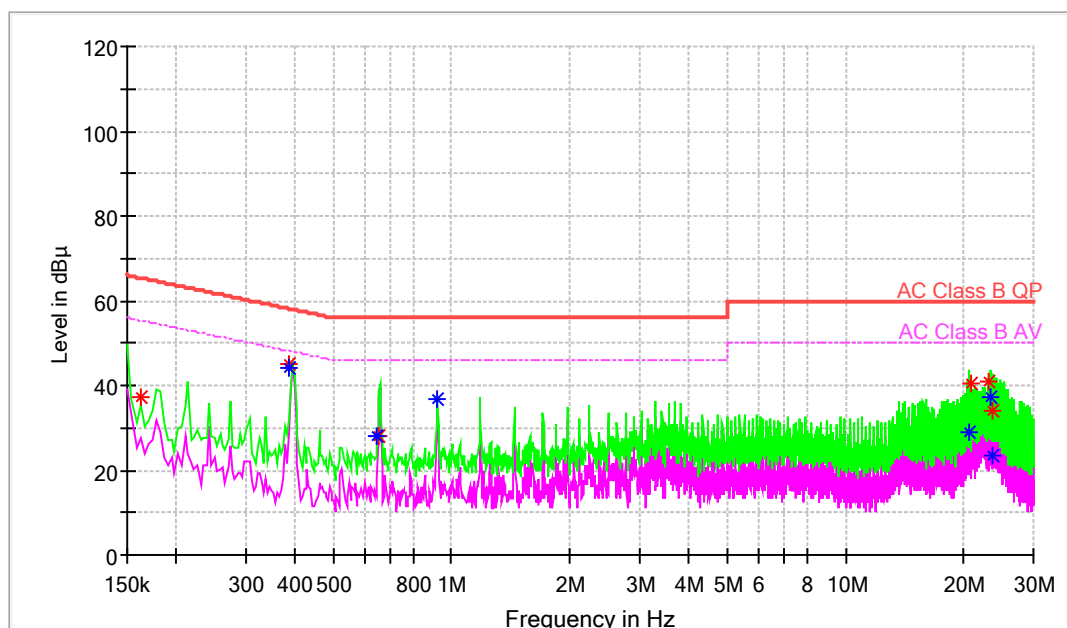

— Preview Result 2-AVG — Preview Result 1-PK+ — AC Class B QP
- - - AC Class B AV * Final_Result QPK * Final_Result AVG

Comment

Pic5. Conducted emission N Line

Final_Result_QPK

Frequency (MHz)	QuasiPeak (dB µ V)	Limit (dB µ V)	Margin (dB)	Meas. Time (ms)	Bandwidth (kHz)	Line	Filter	Corr. (dB)	Comment
0.162000	37.17	65.36	28.19	1000.0	9.000	L1	ON	30.1	
0.387000	45.28	58.13	12.85	1000.0	9.000	L1	ON	30.1	
0.651000	27.97	56.00	28.03	1000.0	9.000	L1	ON	30.1	
20.735000	40.24	60.00	19.76	1000.0	9.000	L1	ON	30.0	
23.199000	40.73	60.00	19.27	1000.0	9.000	L1	ON	30.0	
23.581000	33.87	60.00	26.13	1000.0	9.000	L1	ON	30.0	

Final_Result_QPK

Frequency (MHz)	QuasiPeak (dB µ V)	Limit (dB µ V)	Margin (dB)	Meas. Time (ms)	Bandwidth (kHz)	Line	Filter	Corr. (dB)	Comment
0.162000	37.17	65.36	28.19	1000.0	9.000	L1	ON	30.1	
0.387000	45.28	58.13	12.85	1000.0	9.000	L1	ON	30.1	
0.651000	27.97	56.00	28.03	1000.0	9.000	L1	ON	30.1	
20.735000	40.24	60.00	19.76	1000.0	9.000	L1	ON	30.0	
23.199000	40.73	60.00	19.27	1000.0	9.000	L1	ON	30.0	
23.581000	33.87	60.00	26.13	1000.0	9.000	L1	ON	30.0	

2.2.2 Radiated Emissions-FCC Part15.209/RSS-216

Ambient condition:

Temperature	Relative humidity	Pressure
24.4°C	44.2 %	100.9kPa

Test Setup:

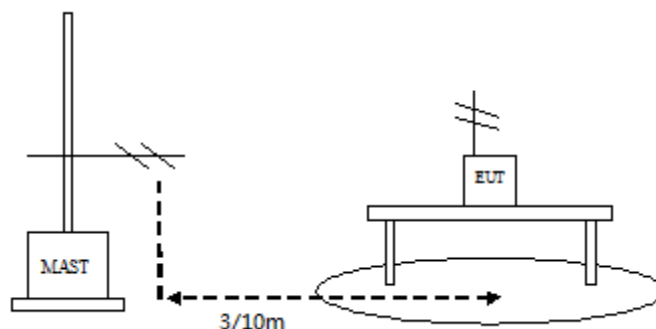

Figure 2

Test Procedure:

The EUT should be placed on a non-metallic table 80cm above the ground plane. The distance between EUT and receive antenna should be 3 meters when testing between 30MHz-6GHz, 10meter when testing between 9kHz-30MHz.

The EUT should work in Charging mode..

The test set-up and the test methods are performed according to ANSI C63.10:2013.

Then start the test software ES-K1. Sweep the whole frequency band through the range from 9KHz to 30MHz, using receive log period antenna HFH2-Z2. the lowest height of the magnetic antenna shall be 1 m above the ground. Measurement is made aligning the loop antenna along the site axis, orthogonal to the axis (x,y,z), when perpendicular to the ground plane

Sweep the whole frequency band through the range from 30MHz to 1GHz, using receive log period antenna HL562, set the receiver do pre-scan with Peak detector and final scan with Quasi-peak Detector. Above 1GHz, using the horn antenna.

During the test, The turn table shall be rotated from 0 to 360 degrees for detecting the maximum of radiated spurious signal level. The measurements shall be repeated with orthogonal polarization of the test antenna.

The data of cable loss and antenna factor have been calibrated in full testing frequency range before the testing.

A “reference path loss” is established and the A_{Rpl} is the attenuation of “reference path loss”, and including the gain of receive antenna, the gain of the preamplifier, the cable loss.

The measurement results are obtained as described below:

$$\text{Result} = P_{\text{mea}} + A_{\text{Rpl}}$$

Limit:

Frequency of Emission(MHz)	Limit (uV/m) @ Distance	Limit (dBuV/m)	Distance Correction
0.009~0.49	2400/F(kHz) @ 300m	48.5 – 13.8 @ 300m	300m to 10m = 59.1dB
0.49~1.705	24000/F(kHz) @ 30m	33.8 – 22.97 @ 30m	30m to 10m = 19.1dB
1.705~30	30 @ 30m	29.54 @ 30m	30m to 10m = 19.1dB

Frequency of Emission(MHz)	Limits	
	Detector	Unit (dBμV/m)
30~88	Quasi-peak	40
88~216	Quasi-peak	43.5
216~960	Quasi-peak	46
960~1000	Quasi-peak	54
1000~5th harmonic of the highest frequency or 40GHz, whichever is lower	Average	54
	Peak	74

The Detector and RBW/VBW Setting:

Frequency(MHz)	Detector	RBW	VBW
0.009-0.15	Average	200Hz	1KHz
0.15-0.49	Average	9KHz	30KHz
0.49-30	Quasi-peak	9KHz	30KHz
30-1000	Quasi-peak	100KHz	300KHz
1000-6000	Peak and Average	1MHz	3MHz

Test result:

EUT (Charged with Zone A)

Frequency(MHz)	Result(dBuV/m)	ARpl (dB)	Pmea (dBuV/m)	Polarity
0.126	3.23	5.28	-2.05	---
NF				

NF: Not found

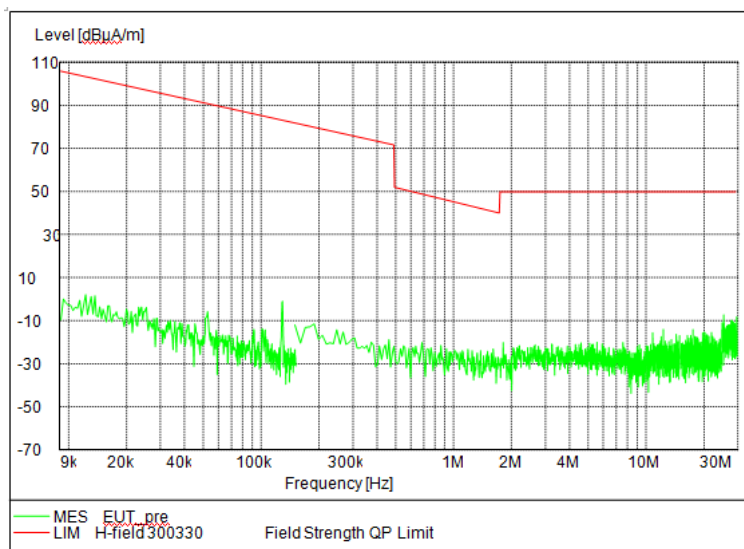

Pic6. Radiated emission(9KHz – 30MHz)

Frequency(MHz)	Result(dBuV/m)	ARpl (dB)	Pmea (dBuV/m)	Polarity
30.42	27.98	20.8	7.18	Vertical
39.39	23.38	15.9	7.48	Vertical
41.64	25.45	14.9	10.55	Vertical
180.96	29.68	10.9	18.78	Vertical
215.43	26.03	12.0	14.03	Vertical
431.86	28.54	19.5	9.04	Vertical

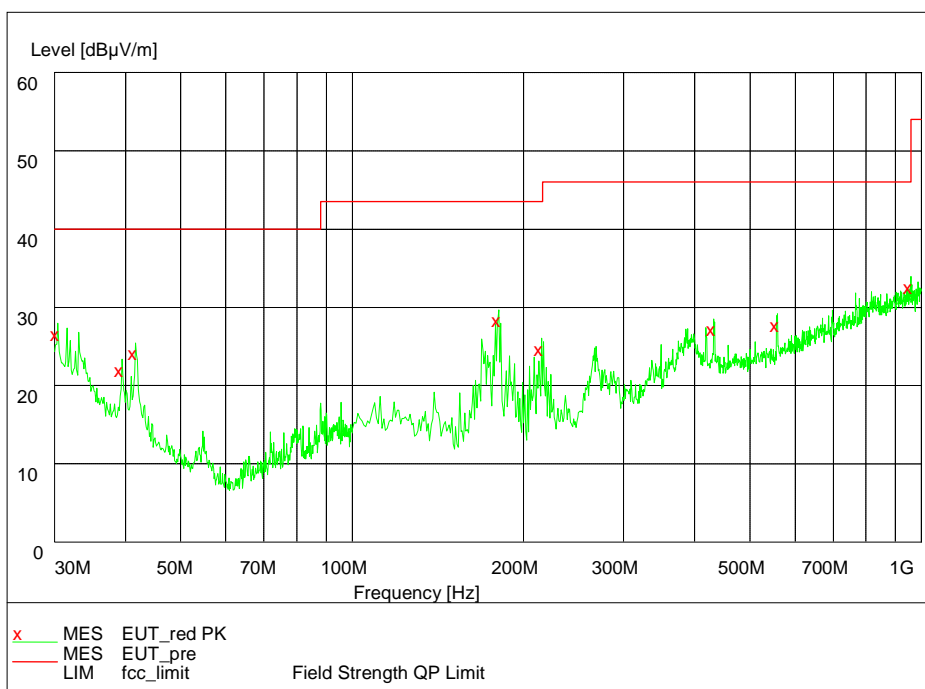

Pic7. Radiated emission(30MHz – 1GHz)

Frequency(MHz)	Result(dBuV/m)	ARpl (dB)	Pmea (dBuV/m)	Polarity
NF				

NF: Not found

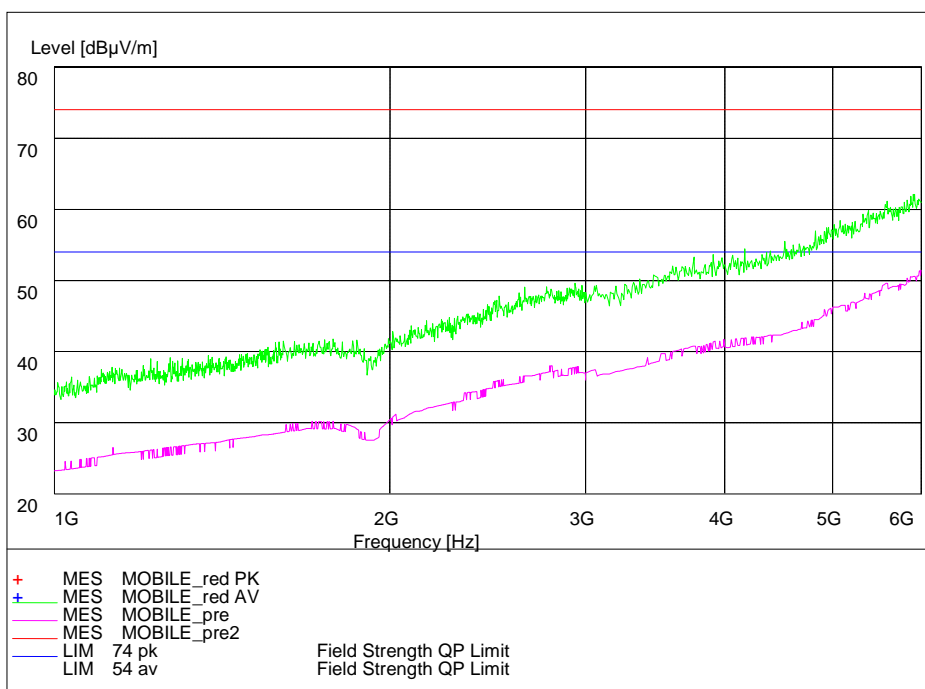

Pic8. Radiated emission (1GHz – 6GHz)

EUT (Charged with Zone B)

Frequency(MHz)	Result(dBuV/m)	ARpl (dB)	Pmea (dBuV/m)	Polarity
0.128	2.95	5.28	-2.33	---

NF: Not found

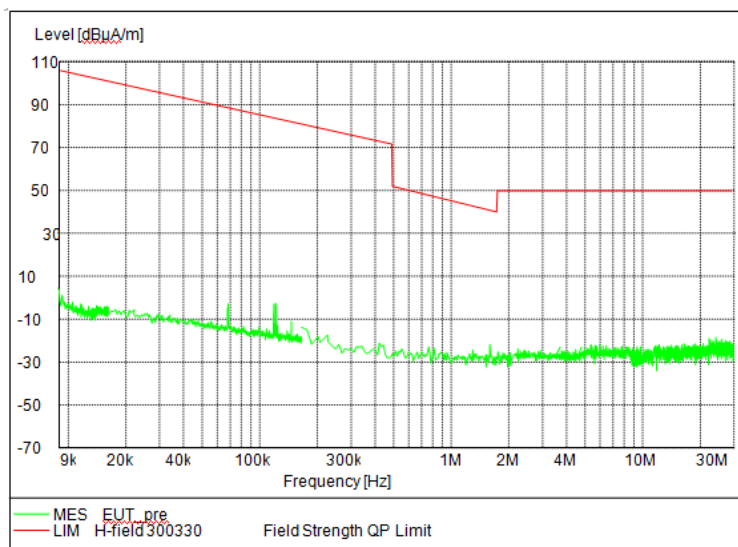

Pic9. Radiated emission(9KHz – 30MHz)

Frequency(MHz)	Result(dBuV/m)	ARpl (dB)	Pmea (dBuV/m)	Polarity
30.39	28.02	20.8	7.22	Vertical
39.52	23.36	15.9	7.46	Vertical
41.61	25.52	14.9	10.62	Vertical
182.32	29.42	10.9	18.52	Vertical
214.97	23.23	12.0	11.23	Vertical
432.64	28.55	19.5	9.05	Vertical

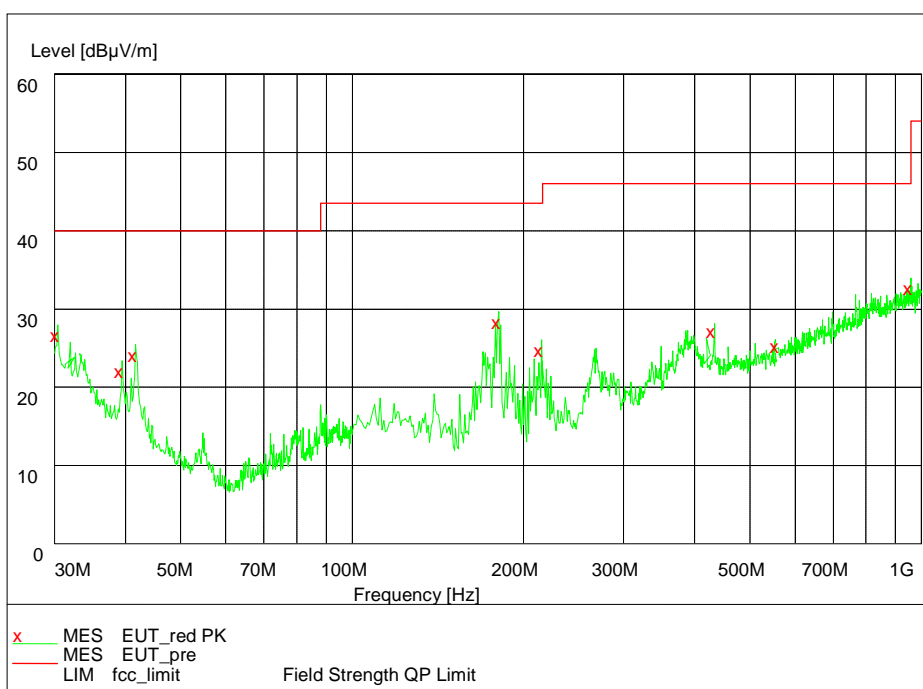

Pic10. Radiated emission(30MHz – 1GHz)

Frequency(MHz)	Result(dBuV/m)	ARpl (dB)	Pmea (dBuV/m)	Polarity
NF				

NF: Not found

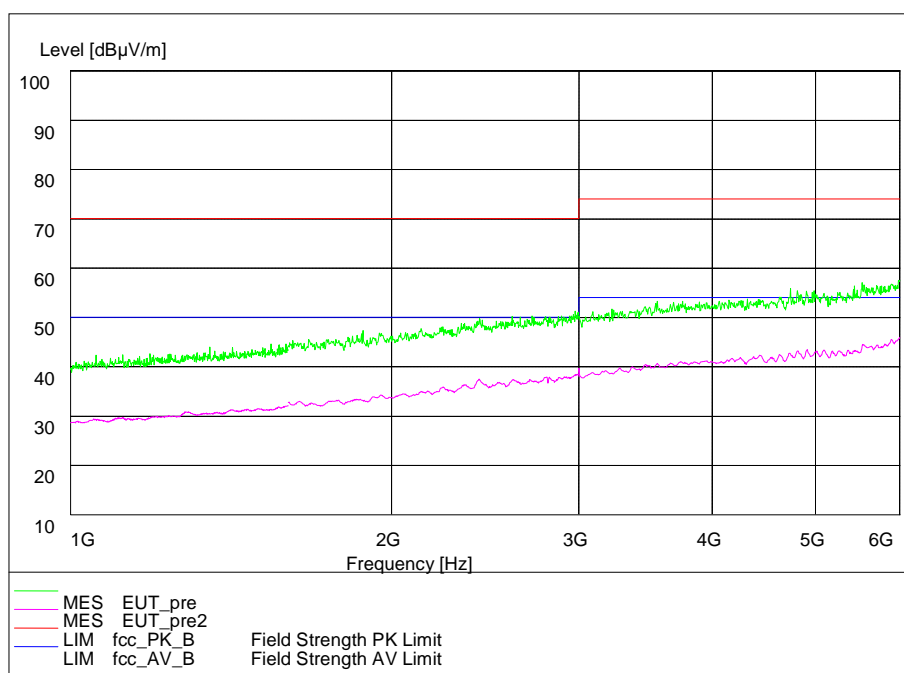

Pic11. Radiated emission (1GHz – 6GHz)

2.2.3 20dB Bandwidth and 99% Bandwidth

Test Procedure:

The bandwidth is measured at an amplitude level reduced from the reference level by a specified ratio. The reference level is the level of the highest amplitude signal observed from the transmitter at either the fundamental frequency or first-order modulation in all typical modes of operation, including the unmodulated carrier, even if at typical . Once the reference level is established, the equipment is conditioned with typical modulating signals to produce worst –case (i.e.,the widest) bandwidth. In order to measure the modulated signal properly, a resolution bandwidth that is small compared to the bandwidth required by the procuring or regulatory agency shall be used on the measuring instrument. However, the 6 dB resolution bandwidth of the measuring instrument shall be set to a value greater than 5% of the bandwidth requirements.

Limit:

Within the specified band!

Test result:

20 dB bandwidth is:

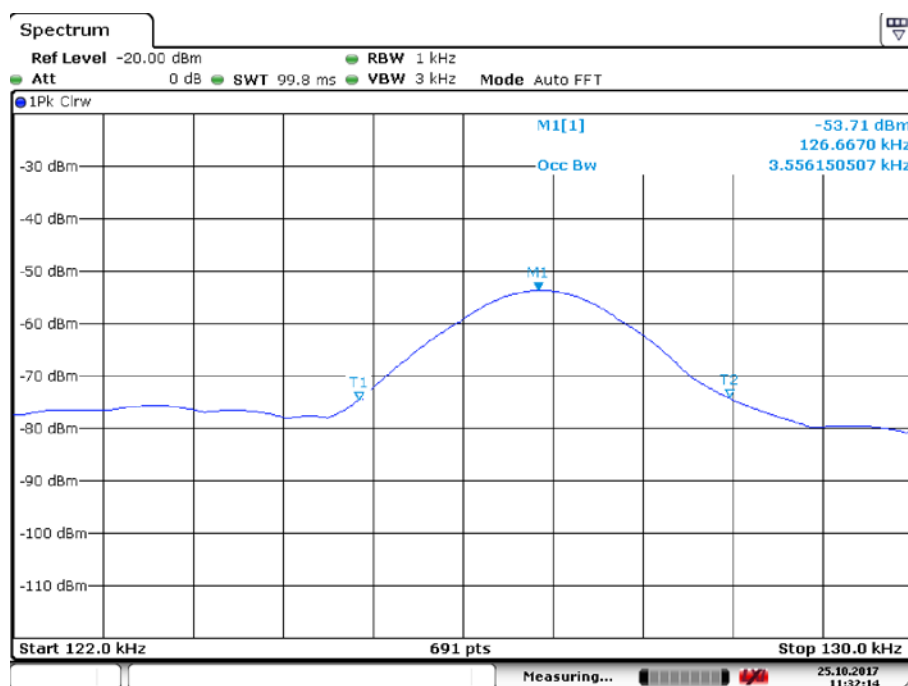

Bandwidth: 3.56 KHz

99% Bandwidth:

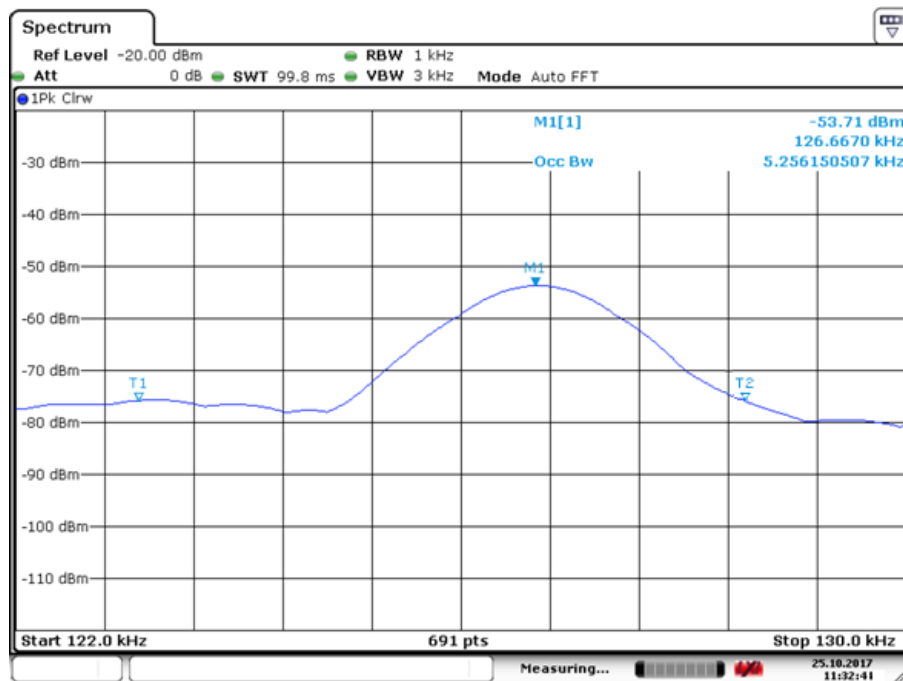

Bandwidth: 5.26 KHz

2.3. List of test equipments

No.	Name/Model	Manufacturer	S/N	Calibration Date	Calibration Due Date
1	23.18m×16.88m×9.60m Semi-Anechoic Chamber	FRANKONIA	-----	2017.8.20	2018.8.19
2	ESI 40EMI test receiver	R&S	100015	2017.8.20	2018.8.19
3	E5515C(8960) Mobile Station Tester	Agilent	GB44050904	2017.8.20	2018.8.19
4	9.080m×5.255m×3.525m Shielding room	FRANKONIA	-----	2017.8.20	2018.8.19
5	ESCS30EMI test receiver	R&S	100029	2017.8.20	2018.8.19
6	HL562Ultra log test antenna	R&S	100016	2017.8.20	2018.8.19
7	ESH3-Z2 Pulse limiter	R&S	10002	2017.8.20	2018.8.19
8	ENV216 AMN	R&S	3560.6550.12	2017.8.20	2018.8.19
9	ESH2Z11 LISN	R&S	50FH-020-10	2017.8.20	2018.8.19
10	HF 907 Double-Ridged Waveguide Horn Antenna	R&S	100512	2017.8.20	2018.8.19
11	HF 907 Double-Ridged Waveguide Horn Antenna	R&S	100513	2017.8.20	2018.8.19
12	PS2000 Turn Table	FRANKONIA	-----	2017.8.20	2018.8.19
13	MA260 Antenna Master	FRANKONIA	-----	2017.8.20	2018.8.19
14	ES-K1EMI test software	R&S	-----	2017.8.20	2018.8.19
15	HL562 Receive antenna	R&S	100167	2017.8.20	2018.8.19
16	HFH2-Z2	R&S	100068	2017.8.20	2018.8.19

Appendix

Appendix1 Test Setup