

## TEST REPORT

**Product** : reMarkable 2  
**Trade mark** : reMarkable  
**Model/Type reference** : RM110, RM111, RM112, RM113  
**Serial Number** : 2c7ce3579f1  
**Report Number** : EED32N80457602  
**FCC ID** : 2AMK2-RM110B  
**Date of Issue** : Aug. 24, 2021  
**Test Standards** : 47 CFR Part 15 Subpart E  
**Test result** : PASS

Prepared for:

**reMarkable AS**

**Biermanns gate 6, 0473 Oslo, Norway**

Prepared by:

**Centre Testing International Group Co., Ltd.**

**Hongwei Industrial Zone, Bao'an 70 District,**

**Shenzhen, Guangdong, China**

**TEL: +86-755-3368 3668**

**FAX: +86-755-3368 3385**



Compiled by:

*Tom Chen*

Tom Chen

Approved by:

*David Wang*

David Wang

Reviewed by:

*Aaron Ma*

Aaron Ma

Date:

Aug. 24 2021

Check No.:1021080621

## 2 Content

<b>1 COVER PAGE</b> .....	<b>1</b>
<b>2 CONTENT</b> .....	<b>2</b>
<b>3 VERSION</b> .....	<b>3</b>
<b>4 TEST SUMMARY</b> .....	<b>4</b>
<b>5 GENERAL INFORMATION</b> .....	<b>5</b>
5.1 CLIENT INFORMATION.....	5
5.2 GENERAL DESCRIPTION OF EUT.....	5
5.3 TEST CONFIGURATION.....	7
5.4 TEST ENVIRONMENT.....	7
5.5 DESCRIPTION OF SUPPORT UNITS.....	8
5.6 TEST LOCATION.....	8
5.7 DEVIATION FROM STANDARDS.....	8
5.8 ABNORMALITIES FROM STANDARD CONDITIONS.....	8
5.9 OTHER INFORMATION REQUESTED BY THE CUSTOMER.....	8
5.10 MEASUREMENT UNCERTAINTY (95% CONFIDENCE LEVELS, K=2).....	8
<b>6 EQUIPMENT LIST</b> .....	<b>9</b>
<b>7 RADIO TECHNICAL REQUIREMENTS SPECIFICATION</b> .....	<b>11</b>
7.1 ANTENNA REQUIREMENT.....	11
7.2 AC POWER LINE CONDUCTED EMISSIONS.....	12
7.3 MAXIMUM CONDUCTED OUTPUT POWER.....	15
7.4 6dB EMISSION BANDWIDTH.....	16
7.5 26dB EMISSION BANDWIDTH AND 99% OCCUPIED BANDWIDTH.....	17
7.6 MAXIMUM POWER SPECTRAL DENSITY.....	18
7.7 FREQUENCY STABILITY.....	19
7.8 RADIATED EMISSION.....	20
7.9 RADIATED EMISSION WHICH FALL IN THE RESTRICTED BANDS.....	31
<b>8 APPENDIX A</b> .....	<b>50</b>
<b>PHOTOGRAPHS OF TEST SETUP</b> .....	<b>51</b>
<b>PHOTOGRAPHS OF EUT CONSTRUCTIONAL DETAILS</b> .....	<b>53</b>

### 3 Version

Version No.	Date	Description
00	Aug. 24, 2021	Original

## 4 Test Summary

Test Item	Test Requirement	Result
Antenna Requirement	47 CFR Part 15 Subpart C Section 15.203	PASS
AC Power Line Conducted Emission	47 CFR Part 15 Subpart E Section 15.407 (b)(6)	PASS
Duty Cycle	47 CFR Part 15 Subpart E Section 15.407	PASS
Maximum Conducted Output Power	47 CFR Part 15 Subpart E Section 15.407 (a)	PASS
26dB emission bandwidth	47 CFR Part 15 Subpart E Section 15.407 (a)	PASS
99% Occupied bandwidth	\	PASS
6dB emission bandwidth	47 CFR Part 15 Subpart E Section 15.407 (e)	PASS
Maximum Power Spectral Density	47 CFR Part 15 Subpart E Section 15.407 (a)	PASS
Frequency stability	47 CFR Part 15 Subpart E Section 15.407 (g)	PASS
Radiated Emissions	47 CFR Part 15 Subpart E Section 15.407 (b)	PASS
Radiated Emissions which fall in the restricted bands	47 CFR Part 15 Subpart E Section 15.407 (b)	PASS

**Remark:**

Company Name and Address shown on Report, the sample(s) and sample Information were provided by the applicant who should be responsible for the authenticity which CTI hasn't verified.

Model No.: RM110, RM111, RM112, RM113

Only the model RM110 was tested, The added models and original model: The Electrical circuit design, Layout, components and internal wiring are identical. Only the model name and packaging contents are different.

## 5 General Information

### 5.1 Client Information

Applicant:	reMarkable AS
Address of Applicant:	Biermanns gate 6, 0473 Oslo, Norway
Manufacturer:	reMarkable AS
Address of Manufacturer:	Biermanns gate 6, 0473 Oslo, Norway
Factory:	Dongguan Kaifa Technology Co., Ltd.
Address of Factory:	No.2 Junma Road, Chigang Community, Humen Town, Dongguan City, Guangdong Province, 523921. P. R. China

### 5.2 General Description of EUT

Product Name:	reMarkable 2	
Model No.(EUT):	RM110, RM111, RM112, RM113	
Test Model No:	RM110	
Trade mark:	<b>reMarkable</b>	
Product Type:	<input type="checkbox"/> Mobile <input checked="" type="checkbox"/> Portable <input type="checkbox"/> Fix Location	
Type of Modulation:	IEEE 802.11a: OFDM (BPSK, QPSK, 16QAM, 64QAM) IEEE 802.11n(HT20): OFDM (BPSK, QPSK, 16QAM, 64QAM)	
Operating Frequency	U-NII-1: 5180-5240MHz U-NII-3: 5745-5825MHz	
Operating Temperature:	-0°C to +35°C	
Antenna Type:	PCB Antenna	
Antenna Gain:	6.35dBi	
Power Supply:	USB Port	DC 5V
	Battery:	Model: Fusion DC 3.85V 3000mAh 11.55Wh
Test voltage:	Battery 3.85V	
Sample Received Date:	Jun. 11, 2021	
Sample tested Date:	Jun. 11, 2021 to Aug. 12, 2021	

Operation Frequency each of channel

802.11a/802.11n Frequency/Channel Operations:

U-NII-1		U-NII-3	
Channel	Frequency(MHz)	Channel	Frequency(MHz)
36	5180	149	5745
40	5200	153	5765
44	5220	157	5785
48	5240	161	5805
-	-	165	5825

Note:

In section 15.31(m), regards to the operating frequency range over 10 MHz, the lowest frequency, the middle frequency, and the highest frequency of channel were selected to perform the test, and the selected channel see below:

### 5.3 Test Configuration

EUT Test Software Settings:	
Software:	PUTTY
EUT Power Grade:	Default
Use test software to set the lowest frequency, the middle frequency and the highest frequency keep transmitting of the EUT.	
Test Mode:	
We have verified the construction and function in typical operation. All the test modes were carried out with the EUT in transmitting operation, which was shown in this test report and defined as follows:	
<b>Per-scan all kind of data rate in lowest channel, and found the follow list which it was worst case.</b>	
Mode	Data rate
802.11a	6 Mbps
802.11n(HT20)	MCS0

### 5.4 Test Environment

Operating Environment:		
Radiated Spurious Emissions:		
Temperature:	22~25.0 °C	
Humidity:	50~56 % RH	
Atmospheric Pressure:	1010mbar	
Conducted Emissions:		
Temperature:	22~26.0 °C	
Humidity:	50~56 % RH	
Atmospheric Pressure:	1010mbar	
RF Conducted:		
Humidity:	50~55 % RH	
Atmospheric Pressure:	1010mbar	
Temperature:	NT (Normal Temperature)	22~25.0 °C
	LT (Low Temperature)	0 °C
	HT (High Temperature)	35.0 °C
Working Voltage of the EUT:	NV (Normal Voltage)	3.85V
	LV (Low Voltage)	3.55V
	HV (High Voltage)	4.4 V

### 5.5 Description of Support Units

The EUT has been tested with associated equipment below.

1) support equipment

Description	Manufacturer	Model No.	Certification	Supplied by
QUICK CHARGE	Shenzhen GOOD-SHE Technology Co., Ltd.	GS-551B	FCC	Client

2) cable

Cable No.	Description	Manufacturer	Cable Type/Length	Supplied by
1	USB Cable	Dongguan Kaifa Technology Co., Ltd.	Shielded (100cm)	Client

### 5.6 Test Location

All tests were performed at:

Centre Testing International Group Co., Ltd  
 Building C, Hongwei Industrial Park Block 70, Bao'an District, Shenzhen, China  
 Telephone: +86 (0) 755 33683668 Fax:+86 (0) 755 33683385  
 No tests were sub-contracted.

FCC Designation No.: CN1164

### 5.7 Deviation from Standards

None.

### 5.8 Abnormalities from Standard Conditions

None.

### 5.9 Other Information Requested by the Customer

None.

### 5.10 Measurement Uncertainty (95% confidence levels, k=2)

No.	Item	Measurement Uncertainty
1	Radio Frequency	7.9 x 10 <sup>-8</sup>
2	RF power, conducted	0.46dB (30MHz-1GHz)
		0.55dB (1GHz-18GHz)
3	Radiated Spurious emission test	3.3dB (9kHz-30MHz)
		4.5dB (30MHz-1GHz)
		4.8dB (1GHz-18GHz)
		3.4dB (18GHz-40GHz)
4	Conduction emission	3.5dB (9kHz to 150kHz)
		3.1dB (150kHz to 30MHz)
5	Temperature test	0.64°C
6	Humidity test	3.8%
7	DC power voltages	0.026%



## 6 Equipment List

Conducted disturbance Test					
Equipment	Manufacturer	Model No.	Serial Number	Cal. date (mm-dd-yyyy)	Cal. Due date (mm-dd-yyyy)
Receiver	R&S	ESCI	100435	04-27-2021	04-26-2022
Temperature/ Humidity Indicator	Defu	TH128	/	---	---
LISN	R&S	ENV216	100098	03-04-2021	03-03-2022
Barometer	changchun	DYM3	1188	---	---

RF test system					
Equipment	Manufacturer	Mode No.	Serial Number	Cal. Date (mm-dd-yyyy)	Cal. Due date (mm-dd-yyyy)
Spectrum Analyzer	Keysight	N9010A	MY54510339	12-28-2020	12-27-2021
Signal Generator	Keysight	N5182B	MY53051549	12-28-2020	12-27-2021
Signal Generator	Keysight	E8257D	MY53401106	12-28-2020	12-27-2021
Temperature/ Humidity Indicator	biaozhi	HM10	1804186	06-29-2020 06-28-2021	06-28-2021 06-27-2022
High-pass filter	Sinoscite	FL3CX03WG18 NM12-0398-002	---	---	---
High-pass filter	MICRO- TRONICS	SPA-F-63029-4	---	---	---
DC Power	Keysight	E3642A	MY56376072	12-28-2020	12-27-2021
Power unit	R&S	OSP120	101374	12-28-2020	12-27-2021
RF control unit	JS Tonscend	JS0806-2	158060006	12-28-2020	12-27-2021
BT&WI-FI Automatic test software	JS Tonscend	JS1120-3	---	---	---

3M Semi/full-anechoic Chamber					
Equipment	Manufacturer	Model No.	Serial Number	Cal. date (mm-dd-yyyy)	Cal. Due date (mm-dd-yyyy)
3M Chamber & Accessory Equipment	TDK	SAC-3	---	05-24-2019	05-23-2022
TRILOG Broadband Antenna	Schwarzbeck	VULB9163	9163-618	05-16-2021	05-15-2022
Loop Antenna	Schwarzbeck	FMZB 1519B	1519B-076	04-15-2021	04-14-2024
Receiver	R&S	ESCI7	100938-003	10-16-2020	10-15-2021
Multi device Controller	maturu	NCD/070/10711 112	---	---	---
Temperature/ Humidity Indicator	Shanghai qixiang	HM10	1804298	06-29-2020 06-23-2021	06-28-2021 06-22-2022
Communication test set	Agilent	E5515C	GB47050534	03-01-2019	02-28-2022
Cable line	Fulai(7M)	SF106	5219/6A	---	---
Cable line	Fulai(6M)	SF106	5220/6A	---	---
Cable line	Fulai(3M)	SF106	5216/6A	---	---
Cable line	Fulai(3M)	SF106	5217/6A	---	---
band rejection filter	Sinoscite	FL5CX01CA08 CL12-0393-001	---	---	---

3M full-anechoic Chamber					
Equipment	Manufacturer	Model No.	Serial Number	Cal. date (mm-dd-yyyy)	Cal. Due date (mm-dd-yyyy)
RSE Automatic test software	JS Tonscend	JS36-RSE	10166	---	---
Receiver	Keysight	N9038A	MY57290136	03-04-2021	03-03-2022
Spectrum Analyzer	Keysight	N9020B	MY57111112	03-04-2021	03-03-2022
Spectrum Analyzer	Keysight	N9030B	MY57140871	03-04-2021	03-03-2022
TRILOG Broadband Antenna	Schwarzbeck	VULB 9163	9163-1148	04-28-2021	04-27-2024
Horn Antenna	Schwarzbeck	BBHA 9170	9170-832	04-15-2021	04-14-2024
Communication Antenna	Schwarzbeck	CLSA 0110L	1014	---	---
Horn Antenna	ETS-LINDGREN	3117	57407	07-10-2018 07-04-2021	07-09-2021 07-03-2024
Preamplifier	EMCI	EMC184055SE	980597	05-20-2021	05-19-2022
Communication test set	R&S	CMW500	102898	12-31-2020	12-30-2021
Preamplifier	EMCI	EMC001330	980563	04-15-2021	04-14-2022
Preamplifier	JS Tonscend	980380	EMC051845 SE	12-31-2020	12-30-2021
Temperature/ Humidity Indicator	biaozhi	GM1360	EE1186631	04-16-2021	04-15-2022
Fully Anechoic Chamber	TDK	FAC-3	---	01-09-2021	01-08-2024
Cable line	Times	SFT205-NMSM-2.50M	394812-0001	---	---
Cable line	Times	SFT205-NMSM-2.50M	394812-0002	---	---
Cable line	Times	SFT205-NMSM-2.50M	394812-0003	---	---
Cable line	Times	SFT205-NMSM-2.50M	393495-0001	---	---
Cable line	Times	EMC104-NMNM-1000	SN160710	---	---
Cable line	Times	SFT205-NMSM-3.00M	394813-0001	---	---
Cable line	Times	SFT205-NMNM-1.50M	381964-0001	---	---
Cable line	Times	SFT205-NMSM-7.00M	394815-0001	---	---
Cable line	Times	HF160-KMKM-3.00M	393493-0001	---	---

## 7 Radio Technical Requirements Specification

### 7.1 Antenna Requirement

<b>Standard requirement:</b>	47 CFR Part 15C Section 15.203
15.203 requirement: An intentional radiator shall be designed to ensure that no antenna other than that furnished by the responsible party shall be used with the device. The use of a permanently attached antenna or of an antenna that uses a unique coupling to the intentional radiator, the manufacturer may design the unit so that a broken antenna can be replaced by the user, but the use of a standard antenna jack or electrical connector is prohibited.	
<b>EUT Antenna:</b>	Please see Internal photos
The antenna is PCB antenna. The best case gain of the antenna is 6.35dBi.	

## 7.2 AC Power Line Conducted Emissions

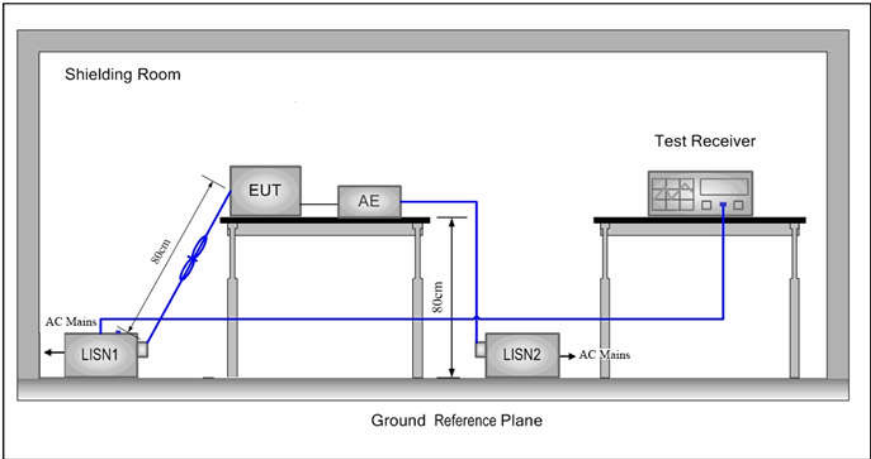
Test Requirement:	47 CFR Part 15C Section 15.207															
Test Method:	ANSI C63.10: 2013															
Test Frequency Range:	150kHz to 30MHz															
Receiver setup:	RBW=9 kHz, VBW=30 kHz, Sweep time=auto															
Limit:	<table border="1"> <thead> <tr> <th rowspan="2">Frequency range (MHz)</th> <th colspan="2">Limit (dBuV)</th> </tr> <tr> <th>Quasi-peak</th> <th>Average</th> </tr> </thead> <tbody> <tr> <td>0.15-0.5</td> <td>66 to 56*</td> <td>56 to 46*</td> </tr> <tr> <td>0.5-5</td> <td>56</td> <td>46</td> </tr> <tr> <td>5-30</td> <td>60</td> <td>50</td> </tr> </tbody> </table>		Frequency range (MHz)	Limit (dBuV)		Quasi-peak	Average	0.15-0.5	66 to 56*	56 to 46*	0.5-5	56	46	5-30	60	50
	Frequency range (MHz)	Limit (dBuV)														
		Quasi-peak	Average													
	0.15-0.5	66 to 56*	56 to 46*													
0.5-5	56	46														
5-30	60	50														
* Decreases with the logarithm of the frequency.																
Test Setup:																
Test Procedure:	<ol style="list-style-type: none"> <li>1) The mains terminal disturbance voltage test was conducted in a shielded room.</li> <li>2) The EUT was connected to AC power source through a LISN 1 (Line Impedance Stabilization Network) which provides a <math>50\Omega/50\mu\text{H} + 5\Omega</math> linear impedance. The power cables of all other units of the EUT were connected to a second LISN 2, which was bonded to the ground reference plane in the same way as the LISN 1 for the unit being measured. A multiple socket outlet strip was used to connect multiple power cables to a single LISN provided the rating of the LISN was not exceeded.</li> <li>3) The tabletop EUT was placed upon a non-metallic table 0.8m above the ground reference plane. And for floor-standing arrangement, the EUT was placed on the horizontal ground reference plane.</li> <li>4) The test was performed with a vertical ground reference plane. The rear of the EUT shall be 0.4 m from the vertical ground reference plane. The vertical ground reference plane was bonded to the horizontal ground reference plane. The LISN 1 was placed 0.8 m from the boundary of the unit under test and bonded to a ground reference plane for LISNs mounted on top of the ground reference plane. This distance was between the closest points of the LISN 1 and the EUT. All other units of the EUT and associated equipment was at least 0.8 m from the LISN 2.</li> <li>5) In order to find the maximum emission, the relative positions of equipment and all of the interface cables must be changed according to ANSI C63.10: 2013 on conducted measurement.</li> </ol>															
Test Mode:	All modes were tested, only the worst case lowest channel of 6Mbps for 802.11a was recorded in the report.															
Test Results:	Pass															

## Measurement Data

Live line:

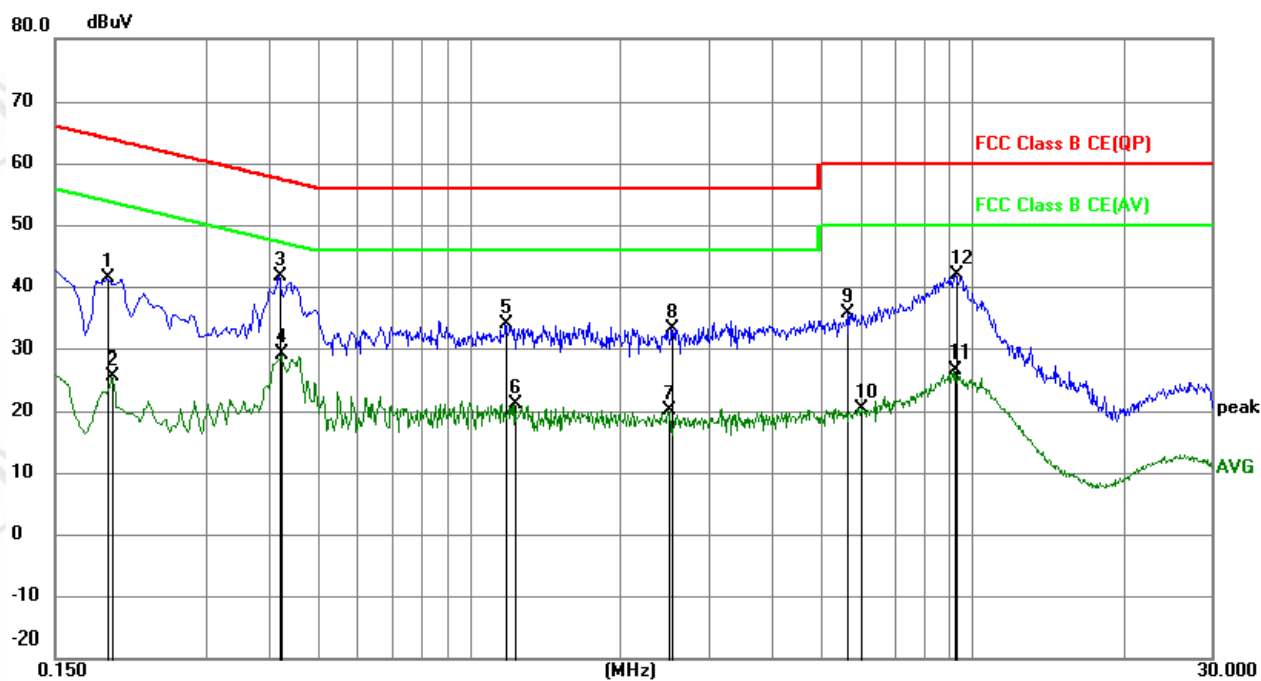

No.	Mk.	Freq. MHz	Reading Level dBuV	Correct Factor dB	Measure- ment dBuV	Limit dBuV	Margin dB	Detector	Comment
1		0.1905	31.39	9.87	41.26	64.01	-22.75	peak	
2		0.1949	15.70	9.87	25.57	53.83	-28.26	AVG	
3	*	0.4200	31.71	9.97	41.68	57.45	-15.77	peak	
4		0.4245	19.28	9.97	29.25	47.36	-18.11	AVG	
5		1.1805	24.13	9.82	33.95	56.00	-22.05	peak	
6		1.2345	11.38	9.82	21.20	46.00	-24.80	AVG	
7		2.4945	10.29	9.79	20.08	46.00	-25.92	AVG	
8		2.5350	23.45	9.79	33.24	56.00	-22.76	peak	
9		5.6400	25.92	9.78	35.70	60.00	-24.30	peak	
10		6.0090	10.69	9.78	20.47	50.00	-29.53	AVG	
11		9.2084	16.84	9.78	26.62	50.00	-23.38	AVG	
12		9.2805	32.18	9.78	41.96	60.00	-18.04	peak	

Remark:

1. The following Quasi-Peak and Average measurements were performed on the EUT:
2. Final Test Level = Receiver Reading + LISN Factor + Cable Loss.
3. If the Peak value under Average limit, the Average value is not recorded in the report.

Neutral line:  
80.0 dBuV

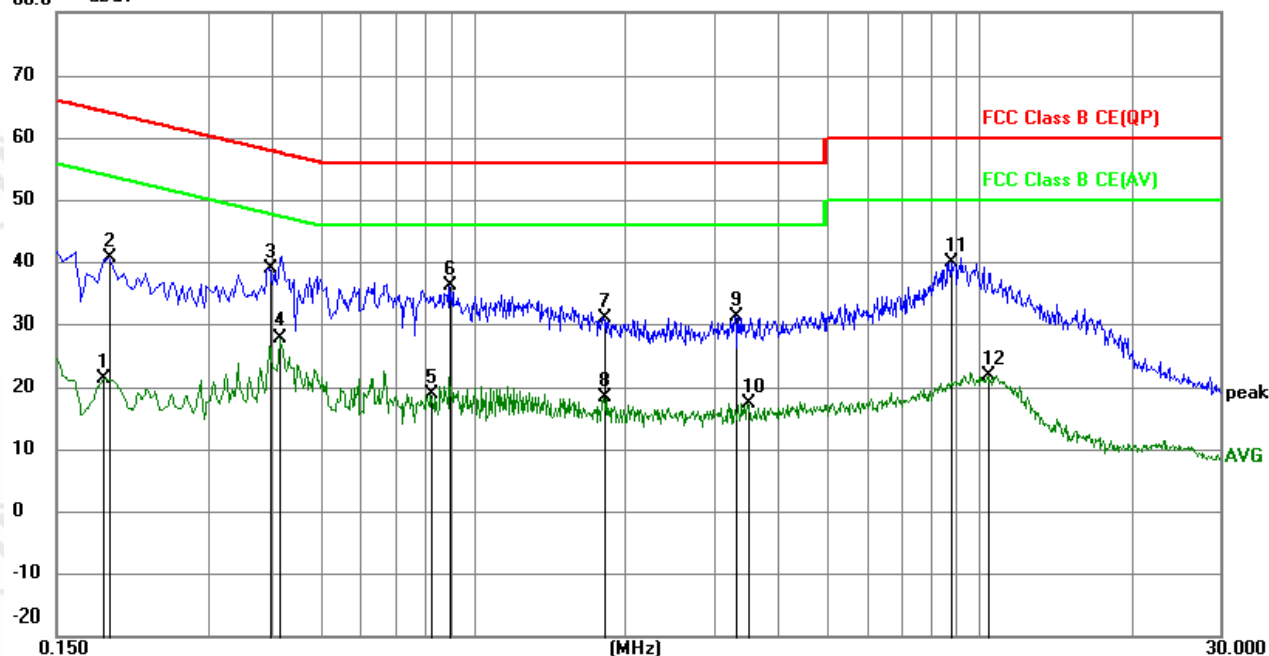

No.	Mk.	Freq. MHz	Reading Level dBuV	Correct Factor dB	Measure- ment dBuV	Limit dBuV	Margin dB	Detector	Comment
1		0.1860	11.62	9.87	21.49	54.21	-32.72	AVG	
2		0.1905	30.82	9.87	40.69	64.01	-23.32	peak	
3	*	0.3975	28.93	9.97	38.90	57.91	-19.01	peak	
4		0.4155	18.02	9.97	27.99	47.54	-19.55	AVG	
5		0.8250	9.03	9.85	18.88	46.00	-27.12	AVG	
6		0.8970	26.22	9.85	36.07	56.00	-19.93	peak	
7		1.8105	21.12	9.80	30.92	56.00	-25.08	peak	
8		1.8105	8.58	9.80	18.38	46.00	-27.62	AVG	
9		3.3090	21.34	9.79	31.13	56.00	-24.87	peak	
10		3.4935	7.50	9.78	17.28	46.00	-28.72	AVG	
11		8.7765	30.05	9.78	39.83	60.00	-20.17	peak	
12		10.4415	12.20	9.79	21.99	50.00	-28.01	AVG	

Remark:

1. The following Quasi-Peak and Average measurements were performed on the EUT:
2. Final Test Level = Receiver Reading + LISN Factor + Cable Loss.
3. If the Peak value under Average limit, the Average value is not recorded in the report.

## 7.3 Maximum Conducted Output Power

Test Requirement:	47 CFR Part 15C Section 15.407 (a)													
Test Method:	KDB789033 D02 General UNII Test Procedures New Rules v02r01 Section E													
Test Setup:														
Test Procedure:	<ol style="list-style-type: none"> <li>1. The testing follows the Measurement Procedure of KDB789033 D02 General UNII Test Procedures New Rules v02r01 Section E, 3, a</li> <li>2. The RF output of EUT was connected to the power meter by RF cable and attenuator. The path loss was compensated to the results for each measurement.</li> <li>3. Set to the maximum power setting and enable the EUT transmit continuously.</li> <li>4. Measure the conducted output power and record the results in the test report.</li> </ol>													
Limit:	<table border="1"> <thead> <tr> <th>Frequency band (MHz)</th> <th>Limit</th> </tr> </thead> <tbody> <tr> <td rowspan="2">5150-5250</td> <td>≤1W(30dBm) for master device</td> </tr> <tr> <td>≤250mW(24dBm) for client device</td> </tr> <tr> <td>5250-5350</td> <td>≤250mW(24dBm) for client device or 11dBm+10logB*</td> </tr> <tr> <td>5470-5725</td> <td>≤250mW(24dBm) for client device or 11dBm+10logB*</td> </tr> <tr> <td>5725-5850</td> <td>≤1W(30dBm)</td> </tr> <tr> <td>Remark:</td> <td>* Where B is the 26dB emission bandwidth in MHz. The maximum conducted output power must be measured over any interval of continuous transmission using instrumentation calibrated in terms of an rms-equivalent voltage.</td> </tr> </tbody> </table>	Frequency band (MHz)	Limit	5150-5250	≤1W(30dBm) for master device	≤250mW(24dBm) for client device	5250-5350	≤250mW(24dBm) for client device or 11dBm+10logB*	5470-5725	≤250mW(24dBm) for client device or 11dBm+10logB*	5725-5850	≤1W(30dBm)	Remark:	* Where B is the 26dB emission bandwidth in MHz. The maximum conducted output power must be measured over any interval of continuous transmission using instrumentation calibrated in terms of an rms-equivalent voltage.
Frequency band (MHz)	Limit													
5150-5250	≤1W(30dBm) for master device													
	≤250mW(24dBm) for client device													
5250-5350	≤250mW(24dBm) for client device or 11dBm+10logB*													
5470-5725	≤250mW(24dBm) for client device or 11dBm+10logB*													
5725-5850	≤1W(30dBm)													
Remark:	* Where B is the 26dB emission bandwidth in MHz. The maximum conducted output power must be measured over any interval of continuous transmission using instrumentation calibrated in terms of an rms-equivalent voltage.													
Test Mode:	Transmitting mode with modulation													
Test Results:	Refer to Appendix A													

## 7.4 6dB Emission Bandwidth

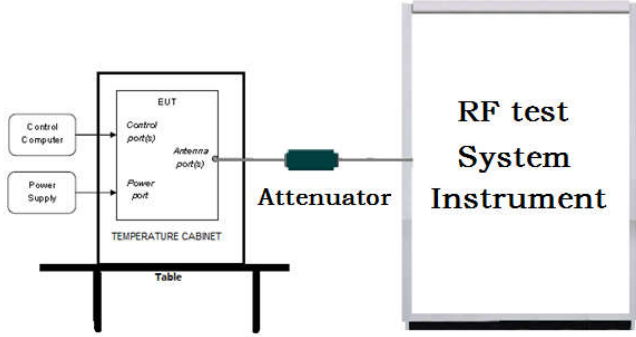
Test Requirement:	47 CFR Part 15C Section 15.407 (e)
Test Method:	KDB789033 D02 General UNII Test Procedures New Rules v02r01 Section C
Test Setup:	 <p>Remark: Offset=Cable loss+ attenuation factor.</p>
Test Procedure:	<ol style="list-style-type: none"> <li>1. KDB789033 D02 General UNII Test Procedures New Rules v02r01 Section C</li> <li>2. Set to the maximum power setting and enable the EUT transmit continuously.</li> <li>3. Make the measurement with the spectrum analyzer's resolution bandwidth (RBW) = 100 kHz. Set the Video bandwidth (VBW) = 300 kHz. In order to make an accurate measurement. The 6dB bandwidth must be greater than 500 kHz.</li> <li>4. Measure and record the results in the test report.</li> </ol>
Limit:	≥ 500 kHz
Test Mode:	Transmitting mode with modulation
Test Results:	Refer to Appendix A

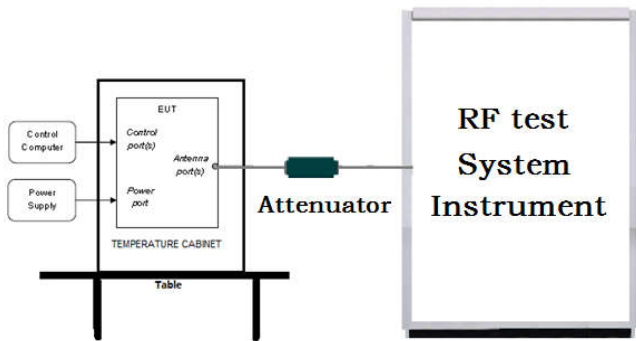

## 7.5 26dB Emission Bandwidth and 99% Occupied Bandwidth

Test Requirement:	47 CFR Part 15C Section 15.407 (a)
Test Method:	KDB789033 D02 General UNII Test Procedures New Rules v02r01 Section D
Test Setup:	 <p>Remark: Offset=Cable loss+ attenuation factor.</p>
Test Procedure:	<ol style="list-style-type: none"> <li>1. KDB789033 D02 General UNII Test Procedures New Rules v02r01 Section D</li> <li>2. Set to the maximum power setting and enable the EUT transmit continuously.</li> <li>3. Make the measurement with the spectrum analyzer's resolution bandwidth (RBW) = 100 kHz. Set the Video bandwidth (VBW) = 300 kHz. In order to make an accurate measurement.</li> <li>4. Measure and record the results in the test report.</li> </ol>
Limit:	No restriction limits
Test Mode:	Transmitting mode with modulation
Test Results:	Refer to Appendix A

## 7.6 Maximum Power Spectral Density

Test Requirement:	47 CFR Part 15C Section 15.407 (a)													
Test Method:	KDB789033 D02 General UNII Test Procedures New Rules v02r01 Section F													
Test Setup:	<p>Remark: Offset=Cable loss+ attenuation factor.</p>													
Test Procedure:	<ol style="list-style-type: none"> <li>1. Set the spectrum analyzer or EMI receiver span to view the entire emission bandwidth. 1. Set RBW = 510 kHz/1 MHz, VBW ≥ 3*RBW, Sweep time = Auto, Detector = RMS.</li> <li>2. Allow the sweeps to continue until the trace stabilizes.</li> <li>3. Use the peak marker function to determine the maximum amplitude level.</li> </ol>													
Limit:	<table border="1"> <thead> <tr> <th>Frequency band (MHz)</th> <th>Limit</th> </tr> </thead> <tbody> <tr> <td rowspan="2">5150-5250</td> <td>≤17dBm in 1MHz for master device</td> </tr> <tr> <td>≤11dBm in 1MHz for client device</td> </tr> <tr> <td>5250-5350</td> <td>≤11dBm in 1MHz for client device</td> </tr> <tr> <td>5470-5725</td> <td>≤11dBm in 1MHz for client device</td> </tr> <tr> <td>5725-5850</td> <td>≤30dBm in 500kHz</td> </tr> <tr> <td>Remark:</td> <td>The maximum power spectral density is measured as a conducted emission by direct connection of a calibrated test instrument to the equipment under test.</td> </tr> </tbody> </table>	Frequency band (MHz)	Limit	5150-5250	≤17dBm in 1MHz for master device	≤11dBm in 1MHz for client device	5250-5350	≤11dBm in 1MHz for client device	5470-5725	≤11dBm in 1MHz for client device	5725-5850	≤30dBm in 500kHz	Remark:	The maximum power spectral density is measured as a conducted emission by direct connection of a calibrated test instrument to the equipment under test.
Frequency band (MHz)	Limit													
5150-5250	≤17dBm in 1MHz for master device													
	≤11dBm in 1MHz for client device													
5250-5350	≤11dBm in 1MHz for client device													
5470-5725	≤11dBm in 1MHz for client device													
5725-5850	≤30dBm in 500kHz													
Remark:	The maximum power spectral density is measured as a conducted emission by direct connection of a calibrated test instrument to the equipment under test.													
Test Mode:	Transmitting mode with modulation													
Test Results:	Refer to Appendix A													

## 7.7 Frequency Stability

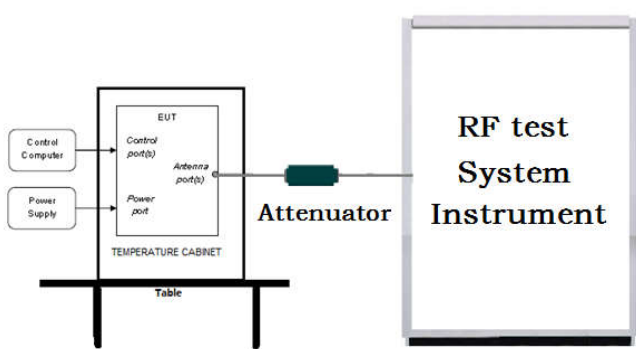
Test Requirement:	47 CFR Part 15C Section 15.407 (g)
Test Method:	ANSI C63.10: 2013
Test Setup:	 <p>Remark: Offset=Cable loss+ attenuation factor.</p>
Test Procedure:	<ol style="list-style-type: none"> <li>1.The EUT was placed inside the environmental test chamber and powered by nominal AC/DC voltage.</li> <li>2. Turn the EUT on and couple its output to a spectrum analyzer.</li> <li>3. Turn the EUT off and set the chamber to the highest temperature specified. d. Allow sufficient time (approximately 30 min) for the temperature of the chamber to stabilize.</li> <li>4. Repeat step 2 and 3 with the temperature chamber set to the lowest temperature.</li> <li>5. The test chamber was allowed to stabilize at +20 degree C for a minimum of 30 minutes. The supply voltage was then adjusted on the EUT from 85% to 115% and the frequency record.</li> </ol>
Limit:	The frequency tolerance shall be maintained within the band of operation frequency over a temperature variation of 0 degrees to 45 degrees C at normal supply voltage, and for a variation in the primary supply voltage from 85% to 115% of the rated supply voltage at a temperature of 20 degrees C.
Test Mode:	Transmitting mode with modulation
Test Results:	Refer to Appendix A

### 7.8 Radiated Emission

Test Requirement:	47 CFR Part 15C Section 15.209 and 15.407 (b)				
Test Method:	ANSI C63.10 2013				
Test Site:	Measurement Distance: 3m (Semi-Anechoic Chamber)				
Receiver Setup:	Frequency	Detector	RBW	VBW	Remark
	0.009MHz-0.090MHz	Peak	10kHz	30kHz	Peak
	0.009MHz-0.090MHz	Average	10kHz	30kHz	Average
	0.090MHz-0.110MHz	Quasi-peak	10kHz	30kHz	Quasi-peak
	0.110MHz-0.490MHz	Peak	10kHz	30kHz	Peak
	0.110MHz-0.490MHz	Average	10kHz	30kHz	Average
	0.490MHz-30MHz	Quasi-peak	10kHz	30kHz	Quasi-peak
	30MHz-1GHz	Quasi-peak	100 kHz	300kHz	Quasi-peak
	Above 1GHz	Peak	1MHz	3MHz	Peak
Peak		1MHz	10kHz	Average	
Limit:	Frequency	Field strength (microvolt/meter)	Limit (dBuV/m)	Remark	Measurement distance (m)
	0.009MHz-0.490MHz	2400/F(kHz)	-	-	300
	0.490MHz-1.705MHz	24000/F(kHz)	-	-	30
	1.705MHz-30MHz	30	-	-	30
	30MHz-88MHz	100	40.0	Quasi-peak	3
	88MHz-216MHz	150	43.5	Quasi-peak	3
	216MHz-960MHz	200	46.0	Quasi-peak	3
	960MHz-1GHz	500	54.0	Quasi-peak	3
	Above 1GHz	500	54.0	Average	3
	<p>*(1) For transmitters operating in the 5.15-5.25 GHz band: All emissions outside of the 5.15-5.35 GHz band shall not exceed an e.i.r.p. of -27 dBm/MHz.</p> <p>(2) For transmitters operating in the 5.25-5.35 GHz band: All emissions outside of the 5.15-5.35 GHz band shall not exceed an e.i.r.p. of -27 dBm/MHz.</p> <p>(3) For transmitters operating in the 5.47-5.725 GHz band: All emissions outside of the 5.47-5.725 GHz band shall not exceed an e.i.r.p. of -27 dBm/MHz.</p> <p>(4) For transmitters operating in the 5.725-5.85 GHz band:</p> <p>(i) All emissions shall be limited to a level of -27 dBm/MHz at 75 MHz or more above or below the band edge increasing linearly to 10 dBm/MHz at 25 MHz above or below the band edge, and from 25 MHz above or below the band edge increasing linearly to a level of 15.6 dBm/MHz at 5 MHz above or below the band edge, and from 5 MHz above or below the band edge increasing linearly to a level of 27 dBm/MHz at the band edge.</p> <p>Remark: The emission limits shown in the above table are based on measurements employing a CISPR quasi-peak detector except for the frequency bands 9-90kHz, 110-490kHz and above 1000 MHz. Radiated emission limits in these three bands are based on measurements employing an average detector, the peak field strength of any emission shall not exceed the maximum permitted average limits specified above by more than 20 dB under any condition of modulation.</p> <p>Note:</p> <p>(j) <math>EIRP = ((E*d)^2) / 30</math></p>				

where:

- E is the field strength in V/m;
  - d is the measurement distance in meters;
  - EIRP is the equivalent isotropically radiated power in watts.
- (ii) Working in dB units, the above equation is equivalent to:  

$$\text{EIRP}[\text{dBm}] = E[\text{dB}\mu\text{V/m}] + 20 \log(d[\text{meters}]) - 104.77$$
- (iii) Or, if d is 3 meters:  

$$\text{EIRP}[\text{dBm}] = E[\text{dB}\mu\text{V/m}] - 95.2$$

Test Setup:

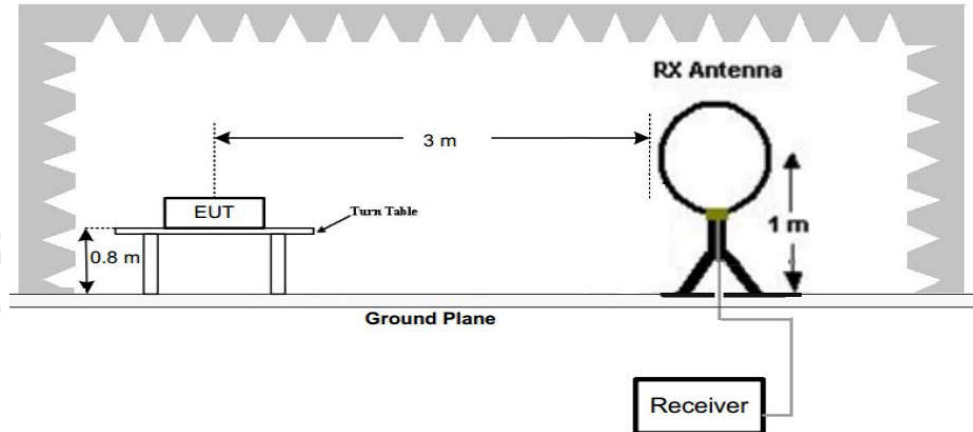

Figure 1. Below 30MHz

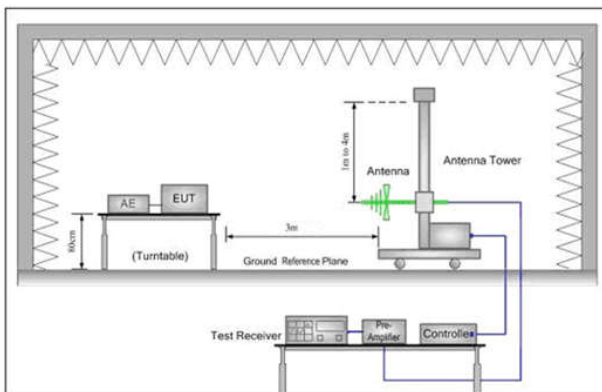

Figure 2. 30MHz to 1GHz

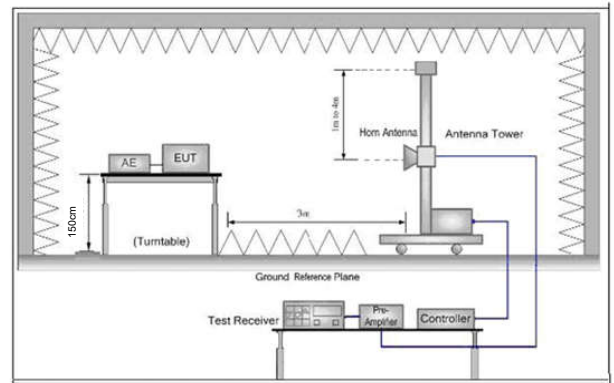

Figure 3. Above 1 GHz

Test Procedure:

- a. 1) Below 1G: The EUT was placed on the top of a rotating table 0.8 meters above the ground at a 3 meter semi-anechoic chamber. The table was rotated 360 degrees to determine the position of the highest radiation.
  - 2) Above 1G: The EUT was placed on the top of a rotating table 1.5 meters above the ground at a 3 meter semi-anechoic chamber. The table was rotated 360 degrees to determine the position of the highest radiation.
- Note: For the radiated emission test above 1GHz:  
 Place the measurement antenna away from each area of the EUT determined to be a source of emissions at the specified measurement

	<p>distance, while keeping the measurement antenna aimed at the source of emissions at each frequency of significant emissions, with polarization oriented for maximum response. The measurement antenna may have to be higher or lower than the EUT, depending on the radiation pattern of the emission and staying aimed at the emission source for receiving the maximum signal. The final measurement antenna elevation shall be that which maximizes the emissions. The measurement antenna elevation for maximum emissions shall be restricted to a range of heights of from 1 m to 4 m above the ground or reference ground plane.</p> <ul style="list-style-type: none"> <li>b. The EUT was set 3 meters away from the interference-receiving antenna, which was mounted on the top of a variable-height antenna tower.</li> <li>c. The antenna height is varied from one meter to four meters above the ground to determine the maximum value of the field strength. Both horizontal and vertical polarizations of the antenna are set to make the measurement.</li> <li>d. For each suspected emission, the EUT was arranged to its worst case and then the antenna was tuned to heights from 1 meter to 4 meters (for the test frequency of below 30MHz, the antenna was tuned to heights 1 meter) and the rotatable table was turned from 0 degrees to 360 degrees to find the maximum reading.</li> <li>e. The test-receiver system was set to Peak Detect Function and Specified Bandwidth with Maximum Hold Mode.</li> <li>f. If the emission level of the EUT in peak mode was 10dB lower than the limit specified, then testing could be stopped and the peak values of the EUT would be reported. Otherwise the emissions that did not have 10dB margin would be re-tested one by one using peak, quasi-peak or average method as specified and then reported in a data sheet.</li> <li>g. Test the EUT in the lowest channel, the middle channel and the highest channel</li> <li>h. The radiation measurements are performed in X, Y, Z axis positioning for Transmitting mode, and found the X axis positioning which it is the worst case.</li> <li>i. Repeat above procedures until all frequencies measured was complete.</li> </ul>
Test Mode:	Transmitting mode with modulation
Test Results:	Pass

## Radiated Spurious Emissions test Data: Radiated Emission below 1GHz

Remark: During the test, the Radiates Emission from 30MHz to 1GHz was performed in all modes, only the worst case lower channel of 6Mbps for 802.11a was recorded in the report.

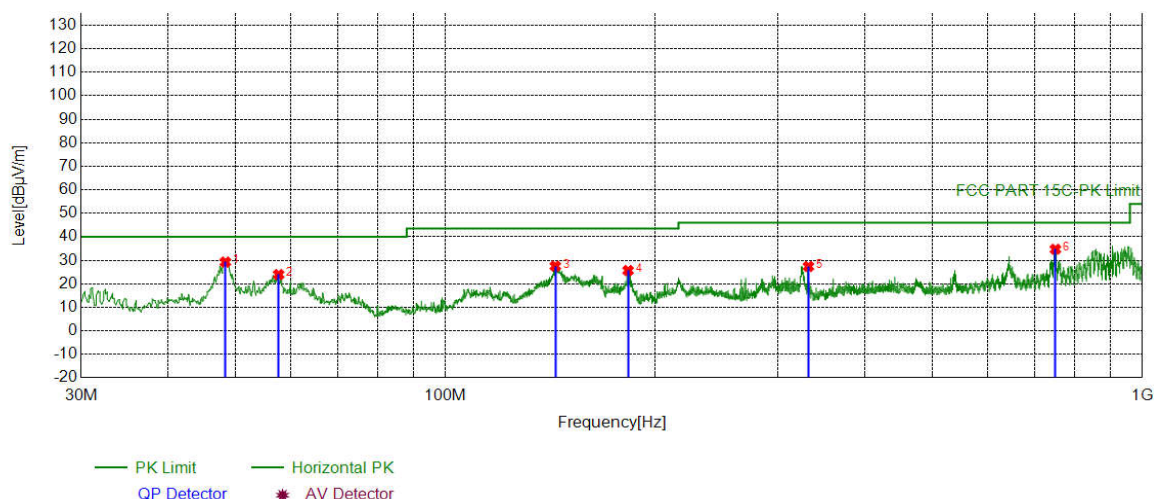

Suspected List									
NO	Freq. [MHz]	Factor [dB]	Reading [dBμV]	Level [dBμV/m]	Limit [dBμV/m]	Margin [dB]	Result	Polarity	Remark
1	48.3348	-17.17	46.44	29.27	40.00	10.73	PASS	Horizontal	PK
2	57.6478	-18.18	42.13	23.95	40.00	16.05	PASS	Horizontal	PK
3	143.7924	-21.88	49.41	27.53	43.50	15.97	PASS	Horizontal	PK
4	182.8873	-19.51	45.19	25.68	43.50	17.82	PASS	Horizontal	PK
5	331.8942	-14.66	42.03	27.37	46.00	18.63	PASS	Horizontal	PK
6	750.5881	-6.99	41.70	34.71	46.00	11.29	PASS	Horizontal	PK

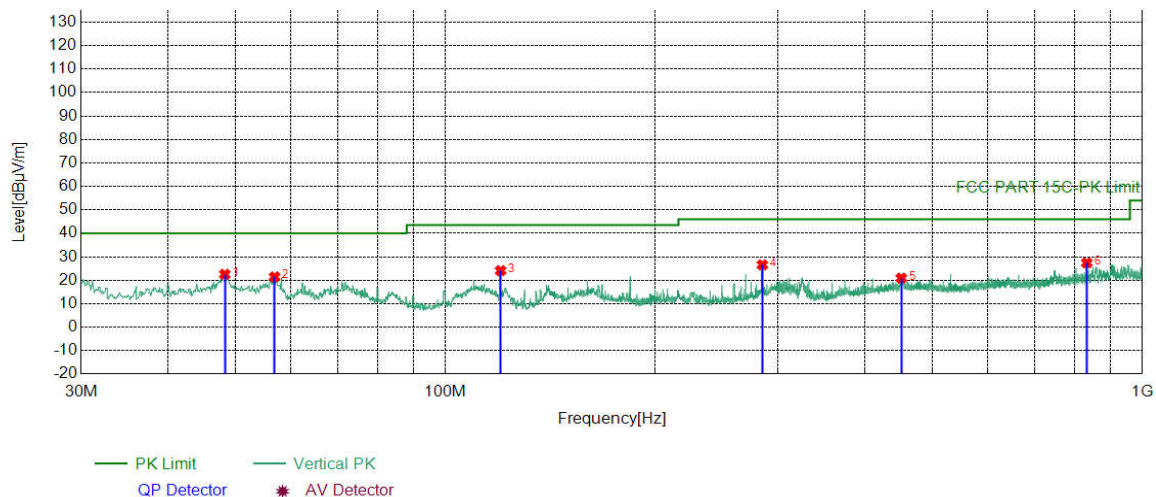

### Suspected List

NO	Freq. [MHz]	Factor [dB]	Reading [dBμV]	Level [dBμV/m]	Limit [dBμV/m]	Margin [dB]	Result	Polarity	Remark
1	48.2378	-17.17	39.71	22.54	40.00	17.46	PASS	Vertical	PK
2	56.8717	-18.08	39.52	21.44	40.00	18.56	PASS	Vertical	PK
3	120.0250	-20.08	44.18	24.10	43.50	19.40	PASS	Vertical	PK
4	285.0385	-15.83	42.41	26.58	46.00	19.42	PASS	Vertical	PK
5	451.1191	-11.71	32.61	20.90	46.00	25.10	PASS	Vertical	PK
6	832.6583	-6.02	33.43	27.41	46.00	18.59	PASS	Vertical	PK



### Transmitter Emission above 1GHz

Remark: Through Pre-scan, for 20MHz Occupied Bandwidth, 802.11 a mode was the worst case; for 40MHz Occupied Bandwidth, 802.11 n(HT40) mode was the worst case; for 80MHz Occupied Bandwidth, 802.11 ac(VHT80) mode was the worst case; only the worst case was in the report.

Mode:			802.11 a Transmitting			Channel:		5180 MHz	
NO	Freq. [MHz]	Factor [dB]	Reading [dBμV]	Level [dBμV/m]	Limit [dBμV/m]	Margin [dB]	Result	Polarity	Remark
1	1278.3278	1.08	41.37	42.45	68.20	25.75	PASS	H	PK
2	2999.4499	6.54	40.00	46.54	68.20	21.66	PASS	H	PK
3	4099.0099	9.59	38.58	48.17	68.20	20.03	PASS	H	PK
4	7834.6417	-11.31	53.42	42.11	68.20	26.09	PASS	H	PK
5	10570.0535	-6.46	52.34	45.88	68.20	22.32	PASS	H	PK
6	14364.0932	0.25	50.68	50.93	68.20	17.27	PASS	H	PK
7	1663.3663	2.81	41.43	44.24	68.20	23.96	PASS	V	PK
8	2251.3751	3.99	41.13	45.12	68.20	23.08	PASS	V	PK
9	3084.1584	6.78	41.46	48.24	68.20	19.96	PASS	V	PK
10	7440.7470	-11.40	57.05	45.65	68.20	22.55	PASS	V	PK
11	9662.0831	-7.48	55.03	47.55	68.20	20.65	PASS	V	PK
12	13672.3336	-1.71	50.93	49.22	68.20	18.98	PASS	V	PK

Mode:			802.11 a Transmitting			Channel:		5200 MHz	
NO	Freq. [MHz]	Factor [dB]	Reading [dBμV]	Level [dBμV/m]	Limit [dBμV/m]	Margin [dB]	Result	Polarity	Remark
1	2038.5039	4.79	41.30	46.09	68.20	22.11	PASS	H	PK
2	2654.0154	5.36	42.70	48.06	68.20	20.14	PASS	H	PK
3	3811.8812	8.59	39.54	48.13	68.20	20.07	PASS	H	PK
4	7653.5077	-10.88	54.51	43.63	68.20	24.57	PASS	H	PK
5	9669.5585	-7.50	53.99	46.49	68.20	21.71	PASS	H	PK
6	13675.2088	-1.71	51.81	50.10	68.20	18.10	PASS	H	PK
7	1661.1661	2.80	41.96	44.76	68.20	23.44	PASS	V	PK
8	2513.7514	5.17	40.15	45.32	68.20	22.88	PASS	V	PK
9	3378.9879	7.53	39.16	46.69	68.20	21.51	PASS	V	PK
10	7603.4802	-10.55	55.61	45.06	68.20	23.14	PASS	V	PK
11	10395.8198	-6.27	53.43	47.16	68.20	21.04	PASS	V	PK
12	14318.6659	-0.24	51.67	51.43	68.20	16.77	PASS	V	PK

Mode:			802.11 a Transmitting			Channel:		5240 MHz	
NO	Freq. [MHz]	Factor [dB]	Reading [dB $\mu$ V]	Level [dB $\mu$ V/m]	Limit [dB $\mu$ V/m]	Margin [dB]	Result	Polarity	Remark
1	1651.8152	2.75	41.98	44.73	68.20	23.47	PASS	H	PK
2	2330.0330	4.15	41.42	45.57	68.20	22.63	PASS	H	PK
3	3527.5028	7.45	39.08	46.53	68.20	21.67	PASS	H	PK
4	7564.3782	-10.80	54.52	43.72	68.20	24.48	PASS	H	PK
5	10239.4120	-6.72	53.89	47.17	68.20	21.03	PASS	H	PK
6	14299.6900	-0.44	51.61	51.17	68.20	17.03	PASS	H	PK
7	1710.1210	3.06	41.69	44.75	68.20	23.45	PASS	V	PK
8	2440.0440	4.69	41.18	45.87	68.20	22.33	PASS	V	PK
9	3389.4389	7.55	39.03	46.58	68.20	21.62	PASS	V	PK
10	7639.7070	-10.79	54.72	43.93	68.20	24.27	PASS	V	PK
11	11208.9104	-5.80	53.24	47.44	68.20	20.76	PASS	V	PK
12	14373.8687	0.36	50.46	50.82	68.20	17.38	PASS	V	PK

Mode:			802.11 n(HT20) Transmitting			Channel:		5180 MHz	
NO	Freq. [MHz]	Factor [dB]	Reading [dB $\mu$ V]	Level [dB $\mu$ V/m]	Limit [dB $\mu$ V/m]	Margin [dB]	Result	Polarity	Remark
1	1661.1661	2.80	41.61	44.41	68.20	23.79	PASS	H	PK
2	2533.5534	5.17	40.89	46.06	68.20	22.14	PASS	H	PK
3	3486.2486	7.61	39.15	46.76	68.20	21.44	PASS	H	PK
4	7412.5706	-11.46	55.38	43.92	68.20	24.28	PASS	H	PK
5	9663.8082	-7.48	54.04	46.56	68.20	21.64	PASS	H	PK
6	14321.5411	-0.21	51.23	51.02	68.20	17.18	PASS	H	PK
7	1660.0660	2.79	41.97	44.76	68.20	23.44	PASS	V	PK
8	2426.2926	4.58	40.06	44.64	68.20	23.56	PASS	V	PK
9	3352.5853	7.48	39.52	47.00	68.20	21.20	PASS	V	PK
10	7621.8811	-10.67	54.25	43.58	68.20	24.62	PASS	V	PK
11	9630.4565	-7.40	53.40	46.00	68.20	22.20	PASS	V	PK
12	14401.4701	0.62	50.78	51.40	68.20	16.80	PASS	V	PK

Mode:			802.11 n(HT20) Transmitting			Channel:		5200 MHz	
NO	Freq. [MHz]	Factor [dB]	Reading [dB $\mu$ V]	Level [dB $\mu$ V/m]	Limit [dB $\mu$ V/m]	Margin [dB]	Result	Polarity	Remark
1	1774.4774	3.30	41.28	44.58	68.20	23.62	PASS	H	PK
2	2704.6205	5.57	40.11	45.68	68.20	22.52	PASS	H	PK
3	3953.7954	9.19	39.51	48.70	68.20	19.50	PASS	H	PK
4	7600.0300	-10.53	54.03	43.50	68.20	24.70	PASS	H	PK
5	10255.5128	-6.60	53.36	46.76	68.20	21.44	PASS	H	PK
6	14399.7450	0.64	51.24	51.88	68.20	16.32	PASS	H	PK
7	1693.0693	2.98	41.28	44.26	68.20	23.94	PASS	V	PK
8	2344.8845	4.19	40.67	44.86	68.20	23.34	PASS	V	PK
9	3442.2442	7.59	39.14	46.73	68.20	21.47	PASS	V	PK
10	8728.8114	-9.82	53.55	43.73	68.20	24.47	PASS	V	PK
11	12426.8213	-4.08	53.33	49.25	68.20	18.95	PASS	V	PK
12	15893.0947	0.02	51.50	51.52	68.20	16.68	PASS	V	PK

Mode:			802.11 n(HT20) Transmitting			Channel:		5240 MHz	
NO	Freq. [MHz]	Factor [dB]	Reading [dB $\mu$ V]	Level [dB $\mu$ V/m]	Limit [dB $\mu$ V/m]	Margin [dB]	Result	Polarity	Remark
1	1995.5996	4.60	44.44	49.04	68.20	19.16	PASS	H	PK
2	2664.4664	5.40	42.12	47.52	68.20	20.68	PASS	H	PK
3	3962.0462	9.24	38.35	47.59	68.20	20.61	PASS	H	PK
4	7517.8009	-11.15	54.90	43.75	68.20	24.45	PASS	H	PK
5	10812.1406	-6.21	53.10	46.89	68.20	21.31	PASS	H	PK
6	14391.6946	0.55	49.88	50.43	68.20	17.77	PASS	H	PK
7	1633.1133	2.64	41.04	43.68	68.20	24.52	PASS	V	PK
8	2673.8174	5.44	41.41	46.85	68.20	21.35	PASS	V	PK
9	3954.8955	9.20	38.91	48.11	68.20	20.09	PASS	V	PK
10	9083.6042	-8.62	53.15	44.53	68.20	23.67	PASS	V	PK
11	11981.7491	-4.94	52.83	47.89	68.20	20.31	PASS	V	PK
12	15904.0202	0.12	52.34	52.46	68.20	15.74	PASS	V	PK

Mode:			802.11 a Transmitting			Channel:		5745 MHz	
NO	Freq. [MHz]	Factor [dB]	Reading [dB $\mu$ V]	Level [dB $\mu$ V/m]	Limit [dB $\mu$ V/m]	Margin [dB]	Result	Polarity	Remark
1	1312.4312	1.66	42.13	43.79	68.20	24.41	PASS	H	PK
2	1992.2992	5.05	42.19	47.24	68.20	20.96	PASS	H	PK
3	3200.2200	7.82	40.38	48.20	68.20	20.00	PASS	H	PK
4	7561.9041	-10.82	54.42	43.60	68.20	24.60	PASS	H	PK
5	11783.4522	-6.13	54.73	48.60	68.20	19.60	PASS	H	PK
6	14312.0875	-0.31	51.28	50.97	68.20	17.23	PASS	H	PK
7	1466.4466	1.89	41.63	43.52	68.20	24.68	PASS	V	PK
8	2419.1419	4.97	40.48	45.45	68.20	22.75	PASS	V	PK
9	3762.9263	8.96	38.92	47.88	68.20	20.32	PASS	V	PK
10	7995.0997	-11.48	56.03	44.55	68.20	23.65	PASS	V	PK
11	10286.0524	-6.36	52.99	46.63	68.20	21.57	PASS	V	PK
12	13675.7117	-1.71	52.92	51.21	68.20	16.99	PASS	V	PK

Mode:			802.11 a Transmitting			Channel:		5785 MHz	
NO	Freq. [MHz]	Factor [dB]	Reading [dB $\mu$ V]	Level [dB $\mu$ V/m]	Limit [dB $\mu$ V/m]	Margin [dB]	Result	Polarity	Remark
1	1446.0946	1.87	40.87	42.74	68.20	25.46	PASS	H	PK
2	2539.6040	5.54	40.79	46.33	68.20	21.87	PASS	H	PK
3	3954.8955	10.07	38.64	48.71	68.20	19.49	PASS	H	PK
4	7529.7020	-11.06	55.21	44.15	68.20	24.05	PASS	H	PK
5	9788.4526	-7.22	54.00	46.78	68.20	21.42	PASS	H	PK
6	14394.1263	0.58	50.40	50.98	68.20	17.22	PASS	H	PK
7	1435.0935	1.86	41.40	43.26	68.20	24.94	PASS	V	PK
8	2333.8834	4.69	40.80	45.49	68.20	22.71	PASS	V	PK
9	3599.5600	7.67	39.85	47.52	68.20	20.68	PASS	V	PK
10	7655.4437	-10.90	54.85	43.95	68.20	24.25	PASS	V	PK
11	10416.3944	-6.31	53.22	46.91	68.20	21.29	PASS	V	PK
12	14410.9941	0.48	49.86	50.34	68.20	17.86	PASS	V	PK

Mode:			802.11 a Transmitting			Channel:		5825 MHz	
NO	Freq. [MHz]	Factor [dB]	Reading [dB $\mu$ V]	Level [dB $\mu$ V/m]	Limit [dB $\mu$ V/m]	Margin [dB]	Result	Polarity	Remark
1	1601.7602	2.72	41.89	44.61	68.20	23.59	PASS	H	PK
2	2326.1826	4.68	40.60	45.28	68.20	22.92	PASS	H	PK
3	3205.1705	7.85	39.84	47.69	68.20	20.51	PASS	H	PK
4	9078.4719	-8.60	53.39	44.79	68.20	23.41	PASS	H	PK
5	11860.1240	-5.74	54.28	48.54	68.20	19.66	PASS	H	PK
6	14313.6209	-0.29	51.71	51.42	68.20	16.78	PASS	H	PK
7	1542.3542	2.25	41.06	43.31	68.20	24.89	PASS	V	PK
8	2434.5435	5.06	40.80	45.86	68.20	22.34	PASS	V	PK
9	3290.9791	8.27	39.82	48.09	68.20	20.11	PASS	V	PK
10	7982.0655	-11.45	55.58	44.13	68.20	24.07	PASS	V	PK
11	11348.7232	-6.40	54.16	47.76	68.20	20.44	PASS	V	PK
12	14302.8869	-0.41	51.20	50.79	68.20	17.41	PASS	V	PK

Mode:			802.11 n(HT20) Transmitting			Channel:		5745 MHz	
NO	Freq. [MHz]	Factor [dB]	Reading [dB $\mu$ V]	Level [dB $\mu$ V/m]	Limit [dB $\mu$ V/m]	Margin [dB]	Result	Polarity	Remark
1	1995.0495	5.06	42.49	47.55	68.20	20.65	PASS	H	PK
2	2664.4664	5.97	42.91	48.88	68.20	19.32	PASS	H	PK
3	4268.4268	11.50	37.43	48.93	68.20	19.27	PASS	H	PK
4	9165.1110	-8.05	54.12	46.07	68.20	22.13	PASS	H	PK
5	11779.6186	-6.11	54.21	48.10	68.20	20.10	PASS	H	PK
6	13673.4116	-1.71	52.85	51.14	68.20	17.06	PASS	H	PK
7	1277.7778	1.52	42.82	44.34	68.20	23.86	PASS	V	PK
8	2038.5039	5.29	41.85	47.14	68.20	21.06	PASS	V	PK
9	3343.2343	8.25	39.87	48.12	68.20	20.08	PASS	V	PK
10	8514.9343	-10.58	55.93	45.35	68.20	22.85	PASS	V	PK
11	12476.5651	-4.21	53.41	49.20	68.20	19.00	PASS	V	PK
12	15891.5261	0.00	51.63	51.63	68.20	16.57	PASS	V	PK

Mode:			802.11 n(HT20) Transmitting			Channel:		5785 MHz	
NO	Freq. [MHz]	Factor [dB]	Reading [dBμV]	Level [dBμV/m]	Limit [dBμV/m]	Margin [dB]	Result	Polarity	Remark
1	2124.3124	5.32	44.57	49.89	68.20	18.31	PASS	H	PK
2	3053.3553	7.41	40.71	48.12	68.20	20.08	PASS	H	PK
3	4878.9879	13.35	37.06	50.41	68.20	17.79	PASS	H	PK
4	8364.6576	-10.79	54.26	43.47	68.20	24.73	PASS	H	PK
5	11236.7825	-6.03	53.78	47.75	68.20	20.45	PASS	H	PK
6	14407.1605	0.54	51.13	51.67	68.20	16.53	PASS	H	PK
7	1597.9098	2.68	44.37	47.05	68.20	21.15	PASS	V	PK
8	2131.4631	5.23	41.79	47.02	68.20	21.18	PASS	V	PK
9	3402.0902	8.15	39.65	47.80	68.20	20.40	PASS	V	PK
10	7640.8761	-10.80	55.34	44.54	68.20	23.66	PASS	V	PK
11	11265.9177	-6.28	53.49	47.21	68.20	20.99	PASS	V	PK
12	14328.1885	-0.14	50.75	50.61	68.20	17.59	PASS	V	PK

Mode:			802.11 n(HT20) Transmitting			Channel:		5825 MHz	
NO	Freq. [MHz]	Factor [dB]	Reading [dBμV]	Level [dBμV/m]	Limit [dBμV/m]	Margin [dB]	Result	Polarity	Remark
1	1281.6282	1.54	41.77	43.31	68.20	24.89	PASS	H	PK
2	1918.5919	4.79	41.14	45.93	68.20	22.27	PASS	H	PK
3	3739.8240	8.71	38.83	47.54	68.20	20.66	PASS	H	PK
4	8359.2906	-10.81	53.70	42.89	68.20	25.31	PASS	H	PK
5	11755.8504	-6.01	53.77	47.76	68.20	20.44	PASS	H	PK
6	14419.4280	0.36	51.63	51.99	68.20	16.21	PASS	H	PK
7	1772.2772	3.71	40.69	44.40	68.20	23.80	PASS	V	PK
8	2541.8042	5.55	40.61	46.16	68.20	22.04	PASS	V	PK
9	3986.7987	10.29	40.66	50.95	68.20	17.25	PASS	V	PK
10	8527.9685	-10.57	55.59	45.02	68.20	23.18	PASS	V	PK
11	11219.1479	-5.88	53.37	47.49	68.20	20.71	PASS	V	PK
12	14405.6270	0.56	49.60	50.16	68.20	18.04	PASS	V	PK

**Note:**

1) The field strength is calculated by adding the Antenna Factor, Cable Factor & Preamplifier. The basic equation with a sample calculation is as follows:

Final Test Level = Receiver Reading - Correct Factor

Correct Factor = Preamplifier Factor - Antenna Factor - Cable Factor

2) Scan from 9kHz to 40GHz, the disturbance above 18GHz and below 30MHz was very low, and the above harmonics were the highest point could be found when testing, so only the above harmonics had been displayed. The amplitude of spurious emissions from the radiator which are attenuated more than 20dB below the limit need not be reported.

## 7.9 Radiated Emission which fall in the restricted bands

Test Requirement:	47 CFR Part 15C Section 15.209 and 15.407 (b)				
Test Method:	ANSI C63.10 2013				
Test Site:	Measurement Distance: 3m (Semi-Anechoic Chamber)				
Receiver Setup:	Frequency	Detector	RBW	VBW	Remark
	0.009MHz-0.090MHz	Peak	10kHz	30kHz	Peak
	0.009MHz-0.090MHz	Average	10kHz	30kHz	Average
	0.090MHz-0.110MHz	Quasi-peak	10kHz	30kHz	Quasi-peak
	0.110MHz-0.490MHz	Peak	10kHz	30kHz	Peak
	0.110MHz-0.490MHz	Average	10kHz	30kHz	Average
	0.490MHz -30MHz	Quasi-peak	10kHz	30kHz	Quasi-peak
	30MHz-1GHz	Quasi-peak	100 kHz	300kHz	Quasi-peak
	Above 1GHz	Peak	1MHz	3MHz	Peak
Peak		1MHz	10kHz	Average	
Limit:	Frequency	Field strength (microvolt/meter)	Limit (dBuV/m)	Remark	Measurement distance (m)
	0.009MHz-0.490MHz	2400/F(kHz)	-	-	300
	0.490MHz-1.705MHz	24000/F(kHz)	-	-	30
	1.705MHz-30MHz	30	-	-	30
	30MHz-88MHz	100	40.0	Quasi-peak	3
	88MHz-216MHz	150	43.5	Quasi-peak	3
	216MHz-960MHz	200	46.0	Quasi-peak	3
	960MHz-1GHz	500	54.0	Quasi-peak	3
	Above 1GHz	500	54.0	Average	3
<p>*(1) For transmitters operating in the 5.15-5.25 GHz band: All emissions outside of the 5.15-5.35 GHz band shall not exceed an e.i.r.p. of -27 dBm/MHz.</p> <p>(2) For transmitters operating in the 5.25-5.35 GHz band: All emissions outside of the 5.15-5.35 GHz band shall not exceed an e.i.r.p. of -27 dBm/MHz.</p> <p>(3) For transmitters operating in the 5.47-5.725 GHz band: All emissions outside of the 5.47-5.725 GHz band shall not exceed an e.i.r.p. of -27 dBm/MHz.</p> <p>(4) For transmitters operating in the 5.725-5.85 GHz band:</p> <p>(i) All emissions shall be limited to a level of -27 dBm/MHz at 75 MHz or more above or below the band edge increasing linearly to 10 dBm/MHz at 25 MHz above or below the band edge, and from 25 MHz above or below the band edge increasing linearly to a level of 15.6 dBm/MHz at 5 MHz above or below the band edge, and from 5 MHz above or below the band edge increasing linearly to a level of 27 dBm/MHz at the band edge.</p> <p>Remark: The emission limits shown in the above table are based on measurements employing a CISPR quasi-peak detector except for the frequency bands 9-90kHz, 110-490kHz and above 1000 MHz. Radiated emission limits in these three bands are based on measurements employing an average detector, the peak field strength of any emission shall not exceed</p>					

the maximum permitted average limits specified above by more than 20 dB under any condition of modulation.

Note:

(j)  $EIRP = ((E*d)^2) / 30$   
 where:

- E is the field strength in V/m;
- d is the measurement distance in meters;
- EIRP is the equivalent isotropically radiated power in watts.

(ii) Working in dB units, the above equation is equivalent to:  
 $EIRP[dBm] = E[dB\mu V/m] + 20 \log(d[meters]) - 104.77$

(iii) Or, if d is 3 meters:  
 $EIRP[dBm] = E[dB\mu V/m] - 95.2$

**Test Setup:**

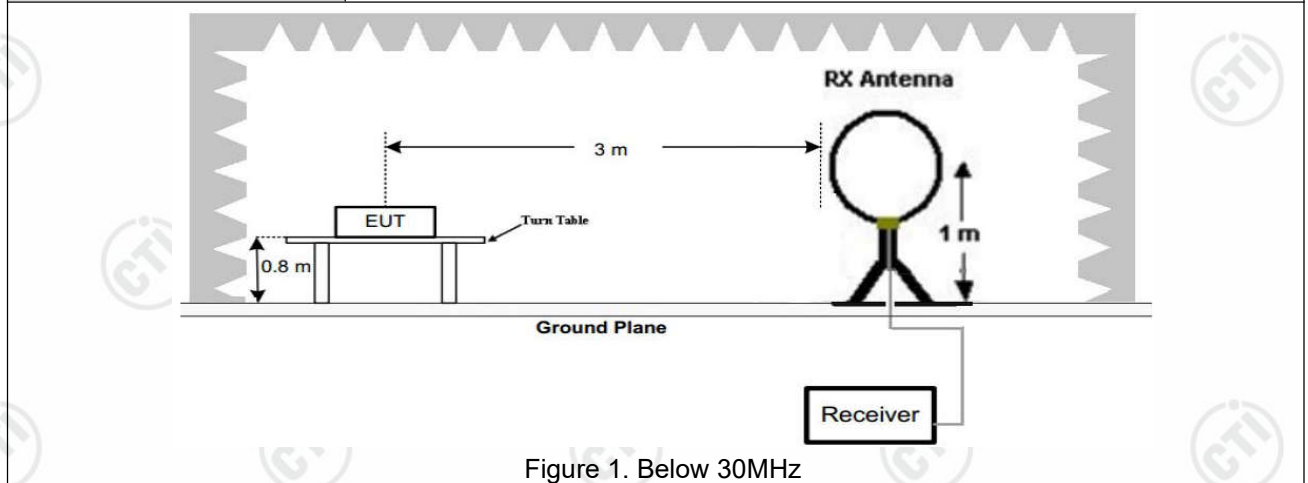

Figure 1. Below 30MHz

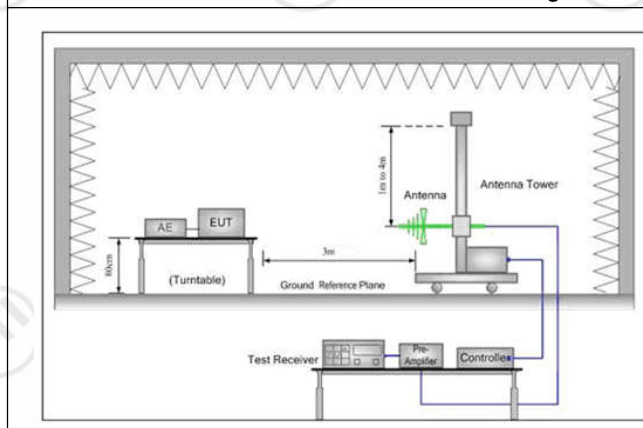

Figure 2. 30MHz to 1GHz

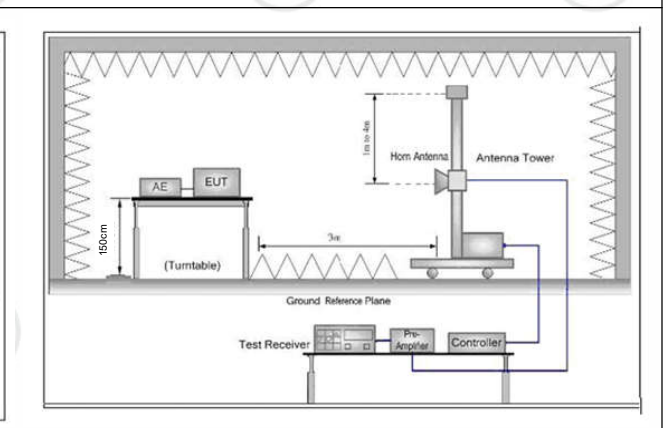

Figure 3. Above 1 GHz

**Test Procedure:**

- j.
- 1) Below 1G: The EUT was placed on the top of a rotating table 0.8 meters above the ground at a 3 meter semi-anechoic chamber. The table was rotated 360 degrees to determine the position of the highest radiation.
  - 2) Above 1G: The EUT was placed on the top of a rotating table 1.5 meters above the ground at a 3 meter semi-anechoic chamber. The table was rotated 360 degrees to determine the position of the highest radiation.
- Note: For the radiated emission test above 1GHz:



	<p>Place the measurement antenna away from each area of the EUT determined to be a source of emissions at the specified measurement distance, while keeping the measurement antenna aimed at the source of emissions at each frequency of significant emissions, with polarization oriented for maximum response. The measurement antenna may have to be higher or lower than the EUT, depending on the radiation pattern of the emission and staying aimed at the emission source for receiving the maximum signal. The final measurement antenna elevation shall be that which maximizes the emissions. The measurement antenna elevation for maximum emissions shall be restricted to a range of heights of from 1 m to 4 m above the ground or reference ground plane.</p> <ul style="list-style-type: none"> <li>k. The EUT was set 3 meters away from the interference-receiving antenna, which was mounted on the top of a variable-height antenna tower.</li> <li>l. The antenna height is varied from one meter to four meters above the ground to determine the maximum value of the field strength. Both horizontal and vertical polarizations of the antenna are set to make the measurement.</li> <li>m. For each suspected emission, the EUT was arranged to its worst case and then the antenna was tuned to heights from 1 meter to 4 meters (for the test frequency of below 30MHz, the antenna was tuned to heights 1 meter) and the rotatable table was turned from 0 degrees to 360 degrees to find the maximum reading.</li> <li>n. The test-receiver system was set to Peak Detect Function and Specified Bandwidth with Maximum Hold Mode.</li> <li>o. If the emission level of the EUT in peak mode was 10dB lower than the limit specified, then testing could be stopped and the peak values of the EUT would be reported. Otherwise the emissions that did not have 10dB margin would be re-tested one by one using peak, quasi-peak or average method as specified and then reported in a data sheet.</li> <li>p. Test the EUT in the lowest channel, the Highest channel</li> <li>q. The radiation measurements are performed in X, Y, Z axis positioning for Transmitting mode, and found the X axis positioning which it is the worst case.</li> <li>r. Repeat above procedures until all frequencies measured was complete.</li> </ul>
Test Mode:	Transmitting mode with modulation
Test Results:	Pass

Remark: During the test, the Radiates Emission from 1GHz to 40GHz was performed in all modes, only the worst case was in the report.

**Test Data:**

Mode:	802.11 a Transmitting	Channel:	5180MHz
Remark:			

**Test Graph**

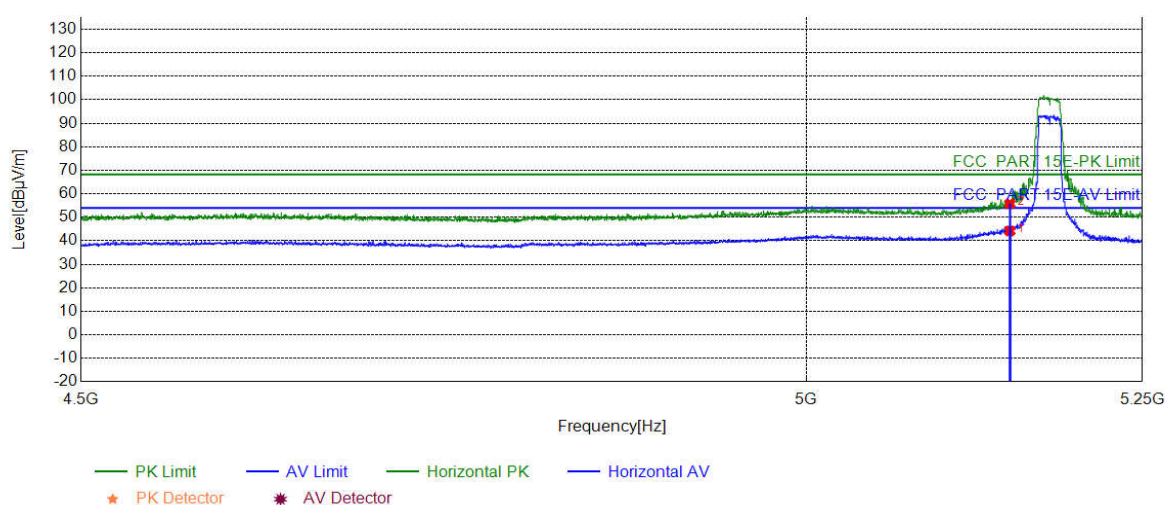

Suspected List									
NO	Freq. [MHz]	Factor [dB]	Reading [dBµV]	Level [dBµV/m]	Limit [dBµV/m]	Margin [dB]	Result	Polarity	Remark
1	5150.0000	12.36	31.84	44.20	54.00	9.80	PASS	Horizontal	AV
2	5150.0000	12.36	43.43	55.79	68.20	12.41	PASS	Horizontal	PK

Mode:	802.11 a Transmitting	Channel:	5180MHz
Remark:			

### Test Graph

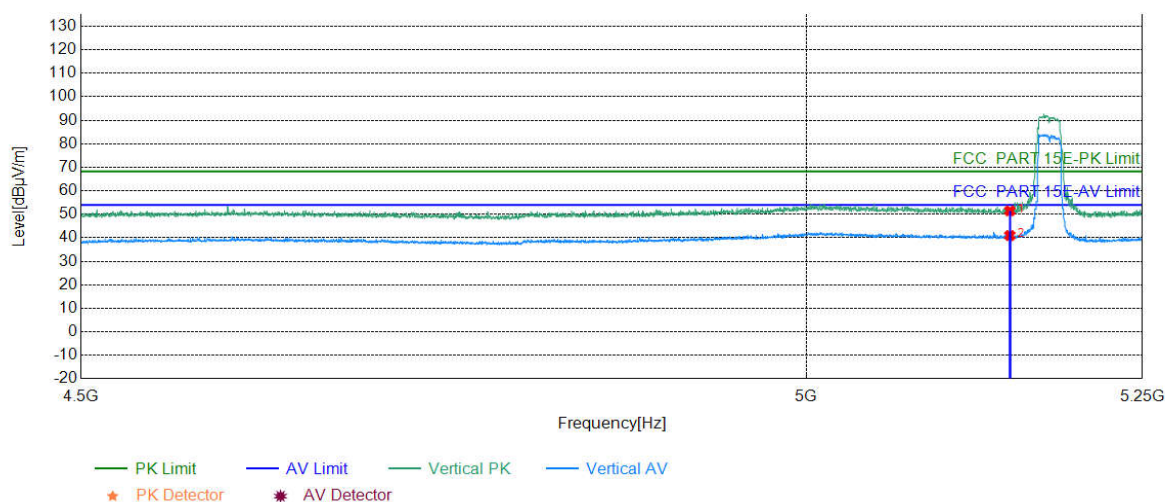

### Suspected List

NO	Freq. [MHz]	Factor [dB]	Reading [dBμV]	Level [dBμV/m]	Limit [dBμV/m]	Margin [dB]	Result	Polarity	Remark
1	5150.0000	12.36	39.09	51.45	68.20	16.75	PASS	Vertical	PK
2	5150.0000	12.36	28.61	40.97	54.00	13.03	PASS	Vertical	AV

Mode:	802.11 n(HT20) Transmitting	Channel:	5180MHz
Remark:			

### Test Graph

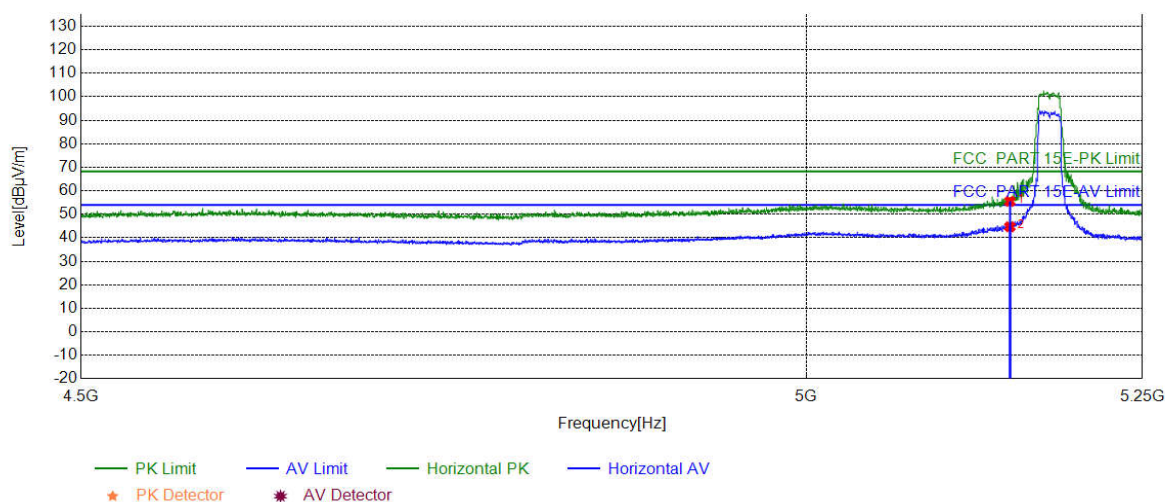

Suspected List									
NO	Freq. [MHz]	Factor [dB]	Reading [dBμV]	Level [dBμV/m]	Limit [dBμV/m]	Margin [dB]	Result	Polarity	Remark
1	5150.0000	12.36	43.15	55.51	68.20	12.69	PASS	Horizontal	PK
2	5150.0000	12.36	32.33	44.69	54.00	9.31	PASS	Horizontal	AV

Mode:	802.11 n(HT20) Transmitting	Channel:	5180MHz
Remark:			

### Test Graph

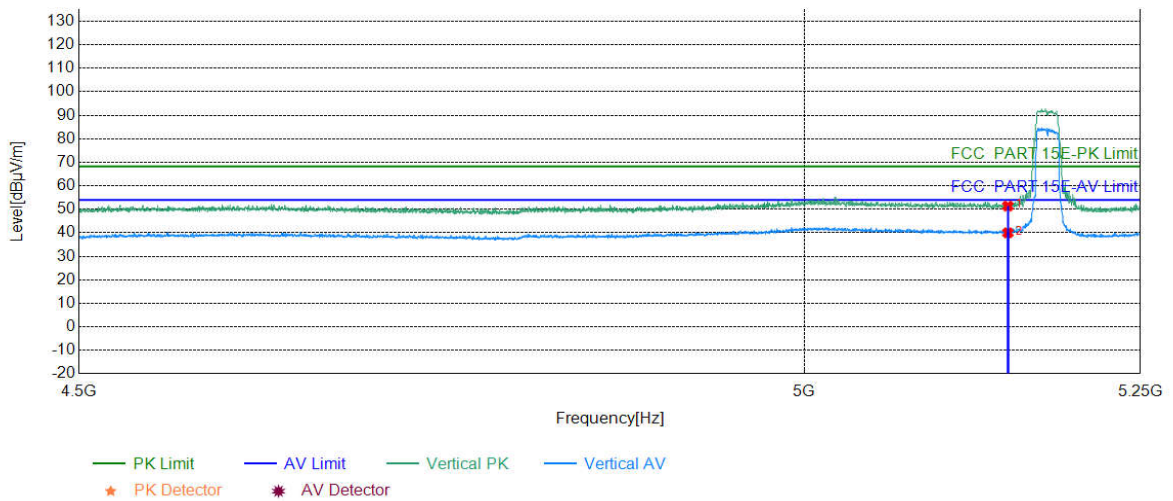

### Suspected List

NO	Freq. [MHz]	Factor [dB]	Reading [dBμV]	Level [dBμV/m]	Limit [dBμV/m]	Margin [dB]	Result	Polarity	Remark
1	5150.0000	12.36	39.01	51.37	68.20	16.83	PASS	Vertical	PK
2	5150.0000	12.36	27.63	39.99	54.00	14.01	PASS	Vertical	AV

Mode:	802.11 a Transmitting	Channel:	5745MHz
Remark:			

### Test Graph

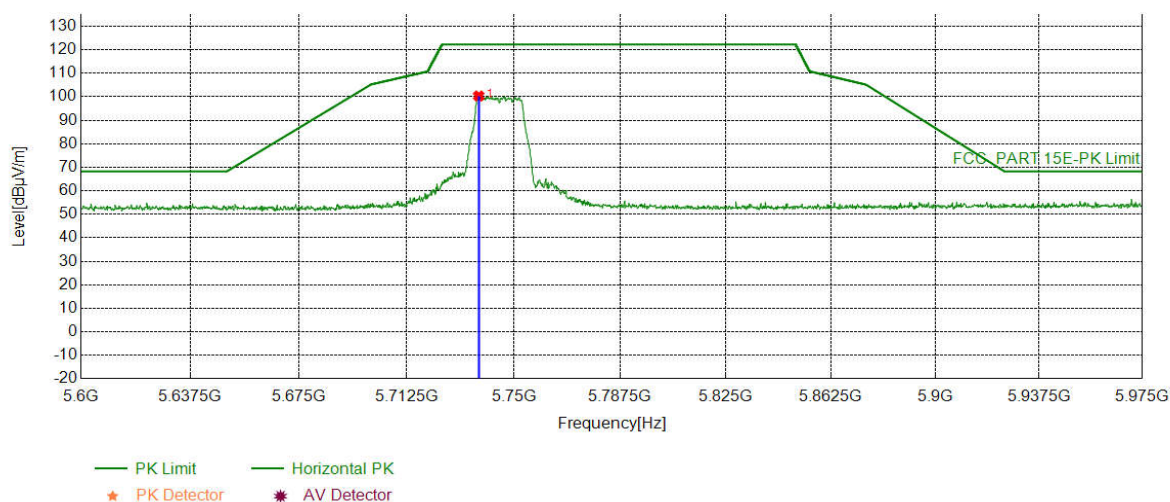

Suspected List									
NO	Freq. [MHz]	Factor [dB]	Reading [dBµV]	Level [dBµV/m]	Limit [dBµV/m]	Margin [dB]	Result	Polarity	Remark
1	5737.6938	13.83	86.52	100.35	122.20	21.85	PASS	Horizontal	PK

Mode:	802.11 a Transmitting	Channel:	5745MHz
Remark:			

### Test Graph

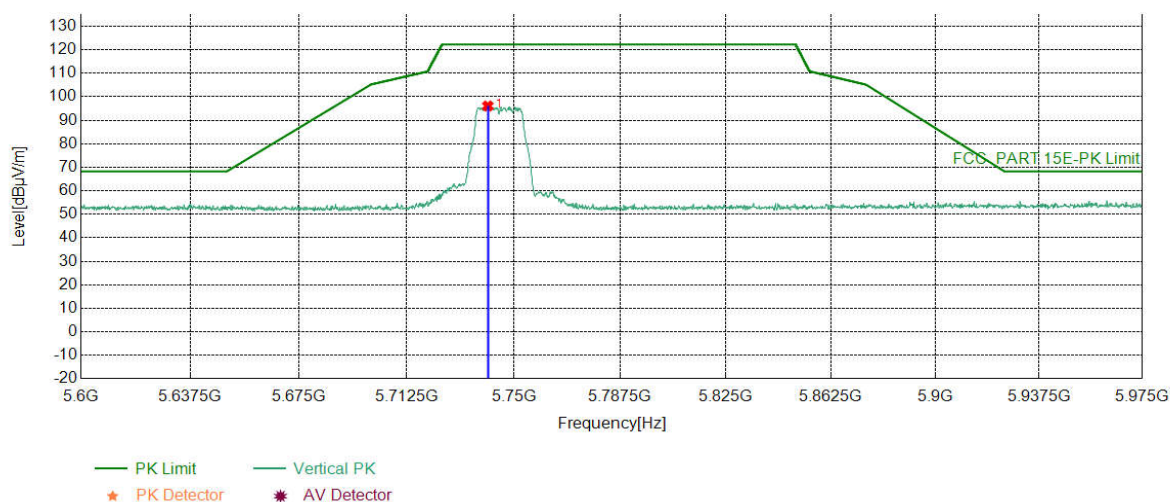

### Suspected List

NO	Freq. [MHz]	Factor [dB]	Reading [dBµV]	Level [dBµV/m]	Limit [dBµV/m]	Margin [dB]	Result	Polarity	Remark
1	5740.8829	13.84	82.24	96.08	122.20	26.12	PASS	Vertical	PK

Mode:	802.11 n(HT20) Transmitting	Channel:	5745MHz
Remark:			

### Test Graph

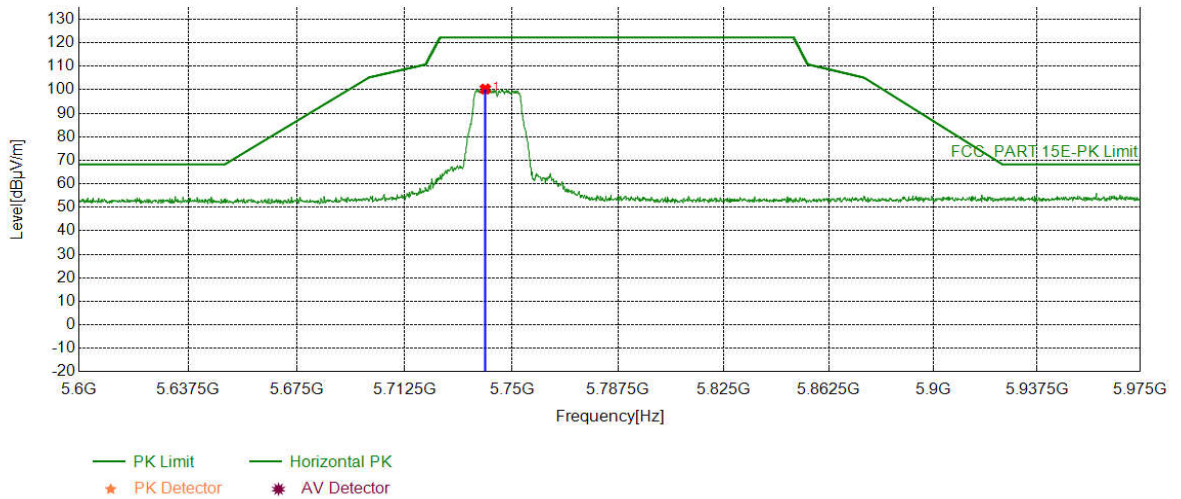

Suspected List									
NO	Freq. [MHz]	Factor [dB]	Reading [dBμV]	Level [dBμV/m]	Limit [dBμV/m]	Margin [dB]	Result	Polarity	Remark
1	5740.6953	13.84	86.47	100.31	122.20	21.89	PASS	Horizontal	PK



Mode:	802.11 n(HT20) Transmitting	Channel:	5745MHz
Remark:			

### Test Graph

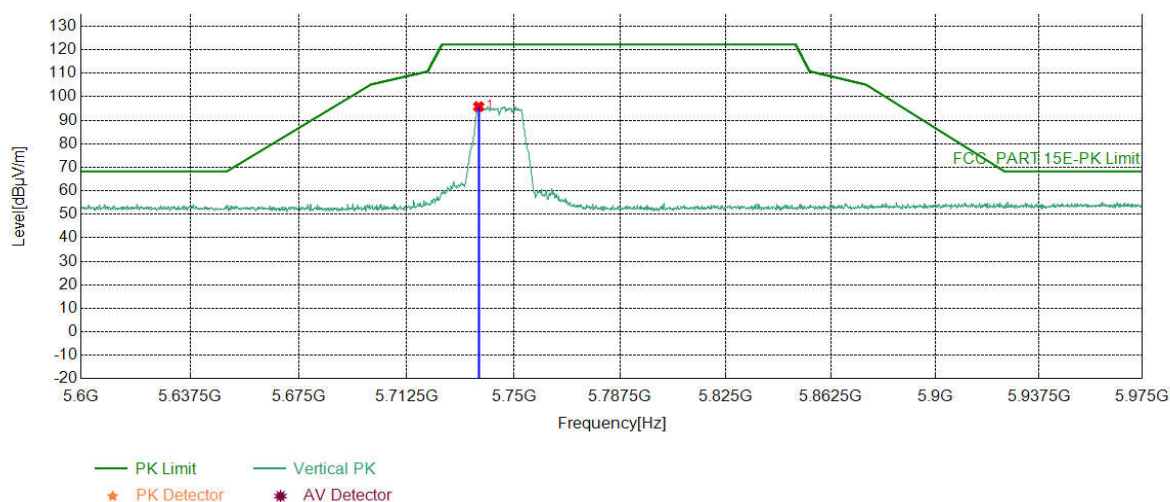

### Suspected List

NO	Freq. [MHz]	Factor [dB]	Reading [dBμV]	Level [dBμV/m]	Limit [dBμV/m]	Margin [dB]	Result	Polarity	Remark
1	5737.6938	13.83	81.97	95.80	122.20	26.40	PASS	Vertical	PK

Mode:	802.11 a Transmitting	Channel:	5785MHz
Remark:			

## Test Graph

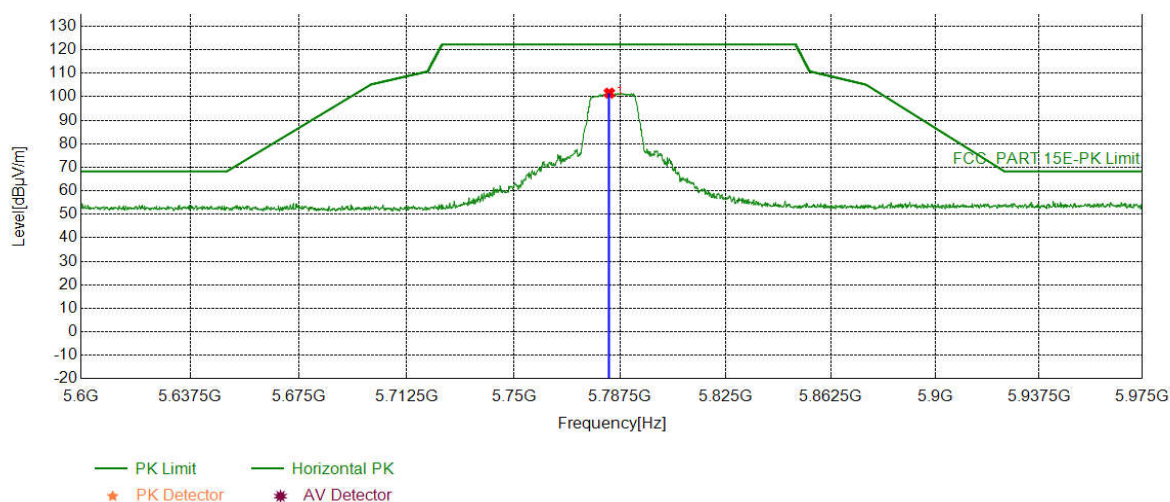

## Suspected List

NO	Freq. [MHz]	Factor [dB]	Reading [dBμV]	Level [dBμV/m]	Limit [dBμV/m]	Margin [dB]	Result	Polarity	Remark
1	5783.6543	13.91	87.67	101.58	122.20	20.62	PASS	Horizontal	PK

Mode:	802.11 a Transmitting	Channel:	5785MHz
Remark:			

### Test Graph

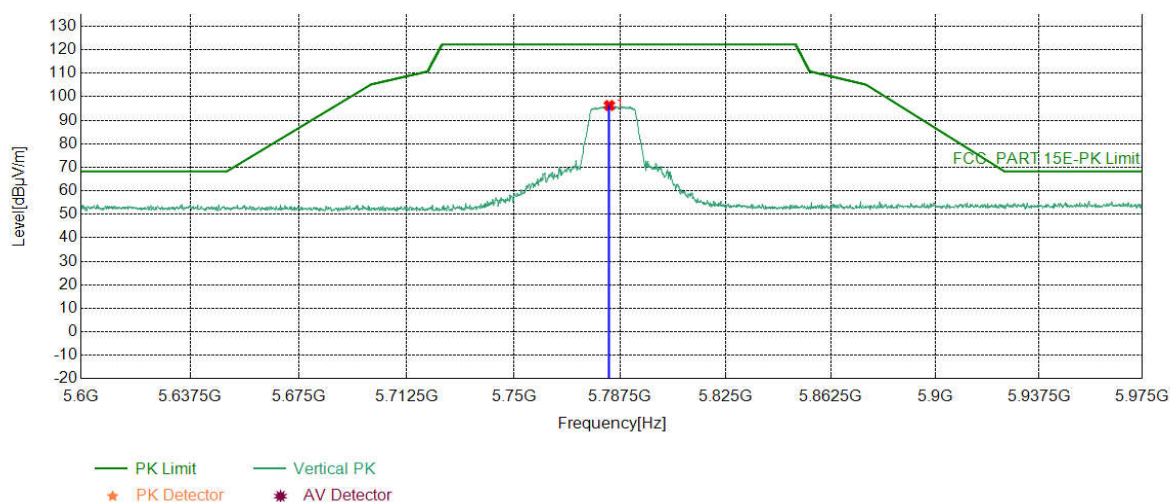

### Suspected List

NO	Freq. [MHz]	Factor [dB]	Reading [dBμV]	Level [dBμV/m]	Limit [dBμV/m]	Margin [dB]	Result	Polarity	Remark
1	5783.6543	13.91	82.37	96.28	122.20	25.92	PASS	Vertical	PK

Mode:	802.11 n(HT20) Transmitting	Channel:	5785MHz
Remark:			

## Test Graph

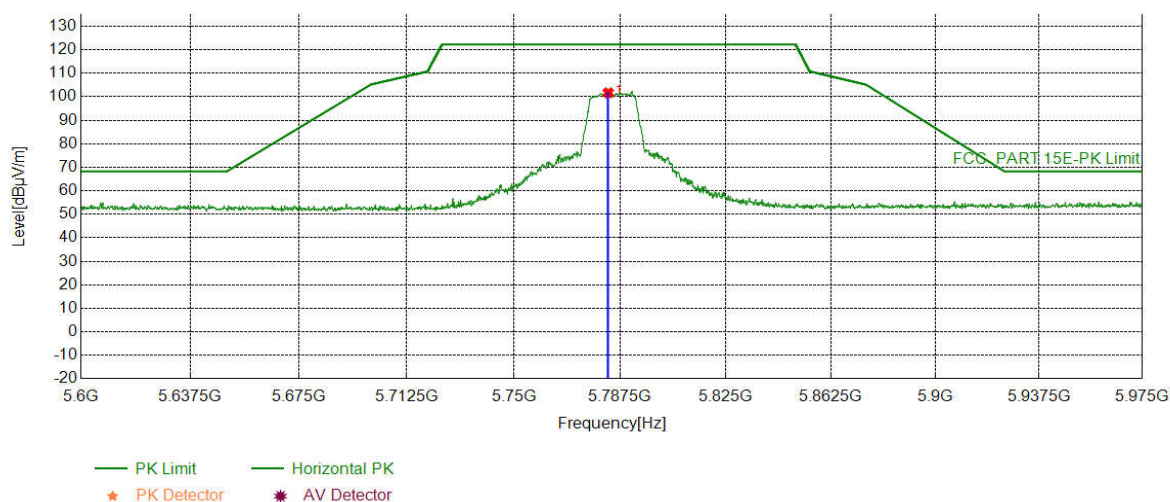

## Suspected List

NO	Freq. [MHz]	Factor [dB]	Reading [dBμV]	Level [dBμV/m]	Limit [dBμV/m]	Margin [dB]	Result	Polarity	Remark
1	5783.2791	13.91	87.77	101.68	122.20	20.52	PASS	Horizontal	PK

Mode:	802.11 n(HT20) Transmitting	Channel:	5785MHz
Remark:			

### Test Graph

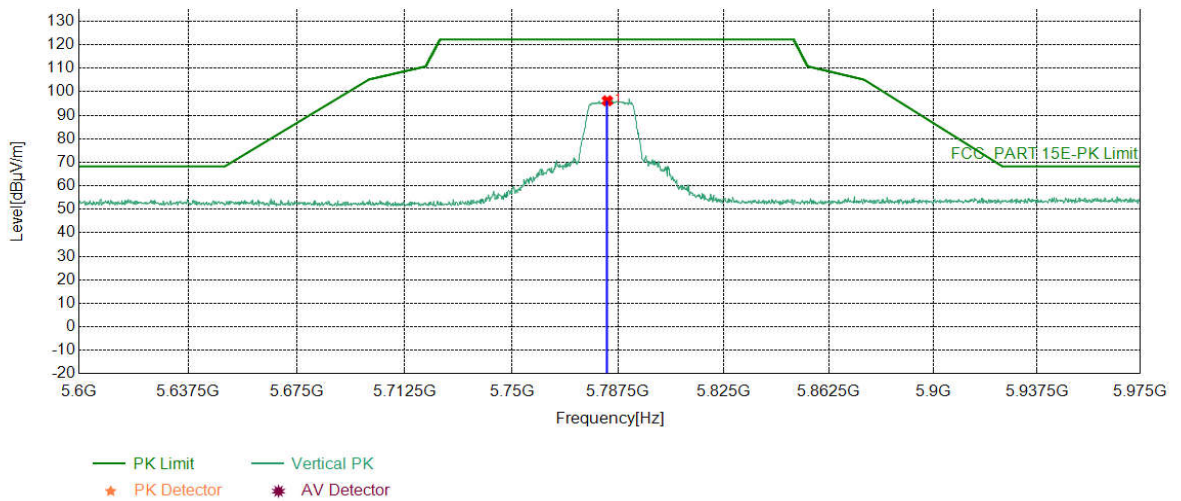

### Suspected List

NO	Freq. [MHz]	Factor [dB]	Reading [dBμV]	Level [dBμV/m]	Limit [dBμV/m]	Margin [dB]	Result	Polarity	Remark
1	5783.6543	13.91	82.26	96.17	122.20	26.03	PASS	Vertical	PK

Mode:	802.11 a Transmitting	Channel:	5825MHz
Remark:			

### Test Graph

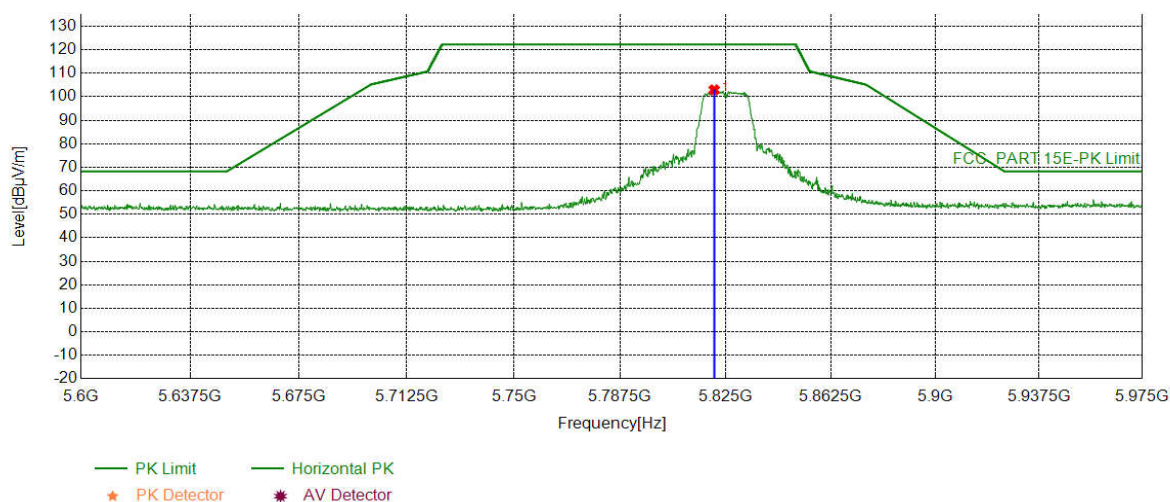

### Suspected List

NO	Freq. [MHz]	Factor [dB]	Reading [dBµV]	Level [dBµV/m]	Limit [dBµV/m]	Margin [dB]	Result	Polarity	Remark
1	5820.7979	14.02	88.92	102.94	122.20	19.26	PASS	Horizontal	PK

Mode:	802.11 a Transmitting	Channel:	5825MHz
Remark:			

### Test Graph

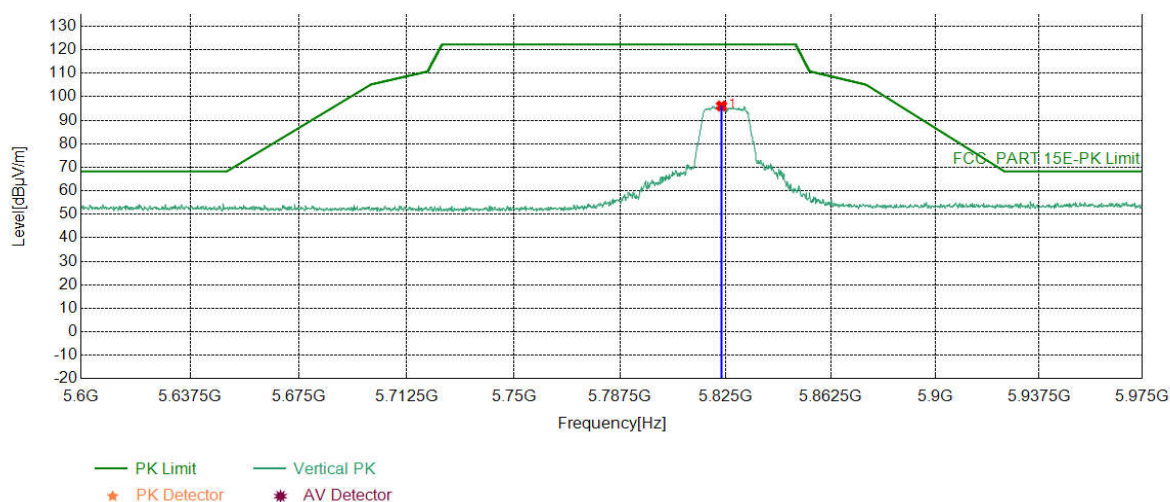

### Suspected List

NO	Freq. [MHz]	Factor [dB]	Reading [dBµV]	Level [dBµV/m]	Limit [dBµV/m]	Margin [dB]	Result	Polarity	Remark
1	5823.4242	14.03	82.03	96.06	122.20	26.14	PASS	Vertical	PK

Mode:	802.11 n(HT20) Transmitting	Channel:	5825MHz
Remark:			

### Test Graph

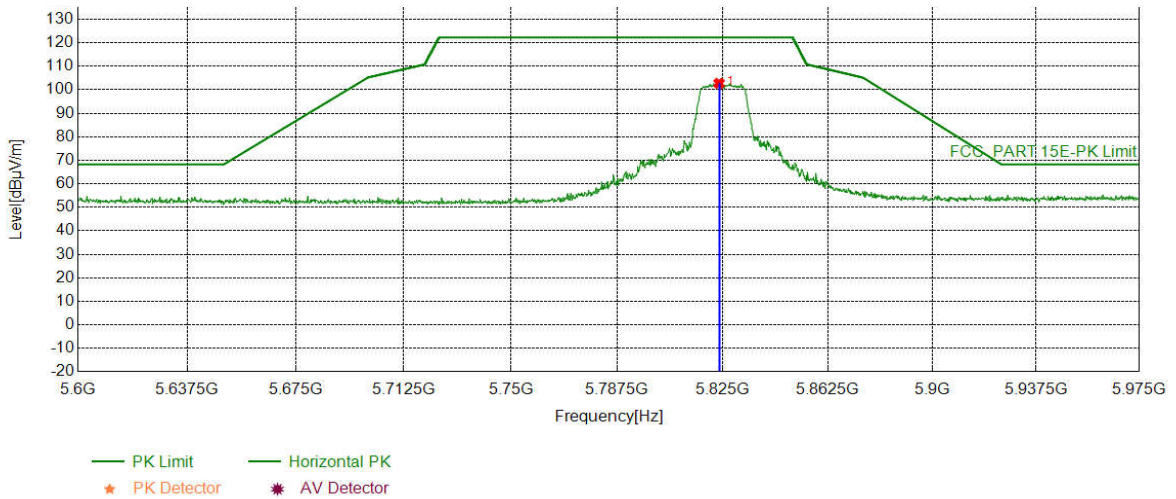

Suspected List									
NO	Freq. [MHz]	Factor [dB]	Reading [dBμV]	Level [dBμV/m]	Limit [dBμV/m]	Margin [dB]	Result	Polarity	Remark
1	5823.6118	14.03	88.73	102.76	122.20	19.44	PASS	Horizontal	PK



Mode:	802.11 n(HT20) Transmitting	Channel:	5825MHz
Remark:			

### Test Graph

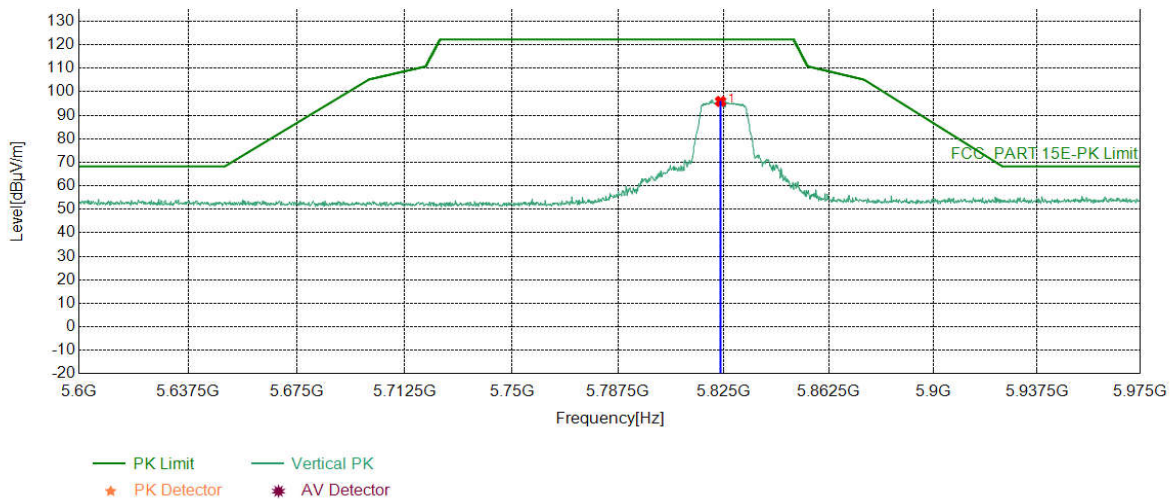

Suspected List									
NO	Freq. [MHz]	Factor [dB]	Reading [dBµV]	Level [dBµV/m]	Limit [dBµV/m]	Margin [dB]	Result	Polarity	Remark
1	5823.7994	14.03	81.86	95.89	122.20	26.31	PASS	Vertical	PK

**Note:**

1) The field strength is calculated by adding the Antenna Factor, Cable Factor & Preamplifier. The basic equation with a sample calculation is as follows:

Final Test Level = Receiver Reading - Correct Factor

Correct Factor = Preamplifier Factor - Antenna Factor - Cable Factor

2) Scan from 1GHz to 25GHz, the disturbance above 13GHz was very low, and the above harmonics were the highest point could be found when testing, so only the above harmonics had been displayed. The amplitude of spurious emissions from the radiator which are attenuated more than 20dB below the limit need not be reported.

## 8 Appendix A

Refer to Appendix: 5G WIFI of EED32N80457602.