



Shenzhen Huaxia Testing Technology Co., Ltd

1F., Block A of Tongsheng Technology Building, Huahui Road, Dalang Street, Longhua District, Shenzhen, China

Telephone: +86-755-26648640

Fax: +86-755-26648637

Website: www.cqa-cert.com

Report Template Version: V03

Report Template Revision Date: Mar.1st, 2017

FCC/IC Test Report

Report No. : CQSZ20180500205EW-01

Applicant: Hangzhou Great Star Industrial Co., Ltd.

Address of Applicant: No.35, Jiujuan Road, Jiubao Town, Jianggan District, Hangzhou 310019, China

Manufacturer: Hangzhou Great Star Industrial Co., Ltd.

Address of Manufacturer: No.35, Jiujuan Road, Jiubao Town, Jianggan District, Hangzhou 310019, China

Equipment Under Test (EUT):

Product: Smart Plug

Model No.: iL03_1

Brand Name: 

FCC ID: 2AMI2IL03

IC: 22853-IL03

Standards: 47 CFR Part 15, Subpart C
RSS-247 Issue 2 February 2017
RSS-Gen Issue 5 Nov 2018

Date of Test: 2018-06-01 to 2018-06-21

Date of Issue: 2018-06-21

Test Result : **PASS***

Tested By:

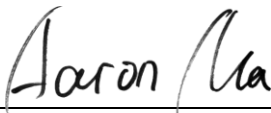

(Aaron Ma)

Reviewed By:



(Owen Zhou)

Approved By:



(Jack Ai)



* In the configuration tested, the EUT complied with the standards specified above.

The test report is effective only with both signature and specialized stamp, The result(s) shown in this report refer only to the sample(s) tested. Without written approval of CQA, this report can't be reproduced except in full.

2 Version

Revision History Of Report

Report No.	Version	Description	Issue Date
CQSZ20180500205EW-01	Rev.01	Initial report	2018-06-21

3 Test Summary

Test Item	Test Requirement	Test method	Result
Antenna Requirement	47 CFR Part 15, Subpart C Section 15.203/15.247 (c), RSS-Gen Issue 5	ANSI C63.10 2013	PASS
AC Power Line Conducted Emission	47 CFR Part 15, Subpart C Section 15.207, RSS-Gen Issue 5	ANSI C63.10 2013	PASS
Conducted Peak & Average Output Power	47 CFR Part 15, Subpart C Section 15.247 (b)(3), RSS 247 5.4(4)	KDB558074 D01 v04	PASS
6dB Occupied Bandwidth	47 CFR Part 15, Subpart C Section 15.247 (a)(2), RSS 247 5.2(1)	KDB558074 D01 v04	PASS
99% Occupied Bandwidth	RSS-Gen Issue 5	RSS-Gen Issue 5	PASS
Power Spectral Density	47 CFR Part 15, Subpart C Section 15.247 (e), RSS 247 5.2(2)	KDB558074 D01 v04	PASS
Band-edge for RF Conducted Emissions	47 CFR Part 15, Subpart C Section 15.247(d), RSS 247 5.5	KDB558074 D01 v04	PASS
RF Conducted Spurious Emissions	47 CFR Part 15, Subpart C Section 15.247(d), RSS 247 5.5	KDB558074 D01 v04	PASS
Radiated Spurious Emissions	47 CFR Part 15, Subpart C Section 15.205/15.209, RSS-Gen Issue 5	ANSI C63.10 2013	PASS
Restricted bands around fundamental frequency (Radiated Emission)	47 CFR Part 15, Subpart C Section 15.205/15.209, RSS-Gen Issue 5	ANSI C63.10 2013	PASS

4 Contents

		Page
1	COVER PAGE.....	1
2	VERSION	2
3	TEST SUMMARY	3
4	CONTENTS	4
5	GENERAL INFORMATION.....	5
5.1	CLIENT INFORMATION	5
5.2	GENERAL DESCRIPTION OF EUT	5
5.3	TEST ENVIRONMENT AND MODE	7
5.4	DESCRIPTION OF SUPPORT UNITS	7
5.5	TEST LOCATION	7
5.6	TEST FACILITY	7
5.7	STATEMENT OF THE MEASUREMENT UNCERTAINTY	8
5.8	DEVIATION FROM STANDARDS	8
5.9	ABNORMALITIES FROM STANDARD CONDITIONS	8
5.10	OTHER INFORMATION REQUESTED BY THE CUSTOMER	8
5.11	EQUIPMENT LIST	9
6	TEST RESULTS AND MEASUREMENT DATA.....	10
6.1	ANTENNA REQUIREMENT	10
6.2	CONDUCTED EMISSIONS	11
6.3	CONDUCTED PEAK & AVERAGE OUTPUT POWER	15
6.4	6dB OCCUPY BANDWIDTH	16
6.5	99% OCCUPY BANDWIDTH.....	19
6.6	POWER SPECTRAL DENSITY	22
6.7	BAND-EDGE FOR RF CONDUCTED EMISSIONS	25
6.8	RF CONDUCTED SPURIOUS EMISSIONS	27
6.9	RADIATED SPURIOUS EMISSIONS.....	33
6.9.1	<i>Radiated emission below 1GHz.....</i>	<i>36</i>
6.9.2	<i>Transmitter emission above 1GHz.....</i>	<i>38</i>
6.10	RESTRICTED BANDS AROUND FUNDAMENTAL FREQUENCY	44

5 General Information

5.1 Client Information

Applicant:	Hangzhou Great Star Industrial Co., Ltd.
Address of Applicant:	No.35, Jiujuan Road, Jiubao Town, Jianggan District, Hangzhou 310019, China
Manufacturer:	Hangzhou Great Star Industrial Co., Ltd.
Address of Manufacturer:	No.35, Jiujuan Road, Jiubao Town, Jianggan District, Hangzhou 310019, China

5.2 General Description of EUT

Product Name:	Smart Plug
Model No.:	iL03_1
Trade Mark:	
Hardware version:	100
Software version:	268460592(hex:0x10006230)
Operation Frequency:	2405~2480MHz
Channel Numbers:	16
Channel Separation:	5MHz
Type of Modulation:	O-QPSK
Sample Type:	Mobile production
Test Software of EUT:	Secure CRT (manufacturer declare)
Antenna Type:	PCB antenna
Antenna Gain:	0.3dBi
Power Supply:	Input:100-240V~50/60Hz

Operation Frequency each of channel							
Channel	Frequency	Channel	Frequency	Channel	Frequency	Channel	Frequency
11	2405MHz	15	2425MHz	19	2445MHz	23	2465MHz
12	2410MHz	16	2430MHz	20	2450MHz	24	2470MHz
13	2415MHz	17	2435MHz	21	2455MHz	25	2475MHz
14	2420MHz	18	2440MHz	22	2460MHz	26	2480MHz

Note:

In section 15.31(m), regards to the operating frequency range over 10 MHz, the Lowest frequency, the middle frequency, and the highest frequency of channel were selected to perform the test, and the selected channel see below:

Channel	Frequency
The Lowest channel	2405MHz
The Middle channel	2440MHz
The Highest channel	2480MHz

Note:

Software (Secure CRT) provided by client enabled the EUT to transmit and receive data at lowest, middle and highest channel individually.

5.3 Test Environment and Mode

Operating Environment:	
Temperature:	24.0 °C
Humidity:	52 % RH
Atmospheric Pressure:	1008 mbar
Test mode:	
Transmitting mode:	Continuous traffic was generated using test commands. The device was programmed to transmit at 100% duty cycle at low, middle, and high channels

5.4 Description of Support Units

The EUT has been tested with associated equipment below.

Description	Manufacturer	Model No.	Remark	FCC certification
PC	Lenovo	ThinkPad E450c	Provide by lab	ID
AC/DC Adapter	Lenovo	PA-1450-55LN	Provide by lab	DOC

5.5 Test Location

All tests were performed at:

Shenzhen Huaxia Testing Technology Co., Ltd.,

1F., Block A of Tongsheng Technology Building, Huahui Road, Dalang Street, Longhua New District, Shenzhen, Guangdong, China

5.6 Test Facility

The test facility is recognized, certified, or accredited by the following organizations:

• **CNAS (No. CNAS L5785)**

CNAS has accredited Shenzhen Huaxia Testing Technology Co., Ltd. Shenzhen Branch EMC Lab to ISO/IEC 17025:2005 General Requirements for the Competence of Testing and Calibration Laboratories (CNAS-CL01 Accreditation Criteria for the Competence of Testing and Calibration Laboratories) for the competence in the field of testing.

• **ISED Registration No.: 22984-1**

The 3m Semi-anechoic chamber of Shenzhen Huaxia Testing Technology Co., Ltd. has been registered by Certification and Engineering Bureau of Industry Canada for radio equipment testing

• **A2LA (Certificate No. 4742.01)**

Shenzhen Huaxia Testing Technology Co., Ltd., Shenzhen EMC Laboratory is accredited by the American Association for Laboratory Accreditation(A2LA). Certificate No. 4742.01.

• **FCC Registration No.: 522263**

Shenzhen Huaxia Testing Technology Co., Ltd., Shenzhen EMC Laboratory has been registered and fully described in a report filed with the (FCC) Federal Communications Commission. The acceptance letter from the FCC is maintained in our files. Registration No.:522263

5.7 Statement of the measurement uncertainty

The data and results referenced in this document are true and accurate.

The reader is cautioned that there may be errors within the calibration limits of the equipment and facilities.

The measurement uncertainty was calculated for all measurements listed in this test report acc. to CISPR 16 - 4 „Specification for radio disturbance and immunity measuring apparatus and methods – Part 4: Uncertainty in EMC Measurements“ and is documented in the **Shenzhen Huaxia Testing Technology Co., Ltd.** quality system acc. to DIN EN ISO/IEC 17025.

Furthermore, component and process variability of devices similar to that tested may result in additional deviation. The manufacturer has the sole responsibility of continued compliance of the device.

Hereafter the best measurement capability for CQA laboratory is reported:

Test	Range	Uncertainty	Notes
Radiated Emission	Below 1GHz	±5.12dB	(1)
Radiated Emission	Above 1GHz	±4.60dB	(1)
Conducted Disturbance	0.15~30MHz	±3.34dB	(1)

(1) This uncertainty represents an expanded uncertainty expressed at approximately the 95% confidence level using a coverage factor of k=2.

5.8 Deviation from Standards

None.

5.9 Abnormalities from Standard Conditions

None.

5.10 Other Information Requested by the Customer

None.

5.11 Equipment List

Item	Test Equipment	Manufacturer	Model No.	Instrument No.	Calibration Due Date
1	EMI Test Receiver	R&S	ESR7	CQA-005	2018/9/24
2	Spectrum analyzer	R&S	FSU26	CQA-038	2018/9/24
3	Preamplifier	MITEQ	AFS4-00010300-18-10P-4	CQA-035	2018/9/24
4	Preamplifier	MITEQ	AMF-6D-02001800-29-20P	CQA-036	2018/9/24
5	Loop antenna	ZHINAN	ZN30900A	CQA-087	2019/3/21
6	Bilog Antenna	R&S	HL562	CQA-011	2018/9/24
7	Horn Antenna	R&S	HF906	CQA-012	2018/9/24
8	Horn Antenna	R&S	BBHA 9170	CQA-088	2018/9/24
9	Coax cable (9KHz~40GHz)	CQA	RE-low-01	CQA-077	2018/9/24
10	Coax cable (9KHz~40GHz)	CQA	RE-high-02	CQA-078	2018/9/24
11	Antenna Connector	CQA	RFC-01	CQA-080	2018/9/24
12	RF cable(9KHz~40GHz)	CQA	RF-01	CQA-079	2018/9/24
13	Power Sensor	Anritsu	MA2411B	CQA-089	2018/9/24
14	Wideband Peak Power Meter	Anritsu	ML2495A	CQA-090	2018/9/24
15	EMI Test Receiver	R&S	ESPI3	CQA-005	2018/9/24
16	LISN	R&S	ENV216	CQA-003	2018/9/24
17	Coaxial cable (9KHz~300MHz)	CQA	N/A	CQA-C009	2018/10/17
18	Power divider	CQA	PWD-2533-02-SMA-79	CQA-067	2018/9/29

Note:

The temporary antenna connector is soldered on the PCB board in order to perform conducted tests and this temporary antenna connector is listed in the equipment list.

6 Test results and Measurement Data

6.1 Antenna Requirement

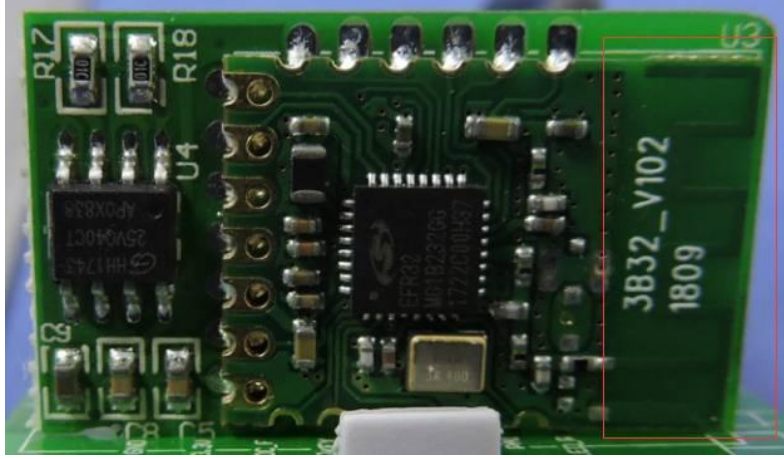
Standard requirement:	47 CFR Part 15C Section 15.203 /247(c), RSS-Gen Issue 5
<p>15.203 requirement: An intentional radiator shall be designed to ensure that no antenna other than that furnished by the responsible party shall be used with the device. The use of a permanently attached antenna or of an antenna that uses a unique coupling to the intentional radiator, the manufacturer may design the unit so that a broken antenna can be replaced by the user, but the use of a standard antenna jack or electrical connector is prohibited.</p> <p>15.247(b) (4) requirement: The conducted output power limit specified in paragraph (b) of this section is based on the use of antennas with directional gains that do not exceed 6 dBi. Except as shown in paragraph (c) of this section, if transmitting antennas of directional gain greater than 6 dBi are used, the conducted output power from the intentional radiator shall be reduced below the stated values in paragraphs (b)(1), (b)(2), and (b)(3) of this section, as appropriate, by the amount in dB that the directional gain of the antenna exceeds 6 dBi.</p>	
EUT Antenna:	
<p>The antenna is PCB antenna. The best case gain of the antenna is 0.3dBi.</p>	

6.2 Conducted Emissions

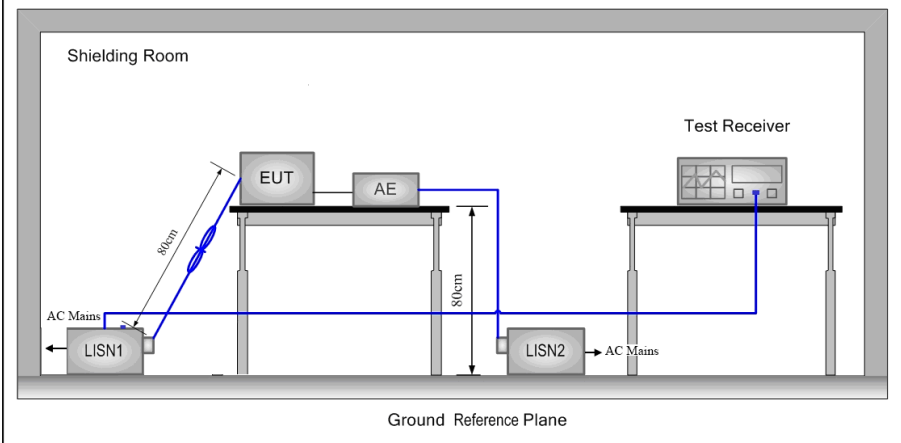
Test Requirement:	47 CFR Part 15C Section 15.207, RSS-Gen Issue 5		
Test Method:	ANSI C63.10: 2013		
Test Frequency Range:	150kHz to 30MHz		
Limit:	Frequency range (MHz)	Limit (dBuV)	
		Quasi-peak	Average
	0.15-0.5	66 to 56*	56 to 46*
	0.5-5	56	46
	5-30	60	50
* Decreases with the logarithm of the frequency.			
Test Procedure:	<ol style="list-style-type: none"> 1) The mains terminal disturbance voltage test was conducted in a shielded room. 2) The EUT was connected to AC power source through a LISN 1 (Line Impedance Stabilization Network) which provides a $50\Omega/50\mu\text{H} + 5\Omega$ linear impedance. The power cables of all other units of the EUT were connected to a second LISN 2, which was bonded to the ground reference plane in the same way as the LISN 1 for the unit being measured. A multiple socket outlet strip was used to connect multiple power cables to a single LISN provided the rating of the LISN was not exceeded. 3) The tabletop EUT was placed upon a non-metallic table 0.8m above the ground reference plane. And for floor-standing arrangement, the EUT was placed on the horizontal ground reference plane, 4) The test was performed with a vertical ground reference plane. The rear of the EUT shall be 0.4 m from the vertical ground reference plane. The vertical ground reference plane was bonded to the horizontal ground reference plane. The LISN 1 was placed 0.8 m from the boundary of the unit under test and bonded to a ground reference plane for LISNs mounted on top of the ground reference plane. This distance was between the closest points of the LISN 1 and the EUT. All other units of the EUT and associated equipment was at least 0.8 m from the LISN 2. 5) In order to find the maximum emission, the relative positions of equipment and all of the interface cables must be changed according to ANSI C63.10: 2013 on conducted measurement. 		
Test Setup:			

Exploratory Test Mode:	Transmitting with O-QPSK at lowest, middle and highest channel.
Final Test Mode:	Through Pre-scan, find at highest channel is the worst case. Only the worst case is recorded in the report.
Test Voltage:	AC120V/60Hz
Test Results:	Pass

Measurement Data

Live Line:

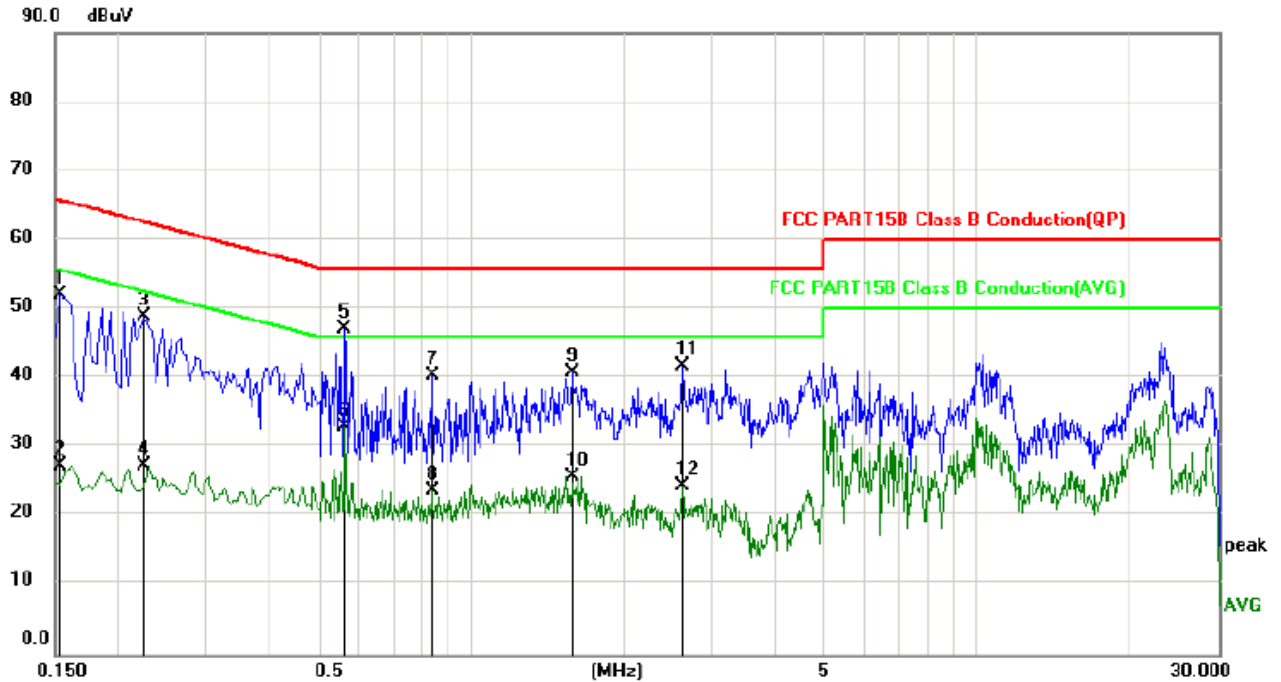

No.	Mk.	Freq.	Reading Level	Correct Factor	Measurement	Limit	Over	Detector
		MHz	dBuV	dB	dBuV	dBuV	dB	
1		0.1539	42.36	9.73	52.09	65.79	-13.70	peak
2		0.1539	17.52	9.73	27.25	55.79	-28.54	AVG
3		0.2260	39.24	9.74	48.98	62.60	-13.62	peak
4		0.2260	17.59	9.74	27.33	52.60	-25.27	AVG
5	*	0.5620	37.38	9.74	47.12	56.00	-8.88	peak
6		0.5620	23.33	9.74	33.07	46.00	-12.93	AVG
7		0.8380	30.56	9.74	40.30	56.00	-15.70	peak
8		0.8380	13.95	9.74	23.69	46.00	-22.31	AVG
9		1.5820	31.03	9.76	40.79	56.00	-15.21	peak
10		1.5820	16.08	9.76	25.84	46.00	-20.16	AVG
11		2.6180	31.86	9.77	41.63	56.00	-14.37	peak
12		2.6180	14.56	9.77	24.33	46.00	-21.67	AVG

Remark:

1. The following Quasi-Peak and Average measurements were performed on the EUT:
2. Final Test Level = Receiver Reading + LISN Factor + Cable Loss.
3. If the Peak value under Average limit, the Average value is not recorded in the report.

Neutral Line:

90.0 dBuV

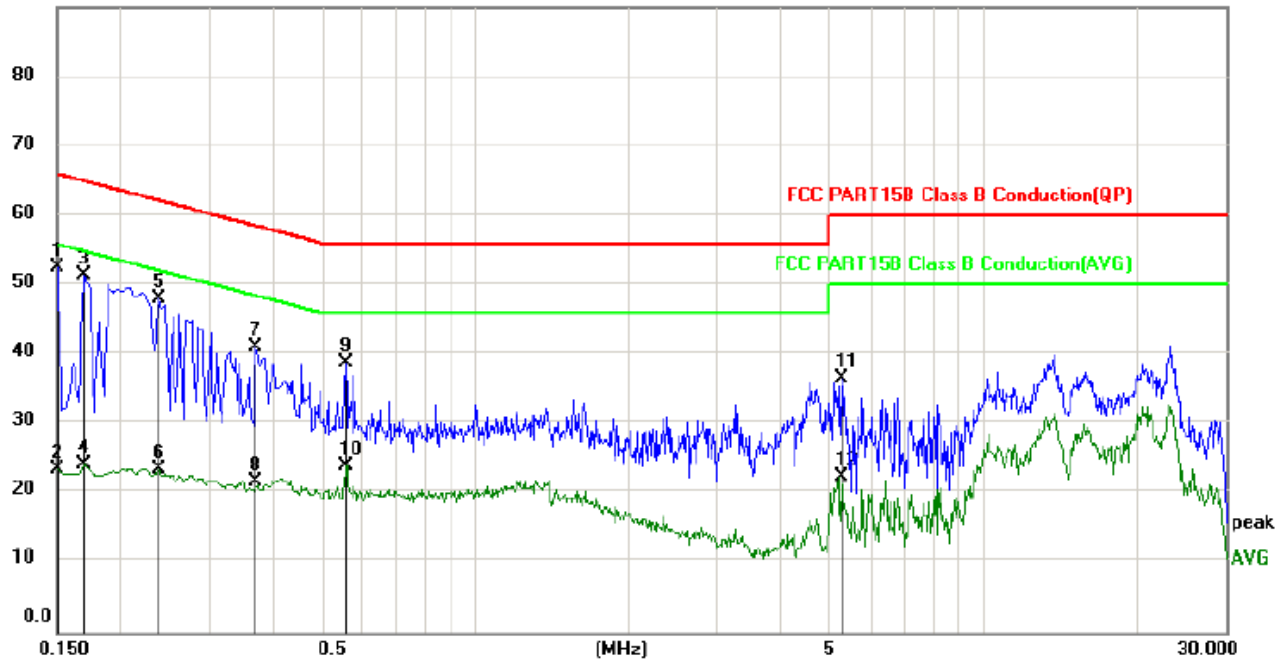

No.	Mk.	Freq. MHz	Reading Level dBuV	Correct Factor dB	Measure- ment dBuV	Limit dBuV	Over dB	Detector
1	*	0.1500	42.83	9.79	52.62	66.00	-13.38	peak
2		0.1500	13.81	9.79	23.60	56.00	-32.40	AVG
3		0.1700	41.64	9.79	51.43	64.96	-13.53	peak
4		0.1700	14.35	9.79	24.14	54.96	-30.82	AVG
5		0.2380	38.18	9.80	47.98	62.17	-14.19	peak
6		0.2380	13.75	9.80	23.55	52.17	-28.62	AVG
7		0.3700	31.28	9.80	41.08	58.50	-17.42	peak
8		0.3700	11.85	9.80	21.65	48.50	-26.85	AVG
9		0.5580	29.12	9.80	38.92	56.00	-17.08	peak
10		0.5580	14.13	9.80	23.93	46.00	-22.07	AVG
11		5.2619	26.67	9.83	36.50	60.00	-23.50	peak
12		5.2619	12.66	9.83	22.49	50.00	-27.51	AVG

Remark:

1. The following Quasi-Peak and Average measurements were performed on the EUT:
2. Final Test Level = Receiver Reading + LISN Factor + Cable Loss.
3. If the Peak value under Average limit, the Average value is not recorded in the report.

6.3 Conducted Peak & Average Output Power

Test Requirement:	47 CFR Part 15C Section 15.247 (b)(3), RSS 247 5.4(4)
Test Method:	KDB558074 D01 v04
Test Setup:	 <pre> graph LR EUT[EUT] --- PM[Power Meter] </pre>
Test Mode:	Transmitting with O-QPSK at lowest, middle and highest channel.
Limit:	30dBm
Test Results:	Pass

Measurement Data

O-QPSK mode				
Test channel	Peak Output Power (dBm)	Average Output Power (dBm)	Limit (dBm)	Result
Lowest	17.06	16.78	30.00	Pass
Middle	17.08	16.81	30.00	Pass
Highest	17.11	16.95	30.00	Pass

6.4 6dB Occupancy Bandwidth

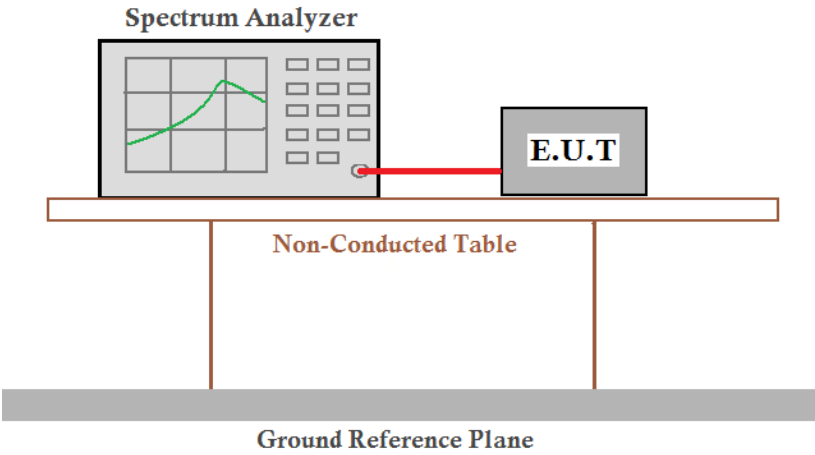
Test Requirement:	47 CFR Part 15C Section 15.247 (a)(2), RSS 247 5.2(1)
Test Method:	KDB558074 D01 v04
Test Setup:	 <p style="text-align: center;"><i>Remark: Offset = cable loss + attenuation factor</i></p>
Test Mode:	Transmitting with O-QPSK at lowest, middle and highest channel.
Limit:	≥ 500 kHz
Test Results:	Pass

Measurement Data

O-QPSK mode			
Test channel	6dB Occupancy Bandwidth (MHz)	Limit (kHz)	Result
Lowest	1.630	≥500	Pass
Middle	1.650	≥500	Pass
Highest	1.625	≥500	Pass

Test plot as follows:

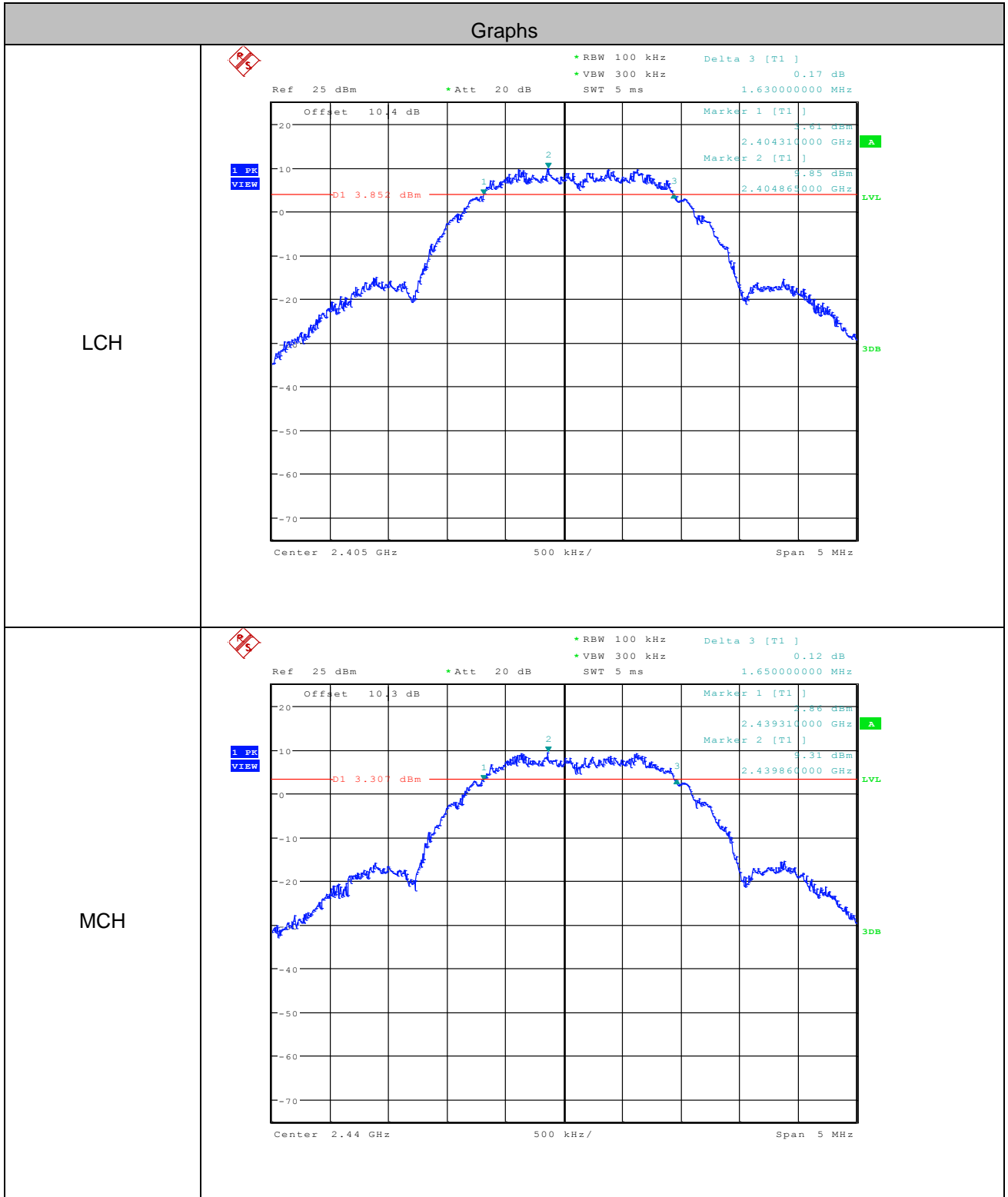

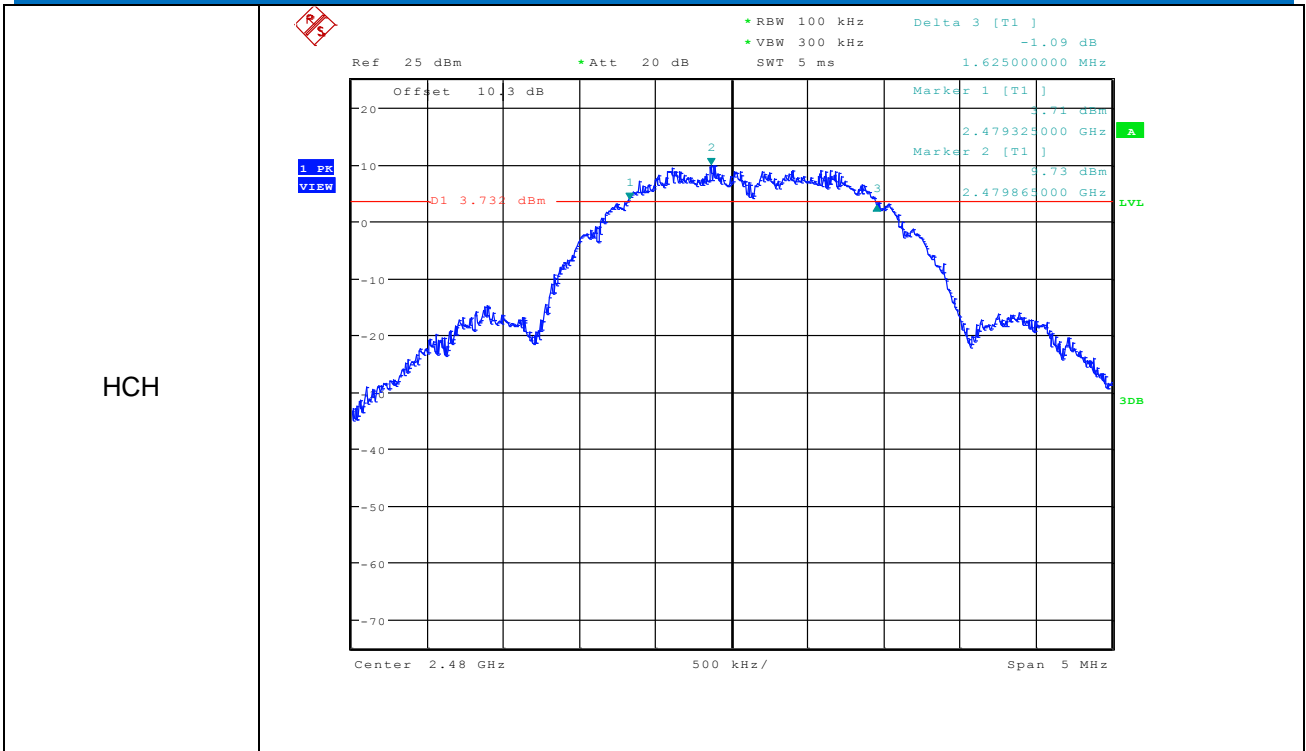

6.5 99% Occupy Bandwidth

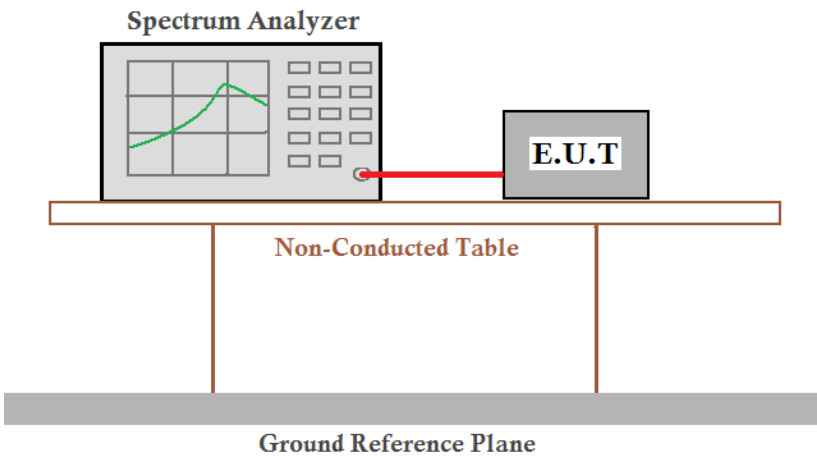
Test Requirement:	RSS-Gen Issue 5
Test Method:	RSS-Gen Issue 5
Test Setup:	 <p style="text-align: center;"><i>Remark: Offset = cable loss + attenuation factor</i></p>
Test Mode:	Transmitting with O-QPSK at lowest, middle and highest channel.
Limit:	N/A
Test Results:	Pass

Measurement Data

O-QPSK mode			
Test channel	99% Occupy Bandwidth (MHz)	Limit (kHz)	Result
Lowest	2.275	---	Pass
Middle	2.275	---	Pass
Highest	2.280	---	Pass

Test plot as follows:

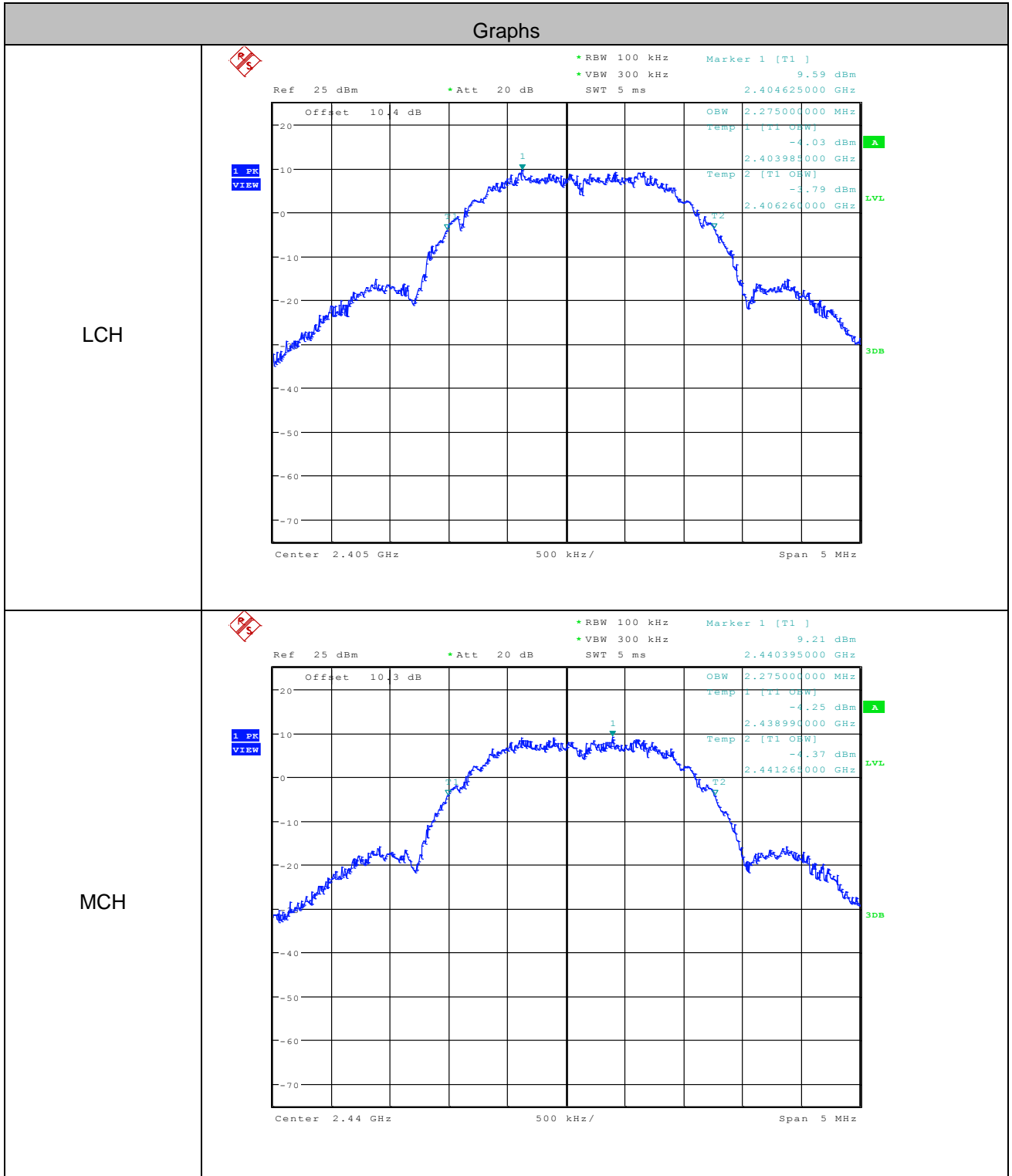

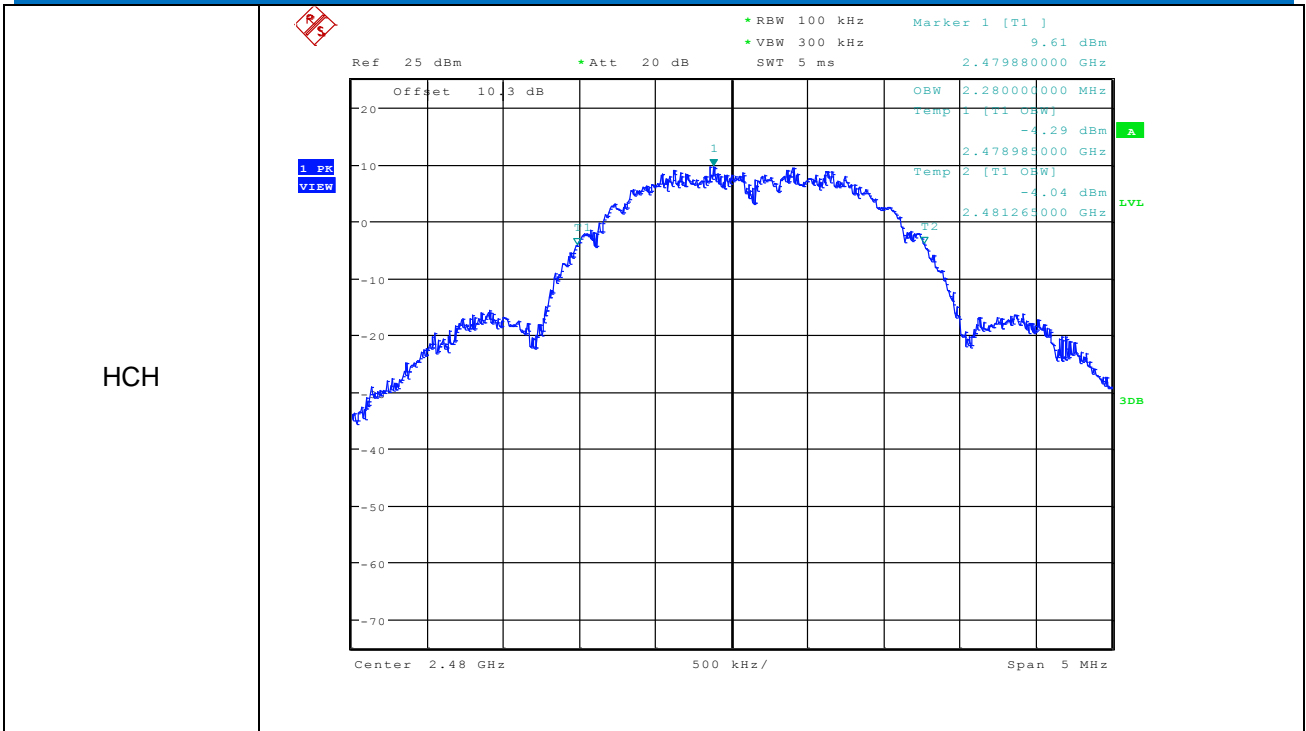

6.6 Power Spectral Density

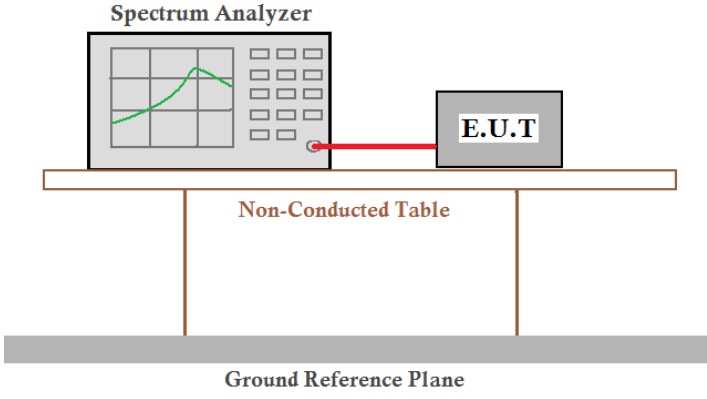
Test Requirement:	47 CFR Part 15C Section 15.247 (e), RSS 247 5.2(2)
Test Method:	KDB558074 D01 v04
Test Setup:	 <p style="text-align: center;"><i>Remark: Offset = cable loss + attenuation factor</i></p>
Test Mode:	Transmitting with O-QPSK at lowest, middle and highest channel.
Limit:	≤8.00dBm/3kHz
Test Results:	Pass

Measurement Data

O-QPSK mode			
Test channel	Power Spectral Density (dBm/3kHz)	Limit (dBm/3kHz)	Result
Lowest	-2.2	≤8.00	Pass
Middle	-3.07	≤8.00	Pass
Highest	-1.91	≤8.00	Pass

Test plot as follows:

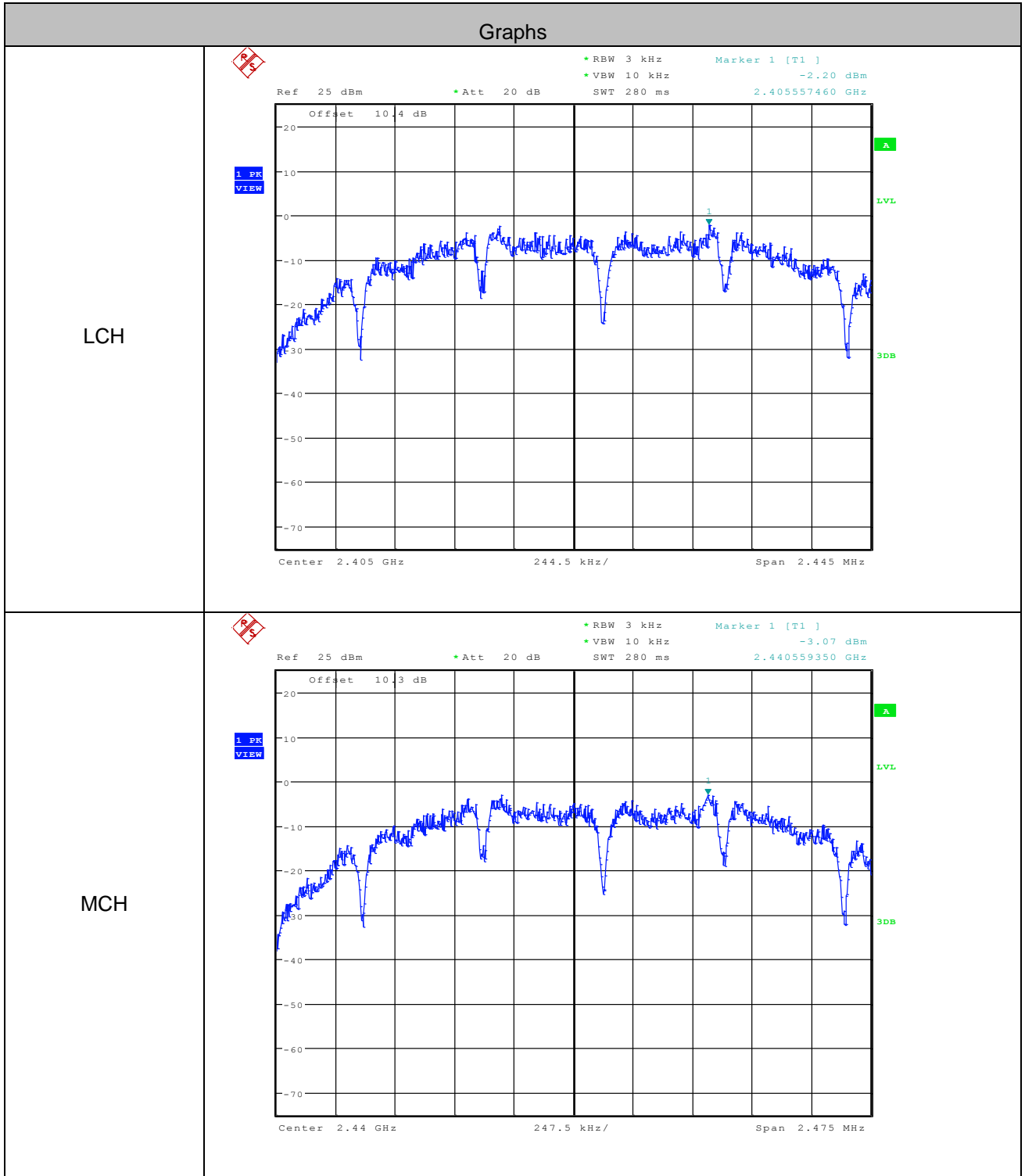

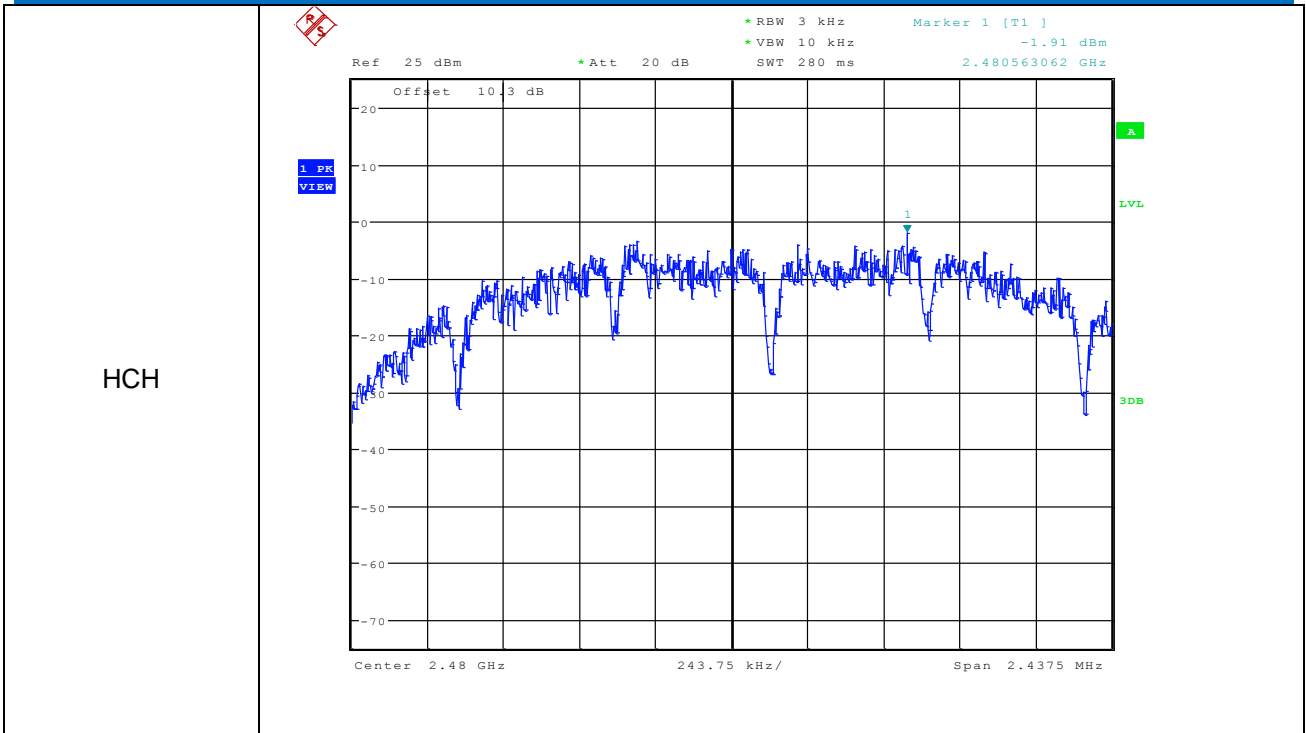

6.7 Band-edge for RF Conducted Emissions

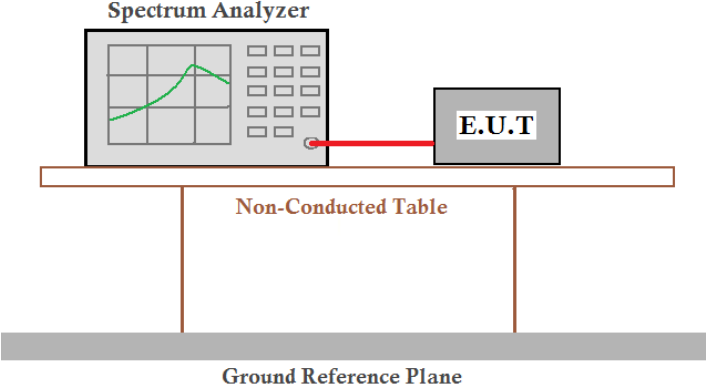
Test Requirement:	47 CFR Part 15C Section 15.247 (d), RSS 247 5.5
Test Method:	KDB558074 D01 v04
Test Setup:	 <p style="text-align: center;"><i>Remark: Offset = cable loss + attenuation factor</i></p>
Test Mode:	Transmitting with O-QPSK at lowest, middle and highest channel.
Limit:	In any 100 kHz bandwidth outside the frequency band in which the spread spectrum intentional radiator is operating, the radio frequency power that is produced by the intentional radiator shall be at least 20 dB below that in the 100 kHz bandwidth within the band that contains the highest level of the desired power, based on either an RF conducted or a radiated measurement.
Test Results:	Pass

Test Data:

O-QPSK Test mode				
Test channel	Frequency(MHz)	Emission Level(dBm)	Limit(dBm)	Result
Lowest	2400	-42.265	-11.65	Pass
Highest	2483.5	-37.116	-11.11	Pass

Test plot as follows:

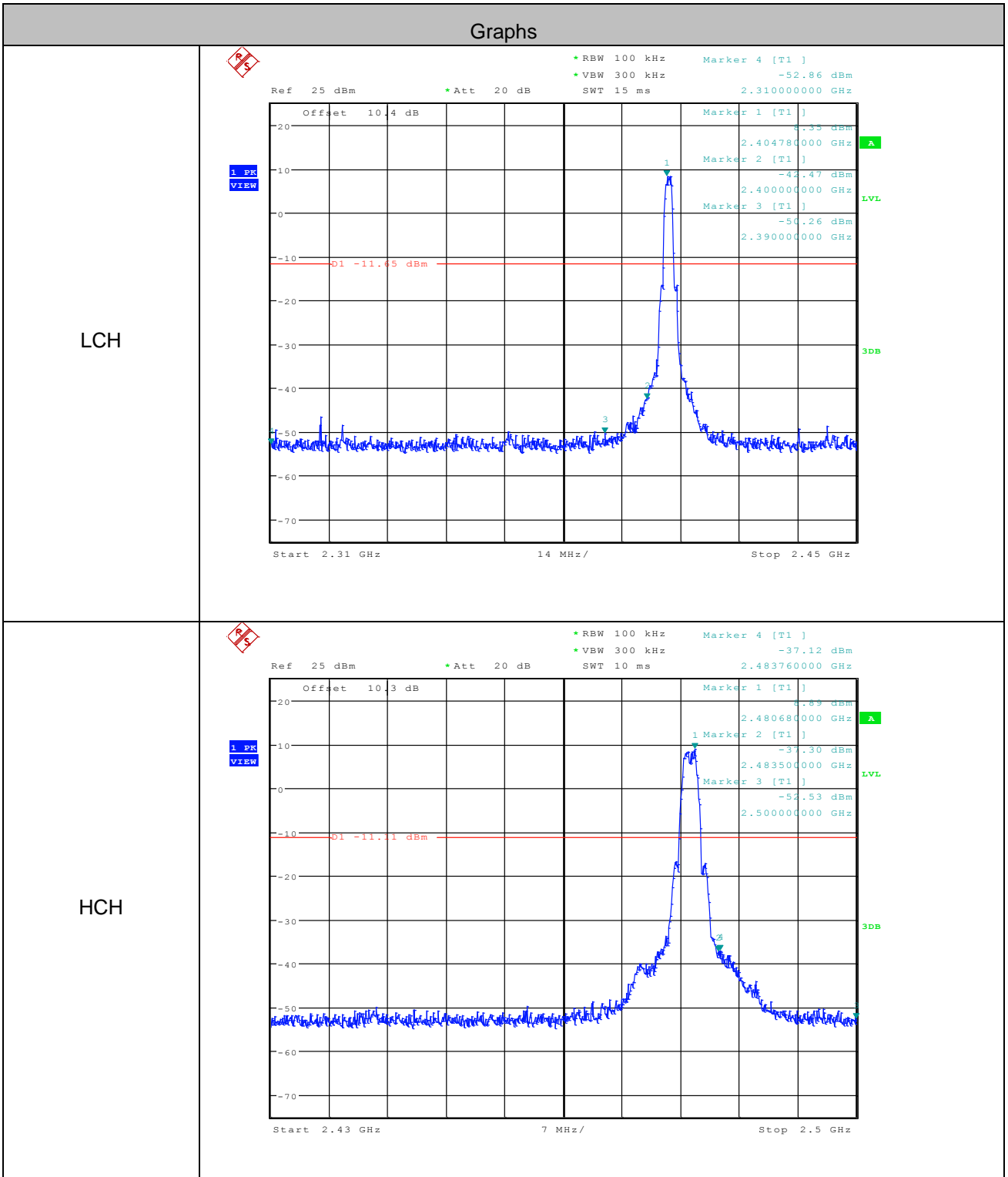

6.8 RF Conducted Spurious Emissions

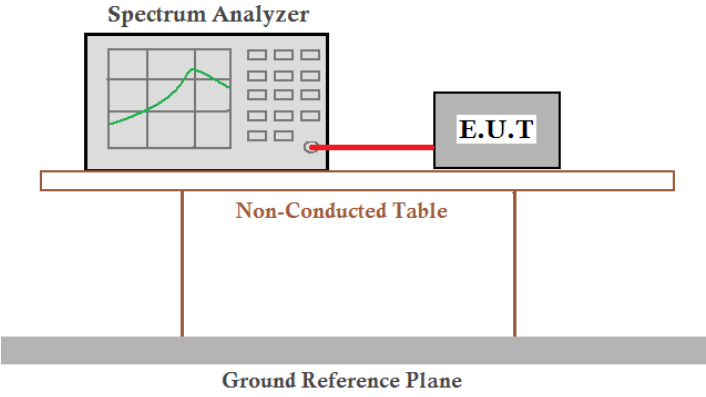
Test Requirement:	47 CFR Part 15C Section 15.247 (d), RSS 247 5.5
Test Method:	KDB558074 D01 v04
Test Setup:	 <p>The diagram illustrates the test setup for RF conducted spurious emissions. A Spectrum Analyzer is connected via a red cable to an E.U.T. (Equipment Under Test). Both are placed on a Non-Conducted Table, which is supported by two vertical legs. Below the table is a Ground Reference Plane, represented by a thick grey bar.</p> <p><i>Remark: Offset = cable loss + attenuation factor</i></p>
Test Mode:	Transmitting with O-QPSK at lowest, middle and highest channel.
Limit:	In any 100 kHz bandwidth outside the frequency band in which the spread spectrum intentional radiator is operating, the radio frequency power that is produced by the intentional radiator shall be at least 20 dB below that in the 100 kHz bandwidth within the band that contains the highest level of the desired power, based on either an RF conducted or a radiated measurement.
Test Results:	Pass

Test plot as follows:

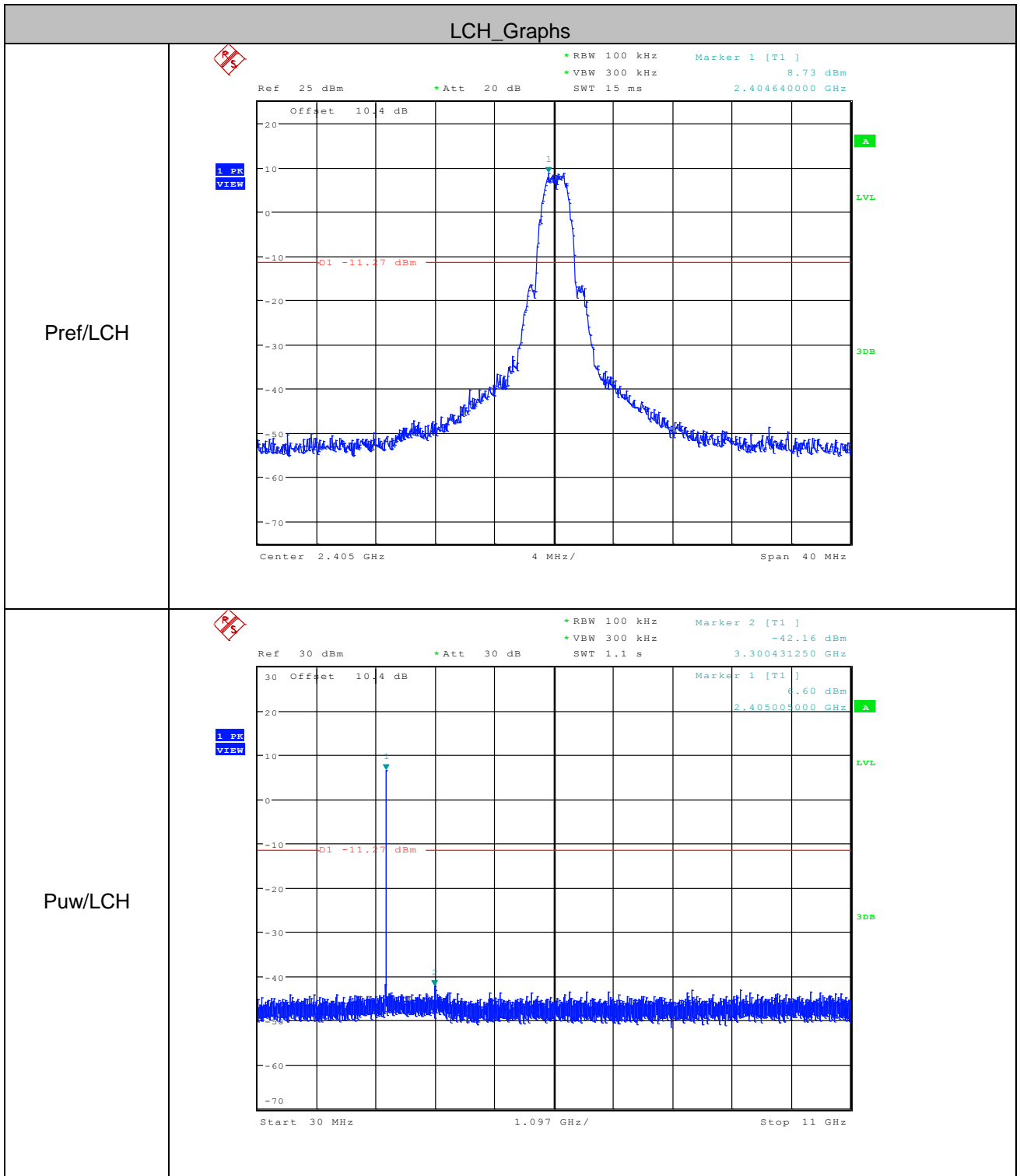

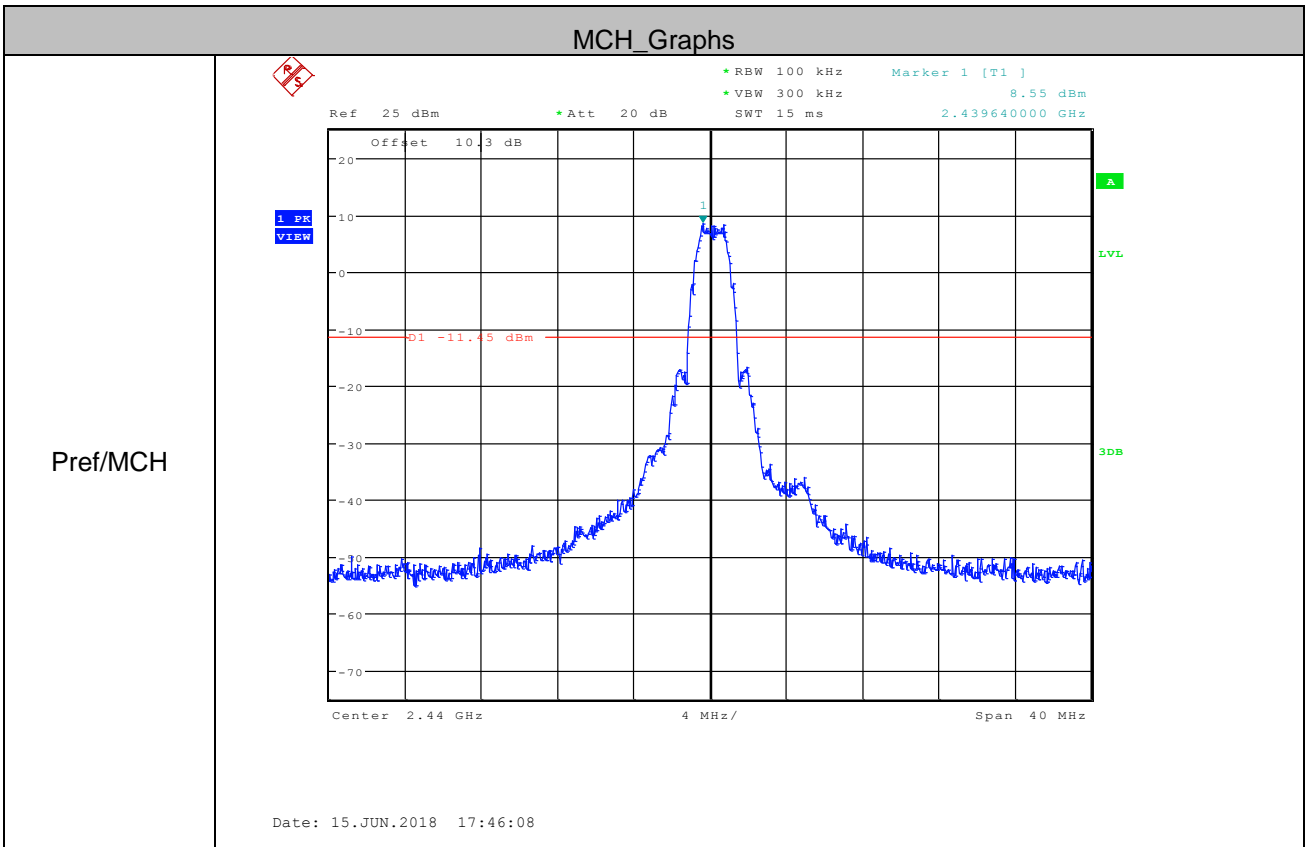
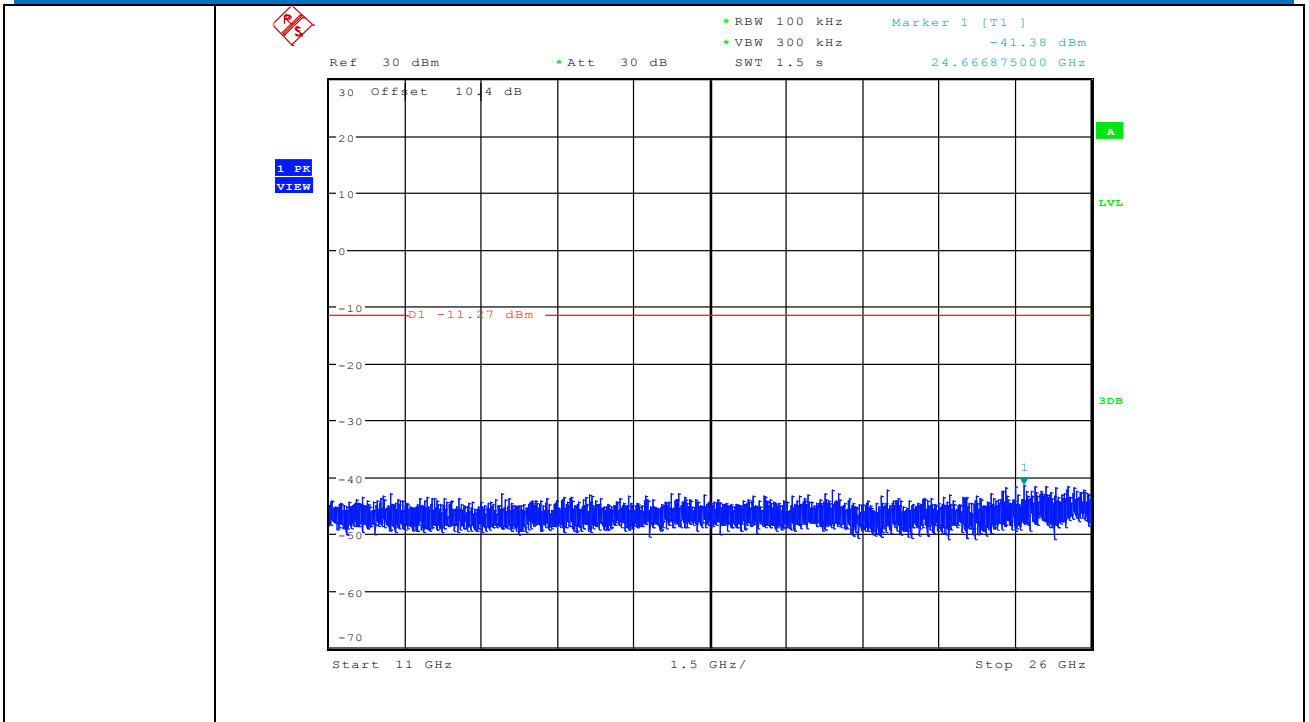

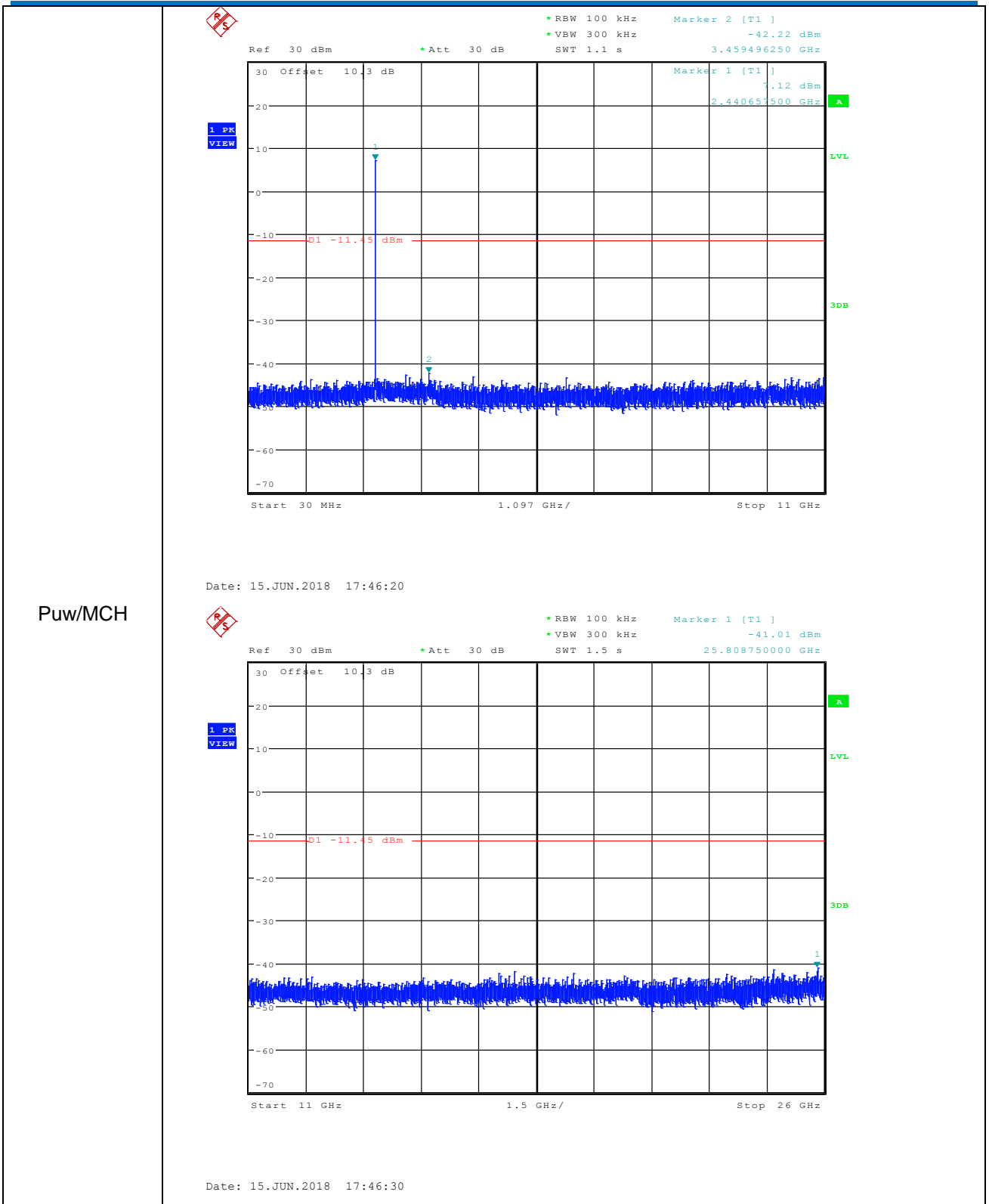

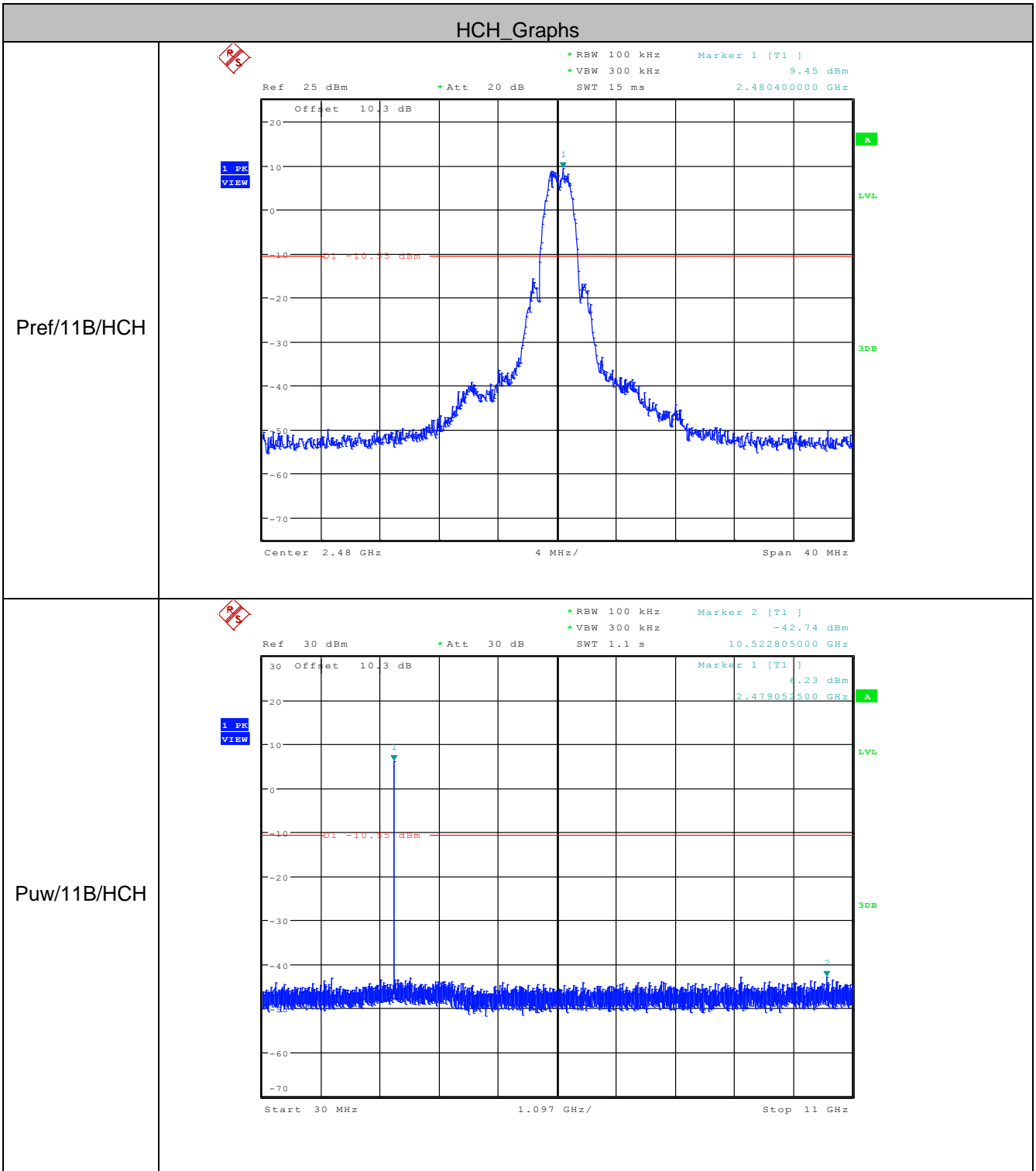

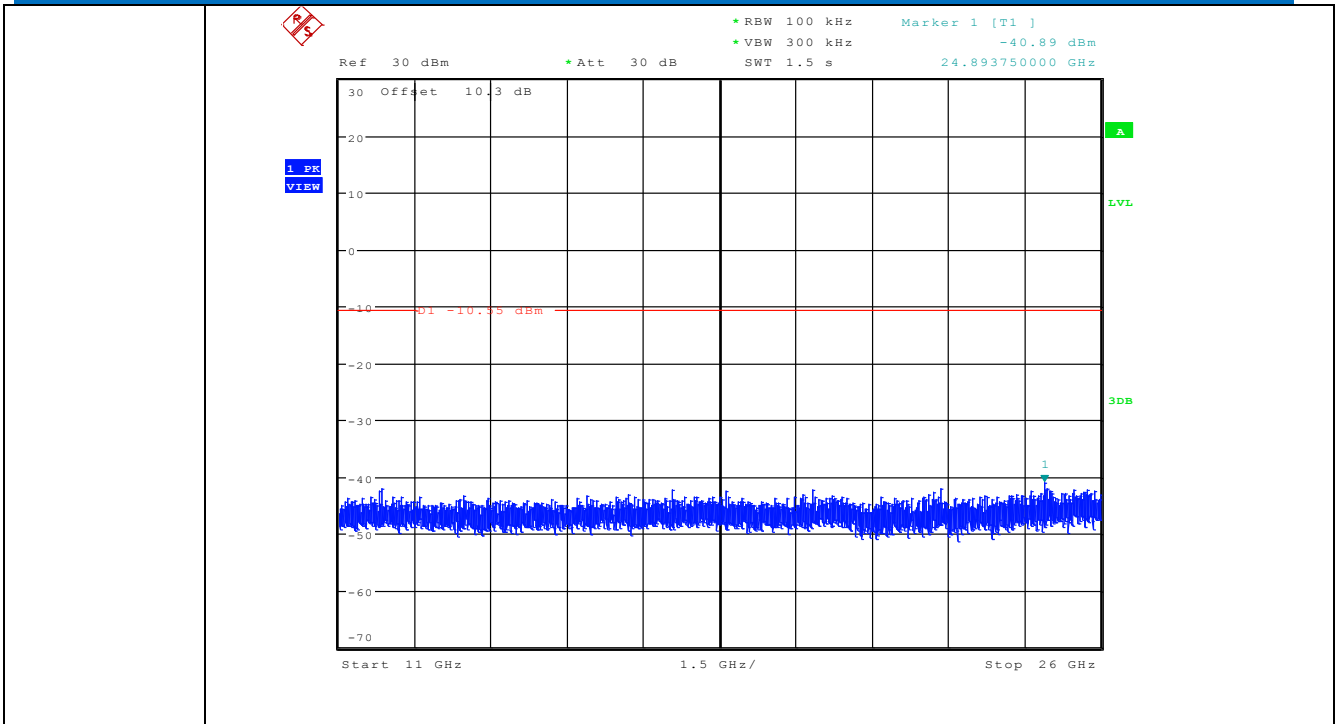

Remark:

Pretest 9kHz to 25GHz, find the highest point when testing, so only the worst data were shown in the test report. Per FCC Part 15.33 (a) and 15.31 (o) ,The amplitude of spurious emissions from intentional radiators which are attenuated more than 20 dB below the permissible value need not be reported unless specifically required elsewhere in this part.

6.9 Radiated Spurious Emissions

Test Requirement:	47 CFR Part 15C Section 15.209 and 15.205, RSS-Gen Issue 5				
Test Method:	ANSI C63.10 2013				
Test Site:	Measurement Distance: 3m (Semi-Anechoic Chamber)				
Receiver Setup:	Frequency	Detector	RBW	VBW	Remark
	0.009MHz-0.090MHz	Peak	10kHz	30kHz	Peak
	0.009MHz-0.090MHz	Average	10kHz	30kHz	Average
	0.090MHz-0.110MHz	Quasi-peak	10kHz	30kHz	Quasi-peak
	0.110MHz-0.490MHz	Peak	10kHz	30kHz	Peak
	0.110MHz-0.490MHz	Average	10kHz	30kHz	Average
	0.490MHz -30MHz	Quasi-peak	10kHz	30kHz	Quasi-peak
	30MHz-1GHz	Quasi-peak	100 kHz	300kHz	Quasi-peak
	Above 1GHz	Peak	1MHz	3MHz	Peak
Peak		1MHz	10Hz	Average	
Limit:	Frequency	Field strength (microvolt/meter)	Limit (dBuV/m)	Remark	Measurement distance (m)
	0.009MHz-0.490MHz	2400/F(kHz)	-	-	300
	0.490MHz-1.705MHz	24000/F(kHz)	-	-	30
	1.705MHz-30MHz	30	-	-	30
	30MHz-88MHz	100	40.0	Quasi-peak	3
	88MHz-216MHz	150	43.5	Quasi-peak	3
	216MHz-960MHz	200	46.0	Quasi-peak	3
	960MHz-1GHz	500	54.0	Quasi-peak	3
	Above 1GHz	500	54.0	Average	3
Note: 15.35(b), Unless otherwise specified, the limit on peak radio frequency emissions is 20dB above the maximum permitted average emission limit applicable to the equipment under test. This peak limit applies to the total peak emission level radiated by the device.					

Test Setup:

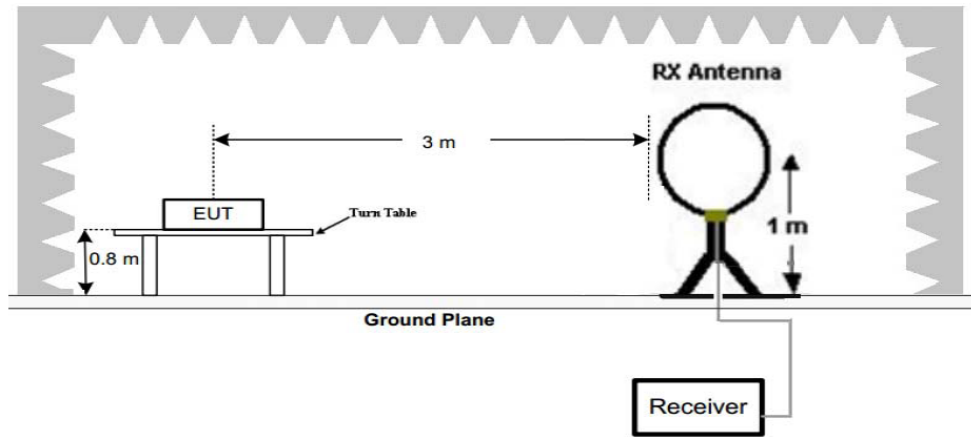

Figure 1. Below 30MHz

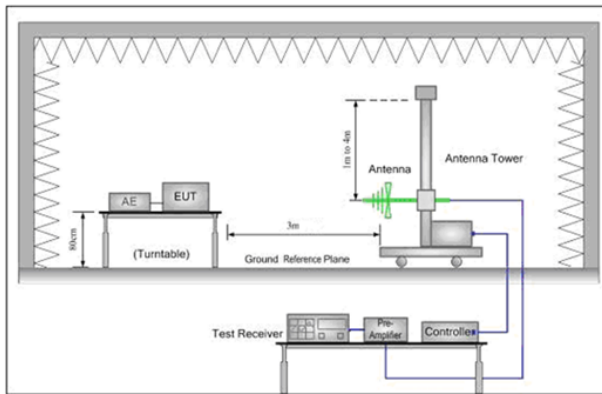

Figure 2. 30MHz to 1GHz

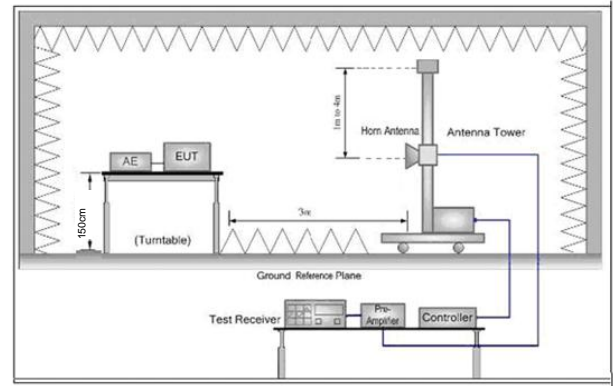

Figure 3. Above 1 GHz

Test Procedure:

- a. 1) Below 1G: The EUT was placed on the top of a rotating table 0.8 meters above the ground at a 3 meter semi-anechoic chamber. The table was rotated 360 degrees to determine the position of the highest radiation.
 - 2) Above 1G: The EUT was placed on the top of a rotating table 1.5 meters above the ground at a 3 meter semi-anechoic chamber. The table was rotated 360 degrees to determine the position of the highest radiation.
- Note: For the radiated emission test above 1GHz:
Place the measurement antenna away from each area of the EUT determined to be a source of emissions at the specified measurement distance, while keeping the measurement antenna aimed at the source of emissions at each frequency of significant emissions, with polarization oriented for maximum response. The measurement antenna may have to be higher or lower than the EUT, depending on the radiation pattern of the emission and staying aimed at the emission source for receiving the maximum signal. The final measurement antenna elevation shall be that which maximizes the emissions. The measurement antenna elevation for maximum emissions shall be restricted to a range of heights of from 1 m to 4 m above the ground or reference ground plane.
- b. The EUT was set 3 meters away from the interference-receiving antenna, which was mounted on the top of a variable-height antenna tower.
 - c. The antenna height is varied from one meter to four meters above the ground to determine the maximum value of the field strength. Both horizontal and vertical polarizations of the antenna are set to make the measurement.
 - d. For each suspected emission, the EUT was arranged to its worst case and then the antenna was tuned to heights from 1 meter to 4 meters (for

	<p>the test frequency of below 30MHz, the antenna was tuned to heights 1 meter) and the rotatable table was turned from 0 degrees to 360 degrees to find the maximum reading.</p> <ul style="list-style-type: none"> e. The test-receiver system was set to Peak Detect Function and Specified Bandwidth with Maximum Hold Mode. f. If the emission level of the EUT in peak mode was 10dB lower than the limit specified, then testing could be stopped and the peak values of the EUT would be reported. Otherwise the emissions that did not have 10dB margin would be re-tested one by one using peak, quasi-peak or average method as specified and then reported in a data sheet. g. Test the EUT in the lowest channel ,the middle channel ,the Highest channel h. Repeat above procedures until all frequencies measured was complete.
Test Mode:	Transmitting with O-QPSK at lowest, middle and highest channel.
Final Test Mode:	For below 1GHz, through Pre-scan, find at highest channel is the worst case. Only the worst case is recorded in the report.
Test Results:	Pass

6.9.1 Radiated emission below 1GHz

30MHz~1GHz_the worst case(Middle)		
Test mode:	Transmitting	Vertical

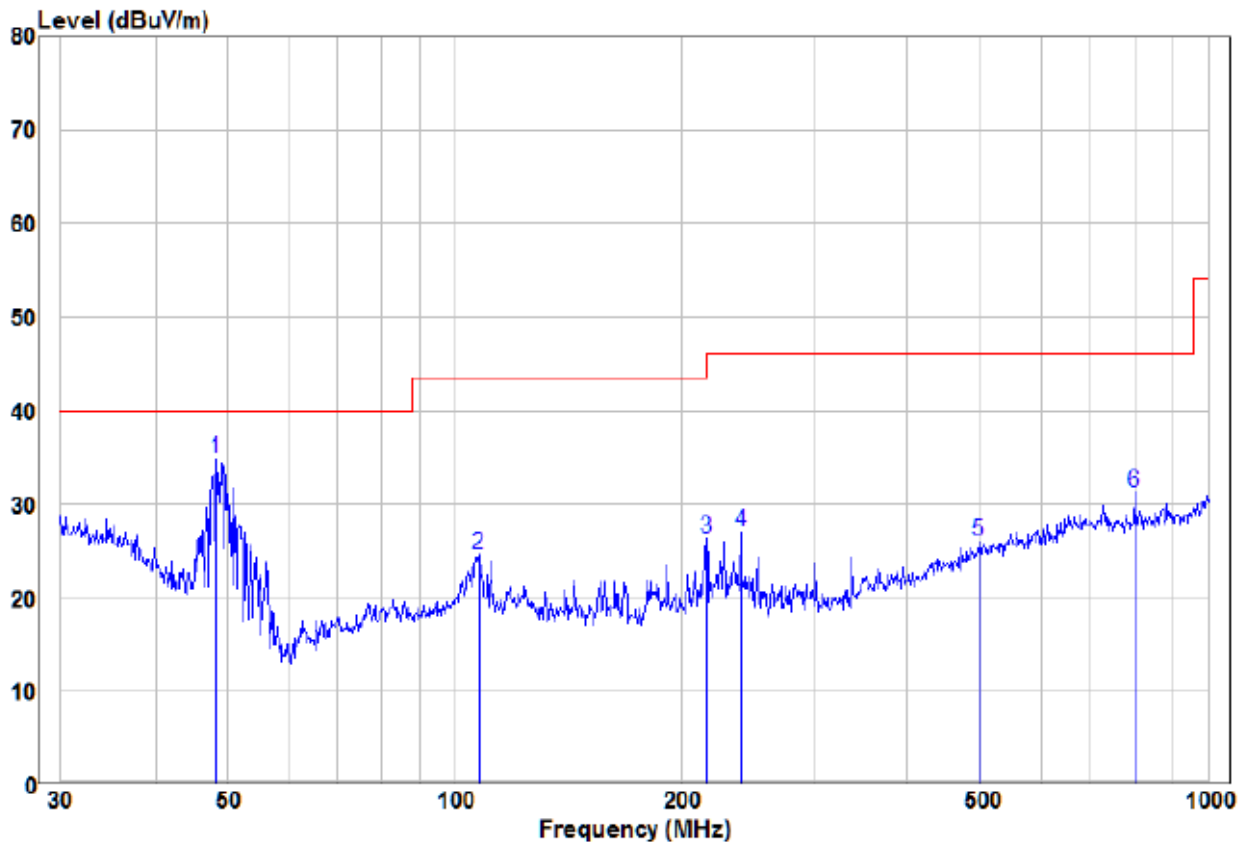

	Read		Limit	Over			
Freq	Level	Factor	Level	Line	Limit	Remark	Pol/Phase
MHz	dBuV	dB/m	dBuV/m	dBuV/m	dB		
1 pp	48.33	24.92	9.93	34.85	40.00	-5.15 Peak	VERTICAL
2	107.51	14.73	9.87	24.60	43.50	-18.90 Peak	VERTICAL
3	216.02	17.00	9.28	26.28	46.00	-19.72 Peak	VERTICAL
4	239.99	18.66	8.30	26.96	46.00	-19.04 Peak	VERTICAL
5	497.68	9.95	15.93	25.88	46.00	-20.12 Peak	VERTICAL
6	798.98	12.01	19.19	31.20	46.00	-14.80 Peak	VERTICAL

Test mode:	Transmitting	Horizontal
------------	--------------	------------

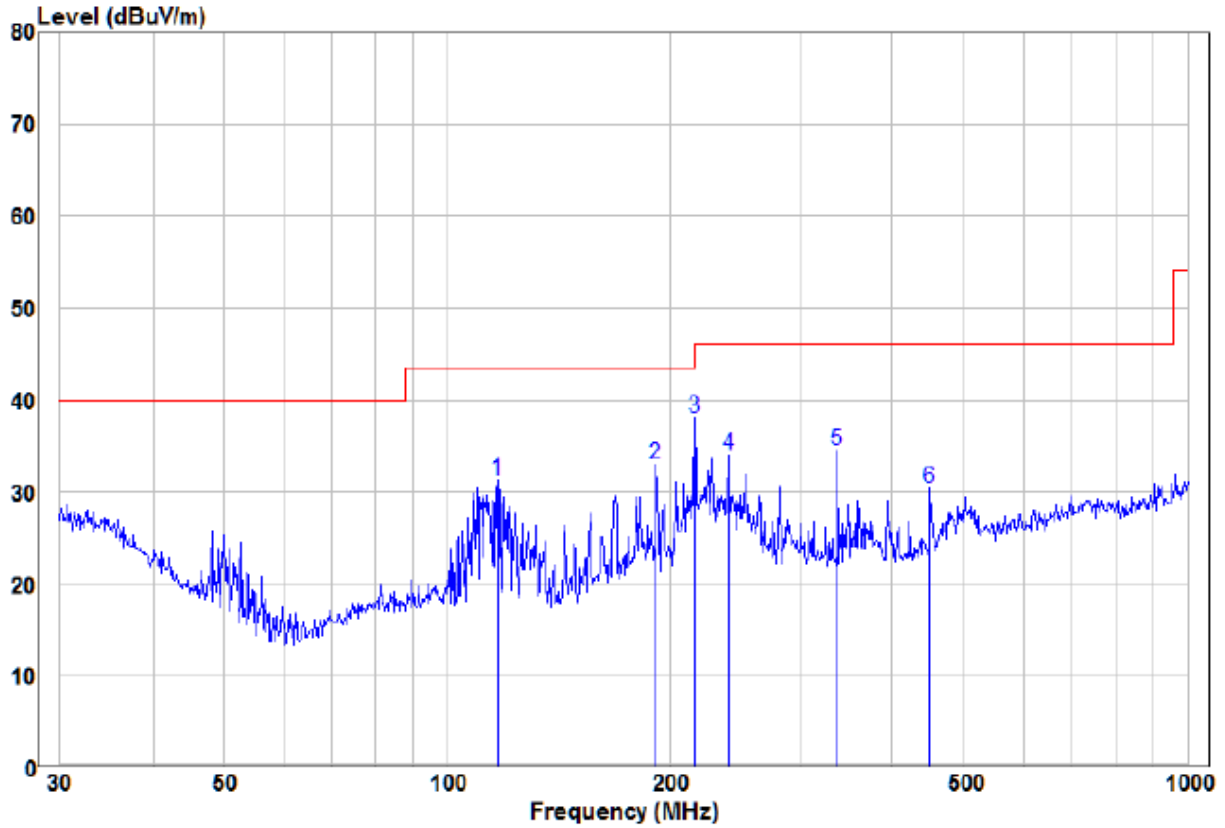

	Read Freq	Read Level	Read Factor	Level	Limit Line	Over Limit	Remark	Pol/Phase
	MHz	dBuV	dB/m	dBuV/m	dBuV/m	dB		
1	116.95	21.07	10.08	31.15	43.50	-12.35	Peak	HORIZONTAL
2	191.75	25.58	7.37	32.95	43.50	-10.55	Peak	HORIZONTAL
3 pp	216.02	28.77	9.28	38.05	46.00	-7.95	Peak	HORIZONTAL
4	239.99	25.71	8.30	34.01	46.00	-11.99	Peak	HORIZONTAL
5	337.22	22.98	11.55	34.53	46.00	-11.47	Peak	HORIZONTAL
6	449.56	15.82	14.59	30.41	46.00	-15.59	Peak	HORIZONTAL

6.9.2 Transmitter emission above 1GHz

Test mode:	Transmitting	Test channel:	Lowest
------------	--------------	---------------	--------

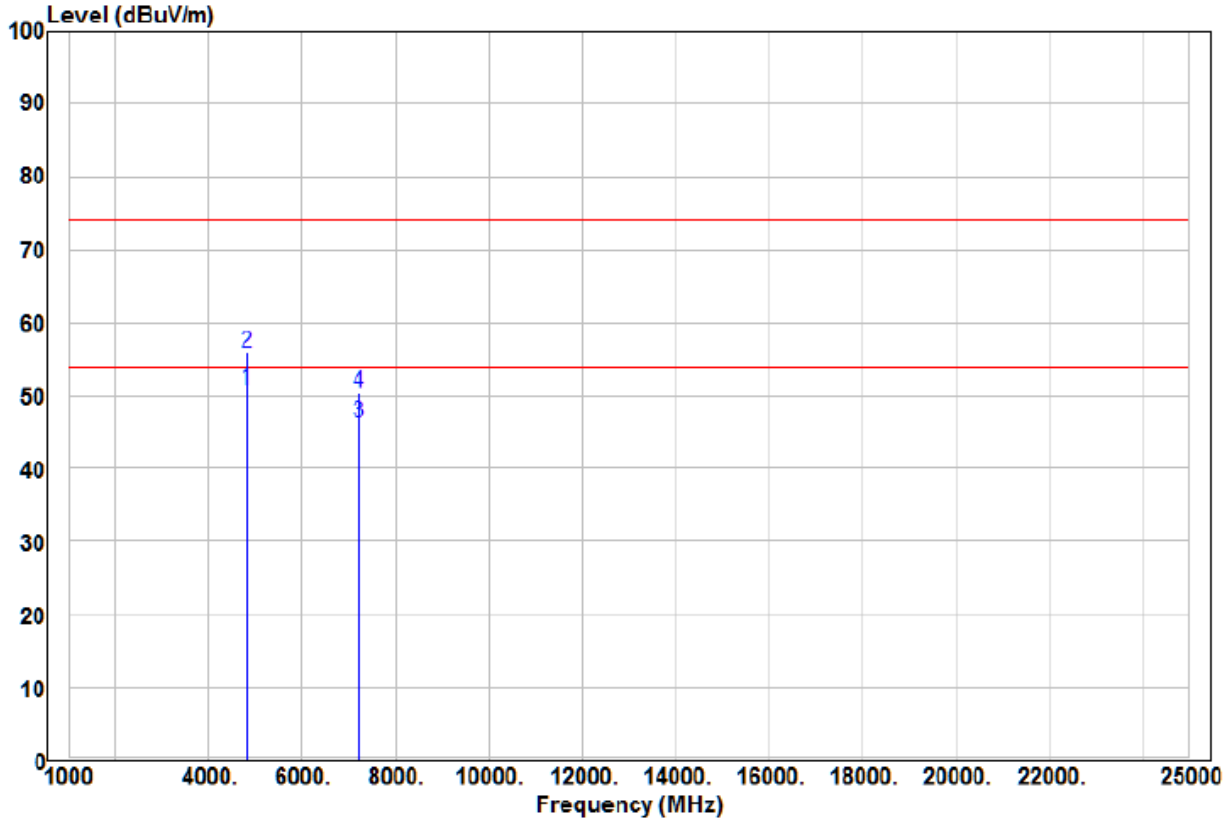

	Read			Limit	Over			
Freq	Level	Factor	Level	Line	Limit	Remark	Pol/Phase	
MHz	dBuV	dB/m	dBuV/m	dBuV/m	dB			
1 pp	4810.00	54.68	-3.97	50.71	54.00	-3.29	Average	VERTICAL
2 pk	4810.00	59.78	-3.97	55.81	74.00	-18.19	Peak	VERTICAL
3	7215.00	45.77	0.54	46.31	54.00	-7.69	Average	VERTICAL
4	7215.00	49.77	0.54	50.31	74.00	-23.69	Peak	VERTICAL

Test mode:	Transmitting	Test channel:	Lowest
------------	--------------	---------------	--------

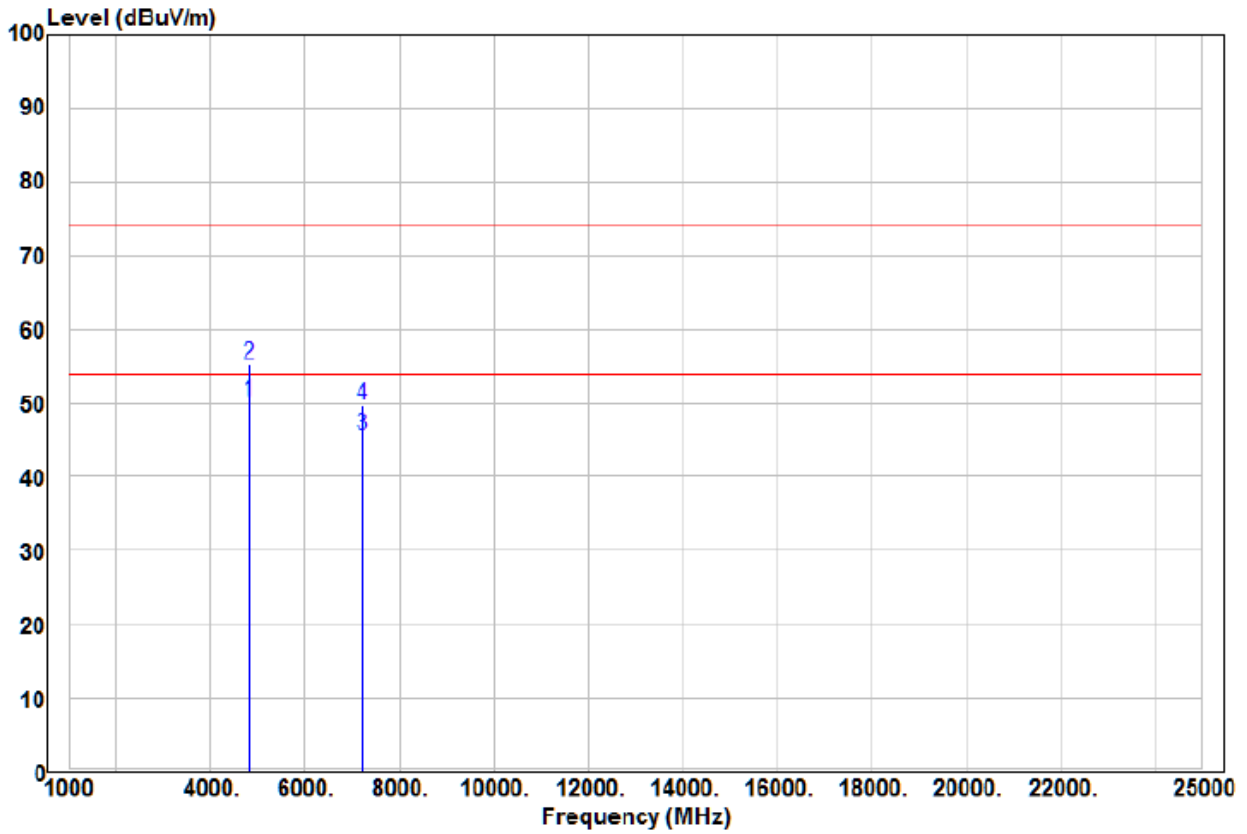

		Read		Limit	Over				
	Freq	Level	Factor	Level	Line	Limit	Remark	Pol/Phase	
	MHz	dBuV	dB/m	dBuV/m	dBuV/m	dB			
1	pp	4810.00	54.19	-3.97	50.22	54.00	-3.78	Average	HORIZONTAL
2	pk	4810.00	59.16	-3.97	55.19	74.00	-18.81	Peak	HORIZONTAL
3		7215.00	45.02	0.54	45.56	54.00	-8.44	Average	HORIZONTAL
4		7215.00	49.16	0.54	49.70	74.00	-24.30	Peak	HORIZONTAL

Test mode:	Transmitting	Test channel:	Middle
------------	--------------	---------------	--------

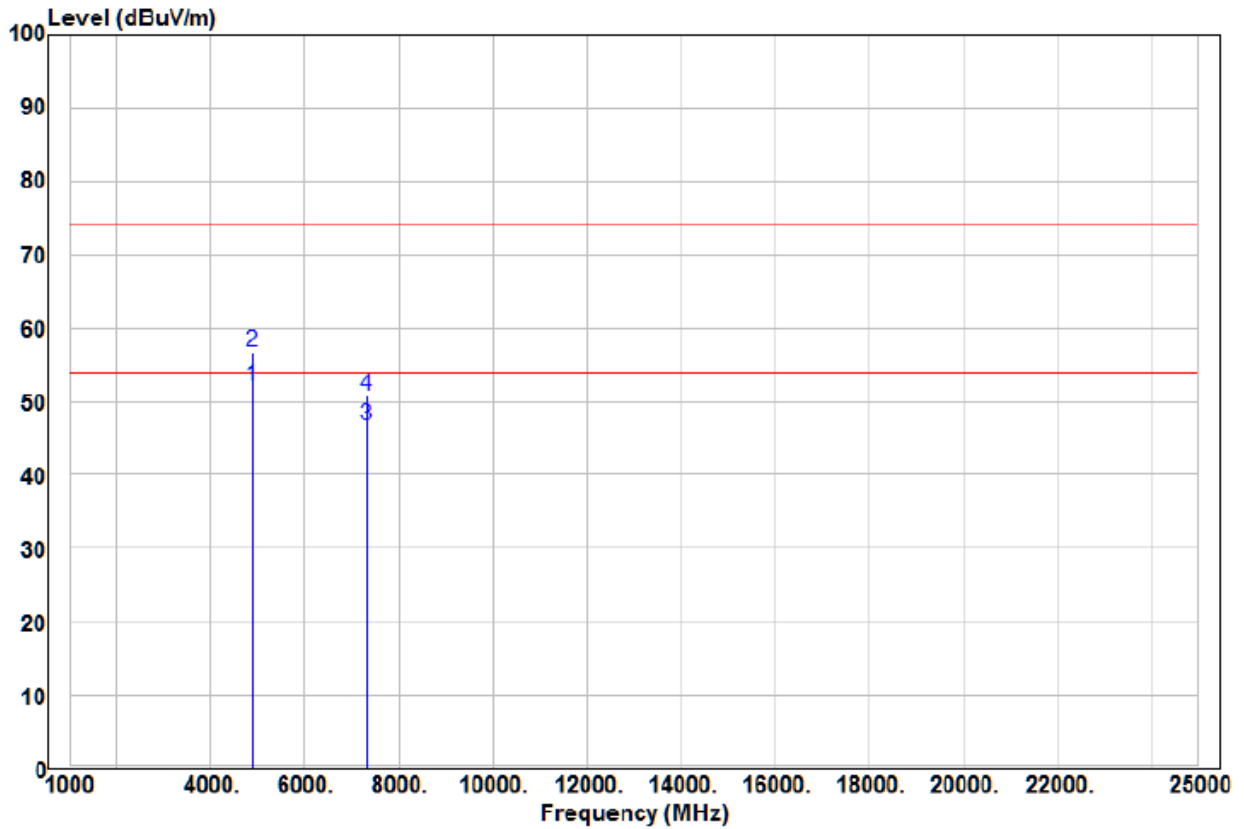

	Read		Limit	Over					
	Freq	Level	Factor	Level	Line	Limit	Remark	Pol/Phase	
	MHz	dBuV	dB/m	dBuV/m	dBuV/m	dB			
1	pp	4880.00	56.13	-4.01	52.12	54.00	-1.88	Average	VERTICAL
2	pk	4880.00	60.82	-4.01	56.81	74.00	-17.19	Peak	VERTICAL
3		7320.00	45.71	1.01	46.72	54.00	-7.28	Average	VERTICAL
4		7320.00	49.78	1.01	50.79	74.00	-23.21	Peak	VERTICAL

Test mode:	Transmitting	Test channel:	Middle
------------	--------------	---------------	--------

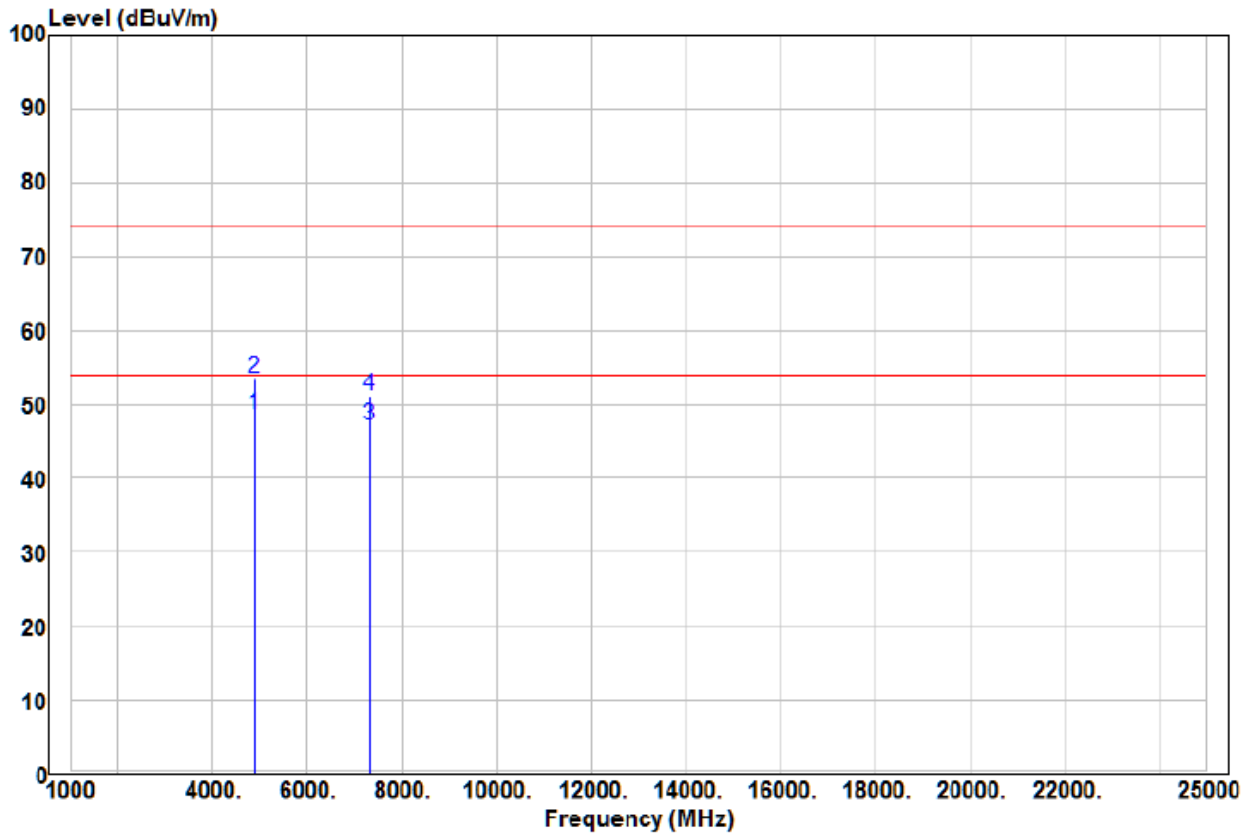

		Read		Limit	Over			
	Freq	Level	Factor	Level	Line	Limit	Remark	
	MHz	dBuV	dB/m	dBuV/m	dBuV/m	dB		
1	pp	4880.00	52.69	-4.01	48.68	54.00	-5.32 Average	HORIZONTAL
2	pk	4880.00	57.61	-4.01	53.60	74.00	-20.40 Peak	HORIZONTAL
3		7320.00	46.02	1.01	47.03	54.00	-6.97 Average	HORIZONTAL
4		7320.00	50.13	1.01	51.14	74.00	-22.86 Peak	HORIZONTAL

Test mode:	Transmitting	Test channel:	Highest
------------	--------------	---------------	---------

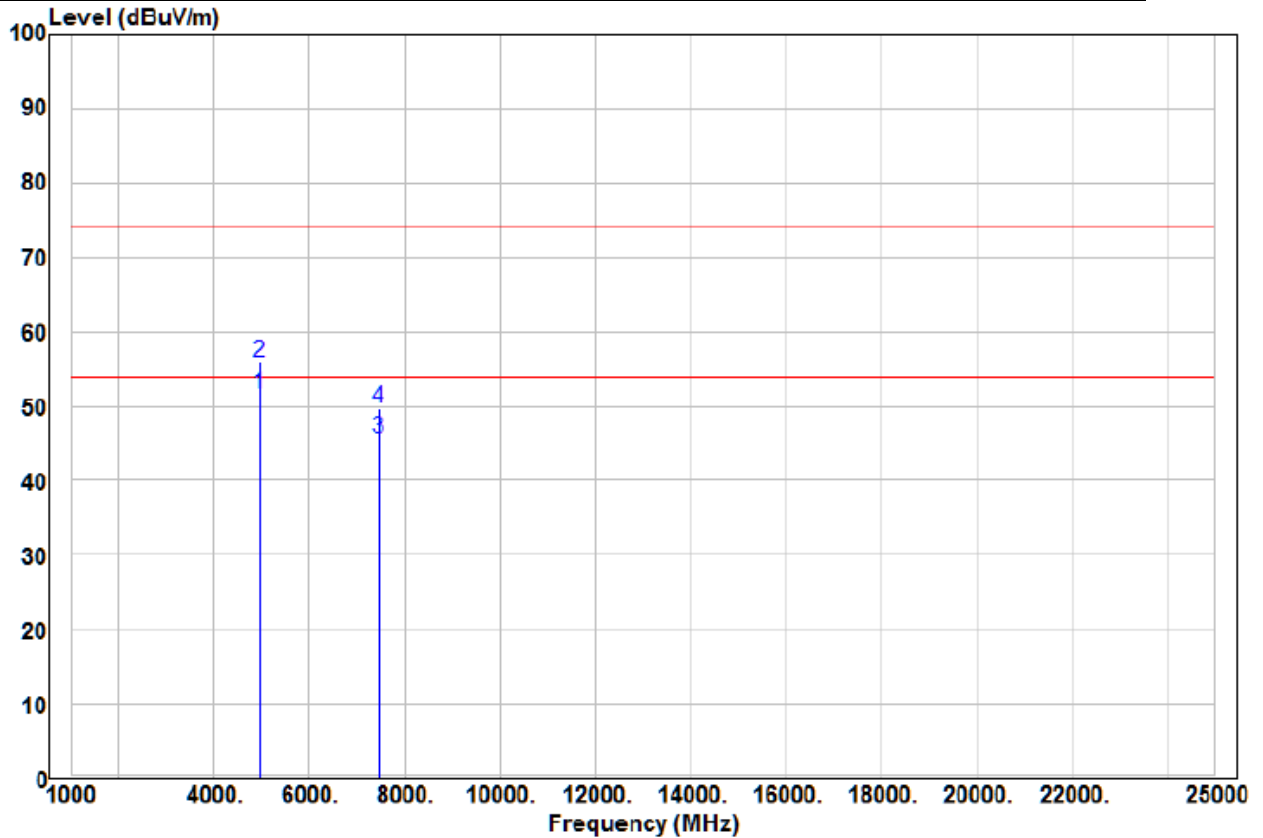

	Read	Limit	Over					
Freq	Level	Factor	Level	Line	Limit	Remark	Pol/Phase	
MHz	dBuV	dB/m	dBuV/m	dBuV/m	dB			
1 pp	4960.00	55.78	-4.22	51.56	54.00	-2.44	Average	VERTICAL
2 pk	4960.00	60.18	-4.22	55.96	74.00	-18.04	Peak	VERTICAL
3	7440.00	44.22	1.31	45.53	54.00	-8.47	Average	VERTICAL
4	7440.00	48.36	1.31	49.67	74.00	-24.33	Peak	VERTICAL

Test mode:	Transmitting	Test channel:	Highest
------------	--------------	---------------	---------

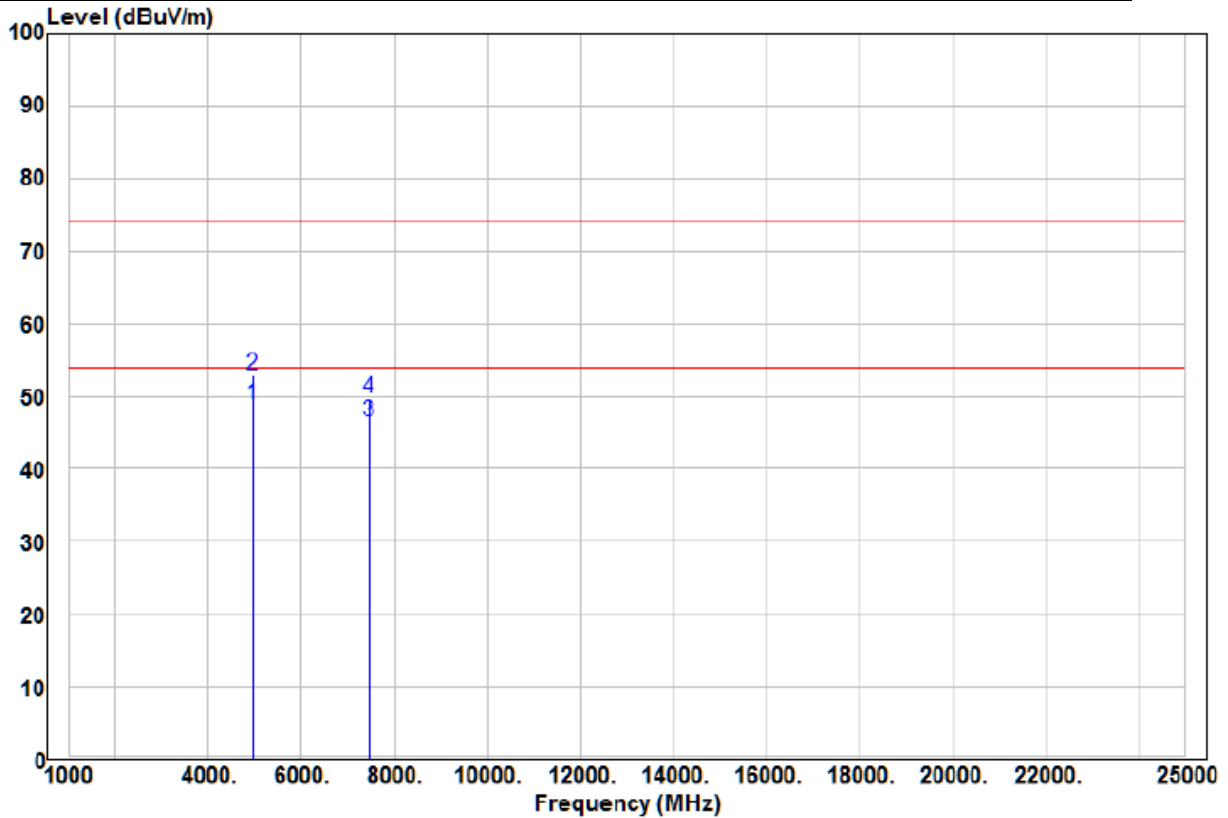

	Read		Limit	Over				
Freq	Level	Factor	Level	Line	Limit	Remark	Pol/Phase	
MHZ	dBuV	dB/m	dBuV/m	dBuV/m	dB			
1 pp	4960.00	53.10	-4.22	48.88	54.00	-5.12	Average	HORIZONTAL
2 pk	4960.00	57.16	-4.22	52.94	74.00	-21.06	Peak	HORIZONTAL
3	7440.00	45.25	1.31	46.56	54.00	-7.44	Average	HORIZONTAL
4	7440.00	48.37	1.31	49.68	74.00	-24.32	Peak	HORIZONTAL

Remark:

2) The field strength is calculated by adding the Antenna Factor, Cable Factor & Preamplifier. The basic equation with a sample calculation is as follows:

$$\text{Final Test Level} = \text{Receiver Reading} + \text{Antenna Factor} + \text{Cable Factor} - \text{Preamplifier Factor}$$

3) Scan from 9kHz to 25GHz, The disturbance above 13GHz and below 30MHz was very low, and the above harmonics were the highest point could be found when testing, so only the above harmonics had been displayed. The amplitude of spurious emissions from the radiator which are attenuated more than 20dB below the limit need not be reported.

6.10 Restricted bands around fundamental frequency

Test Requirement:	47 CFR Part 15C Section 15.209 and 15.205, RSS-Gen Issue 5		
Test Method:	ANSI C63.10 2013		
Test Site:	Measurement Distance: 3m (Semi-Anechoic Chamber)		
Limit:	Frequency	Limit (dBuV/m @3m)	Remark
	30MHz-88MHz	40.0	Quasi-peak Value
	88MHz-216MHz	43.5	Quasi-peak Value
	216MHz-960MHz	46.0	Quasi-peak Value
	Above 1GHz	54.0	Average Value
		74.0	Peak Value

Test Setup:

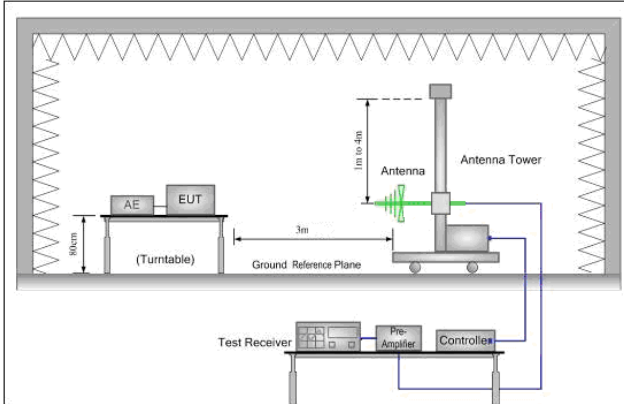

Figure 1. 30MHz to 1GHz

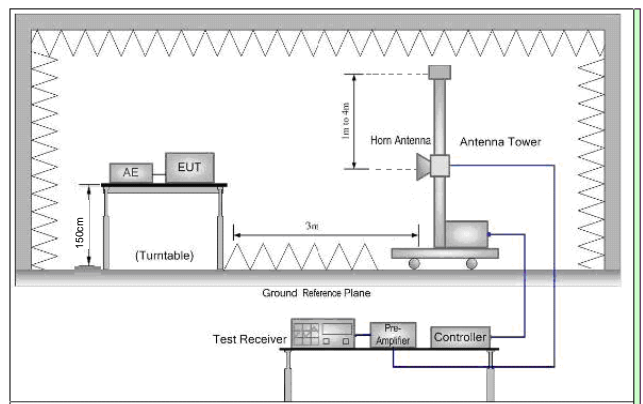

Figure 2. Above 1 GHz

Test Procedure:

- a. 1) Below 1G: The EUT was placed on the top of a rotating table 0.8 meters above the ground at a 3 meter semi-anechoic chamber. The table was rotated 360 degrees to determine the position of the highest radiation.
2) Above 1G: The EUT was placed on the top of a rotating table 1.5 meters above the ground at a 3 meter semi-anechoic chamber. The table was rotated 360 degrees to determine the position of the highest radiation.
Note: For the radiated emission test above 1GHz:
Place the measurement antenna away from each area of the EUT determined to be a source of emissions at the specified measurement distance, while keeping the measurement antenna aimed at the source of emissions at each frequency of significant emissions, with polarization oriented for maximum response. The measurement antenna may have to be higher or lower than the EUT, depending on the radiation pattern of the emission and staying aimed at the emission source for receiving the maximum signal. The final measurement antenna elevation shall be that which maximizes the emissions. The measurement antenna elevation for maximum emissions shall be restricted to a range of heights of from 1 m to 4 m above the ground or reference ground plane.
- b. The EUT was set 3 meters away from the interference-receiving antenna, which was mounted on the top of a variable-height antenna tower.
- c. The antenna height is varied from one meter to four meters above the ground to determine the maximum value of the field strength. Both horizontal and vertical polarizations of the antenna are set to make the

	<p>measurement.</p> <p>d. For each suspected emission, the EUT was arranged to its worst case and then the antenna was tuned to heights from 1 meter to 4 meters and the rotatable table was turned from 0 degrees to 360 degrees to find the maximum reading.</p> <p>e. The test-receiver system was set to Peak Detect Function and Specified Bandwidth with Maximum Hold Mode.</p> <p>f. Place a marker at the end of the restricted band closest to the transmit frequency to show compliance. Also measure any emissions in the restricted bands. Save the spectrum analyzer plot. Repeat for each power and modulation for lowest and highest channel</p> <p>g. Test the EUT in the lowest channel , the Highest channel</p> <p>h. Repeat above procedures until all frequencies measured was complete.</p>
Test Mode:	Transmitting with O-QPSK at lowest, middle and highest channel.
Test Results:	Pass

Test data:

Test mode:	Transmitting	Test channel:	Lowest
------------	--------------	---------------	--------

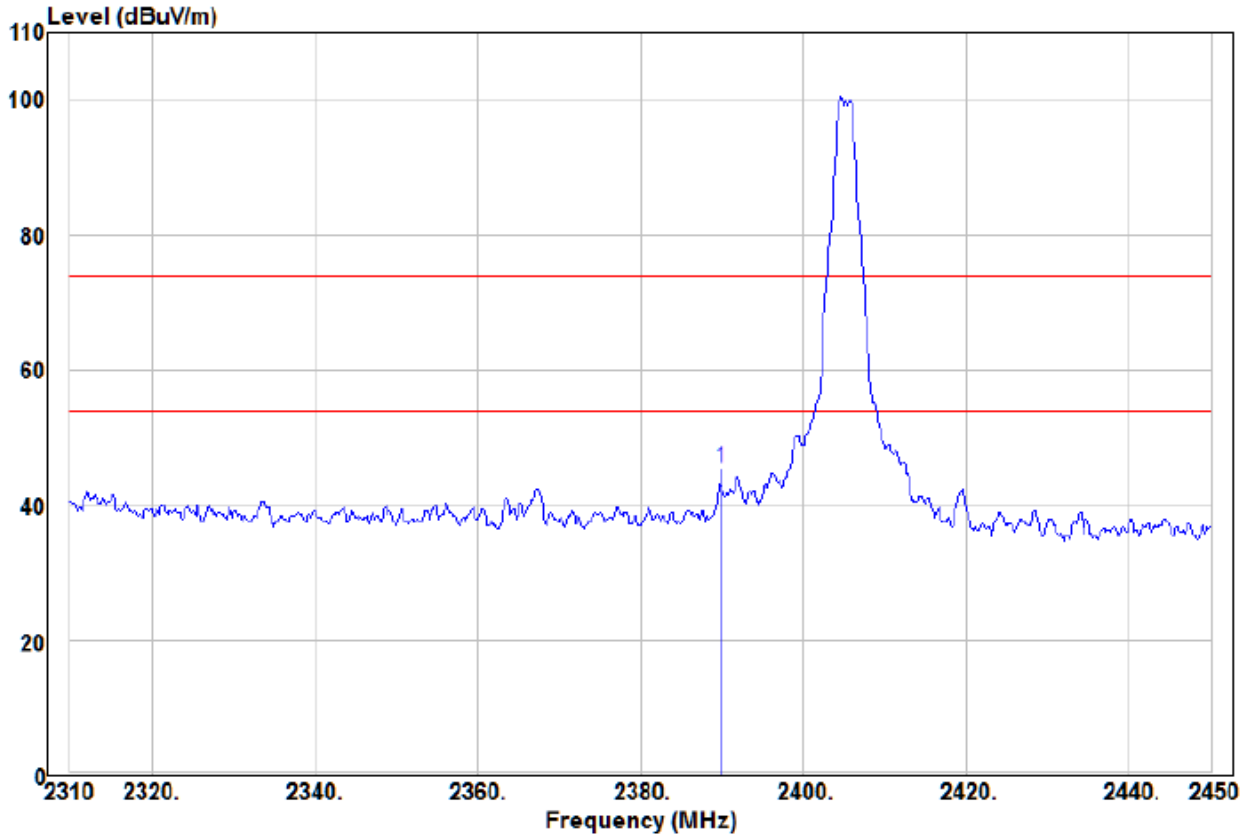

	Read		Limit	Over			
Freq	Level	Factor	Level	Line	Limit	Remark	Pol/Phase
MHz	dBuV	dB/m	dBuV/m	dBuV/m	dB		
1 pp 2390.00	55.80	-10.21	45.59	74.00	-28.41	Peak	VERTICAL

Test mode:	Transmitting	Test channel:	Lowest
------------	--------------	---------------	--------

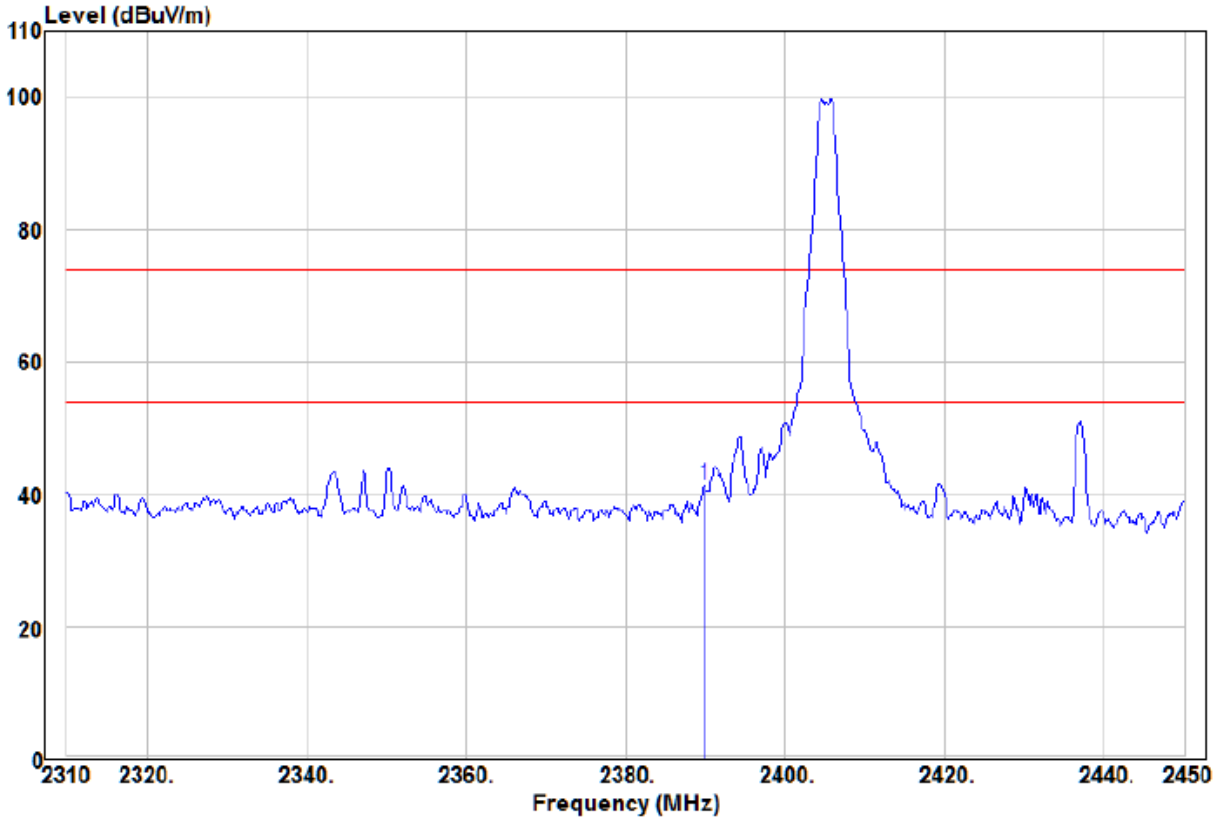

	Read		Limit	Over			
Freq	Level	Factor	Level	Line	Limit	Remark	Pol/Phase
MHz	dBuV	dB/m	dBuV/m	dBuV/m	dB		
1 pp 2390.00	51.62	-10.21	41.41	74.00	-32.59	Peak	HORIZONTAL

Test mode:	Transmitting	Test channel:	Highest
------------	--------------	---------------	---------

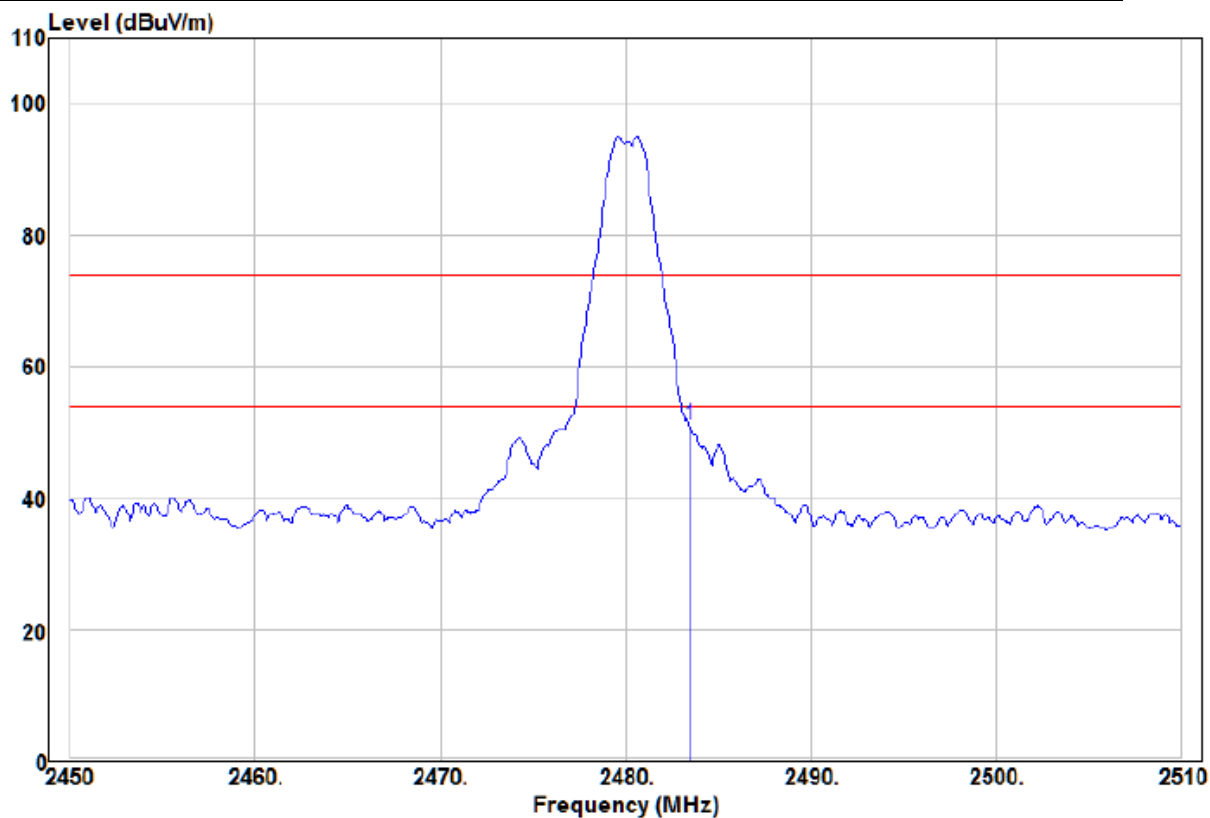

	Read		Limit	Over			
Freq	Level	Factor	Level	Line	Limit	Remark	Pol/Phase
MHz	dBuV	dB/m	dBuV/m	dBuV/m	dB		
1 pp 2483.50	62.44	-11.21	51.23	74.00	-22.77	Peak	VERTICAL

Test mode:	Transmitting	Test channel:	Highest
------------	--------------	---------------	---------

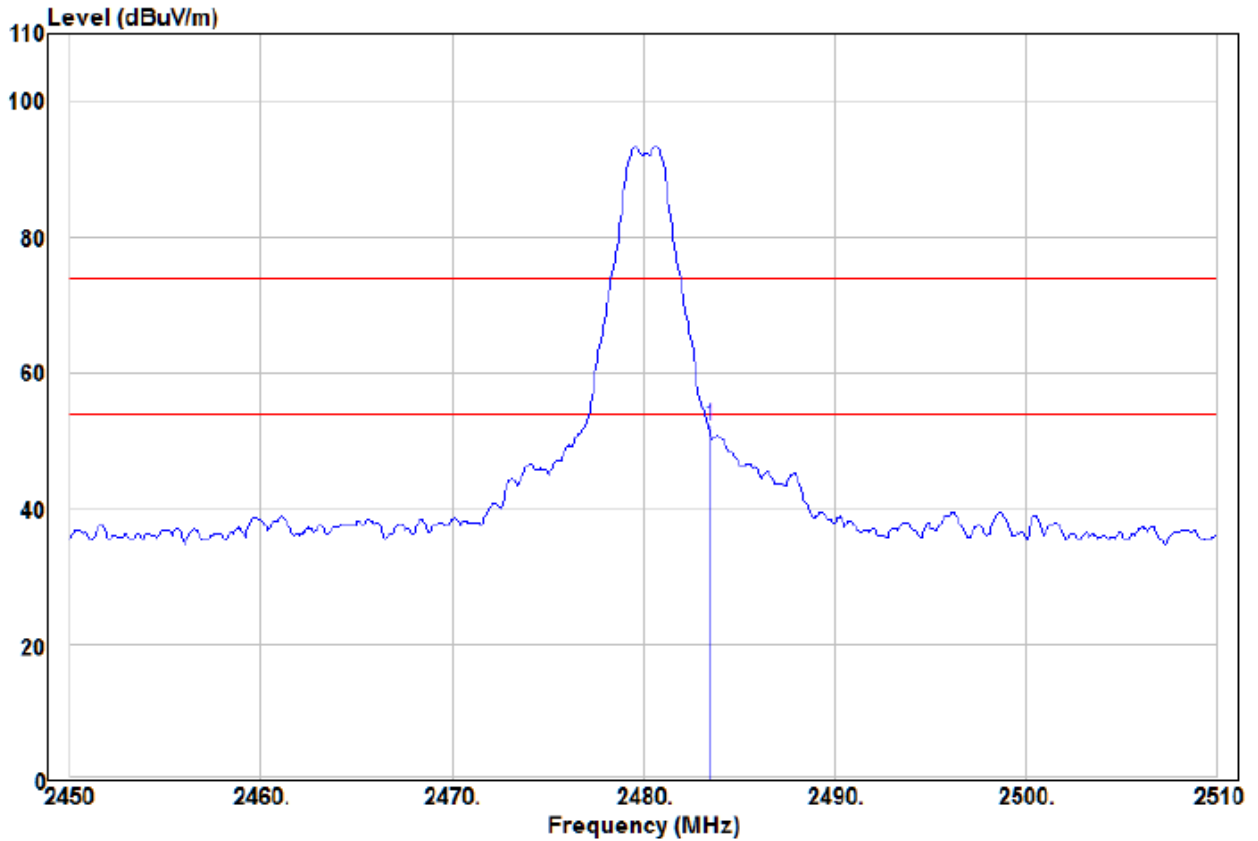

	Read		Limit	Over			
Freq	Level	Factor	Level	Line	Limit	Remark	Pol/Phase
MHz	dBuV	dB/m	dBuV/m	dBuV/m	dB		
1 pp	2483.50	63.59	-11.21	52.38	74.00	-21.62	Peak HORIZONTAL

Note:

The field strength is calculated by adding the Antenna Factor, Cable Factor & Preamplifier. The basic equation with a sample calculation is as follows:

$$\text{Final Test Level} = \text{Receiver Reading} + \text{Antenna Factor} + \text{Cable Factor} - \text{Preamplifier Factor}$$

THE END