

# APPENDIX C CALIBRATION CERTIFICATES



In Collaboration with  
**TTL Speag**  
 CALIBRATION LABORATORY  
 Add: No.52 HuaYuanBei Road, Haidian District, Beijing, 100191, China  
 Tel: +86-10-62304633-2117  
 E-mail: emf@caict.ac.cn http://www.caict.ac.cn



中国认可  
 国际互认  
**CAICT**  
 校准  
 CALIBRATION  
 CNAS L0570

Client

**CCICT**

Certificate No: **J23Z60226**

CALIBRATION CERTIFICATE			
Object	EX3DV4 - SN : 7522		
Calibration Procedure(s)	FF-Z11-004-02 Calibration Procedures for Dosimetric E-field Probes		
Calibration date:	May 29, 2023		
This calibration Certificate documents the traceability to national standards, which realize the physical units of measurements(SI). The measurements and the uncertainties with confidence probability are given on the following pages and are part of the certificate.			
All calibrations have been conducted in the closed laboratory facility: environment temperature(22±3)°C and humidity<70%.			
Calibration Equipment used (M&TE critical for calibration)			
Primary Standards	ID #	Cal Date(Calibrated by, Certificate No.)	Scheduled Calibration
Power Meter NRP2	101919	14-Jun-22(CTTL, No.J22X04181)	Jun-23
Power sensor NRP-Z91	101547	14-Jun-22(CTTL, No.J22X04181)	Jun-23
Power sensor NRP-Z91	101548	14-Jun-22(CTTL, No.J22X04181)	Jun-23
Reference 10dBAttenuator	18N50W-10dB	19-Jan-23(CTTL, No.J23X00212)	Jan-25
Reference 20dBAttenuator	18N50W-20dB	19-Jan-23(CTTL, No.J23X00211)	Jan-25
OCP DAK-3.5	SN 1040	18-Jan-23(SPEAG, No.OCP-DAK3.5-1040_Jan23)	Jan-24
Reference Probe EX3DV4	SN 7517	27-Jan-23(SPEAG, No.EX-7517_Jan23)	Jan-24
DAE4	SN 1555	25-Aug-22(SPEAG, No.DAE4-1555_Aug22)	Aug-23
Secondary Standards	ID #	Cal Date(Calibrated by, Certificate No.)	Scheduled Calibration
SignalGenerator MG3700A	6201052605	14-Jun-22(CTTL, No.J22X04182)	Jun-23
Network Analyzer E5071C	MY46110673	10-Jan-23(CTTL, No.J23X00104)	Jan-24
Reference 10dBAttenuator	BT0520	11-May-23(CTTL, No.J23X04061)	May-25
Reference 20dBAttenuator	BT0267	11-May-23(CTTL, No.J23X04062)	May-25
Calibrated by:	Name Yu Zongying	Function SAR Test Engineer	Signature 
Reviewed by:	Name Lin Hao	Function SAR Test Engineer	Signature 
Approved by:	Name Qi Dianyuan	Function SAR Project Leader	Signature 
Issued: June 04, 2023			
This calibration certificate shall not be reproduced except in full without written approval of the laboratory.			

**Glossary:**

TSL	tissue simulating liquid
NORM <sub>x,y,z</sub>	sensitivity in free space
ConvF	sensitivity in TSL / NORM <sub>x,y,z</sub>
DCP	diode compression point
CF	crest factor (1/duty_cycle) of the RF signal
A,B,C,D	modulation dependent linearization parameters
Polarization $\Phi$	$\Phi$ rotation around probe axis
Polarization $\theta$	$\theta$ rotation around an axis that is in the plane normal to probe axis (at measurement center), $\theta=0$ is normal to probe axis

Connector Angle information used in DASY system to align probe sensor X to the robot coordinate system

**Calibration is Performed According to the Following Standards:**

- a) IEEE Std 1528-2013, "IEEE Recommended Practice for Determining the Peak Spatial-Averaged Specific Absorption Rate (SAR) in the Human Head from Wireless Communications Devices: Measurement Techniques", June 2013
- b) IEC 62209-1, "Measurement procedure for the assessment of Specific Absorption Rate (SAR) from hand-held and body-mounted devices used next to the ear (frequency range of 300 MHz to 6 GHz)", July 2016
- c) IEC 62209-2, "Procedure to determine the Specific Absorption Rate (SAR) for wireless communication devices used in close proximity to the human body (frequency range of 30 MHz to 6 GHz)", March 2010
- d) KDB 865664, "SAR Measurement Requirements for 100 MHz to 6 GHz"

**Methods Applied and Interpretation of Parameters:**

- *NORM<sub>x,y,z</sub>*: Assessed for E-field polarization  $\theta=0$  ( $f \leq 900\text{MHz}$  in TEM-cell;  $f > 1800\text{MHz}$ : waveguide). *NORM<sub>x,y,z</sub>* are only intermediate values, i.e., the uncertainties of *NORM<sub>x,y,z</sub>* does not effect the  $E^2$ -field uncertainty inside TSL (see below ConvF).
- *NORM(f)<sub>x,y,z</sub> = NORM<sub>x,y,z</sub> \* frequency\_response* (see Frequency Response Chart). This linearization is implemented in DASY4 software versions later than 4.2. The uncertainty of the frequency response is included in the stated uncertainty of ConvF.
- *DCP<sub>x,y,z</sub>*: DCP are numerical linearization parameters assessed based on the data of power sweep (no uncertainty required). DCP does not depend on frequency nor media.
- PAR: PAR is the Peak to Average Ratio that is not calibrated but determined based on the signal characteristics.
- *A<sub>x,y,z</sub>; B<sub>x,y,z</sub>; C<sub>x,y,z</sub>; VR<sub>x,y,z</sub>; A,B,C* are numerical linearization parameters assessed based on the data of power sweep for specific modulation signal. The parameters do not depend on frequency nor media. VR is the maximum calibration range expressed in RMS voltage across the diode.
- *ConvF and Boundary Effect Parameters*: Assessed in flat phantom using E-field (or Temperature Transfer Standard for  $f \leq 800\text{MHz}$ ) and inside waveguide using analytical field distributions based on power measurements for  $f > 800\text{MHz}$ . The same setups are used for assessment of the parameters applied for boundary compensation (alpha, depth) of which typical uncertainty valued are given. These parameters are used in DASY4 software to improve probe accuracy close to the boundary. The sensitivity in TSL corresponds to *NORM<sub>x,y,z</sub> \* ConvF* whereby the uncertainty corresponds to that given for ConvF. A frequency dependent ConvF is used in DASY version 4.4 and higher which allows extending the validity from  $\pm 50\text{MHz}$  to  $\pm 100\text{MHz}$ .
- *Spherical isotropy (3D deviation from isotropy)*: in a field of low gradients realized using a flat phantom exposed by a patch antenna.
- *Sensor Offset*: The sensor offset corresponds to the offset of virtual measurement center from the probe tip (on probe axis). No tolerance required.
- *Connector Angle*: The angle is assessed using the information gained by determining the *NORM<sub>x</sub>* (no uncertainty required).

## DASY/EASY – Parameters of Probe: EX3DV4 – SN:7522

### Basic Calibration Parameters

	Sensor X	Sensor Y	Sensor Z	Unc ( $k=2$ )
Norm( $\mu V/(V/m)^2$ ) <sup>A</sup>	0.44	0.45	0.53	±10.0%
DCP(mV) <sup>B</sup>	99.4	98.3	99.1	

### Modulation Calibration Parameters

UID	Communication System Name		A dB	B dB $\sqrt{\mu V}$	C	D dB	VR mV	Unc <sup>E</sup> ( $k=2$ )
0	CW	X	0.0	0.0	1.0	0.00	156.8	±2.8%
		Y	0.0	0.0	1.0		158.4	
		Z	0.0	0.0	1.0		176.2	

The reported uncertainty of measurement is stated as the standard uncertainty of Measurement multiplied by the coverage factor  $k=2$ , which for a normal distribution Corresponds to a coverage probability of approximately 95%.

<sup>A</sup> The uncertainties of Norm X, Y, Z do not affect the E<sup>2</sup>-field uncertainty inside TSL (see Page 4).

<sup>B</sup> Numerical linearization parameter: uncertainty not required.

<sup>E</sup> Uncertainty is determined using the max. deviation from linear response applying rectangular distribution and is expressed for the square of the field value.

## DASY/EASY – Parameters of Probe: EX3DV4 – SN:7522

### Calibration Parameter Determined in Head Tissue Simulating Media

f [MHz] <sup>C</sup>	Relative Permittivity <sup>F</sup>	Conductivity (S/m) <sup>F</sup>	ConvF X	ConvF Y	ConvF Z	Alpha <sup>G</sup>	Depth <sup>G</sup> (mm)	Unct. (k=2)
750	41.9	0.89	9.90	9.90	9.90	0.11	1.85	± 12.7%
900	41.5	0.97	9.37	9.37	9.37	0.15	1.74	± 12.7%
1750	40.1	1.37	8.15	8.15	8.15	0.25	1.13	± 12.7%
1900	40.0	1.40	7.94	7.94	7.94	0.23	1.09	± 12.7%
2300	39.5	1.67	7.67	7.67	7.67	0.65	0.69	± 12.7%
2450	39.2	1.80	7.42	7.42	7.42	0.65	0.69	± 12.7%
2600	39.0	1.96	7.23	7.23	7.23	0.50	0.83	± 12.7%
5250	35.9	4.71	5.36	5.36	5.36	0.45	1.47	± 13.9%
5500	35.6	4.96	4.85	4.85	4.85	0.50	1.40	± 13.9%
5750	35.4	5.22	4.90	4.90	4.90	0.45	1.50	± 13.9%

<sup>C</sup> Frequency validity above 300 MHz of ±100MHz only applies for DASY v4.4 and higher (Page 2), else it is restricted to ±50MHz. The uncertainty is the RSS of ConvF uncertainty at calibration frequency and the uncertainty for the indicated frequency band. Frequency validity below 300 MHz is ± 10, 25, 40, 50 and 70 MHz for ConvF assessments at 30, 64, 128, 150 and 220 MHz respectively. Above 5 GHz frequency validity can be extended to ± 110 MHz.

<sup>F</sup> At frequency up to 6 GHz, the validity of tissue parameters ( $\epsilon$  and  $\sigma$ ) can be relaxed to ±10% if liquid compensation formula is applied to measured SAR values. The uncertainty is the RSS of the ConvF uncertainty for indicated target tissue parameters.

<sup>G</sup> Alpha/Depth are determined during calibration. SPEAG warrants that the remaining deviation due to the boundary effect after compensation is always less than ± 1% for frequencies below 3 GHz and below ± 2% for the frequencies between 3-6 GHz at any distance larger than half the probe tip diameter from the boundary.

## Frequency Response of E-Field (TEM-Cell: ifi110 EXX, Waveguide: R22)

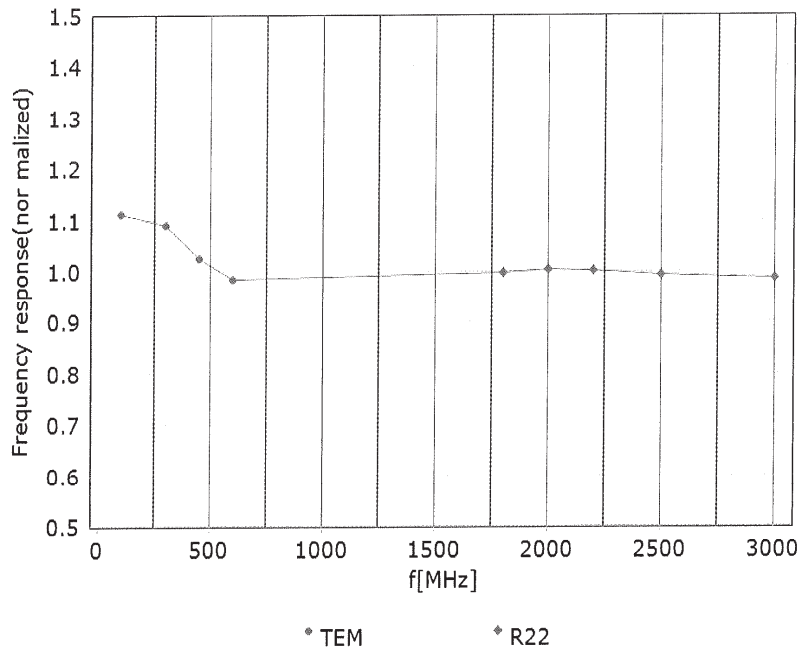

Uncertainty of Frequency Response of E-field:  $\pm 7.4\%$  ( $k=2$ )

Add: No.52 HuaYuanBei Road, Haidian District, Beijing, 100191, China  
 Tel: +86-10-62304633-2117  
 E-mail: emf@caict.ac.cn      http://www.caict.ac.cn

## Receiving Pattern ( $\Phi$ ), $\theta=0^\circ$

**f=600 MHz, TEM**

**f=1800 MHz, R22**

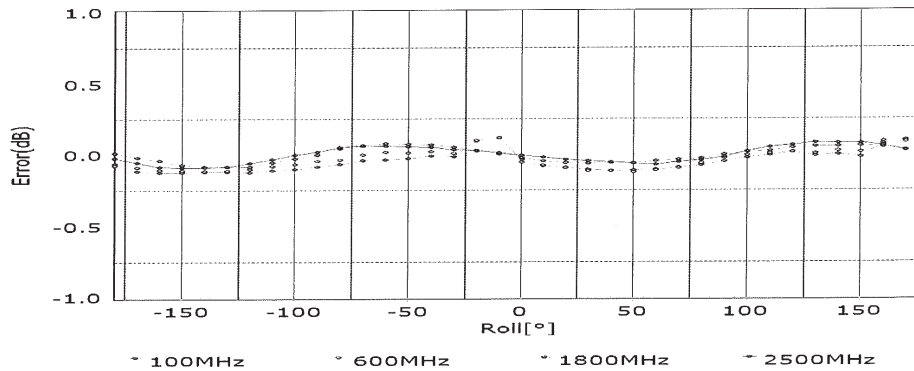
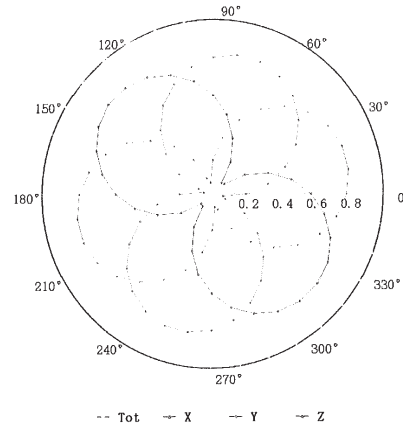
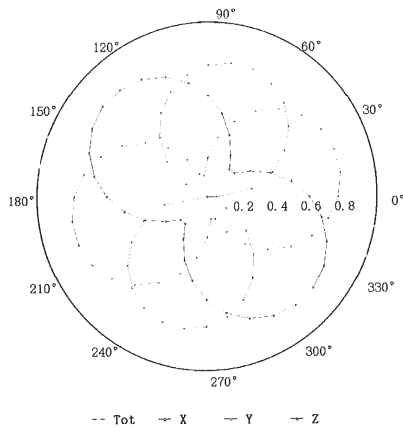

Uncertainty of Axial Isotropy Assessment:  $\pm 1.2\%$  ( $k=2$ )

Add: No.52 HuaYuanBei Road, Haidian District, Beijing, 100191, China  
 Tel: +86-10-62304633-2117  
 E-mail: emf@caict.ac.cn      http://www.caict.ac.cn

### Dynamic Range f(SAR<sub>head</sub>) (TEM cell, f = 900 MHz)

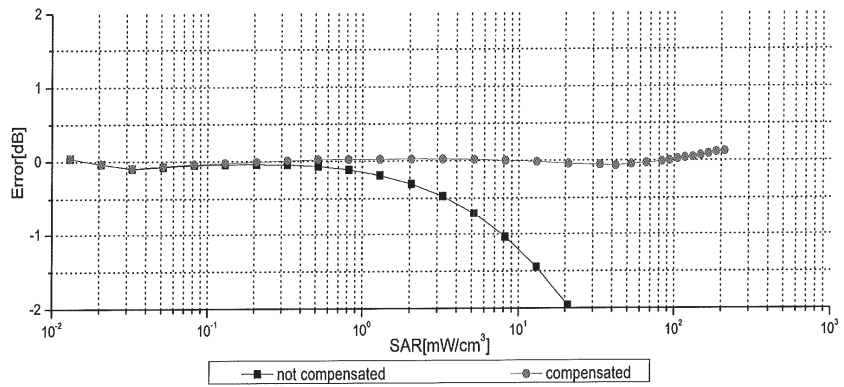
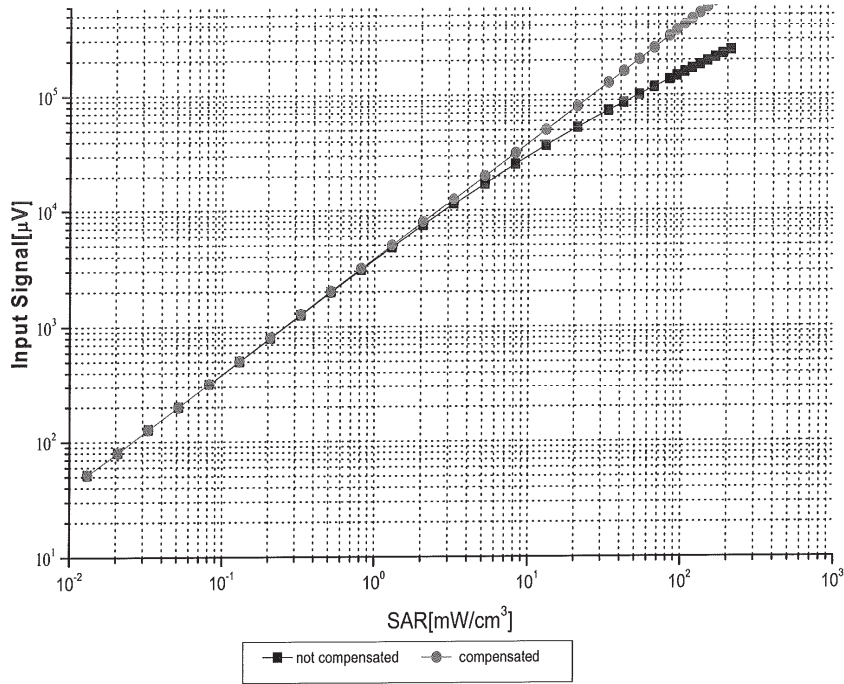

**Uncertainty of Linearity Assessment: ±0.9% (k=2)**

## Conversion Factor Assessment

f=750 MHz,WGLS R9(H\_convF)

f=1750 MHz,WGLS R22(H\_convF)

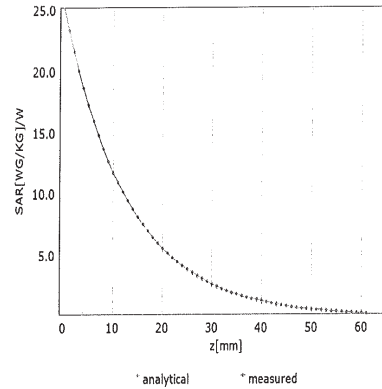
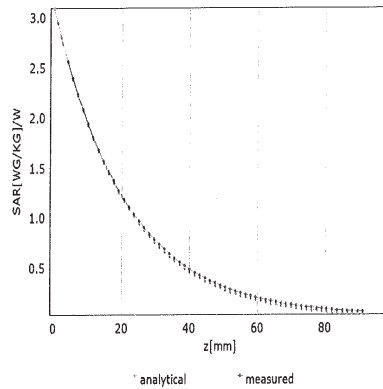

## Deviation from Isotropy in Liquid

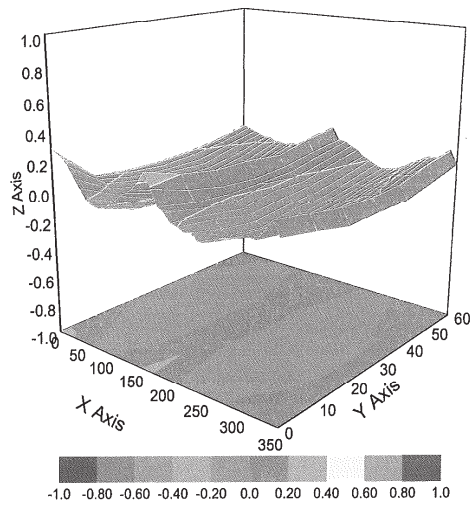

**Uncertainty of Spherical Isotropy Assessment:  $\pm 3.2\%$  ( $k=2$ )**



## DASY/EASY – Parameters of Probe: EX3DV4 – SN:7522

### Other Probe Parameters

Sensor Arrangement	Triangular
Connector Angle (°)	31.1
Mechanical Surface Detection Mode	enabled
Optical Surface Detection Mode	disable
Probe Overall Length	337mm
Probe Body Diameter	10mm
Tip Length	9mm
Tip Diameter	2.5mm
Probe Tip to Sensor X Calibration Point	1mm
Probe Tip to Sensor Y Calibration Point	1mm
Probe Tip to Sensor Z Calibration Point	1mm
Recommended Measurement Distance from Surface	1.4mm

# DIPOLE CALIBRATION CERTIFICATES

**Calibration Laboratory of  
Schmid & Partner  
Engineering AG**  
Zeughausstrasse 43, 8004 Zurich, Switzerland



**S  
C  
S** Schweizerischer Kalibrierdienst  
Service suisse d'étalonnage  
Servizio svizzero di taratura  
Swiss Calibration Service

Accredited by the Swiss Accreditation Service (SAS)  
The Swiss Accreditation Service is one of the signatories to the EA  
Multilateral Agreement for the recognition of calibration certificates

Accreditation No.: **SCS 0108**

Client **BACL USA**  
**Sunnyvale, USA**

Certificate No. **D750V3-1230\_Mar23**

## CALIBRATION CERTIFICATE

Object **D750V3 - SN:1230**

Calibration procedure(s) **QA CAL-05.v12  
Calibration Procedure for SAR Validation Sources between 0.7-3 GHz**

Calibration date: **March 24, 2023**

This calibration certificate documents the traceability to national standards, which realize the physical units of measurements (SI).  
The measurements and the uncertainties with confidence probability are given on the following pages and are part of the certificate.

All calibrations have been conducted in the closed laboratory facility: environment temperature (22 ± 3)°C and humidity < 70%.

Calibration Equipment used (M&TE critical for calibration)

Primary Standards	ID #	Cal Date (Certificate No.)	Scheduled Calibration
Power meter NRP	SN: 104778	04-Apr-22 (No. 217-03525/03524)	Apr-23
Power sensor NRP-Z91	SN: 103244	04-Apr-22 (No. 217-03524)	Apr-23
Power sensor NRP-Z91	SN: 103245	04-Apr-22 (No. 217-03525)	Apr-23
Reference 20 dB Attenuator	SN: BH9394 (20k)	04-Apr-22 (No. 217-03527)	Apr-23
Type-N mismatch combination	SN: 310982 / 06327	04-Apr-22 (No. 217-03528)	Apr-23
Reference Probe EX3DV4	SN: 7349	10-Jan-23 (No. EX3-7349_Jan23)	Jan-24
DAE4	SN: 601	19-Dec-22 (No. DAE4-601_Dec22)	Dec-23
Secondary Standards	ID #	Check Date (in house)	Scheduled Check
Power meter E4419B	SN: GB39512475	30-Oct-14 (in house check Oct-22)	In house check: Oct-24
Power sensor HP 8481A	SN: US37292783	07-Oct-15 (in house check Oct-22)	In house check: Oct-24
Power sensor HP 8481A	SN: MY41093315	07-Oct-15 (in house check Oct-22)	In house check: Oct-24
RF generator R&S SMT-06	SN: 100972	15-Jun-15 (in house check Oct-22)	In house check: Oct-24
Network Analyzer Agilent E8358A	SN: US41080477	31-Mar-14 (in house check Oct-22)	In house check: Oct-24

Calibrated by: **Name** Michael Weber **Function** Laboratory Technician

Approved by: **Name** Sven Kühn **Function** Technical Manager

Signature

Issued: March 24, 2023

This calibration certificate shall not be reproduced except in full without written approval of the laboratory.



Accredited by the Swiss Accreditation Service (SAS)

The Swiss Accreditation Service is one of the signatories to the EA  
Multilateral Agreement for the recognition of calibration certificates

Accreditation No.: **SCS 0108**

### Glossary:

TSL	tissue simulating liquid
ConvF	sensitivity in TSL / NORM x,y,z
N/A	not applicable or not measured

### Calibration is Performed According to the Following Standards:

- IEC/IEEE 62209-1528, "Measurement Procedure For The Assessment Of Specific Absorption Rate Of Human Exposure To Radio Frequency Fields From Hand-Held And Body-Worn Wireless Communication Devices - Part 1528: Human Models, Instrumentation And Procedures (Frequency Range of 4 MHz to 10 GHz)", October 2020.
- KDB 865664, "SAR Measurement Requirements for 100 MHz to 6 GHz"

### Additional Documentation:

- DASY System Handbook

### Methods Applied and Interpretation of Parameters:

- Measurement Conditions:* Further details are available from the Validation Report at the end of the certificate. All figures stated in the certificate are valid at the frequency indicated.
- Antenna Parameters with TSL:* The source is mounted in a touch configuration below the center marking of the flat phantom.
- Return Loss:* This parameter is measured with the source positioned under the liquid filled phantom (as described in the measurement condition clause). The Return Loss ensures low reflected power. No uncertainty required.
- SAR measured:* SAR measured at the stated antenna input power.
- SAR normalized:* SAR as measured, normalized to an input power of 1 W at the antenna connector.
- SAR for nominal TSL parameters:* The measured TSL parameters are used to calculate the nominal SAR result.

The reported uncertainty of measurement is stated as the standard uncertainty of measurement multiplied by the coverage factor  $k=2$ , which for a normal distribution corresponds to a coverage probability of approximately 95%.

## Measurement Conditions

DASY system configuration, as far as not given on page 1.

DASY Version	DASY52	V52.10.4
Extrapolation	Advanced Extrapolation	
Phantom	Modular Flat Phantom	
Distance Dipole Center - TSL	15 mm	with Spacer
Zoom Scan Resolution	dx, dy, dz = 5 mm	
Frequency	750 MHz $\pm$ 1 MHz	

## Head TSL parameters

The following parameters and calculations were applied.

	Temperature	Permittivity	Conductivity
Nominal Head TSL parameters	22.0 °C	41.9	0.89 mho/m
Measured Head TSL parameters	(22.0 $\pm$ 0.2) °C	41.0 $\pm$ 6 %	0.90 mho/m $\pm$ 6 %
Head TSL temperature change during test	< 0.5 °C	----	----

## SAR result with Head TSL

SAR averaged over 1 cm <sup>3</sup> (1 g) of Head TSL	Condition	
SAR measured	250 mW input power	2.15 W/kg
SAR for nominal Head TSL parameters	normalized to 1W	<b>8.49 W/kg <math>\pm</math> 17.0 % (k=2)</b>

SAR averaged over 10 cm <sup>3</sup> (10 g) of Head TSL	condition	
SAR measured	250 mW input power	1.40 W/kg
SAR for nominal Head TSL parameters	normalized to 1W	<b>5.54 W/kg <math>\pm</math> 16.5 % (k=2)</b>

## Appendix (Additional assessments outside the scope of SCS 0108)

### Antenna Parameters with Head TSL

Impedance, transformed to feed point	53.0 $\Omega$ + 0.9 j $\Omega$
Return Loss	- 30.3 dB

### General Antenna Parameters and Design

Electrical Delay (one direction)	1.037 ns
----------------------------------	----------

After long term use with 100W radiated power, only a slight warming of the dipole near the feedpoint can be measured.

The dipole is made of standard semirigid coaxial cable. The center conductor of the feeding line is directly connected to the second arm of the dipole. The antenna is therefore short-circuited for DC-signals. On some of the dipoles, small end caps are added to the dipole arms in order to improve matching when loaded according to the position as explained in the "Measurement Conditions" paragraph. The SAR data are not affected by this change. The overall dipole length is still according to the Standard.

No excessive force must be applied to the dipole arms, because they might bend or the soldered connections near the feedpoint may be damaged.

### Additional EUT Data

Manufactured by	SPEAG
-----------------	-------

## DASY5 Validation Report for Head TSL

Date: 24.03.2023

Test Laboratory: SPEAG, Zurich, Switzerland

**DUT: Dipole 750 MHz; Type: D750V3; Serial: D750V3 - SN:1230**

Communication System: UID 0 - CW; Frequency: 750 MHz

Medium parameters used:  $f = 750$  MHz;  $\sigma = 0.9$  S/m;  $\epsilon_r = 41$ ;  $\rho = 1000$  kg/m<sup>3</sup>

Phantom section: Flat Section

Measurement Standard: DASY5 (IEEE/IEC/ANSI C63.19-2011)

DASY52 Configuration:

- Probe: EX3DV4 - SN7349; ConvF(10.11, 10.11, 10.11) @ 750 MHz; Calibrated: 10.01.2023
- Sensor-Surface: 1.4mm (Mechanical Surface Detection)
- Electronics: DAE4 Sn601; Calibrated: 19.12.2022
- Phantom: Flat Phantom 4.9 (front); Type: QD 00L P49 AA; Serial: 1001
- DASY52 52.10.4(1535); SEMCAD X 14.6.14(7501)

### Dipole Calibration for Head Tissue/Pin=250 mW, d=15mm/Zoom Scan (7x7x7)/Cube 0:

Measurement grid: dx=5mm, dy=5mm, dz=5mm

Reference Value = 60.71 V/m; Power Drift = -0.03 dB

Peak SAR (extrapolated) = 3.26 W/kg

**SAR(1 g) = 2.15 W/kg; SAR(10 g) = 1.4 W/kg**

Smallest distance from peaks to all points 3 dB below = 21.2 mm

Ratio of SAR at M2 to SAR at M1 = 65.7%

Maximum value of SAR (measured) = 2.90 W/kg

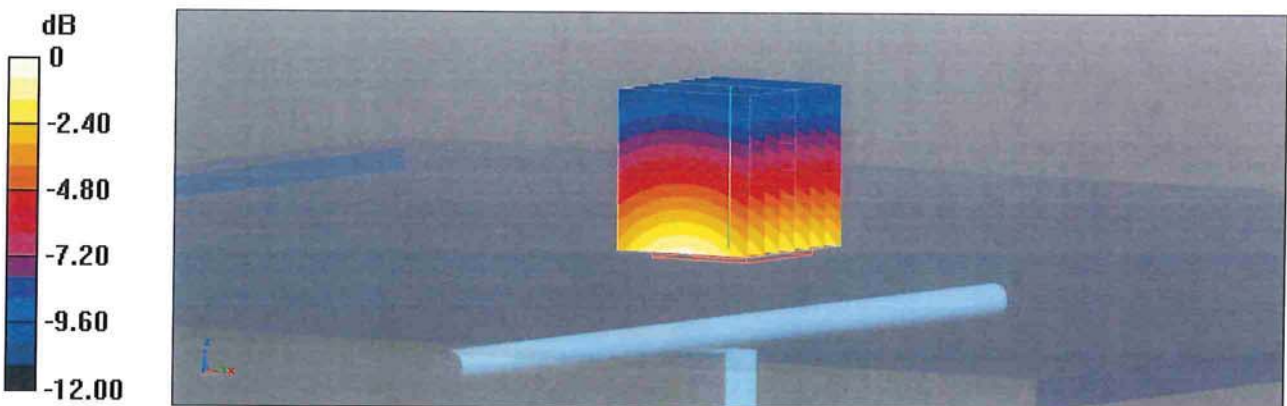

0 dB = 2.90 W/kg = 4.62 dBW/kg

# Impedance Measurement Plot for Head TSL

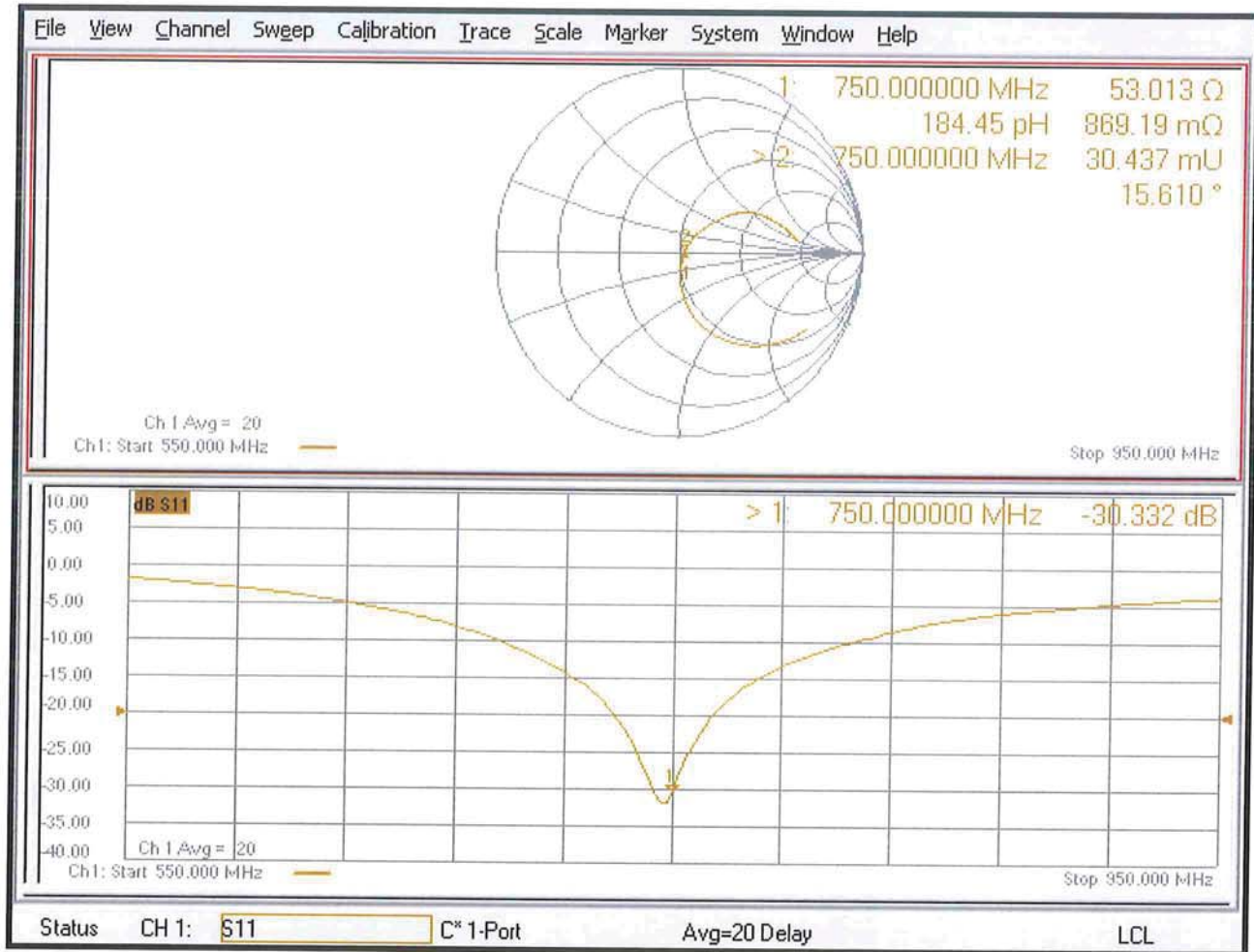



Accredited by the Swiss Accreditation Service (SAS)  
The Swiss Accreditation Service is one of the signatories to the EA  
Multilateral Agreement for the recognition of calibration certificates

Client **BACL**  
**Sunnyvale USA**

Certificate No. **D1750V2-1200\_Mar23**

## CALIBRATION CERTIFICATE

Object **D1750V2 - SN:1200**

Calibration procedure(s) **QA CAL-05.v12  
Calibration Procedure for SAR Validation Sources between 0.7-3 GHz**

Calibration date: **March 27, 2023**

This calibration certificate documents the traceability to national standards, which realize the physical units of measurements (SI).  
The measurements and the uncertainties with confidence probability are given on the following pages and are part of the certificate.

All calibrations have been conducted in the closed laboratory facility: environment temperature (22 ± 3)°C and humidity < 70%.

**Calibration Equipment used (M&TE critical for calibration)**

Primary Standards	ID #	Cal Date (Certificate No.)	Scheduled Calibration
Power meter NRP	SN: 104778	04-Apr-22 (No. 217-03525/03524)	Apr-23
Power sensor NRP-Z91	SN: 103244	04-Apr-22 (No. 217-03524)	Apr-23
Power sensor NRP-Z91	SN: 103245	04-Apr-22 (No. 217-03525)	Apr-23
Reference 20 dB Attenuator	SN: BH9394 (20k)	04-Apr-22 (No. 217-03527)	Apr-23
Type-N mismatch combination	SN: 310982 / 06327	04-Apr-22 (No. 217-03528)	Apr-23
Reference Probe EX3DV4	SN: 7349	10-Jan-23 (No. EX3-7349_Jan23)	Jan-24
DAE4	SN: 601	19-Dec-22 (No. DAE4-601_Dec22)	Dec-23

Secondary Standards	ID #	Check Date (in house)	Scheduled Check
Power meter E4419B	SN: GB39512475	30-Oct-14 (in house check Oct-22)	In house check: Oct-24
Power sensor HP 8481A	SN: US37292783	07-Oct-15 (in house check Oct-22)	In house check: Oct-24
Power sensor HP 8481A	SN: MY41093315	07-Oct-15 (in house check Oct-22)	In house check: Oct-24
RF generator R&S SMT-06	SN: 100972	15-Jun-15 (in house check Oct-22)	In house check: Oct-24
Network Analyzer Agilent E8358A	SN: US41080477	31-Mar-14 (in house check Oct-22)	In house check: Oct-24

Calibrated by:	Name <b>Paulo Pina</b>	Function <b>Laboratory Technician</b>	Signature 
Approved by:	<b>Sven Kühn</b>	<b>Technical Manager</b>	

Issued: March 27, 2023

This calibration certificate shall not be reproduced except in full without written approval of the laboratory.





Accredited by the Swiss Accreditation Service (SAS)

The Swiss Accreditation Service is one of the signatories to the EA  
Multilateral Agreement for the recognition of calibration certificates

**Glossary:**

TSL	tissue simulating liquid
ConvF	sensitivity in TSL / NORM x,y,z
N/A	not applicable or not measured

**Calibration is Performed According to the Following Standards:**

- a) IEC/IEEE 62209-1528, "Measurement Procedure For The Assessment Of Specific Absorption Rate Of Human Exposure To Radio Frequency Fields From Hand-Held And Body-Worn Wireless Communication Devices - Part 1528: Human Models, Instrumentation And Procedures (Frequency Range of 4 MHz to 10 GHz)", October 2020.
- b) KDB 865664, "SAR Measurement Requirements for 100 MHz to 6 GHz"

**Additional Documentation:**

- c) DASY System Handbook

**Methods Applied and Interpretation of Parameters:**

- *Measurement Conditions:* Further details are available from the Validation Report at the end of the certificate. All figures stated in the certificate are valid at the frequency indicated.
- *Antenna Parameters with TSL:* The source is mounted in a touch configuration below the center marking of the flat phantom.
- *Return Loss:* This parameter is measured with the source positioned under the liquid filled phantom (as described in the measurement condition clause). The Return Loss ensures low reflected power. No uncertainty required.
- *SAR measured:* SAR measured at the stated antenna input power.
- *SAR normalized:* SAR as measured, normalized to an input power of 1 W at the antenna connector.
- *SAR for nominal TSL parameters:* The measured TSL parameters are used to calculate the nominal SAR result.

The reported uncertainty of measurement is stated as the standard uncertainty of measurement multiplied by the coverage factor  $k=2$ , which for a normal distribution corresponds to a coverage probability of approximately 95%.

## Measurement Conditions

DASY system configuration, as far as not given on page 1.

<b>DASY Version</b>	DASY52	V52.10.4
<b>Extrapolation</b>	Advanced Extrapolation	
<b>Phantom</b>	Modular Flat Phantom	
<b>Distance Dipole Center - TSL</b>	10 mm	with Spacer
<b>Zoom Scan Resolution</b>	dx, dy, dz = 5 mm	
<b>Frequency</b>	1750 MHz $\pm$ 1 MHz	

## Head TSL parameters

The following parameters and calculations were applied.

	Temperature	Permittivity	Conductivity
<b>Nominal Head TSL parameters</b>	22.0 °C	40.1	1.37 mho/m
<b>Measured Head TSL parameters</b>	(22.0 $\pm$ 0.2) °C	38.8 $\pm$ 6 %	1.33 mho/m $\pm$ 6 %
<b>Head TSL temperature change during test</b>	< 0.5 °C	----	----

## SAR result with Head TSL

<b>SAR averaged over 1 cm<sup>3</sup> (1 g) of Head TSL</b>	Condition	
SAR measured	250 mW input power	8.85 W/kg
SAR for nominal Head TSL parameters	normalized to 1W	<b>35.8 W/kg <math>\pm</math> 17.0 % (k=2)</b>

<b>SAR averaged over 10 cm<sup>3</sup> (10 g) of Head TSL</b>	condition	
SAR measured	250 mW input power	4.67 W/kg
SAR for nominal Head TSL parameters	normalized to 1W	<b>18.8 W/kg <math>\pm</math> 16.5 % (k=2)</b>

## Appendix (Additional assessments outside the scope of SCS 0108)

### Antenna Parameters with Head TSL

Impedance, transformed to feed point	46.9 $\Omega$ + 3.1 j $\Omega$
Return Loss	- 27.0 dB

### General Antenna Parameters and Design

Electrical Delay (one direction)	1.209 ns
----------------------------------	----------

After long term use with 100W radiated power, only a slight warming of the dipole near the feedpoint can be measured.

The dipole is made of standard semirigid coaxial cable. The center conductor of the feeding line is directly connected to the second arm of the dipole. The antenna is therefore short-circuited for DC-signals. On some of the dipoles, small end caps are added to the dipole arms in order to improve matching when loaded according to the position as explained in the "Measurement Conditions" paragraph. The SAR data are not affected by this change. The overall dipole length is still according to the Standard.

No excessive force must be applied to the dipole arms, because they might bend or the soldered connections near the feedpoint may be damaged.

### Additional EUT Data

Manufactured by	SPEAG
-----------------	-------

## DASY5 Validation Report for Head TSL

Date: 27.03.2023

Test Laboratory: SPEAG, Zurich, Switzerland

**DUT: Dipole 1750 MHz; Type: D1750V2; Serial: D1750V2 - SN:1200**

Communication System: UID 0 - CW; Frequency: 1750 MHz

Medium parameters used:  $f = 1750$  MHz;  $\sigma = 1.33$  S/m;  $\epsilon_r = 38.8$ ;  $\rho = 1000$  kg/m<sup>3</sup>

Phantom section: Flat Section

Measurement Standard: DASY5 (IEEE/IEC/ANSI C63.19-2011)

DASY52 Configuration:

- Probe: EX3DV4 - SN7349; ConvF(8.67, 8.67, 8.67) @ 1750 MHz; Calibrated: 10.01.2023
- Sensor-Surface: 1.4mm (Mechanical Surface Detection)
- Electronics: DAE4 Sn601; Calibrated: 19.12.2022
- Phantom: Flat Phantom 5.0 (front); Type: QD 000 P50 AA; Serial: 1001
- DASY52 52.10.4(1535); SEMCAD X 14.6.14(7501)

### Dipole Calibration for Head Tissue/Pin=250 mW, d=10mm/Zoom Scan (7x7x7)/Cube 0:

Measurement grid: dx=5mm, dy=5mm, dz=5mm

Reference Value = 104.6 V/m; Power Drift = 0.01 dB

Peak SAR (extrapolated) = 16.3 W/kg

**SAR(1 g) = 8.85 W/kg; SAR(10 g) = 4.67 W/kg**

Smallest distance from peaks to all points 3 dB below = 10.4 mm

Ratio of SAR at M2 to SAR at M1 = 54.4%

Maximum value of SAR (measured) = 13.7 W/kg

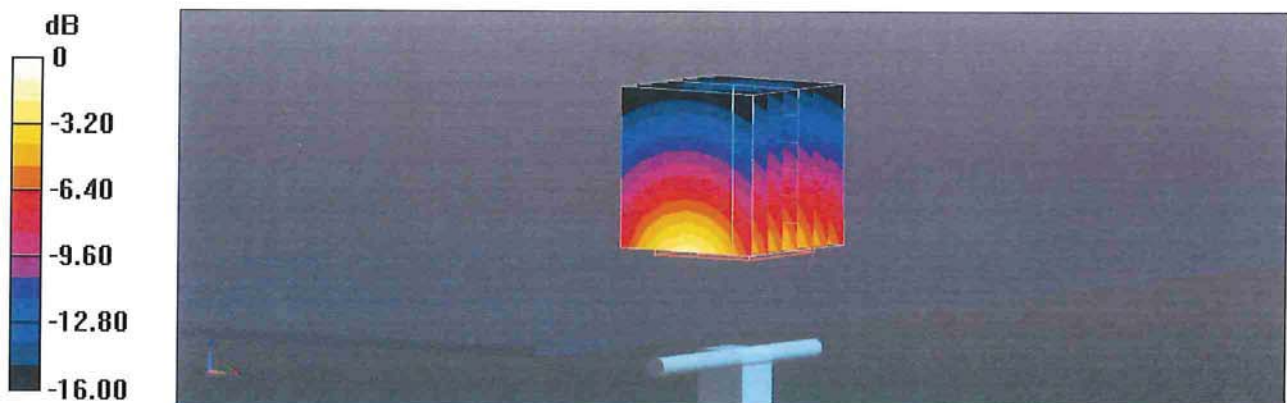

# Impedance Measurement Plot for Head TSL

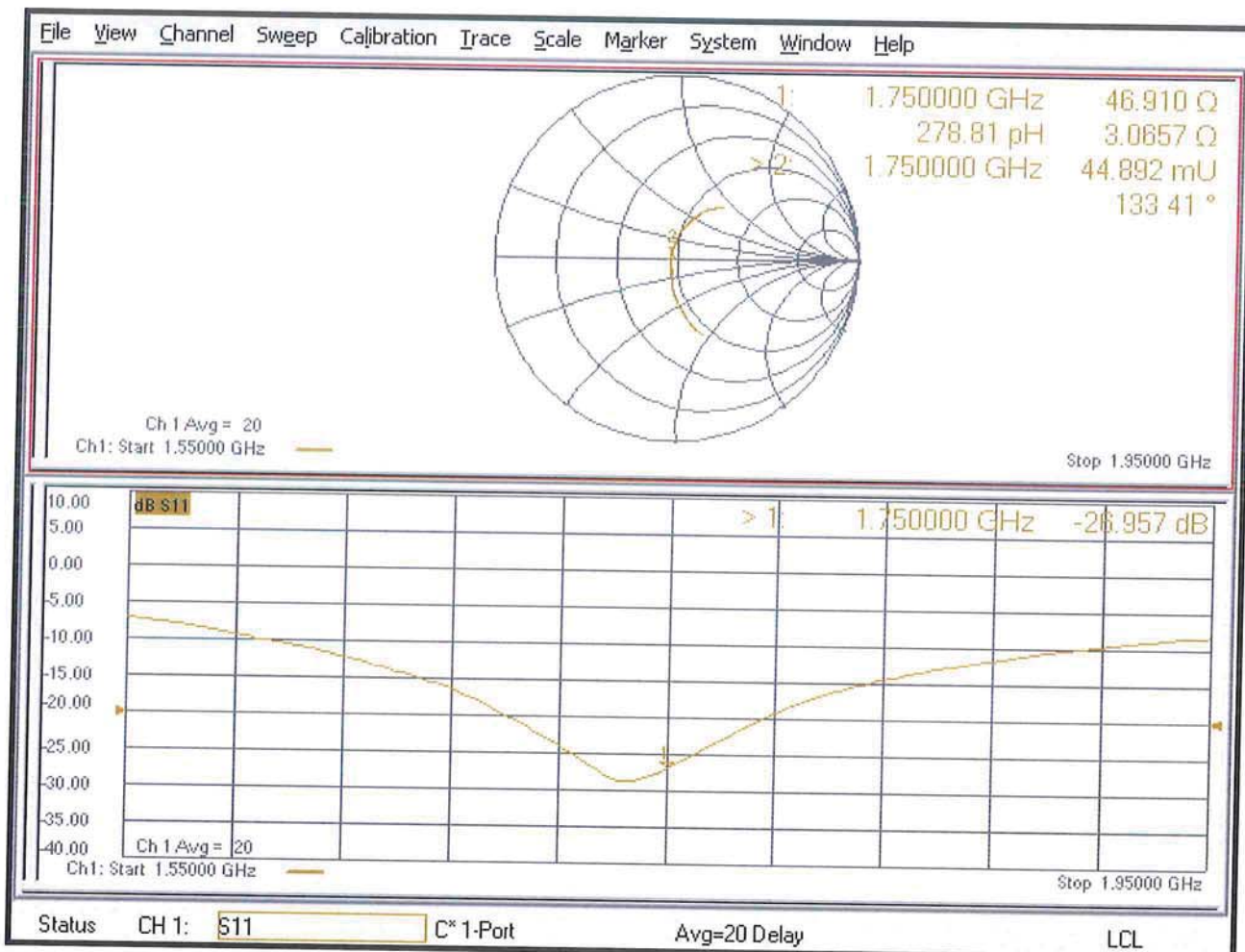



Accredited by the Swiss Accreditation Service (SAS)  
The Swiss Accreditation Service is one of the signatories to the EA  
Multilateral Agreement for the recognition of calibration certificates

Client **BACL**  
**Sunnyvale, USA**

Certificate No. **D1900V2-5d251\_Mar23**

## CALIBRATION CERTIFICATE

Object **D1900V2 - SN:5d251**

Calibration procedure(s) **QA CAL-05.v12  
Calibration Procedure for SAR Validation Sources between 0.7-3 GHz**

Calibration date: **March 27, 2023**

This calibration certificate documents the traceability to national standards, which realize the physical units of measurements (SI).  
The measurements and the uncertainties with confidence probability are given on the following pages and are part of the certificate.

All calibrations have been conducted in the closed laboratory facility: environment temperature (22 ± 3)°C and humidity < 70%.

Calibration Equipment used (M&TE critical for calibration)

Primary Standards	ID #	Cal Date (Certificate No.)	Scheduled Calibration
Power meter NRP	SN: 104778	04-Apr-22 (No. 217-03525/03524)	Apr-23
Power sensor NRP-Z91	SN: 103244	04-Apr-22 (No. 217-03524)	Apr-23
Power sensor NRP-Z91	SN: 103245	04-Apr-22 (No. 217-03525)	Apr-23
Reference 20 dB Attenuator	SN: BH9394 (20k)	04-Apr-22 (No. 217-03527)	Apr-23
Type-N mismatch combination	SN: 310982 / 06327	04-Apr-22 (No. 217-03528)	Apr-23
Reference Probe EX3DV4	SN: 7349	10-Jan-23 (No. EX3-7349_Jan23)	Jan-24
DAE4	SN: 601	19-Dec-22 (No. DAE4-601_Dec22)	Dec-23

Secondary Standards	ID #	Check Date (in house)	Scheduled Check
Power meter E4419B	SN: GB39512475	30-Oct-14 (in house check Oct-22)	In house check: Oct-24
Power sensor HP 8481A	SN: US37292783	07-Oct-15 (in house check Oct-22)	In house check: Oct-24
Power sensor HP 8481A	SN: MY41093315	07-Oct-15 (in house check Oct-22)	In house check: Oct-24
RF generator R&S SMT-06	SN: 100972	15-Jun-15 (in house check Oct-22)	In house check: Oct-24
Network Analyzer Agilent E8358A	SN: US41080477	31-Mar-14 (in house check Oct-22)	In house check: Oct-24

Calibrated by:	Name <b>Jeton Kastrati</b>	Function <b>Laboratory Technician</b>	Signature 
Approved by:	Name <b>Sven Kühn</b>	Function <b>Technical Manager</b>	Signature 

Issued: March 27, 2023

This calibration certificate shall not be reproduced except in full without written approval of the laboratory.



Accredited by the Swiss Accreditation Service (SAS)

The Swiss Accreditation Service is one of the signatories to the EA  
Multilateral Agreement for the recognition of calibration certificates

### Glossary:

TSL	tissue simulating liquid
ConvF	sensitivity in TSL / NORM x,y,z
N/A	not applicable or not measured

### Calibration is Performed According to the Following Standards:

- IEC/IEEE 62209-1528, "Measurement Procedure For The Assessment Of Specific Absorption Rate Of Human Exposure To Radio Frequency Fields From Hand-Held And Body-Worn Wireless Communication Devices - Part 1528: Human Models, Instrumentation And Procedures (Frequency Range of 4 MHz to 10 GHz)", October 2020.
- KDB 865664, "SAR Measurement Requirements for 100 MHz to 6 GHz"

### Additional Documentation:

- DASY System Handbook

### Methods Applied and Interpretation of Parameters:

- Measurement Conditions:* Further details are available from the Validation Report at the end of the certificate. All figures stated in the certificate are valid at the frequency indicated.
- Antenna Parameters with TSL:* The source is mounted in a touch configuration below the center marking of the flat phantom.
- Return Loss:* This parameter is measured with the source positioned under the liquid filled phantom (as described in the measurement condition clause). The Return Loss ensures low reflected power. No uncertainty required.
- SAR measured:* SAR measured at the stated antenna input power.
- SAR normalized:* SAR as measured, normalized to an input power of 1 W at the antenna connector.
- SAR for nominal TSL parameters:* The measured TSL parameters are used to calculate the nominal SAR result.

The reported uncertainty of measurement is stated as the standard uncertainty of measurement multiplied by the coverage factor  $k=2$ , which for a normal distribution corresponds to a coverage probability of approximately 95%.

## Measurement Conditions

DASY system configuration, as far as not given on page 1.

<b>DASY Version</b>	DASY52	V52.10.4
<b>Extrapolation</b>	Advanced Extrapolation	
<b>Phantom</b>	Modular Flat Phantom	
<b>Distance Dipole Center - TSL</b>	10 mm	with Spacer
<b>Zoom Scan Resolution</b>	dx, dy, dz = 5 mm	
<b>Frequency</b>	1900 MHz $\pm$ 1 MHz	

## Head TSL parameters

The following parameters and calculations were applied.

	Temperature	Permittivity	Conductivity
<b>Nominal Head TSL parameters</b>	22.0 °C	40.0	1.40 mho/m
<b>Measured Head TSL parameters</b>	(22.0 $\pm$ 0.2) °C	39.0 $\pm$ 6 %	1.36 mho/m $\pm$ 6 %
<b>Head TSL temperature change during test</b>	< 0.5 °C	----	----

## SAR result with Head TSL

<b>SAR averaged over 1 cm<sup>3</sup> (1 g) of Head TSL</b>	Condition	
SAR measured	250 mW input power	9.61 W/kg
SAR for nominal Head TSL parameters	normalized to 1W	<b>38.9 W/kg <math>\pm</math> 17.0 % (k=2)</b>

<b>SAR averaged over 10 cm<sup>3</sup> (10 g) of Head TSL</b>	condition	
SAR measured	250 mW input power	5.04 W/kg
SAR for nominal Head TSL parameters	normalized to 1W	<b>20.3 W/kg <math>\pm</math> 16.5 % (k=2)</b>



## Appendix (Additional assessments outside the scope of SCS 0108)

### Antenna Parameters with Head TSL

Impedance, transformed to feed point	49.5 $\Omega$ + 6.5 j $\Omega$
Return Loss	- 23.7 dB

### General Antenna Parameters and Design

Electrical Delay (one direction)	1.191 ns
----------------------------------	----------

After long term use with 100W radiated power, only a slight warming of the dipole near the feedpoint can be measured.

The dipole is made of standard semirigid coaxial cable. The center conductor of the feeding line is directly connected to the second arm of the dipole. The antenna is therefore short-circuited for DC-signals. On some of the dipoles, small end caps are added to the dipole arms in order to improve matching when loaded according to the position as explained in the "Measurement Conditions" paragraph. The SAR data are not affected by this change. The overall dipole length is still according to the Standard.

No excessive force must be applied to the dipole arms, because they might bend or the soldered connections near the feedpoint may be damaged.

### Additional EUT Data

Manufactured by	SPEAG
-----------------	-------

## DASY5 Validation Report for Head TSL

Date: 27.03.2023

Test Laboratory: SPEAG, Zurich, Switzerland

**DUT: Dipole 1900 MHz; Type: D1900V2; Serial: D1900V2 - SN:5d251**

Communication System: UID 0 - CW; Frequency: 1900 MHz

Medium parameters used:  $f = 1900$  MHz;  $\sigma = 1.36$  S/m;  $\epsilon_r = 39$ ;  $\rho = 1000$  kg/m<sup>3</sup>

Phantom section: Flat Section

Measurement Standard: DASY5 (IEEE/IEC/ANSI C63.19-2011)

DASY52 Configuration:

- Probe: EX3DV4 - SN7349; ConvF(8.35, 8.35, 8.35) @ 1900 MHz; Calibrated: 10.01.2023
- Sensor-Surface: 1.4mm (Mechanical Surface Detection)
- Electronics: DAE4 Sn601; Calibrated: 19.12.2022
- Phantom: Flat Phantom 5.0 (front); Type: QD 000 P50 AA; Serial: 1001
- DASY52 52.10.4(1535); SEMCAD X 14.6.14(7501)

### Dipole Calibration for Head Tissue/Pin=250 mW, d=10mm/Zoom Scan (7x7x7)/Cube 0:

Measurement grid: dx=5mm, dy=5mm, dz=5mm

Reference Value = 108.9 V/m; Power Drift = -0.01 dB

Peak SAR (extrapolated) = 17.4 W/kg

**SAR(1 g) = 9.61 W/kg; SAR(10 g) = 5.04 W/kg**

Smallest distance from peaks to all points 3 dB below = 10 mm

Ratio of SAR at M2 to SAR at M1 = 55.4%

Maximum value of SAR (measured) = 14.8 W/kg

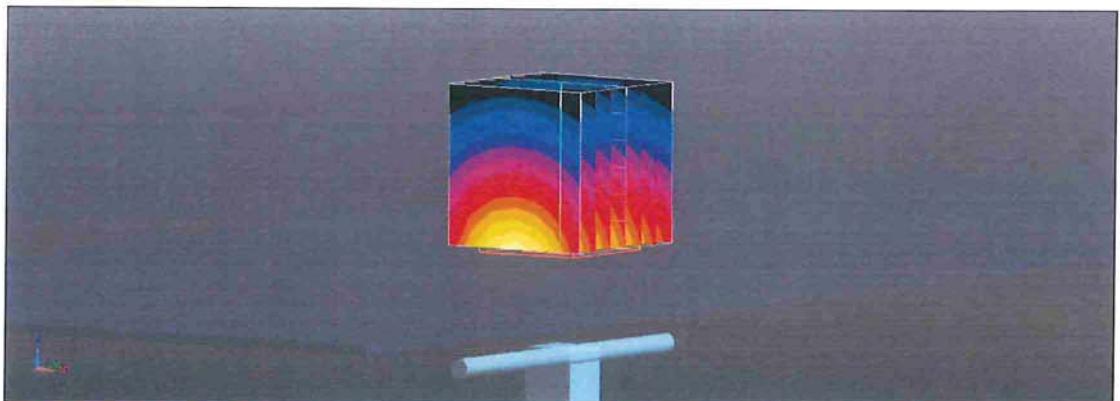
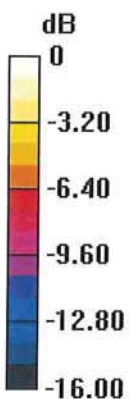

0 dB = 14.8 W/kg = 11.70 dBW/kg

# Impedance Measurement Plot for Head TSL

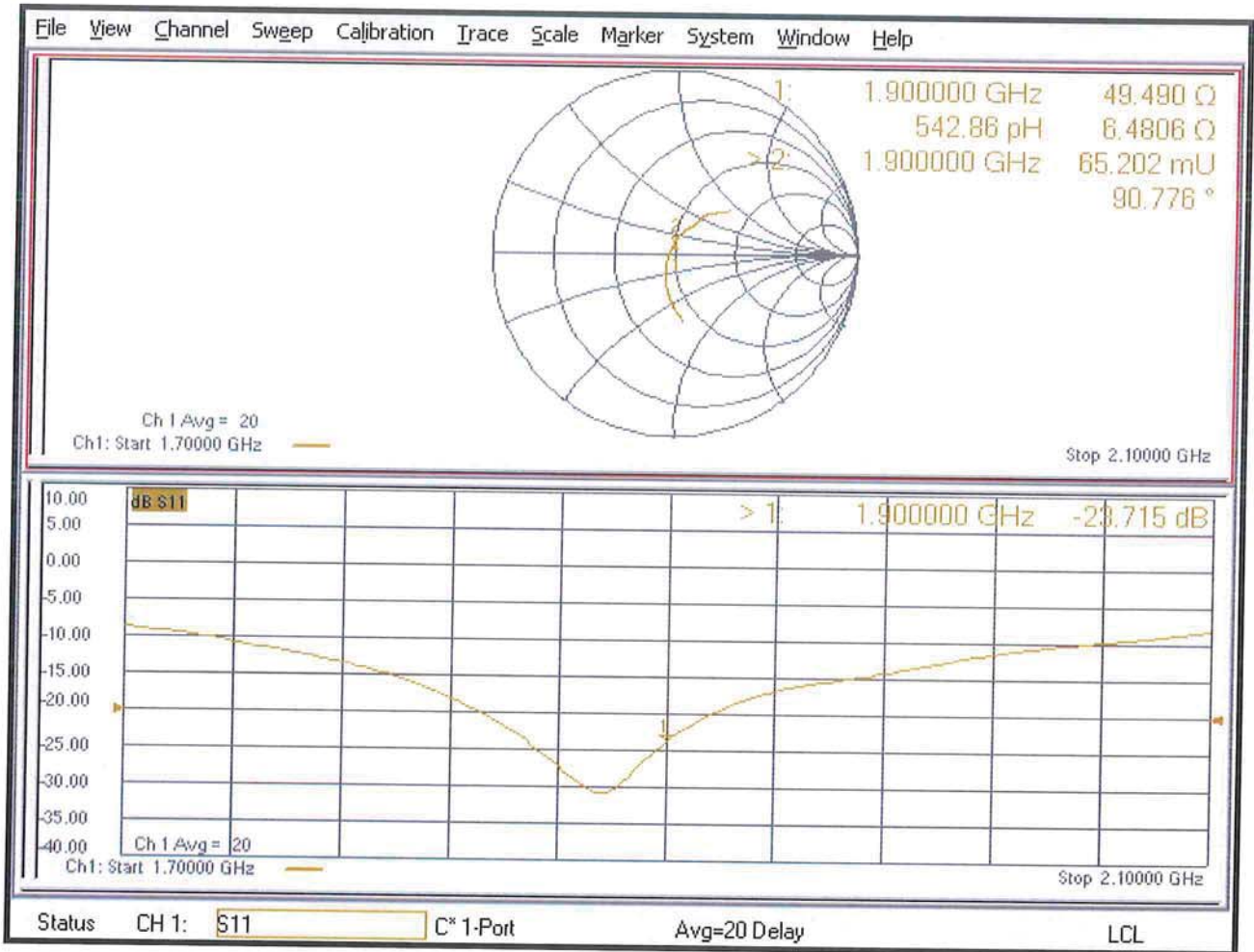



Accredited by the Swiss Accreditation Service (SAS)  
The Swiss Accreditation Service is one of the signatories to the EA  
Multilateral Agreement for the recognition of calibration certificates

Client **BACL**  
**Sunnyvale, USA**

Certificate No. **D2450V2-1102\_Mar23**

**CALIBRATION CERTIFICATE**

Object **D2450V2 - SN:1102**

Calibration procedure(s) **QA CAL-05.v12  
Calibration Procedure for SAR Validation Sources between 0.7-3 GHz**

Calibration date: **March 27, 2023**

This calibration certificate documents the traceability to national standards, which realize the physical units of measurements (SI).  
The measurements and the uncertainties with confidence probability are given on the following pages and are part of the certificate.

All calibrations have been conducted in the closed laboratory facility: environment temperature (22 ± 3)°C and humidity < 70%.

Calibration Equipment used (M&TE critical for calibration)

Primary Standards	ID #	Cal Date (Certificate No.)	Scheduled Calibration
Power meter NRP	SN: 104778	04-Apr-22 (No. 217-03525/03524)	Apr-23
Power sensor NRP-Z91	SN: 103244	04-Apr-22 (No. 217-03524)	Apr-23
Power sensor NRP-Z91	SN: 103245	04-Apr-22 (No. 217-03525)	Apr-23
Reference 20 dB Attenuator	SN: BH9394 (20k)	04-Apr-22 (No. 217-03527)	Apr-23
Type-N mismatch combination	SN: 310982 / 06327	04-Apr-22 (No. 217-03528)	Apr-23
Reference Probe EX3DV4	SN: 7349	10-Jan-23 (No. EX3-7349_Jan23)	Jan-24
DAE4	SN: 601	19-Dec-22 (No. DAE4-601_Dec22)	Dec-23
Secondary Standards	ID #	Check Date (in house)	Scheduled Check
Power meter E4419B	SN: GB39512475	30-Oct-14 (in house check Oct-22)	In house check: Oct-24
Power sensor HP 8481A	SN: US37292783	07-Oct-15 (in house check Oct-22)	In house check: Oct-24
Power sensor HP 8481A	SN: MY41093315	07-Oct-15 (in house check Oct-22)	In house check: Oct-24
RF generator R&S SMT-06	SN: 100972	15-Jun-15 (in house check Oct-22)	In house check: Oct-24
Network Analyzer Agilent E8358A	SN: US41080477	31-Mar-14 (in house check Oct-22)	In house check: Oct-24

Calibrated by:	Name <b>Jeton Kastrati</b>	Function <b>Laboratory Technician</b>	Signature 
Approved by:	Name <b>Sven Kühn</b>	Function <b>Technical Manager</b>	Signature 

Issued: March 27, 2023

This calibration certificate shall not be reproduced except in full without written approval of the laboratory.



Accredited by the Swiss Accreditation Service (SAS)

The Swiss Accreditation Service is one of the signatories to the EA Multilateral Agreement for the recognition of calibration certificates

### Glossary:

TSL	tissue simulating liquid
ConvF	sensitivity in TSL / NORM x,y,z
N/A	not applicable or not measured

### Calibration is Performed According to the Following Standards:

- a) IEC/IEEE 62209-1528, "Measurement Procedure For The Assessment Of Specific Absorption Rate Of Human Exposure To Radio Frequency Fields From Hand-Held And Body-Worn Wireless Communication Devices - Part 1528: Human Models, Instrumentation And Procedures (Frequency Range of 4 MHz to 10 GHz)", October 2020.
- b) KDB 865664, "SAR Measurement Requirements for 100 MHz to 6 GHz"

### Additional Documentation:

- c) DASY System Handbook

### Methods Applied and Interpretation of Parameters:

- *Measurement Conditions:* Further details are available from the Validation Report at the end of the certificate. All figures stated in the certificate are valid at the frequency indicated.
- *Antenna Parameters with TSL:* The source is mounted in a touch configuration below the center marking of the flat phantom.
- *Return Loss:* This parameter is measured with the source positioned under the liquid filled phantom (as described in the measurement condition clause). The Return Loss ensures low reflected power. No uncertainty required.
- *SAR measured:* SAR measured at the stated antenna input power.
- *SAR normalized:* SAR as measured, normalized to an input power of 1 W at the antenna connector.
- *SAR for nominal TSL parameters:* The measured TSL parameters are used to calculate the nominal SAR result.

The reported uncertainty of measurement is stated as the standard uncertainty of measurement multiplied by the coverage factor  $k=2$ , which for a normal distribution corresponds to a coverage probability of approximately 95%.

## Measurement Conditions

DASY system configuration, as far as not given on page 1.

DASY Version	DASY52	V52.10.4
Extrapolation	Advanced Extrapolation	
Phantom	Modular Flat Phantom	
Distance Dipole Center - TSL	10 mm	with Spacer
Zoom Scan Resolution	dx, dy, dz = 5 mm	
Frequency	2450 MHz ± 1 MHz	

## Head TSL parameters

The following parameters and calculations were applied.

	Temperature	Permittivity	Conductivity
Nominal Head TSL parameters	22.0 °C	39.2	1.80 mho/m
Measured Head TSL parameters	(22.0 ± 0.2) °C	38.0 ± 6 %	1.81 mho/m ± 6 %
Head TSL temperature change during test	< 0.5 °C	----	----

## SAR result with Head TSL

SAR averaged over 1 cm <sup>3</sup> (1 g) of Head TSL	Condition	
SAR measured	250 mW input power	12.9 W/kg
SAR for nominal Head TSL parameters	normalized to 1W	<b>50.9 W/kg ± 17.0 % (k=2)</b>

SAR averaged over 10 cm <sup>3</sup> (10 g) of Head TSL	condition	
SAR measured	250 mW input power	6.07 W/kg
SAR for nominal Head TSL parameters	normalized to 1W	<b>24.1 W/kg ± 16.5 % (k=2)</b>

## Appendix (Additional assessments outside the scope of SCS 0108)

### Antenna Parameters with Head TSL

Impedance, transformed to feed point	53.9 $\Omega$ + 4.8 j $\Omega$
Return Loss	- 24.6 dB

### General Antenna Parameters and Design

Electrical Delay (one direction)	1.155 ns
----------------------------------	----------

After long term use with 100W radiated power, only a slight warming of the dipole near the feedpoint can be measured.

The dipole is made of standard semirigid coaxial cable. The center conductor of the feeding line is directly connected to the second arm of the dipole. The antenna is therefore short-circuited for DC-signals. On some of the dipoles, small end caps are added to the dipole arms in order to improve matching when loaded according to the position as explained in the "Measurement Conditions" paragraph. The SAR data are not affected by this change. The overall dipole length is still according to the Standard.

No excessive force must be applied to the dipole arms, because they might bend or the soldered connections near the feedpoint may be damaged.

### Additional EUT Data

Manufactured by	SPEAG
-----------------	-------

## DASY5 Validation Report for Head TSL

Date: 27.03.2023

Test Laboratory: SPEAG, Zurich, Switzerland

**DUT: Dipole 2450 MHz; Type: D2450V2; Serial: D2450V2 - SN:1102**

Communication System: UID 0 - CW; Frequency: 2450 MHz

Medium parameters used:  $f = 2450$  MHz;  $\sigma = 1.81$  S/m;  $\epsilon_r = 38$ ;  $\rho = 1000$  kg/m<sup>3</sup>

Phantom section: Flat Section

Measurement Standard: DASY5 (IEEE/IEC/ANSI C63.19-2011)

DASY52 Configuration:

- Probe: EX3DV4 - SN7349; ConvF(7.88, 7.88, 7.88) @ 2450 MHz; Calibrated: 10.01.2023
- Sensor-Surface: 1.4mm (Mechanical Surface Detection)
- Electronics: DAE4 Sn601; Calibrated: 19.12.2022
- Phantom: Flat Phantom 5.0 (front); Type: QD 000 P50 AA; Serial: 1001
- DASY52 52.10.4(1535); SEMCAD X 14.6.14(7501)

### Dipole Calibration for Head Tissue/Pin=250 mW, d=10mm/Zoom Scan (7x7x7)/Cube 0:

Measurement grid: dx=5mm, dy=5mm, dz=5mm

Reference Value = 115.0 V/m; Power Drift = -0.01 dB

Peak SAR (extrapolated) = 24.7 W/kg

**SAR(1 g) = 12.9 W/kg; SAR(10 g) = 6.07 W/kg**

Smallest distance from peaks to all points 3 dB below = 9 mm

Ratio of SAR at M2 to SAR at M1 = 51.9%

Maximum value of SAR (measured) = 20.7 W/kg

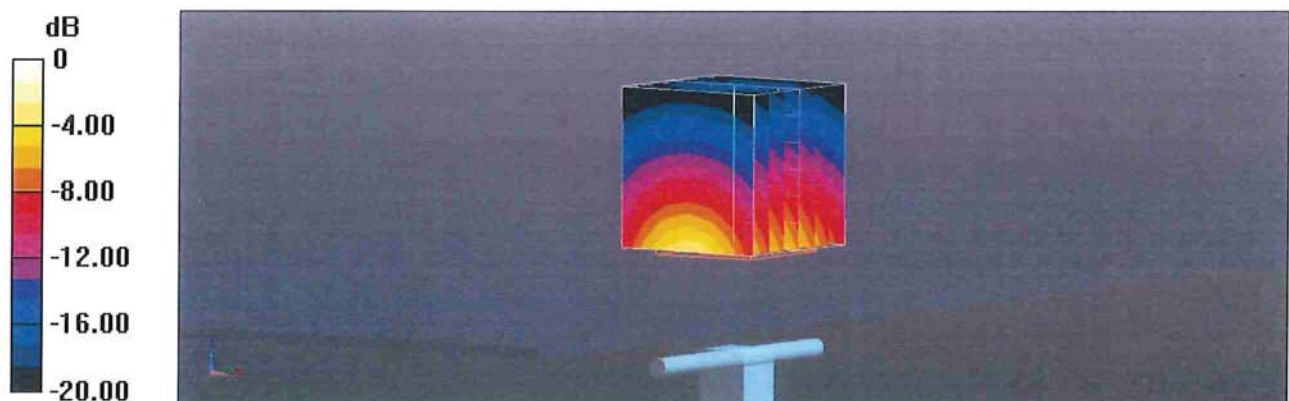



# Impedance Measurement Plot for Head TSL

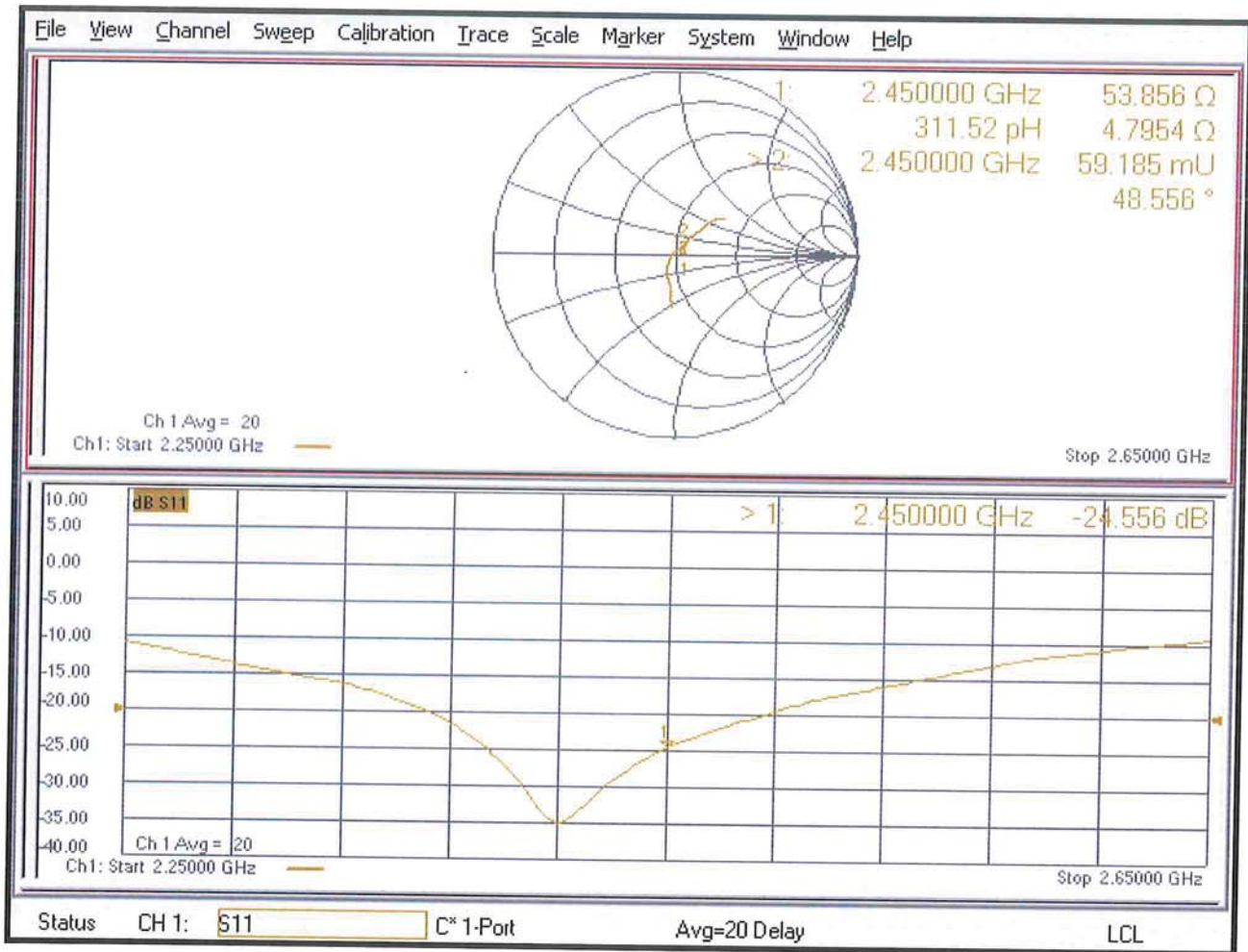



Accredited by the Swiss Accreditation Service (SAS)  
The Swiss Accreditation Service is one of the signatories to the EA  
Multilateral Agreement for the recognition of calibration certificates

Client **BACL**  
Sunnyvale, USA

Certificate No. **D2600V2-1206\_Mar23**

## CALIBRATION CERTIFICATE

Object **D2600V2 - SN:1206**

Calibration procedure(s) **QA CAL-05.v12**  
**Calibration Procedure for SAR Validation Sources between 0.7-3 GHz**

Calibration date: **March 27, 2023**

This calibration certificate documents the traceability to national standards, which realize the physical units of measurements (SI).  
The measurements and the uncertainties with confidence probability are given on the following pages and are part of the certificate.

All calibrations have been conducted in the closed laboratory facility: environment temperature (22 ± 3)°C and humidity < 70%.

Calibration Equipment used (M&TE critical for calibration)

Primary Standards	ID #	Cal Date (Certificate No.)	Scheduled Calibration
Power meter NRP	SN: 104778	04-Apr-22 (No. 217-03525/03524)	Apr-23
Power sensor NRP-Z91	SN: 103244	04-Apr-22 (No. 217-03524)	Apr-23
Power sensor NRP-Z91	SN: 103245	04-Apr-22 (No. 217-03525)	Apr-23
Reference 20 dB Attenuator	SN: BH9394 (20k)	04-Apr-22 (No. 217-03527)	Apr-23
Type-N mismatch combination	SN: 310982 / 06327	04-Apr-22 (No. 217-03528)	Apr-23
Reference Probe EX3DV4	SN: 7349	10-Jan-23 (No. EX3-7349_Jan23)	Jan-24
DAE4	SN: 601	19-Dec-22 (No. DAE4-601_Dec22)	Dec-23
Secondary Standards	ID #	Check Date (in house)	Scheduled Check
Power meter E4419B	SN: GB39512475	30-Oct-14 (in house check Oct-22)	In house check: Oct-24
Power sensor HP 8481A	SN: US37292783	07-Oct-15 (in house check Oct-22)	In house check: Oct-24
Power sensor HP 8481A	SN: MY41093315	07-Oct-15 (in house check Oct-22)	In house check: Oct-24
RF generator R&S SMT-06	SN: 100972	15-Jun-15 (in house check Oct-22)	In house check: Oct-24
Network Analyzer Agilent E8358A	SN: US41080477	31-Mar-14 (in house check Oct-22)	In house check: Oct-24

Calibrated by:	Name Jeton Kastrati	Function Laboratory Technician	Signature 
Approved by:	Sven Kühn	Technical Manager	

Issued: March 27, 2023

This calibration certificate shall not be reproduced except in full without written approval of the laboratory.



Accredited by the Swiss Accreditation Service (SAS)

The Swiss Accreditation Service is one of the signatories to the EA  
Multilateral Agreement for the recognition of calibration certificates

### Glossary:

TSL	tissue simulating liquid
ConvF	sensitivity in TSL / NORM x,y,z
N/A	not applicable or not measured

### Calibration is Performed According to the Following Standards:

- IEC/IEEE 62209-1528, "Measurement Procedure For The Assessment Of Specific Absorption Rate Of Human Exposure To Radio Frequency Fields From Hand-Held And Body-Worn Wireless Communication Devices - Part 1528: Human Models, Instrumentation And Procedures (Frequency Range of 4 MHz to 10 GHz)", October 2020.
- KDB 865664, "SAR Measurement Requirements for 100 MHz to 6 GHz"

### Additional Documentation:

- DASY System Handbook

### Methods Applied and Interpretation of Parameters:

- Measurement Conditions:* Further details are available from the Validation Report at the end of the certificate. All figures stated in the certificate are valid at the frequency indicated.
- Antenna Parameters with TSL:* The source is mounted in a touch configuration below the center marking of the flat phantom.
- Return Loss:* This parameter is measured with the source positioned under the liquid filled phantom (as described in the measurement condition clause). The Return Loss ensures low reflected power. No uncertainty required.
- SAR measured:* SAR measured at the stated antenna input power.
- SAR normalized:* SAR as measured, normalized to an input power of 1 W at the antenna connector.
- SAR for nominal TSL parameters:* The measured TSL parameters are used to calculate the nominal SAR result.

The reported uncertainty of measurement is stated as the standard uncertainty of measurement multiplied by the coverage factor  $k=2$ , which for a normal distribution corresponds to a coverage probability of approximately 95%.

## Measurement Conditions

DASY system configuration, as far as not given on page 1.

DASY Version	DASY52	V52.10.4
Extrapolation	Advanced Extrapolation	
Phantom	Modular Flat Phantom	
Distance Dipole Center - TSL	10 mm	with Spacer
Zoom Scan Resolution	dx, dy, dz = 5 mm	
Frequency	2600 MHz $\pm$ 1 MHz	

## Head TSL parameters

The following parameters and calculations were applied.

	Temperature	Permittivity	Conductivity
Nominal Head TSL parameters	22.0 °C	39.0	1.96 mho/m
Measured Head TSL parameters	(22.0 $\pm$ 0.2) °C	37.4 $\pm$ 6 %	1.97 mho/m $\pm$ 6 %
Head TSL temperature change during test	< 0.5 °C	----	----

## SAR result with Head TSL

SAR averaged over 1 cm <sup>3</sup> (1 g) of Head TSL	Condition	
SAR measured	250 mW input power	14.2 W/kg
SAR for nominal Head TSL parameters	normalized to 1W	<b>56.0 W/kg <math>\pm</math> 17.0 % (k=2)</b>

SAR averaged over 10 cm <sup>3</sup> (10 g) of Head TSL	condition	
SAR measured	250 mW input power	6.36 W/kg
SAR for nominal Head TSL parameters	normalized to 1W	<b>25.3 W/kg <math>\pm</math> 16.5 % (k=2)</b>

## Appendix (Additional assessments outside the scope of SCS 0108)

### Antenna Parameters with Head TSL

Impedance, transformed to feed point	48.1 $\Omega$ + 1.3 j $\Omega$
Return Loss	- 32.7 dB

### General Antenna Parameters and Design

Electrical Delay (one direction)	1.143 ns
----------------------------------	----------

After long term use with 100W radiated power, only a slight warming of the dipole near the feedpoint can be measured.

The dipole is made of standard semirigid coaxial cable. The center conductor of the feeding line is directly connected to the second arm of the dipole. The antenna is therefore short-circuited for DC-signals. On some of the dipoles, small end caps are added to the dipole arms in order to improve matching when loaded according to the position as explained in the "Measurement Conditions" paragraph. The SAR data are not affected by this change. The overall dipole length is still according to the Standard.

No excessive force must be applied to the dipole arms, because they might bend or the soldered connections near the feedpoint may be damaged.

### Additional EUT Data

Manufactured by	SPEAG
-----------------	-------

## DASY5 Validation Report for Head TSL

Date: 27.03.2023

Test Laboratory: SPEAG, Zurich, Switzerland

**DUT: Dipole 2600 MHz; Type: D2600V2; Serial: D2600V2 - SN:1206**

Communication System: UID 0 - CW; Frequency: 2600 MHz

Medium parameters used:  $f = 2600$  MHz;  $\sigma = 1.97$  S/m;  $\epsilon_r = 37.4$ ;  $\rho = 1000$  kg/m<sup>3</sup>

Phantom section: Flat Section

Measurement Standard: DASY5 (IEEE/IEC/ANSI C63.19-2011)

DASY52 Configuration:

- Probe: EX3DV4 - SN7349; ConvF(7.68, 7.68, 7.68) @ 2600 MHz; Calibrated: 10.01.2023
- Sensor-Surface: 1.4mm (Mechanical Surface Detection)
- Electronics: DAE4 Sn601; Calibrated: 19.12.2022
- Phantom: Flat Phantom 5.0 (front); Type: QD 000 P50 AA; Serial: 1001
- DASY52 52.10.4(1535); SEMCAD X 14.6.14(7501)

### Dipole Calibration for Head Tissue/Pin=250 mW, d=10mm/Zoom Scan (7x7x7)/Cube 0:

Measurement grid: dx=5mm, dy=5mm, dz=5mm

Reference Value = 118.2 V/m; Power Drift = -0.00 dB

Peak SAR (extrapolated) = 27.7 W/kg

**SAR(1 g) = 14.2 W/kg; SAR(10 g) = 6.36 W/kg**

Smallest distance from peaks to all points 3 dB below = 9 mm

Ratio of SAR at M2 to SAR at M1 = 51%

Maximum value of SAR (measured) = 23.5 W/kg

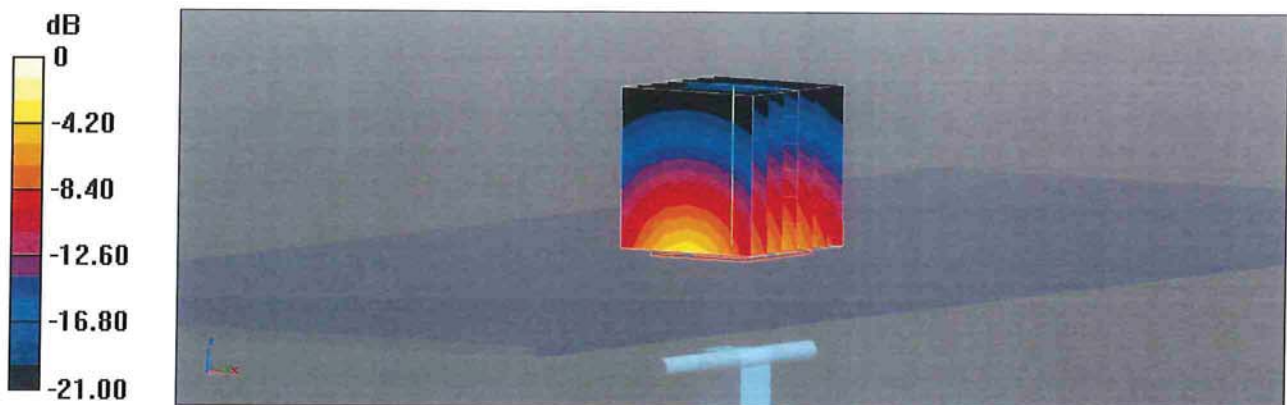

# Impedance Measurement Plot for Head TSL

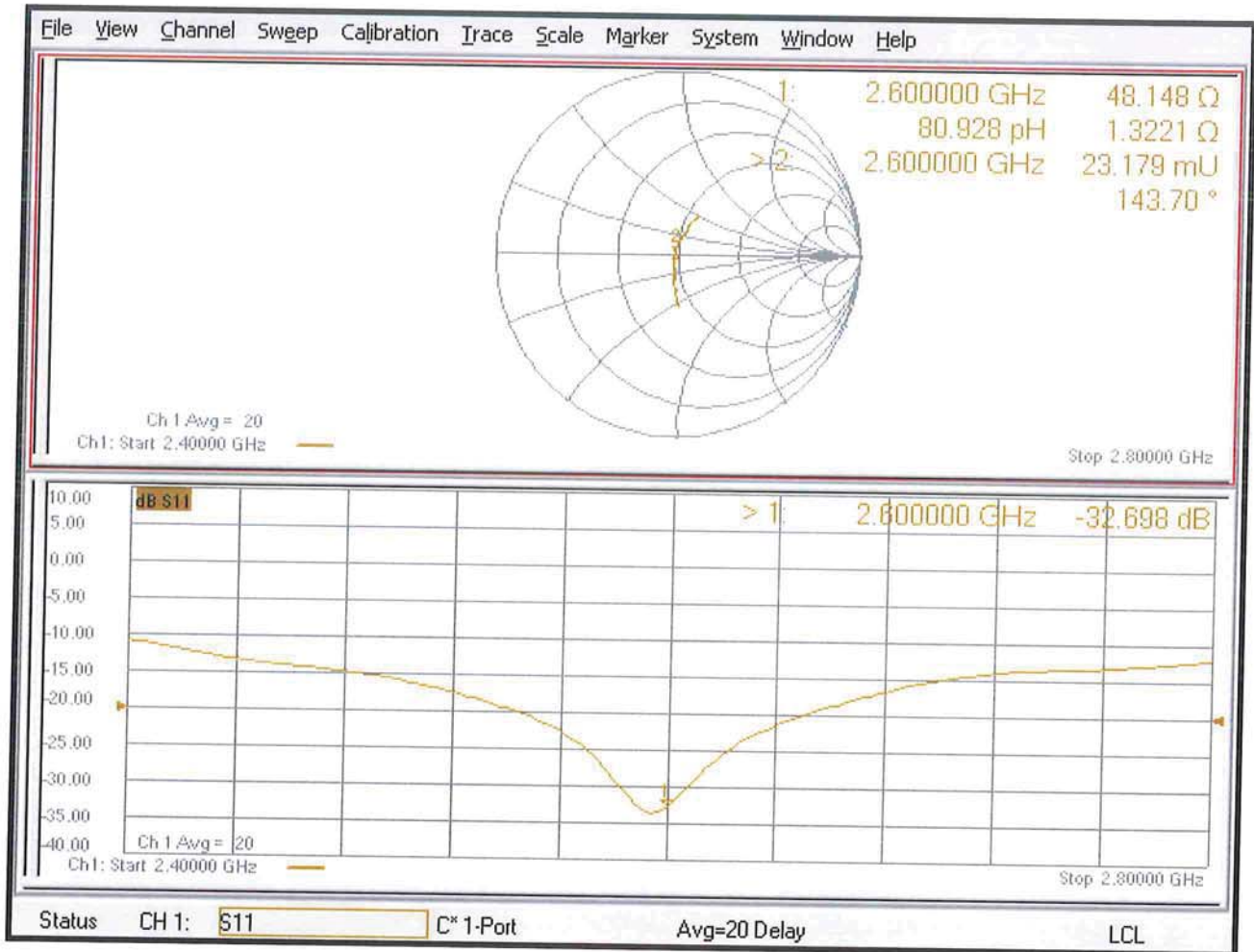

Add: No.52 HuaYuanBei Road, Haidian District, Beijing, 100191  
Tel: +86-10-62304633-2117  
E-mail: emf@caict.ac.cn      http://www.caic.ac.cn

Client **BACL**

Certificate No: **Z22-60480**

## CALIBRATION CERTIFICATE

Object **D5GHzV2 - SN: 1246**

Calibration Procedure(s) **FF-Z11-003-01**  
**Calibration Procedures for dipole validation kits**



Calibration date: **November 1, 2022**

This calibration Certificate documents the traceability to national standards, which realize the physical units of measurements (SI). The measurements and the uncertainties with confidence probability are given on the following pages and are part of the certificate.

All calibrations have been conducted in the closed laboratory facility: environment temperature (22±3)°C and humidity<70%.

Calibration Equipment used (M&TE critical for calibration)

Primary Standards	ID #	Cal Date (Calibrated by, Certificate No.)	Scheduled Calibration
Power Meter NRP2	106276	10-May-22 (CTTL, No.J22X03103)	May-23
Power sensor NRP6A	101369	10-May-22 (CTTL, No.J22X03103)	May-23
Reference Probe EX3DV4	SN 7464	26-Jan-22(SPEAG,No.EX3-7464_Jan22)	Jan-23
DAE4	SN 1556	12-Jan-22(CTTL-SPEAG,No.Z22-60007)	Jan-23
Secondary Standards	ID #	Cal Date (Calibrated by, Certificate No.)	Scheduled Calibration
Signal Generator E4438C	MY49071430	13-Jan-22 (CTTL, No. J22X00409)	Jan-23
Network Analyzer E5071C	MY46110673	14-Jan-22 (CTTL, No.J22X00406)	Jan-23

	Name	Function	Signature
Calibrated by:	Zhao Jing	SAR Test Engineer	
Reviewed by:	Lin Hao	SAR Test Engineer	
Approved by:	Qi Dianyuan	SAR Project Leader	

Issued: November 7, 2022

This calibration certificate shall not be reproduced except in full without written approval of the laboratory.