

TEST REPORT

Test report no.: 1-3474/17-01-03-A

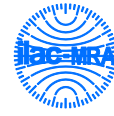

Deutsche
Akkreditierungsstelle
D-PL-12076-01-01

Testing laboratory

CTC advanced GmbH

Untertuerkheimer Strasse 6 – 10

66117 Saarbruecken / Germany

Phone: + 49 681 5 98 - 0

Fax: + 49 681 5 98 - 9075

Internet: <http://www.ctcadvanced.com>

e-mail: mail@ctcadvanced.com

Accredited Testing Laboratory:

The testing laboratory (area of testing) is accredited according to DIN EN ISO/IEC 17025 (2005) by the Deutsche Akkreditierungsstelle GmbH (DAkkS)

The accreditation is valid for the scope of testing procedures as stated in the accreditation certificate with the registration number: D-PL-12076-01-03

Applicant

Bosch Engineering GmbH

Robert Bosch Allee 1

74232 Abstatt / GERMANY

Phone: +49 7062 911-02

Fax: +49 7062 911-6201

Contact: Roman Walther

e-mail: Roman.Walther@de.bosch.com

Phone: +49 7062 911-9636

Manufacturer

Bosch Engineering GmbH

Robert Bosch Allee 1

74232 Abstatt / GERMANY

Test standard/s

47 CFR Part 95

Subpart M: 76-81 GHz Band Radar Service

RSS - Gen Issue 4

Spectrum Management and Telecommunications Radio Standards Specifications - General Requirements and Information for the Certification of Radio Apparatus

RSS-251 Issue 1

Field Disturbance Sensors in the Bands 46.7-46.9 GHz (Vehicular Radar) and 76-77 GHz (Vehicular and Airport Fixed Radar)

For further applied test standards please refer to section 3 of this test report.

Test Item

Kind of test item: Motion Detector 76 GHz Mid Range Radar

Model name: MRRe14HBW

FCC ID: 2AM6A-MRRE14HBW

IC: 23203-MRRE14HBW

Frequency: 76.0 – 77.0 GHz

Antenna: Integrated patch antenna

Power supply: 7.0 – 18.0 V DC from power supply

Temperature range: -40°C to +85°C



This test report is electronically signed and valid without handwriting signature. For verification of the electronic signatures, the public keys can be requested at the testing laboratory.

Test report authorized:

Karsten Gerdaldy
Lab Manager
Radio Communications & EMC

Test performed:

Meheza Walla
Lab Manager
Radio Communications & EMC

1 Table of contents

1	Table of contents	2
2	General information	3
2.1	Notes and disclaimer	3
2.2	Application details.....	3
2.3	Test laboratories sub-contracted	3
3	Test standard/s	4
4	Test environment.....	4
5	Test item	5
5.1	General description	5
5.2	Additional information	5
6	Description of the test setup	6
6.1	Shielded semi anechoic chamber	7
6.2	Shielded fully anechoic chamber	8
6.3	Radiated measurements > 18 GHz.....	9
7	Sequence of testing	11
7.1	Sequence of testing radiated spurious 9 kHz to 30 MHz.....	11
7.2	Sequence of testing radiated spurious 30 MHz to 1 GHz.....	12
7.3	Sequence of testing radiated spurious 1 GHz to 18 GHz	13
7.4	Sequence of testing radiated spurious above 18 GHz	14
7.5	Sequence of testing radiated spurious above 50 GHz with external mixers	15
8	Summary of measurement results	16
9	Measurement results.....	17
9.1	Power density	17
9.2	Modulation characteristics	31
9.3	Occupied bandwidth	32
9.4	Field strength of emissions (band edge)	33
9.5	Field strength of emissions (radiated spurious)	35
9.6	Frequency stability	50
10	Glossary.....	52
11	Document history	53
12	Accreditation Certificate	53

2 General information

2.1 Notes and disclaimer

The test results of this test report relate exclusively to the test item specified in this test report. CTC advanced GmbH does not assume responsibility for any conclusions and generalizations drawn from the test results with regard to other specimens or samples of the type of the equipment represented by the test item.

The test report may only be reproduced or published in full. Reproduction or publication of extracts from the report requires the prior written approval of CTC advanced GmbH.

The testing service provided by CTC advanced GmbH has been rendered under the current "General Terms and Conditions for CTC advanced GmbH".

CTC advanced GmbH will not be liable for any loss or damage resulting from false, inaccurate, inappropriate or incomplete product information provided by the customer.

Under no circumstances does the CTC advanced GmbH test report include any endorsement or warranty regarding the functionality, quality or performance of any other product or service provided.

Under no circumstances does the CTC advanced GmbH test report include or imply any product or service warranties from CTC advanced GmbH, including, without limitation, any implied warranties of merchantability, fitness for purpose, or non-infringement, all of which are expressly disclaimed by CTC advanced GmbH.

All rights and remedies regarding vendor's products and services for which CTC advanced GmbH has prepared this test report shall be provided by the party offering such products or services and not by CTC advanced GmbH. In no case this test report can be considered as a Letter of Approval.

This test report is electronically signed and valid without handwritten signature. For verification of the electronic signatures, the public keys can be requested at the testing laboratory.

This test report replaces the test report with the number 1-3474/17-01-03 and dated 2017-11-20

2.2 Application details

Date of receipt of order:	2017-03-17
Date of receipt of test item:	2017-07-17
Start of test:	2017-07-17
End of test:	2017-07-21
Person(s) present during the test:	Mr. Stefan Aniol

2.3 Test laboratories sub-contracted

None

3 Test standard/s

Test standard	Date	Test standard description
47 CFR Part 95		Subpart M: 76-81 GHz Band Radar Service
RSS - Gen Issue 4	November 2014	Spectrum Management and Telecommunications Radio Standards Specifications - General Requirements and Information for the Certification of Radio Apparatus
RSS-251 Issue 1	November 2014	Field Disturbance Sensors in the Bands 46.7-46.9 GHz (Vehicular Radar) and 76-77 GHz (Vehicular and Airport Fixed Radar)

Guidance	Version	Description
ANSI C63.4-2014	-/-	American national standard for methods of measurement of radio-noise emissions from low-voltage electrical and electronic equipment in the range of 9 kHz to 40 GHz
ANSI C63.10-2013	-/-	American national standard of procedures for compliance testing of unlicensed wireless devices

4 Test environment

Temperature	:	T _{nom} T _{max} T _{min}	+22 °C during room temperature tests +85 °C during high temperature tests -40 °C during low temperature tests
Relative humidity content	:		55 %
Barometric pressure	:		not relevant for this kind of testing
Power supply	:	V _{nom} V _{max} V _{min}	12.75 V DC from power supply 18.00 V 7.00 V

5 Test item

5.1 General description

Kind of test item	:	Motion Detector 76 GHz Mid Range Radar
Type identification	:	MRRe14HBW
S/N serial number	:	-/-
HMN	:	NA
PMN	:	MRRe14HBW
HVIN	:	MRRe14HBW
FVIN	:	NA
HW hardware status	:	0 203 300 996
SW software status	:	I8.1
Frequency band	:	76.0 – 77.0 GHz
Type of modulation	:	FMCW
Number of channels	:	1
Antenna	:	Integrated patch antenna
Power supply	:	7.0 – 18.0 V DC from power supply
Temperature range	:	-40°C to +85°C

NA: Not Applicable

5.2 Additional information

- Test mode:
- Normal operation mode (Mode 1_200 MHz / Mode 2_400 MHz / Mode 3_700 MHz).
 - Special test software was used to change from normal operation mode to test mode (low / middle / high) as required by CFR 47 Part 15.31(c).

Mode 1: 200 MHz mode results a measured occupied bandwidth of 462 MHz.
Please see Customer's Declaration for further clarification.

The content of the following annexes is defined in the QA. It may be that not all of the listed annexes are necessary for this report, thus some values in between may be missing.

Test setup- and EUT-photos are included in test report:

- 1-3474/17-01-01_AnnexA
- 1-3474/17-01-01_AnnexB
- 1-3474/17-01-01_AnnexD

6 Description of the test setup

Typically, the calibrations of the test apparatus are commissioned to and performed by an accredited calibration laboratory. The calibration intervals are determined in accordance with the DIN EN ISO/IEC 17025. In addition to the external calibrations, the laboratory executes comparison measurements with other calibrated test systems or effective verifications. Weekly chamber inspections and range calibrations are performed. Where possible, RF generating and signaling equipment as well as measuring receivers and analyzers are connected to an external high-precision 10 MHz reference (GPS-based or rubidium frequency standard).

In order to simplify the identification of the equipment used at some special tests, some items of test equipment and ancillaries can be provided with an identifier or number in the equipment list below (Lab/Item).

Agenda: Kind of Calibration

k	calibration / calibrated	EK	limited calibration
ne	not required (k, ev, izw, zw not required)	zw	cyclical maintenance (external cyclical maintenance)
ev	periodic self verification	izw	internal cyclical maintenance
Ve	long-term stability recognized	g	blocked for accredited testing
v/k!	Attention: extended calibration interval		
NK!	Attention: not calibrated	*)	next calibration ordered / currently in progress

6.1 Shielded semi anechoic chamber

The radiated measurements are performed in vertical and horizontal plane in the frequency range from 9 kHz to 1 GHz in semi-anechoic chambers. The EUT is positioned on a non-conductive support with a height of 0.80 m above a conductive ground plane that covers the whole chamber. The receiving antennas are confirmed with specifications ANSI C63. These antennas can be moved over the height range between 1.0 m and 4.0 m in order to search for maximum field strength emitted from EUT. The measurement distances between EUT and receiving antennas are indicated in the test setups for the various frequency ranges. For each measurement, the EUT is rotated in all three axes until the maximum field strength is received. The wanted and unwanted emissions are received by spectrum analyzers where the detector modes and resolution bandwidths over various frequency ranges are set according to requirement ANSI C63.

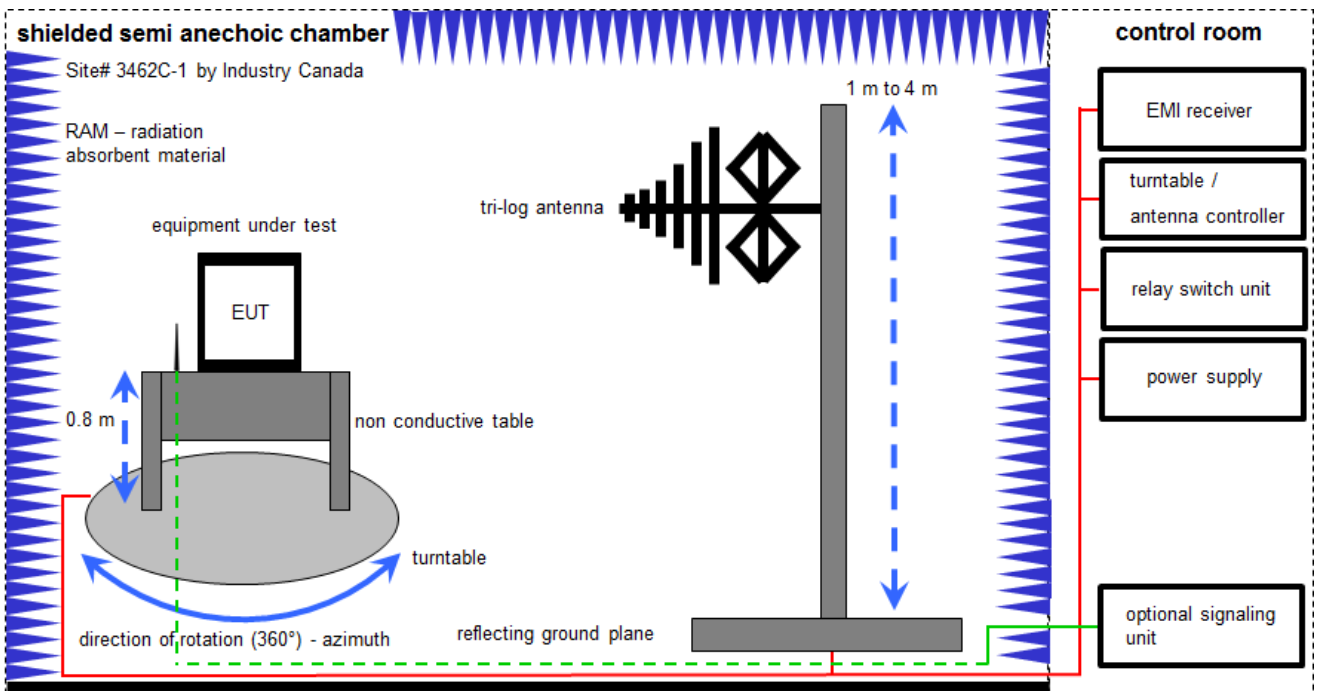

Measurement distance: tri-log antenna 10 meter

$$FS = UR + CL + AF$$

(FS-field strength; UR-voltage at the receiver; CL-loss of the cable; AF-antenna factor)

Example calculation:

$$FS [dB\mu V/m] = 12.35 [dB\mu V/m] + 1.90 [dB] + 16.80 [dB/m] = 31.05 [dB\mu V/m] (35.69 \mu V/m)$$

Equipment table:

No.	Lab / Item	Equipment	Type	Manufacturer	Serial No.	INV. No	Kind of Calibration	Last Calibration	Next Calibration
1	45	Switch-Unit	3488A	HP	2719A14505	300000368	ev	-/-	-/-
2	50	DC power supply, 60Vdc, 50A, 1200 W	6032A	HP	2920A04466	300000580	ne	-/-	-/-
3	93	Meßkabine 1	HF-Absorberhalle	MWB AG 300023		300000551	ne	-/-	-/-
4	n. a.	EMI Test Receiver	ESCI 3	R&S	100083	300003312	k	01.02.2017	31.01.2018
5	n. a.	Analyzer-Reference-System (Harmonics and Flicker)	ARS 16/1	SPS	A3509 07/0 0205	300003314	vKII	02.02.2016	01.02.2018
6	n. a.	Antenna Tower	Model 2175	ETS-Lindgren	64762	300003745	izw	-/-	-/-
7	n. a.	Positioning Controller	Model 2090	ETS-Lindgren	64672	300003746	izw	-/-	-/-
8	n. a.	Turntable Interface-Box	Model 105637	ETS-Lindgren	44583	300003747	izw	-/-	-/-
9	n. a.	TRILOG Broadband Test-Antenna 30 MHz - 3 GHz	VULB9163	Schwarzbeck	295	300003787	k	25.04.2016	25.04.2018
10	n. a.	Spectrum-Analyzer	FSU26	R&S	200809	300003874	k	31.01.2017	30.01.2018

6.2 Shielded fully anechoic chamber

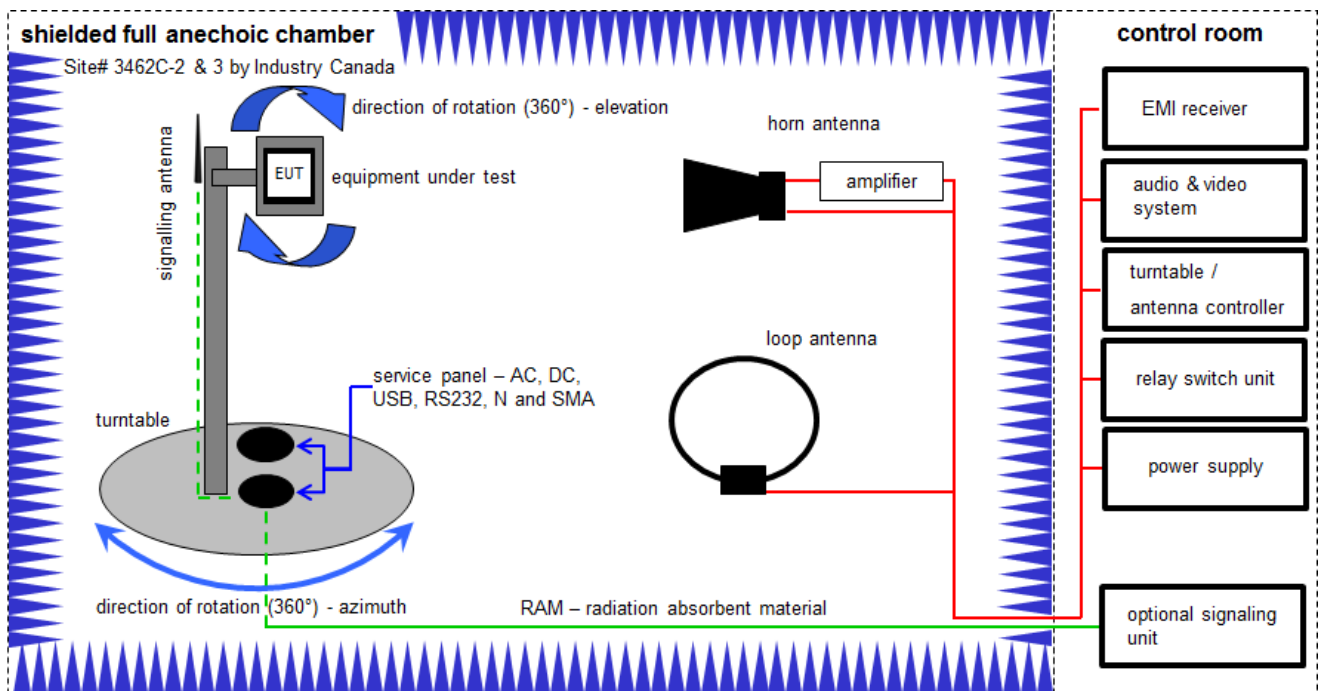

Measurement distance: horn antenna 3 meter; loop antenna 3 meter / 1 meter

FS = UR + CA + AF
(FS-field strength; UR-voltage at the receiver; CA-loss of the signal path; AF-antenna factor)

Example calculation:

$$FS [dB\mu V/m] = 40.0 [dB\mu V/m] + (-35.8) [dB] + 32.9 [dB/m] = 37.1 [dB\mu V/m] (71.61 \mu V/m)$$

Equipment table:

No.	Lab / Item	Equipment	Type	Manufacturer	Serial No.	INV. No	Kind of Calibration	Last Calibration	Next Calibration
1	n. a.	DC power supply, 60Vdc, 50A, 1200 W	6032A	HP	2818A03450	300001040	Ve	20.01.2015	20.01.2018
2	n. a.	Double-Ridged Waveguide Horn Antenna 1-18.0GHz	3115	EMCO	8812-3088	300001032	vIKI!	14.02.2017	13.02.2019
3	n. a.	Anechoic chamber	FAC 3/5m	MWB / TDK	87400/02	300000996	ev		
4	n. a.	Switch / Control Unit	3488A	HP	*	300000199	ne		
5	90	Active Loop Antenna 10 kHz to 30 MHz	6502	EMCO/2	8905-2342	300000256	k	24.06.2015	24.06.2018
6	n. a.	Amplifier	js42-00502650-28-5a	Parzich GMBH	928979	300003143	ne		
7	n. a.	Highpass Filter	WHKX7.0/18G-8SS	Wainwright	18	300003789	ne		
8	n. a.	TRILOG Broadband Test-Antenna 30 MHz - 3 GHz	VULB9163	Schwarzbeck	371	300003854	vIKI!	29.10.2014	29.10.2017
9	n. a.	4U RF Switch Platform	L4491A	Agilent Technologies	MY50000037	300004509	ne		
10	n. a.	EMI Test Receiver 9kHz-26,5GHz	ESR26	R&S	101376	300005063	k	13.09.2016	13.03.2018
11	A026	Std. Gain Horn Antenna 12.4 to 18.0 GHz	639	Narda	8402	300000787	k	14.08.2015	14.08.2017
12	A033	Spectrum Analyzer 20 Hz - 50 GHz	FSU50	R&S	200012	300003443	Ve	13.09.2016	13.03.2018

6.3 Radiated measurements > 18 GHz

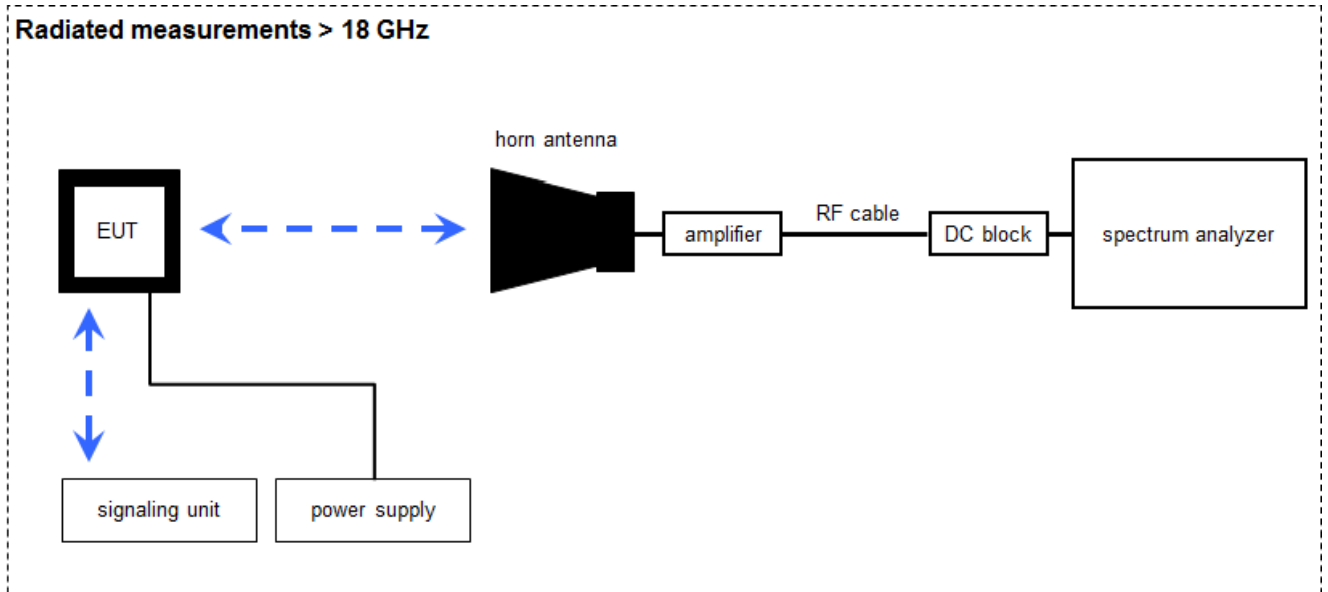

$$FS = UR + CA + AF$$

(FS-field strength; UR-voltage at the receiver; CA-loss signal path & distance correction; AF-antenna factor)

Example calculation:

$$FS [dB\mu V/m] = 40.0 [dB\mu V/m] + (-60.1) [dB] + 36.74 [dB/m] = 16.64 [dB\mu V/m] (6.79 \mu V/m)$$

$$OP = AV + D - G + CA$$

(OP-radiated output power; AV-analyzer value; D-free field attenuation of measurement distance; G-antenna gain+amplifier gain; CA-loss signal path)

Example calculation:

$$OP [dBm] = -59.0 [dBm] + 44.0 [dB] - 20.0 [dBi] + 5.0 [dB] = -30 [dBm] (1 \mu W)$$

Equipment table:

No.	Lab / Item	Equipment	Type	Manufacturer	Serial No.	INV. No	Kind of Calibration	Last Calibration	Next Calibration
1	-/-	Std. Gain Horn Antenna 18.0 to 26.5 GHz	638	Narda	8402	300000487	ne	-/-	-/-
2	-/-	Std. Gain Horn Antenna 26.5 to 40.0 GHz	V637	Narda	82-16	300000510	k	14.08.2015	14.08.2017
3	-/-	Std. Gain Horn Antenna 33.0-50.1 GHz	2324-20	Flann	57	400000683	ne	-/-	-/-
4	-/-	Broadband LNA 18-50 GHz	CBL18503070PN	CERNEX	25240	300004948	ev	-/-	-/-
5	-/-	Std. Gain Horn Antenna 49.9-75.8 GHz	2524-20	Flann	*	300001983	ne	-/-	-/-
6	-/-	Std. Gain Horn Antenna 73.8-112 GHz	2724-20	Flann	*	300001991	ne	-/-	-/-
7	-/-	Std. Gain Horn Antenna 114-173 GHz	2924-20	Flann	*	300001999	ne	-/-	-/-
8	-/-	Std. Gain Horn Antenna 145-220 GHz	3024-20	Flann	*	300002000	ne	-/-	-/-
9	-/-	Power Supply	LA30/5GA	Zentro	2046	300000711	NK!	-/-	-/-
10	-/-	Spectrum Analyzer 20 Hz - 50 GHz	FSU50	R&S	200012	300003443	Ve	24.10.2016	24.10.2017
11	-/-	Temperature Test Chamber	T-40/50	CTS GmbH	064023	300003540	ev	03.09.2015	03.09.2017
12	-/-	Harmonic Mixer 2-Port, 50-75 GHz	FS-Z75	R&S	100099	300003949	k	09.03.2016	09.09.2017
13	-/-	Harmonic Mixer 3-Port, 110-170 GHz	SAM-170	Radiometer Physics GmbH	100014	300004156	k	23.05.2016	23.05.2018
14	-/-	Harmonic Mixer 3-Port, 170-220 GHz	SAM-220	Radiometer Physics GmbH	200001	300004157	k	09.06.2016	09.06.2018
15	-/-	Harmonic Mixer 3-Port, 220-325 GHz	SAM-325	Radiometer Physics GmbH	100002	300004158	k	30.05.2016	30.05.2018
16	-/-	Harmonic Mixer 3-Port, 60-90 GHz	FS-Z90	R&S	101555	300004691	k	12.05.2016	12.11.2017
17	-/-	End Launch Adaptor, 60.5 - 92.0GHz	26373-WF60 UG387/U-AC	Flann	227692	300004809	ev	-/-	-/-
18	-/-	Std. Gain Horn Antenna 217-330 GHz	32240-20	Flann	233278	300004960	ne	-/-	-/-
19	-/-	Harmonic Mixer 3-Port, 75-110 GHz	FS-Z110	R&S	101411	300004959	k	24.10.2016	24.10.2017

7 Sequence of testing

7.1 Sequence of testing radiated spurious 9 kHz to 30 MHz

Setup

- The equipment is set up to simulate normal operation mode as described in the user manual or defined by the manufacturer.
- If the EUT is a tabletop system, a 2-axis positioner with 1.5 m height is used.
- If the EUT is a floor standing device, it is placed directly on the turn table.
- Auxiliary equipment and cables are positioned to simulate normal operation conditions as described in ANSI C 63.4.
- The AC power port of the EUT (if available) is connected to a power outlet below the turntable.
- Measurement distance is 3 m (see ANSI C 63.4) – see test details.
- EUT is set into operation.

Premeasurement

- The turntable rotates from 0° to 315° using 45° steps.
- The antenna height is 1.5 m.
- At each turntable position the analyzer sweeps with positive-peak detector to find the maximum of all emissions.

Final measurement

- Identified emissions during the premeasurement are maximized by the software by rotating the turntable from 0° to 360°. In case of the 2-axis positioner is used the elevation axis is also rotated from 0° to 360°.
- The final measurement is done in the position (turntable and elevation) causing the highest emissions with quasi-peak (as described in ANSI C 63.4).
- Final levels, frequency, measuring time, bandwidth, turntable position, correction factor, margin to the limit and limit will be recorded. A plot with the graph of the premeasurement and the limit is stored.

7.2 Sequence of testing radiated spurious 30 MHz to 1 GHz

Setup

- The equipment is set up to simulate normal operation mode as described in the user manual or defined by the manufacturer.
- If the EUT is a tabletop system, a table with 0.8 m height is used, which is placed on the ground plane.
- If the EUT is a floor standing device, it is placed on the ground plane with insulation between both.
- Auxiliary equipment and cables are positioned to simulate normal operation conditions as described in ANSI C 63.4.
- The AC power port of the EUT (if available) is connected to a power outlet below the turntable.
- Measurement distance is 10 m or 3 m (see ANSI C 63.4) – see test details.
- EUT is set into operation.

Premeasurement

- The turntable rotates from 0° to 315° using 45° steps.
- The antenna is polarized vertical and horizontal.
- The antenna height changes from 1 m to 3 m.
- At each turntable position, antenna polarization and height the analyzer sweeps three times in peak to find the maximum of all emissions.

Final measurement

- The final measurement is performed for at least six highest peaks according to the requirements of the ANSI C63.4.
- Based on antenna and turntable positions at which the peak values are measured the software maximize the peaks by changing turntable position $\pm 45^\circ$ and antenna height between 1 and 4 m.
- The final measurement is done with quasi-peak detector (as described in ANSI C 63.4).
- Final levels, frequency, measuring time, bandwidth, antenna height, antenna polarization, turntable angle, correction factor, margin to the limit and limit are recorded. A plot with the graph of the premeasurement with marked maximum final results and the limit is stored.

7.3 Sequence of testing radiated spurious 1 GHz to 18 GHz

Setup

- The equipment is set up to simulate normal operation mode as described in the user manual or defined by the manufacturer.
- If the EUT is a tabletop system, a 2-axis positioner with 1.5 m height is used.
- If the EUT is a floor standing device, it is placed directly on the turn table.
- Auxiliary equipment and cables are positioned to simulate normal operation conditions as described in ANSI C 63.4.
- The AC power port of the EUT (if available) is connected to a power outlet below the turntable.
- Measurement distance is 3 m (see ANSI C 63.4) – see test details.
- EUT is set into operation.

Premeasurement

- The turntable rotates from 0° to 315° using 45° steps.
- The antenna is polarized vertical and horizontal.
- The antenna height is 1.5 m.
- At each turntable position and antenna polarization the analyzer sweeps with positive peak detector to find the maximum of all emissions.

Final measurement

- The final measurement is performed for at least six highest peaks according to the requirements of the ANSI C63.4.
- Based on antenna and turntable positions at which the peak values are measured the software maximizes the peaks by rotating the turntable from 0° to 360°. This measurement is repeated for different EUT-table positions (0° to 150° in 30°-steps) and for both antenna polarizations.
- The final measurement is done in the position (turntable, EUT-table and antenna polarization) causing the highest emissions with Peak and RMS detector (as described in ANSI C 63.4).
- Final levels, frequency, measuring time, bandwidth, turntable position, EUT-table position, antenna polarization, correction factor, margin to the limit and limit are recorded. A plot with the graph of the premeasurement with marked maximum final results and the limit is stored.

7.4 Sequence of testing radiated spurious above 18 GHz

Setup

- The equipment is set up to simulate normal operation mode as described in the user manual or defined by the manufacturer.
- Auxiliary equipment and cables are positioned to simulate normal operation conditions as described in ANSI C 63.4.
- The AC power port of the EUT (if available) is connected to a power outlet.
- The measurement distance is as appropriate (e.g. 0.5 m).
- The EUT is set into operation.

Premeasurement

- The test antenna is handheld and moved carefully over the EUT to cover the EUT's whole sphere and different polarizations of the antenna.

Final measurement

- The final measurement is performed at the position and antenna orientation causing the highest emissions with Peak and RMS detector (as described in ANSI C 63.4).
- Final levels, frequency, measuring time, bandwidth, correction factor, margin to the limit and limit are recorded. A plot with the graph of the premeasurement and the limit is stored.

7.5 Sequence of testing radiated spurious above 50 GHz with external mixers

Setup

- The equipment is set up to simulate normal operation mode as described in the user manual or defined by the manufacturer.
- Auxiliary equipment and cables are positioned to simulate normal operation conditions as described in ANSI C 63.4.
- The AC power port of the EUT (if available) is connected to a power outlet.
- The measurement distance is as appropriate for far field (e.g. 0.25 m).
- The EUT is set into operation.

Premeasurement

- The test antenna with external mixer is handheld and moved carefully over the EUT to cover the EUT's whole sphere and different polarizations of the antenna.
- Caution is taken to reduce the possible overloading of the external mixer.

Final measurement

- The final measurement is performed at the position and antenna orientation causing the highest emissions with Peak and RMS detector (as described in ANSI C 63.4).
- As external mixers may generate false images care is taken to ensure that any emission measured by the spectrum analyzer does indeed originate in the EUT. Signal identification feature of spectrum analyzer is used to eliminate false mixer images (i.e., it is not the fundamental emission or a harmonic falling precisely at the measured frequency).
- Final levels, frequency, measuring time, bandwidth, correction factor, margin to the limit and limit are recorded. A plot with the graph of the premeasurement and the limit is stored.

8 Summary of measurement results

<input checked="" type="checkbox"/>	No deviations from the technical specifications were ascertained
<input type="checkbox"/>	There were deviations from the technical specifications ascertained
<input type="checkbox"/>	This test report is only a partial test report. The content and verdict of the performed test cases are listed below.

TC Identifier	Description	Verdict	Date	Remark
RF-Testing	47 CFR Part 95 Subpart M RSS – 251 Issue 1	see below	2018-01-22	-/-

Test specification clause	Test case	Temperature conditions	Power source voltages	Pass	Fail	NA	NP	Results (max.)
§2.1046 §95.3367 (a) / (b) RSS-251 (5.2.2)	Power density (RF power output)	Nominal	Nominal	<input checked="" type="checkbox"/>	<input type="checkbox"/>	<input type="checkbox"/>	<input type="checkbox"/>	31.4 dBm PK 25.8 dBm AVG
§2.1047	Modulation characteristics	Nominal	Nominal	<input checked="" type="checkbox"/>	<input type="checkbox"/>	<input type="checkbox"/>	<input type="checkbox"/>	FMCW
§2.1049 RSS-Gen	Occupied bandwidth (99% bandwidth)	Nominal	Nominal	<input checked="" type="checkbox"/>	<input type="checkbox"/>	<input type="checkbox"/>	<input type="checkbox"/>	max. 732 MHz
§2.1051	Spurious emissions at antenna terminals	Nominal	Nominal	<input type="checkbox"/>	<input type="checkbox"/>	<input checked="" type="checkbox"/>	<input type="checkbox"/>	see note
§2.1053 §95.3379 (a)(1) §95.3379 (a)(2) §95.3379 (a)(3) RSS-251 (5.3)	Field strength of emissions (radiated spurious)	Nominal	Nominal	<input checked="" type="checkbox"/>	<input type="checkbox"/>	<input type="checkbox"/>	<input type="checkbox"/>	complies
§2.1055 §95.3379 (b) RSS-251 (5.4)	Frequency stability	Nominal and Extreme	Nominal and Extreme	<input checked="" type="checkbox"/>	<input type="checkbox"/>	<input type="checkbox"/>	<input type="checkbox"/>	complies

Note: NA = Not Applicable; NP = Not Performed

See FCC's Millimeter Wave Test Procedures:

I. A radiated method of measurements in order to demonstrate compliance with the various regulatory requirements has been chosen in consideration of test equipment availability and the limitations of many external harmonic mixers. A conducted method of measurement could be employed if EUT and mixer waveguides both are accessible and of the same type (WG number) and if waveguide sections and transitions can be found. Another potential problem is that the peak power output of devices operating under Sections 15.253 and 15.255 may exceed the +20 dBm input power limit of many commercially available mixers. For these reasons a radiated method is preferred.

9 Measurement results

9.1 Power density

Description:

The fundamental radiated emission limits within the 76-81 GHz band are expressed in terms of Equivalent Isotropically Radiated Power (EIRP) and are as shown below.

Limits:

FCC §95.3367 (a) (b)

Frequency	Measurement distance	Power Density → EIRP
76.0 - 81.0 GHz	3.0 m	88 $\mu\text{W}/\text{cm}^2$ → 50 dBm (Average) 279 $\mu\text{W}/\text{cm}^2$ → 55 dBm (PEAK)

Limits:

RSS-251 (5.2.2)

Frequency	Measurement distance	Power Density → EIRP
76.0 - 77.0 GHz	3.0 m	88 $\mu\text{W}/\text{cm}^2$ → 50 dBm (Average) 279 $\mu\text{W}/\text{cm}^2$ → 55 dBm (PEAK)

Test results:

Operating condition	Test conditions	Peak EIRP	Channel Power Mean EIRP
Mode 1: 200 MHz mode	T_{nom} / V_{nom}	30.89	24.90
	T_{nom} / V_{nom}	31.23	25.75
	T_{nom} / V_{nom}	29.91	23.81
Mode 2: 400 MHz mode	T_{nom} / V_{nom}	30.94	19.65
	T_{nom} / V_{nom}	31.15	21.04
	T_{nom} / V_{nom}	30.35	18.57
Mode 3: 700 MHz mode	T_{nom} / V_{nom}	31.11	19.86
	T_{nom} / V_{nom}	31.44	20.08
	T_{nom} / V_{nom}	30.58	17.04

Operating condition	Test conditions	Peak EIRP	Mean EIRP
Low Channel	T_{nom} / V_{nom}	31.19	28.83
	T_{nom} / V_{nom}	31.31	27.53
	T_{nom} / V_{nom}	31.11	28.38
Middle Channel	T_{nom} / V_{nom}	30.78	28.15
	T_{nom} / V_{nom}	30.90	26.81
	T_{nom} / V_{nom}	30.80	28.16
High Channel	T_{nom} / V_{nom}	30.16	26.47
	T_{nom} / V_{nom}	30.36	27.59
	T_{nom} / V_{nom}	29.90	26.71

Plot 1: 200 MHz mode, RMS detector, T_{nom} / V_{nom}

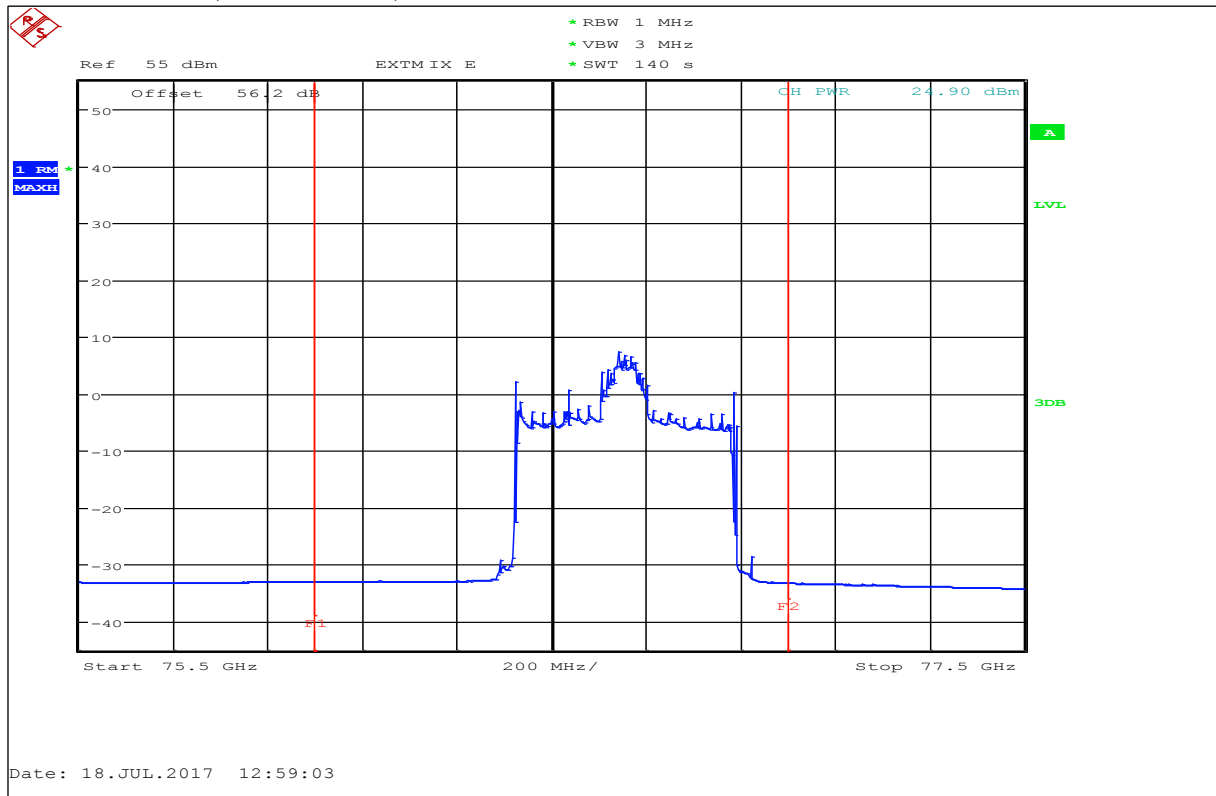

F1=76 GHz / F2=77 GHz

Plot 2: 200 MHz mode, Peak detector, T_{nom} / V_{nom}

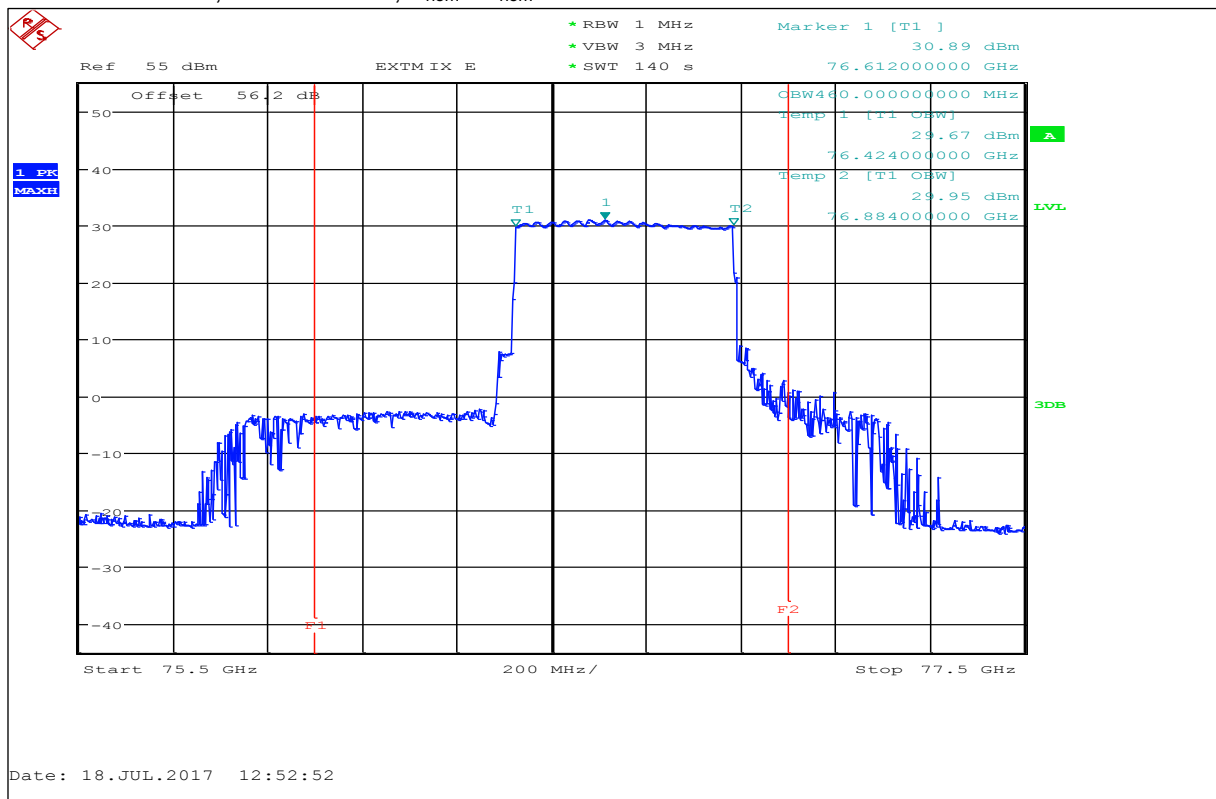

F1=76 GHz / F2=77 GHz

Plot 3: 200 MHz mode, RMS detector, $T_{min} / V_{min} - V_{max}$

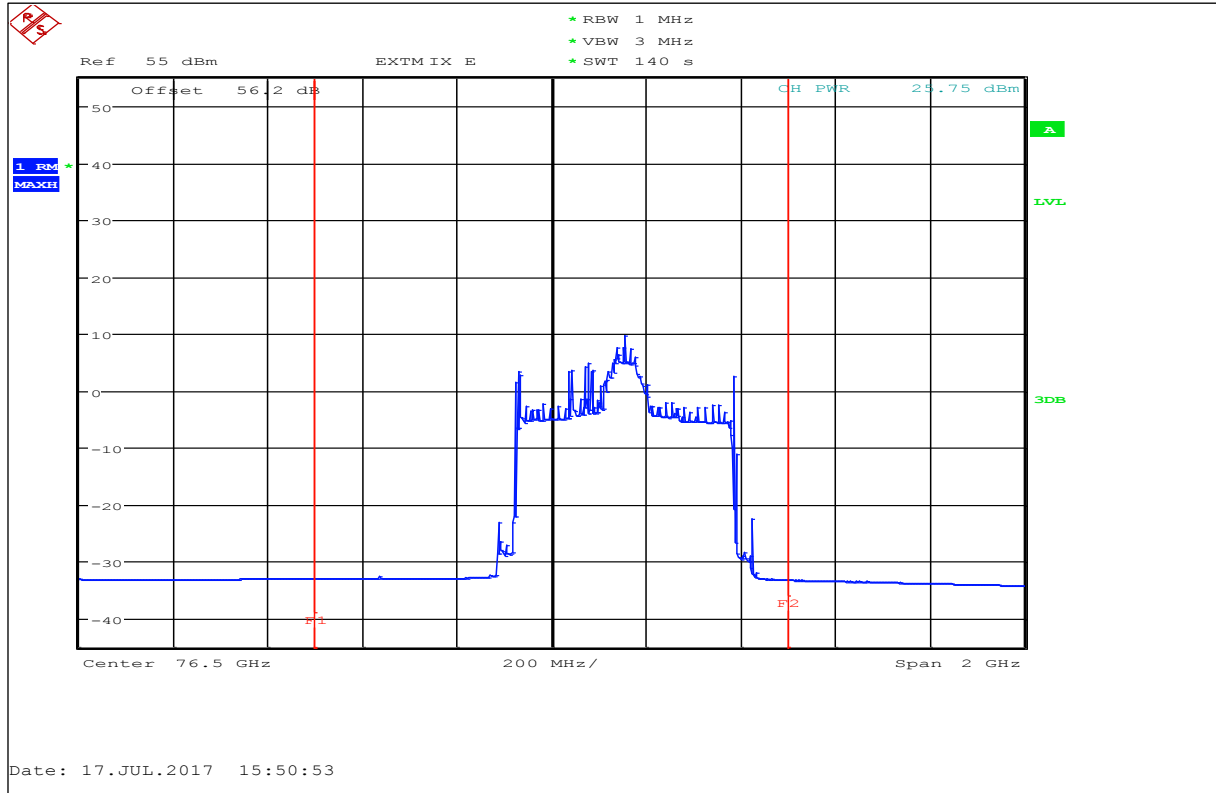

F1=76 GHz / F2=77 GHz

Plot 4: 200 MHz mode, Peak detector, $T_{min} / V_{min} - V_{max}$

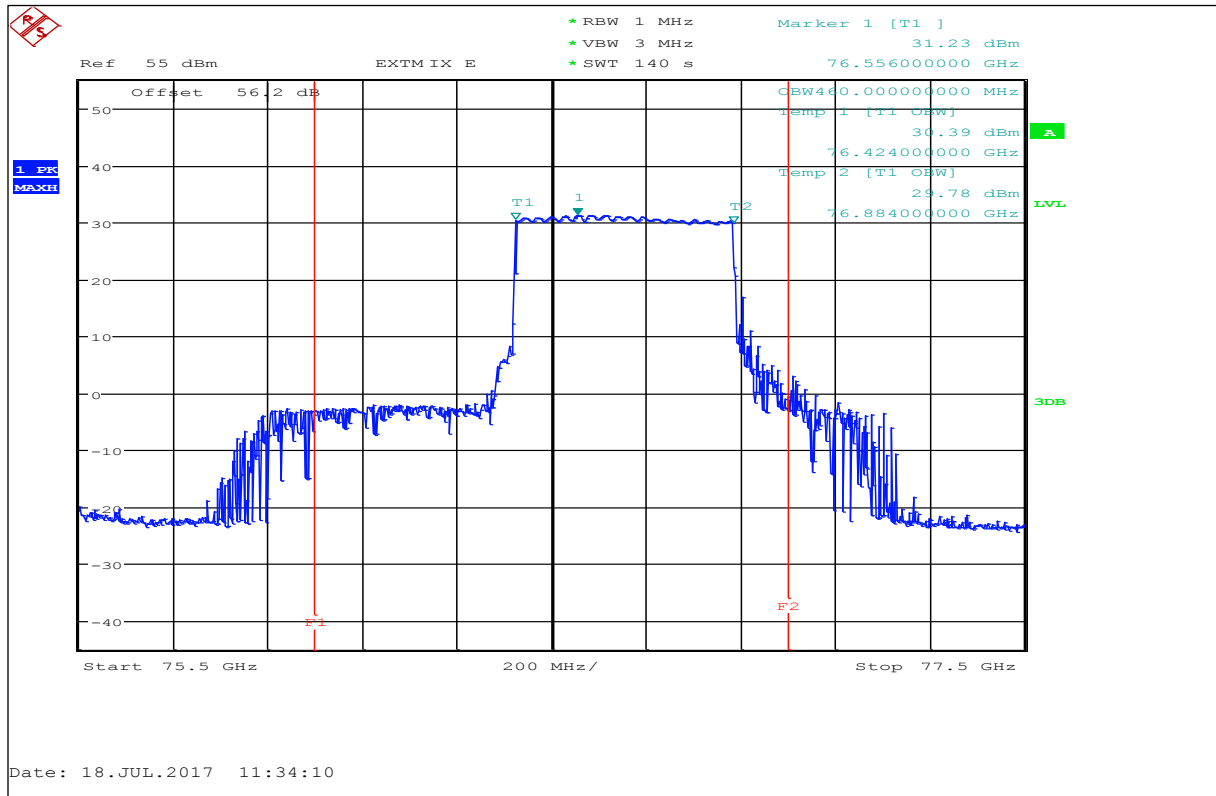

F1=76 GHz / F2=77 GHz

Plot 5: 200 MHz mode, RMS detector, $T_{max} / V_{min} - V_{max}$

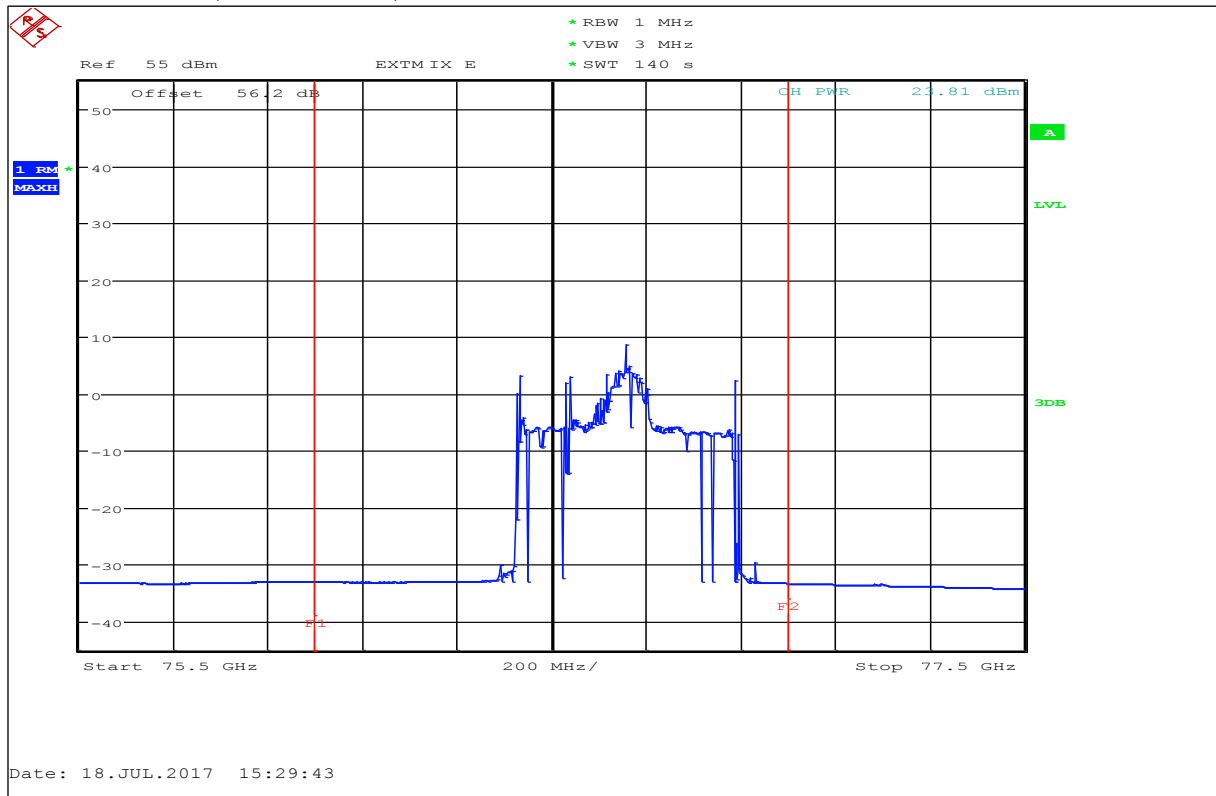

F1=76 GHz / F2=77 GHz

Plot 6: 200 MHz mode, Peak detector, $T_{max} / V_{min} - V_{max}$

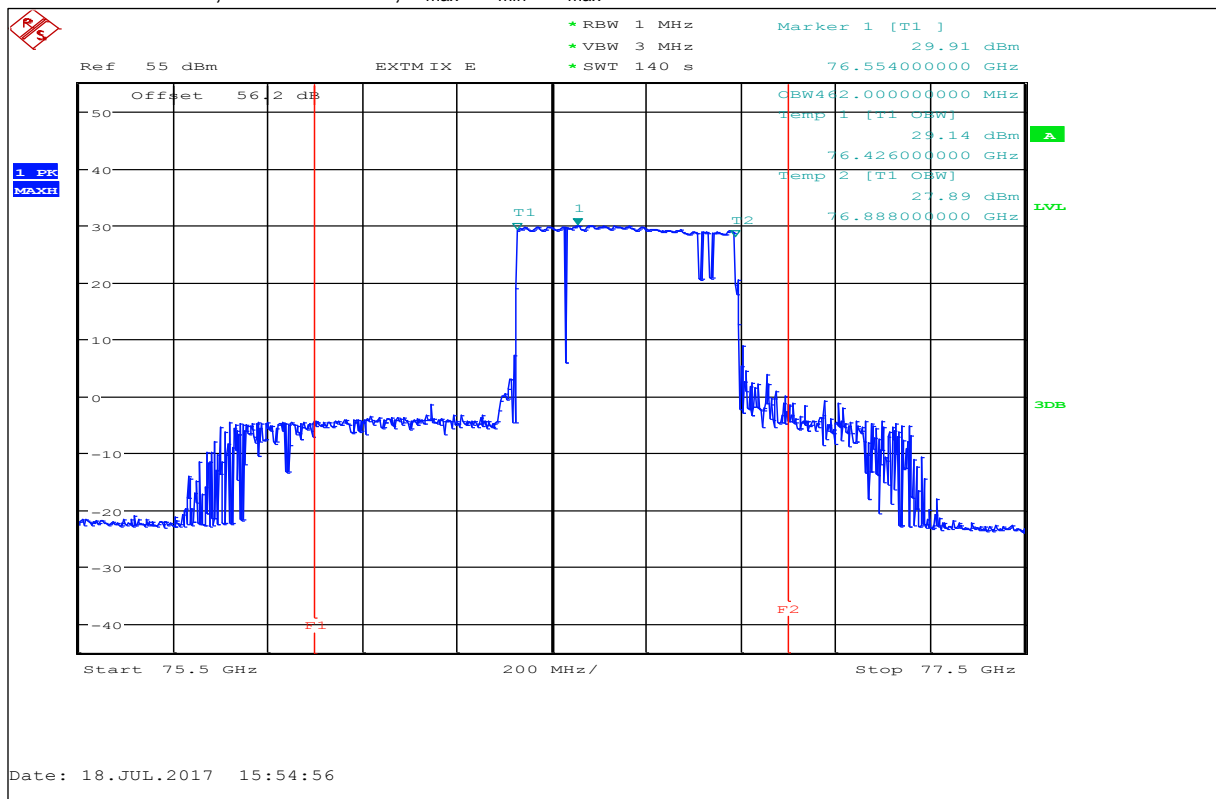

F1=76 GHz / F2=77 GHz

Plot 7: 400 MHz mode, RMS detector, T_{nom} / V_{nom}

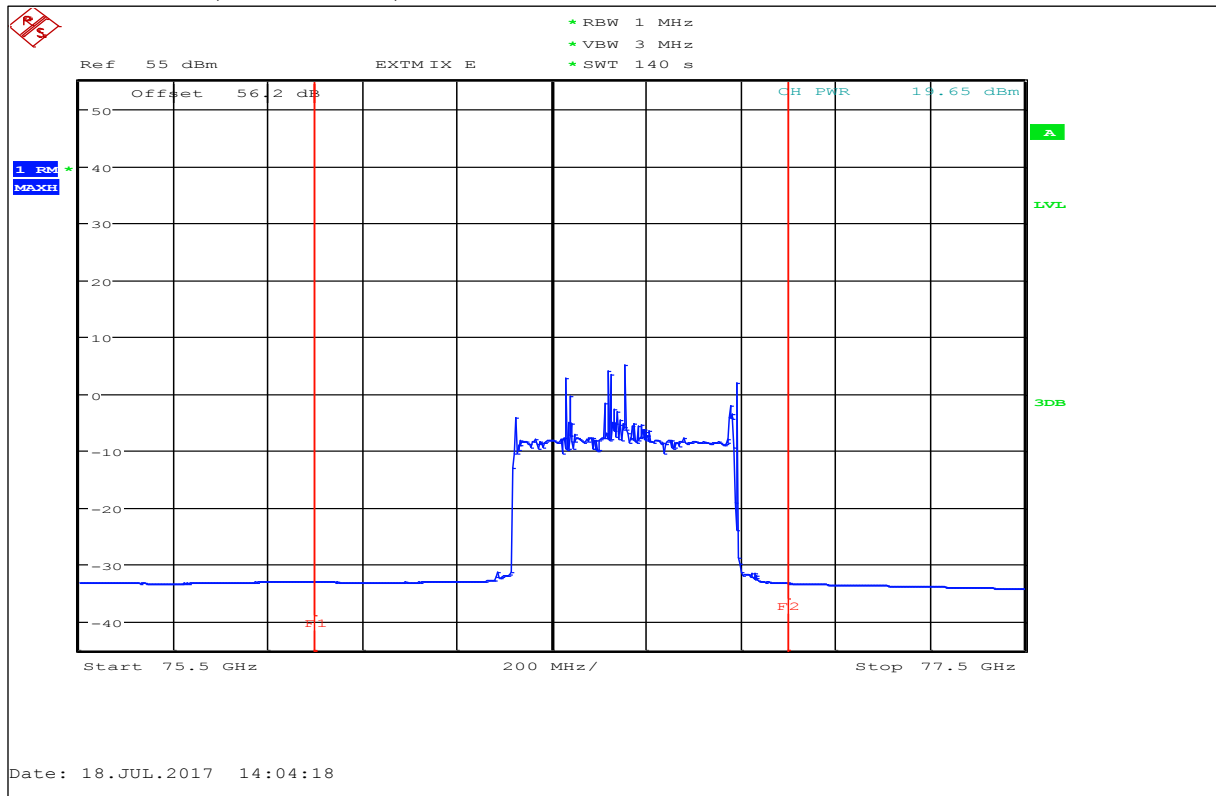

F1=76 GHz / F2=77 GHz

Plot 8: 400 MHz mode, Peak detector, T_{nom} / V_{nom}

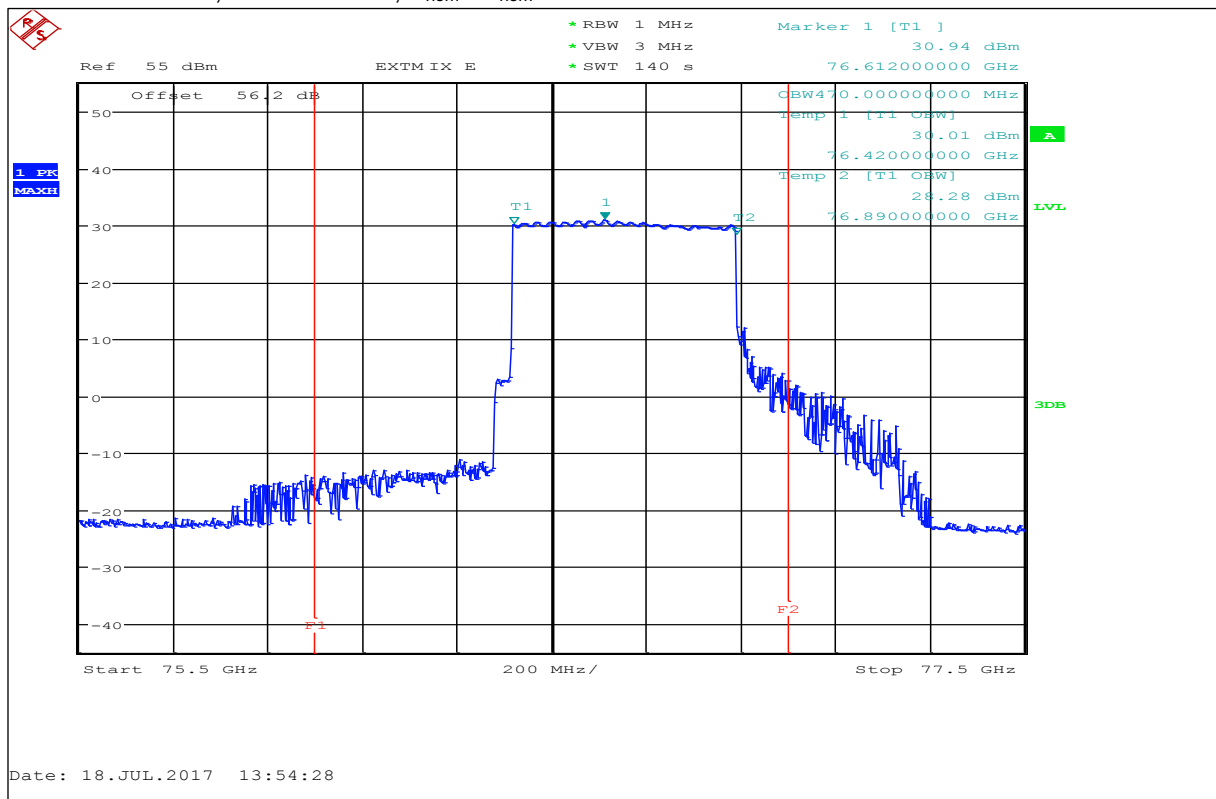

F1=76 GHz / F2=77 GHz

Plot 9: 400 MHz mode, RMS detector, $T_{min} / V_{min} - V_{max}$

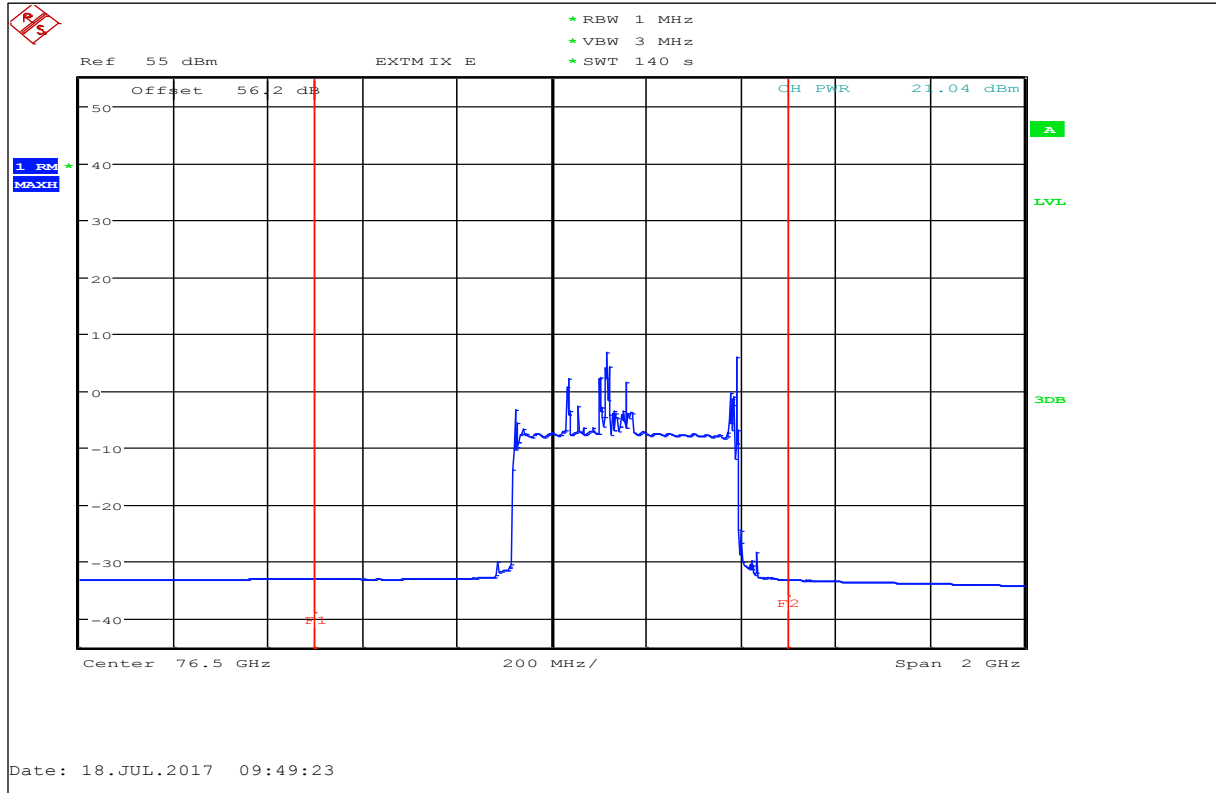

F1=76 GHz / F2=77 GHz

Plot 10: 400 MHz mode, Peak detector, $T_{min} / V_{min} - V_{max}$

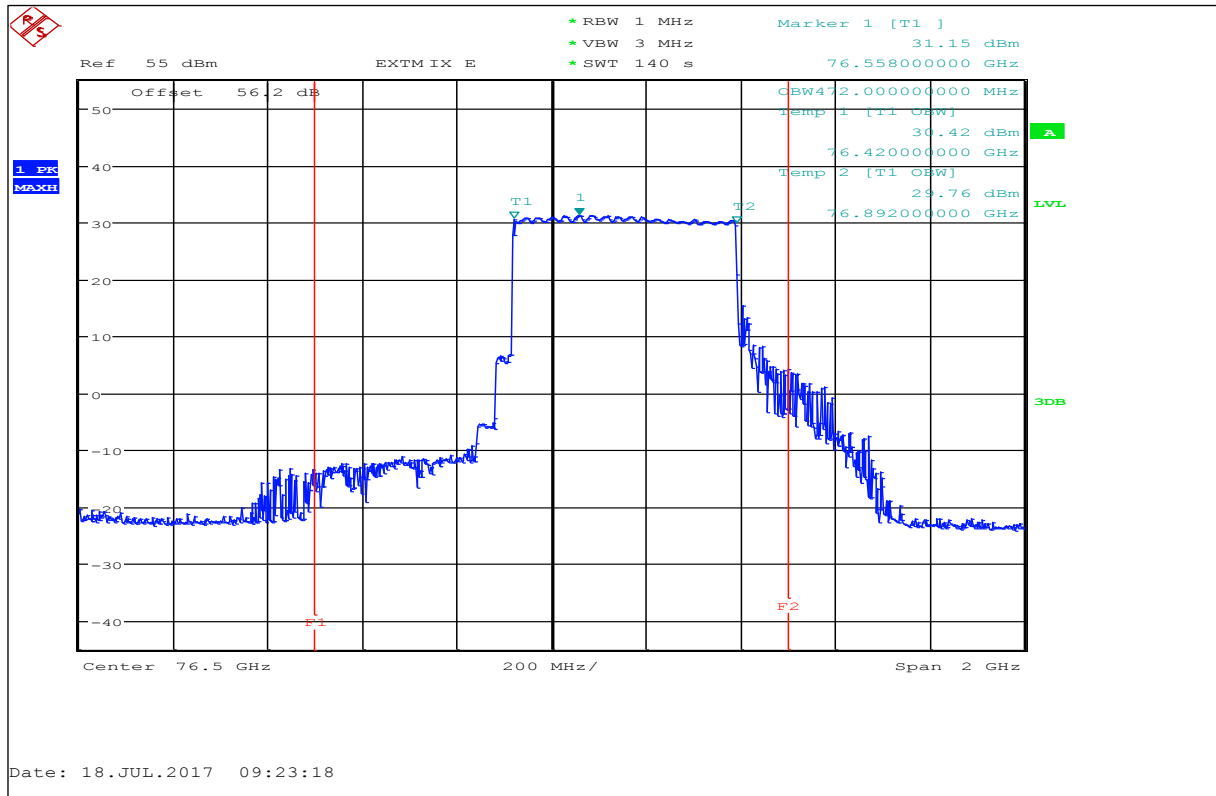

F1=76 GHz / F2=77 GHz

Plot 11: 400 MHz mode, RMS detector, $T_{max} / V_{min} - V_{max}$

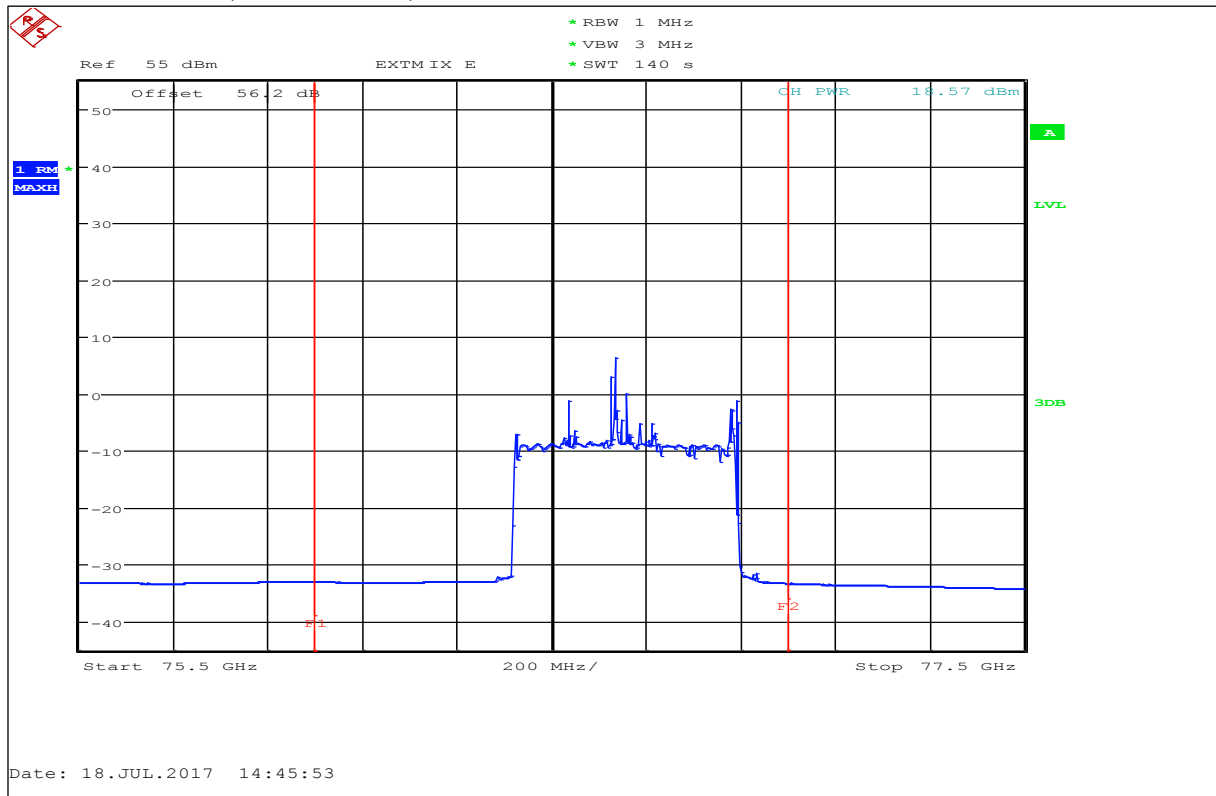

F1=76 GHz / F2=77 GHz

Plot 12: 400 MHz mode, Peak detector, $T_{max} / V_{min} - V_{max}$

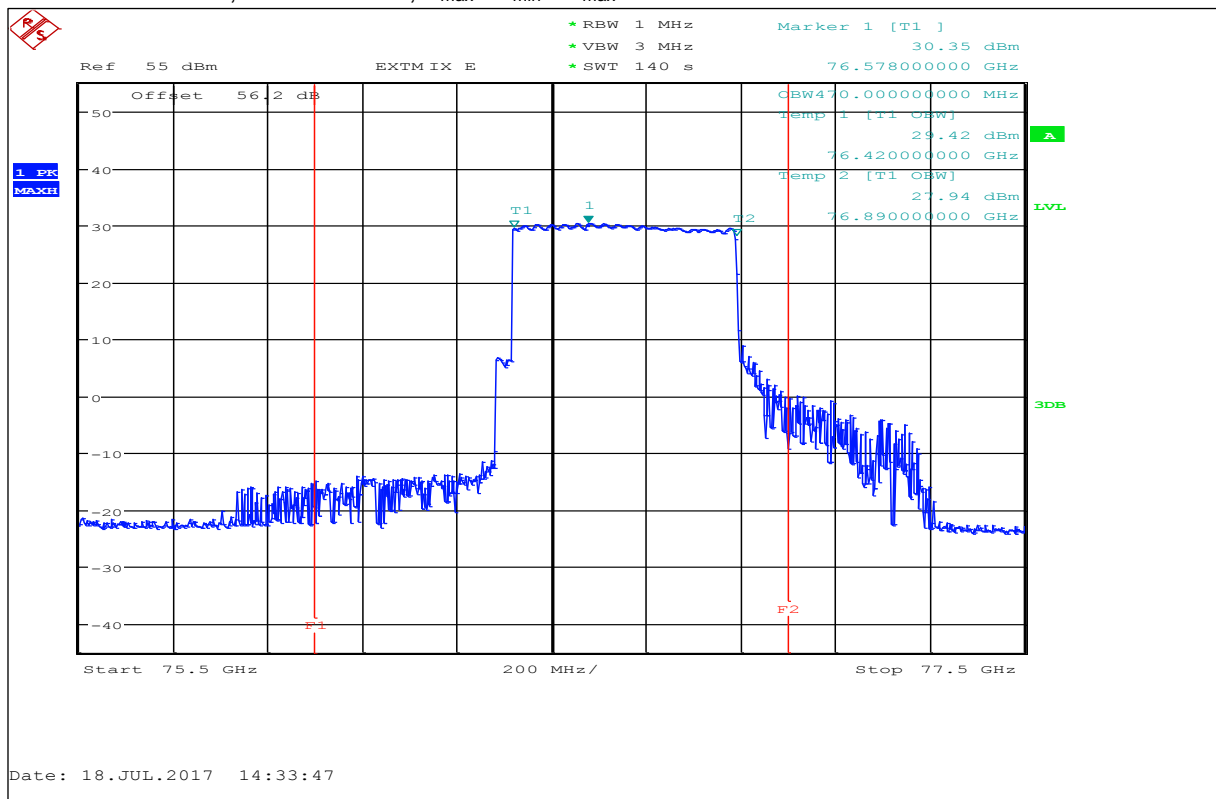

F1=76 GHz / F2=77 GHz

Plot 13: 700 MHz mode, RMS detector, T_{nom} / V_{nom}

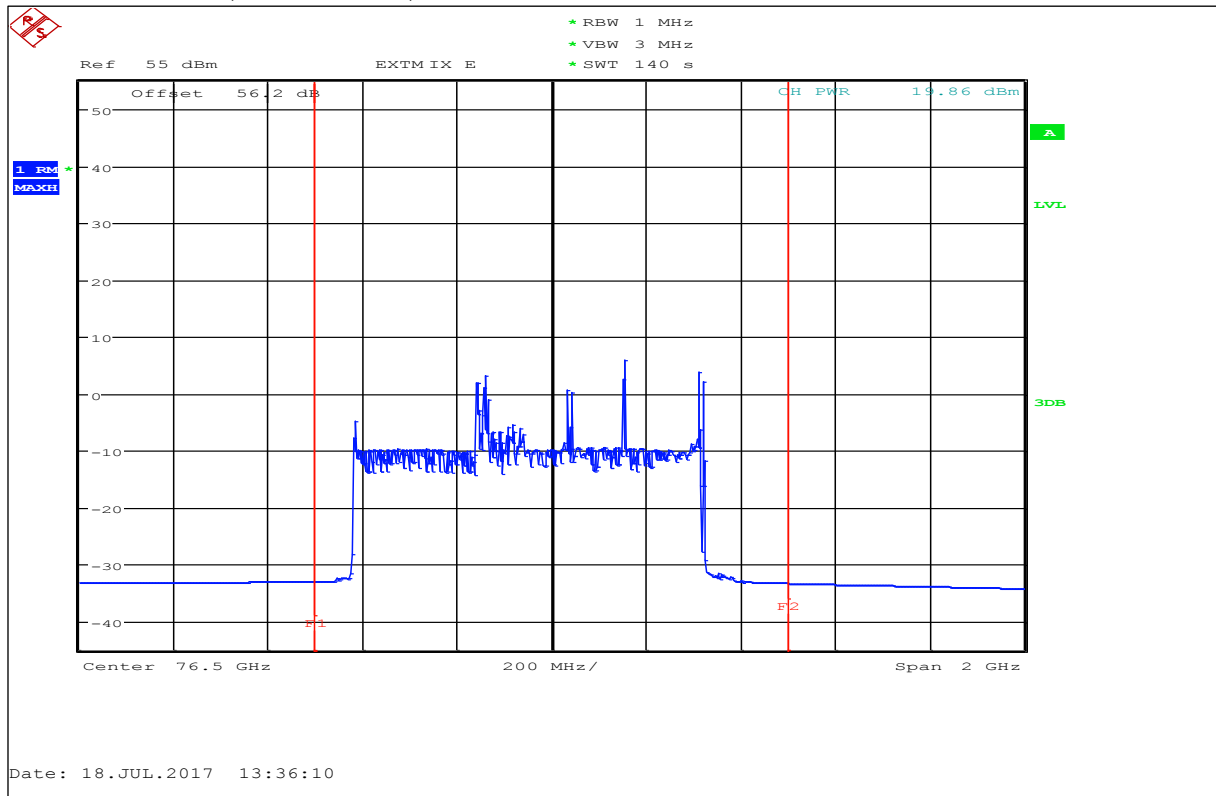

F1=76 GHz / F2=77 GHz

Plot 14: 700 MHz mode, Peak detector, T_{nom} / V_{nom}

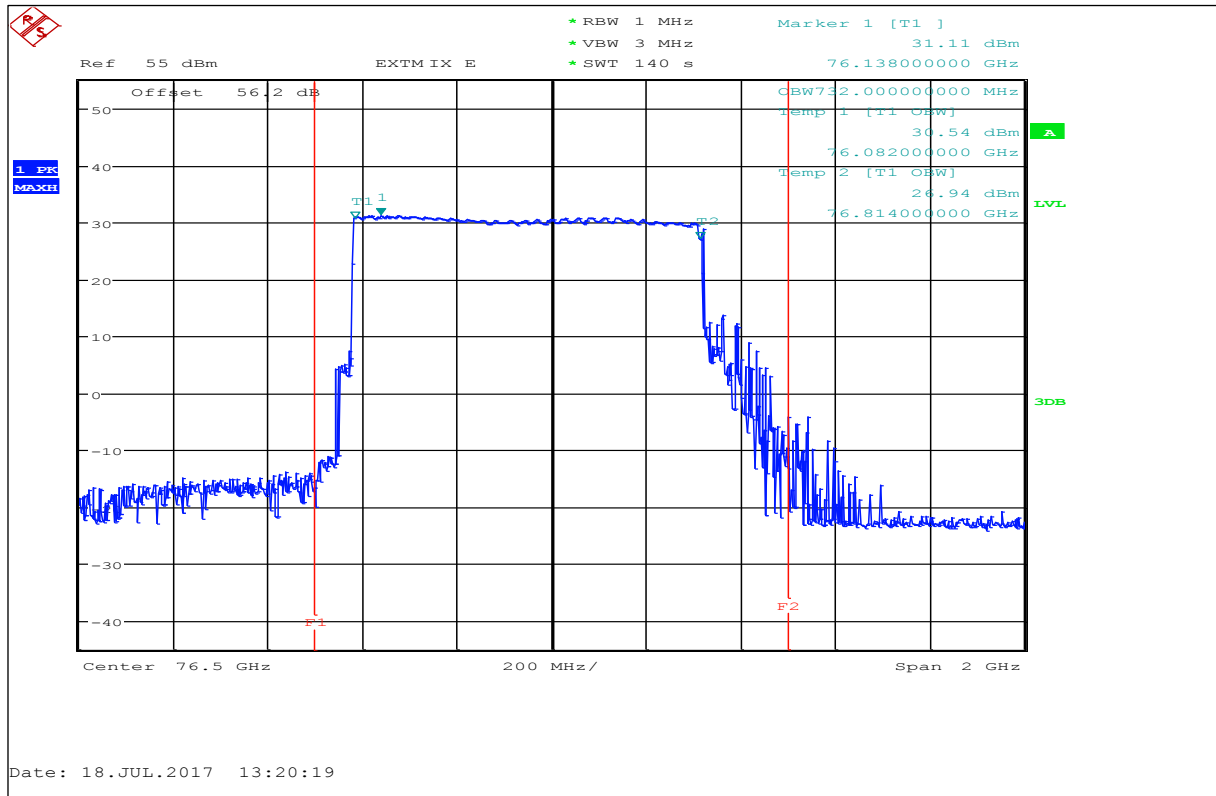

F1=76 GHz / F2=77 GHz

Plot 15: 700 MHz mode, RMS detector, $T_{min} / V_{min} - V_{max}$

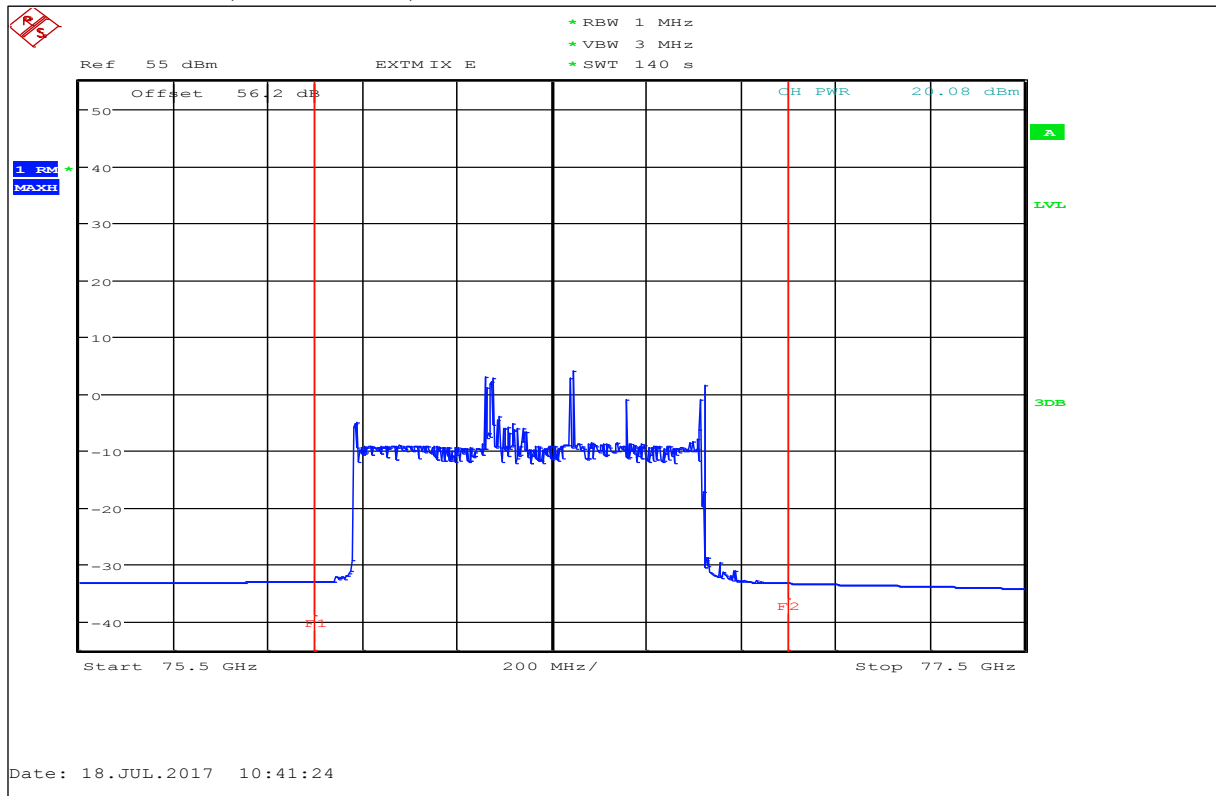

F1=76 GHz / F2=77 GHz

Plot 16: 700 MHz mode, Peak detector, $T_{min} / V_{min} - V_{max}$

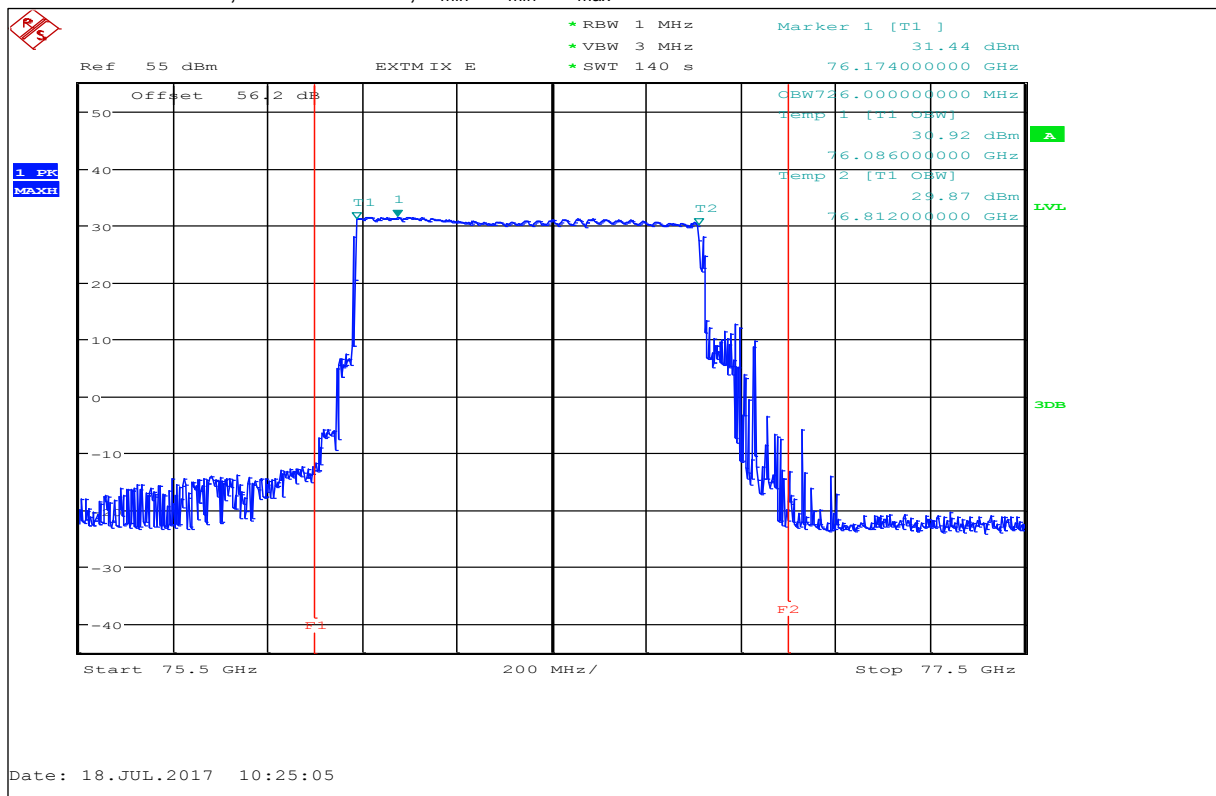

F1=76 GHz / F2=77 GHz

Plot 17: 700 MHz mode, RMS detector, $T_{max} / V_{min} - V_{max}$

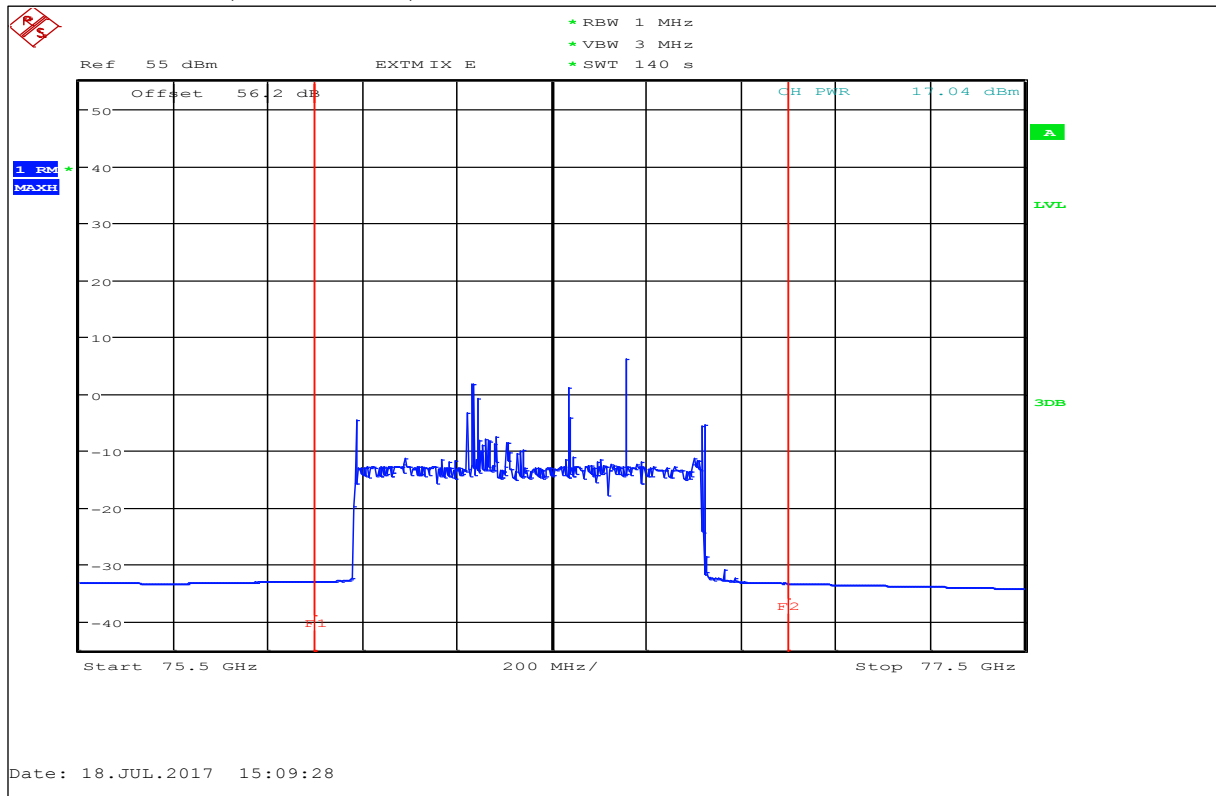

F1=76 GHz / F2=77 GHz

Plot 18: 700 MHz mode, Peak detector, $T_{max} / V_{min} - V_{max}$

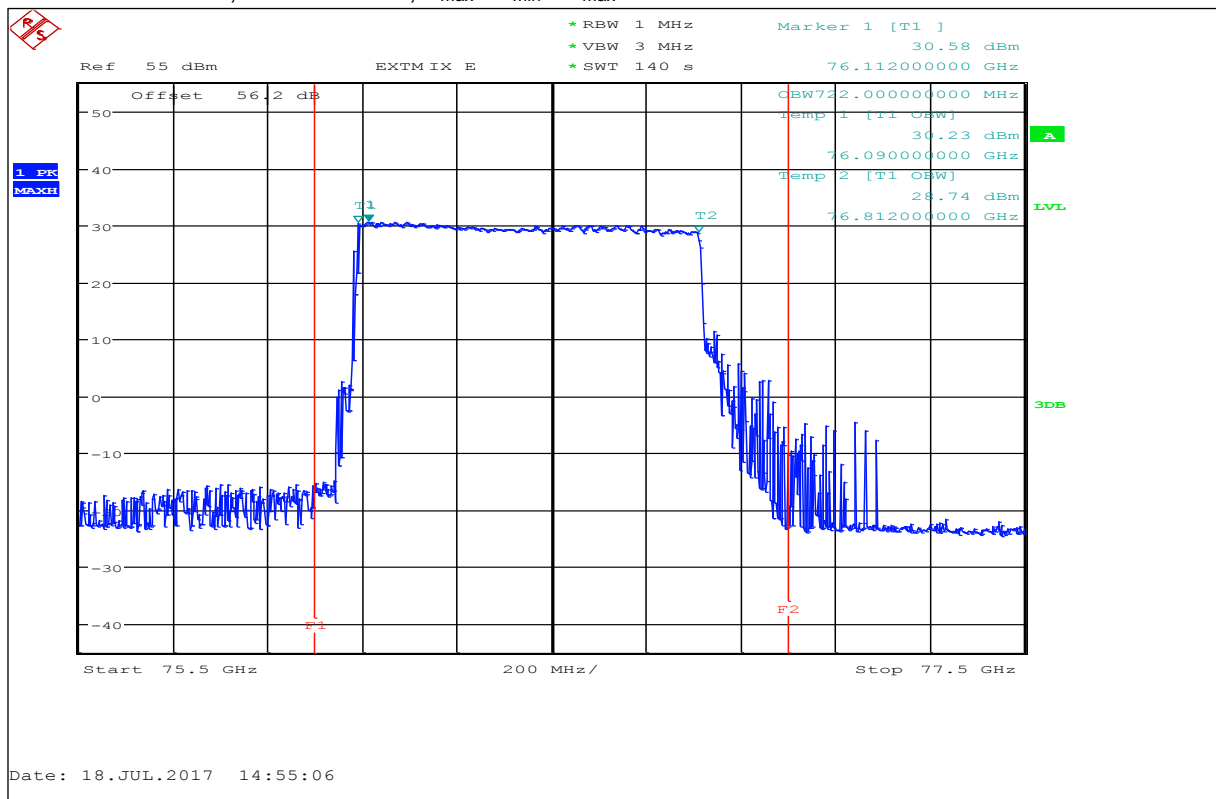

F1=76 GHz / F2=77 GHz

Plot 19: Low, Middle and High Channel, RMS detector, T_{nom} / V_{nom}

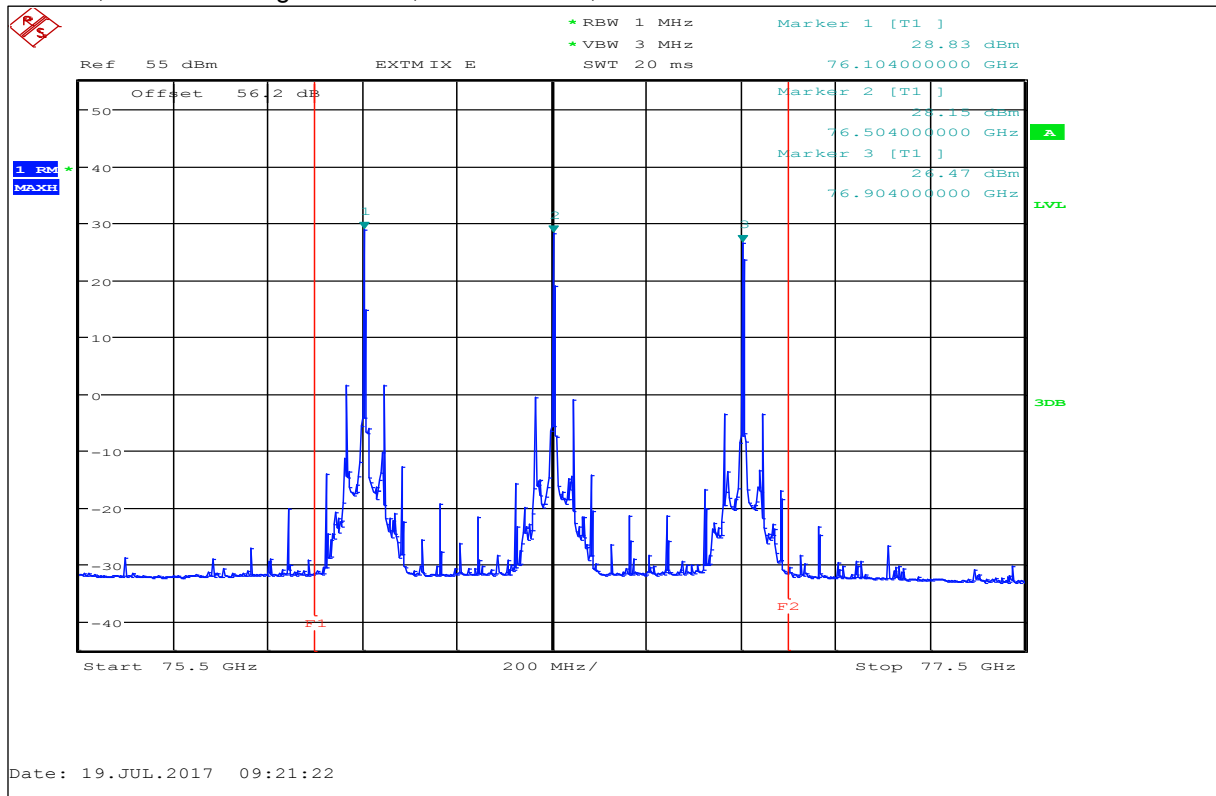

F1=76 GHz / F2=77 GHz

Plot 20: Low, Middle and High Channel, Peak detector, T_{nom} / V_{nom}

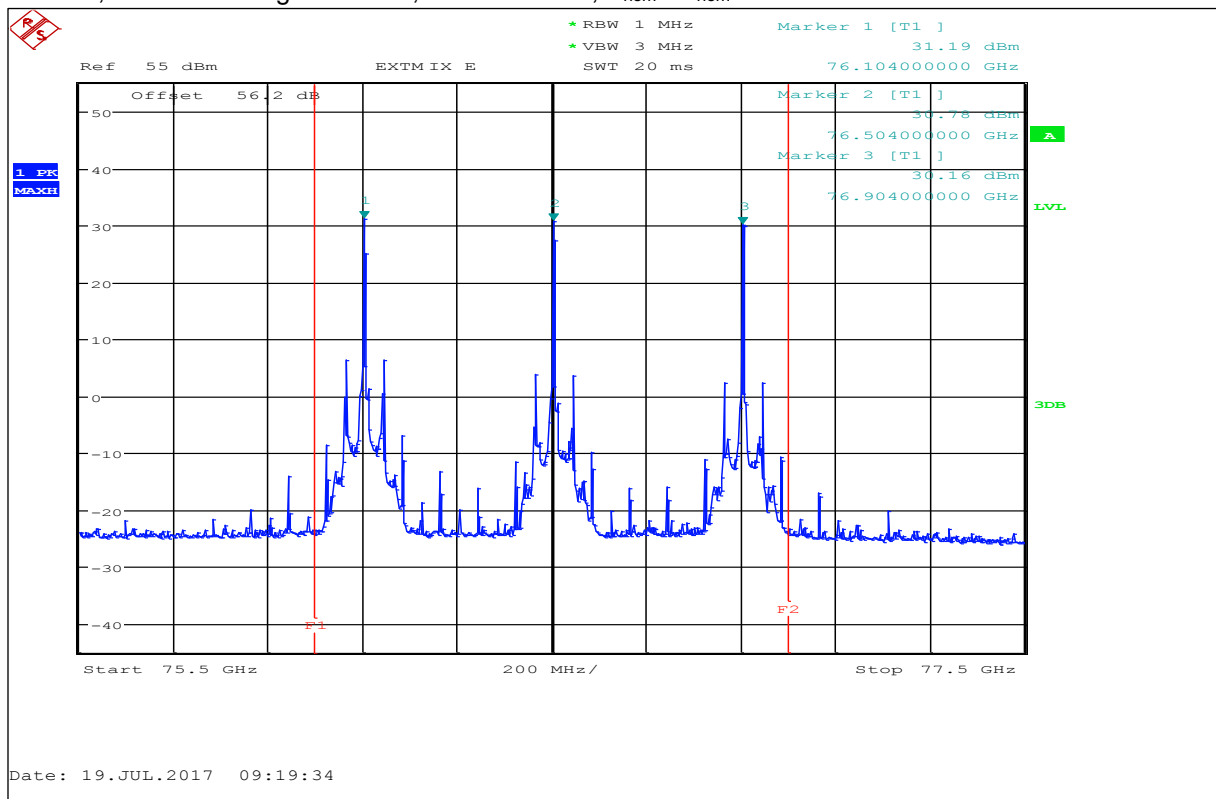

F1=76 GHz / F2=77 GHz

Plot 21: Low, Middle and High Channel, RMS detector, $T_{min} / V_{min} - V_{max}$

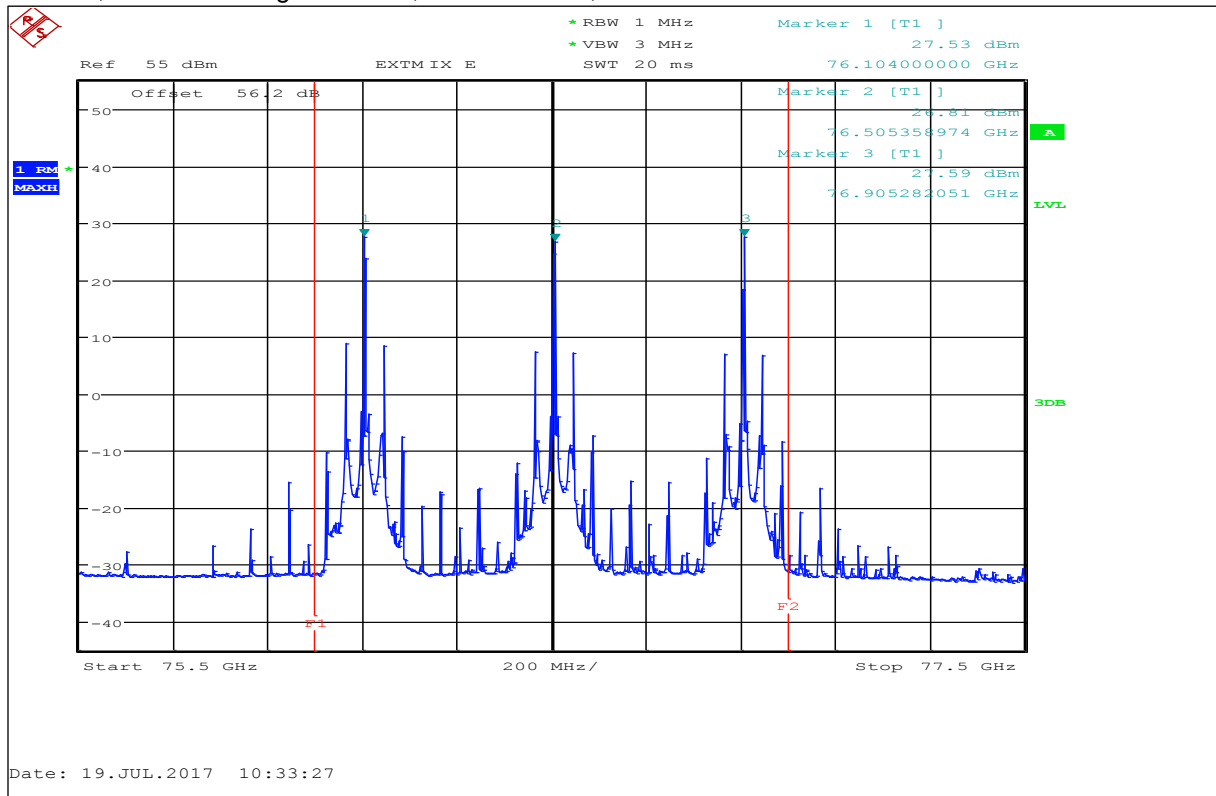

F1=76 GHz / F2=77 GHz

Plot 22: Low, Middle and High Channel, Peak detector, $T_{min} / V_{min} - V_{max}$

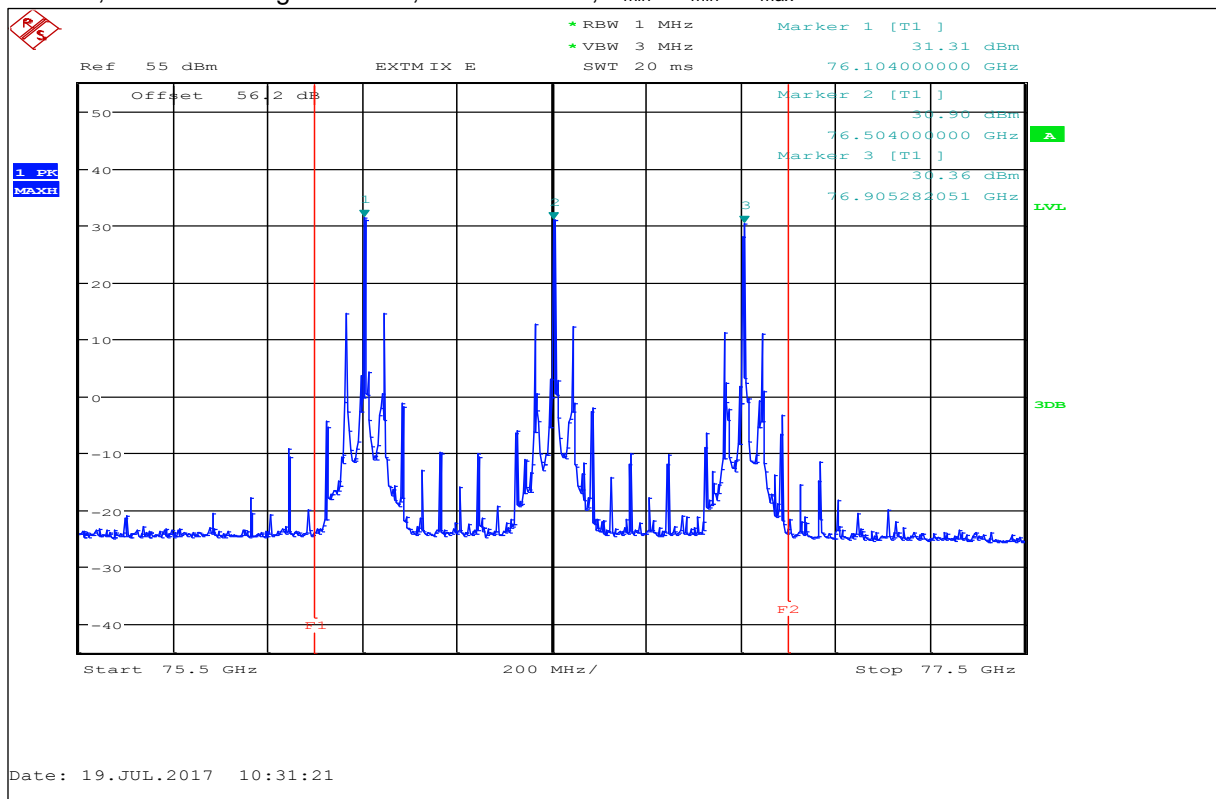

F1=76 GHz / F2=77 GHz

Plot 23: Low, Middle and High Channel, RMS detector, $T_{max} / V_{min} - V_{max}$

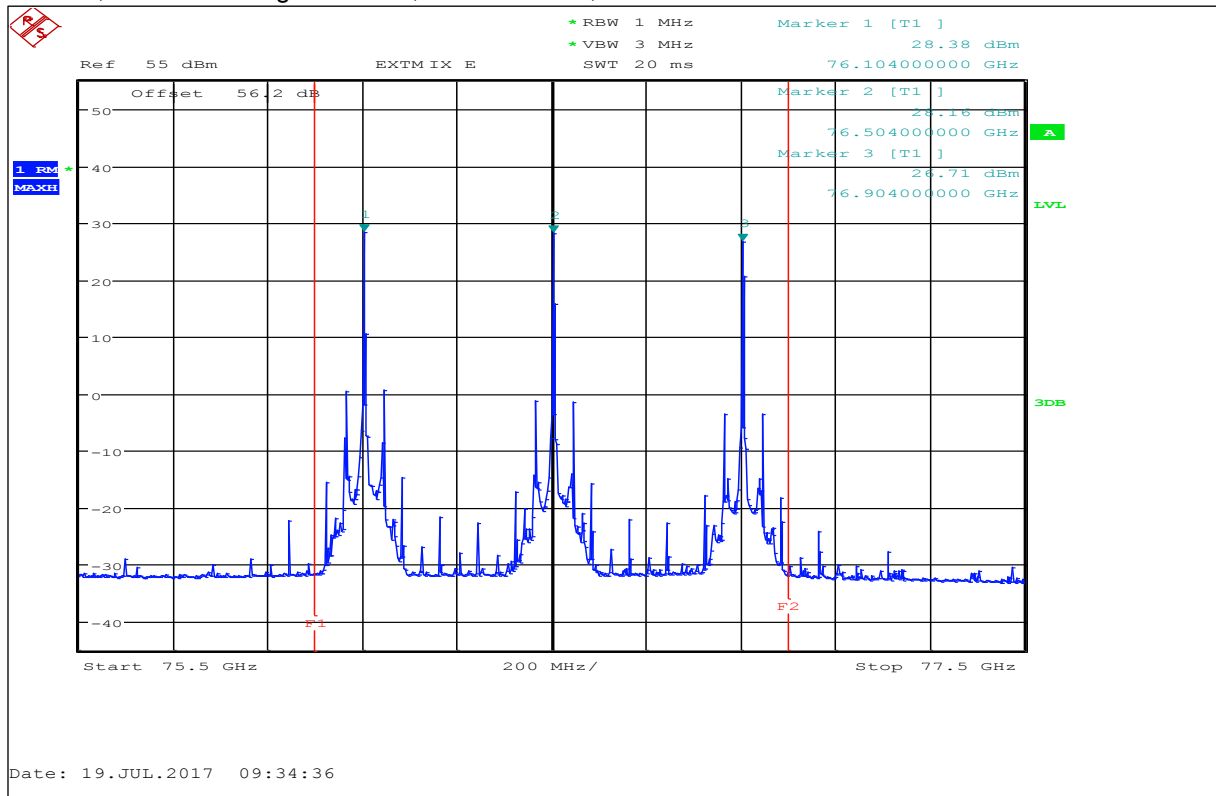

F1=76 GHz / F2=77 GHz

Plot 24: Low, Middle and High Channel, Peak detector, $T_{max} / V_{min} - V_{max}$

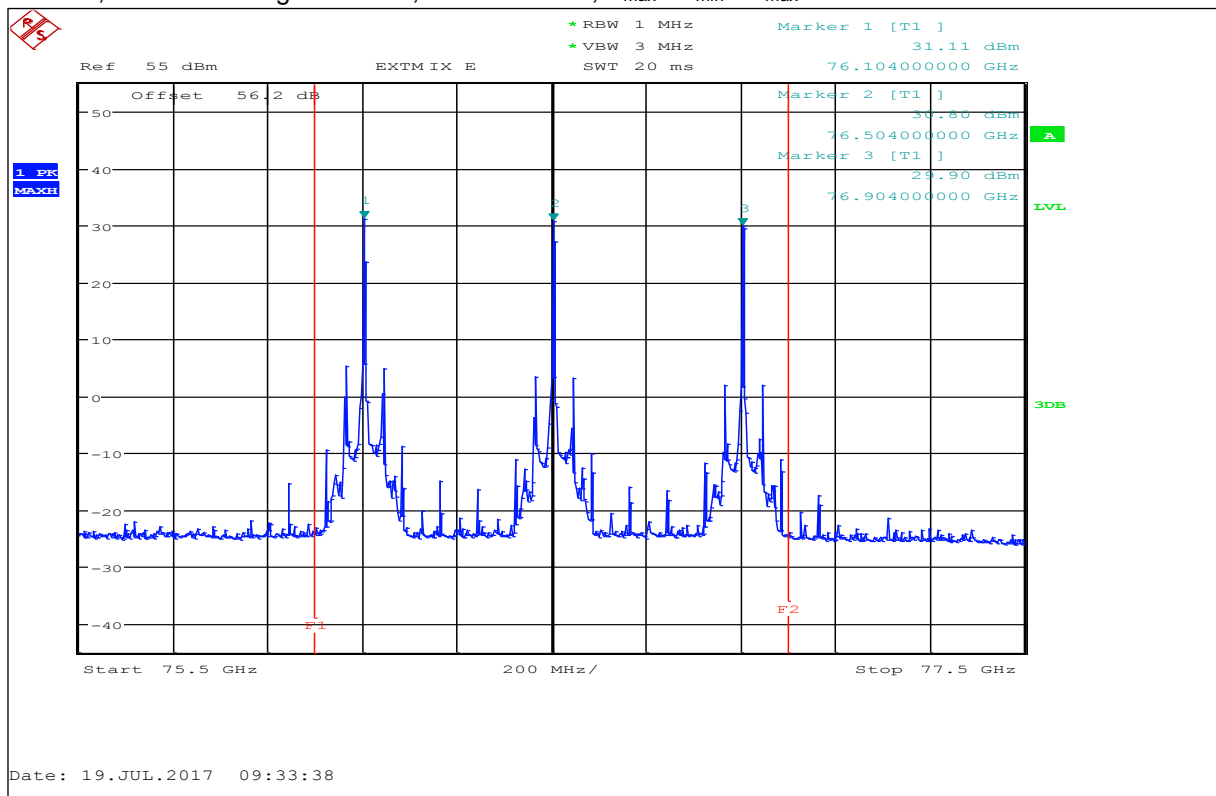

F1=76 GHz / F2=77 GHz

9.2 Modulation characteristics

Description:

§2.1047 (d) *Other types of equipment.* A curve or equivalent data which shows that the equipment will meet the modulation requirements of the rules under which the equipment is to be licensed.

Measurement results:

FMCW is mainly characterized by start and stop frequency resp. the occupied bandwidth.

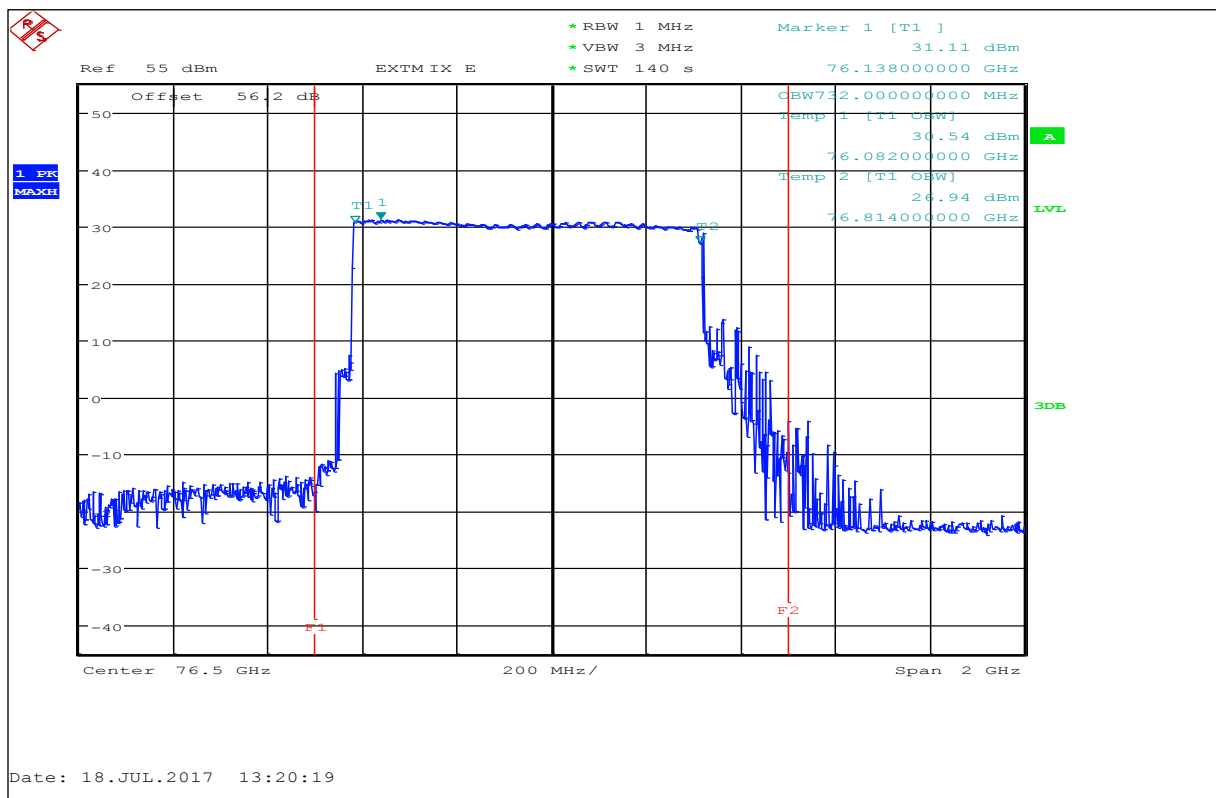

9.3 Occupied bandwidth

Description:

§2.1049 The occupied bandwidth, that is the frequency bandwidth such that, below its lower and above its upper frequency limits, the mean powers radiated are each equal to 0.5 percent of the total mean power radiated by a given emission.

Limits:

FCC §95.3379 (b)

Frequency range	f(lowest) > 76.0 GHz	f(highest) < 81.0 GHz
-----------------	----------------------	-----------------------

Limits:

RSS-251 (5.2.2) / (5.4)

Frequency range	f(lowest) > 76.0 GHz	f(highest) < 77.0 GHz
-----------------	----------------------	-----------------------

Results:

Operating condition	Test conditions	Occupied Bandwidth
Mode 1: 200 MHz mode	T_{nom} / V_{nom}	460 MHz
	T_{nom} / V_{nom}	460 MHz
	T_{nom} / V_{nom}	462 MHz
Mode 2: 400 MHz mode	T_{nom} / V_{nom}	470 MHz
	T_{nom} / V_{nom}	472 MHz
	T_{nom} / V_{nom}	470 MHz
Mode 3: 700 MHz mode	T_{nom} / V_{nom}	732 MHz
	T_{nom} / V_{nom}	726 MHz
	T_{nom} / V_{nom}	722 MHz

9.4 Field strength of emissions (band edge)

Limits: FCC §95.3379 (a) (2) (i) + (ii) / ANSI C63.10-2013 / 6.10

Frequency Range [GHz]	Measurement distance	Power Density
40 – 200	3.0 m	600 pW/cm ² → -1.7 dBm

Limits: FCC §95.3379 (b)

Frequency range	f(lowest) > 76.0 GHz	f(highest) < 81.0 GHz
-----------------	----------------------	-----------------------

Limits: RSS-251 (5.2.2)

Frequency range	f(lowest) > 76.0 GHz	f(highest) < 77.0 GHz
-----------------	----------------------	-----------------------

Plot 25: Low Band Edge (F<76 GHz)

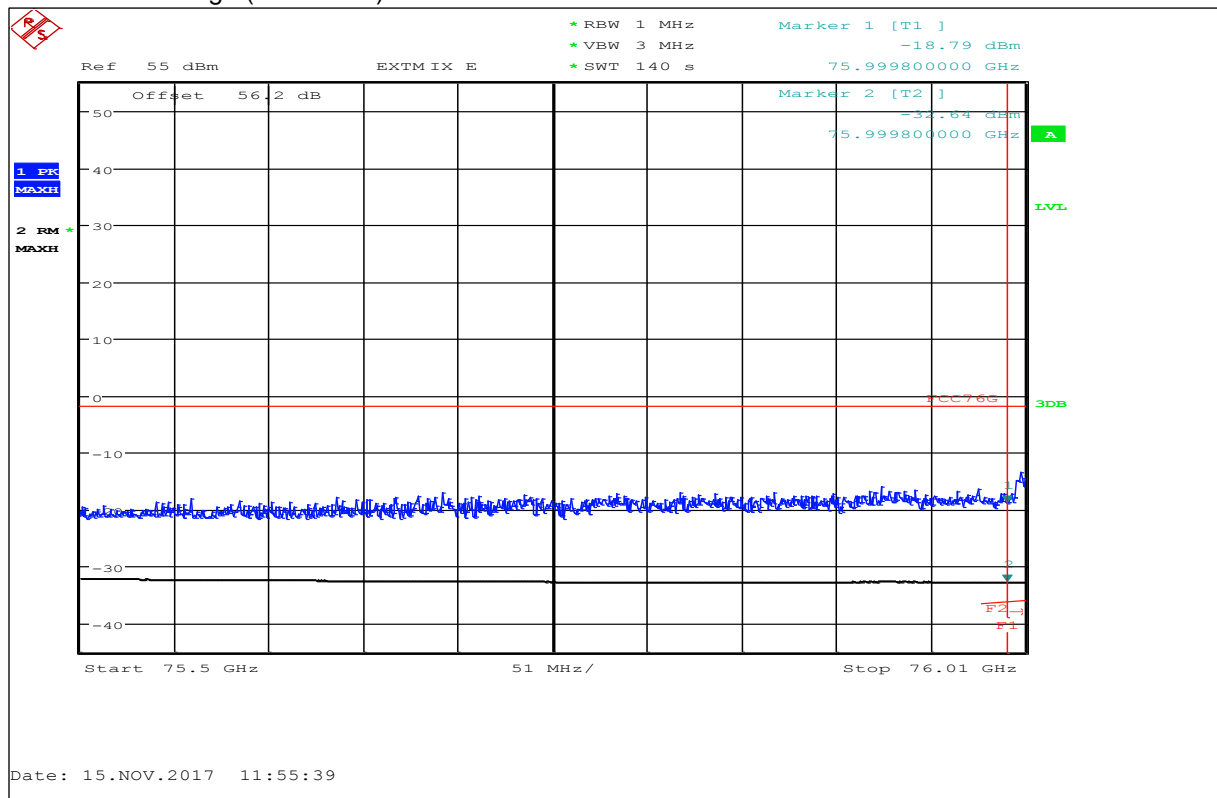

F1=76 GHz

Plot 26: High Band Edge (F>77 GHz)

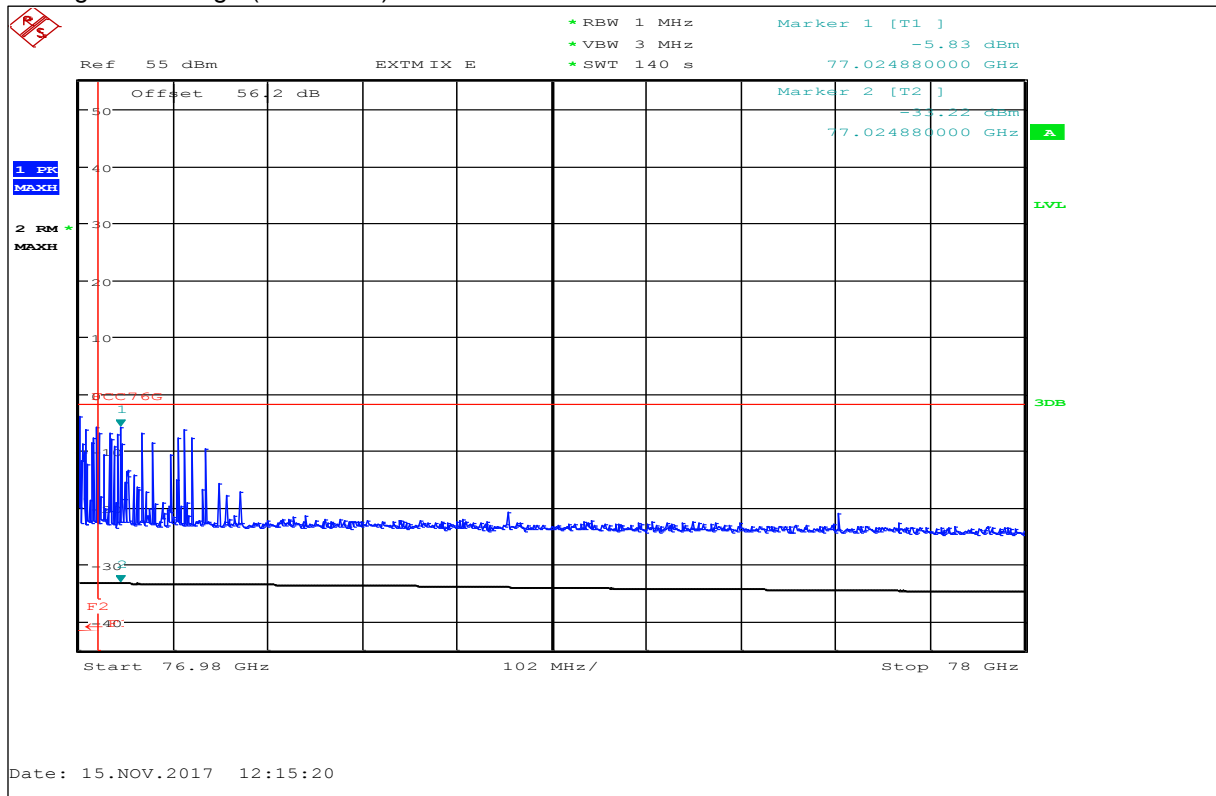

F2=77 GHz

Plot 27: High Band Edge (F>81 GHz)

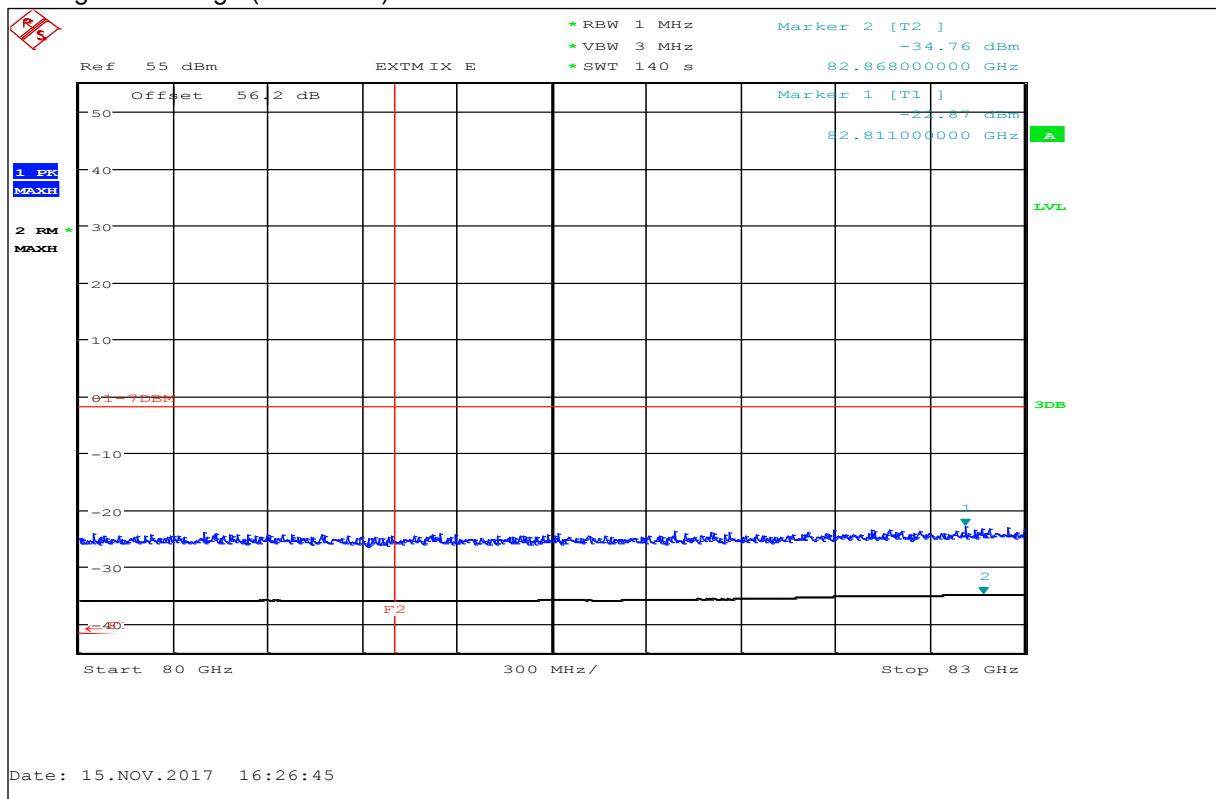

F2=81 GHz

9.5 Field strength of emissions (radiated spurious)

Description:

Measurement of the radiated spurious emissions in transmit mode.

Limits:

FCC §95.3379

FCC		
CFR Part 95.3379 (a) (1) / CFR Part 95.3379 (a) (3)		
Radiated Spurious Emissions		
Emissions radiated outside of the specified frequency bands, except for harmonics, shall be attenuated by at least 50 dB below the level of the fundamental or to the general radiated emission limits in § 15.209, whichever is the lesser attenuation.		
Frequency [MHz]	Field Strength [dBµV/m]	Measurement distance
0.009 – 0.490	2400/F[kHz]	300
0.490 – 1.705	24000/F[kHz]	30
1.705 – 30.0	30	30
30 – 88	30.0	10
88 – 216	33.5	10
216 – 960	36.0	10
960 – 40 000	54.0	3

Limits:

FCC §95.3379 (a) (2) (i) + (ii) / RSS-251 (5.3)

Frequency Range [GHz]	Measurement distance	Power Density
40 – 200	3.0 m	600 pW/cm ² → -1.7 dBm
200 – 231	3.0 m	1000 pW/cm ² → +0.5 dBm

Results:

TX Spurious Emissions Radiated [dBµV/m]								
Low Channel			Middle Channel			High Channel		
F [GHz]	Detector	Level [dBµV/m]	F [GHz]	Detector	Level [dBµV/m]	F [GHz]	Detector	Level [dBµV/m]
See plots			See plots			See plots		
Measurement uncertainty			± 3 dB					

Plot 28: 9 kHz – 30 MHz, Magnetic antenna (Low Channel)

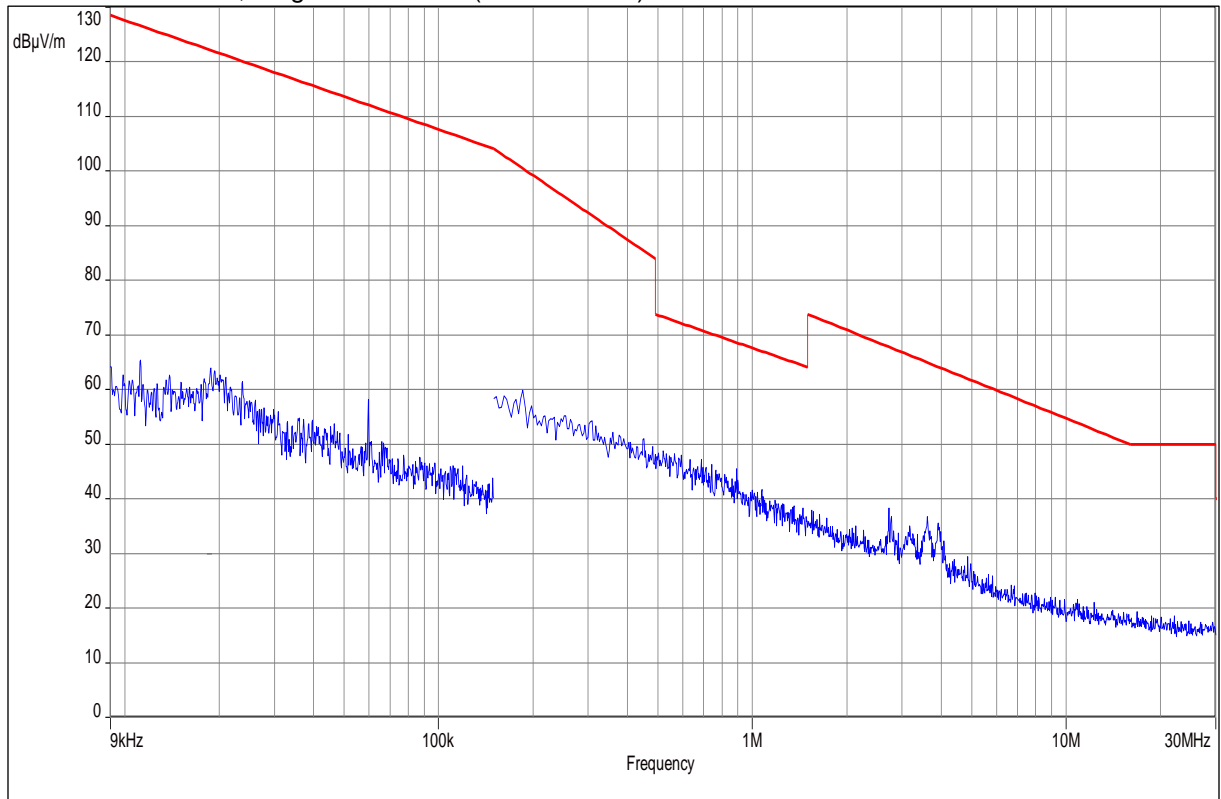

Plot 29: 9 kHz – 30 MHz, Magnetic antenna (Middle Channel)

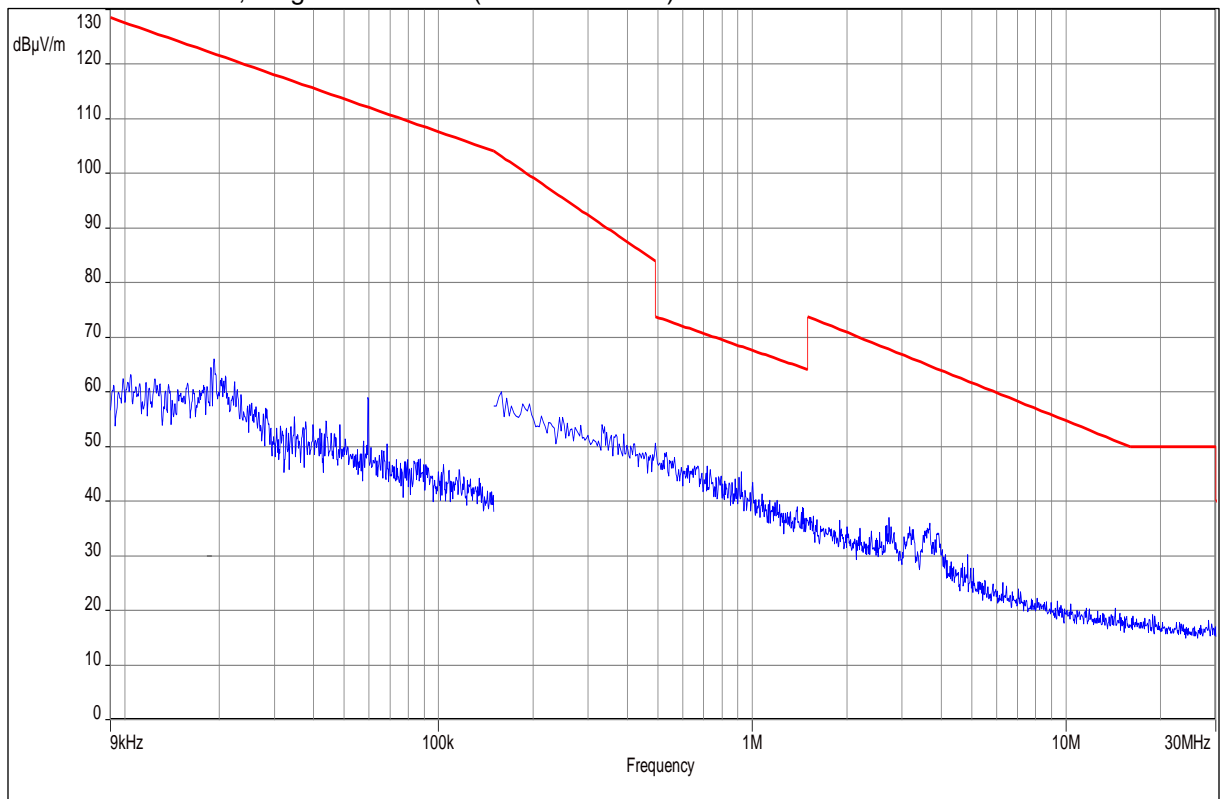

Plot 30: 9 kHz – 30 MHz, Magnetic antenna (High Channel)

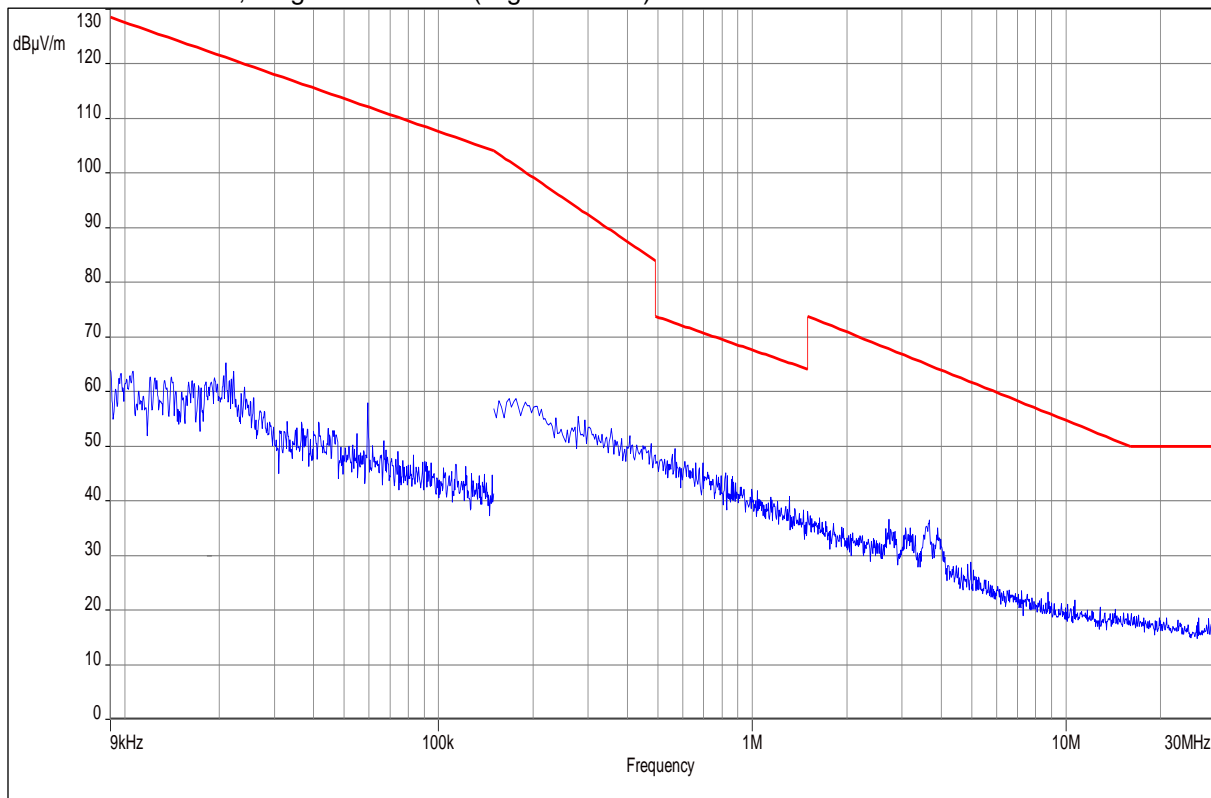

Plot 31: 30 MHz – 1 GHz, antenna vertical / horizontal (Low Channel)

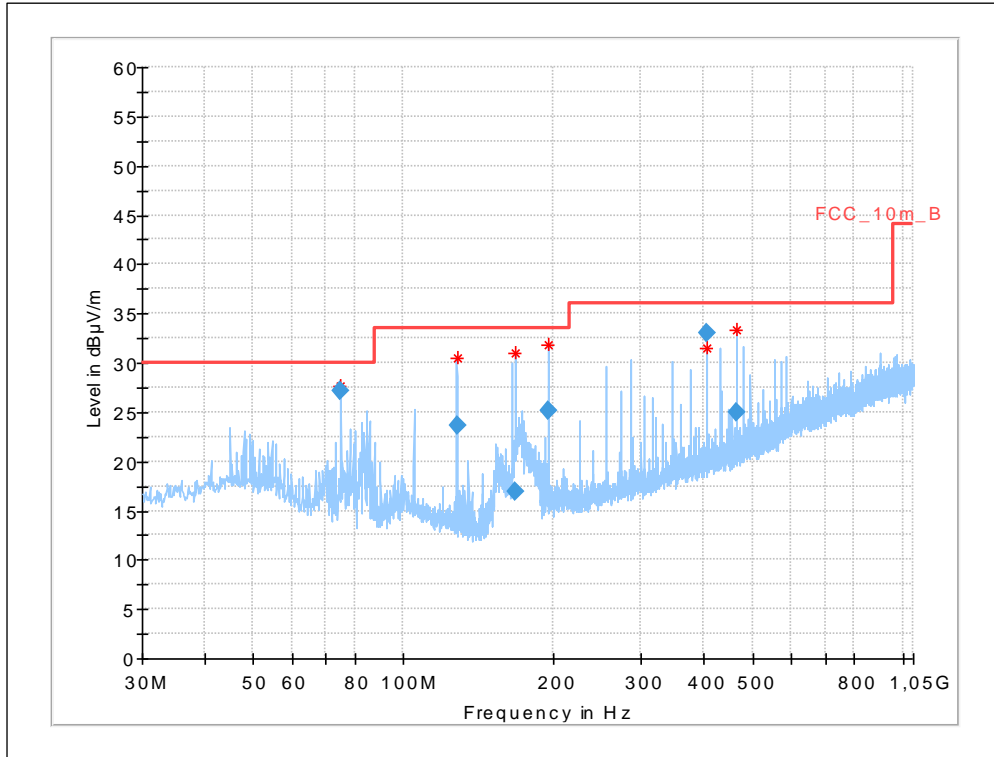

Frequency (MHz)	QuasiPeak (dBµV/m)	Limit (dBµV/m)	Margin (dB)	Meas. Time (ms)	Bandwidth (kHz)	Height (cm)	Pol	Azimuth (deg)	Corr. (dB)
75.003750	27.15	30.00	2.85	1000.0	120.000	203.0	V	195.0	8.9
127.989900	23.60	33.50	9.90	1000.0	120.000	171.0	V	76.0	9.7
167.991900	16.91	33.50	16.59	1000.0	120.000	100.0	V	77.0	10.2
194.999400	25.10	33.50	8.40	1000.0	120.000	100.0	V	167.0	11.7
404.988150	33.04	36.00	2.96	1000.0	120.000	100.0	V	33.0	17.0
464.985600	25.01	36.00	10.99	1000.0	120.000	100.0	V	75.0	18.0

Plot 32: 30 MHz – 1 GHz, antenna vertical / horizontal (Middle channel)

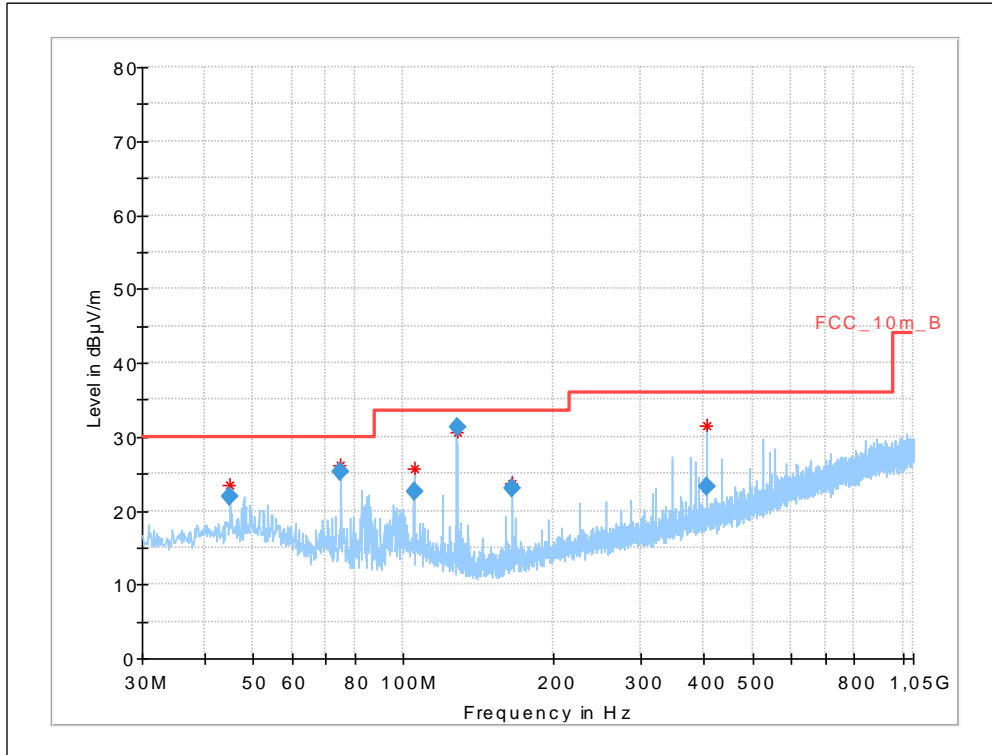

Frequency (MHz)	QuasiPeak (dBµV/m)	Limit (dBµV/m)	Margin (dB)	Meas. Time (ms)	Bandwidth (kHz)	Height (cm)	Pol	Azimuth (deg)	Corr. (dB)
44.989350	22.00	30.00	8.00	1000.0	120.000	101.0	V	10.0	13.6
74.998050	25.32	30.00	4.68	1000.0	120.000	101.0	V	280.0	8.9
105.010650	22.54	33.50	10.96	1000.0	120.000	170.0	V	190.0	11.6
128.004150	31.23	33.50	2.27	1000.0	120.000	98.0	V	280.0	9.7
165.019200	23.02	33.50	10.48	1000.0	120.000	98.0	V	100.0	10.0
404.995800	23.26	36.00	12.74	1000.0	120.000	98.0	V	-8.0	17.0

Plot 33: 30 MHz – 1 GHz, antenna vertical / horizontal (High Channel)

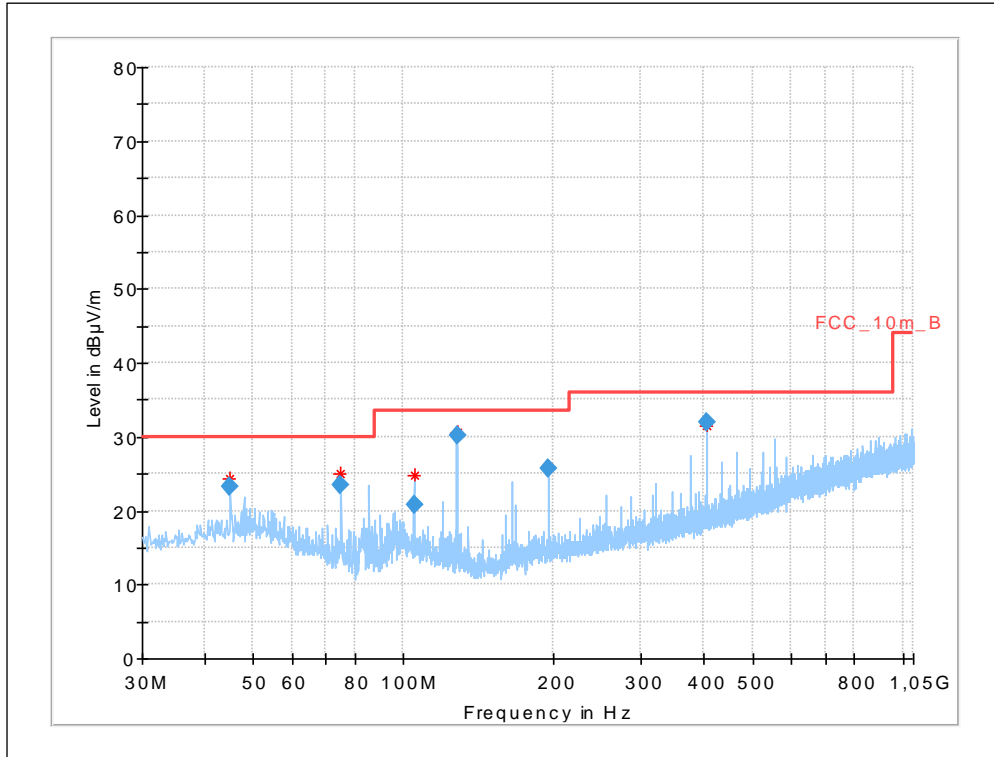

Frequency (MHz)	QuasiPeak (dBµV/m)	Limit (dBµV/m)	Margin (dB)	Meas. Time (ms)	Bandwidth (kHz)	Height (cm)	Pol	Azimuth (deg)	Corr. (dB)
45.009000	23.17	30.00	6.83	1000.0	120.000	101.0	V	10.0	13.6
75.000900	23.49	30.00	6.51	1000.0	120.000	101.0	V	280.0	8.9
105.003150	20.88	33.50	12.62	1000.0	120.000	170.0	V	-8.0	11.6
127.995600	30.20	33.50	3.30	1000.0	120.000	98.0	V	280.0	9.7
195.005400	25.60	33.50	7.90	1000.0	120.000	100.0	V	170.0	11.7
404.997900	31.94	36.00	4.06	1000.0	120.000	98.0	V	10.0	17.0

Plot 34: 1 GHz – 12 GHz, antenna vertical / horizontal (Low Channel)

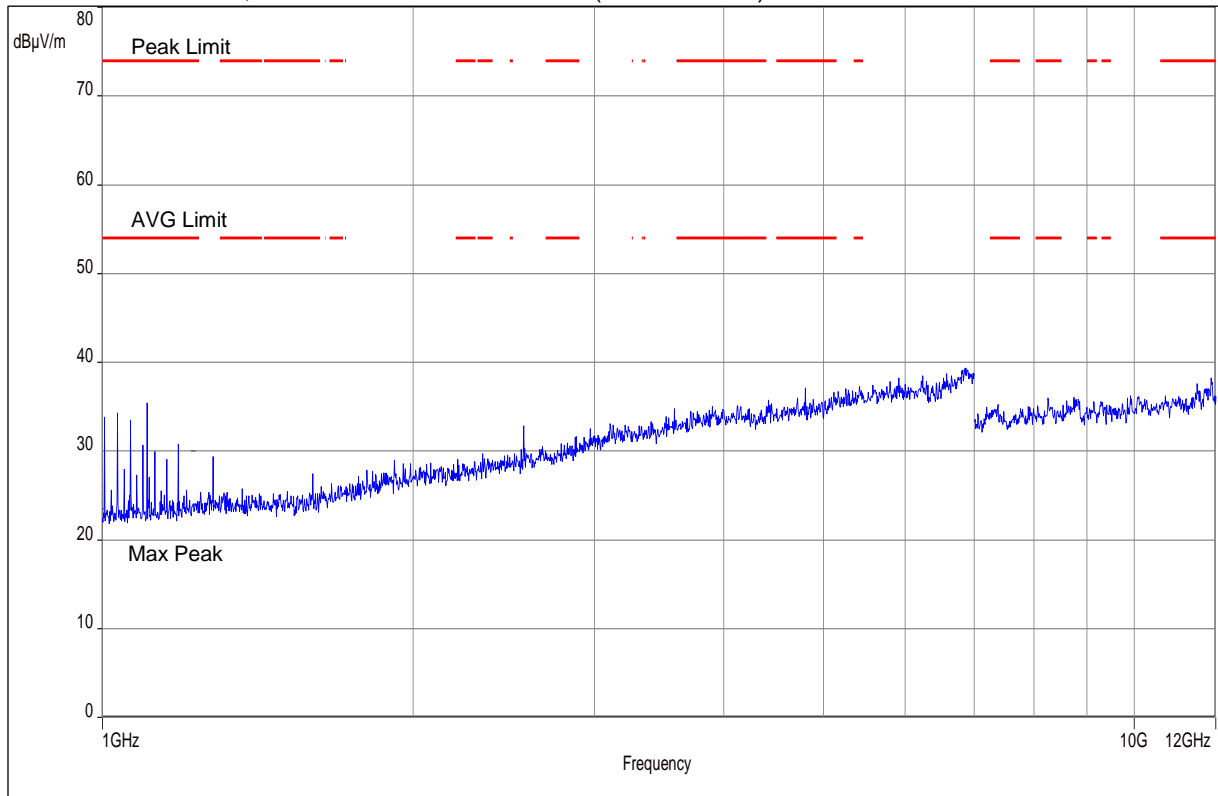

Plot 35: 1 GHz – 12 GHz, antenna vertical / horizontal (Middle Channel)

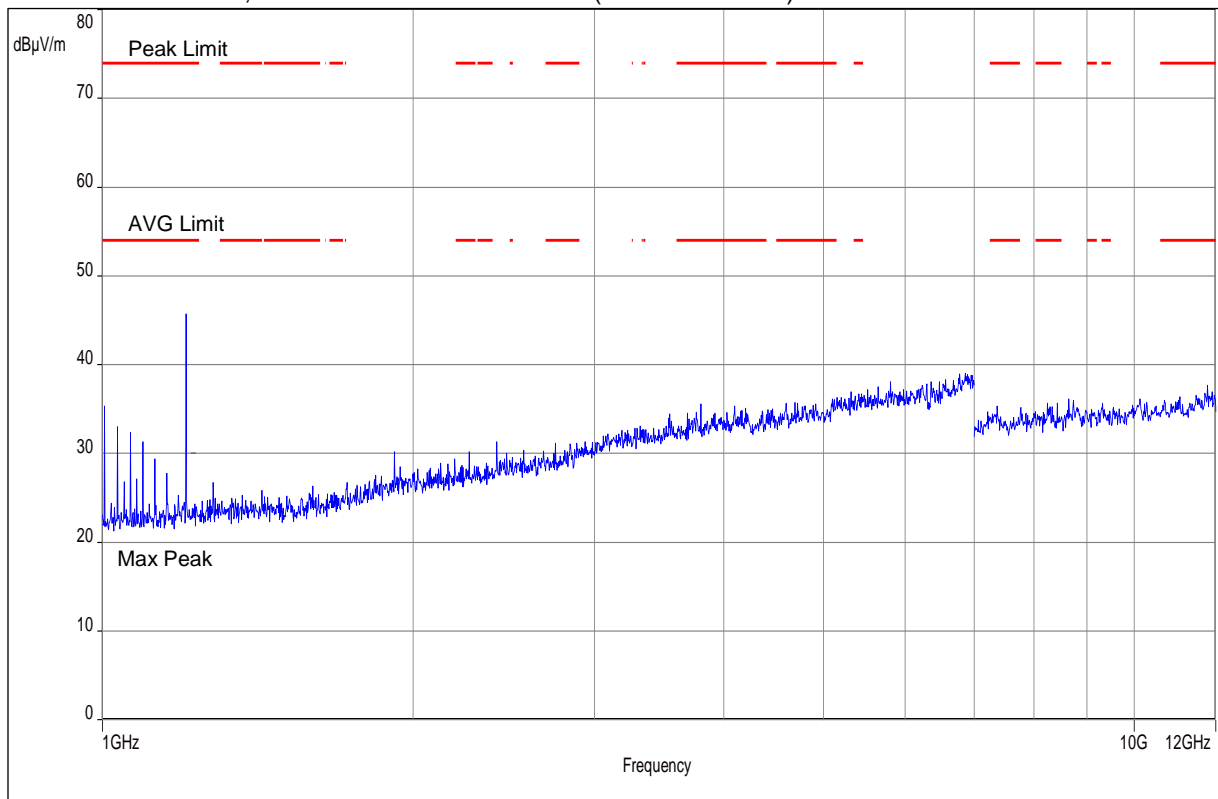

Plot 36: 1 GHz – 12 GHz, antenna vertical / horizontal (High Channel)

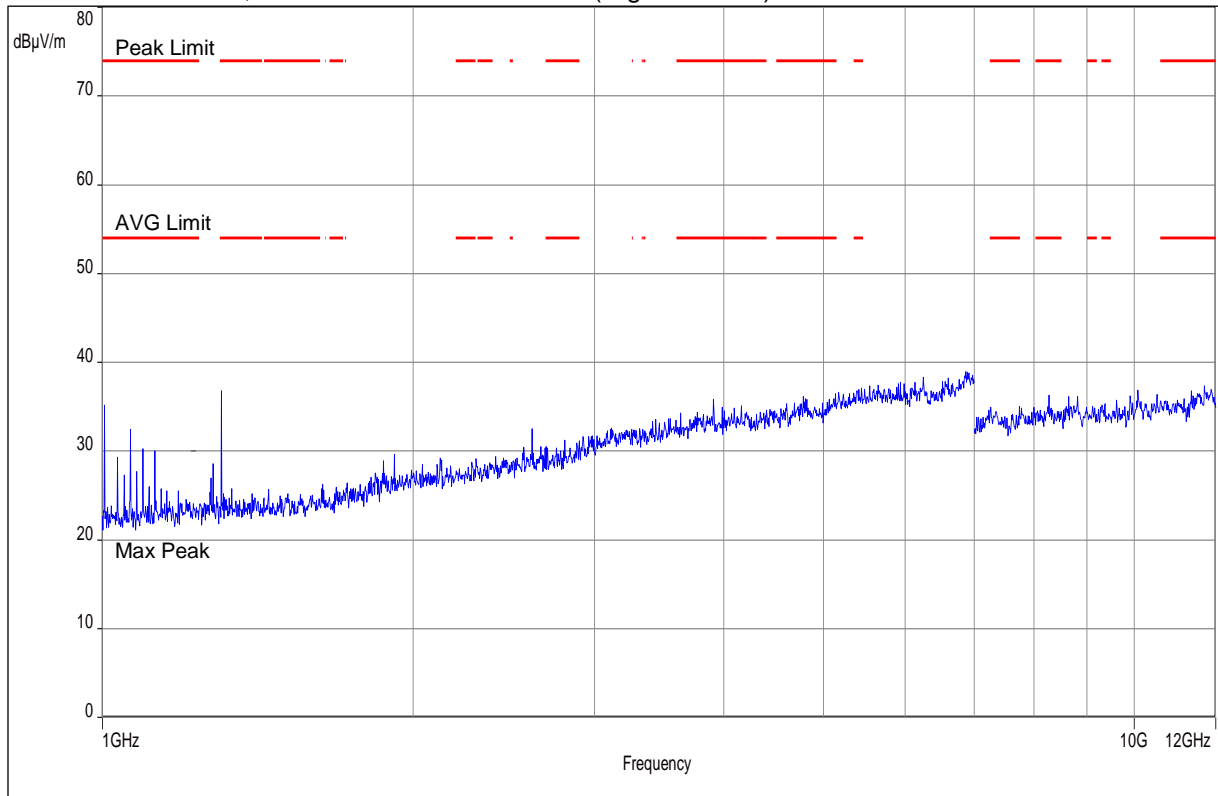

Plot 37: 12 GHz – 18 GHz, antenna vertical / horizontal (valid for all channels)

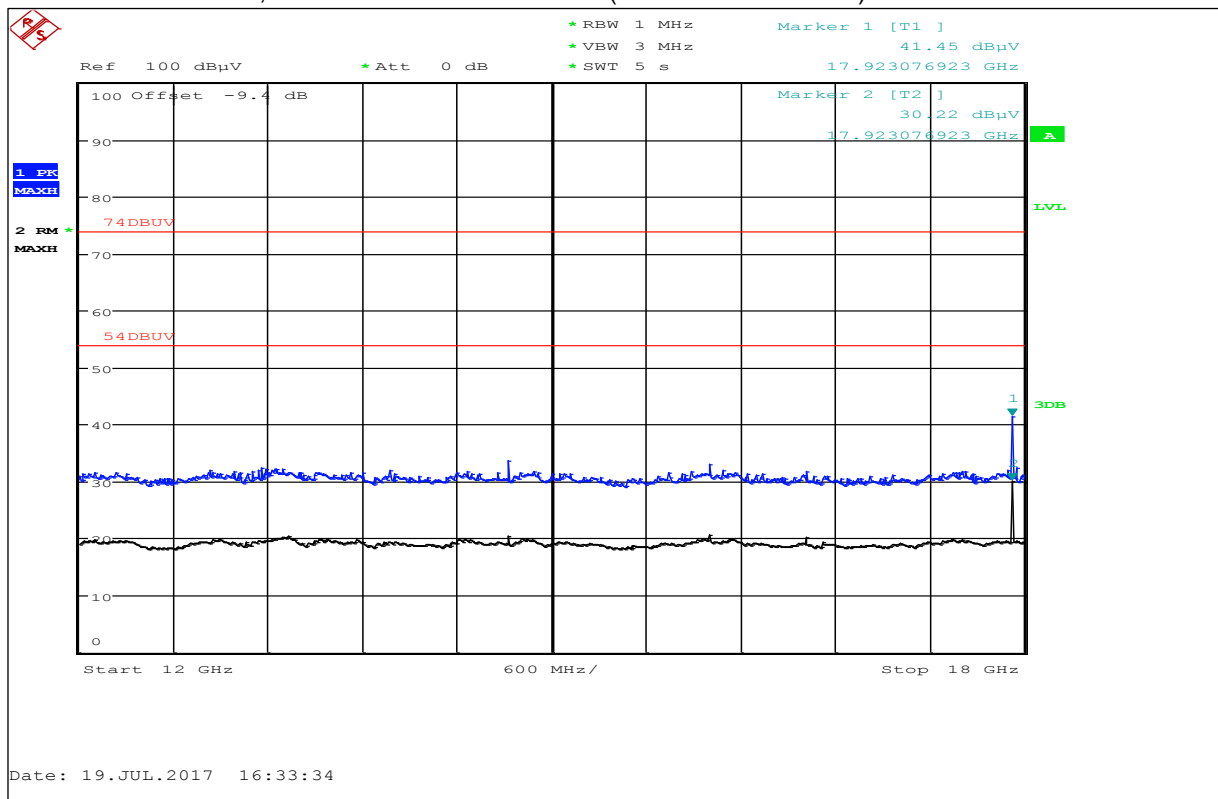

Plot 38: 18 GHz – 26 GHz, antenna vertical / horizontal (valid for all channels)

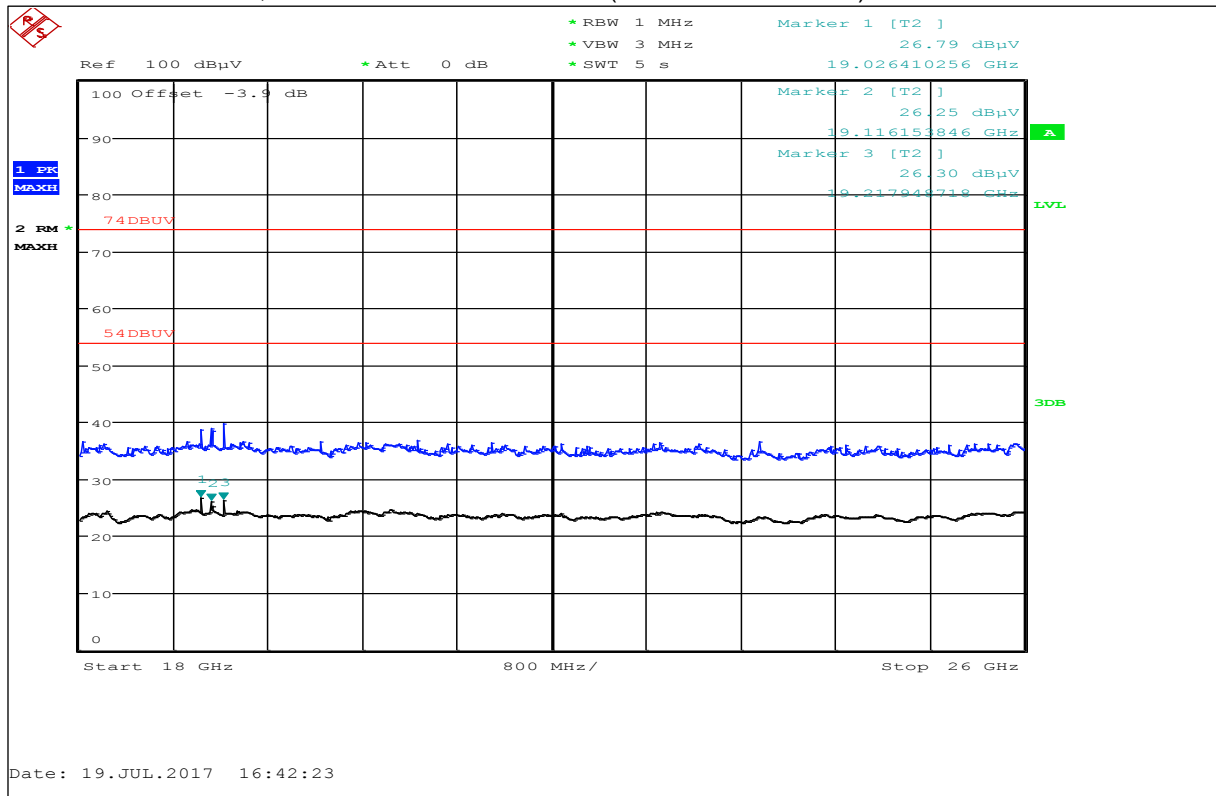

Plot 39: 26 GHz – 40 GHz, Peak detector, antenna vertical / horizontal (valid for all channels)

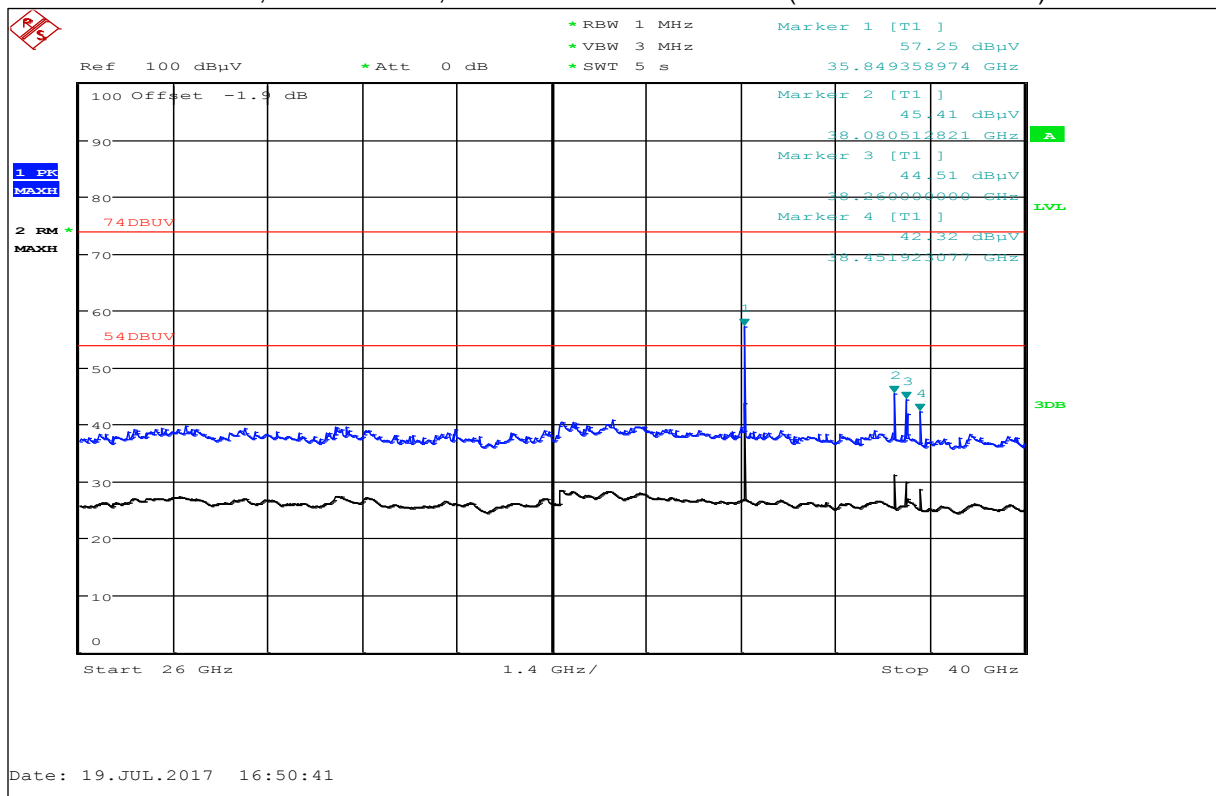

Marker shows the peak value (limit @ 74 dBuV)

Plot 40: 26 GHz – 40 GHz, RMS detector, antenna vertical / horizontal (valid for all channels)

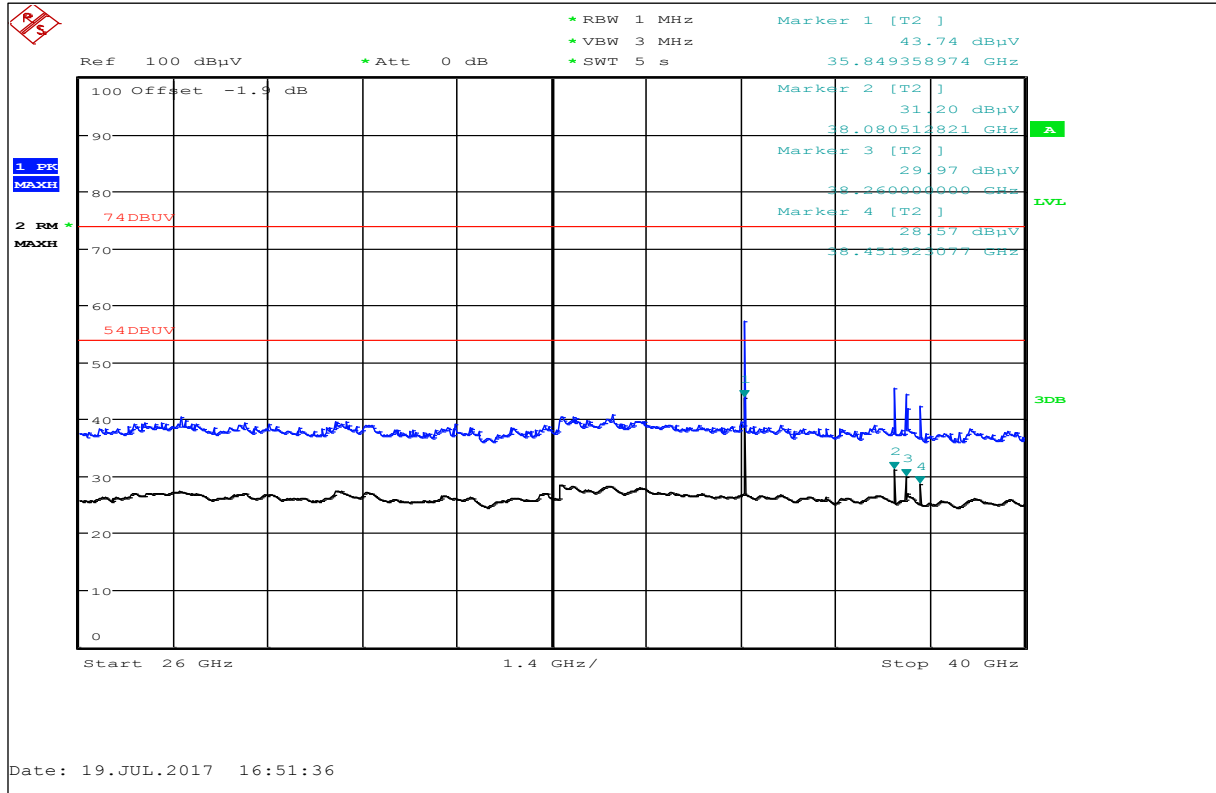

Marker shows the RMS value (Limit @ 54 dBuV)

Plot 41: 40 GHz – 50 GHz, antenna vertical / horizontal (valid for all channels)

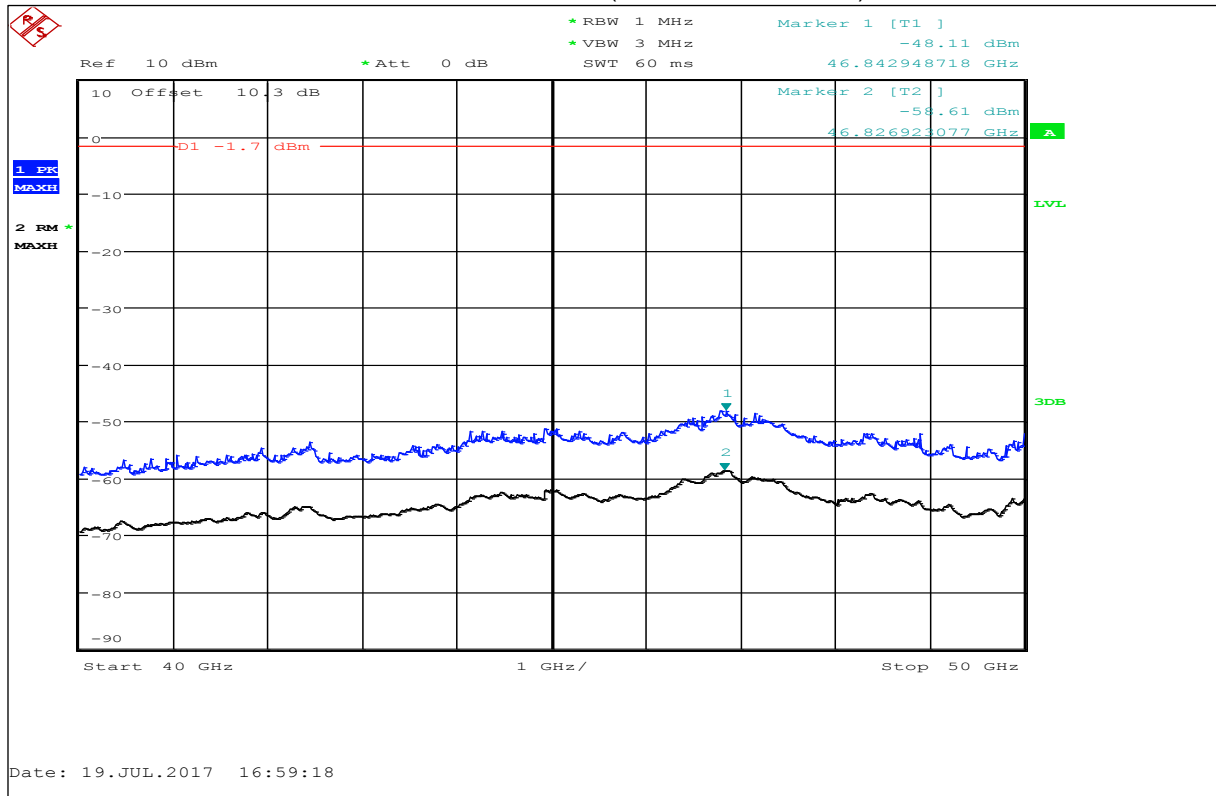

Plot 42: 50 GHz – 75 GHz, antenna vertical / horizontal (valid for all channels)

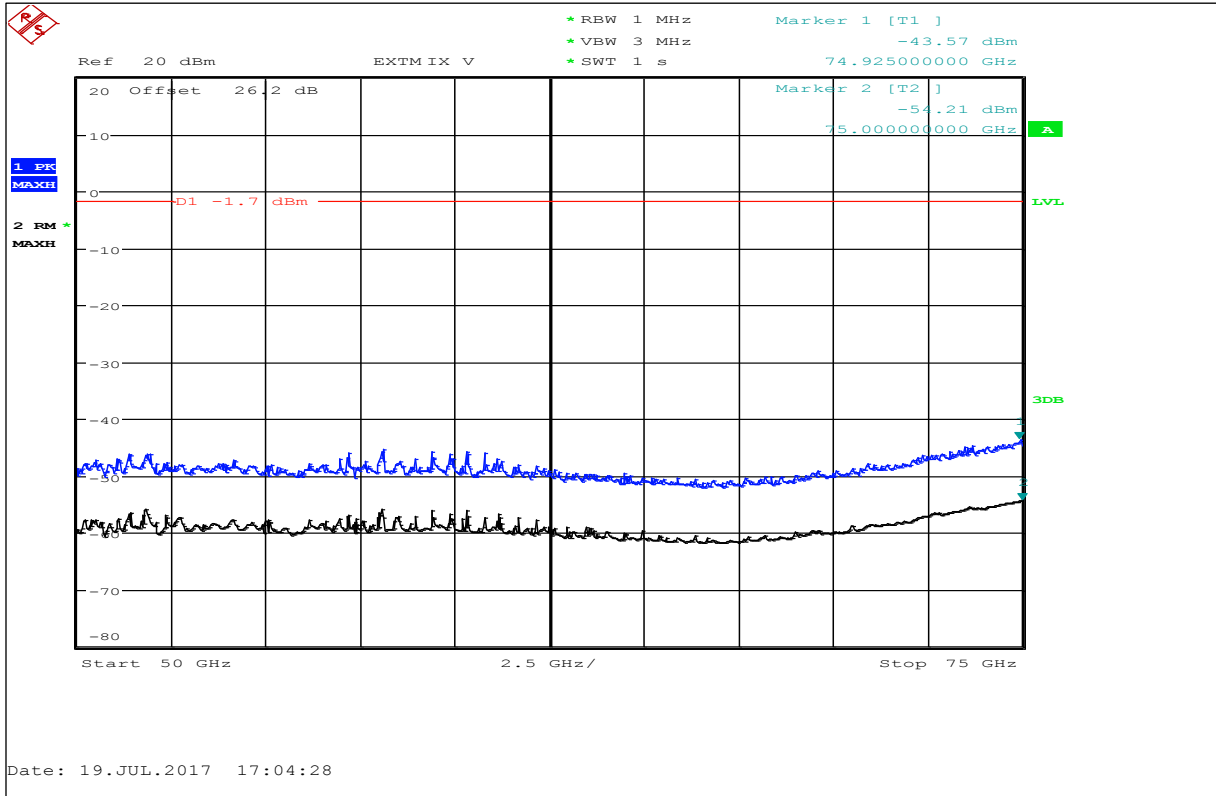

Plot 43: 75 GHz – 90 GHz, Peak detector, antenna vertical / horizontal (valid for all channels)

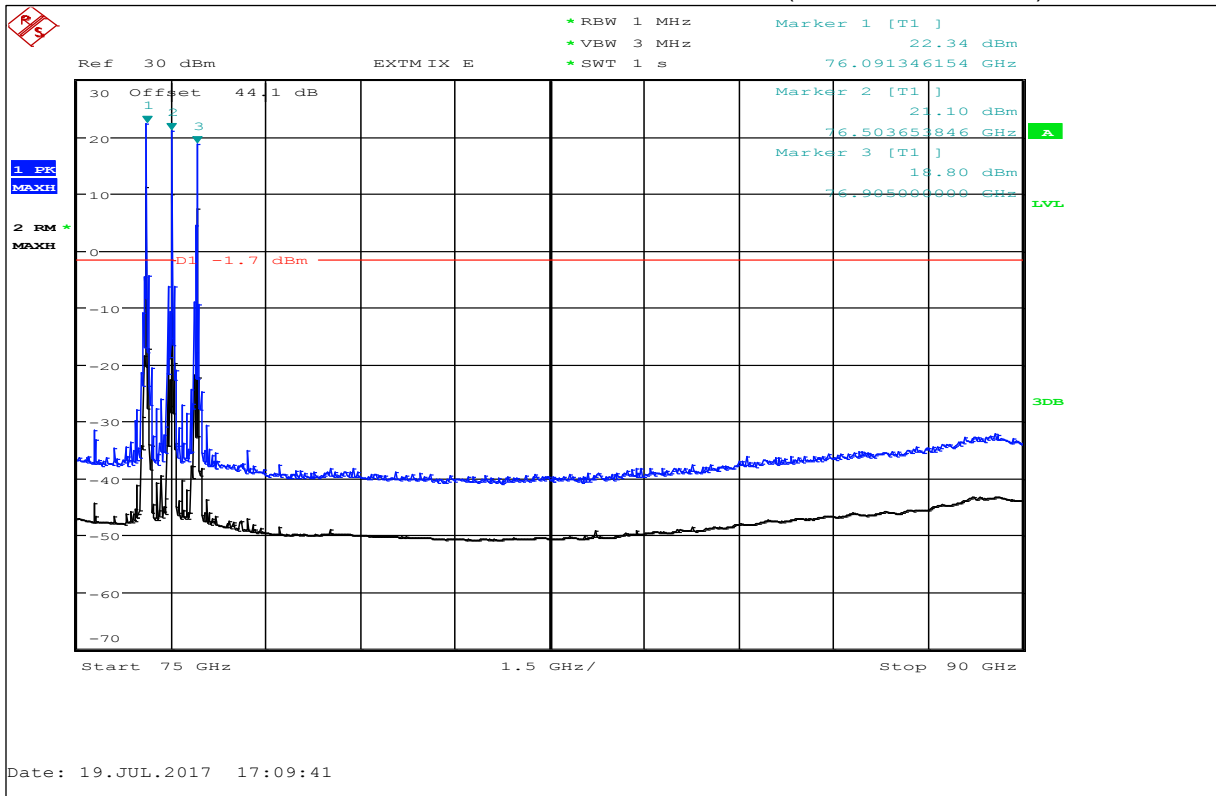

Marker shows the peak value of the wanted signal @ low/middle/high channels

Plot 44: 75 GHz – 90 GHz, RMS detector, antenna vertical / horizontal (valid for all channels)

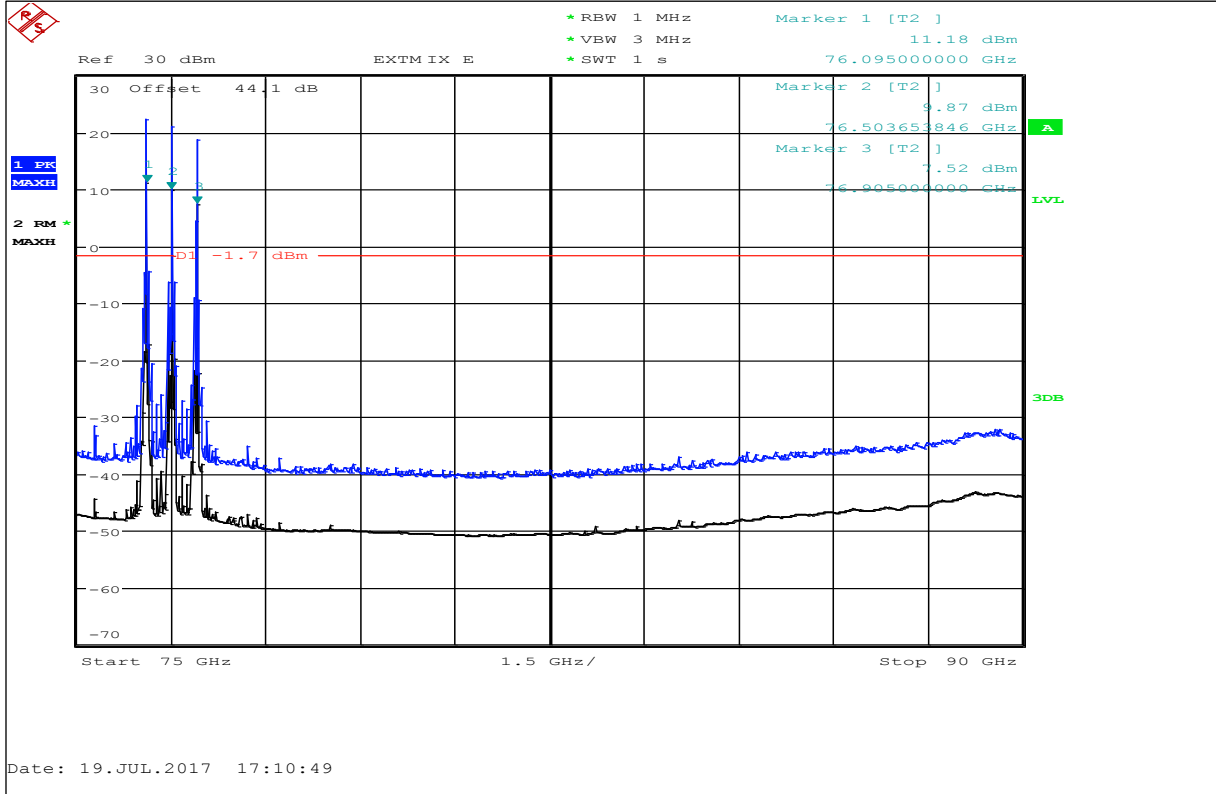

Marker shows the RMS value of the wanted signal @ low/middle/high channels

Plot 45: 90 GHz – 110 GHz, Peak detector, antenna vertical / horizontal (valid for all channels)

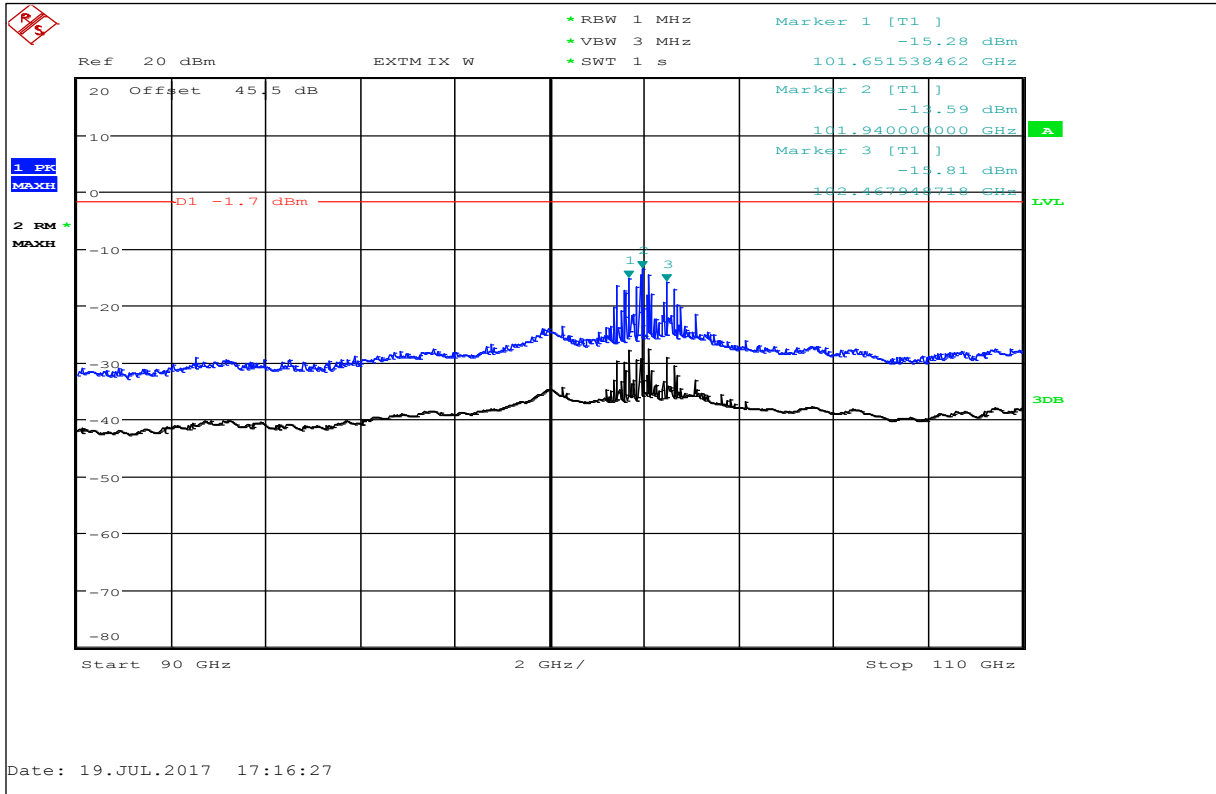

Note: Plot shows mixing products of external harmonic mixer.

Plot 46: 90 GHz – 110 GHz, RMS detector, antenna vertical / horizontal (valid for all channels)

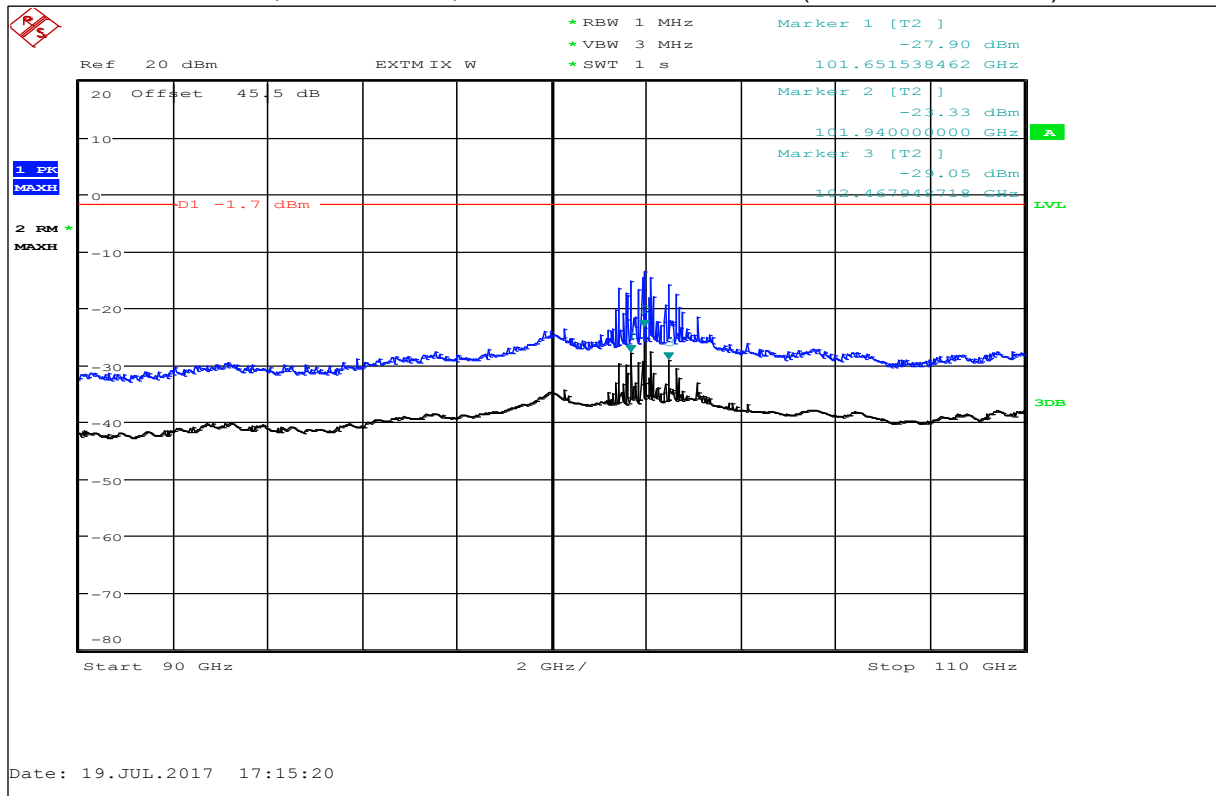

Note: Plot shows mixing products of external harmonic mixer.

Plot 47: 110 GHz – 170 GHz, antenna vertical / horizontal (valid for all channels)

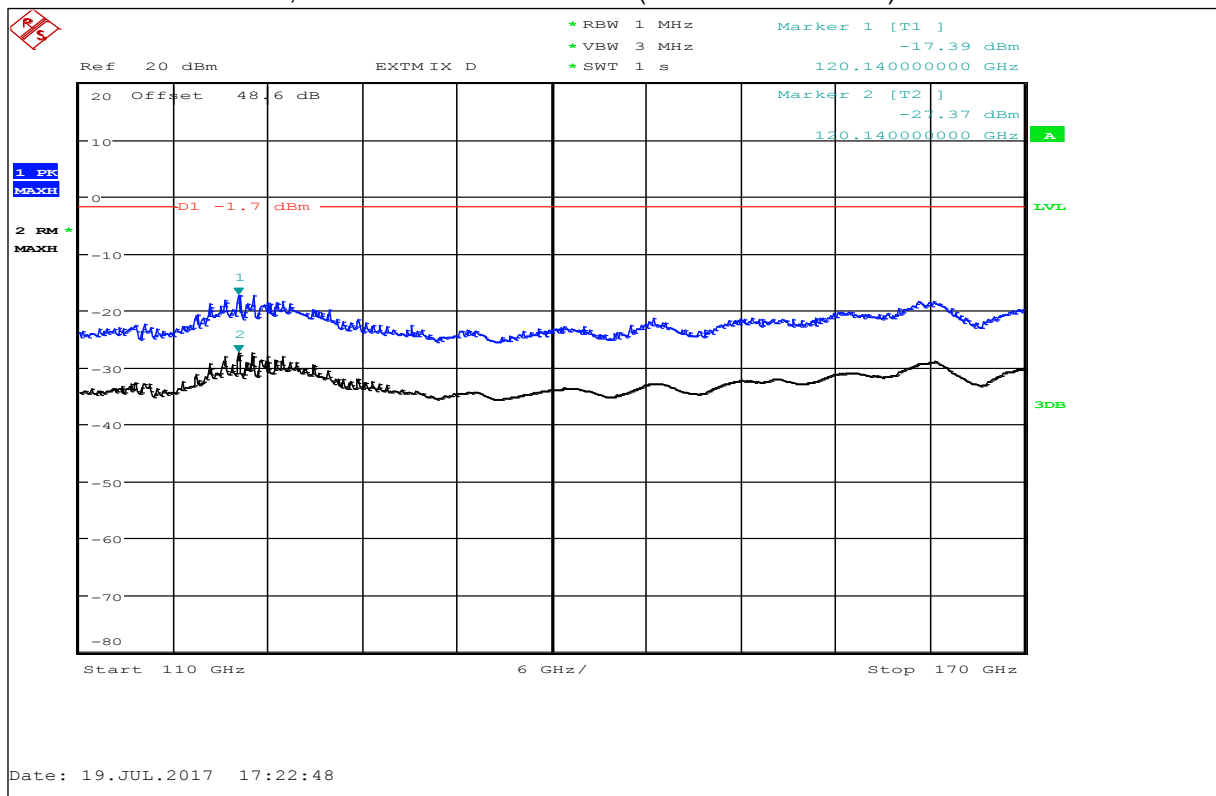

Plot 48: 170 GHz – 200 GHz, antenna vertical / horizontal (valid for all channels)

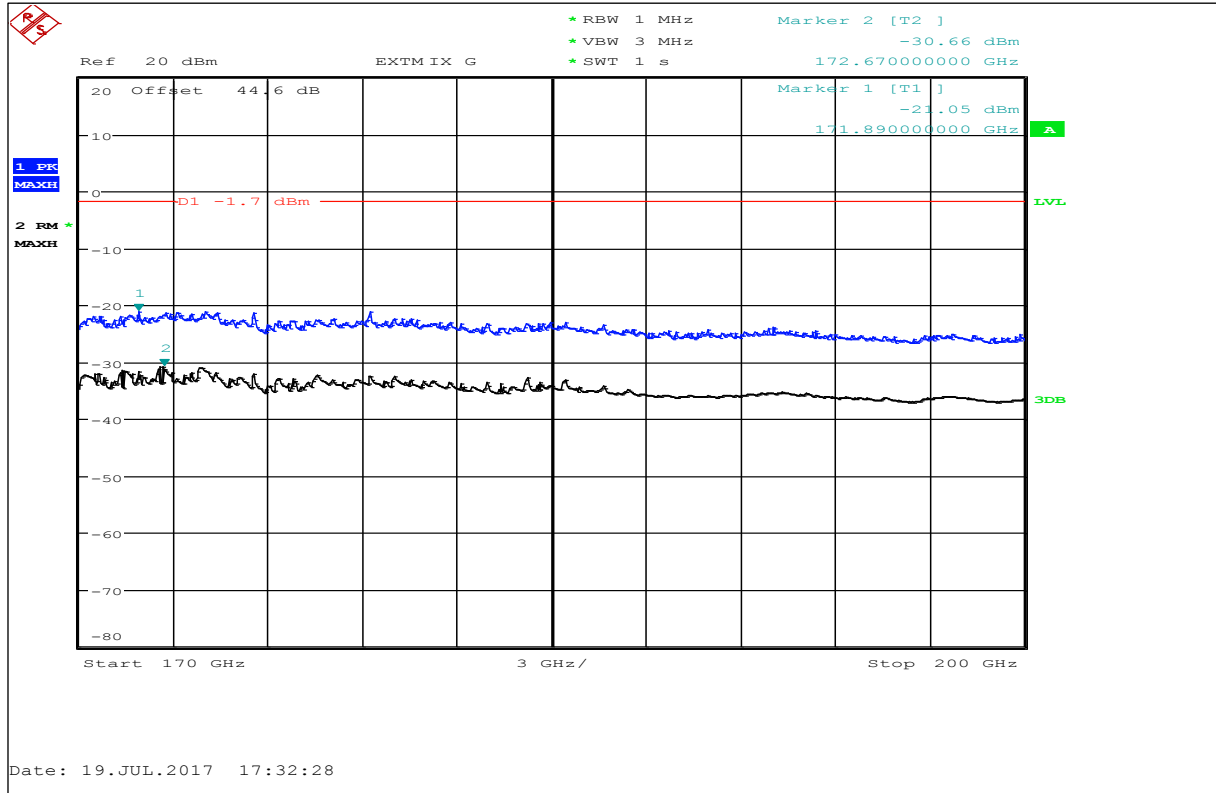

Plot 49: 200 GHz – 220 GHz, antenna vertical / horizontal (valid for all channels)

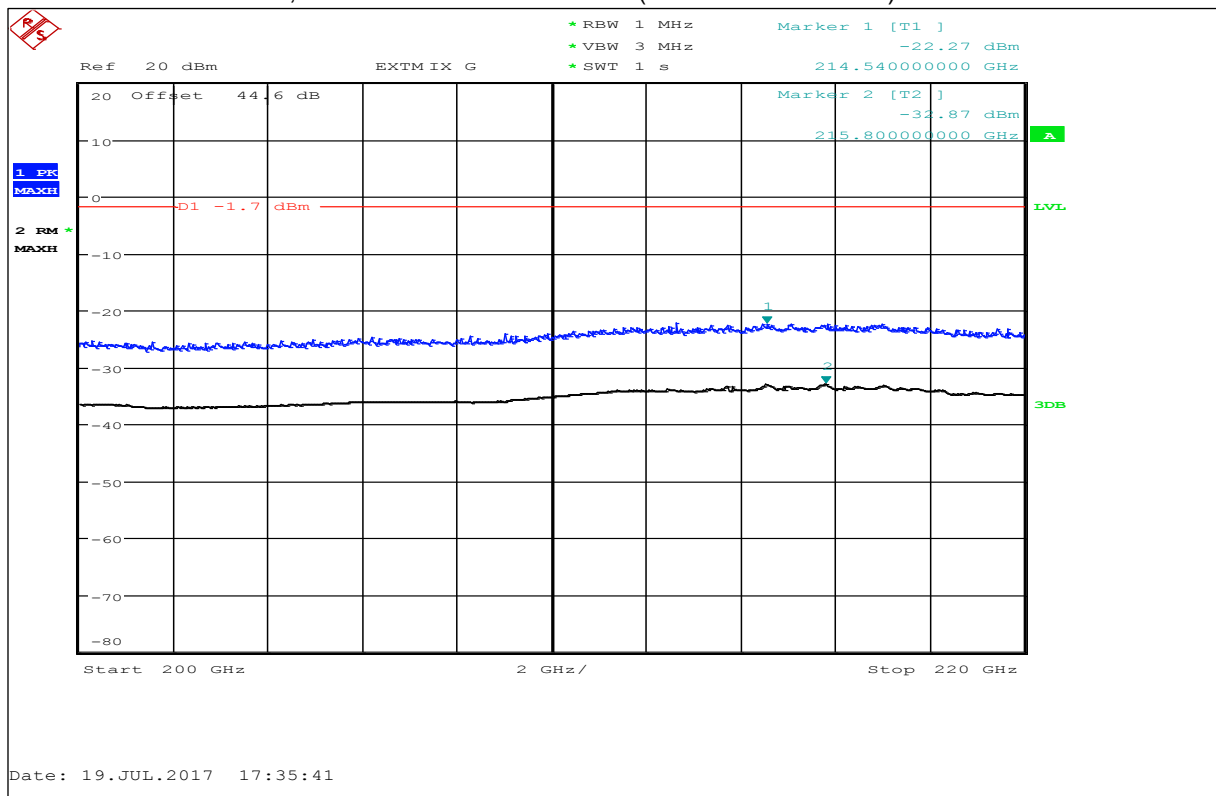

Plot 50: 220 GHz – 330 GHz, antenna vertical / horizontal (valid for all channels)

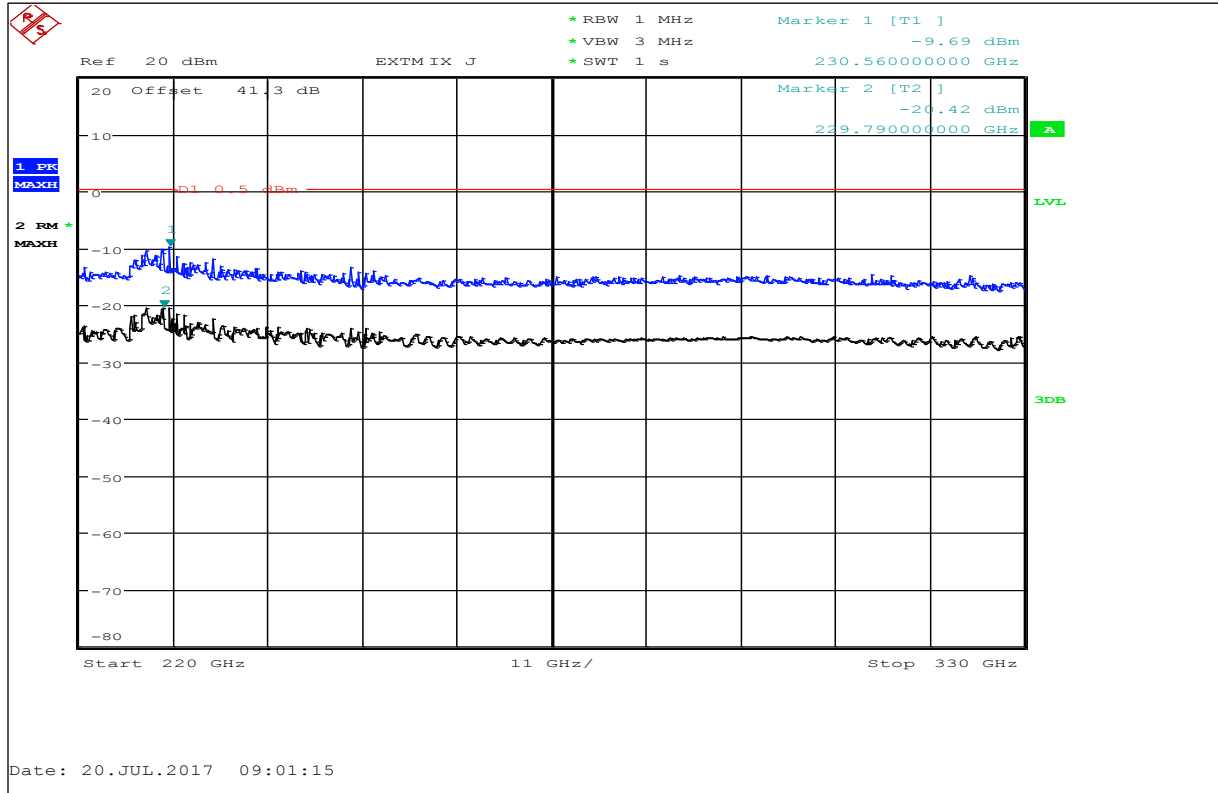

9.6 Frequency stability

Low Channel:

TEST CONDITIONS	Frequency stability [GHz]
T_{nom} / V_{nom}	76.104 000
$T_{min} / V_{min}-V_{max}$	76.104 000
$T_{max} / V_{min}-V_{max}$	76.104 000

Middle Channel:

TEST CONDITIONS	Frequency stability [GHz]
T_{nom} / V_{nom}	76.504 000
$T_{min} / V_{min}-V_{max}$	76.504 000
$T_{max} / V_{min}-V_{max}$	76.504 000

High Channel:

TEST CONDITIONS	Frequency stability [GHz]
T_{nom} / V_{nom}	76.904 000
$T_{min} / V_{min}-V_{max}$	76.905 282
$T_{max} / V_{min}-V_{max}$	76.904 000

Limits:

FCC §95.3379 (b)

Frequency range	$f(\text{lowest}) > 76.0 \text{ GHz}$	$f(\text{highest}) < 81.0 \text{ GHz}$
-----------------	---------------------------------------	--

Limits:

RSS-251 (5.2.2) / (5.4)

Frequency range	$f(\text{lowest}) > 76.0 \text{ GHz}$	$f(\text{highest}) < 77.0 \text{ GHz}$
-----------------	---------------------------------------	--

Plot 51: +22 °C

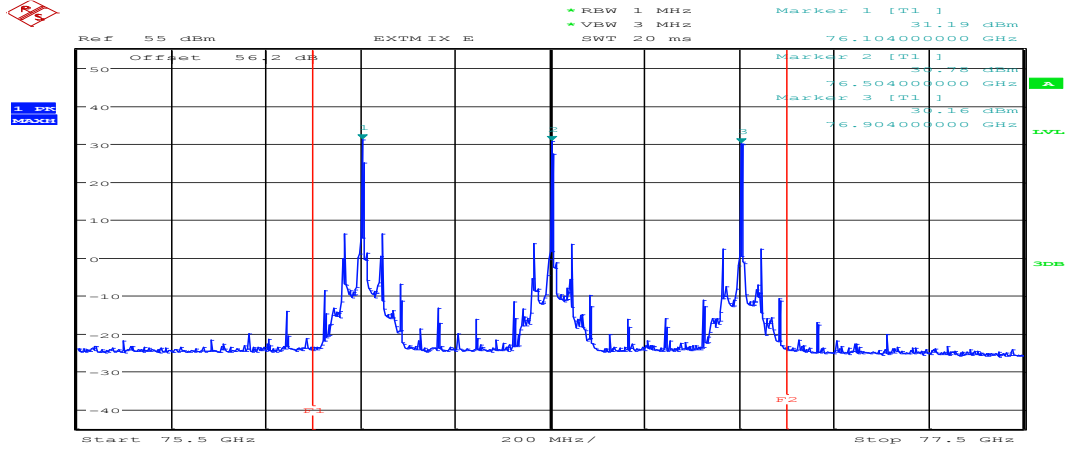

Date: 19.JUL.2017 09:19:34

Plot 52: -40 °C

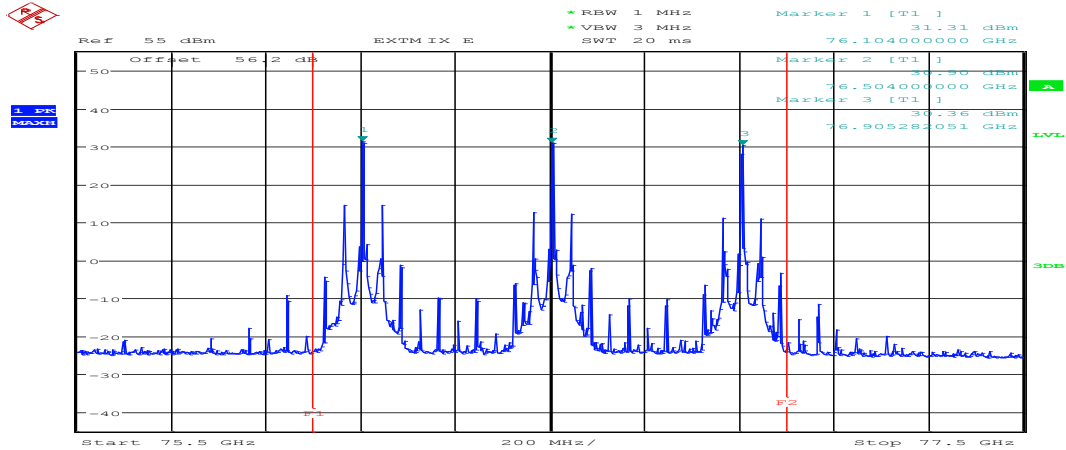

Date: 19.JUL.2017 10:31:21

Plot 53: +85 °C

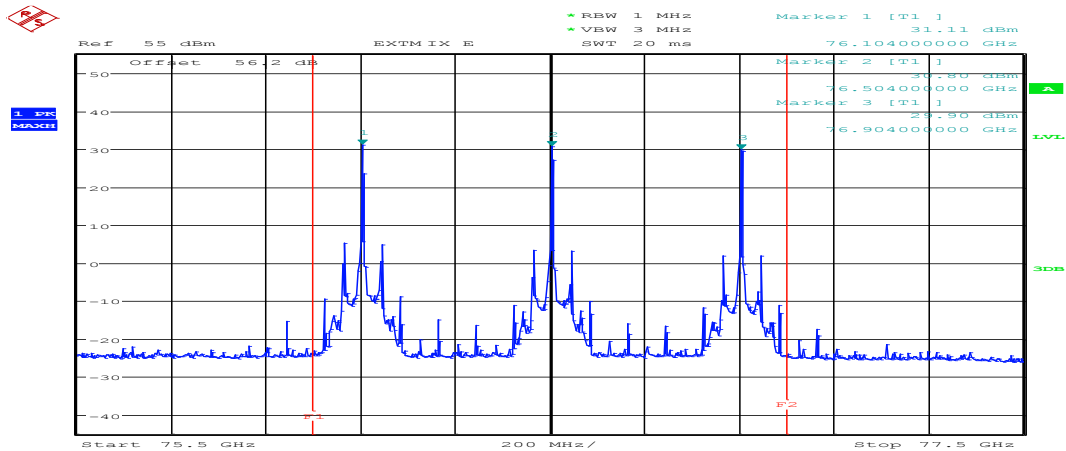

Date: 19.JUL.2017 09:33:38

10 Glossary

EUT	Equipment under test
DUT	Device under test
UUT	Unit under test
ETSI	European Telecommunications Standard Institute
EN	European Standard
FCC	Federal Communication Commission
FCC ID	Company Identifier at FCC
IC	Industry Canada
PMN	Product marketing name
HMN	Host marketing name
HVIN	Hardware version identification number
FVIN	Firmware version identification number
EMC	Electromagnetic Compatibility
HW	Hardware
SW	Software
Inv. No.	Inventory number
S/N or SN	Serial number
C	Compliant
NC	Not compliant
NA	Not applicable
NP	Not performed
PP	Positive peak
QP	Quasi peak
AVG	Average
OC	Operating channel
OCW	Operating channel bandwidth
OBW	Occupied bandwidth
OOB	Out of band
DFS	Dynamic frequency selection
CAC	Channel availability check
OP	Occupancy period
NOP	Non occupancy period
DC	Duty cycle
PER	Packet error rate
CW	Clean wave
MC	Modulated carrier
WLAN	Wireless local area network
RLAN	Radio local area network
DSSS	Dynamic sequence spread spectrum
OFDM	Orthogonal frequency division multiplexing
FHSS	Frequency hopping spread spectrum

11 Document history

Version	Applied changes	Date of release
-/-	DRAFT	2017-08-10
-/-	47 CFR Part 95 Subpart M Update	2017-11-20
-A	47 CFR Part 95 Subpart M , additional editorial changes	2018-01-22

12 Accreditation Certificate

first page	last page
 <p>Deutsche Akkreditierungsstelle GmbH</p> <p>Entrusted according to Section 8 subsection 1 AkkStelleG in connection with Section 1 subsection 1 AkkStelleGBV Signatory to the Multilateral Agreements of EA, ILAC and IAF for Mutual Recognition</p> <p>Accreditation </p> <p>The Deutsche Akkreditierungsstelle GmbH attests that the testing laboratory CTC advanced GmbH Untertürkheimer Straße 6-10, 66117 Saarbrücken</p> <p>is competent under the terms of DIN EN ISO/IEC 17025:2005 to carry out tests in the following fields: Telecommunication</p> <p>The accreditation certificate shall only apply in connection with the notice of accreditation of 02.06.2017 with the accreditation number D-PL-12076-01 and is valid until 21.04.2021. It comprises the cover sheet, the reverse side of the cover sheet and the following annex with a total of 43 pages.</p> <p>Registration number of the certificate: D-PL-12076-01-03</p> <p>Frankfurt, 02.06.2017</p> <p> Dipl.-Ing. (FH) Ralf Peter Head of Division</p> <p>See notes on back.</p>	<p>Deutsche Akkreditierungsstelle GmbH</p> <p>Office Berlin Spittelmarkt 10 10117 Berlin</p> <p>Office Frankfurt am Main Europa-Allee 52 60327 Frankfurt am Main</p> <p>Office Braunschweig Bundesallee 100 38116 Braunschweig</p> <p>The publication of extracts of the accreditation certificate is subject to the prior written approval by Deutsche Akkreditierungsstelle GmbH (DAkKS). Exempted is the unchanged form of separate disseminations of the cover sheet by the conformity assessment body mentioned overleaf.</p> <p>No impression shall be made that the accreditation also extends to fields beyond the scope of accreditation attested by DAkKS.</p> <p>The accreditation was granted pursuant to the Act on the Accreditation Body (AkkStelleG) of 31 July 2009 (Federal Law Gazette I p. 2625) and the Regulation (EC) No 765/2008 of the European Parliament and of the Council of 9 July 2008 setting out the requirements for accreditation and market surveillance relating to the marketing of products (Official Journal of the European Union L 218 of 9 July 2008, p. 30). DAkKS is a signatory to the Multilateral Agreements for Mutual Recognition of the European co-operation for Accreditation (EA), International Accreditation Forum (IAF) and International Laboratory Accreditation Cooperation (ILAC). The signatories to these agreements recognise each other's accreditations.</p> <p>The up-to-date state of membership can be retrieved from the following websites: EA: www.european-accreditation.org ILAC: www.ilac.org IAF: www.iaf.eu</p>

Note: The current certificate annex is published on the website (link see below) of the Accreditation Body DAkKS or may be received by CTC advanced GmbH on request

<http://www.dakks.de/as/ast/d/D-PL-12076-01-03.pdf>