

**P9**

## **CONNECTING TRAINER**

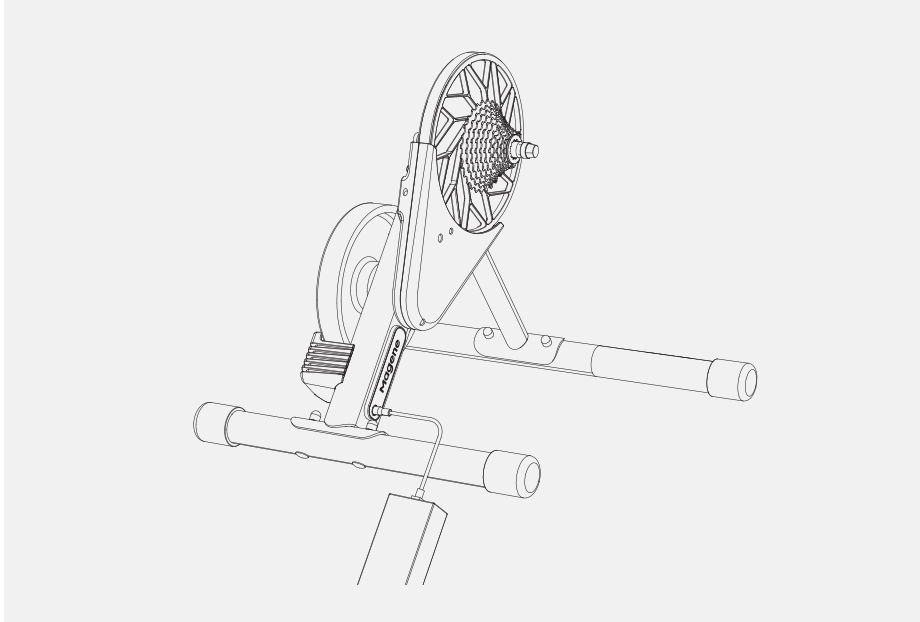

**P10**

## **MODES AND INDICATORS**

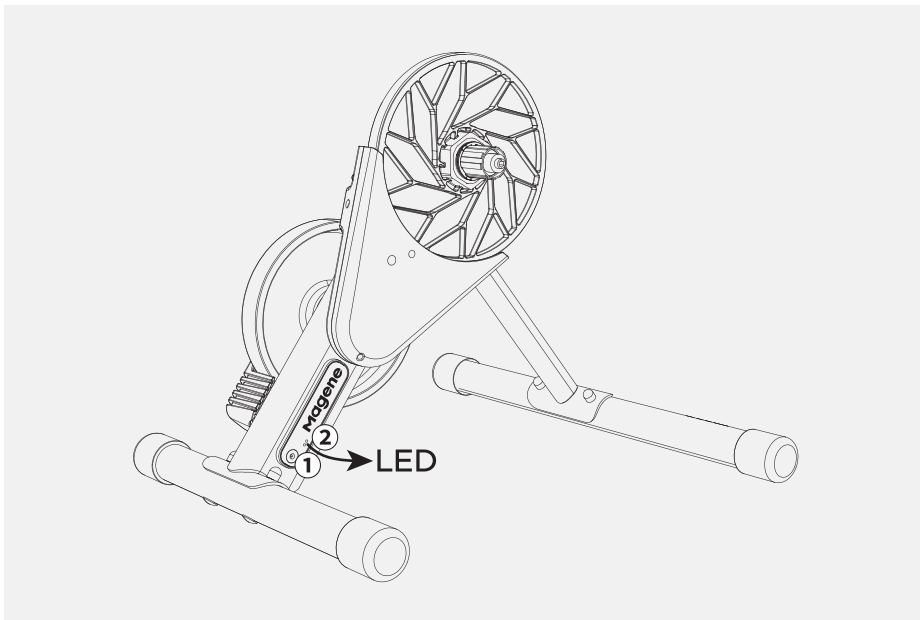



# IMPORTANT PRODUCT INFORMATION

## Contact Magene

Qingdao Magene Intelligence Technology Co., Ltd.  
No.2 AWS,Licang District,Qingdao,Shandong,China  
www.magene.com  
support@magene.com  
V2.0

## EN

### CAUTION!

- There is a wide range of bike models, and we cannot guarantee that the trainer is compatible with each bike. Therefore, we recommend that you visit your local bike store to test your bike for compatibility before purchasing the trainer, thus avoiding damage to your bike's frame.
- Modifications to the trainer to make it compatible with your bike, including (but not limited to) grinding components, adding spacers or improperly reversing the adapters, are strictly prohibited and will void your warranty and increase risk. The manufacturer is not responsible for any damage or injury caused by improper installation and use of the trainer, or misuse of accessories.
- User should weigh less than 100kg.
- Before beginning or modifying any workout program please consult your physician.
- Keep children and pets away from the trainer while in use.
- Do NOT put hands or objects near moving parts of the trainer.
- Only use the trainer on a stable, level surface.
- Do NOT attempt to dismount or assemble the bicycle while the trainer is in motion.
- Use caution when standing while riding on the trainer.
- Keep the trainer away from water, fire and other barriers.
- Only use the power adapter that comes with the trainer.
- Only use accessories that comes with the trainer.
- Check to make sure the bicycle is properly secured to the trainer before every ride.

### WARRANTY CLAUSE PRODUCT

Thank you for purchasing Magene power meter. A free warranty will be offered during the warranty period to repair any failure caused by product quality issues under normal conditions of usage. The warranty period for product is 12 months from the activation date. For warranty information, please visit Magene website: <https://support.magene.com/> View related content. The Company reserves the right to modify and interpret the above contents.

### CE STATEMENT

Hereby, Qingdao Magene Intelligence Technology Co., Ltd. declares that this product is in compliance with the Directive 2014/53/EU. The full text of the EU declaration of conformity is available at the following internet address: <https://magene.com/certificate.html>  
Bluetooth (2402-2480MHz) Max EIRP is -1.3dBm.  
ANT+ (2457MHz) Max EIRP is 0dBm.

### UK DECLARATION OF CONFORMITY

Hereby, Qingdao Magene Intelligence Technology Co., Ltd. declares that this product is in compliance with The Radio Equipment Regulations 2017. The full text of the declaration of conformity is available at the following internet address: <https://www.magene.com/certificate.html>

### CALIFORNIA PROPOSITION 65

The enclosed hardware and its packaging contain chemicals the State of California has found to cause cancer, birth defects or reproductive harm.

### FCC STATEMENT

This device complies with part 15 of the FCC rules. Operation is subject to the following two conditions: (1) this device may not cause harmful interference, and (2) this device must accept any interference received, including interference that may cause undesired operation.

NOTE: The manufacturer is not responsible for any radio or TV interference caused by unauthorized modifications or changes to this equipment. Such modifications or changes could void the user's authority to operate the equipment.

NOTE: This equipment has been tested and found to comply with the limits for a Class B digital device, pursuant to part 15 of the FCC Rules. These limits are designed to provide reasonable protection against harmful interference in a residential installation. This equipment generates uses and can radiate radio frequency energy and, if not installed and used in accordance with the instructions, may cause harmful interference to radio communications. However, there is no guarantee that interference will not occur in a particular installation. If this equipment does cause harmful interference to radio or television reception, which can be determined by turning the equipment off and on, the user is encouraged to try to correct

the interference by one or more of the following measures:

- Reorient or relocate the receiving antenna.
- Increase the separation between the equipment and receiver.
- Connect the equipment into an outlet on a circuit different from that to which the receiver is connected.
- Consult the dealer or an experienced radio/TV technician for help.

When using the product, maintain a distance of 20cm from the body to ensure compliance with RF exposure requirements.





## RECYCLING/LICENSES



### WEEE(Waste Electronic Electric Equipment) European Directive 2012/19/EU

NOTE: This symbol on the product or on its packaging indicates that this product must not be disposed of with your household waste.

Instead, it is your responsibility to dispose of your waste equipment by handing it over to a designated collection point for the recycling of waste electrical and electronic equipment. The separate collection and recycling of your waste equipment at the time of disposal will help to conserve natural resources and ensure that it is recycled in a manner that protects human health and the environment. For more information about where you can drop off your waste equipment for recycling, please contact your local city office, your household waste disposal service or the shop where you purchased the product.

 <b>Magene</b>		<b>Magene Smart Trainer</b>			
Manufacturer		Qingdao Magene Intelligence Technology Co., Ltd.			
Address		No.2 AWS, Road, Licang District, Qingdao Shandong China			
<table border="1"> <tr> <td style="padding: 5px;">EC</td> <td style="padding: 5px;">REP</td> </tr> </table>	EC	REP	WSJ Product LTD (for authorities only)		
	EC	REP			
	Eschborner Landstraße 42-50				
60489 Frankfurt am Main, Hessen, Germany					
<table border="1"> <tr> <td style="padding: 5px;">UK</td> <td style="padding: 5px;">REP</td> </tr> </table>	UK	REP	UK Authorised Representative:		
	UK	REP			
	WSJ Product LTD.				
Unit 1 Alsop Arcade, brownlow hill, Liverpool, L3 5TX, GB					
   					

## DE

### WARNUNG!

- Es gibt viele verschiedene Fahrradmodellen. Hier können wir nicht sicherstellen, dass der Biketrainer mit allen Fahrrädern kompatibel ist. Wir schlagen hier vor, dass Sie Ihr Fahrrad vor dem Kauf in Ihrem örtlichen Fahrradgeschäft auf Kompatibilität mit dem Biketrainer testen, um Schäden an Ihrem Fahrradgestell zu vermeiden.
- Jegliche Modifikation am Biketrainer zur Kompatibilität mit dem Fahrrad ist verboten, einschließlich (aber nicht beschränkt auf) Schleifen von Komponenten, Hinzufügen von Unterlegscheiben oder falsches Umkehren des offenen Schalthebels. Jede unerlaubte Modifikation kann zum Erlöschen Ihrer Garantie und Erhöhen des Risikos führen. Der Hersteller ist nicht verantwortlich für Verluste oder Schäden, die durch unsachgemäße Installation, Verwendung vom Biketrainer oder Missbrauch von Zubehör verursacht werden.
- Das Benutzergewicht sollte weniger als 100kg betragen.
- Bevor Sie ein Sportprogramm beginnen oder ändern, fragen Sie bitte Ihren Arzt.
- Während der Benutzung müssen sich Kinder und Haustiere in sicherer Entfernung zum Biketrainer befinden.
- Halten Sie Hände und Gegenstände von beweglichen Teilen des Biketrainer fern.
- Verwenden Sie den Biketrainer bitte nur auf einer stabilen, ebenen Oberfläche.
- Während der Benutzung bitte montieren bzw. demontieren Sie Ihr Fahrrad nicht.
- Seien Sie vorsichtig, wenn Sie während des Workouts auf dem Biketrainer stehen.
- Halten Sie bitte den Biketrainer von Feuer, Wasser und anderen Hindernissen fern.
- Verwenden Sie bitte für den Biketrainer nur die vorgeschriebene Spannung.
- Verwenden Sie bitte mit dem Biketrainer nur zugelassenes Wahoo-Zubehör.
- Prüfen Sie bitte vor jeder Benutzung, ob das Fahrrad ordnungsgemäß am Biketrainer befestigt ist.

### GARANTIEBEDINGUNGEN

Wir danken Ihnen für den Kauf des Magene Strommessers. Während der Dauer der Gewährleistung wird eine kostenlose Gewährleistung angeboten, um Fehler zu beheben, die durch Qualitätsprobleme

des Produkts unter normalen Verwendungsbedingungen verursacht werden.  
Die Garanzzeit des Produkts beträgt 12 Monate basierend auf der Aktivierungszeit.  
Für Garantieinformationen besuchen Sie bitte die Magene Website: <https://support.magene.com/>  
erwandte Inhalte anzeigen.  
Unser Unternehmen behält sich das Recht vor, die oben genannten Inhalte zu ändern und zu interpretieren.

## CE-ERKLÄRUNGEN

Hiermit erklärt die Qingdao Magene Intelligence Technology Co., Ltd. dass dieses Produkt der Richtlinie 2014/53/EU entspricht. Den vollständigen Text der EU-Konformitätserklärung finden Sie unter folgender Internetadresse: <https://magene.com/certificate.html>  
Bluetooth (2402-2480MHz) Max EIRP beträgt -1,3dBm.  
ANT+ (2457MHz) Max EIRP ist 0dBm.

## FR

### AVERTISSEMENT!

- En raison de la diversité de modèles de vélo, il est impossible pour cet entraîneur de vélo de s'adapter à tous vélos. Il est fortement recommandé de vous rendre dans le magasin de vélos local pour vérifier que votre vélo est compatible avec l'entraîneur de vélo avant de faire l'achat afin d'éviter d'endommager votre cadre de vélo.
- Toute modification de l'entraîneur de vélo, y compris (mais sans s'y limiter) le meulage des composants, l'ajout des rondelles ou l'inversion incorrecte du convertisseur d'engrenage, pour s'adapter à un vélo est strictement interdite, sinon votre garantie sera invalidée et le risque augmentera. Le fabricant n'est pas responsable des dommages ou des blessures dus à une installation ou une utilisation inappropriée de l'entraîneur de vélo ou à une utilisation incorrecte des accessoires, etc.
- L'entraîneur de vélo est destiné aux utilisateurs pesant moins de 100kg.
- Veuillez consulter votre médecin avant de commencer ou de modifier un programme d'exercice.
- Gardez les enfants et les animaux domestiques loins du cycliste et de l'entraîneur de vélo pendant l'utilisation.
- Ne touchez pas les parties de l'entraîneur de vélo avec les mains ou d'autres objets pendant l'utilisation.
- Utilisez uniquement l'entraîneur de vélo sur une surface stable et à niveau.
- Ne tentez pas de monter ni de démonter le vélo lorsque l'entraîneur de vélo est en fonctionnement.
- Soyez prudent lorsque vous vous tenez debout sur l'entraîneur de vélo.
- Gardez l'entraîneur de vélo à l'écart du feu, de l'eau et d'autres obstacles.
- Utilisez uniquement l'adaptateur secteur fourni avec l'entraîneur de vélo.
- Utilisez uniquement les accessoires approuvés pour l'entraîneur de vélo.
- Assurez-vous que le vélo est correctement monté sur l'entraîneur de vélo avant chaque utilisation.

### TERMES ET CONDITIONS DE GARANTIE

Nous vous remercions pour votre achat du wattmètre Magene. Pendant la période de garantie, un service gratuit sera offert pour réparer toute défaillance causée par des problèmes de qualité du produit dans des conditions normales d'utilisation.

La garantie de 12 mois est valable pour ce produit et la période commence à la date d'activation du produit. Pour plus d'informations sur la garantie, visitez le site Web de Magene: <https://support.magene.com/>  
Voir le contenu connexe.

La société Magene se réserve le droit de modifier et d'interpréter les éléments susmentionnés.

### DÉCLARATION CE

Par la présente, Qingdao Magene Intelligence Technology Co., Ltd. déclare que ce produit est conforme à la Directive 2014/53/UE. Vous trouverez le texte intégral de la déclaration de conformité de l'UE à l'adresse Internet suivante: <https://magene.com/certificate.html>

La EIRP max. du Bluetooth (2402-2480MHz) est de -1,3dBm.

La EIRP max. de l'ANT+ (2457MHz) est de 0dBm.

## IT

### ATTENZIONE!

- La grande varietà di modelli di bicicletta non garantisce la compatibilità della piattaforma da ciclismo con tutte le biciclette. Si consiglia vivamente di recarsi in un negozio di biciclette locale per verificare se la bicicletta è compatibile con la piattaforma da ciclismo prima di acquistare, in modo da non danneggiare il telaio.
- Vietato cambiare la piattaforma da ciclismo per essere compatibile con le biciclette, incluso (ma non limitato a) la rettifica di componenti, l'aggiunta di guarnizioni o l'inversione errata del convertitore aperto, che può invalidare la garanzia e aumentare il rischio. Il produttore non è responsabile per eventuali perdite o lesioni causate da un'installazione impropria, dall'uso di piattaforma da ciclismo o dall'uso improprio di accessori.
- Il peso dell'utente dovrebbe essere inferiore a 100kg.
- Consultare un medico prima di iniziare o modificare il programma di esercizi.
- Durante la guida, tenere i bambini o gli animali domestici lontano da cavalleri e la piattaforma da ciclismo.
- Durante la guida, non toccare le parti della piattaforma da ciclismo con le mani o gli oggetti.
- Si prega di utilizzare la piattaforma da ciclismo solo su terreno liscio.
- Non installare o smontare la bicicletta mentre la piattaforma da ciclismo è in funzione.
- Prestare attenzione quando si guida in piedi sulla piattaforma da ciclismo.
- Tenere lontano da incendi, fonti d'acqua e altri ostacoli della piattaforma da ciclismo.
- Si prega di utilizzare la piattaforma da ciclismo con adattatore di alimentazione.
- Si prega di acquistare accessori per la piattaforma da ciclismo con licenza.
- Assicurarsi che la bicicletta sia montata correttamente sulla piattaforma da ciclismo prima di ogni corsa.

## CONDIZIONI DI GARANZIA

Grazie per aver acquistato il misuratore di potenza Magene. Durante il periodo di garanzia è prevista una copertura gratuita per la riparazione di eventuali guasti causati da problemi di qualità del prodotto in condizioni d'uso normali.

Il periodo di garanzia per il prodotto è di 12 mesi, calcolando dalla data di attivazione.

Per informazioni sulla garanzia, visitare il sito Magene:

<https://support.magene.com/> Visualizza contenuti correlati.

La società si riserva il diritto di modificare e interpretare il contenuto sopraindicato.

## DICHIARAZIONI CE

Con la presente, Qingdao Magene Intelligence Technology Co., Ltd. dichiara che questo prodotto è conforme alla Direttiva 2014/53/UE. Il testo completo della dichiarazione di conformità UE è disponibile al seguente indirizzo internet: <https://magene.com/certificate.html>

Bluetooth (2402-2480MHz) EIRP massimo -1,3dBm.

ANT+ (2457MHz) EIRP massimo 0dBm.

## JA

### 警告!

- 自転車の型番は種類が多いため、バイクレーナースタンドがすべての自転車との互換性が保証されていません。ご購入頂く前に、フレームに破損を与えないように、現地の自転車店に行って自転車バイクレーナースタンドと互換性があるかどうかをテストすることを強くお勧めします。
- 自転車と互換性があるようにバイクレーナースタンドを改造することは厳禁です。部品を研削したり、スパーサーを追加したり、またはリバーシブルハブを不当に反転することなどを含むことがこれらに限られません。これらにより、保証が失効し、リスクが増加する恐れがあります。不当に取り付けてバイクレーナースタンドを使用することまたは部品の誤用などによるいかなる損失または傷害についても、メーカーは責任を負わないものとします。
- ユーザーの体重は100kg未満であること。
- エクササイズプログラムを開始または変更する前に、医者にご相談ください。
- サイクリング時は、お子様やペットをライダーやバイクレーナースタンドに近づけないでください。
- サイクリング時は、バイクレーナースタンドの部品に手や物を触れないでください。
- バイクレーナースタンドは安定した水平面のみで使用してください。
- バイクレーナースタンドの運転中は、自転車の取り付けや取り外しを行わないでください。
- バイクレーナースタンドに立ち乗りする時は注意してください。
- バイクレーナースタンドは火元、水源及びその他の障害物から離れること。
- バイクレーナースタンドに付属の電源アダプターを使ってください。
- 承認されたバイクレーナースタンド付属品を購入し使用してください。
- サイクリングするたびに、自転車がバイクレーナースタンドに正しく取り付けられていることを事前に確認してください。

### 保証条項

Magene電力計をお選び頂き、ありがとうございます。保証期間の間に、通常の使用条件の下で製品の品質問題による故障が発生した場合、無償保証が提供されます。

本製品の保証期間は12か月であり、有効になった時点を目安とします。

保証の詳細については、MageneのWebサイトを参照してください: <https://support.magene.com/> 関連コンテンツの表示。

当社は、上記の内容を変更・解釈する権利を留保します。

### CE適合宣言書

ここに、Qingdao Magene Intelligence Technology Co., Ltd. は、当該製品が指令 2014/53/EU に準拠していることを宣言します。EU適合宣言書の全文は、次のインターネットアドレス(IPアドレス)からアクセスすることができます。  
<https://magene.com/certificate.html>

Bluetooth (2402 ~ 2480MHz) の最大 EIRP は -1.3dBm です。

ANT+ (2457MHz) の最大 EIRP は 0dBm です。

## KO

### 경고!

- 자전거의 모델종류가 매우 많아 자전거 트레이너와 모든 자전거가 모두 호환될 수 있다고 보장할 수 없습니다. 자전거를 구입하기 전에 프레임에 손상을 초래할 수 있으므로, 현지 자전거 가게에 가서 자전거 트레이너와 호환성을 갖고 있는지 테스트하시기 바랍니다.
- 구성품 연마, 워셔 추가 또는 기어 전환기의 오류 역전을 포함하여(단 이에 한하지 않음), 자전거와 호환되도록 자전거 트레이너를 수정하는 것은 엄격히 금지하며, 이는 보증 무효화되고 위험이 증가합니다. 부적당한 설치, 자전거 트레이너의 사용 또는 부속품의 오용으로 인한 손실이나 상해에 대하여 제조사는 책임을 지지 않습니다.
- 사용자 몸무게는 100kg 이하여야 합니다.
- 운동 계획을 시작하거나 수정 전에는 의사와 상의하십시오.
- 사이클링시, 어린이나 애완동물이 라이더나 자전거 트레이너에 접근을 금지합니다.
- 사이클링시 손이나 물체로 자전거 트레이너의 부품에 접촉을 금지합니다.
- 자전거 트레이너는 평평한 바닥에서만 사용하십시오.
- 자전거 트레이너가 운행될 때에는 자전거를 조립하거나 분해하지 마십시오.
- 자전거 트레이너에 서서 사이클링을 할 때는 반드시 조심해야 합니다.
- 자전거 트레이너는 화재, 물, 기타 장애물에서 멀리 떨어져 있어야 합니다.
- 자전거 트레이너에 부대할 전원 어댑터를 사용하십시오.
- 라이센스가 허락된 자전거 트레이너 부품을 구입하세요.
- 매번 사이클링전에 자전거 트레이너에 정확히 설치되었는지를 확인하세요.

## 보증수리 조항

Magene 전력계를 구입해 주셔서 감사합니다.

보증 기간 동안 정상적인 사용 조건하에서 제품 품질 문제로 인해 발생한 문제를 해결할 수 있도록 무료 보증을 제공해 드립니다.

제품 보증 기간은 12개월이며 활성화 시간을 기준으로 합니다.

보증에 대한 자세한 내용은 Magene 웹 사이트를 참조하십시오: <https://support.magene.com/> 관련 항목 보기.

당사는 위의 내용에 대한 수정권과 해석권을 보유합니다.

## CE 진술서

이로써 Qingdao Magene Intelligence Technology Co., Ltd. 는 본 제품이 2014/53/EU 지침을 준수함을 선언합니다.

EU 적합성 선언서의 전체 내용은 다음 인터넷 주소에서 찾아볼 수 있습니다. <https://magene.com/certificate.html>

Bluetooth (2402-2480MHz) Max EIRP는 -1,3dBm 입니다.

ANT+ (2457MHz) Max EIRP는 0dBm 입니다.

## PT

### AVISO!

- Não podemos garantir que a plataforma de ciclismo seja compatível com todas as bicicletas devido à grande variedade de modelos de bicicletas. Recomendamos fortemente que você vá à loja de bicicletas local para testar sua compatibilidade com esta plataforma de ciclismo antes de comprar para evitar danos ao seu quadro da bicicleta.
- São estritamente proibidas as modificações na plataforma de ciclismo para ser compatível com a bicicleta, incluindo (mas não limitado a) retificação de componentes, adição de espaçadores ou conversor de abertura de marcha invertido incorretamente, os quais anularão sua garantia e aumentarão seu risco. O fabricante não se responsabiliza por qualquer perda ou lesão causada por instalação inadequada e uso indevido da plataforma de ciclismo ou de acessórios.
- O peso do usuário deve ser inferior a 100kg.
- Consulte seu médico antes de iniciar ou modificar programa de exercícios.
- Mantenha crianças e animais de estimação longe da plataforma de ciclismo enquanto estiver em uso.
- Não coloque as mãos ou objetos nas partes móveis da plataforma de ciclismo enquanto estiver em uso.
- Use a plataforma de ciclismo apenas em uma superfície estável e nivelada.
- Não tente montar e desmontar a bicicleta enquanto a plataforma de ciclismo estiver em execução.
- Tenha cuidado ao ficar em pé enquanto estiver andando na plataforma de ciclismo.
- Mantenha a plataforma de ciclismo longe de fogo, água e outros obstáculos.
- Use o adaptador de energia fornecido com a plataforma de ciclismo.
- Compre e use acessórios de plataforma de ciclismo aprovados.
- Verifique se a bicicleta está devidamente presa à plataforma de ciclismo antes de cada ciclismo.

### GARANTIA

Obrigado por comprar o medidor de energia Magene. É oferecida uma garantia gratuita durante o período de garantia para reparos de qualquer falha causada por problemas de qualidade do produto em condições normais de uso.

O período de garantia do produto é de 12 meses, sujeito ao tempo de ativação.

Para obter informações sobre garantia, visite o site Magene: <https://support.magene.com/> Ver o conteúdo relacionado.

A empresa reserva-se o direito de modificar e interpretar o conteúdo acima.

### DECLARAÇÕES CE

Pelo presente, a Qingdao Magene Intelligence Technology Co., Ltd. declara que este produto está de acordo com a Diretriz 2014/53/UE. O texto completo da declaração de conformidade da UE está disponível no seguinte endereço da internet: <https://magene.com/certificate.html>

Bluetooth (2402-2480MHz) Max EIRP é de -1,3dBm.

ANT+ (2457MHz) Max EIRP é de 0dBm.

## ES

### ¡ADVERTENCIA!

- Existe una amplia gama de modelos de bicicletas y no es posible garantizar que la mesa de ciclismo sea compatible con todas las bicicletas. Se recomienda encarecidamente que acuda a la tienda de bicicletas local para comprobar la compatibilidad de su bicicleta con la mesa de ciclismo antes de comprarla, para evitar daños en el bastidor.
- No debe alterar la mesa de ciclismo para que sea compatible con su bicicleta, incluyendo (pero sin limitarse a) rectificar componentes, añadir arandelas o invertir incorrectamente el convertidor de engranaje abierto, lo que anulará su garantía y aumentará el riesgo. El fabricante no es responsable de los daños y perjuicios causados por una instalación incorrecta, el uso inapropiado de la mesa de ciclismo o el mal uso de los accesorios, etc.
- El peso del usuario debe ser inferior a 100kg.
- Consulte a su médico antes de empezar o cambiar su programa de ejercicios.
- No permita que los niños o las mascotas se acerquen al ciclista ni a la mesa de ciclismo durante el ciclismo.
- No toque partes de la mesa de ciclismo con sus manos u objetos durante el ciclismo.
- Utiliza la mesa de ciclismo sólo en terrenos lisos.
- No monte ni desmonte la bicicleta cuando la mesa de ciclismo esté en funcionamiento.
- Tenga cuidado durante el ciclismo de pie sobre la mesa de ciclismo.
- Mantenga la mesa de ciclismo alejada del fuego, el agua y otros obstáculos.
- Utilice el adaptador de corriente que viene con la mesa de ciclismo.
- Compre accesorios homologados para la mesa de ciclismo.
- Asegúrese de que la bicicleta está bien montada en la mesa de ciclismo antes de cada ciclismo.



## ARTÍCULOS DE GARANTÍA

Gracias por adquirir el medidor de potencia Magene. Se le ofrecerá una garantía gratuita durante el periodo de garantía para reparar cualquier fallo provocado por problemas de calidad del producto bajo condiciones de uso normales.

El producto tiene el plazo de garantía de 12 meses que se calcula a partir del tiempo de activación. Para obtener información sobre la garantía, visite el sitio web Magene: <https://support.magene.com/> Ver contenido relevante.

Nuestra compañía se reserva los derechos de modificación e interpretación del contenido precedente.

## DECLARACIÓN DE CE

Por la presente, Qingdao Magene Intelligence Technology Co., Ltd. declara que este producto cumple con la Directiva 2014/53/EU. El texto completo de la declaración de conformidad de la EU está disponible en la siguiente dirección de internet: <https://magene.com/certificate.html>  
EIRP máximo del Bluetooth (2402-2480MHz) es -1,3dBm.  
EIRP máximo del ANT+ (2457MHz) es 0dBm.

## RU

### ВНИМАНИЕ!

- Существует множество типов велосипедов, поэтому невозможно гарантировать, что данный станок совместим со всеми велосипедами. Настоятельно рекомендуется перед покупкой посетить местный магазин велосипедов, чтобы проверить, совместим ли ваш велосипед с установкой, во избежание повреждения велосипедной рамы.
- Категорически запрещается вносить изменения в велостанок для совмещения с велосипедом, включая (но не ограничиваясь этим) шлифование компонентов, добавление шайб или неправильная перестановка адаптеров, что приведет к аннулированию Вашей гарантии. Производитель не несет ответственности за любые повреждения, вызванные неправильной установкой и использованием тренажера или неправильным использованием аксессуаров.
- Вес пользователя не должен превышать 100кг.
- Проконсультируйтесь с врачом, прежде чем начинать или изменять свою программу тренировок.
- Не подпускайте детей или домашних животных близко к велостанку во время его использования.
- Не касайтесь руками или предметами движущихся частей тренажера.
- Используйте велостанок только на устойчивой поверхности.
- Не пытайтесь установить или снять велосипед во время работы велостанка.
- Будьте осторожны, стоя во время езды на тренажере.
- Велостанок необходимо держать вдали от источника огня, воды и других помех.
- Используйте зарядный адаптер только из комплекта велостанка.
- Используйте аксессуары только из комплекта велостанка.
- Перед каждой поездкой убедитесь, что велосипед надежно установлен в тренажере.

### УСЛОВИЯ ГАРАНТИЙНОГО РЕМОНТА

Спасибо за покупку измерителя мощности Magene. Во время гарантийного периода будет предложена бесплатная гарантия на устранение любой неисправности, вызванной из-за проблем качества продукта при нормальных условиях эксплуатации.

Гарантийный срок на продукцию составляет 12 месяцев, зависит от времени активации.

Для получения информации о гарантии посетите сайт Magene: <https://www.magene.cn/support.html>

Посмотреть соответствующий контент

Наша компания оставляет за собой право изменять и интерпретировать вышеуказан.

### ЗАЯВЛЕНИЯ CE

Настоящим компания Qingdao Magene Intelligence Technology Co., Ltd. заявляет, что это изделие соответствует Директиве 2014/53/ЕС. Полный текст декларации о соответствии ЕС размещен по следующему адресу в Интернете: <https://magene.com/certificate.html>  
Bluetooth (2402-2480MHz) Макс. EIRP равен -1,3дБм.  
ANT+ (2457MHz) Макс. EIRP равен 0дБм.

## ZT

### 警告!

- 自行車型號種類繁多，無法保證騎行台與所有自行車兼容。強烈建議您在購買前，前往當地的自行車店測試您的自行車是否與騎行台兼容，以免對您的車架造成損壞。
- 嚴禁更改騎行台來兼容自行車，包括（但不限於）磨削組件、添加墊圈或不正確地反轉開檔轉換器，這些會使您的保修失效並增加風險。因不當安裝、使用騎行台或誤用配件等造成的任何損失或傷害，廠家不予負責。
- 用戶體重應小於100kg。
- 開始或更改鍛煉計劃前，請諮詢醫生。
- 騎行時，請勿讓小孩或寵物靠近騎手和騎行台。
- 騎行時，請勿用手或物體觸碰騎行台的部件。
- 請僅在平穩地面上使用騎行台。
- 當騎行台運行時，請勿安裝或拆卸自行車。
- 在騎行台上站立騎行時請務必小心。
- 騎行台遠離火源、水源及其他障礙物。
- 請使用騎行台自帶電源適配器。
- 請購買使用許可的騎行台配件。
- 每次騎行前，請確保自行車正確安裝在騎行台上。

## 保固條款

感謝您購買邁金騎行台產品，凡正常使用情況下由產品質量問題造成的故障，在質保期限內，我們給予免費保修。  
產品質保期限為12個月，以激活時間為準。  
有關保修的信息，請訪問邁金官網：<https://support.magene.com/> 查看相關內容。  
本公司保留上述內容的修改權和解釋權。

## NCC

取得審驗證明之低功率射頻器材，非經核准，公司、商號或使用者均不得擅自變更頻率、加大功率或變更原設計之特性及功能。

低功率射頻器材之使用不得影響飛航安全及干擾合法通信；經發現有干擾現象時，應立即停用，並改善至無干擾時方得繼續使用。前述合法通信，指依電信管理法規定作業之無線電通信。低功率射頻器材須忍受合法通信或工業、科學及醫療用電波輻射性電機設備之干擾。

## ZH

## 警告！

- 自行車型號種類繁多，無法保證騎行台與所有自行車兼容。強烈建議您在購買前，前往當地的自行車店測試您的自行車是否與騎行台兼容，以免對您的車架造成損壞。
- 嚴禁更改騎行台來兼容自行車，包括（但不限於）磨削組件、添加墊圈或不正確地反轉開檔轉換器，這些會使您的保修失效並增加風險。因不當安裝、使用騎行台或誤用配件等造成的任何損失或傷害，廠家不予負責。
- 用戶體重應小於100kg。
- 開始或更改鍛煉計劃前，請諮詢醫生。
- 騎行時，請勿讓小孩或寵物靠近騎手和騎行台。
- 騎行時，請勿用手或物體接觸騎行台的部件。
- 請僅在平穩地面上使用騎行台。
- 當騎行台運行時，請勿安裝或拆卸自行車。
- 在騎行台上站立騎行時請務必小心。
- 騎行台遠離火源、水源及其他障礙物。
- 請使用騎行台自帶電源適配器。
- 請購買使用許可的騎行台配件。
- 每次騎行前，請確保自行車正確安裝在騎行台上。

## 保修條款

感謝您購買邁金騎行台產品，凡正常使用情況下由產品質量問題造成的故障，在質保期限內，我們給予免費保修。  
產品質保期限為12個月，以激活時間為準。  
有關保修的信息，請訪問邁金官網：<https://support.magene.com/> 查看相關內容。  
本公司保留上述內容的修改權和解釋權。

## 微功率短距離無線電發射設備目錄和技術要求

1. 具體條款：F類設備  
使用頻率：2457MHz  
發射功率限值：10mW  
頻率容限：75kHz  
使用場景：用於ANT+智能硬件控制、數據傳輸  
天線類型：PIFA天線  
性能/控制：傳輸距離約10米（空曠無遮擋區域）  
調整及開關產品的使用方法：插拔電即開關微功率無線發射器，一方傳輸，一方接收，進行數據傳輸
  2. 不得擅自改變使用場景或使用條件、擴大發射頻率範圍、加大發射功率（包括額外加裝射頻功率放大器），不得擅自更改發射天線。
  3. 不得對其他合法的無線電台（站）產生有害干擾，也不得提出免受有害干擾保護。
  4. 應當承受輻射射頻能量的工業、科學及醫療（ISM）應用設備的干擾或其他合法的無線電台（站）干擾。
  5. 如對其他合法的無線電台（站）產生有害干擾時，應立即停止使用，並採取措施消除干擾後方可繼續使用。
  6. 在航空器內和依據法律法規、國家有關規定、標準劃設的射電天文台、氣象雷達站、衛星地球站（含測控、測距、接收、導航）等軍民無線電台（站）、機場等的電磁環境保護區域內使用微功率設備，應當遵守電磁環境保護及相關行業主管部門的規定。
  7. 禁止在以機場跑道中心點為圓心、半徑5000米的區域內使用各類模型遙控器。
  8. 微功率設備使用時，溫度：-10~50°C、電壓：12V/48V
- 使用微功率短距離無線電發射設備應當符合國家無線電管理有關規定。

## 產品中有害物質的名稱及含量

部件名稱	有毒有害物質或元素					
	鉛(Pb)	汞(Hg)	鎘(Cd)	六價鉻(Cr(VI))	多溴聯苯(PBB)	多溴二苯醚(PBDE)
印刷電路板組件	×	○	○	○	○	○
慣性輪等金屬部件	×	○	○	○	○	○
電纜/電纜組件/連接器	×	○	○	○	○	○
外殼等塑料部件	○	○	○	○	○	○
包裝印刷件	○	○	○	○	○	○

本表格依據 SJ/T 11364 的規定編制。

○：表示該有害物質在該部件所有均質材料中的含量均在 GB/T 26572 規定的限量要求以下。

×：表示該有害物質至少在該部件的某一均質材料中的含量超出 GB/T 26572 規定的限量要求。

\* 產品、說明書等印刷的環保使用期限標識標明的含義是：邁金騎行台產品的環保使用期限為5年。







## **QUICK START GUIDE AND INSTRUCTIONS**

Thank you for purchasing the T110 Smart Trainer.  
Please read the instructions carefully before using it.

If you have any questions, please contact us immediately:

- Email: support@magene.com
- Website: www.magene.com

### **UNPACKING P1**

After you take out the trainer and accessories from the package, please make sure to keep the original product packaging for future transportation or storage. When encountering after-sales problems, please be sure to use the original packaging for mailing; the manufacturer will not be responsible for any damage caused by mailing in non-original packaging. If the original packaging is lost, please contact your local distributor or after-sales service personnel.

- (1) T110 Smart Trainer
- (2) AC Power Adapter
- (3) Hex Tool
- (4) Quick Release Skewer
- (5) Freehub Body Spacer
- (6) Adapter A - Quick Release End Cap (installed already)
- (7) Adapter B - For 130mm and 135mm Quick Release
- (8) Adapter C - Thru-axle cap
- (9) Adapter D - 12\*142/12\*148 Thru-axle open gear converter

Caution:

1. The following diagrams of tools and accessories are printed only to illustrate the use of the product, and the configuration of the real product parts is subject to the packing list.
2. Thru Axle bicycle frame must use Thru Axle conversion kit.

### **INSTALL THE TRAINER P2**

1. Remove the main trainer unit from the box, and expand the trainer.
2. Take out the legs and insert them into the bolts (note that the square hole of the arm is at the bottom and the round hole is at the top).
3. Install the legs on the trainer, with white leg on the white arm, and then tighten the nuts and install the protective caps.
4. When installing, pay attention to the left and right direction of the legs, the long side should be placed near the drive side.

### **INSTALLING CASSETTE P3**

Before installation, please prepare cassette, wrench and sleeve.

1. To install a compatible 9, 8 or 10 speed cassette, it will be necessary to use the included 1.85mm spacer, but not so for 11 or 12 speed cassette.
2. Put the cassette onto the freehub in order from big to small size accordingly, paying attention to the alignment of the freehub spline.
3. Install the cassette cover and tighten it roughly by hand.
4. Wrap the card fly chain whip around the flywheel, then insert it into the flywheel dedicated sleeve, and tighten the flywheel with an adjustable wrench.

### **INSTALLING QUICK RELEASE P4**

1. The quick release end cap on the freehub has been installed by the manufacturer.
2. Choose the quick release matching the specification of your bicycle, and insert the quick release adapter into the non-drive side of the trainer.
3. Insert the quick release skewer into the non-drive side of the trainer; insert the conical springs into the left and right ends of the quick release skewer separately, with the tips facing inward, and then screw on the nuts.

## INSTALLING THRU AXLE ADAPTER P5

1. Use a 5mm hex to unscrew the quick release end cap on the freehub body counterclockwise.
2. Use a wrench to tighten the thru axle end cap.
3. Choose the thru axle matching the specification of your bicycle, and insert the thru axle adapter into the non-drive side of the trainer.

## INSTALLING XDR FREEHUB BODY P6

SRAM XDR freehub, thru axle end caps need to be purchased separately.

1. Use a 5mm hexagon socket to counterclockwise unscrew the quick release end cap on the freehub body.
2. Pull out the original freehub.
3. Insert your XDR freehub into the trainer, turn it counterclockwise and keep pressing the freehub and detent of the freehub until the freehub is fully installed in place.
4. Screw on the end cap of the thru axle and use a wrench to lock it in place.
5. Choose the thru axle matching the specification of your bicycle, and insert the adapter of the thru axle into the non-drive side of the trainer.

## ATTACHING YOUR BICYCLE (QUICK RELEASE) P7

1. Shift your bicycle chain into the smallest sprocket in the front and rear.
2. Release the rear brake, open the quick release skewer, lift the bicycle frame, and then remove your rear wheel.
3. Push the quick release skewer on the trainer to the "open" mode, seat the bike on the trainer, and then align the chain with the smallest sprocket on the trainer.
4. Lift the front wheel up while pressing down on the saddle to ensure the bicycle is fully seated on the trainer.
5. Tighten the quick release nuts while turning the quick release skewer on and off frequently until resistance is felt.
6. Lock the thru axle and wiggle the bicycle frame to ensure that the frame does not fell off from the trainer.

## ATTACHING YOUR BICYCLE (THRU AXLE) P8

1. Shift your bicycle chain into the smallest sprocket.
2. Release the rear brake, remove the thru axle, lift the bicycle frame, and then remove your rear wheel.
3. Align the rear axle with the trainer's axle hole in the center, insert the barrel axle, and then aligning the chain with the smallest sprocket.
4. Lock the thru axle and wiggle the bicycle frame to ensure that the frame does not fell off from the trainer.

### CAUTION!

- Failure to properly tighten the quick release skewer or thru axle may result in property damage or personal injury.
- If you are unsure of proper assembly, please consult your local bike shop or contact us for assistance.
- Failure to properly assemble the quick release skewer or thru axle, please do not ride the trainer.
- Do NOT ride the trainer until the quick release skewer or thru axle is tightened, thus avoiding damages.
- Do NOT adjust the quick release skewer or thru axle while someone is sitting or standing on the bike.

## ACTIVATING AND PERFORMING A SPIN DOWN

### CAUTION! The new product must be activated before first use.

1. Turn on Bluetooth of your cell phone.
2. Download Magene Utility App and connect to the trainer.
3. Select your device to connect and activate.

### CAUTION! A spin down should performed for the new product before first use.

1. Download Magene Utility App and connect to the trainer.
2. Ride with 150W power for 10 minutes to achieve the best efficiency of the drive chain.
3. Follow the prompts for a spin down.
4. The spin down should be repeated once every two weeks to ensure accurate power measurement.



**CONNECTING TRAINER P9**

**Note! The hardware and software you use must support BLE 4.0 and above version. A PC without built-in Bluetooth may be used with a Bluetooth receiver (sold separately).**

1. Power on the trainer and the indicator light on the housing will illuminate.
2. Download Onelap App and register your account.
3. Select the sports mode as "bike".
4. Select the corresponding trainer in the device list to connect.
5. Select your workout program and start riding.

**MODES AND INDICATORS P10**

The trainer has two indicators.

**Led Indicator Description**

System status indicator ①	Connection indicator ②
Power-on status: the red and blue indicator flash twice alternately	Not connected: the blue indicator flashes
Standby status: the blue indicator flashes	
Riding status: the blue indicator is on	Connected: the blue indicator is on

**PRODUCT SPECIFICATION**

Model	P0102019A
Rated voltage/Current	DC 12V, 3A
Maximum simulated slope	6%
Max power	600W
Power accuracy	±5%
Rotational inertia	1.64kg*m <sup>2</sup>
Noise level	<56dB @1.5m&30km/h
Wireless protocol	Bluetooth
Size (unfolded)	600*500*450mm
Size (folded)	600*250*510mm
Overall weight	9.7kg
Compatible cassette	Shimano, SRAM 8-11 speed cassette Shimano 12-speed cassette SRAM XDR 12-speed cassette
Compatible bicycle frame	130/135mm Quick Release 12*142/12*148mm Thru Axle
Compatible wheels	26"-29"MTB 700C RD