

FCC Radio Test Report

FCC ID: 2ALZB-D14MED

Report No. : BTL-FCCP-3-2011T053
Equipment : Gateway
Model Name : SYS-D14-MED-XXXX-1XX0-CX (X=0-9 ,A-Z ,a-z or blank)
Brand Name : SECO
Applicant : SECO S.p.A
Address : Via Achille Grandi 20, 52100 AREZZO Italy

Radio Function : WLAN 2.4 GHz

FCC Rule Part(s) : FCC Part15, Subpart C (15.247)
Measurement Procedure(s) : ANSI C63.10-2013

Date of Receipt : 2020/11/18
Date of Test : 2020/11/18 ~ 2020/12/16
Issued Date : 2021/2/1

The above equipment has been tested and found in compliance with the requirement of the above standards by BTL Inc.

Prepared by

Peter Chen, Engineer

Approved by

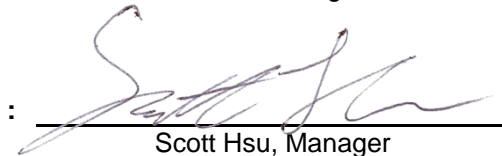
Scott Hsu, Manager



BTL Inc.

No.18, Ln. 171, Sec. 2, Jiuzong Rd., Neihu Dist., Taipei City 114, Taiwan

Tel: +886-2-2657-3299

Fax: +886-2-2657-3331

Web: www.newbtl.com

Declaration

BTL represents to the client that testing is done in accordance with standard procedures as applicable and that test instruments used has been calibrated with standards traceable to international standard(s) and/or national standard(s).

BTL's reports apply only to the specific samples tested under conditions. It is manufacture's responsibility to ensure that additional production units of this model are manufactured with the identical electrical and mechanical components. **BTL** shall have no liability for any declarations, inferences or generalizations drawn by the client or others from **BTL** issued reports.

This report is the confidential property of the client. As a mutual protection to the clients, the public and ourselves, the test report shall not be reproduced, except in full, without our written approval.

BTL's laboratory quality assurance procedures are in compliance with the **ISO/IEC 17025** requirements, and accredited by the conformity assessment authorities listed in this test report.

BTL is not responsible for the sampling stage, so the results only apply to the sample as received.

The information, data and test plan are provided by manufacturer which may affect the validity of results, so it is manufacturer's responsibility to ensure that the apparatus meets the essential requirements of applied standards and in all the possible configurations as representative of its intended use.

Limitation

For the use of the authority's logo is limited unless the Test Standard(s)/Scope(s)/Item(s) mentioned in this test report is (are) included in the conformity assessment authorities acceptance respective.

Please note that the measurement uncertainty is provided for informational purpose only and are not use in determining the Pass/Fail results.

CONTENTS

REPORT ISSUED HISTORY	4
1 SUMMARY OF TEST RESULTS	5
1.1 TEST FACILITY	6
1.2 MEASUREMENT UNCERTAINTY	6
1.3 TEST ENVIRONMENT CONDITIONS	6
2 GENERAL INFORMATION	7
2.1 DESCRIPTION OF EUT	7
2.2 TEST MODES	8
2.3 BLOCK DIAGRAM SHOWING THE CONFIGURATION OF SYSTEM TESTED	9
2.4 SUPPORT UNITS	9
3 AC POWER LINE CONDUCTED EMISSIONS TEST	10
3.1 LIMIT	10
3.2 TEST PROCEDURE	10
3.3 DEVIATION FROM TEST STANDARD	10
3.4 TEST SETUP	11
3.5 TEST RESULT	11
4 RADIATED EMISSIONS TEST	12
4.1 LIMIT	12
4.2 TEST PROCEDURE	13
4.3 DEVIATION FROM TEST STANDARD	13
4.4 TEST SETUP	14
4.5 EUT OPERATING CONDITIONS	15
4.6 TEST RESULT – 30 MHZ TO 1 GHZ	15
4.7 TEST RESULT – ABOVE 1 GHZ	15
5 LIST OF MEASURING EQUIPMENTS	16
6 EUT TEST PHOTO	17
7 EUT PHOTOS	17
APPENDIX A AC POWER LINE CONDUCTED EMISSIONS	18
APPENDIX B RADIATED EMISSIONS - 30 MHZ TO 1 GHZ	23
APPENDIX C RADIATED EMISSIONS - ABOVE 1 GHZ	26

REPORT ISSUED HISTORY

Report Version	Description	Issued Date
R00	Original Issue.	2021/2/1

1 SUMMARY OF TEST RESULTS

Test procedures according to the technical standards.

FCC Part 15, Subpart C (15.247)				
Standard(s) Section	Description	Test Result	Judgement	Remark
15.207	AC Power Line Conducted Emissions	APPENDIX A	Pass	-----
15.205 15.209 15.247(d)	Radiated Emissions	APPENDIX B APPENDIX C	Pass	-----

NOTE:

- (1) "N/A" denotes test is not applicable in this Test Report.
- (2) The report format version is TP.1.1.1.
- (3) The Equipment under test (EUT) is the Gateway, FCC ID: 2ALZB-D14MED. The test data contained in this report pertains only to the emission due to the EUT's transmitter. For other test data can be refer report No.: 170524-01.TR04 (This FCC ID is change ID based on Intel Corporation, the original application information follow as model: 9260NGW, FCC ID: PD99260NG, approved on 07/24/2017)
- (4) After spot check, this revision does not change original radio parameters.

1.1 TEST FACILITY

The test facilities used to collect the test data in this report:

No. 68-1, Ln. 169, Sec. 2, Datong Rd., Xizhi Dist., New Taipei City 221, Taiwan

The test sites and facilities are covered under FCC RN: 674415 and DN: TW0659.

C05
 CB08
 CB11
 CB15
 CB16

1.2 MEASUREMENT UNCERTAINTY

The reported uncertainty of measurement $y \pm U$, where expanded uncertainty U is based on a standard uncertainty multiplied by a coverage factor of $k = 2$, providing a level of confidence of approximately **95 %**.

The measurement instrumentation uncertainty considerations contained in CISPR 16-4-2. The BTL measurement uncertainty is less than the CISPR 16-4-2 U_{cispr} requirement.

A. AC power line conducted emissions test:

Test Site	Method	Measurement Frequency Range	U (dB)
C05	CISPR	150 kHz ~ 30MHz	3.44

B. Radiated emissions test :

Test Site	Measurement Frequency Range	U,(dB)
CB15	0.03 GHz ~ 0.2 GHz	4.17
	0.2 GHz ~ 1 GHz	4.72
	1 GHz ~ 6 GHz	5.21
	6 GHz ~ 18 GHz	5.51
	18 GHz ~ 26 GHz	3.69
	26 GHz ~ 40 GHz	4.23

NOTE:

Unless specifically mentioned, the uncertainty of measurement has not been taken into account to declare the compliance or non-compliance to the specification.

1.3 TEST ENVIRONMENT CONDITIONS

Test Item	Environment Condition	Test Voltage	Tested by
AC Power Line Conducted Emissions	23 °C, 65 %	AC 120V	Nero Hsieh
Radiated emissions below 1 GHz	Refer to data	AC 120V	Jay Kao
Radiated emissions above 1 GHz	Refer to data	AC 120V	Jay Kao

2 GENERAL INFORMATION

2.1 DESCRIPTION OF EUT

Equipment	Gateway		
Model Name	SYS-D14-MED-XXXX-1XX0-CX (X=0-9 ,A-Z ,a-z or blank)		
Brand Name	SECO		
Model Difference	Differ in CPU and market.		
		Model Name	CPU
	SYS-D14-MED-XXXX-1 XX0-CX	SYS-D14-MED-3216-1W00-C1	E3930, 1.8GHz
		SYS-D14-MED-4216-1W00-C1	E3940, 1.8GHz
SYS-D14-MED-5326-1W00-C1		E3950, 2.0GHz	
Power Source	DC voltage supplied from External Power Supply.		
Power Rating	I/P: 100-240V~, 2.0-1.0A, 50-60Hz O/P: 18.0Vdc 3.78A 69.0W		
Products Covered	1 * Adapter: EDAC / EM10681V		
WIFI+BT Module	Intel / 9260NGW		
Operation Band	2400 MHz ~ 2483.5 MHz		
Operation Frequency	2412 MHz ~ 2462 MHz		
Test Model	SYS-D14-MED-5326-1W00-C1		
Sample Status	Engineering Sample		
EUT Modification(s)	N/A		

NOTE:

- (1) For a more detailed features description, please refer to the manufacturer's specifications or the user's manual.
- (2) Channel List:

Channel	Frequency (MHz)	Channel	Frequency (MHz)	Channel	Frequency (MHz)
01	2412	05	2432	09	2452
02	2417	06	2437	10	2457
03	2422	07	2442	11	2462
04	2427	08	2447		

- (3) Table for Filed Antenna:

Antenna	Manufacture	Part number	Type	Connector	Frequency Range (MHz)	Gain (dBi)
Main	Pulse Electronics	W1043	Dipole	RP SMA plug	2400-2500	1
					5150-5350	3
					5470-5725	2.5
					5725-5850	1
Aux	Pulse Electronics	W1043	Dipole	RP SMA plug	2400-2500	1
					5150-5350	3
					5470-5725	2.5
					5725-5850	1

2.2 TEST MODES

Test Items	Test mode	Channel	Note
AC power line conducted emissions	Normal/Idle	-	-
Transmitter Radiated Emissions (below 1GHz)	TX Mode_IEEE 802.11b	06	-
Transmitter Radiated Emissions (above 1GHz)	TX Mode_IEEE 802.11b	01/11	Bandedge
	TX Mode_IEEE 802.11g		
	TX Mode_IEEE 802.11n (HT20)	03/09	
	TX Mode_IEEE 802.11n (HT40)		
Transmitter Radiated Emissions (above 1GHz)	TX Mode_IEEE 802.11b	01/06/11	Harmonic
	TX Mode_IEEE 802.11g		
	TX Mode_IEEE 802.11n (HT20)	03/06/09	
	TX Mode_IEEE 802.11n (HT40)		

NOTE:

- (1) The Radiated emissions test was verified based on the worst conducted power and Bandwidth test results reported in the original report.
- (2) For radiated emission band edge test, both Vertical and Horizontal are evaluated, but only the worst case (Vertical) is recorded.
- (3) All X, Y and Z axes are evaluated, but only the worst case (Y axis) is recorded.
- (4) There were no emissions found below 30 MHz within 20 dB of the limit.

2.3 BLOCK DIAGRAM SHOWING THE CONFIGURATION OF SYSTEM TESTED

Equipment letters and Cable numbers refer to item numbers described in the tables of clause 2.4.

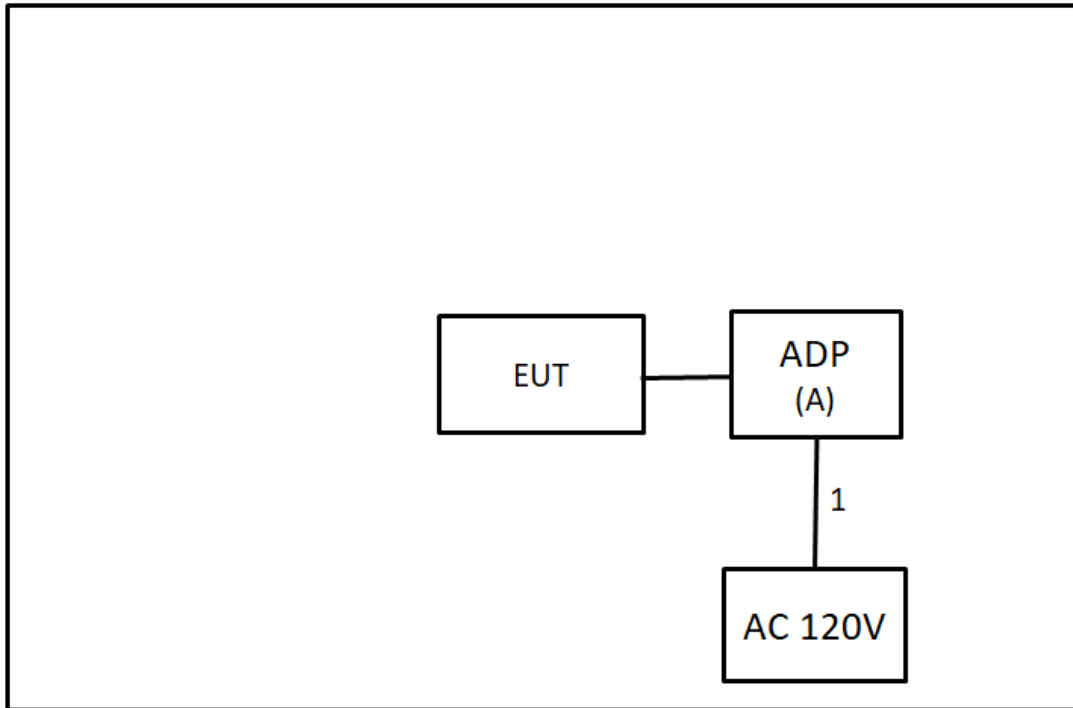

2.4 SUPPORT UNITS

Item	Equipment	Brand	Model No.	Series No.	Remarks
A	Adapter	EDAC	EM10681V	N/A	Supplied by test requester

Item	Shielded	Ferrite Core	Length	Cable Type	Remarks
1	N/A	N/A	1.5m	Power cord	Furnished by test lab.

3 AC POWER LINE CONDUCTED EMISSIONS TEST

3.1 LIMIT

Frequency (MHz)	Limit (dB μ V)	
	Quasi-peak	Average
0.15 - 0.5	66 - 56 *	56 - 46 *
0.50 - 5.0	56	46
5.0 - 30.0	60	50

NOTE:

- (1) The tighter limit applies at the band edges.
- (2) The limit of " * " marked band means the limitation decreases linearly with the logarithm of the frequency in the range.
- (3) The test result calculated as following:
 Measurement Value = Reading Level + Correct Factor
 Correct Factor = Insertion Loss + Cable Loss + Attenuator Factor (if use)
 Margin Level = Measurement Value – Limit Value
 Calculation example:

Reading Level		Correct Factor		Measurement Value
38.22	+	3.45	=	41.67

Measurement Value		Limit Value		Margin Level
41.67	-	60	=	-18.33

The following table is the setting of the receiver.

Receiver Parameter	Setting
Attenuation	10 dB
Start Frequency	0.15 MHz
Stop Frequency	30 MHz
IF Bandwidth	9 KHz

3.2 TEST PROCEDURE

- a. The EUT was placed 0.8 m above the horizontal ground plane with the EUT being connected to the power mains through a line impedance stabilization network (LISN).
 All other support equipment were powered from an additional LISN(s).
 The LISN provides 50 Ohm/50uH of impedance for the measuring instrument.
- b. Interconnecting cables that hang closer than 40 cm to the ground plane shall be folded back and forth in the center forming a bundle to keep the cable above 40 cm.
- c. Excess I/O cables that are not connected to a peripheral shall be bundled in the center.
 The end of the cable will be terminated, using the correct terminating impedance.
 The overall length shall not exceed 1 m.
- d. The LISN is spaced at least 80 cm from the nearest part of the EUT chassis.
- e. For the actual test configuration, please refer to the related Item - EUT TEST PHOTO.

NOTE:

- (1) In the results, each reading is marked as Peak, QP or AVG per the detector used.
 BW=9 kHz (6 dB Bandwidth)
- (2) All readings are Peak unless otherwise stated QP or AVG in column of Note. Both the QP and the AVG readings must be less than the limit for compliance.

3.3 DEVIATION FROM TEST STANDARD

No deviation.

3.4 TEST SETUP

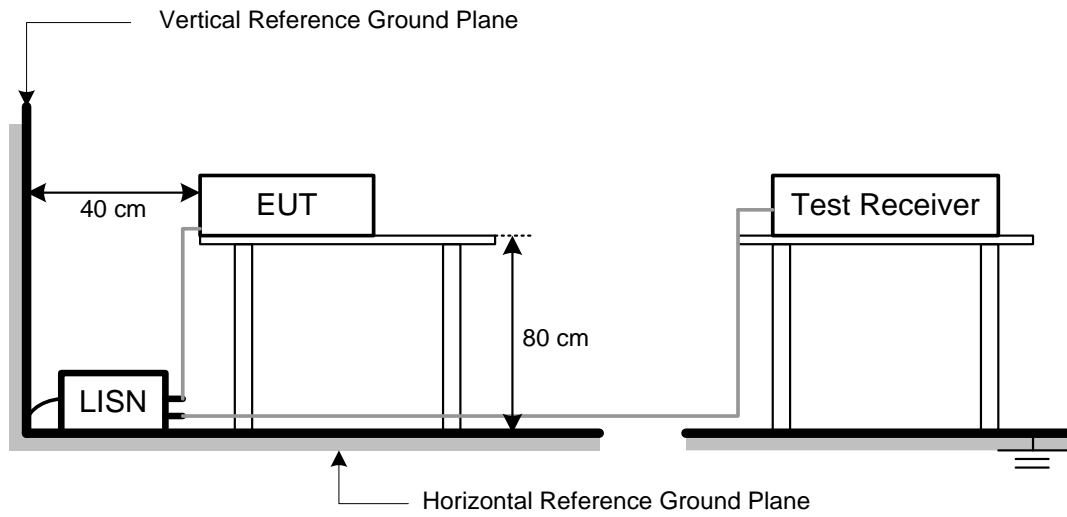

3.5 TEST RESULT

Please refer to the APPENDIX A.

4 RADIATED EMISSIONS TEST

4.1 LIMIT

In case the emission fall within the restricted band specified on 15.205, then the 15.209 limit in the table below has to be followed.

LIMITS OF RADIATED EMISSIONS MEASUREMENT (9 kHz to 1000 MHz)

Frequency (MHz)	Field Strength (microvolts/meter)	Measurement Distance (meters)
0.009~0.490	2400/F(KHz)	300
0.490~1.705	24000/F(KHz)	30
1.705~30.0	30	30
30~88	100	3
88~216	150	3
216~960	200	3
960~1000	500	3

LIMITS OF RADIATED EMISSIONS MEASUREMENT (Above 1000 MHz)

Frequency (MHz)	Radiated Emissions (dBuV/m)		Measurement Distance (meters)
	Peak	Average	
Above 1000	74	54	3

NOTE:

- (1) The limit for radiated test was performed according to FCC Part 15, Subpart C.
- (2) The tighter limit applies at the band edges.
- (3) Emission level (dBuV/m)=20log Emission level (uV/m).
- (4) The test result calculated as following:

Measurement Value = Reading Level + Correct Factor

Correct Factor = Antenna Factor + Cable Loss - Amplifier Gain(if use)

Margin Level = Measurement Value - Limit Value

Calculation example:

Reading Level		Correct Factor		Measurement Value
19.11	+	2.11	=	21.22

Measurement Value		Limit Value		Margin Level
21.22	-	54	=	-32.78

Spectrum Parameter	Setting
Attenuation	Auto
Start Frequency	1000 MHz
Stop Frequency	10th carrier harmonic
RBW / VBW (Emission in restricted band)	1MHz / 3MHz for Peak, 1MHz / 1/T for Average

Spectrum Parameter	Setting
Attenuation	Auto
Start ~ Stop Frequency	9KHz~90KHz for PK/AVG detector
Start ~ Stop Frequency	90KHz~110KHz for QP detector
Start ~ Stop Frequency	110KHz~490KHz for PK/AVG detector
Start ~ Stop Frequency	490KHz~30MHz for QP detector
Start ~ Stop Frequency	30MHz~1000MHz for QP detector

4.2 TEST PROCEDURE

- a. The measuring distance of 3 m shall be used for measurements. The EUT was placed on the top of a rotating table 0.8 meter above the ground at a 3 meter semi-anechoic chamber. The table was rotated 360 degrees to determine the position of the highest radiation.(below 1GHz)
- b. The measuring distance of 3 m shall be used for measurements. The EUT was placed on the top of a rotating table 1.5 meter above the ground at a 3 meter semi-anechoic chamber. The table was rotated 360 degrees to determine the position of the highest radiation.(above 1GHz)
- c. The height of the equipment or of the substitution antenna shall be 0.8 m or 1.5 m, the height of the test antenna shall vary between 1 m to 4 m. Both horizontal and vertical polarizations of the antenna are set to make the measurement.
- d. For each suspected emission, the EUT was arranged to its worst case and then the antenna was tuned to heights find the maximum reading (used Bore sight function).
- e. The receiver system was set to peak and average detect function and specified bandwidth with maximum hold mode when the test frequency is above 1GHz.
- f. The initial step in collecting radiated emission data is a receiver peak detector mode pre-scanning the measurement frequency range. Significant peaks are then marked and then Quasi Peak detector mode re-measured.
- g. All readings are Peak unless otherwise stated QP in column of Note. Peak denotes that the Peak reading compliance with the QP Limits and then QP Mode measurement didn't perform. (below 1GHz)
- h. All readings are Peak Mode value unless otherwise stated AVG in column of Note. If the Peak Mode Measured value compliance with the Peak Limits and lower than AVG Limits, the EUT shall be deemed to meet both Peak & AVG Limits and then only Peak Mode was measured, but AVG Mode didn't perform. (above 1GHz)
- i. For the actual test configuration, please refer to the related Item – EUT TEST PHOTO.

4.3 DEVIATION FROM TEST STANDARD

No deviation.

4.4 TEST SETUP

9 kHz to 30 MHz

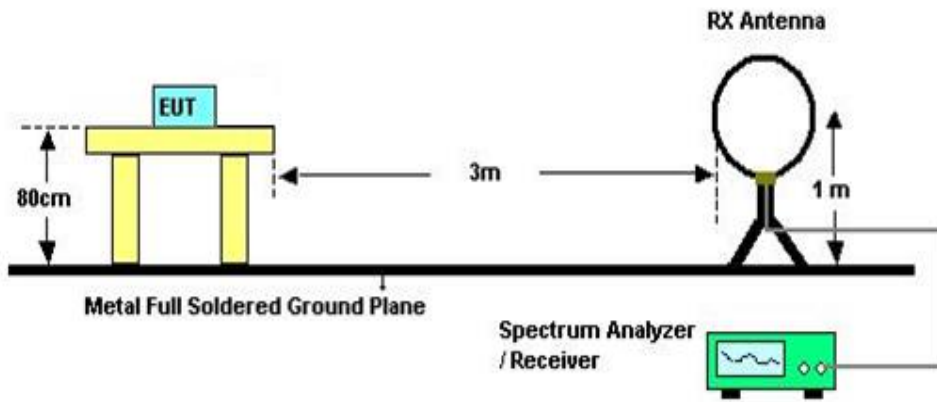

30 MHz to 1 GHz

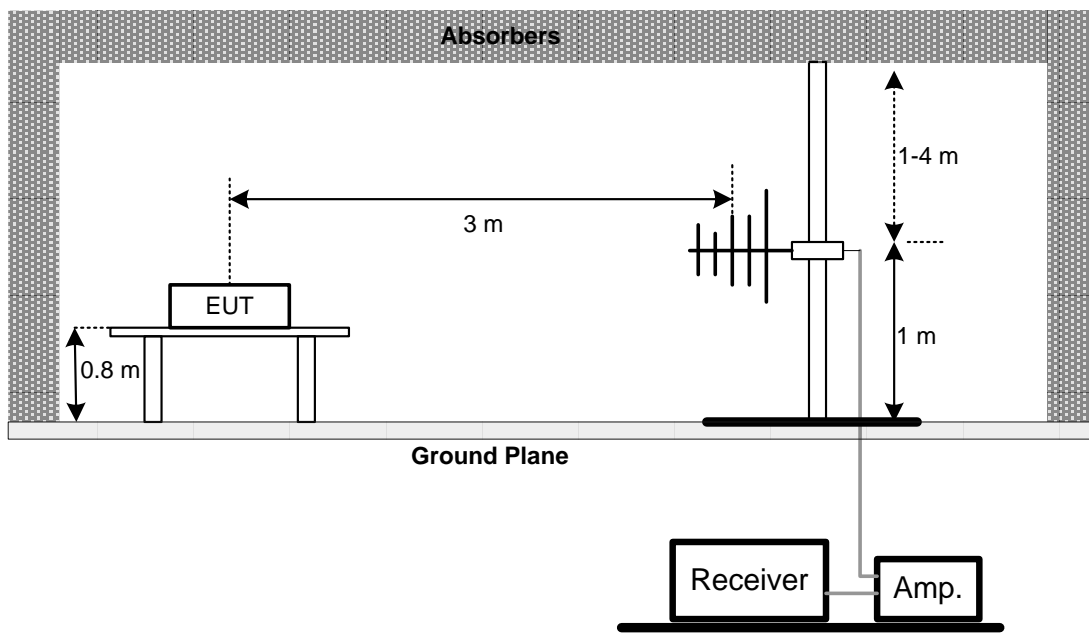

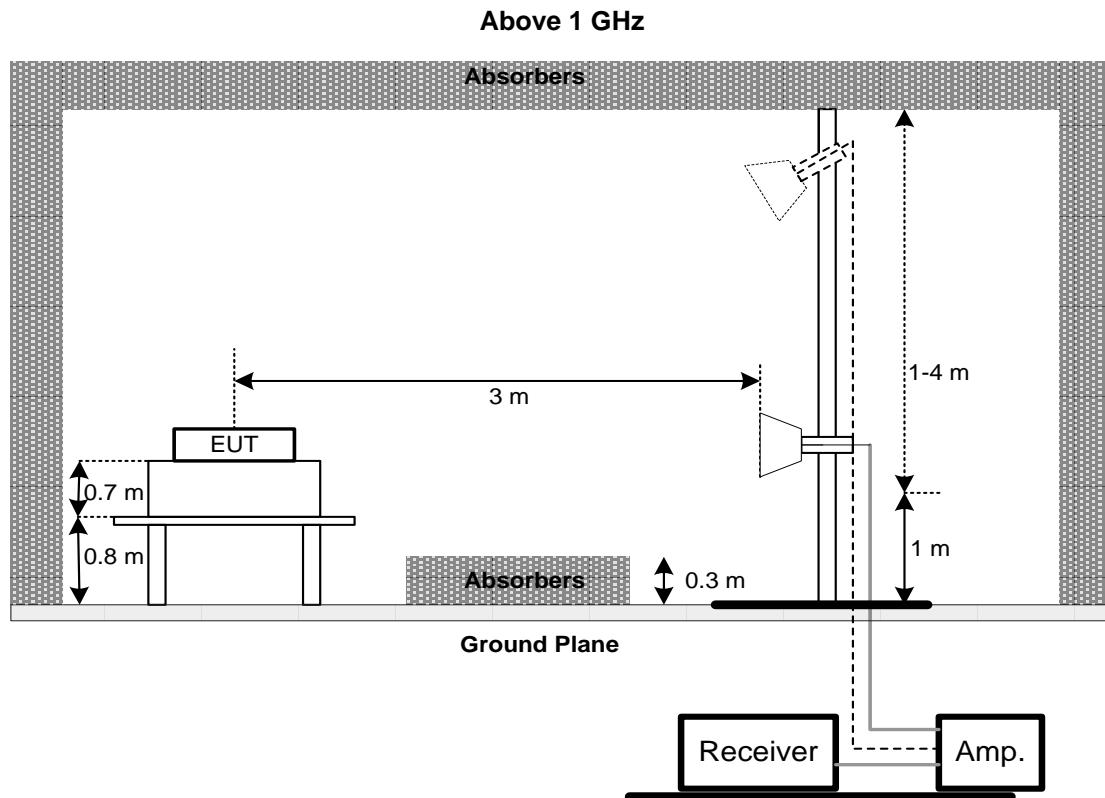

4.5 EUT OPERATING CONDITIONS

The EUT was programmed to be in continuously transmitting mode.

NOTE:

- (1) Distance extrapolation factor = $40 \log (\text{specific distance} / \text{test distance})$ (dB).
- (2) Limit line = specific limits (dBuV) + distance extrapolation factor.

4.6 TEST RESULT – 30 MHZ TO 1 GHZ

Please refer to the APPENDIX B.

4.7 TEST RESULT – ABOVE 1 GHZ

Please refer to the APPENDIX C.

NOTE:

- (1) No limit: This is fundamental signal, the judgment is not applicable. For fundamental signal judgment was referred to Peak output test.

5 LIST OF MEASURING EQUIPMENTS

AC Power Line Conducted Emissions						
Item	Kind of Equipment	Manufacturer	Type No.	Serial No.	Calibrated Date	Calibrated Until
1	TWO-LINE V-NETWORK	R&S	ENV216	101050	2020/6/11	2021/6/10
2	Test Cable	EMCI	EMC400-BM-BM-5000	170501	2020/6/8	2021/6/7
3	EMI Test Receiver	R&S	ESR7	101433	2019/12/13	2020/12/12
4	Measurement Software	EZ	EZ EMC (Version NB-03A1-01)	N/A	N/A	N/A

Radiated Emissions						
Item	Kind of Equipment	Manufacturer	Type No.	Serial No.	Calibrated Date	Calibrated Until
1	Preamplifier	EMCI	EMC02325B	980217	2020/4/10	2021/4/9
2	Preamplifier	EMCI	EMC012645B	980267	2020/4/10	2021/4/9
3	Preamplifier	EMCI	EMC184045SE	980512	2020/6/1	2021/5/31
4	Test Cable	EMCI	EMC-SM-SM-1000	180809	2020/4/10	2021/4/9
5	Test Cable	EMCI	EMC104-SM-SM-3000	151205	2020/4/10	2021/4/9
6	Test Cable	EMCI	EMC-SM-SM-7000	180408	2020/4/10	2021/4/9
7	MXE EMI Receiver	Agilent	N9038A	MY554200087	2020/6/10	2021/6/9
8	Signal Analyzer	Agilent	N9010A	MY56480554	2020/8/25	2021/8/24
9	Horn Ant	SCHWARZBECK	BBHA 9120D	9120D-1342	2020/6/12	2021/6/11
10	Horn Ant	Schwarzbeck	BBHA 9170	BBHA 9170340	2020/7/9	2021/7/8
11	Trilog-Broadband Antenna	Schwarzbeck	VULB 9168	VULB 9168-352	2020/7/24	2021/7/23
12	5dB Attenuator	EMCI	EMCI-N-6-05	AT-N0625	2020/7/24	2021/7/23
13	Measurement Software	EZ	EZ EMC (Version NB-03A1-01)	N/A	N/A	N/A

Remark: "N/A" denotes no model name, no serial no. or no calibration specified.
All calibration period of equipment list is one year.

6 EUT TEST PHOTO

Please refer to document Appendix No.: TP-2011T053-FCCP-1 (APPENDIX-TEST PHOTOS).

7 EUT PHOTOS

Please refer to document Appendix No.: EP-2011T053-1 (APPENDIX-EUT PHOTOS).

APPENDIX A AC POWER LINE CONDUCTED EMISSIONS

Test Mode	Normal	Tested Date	2020/11/20
Test Frequency	-	Phase	Line

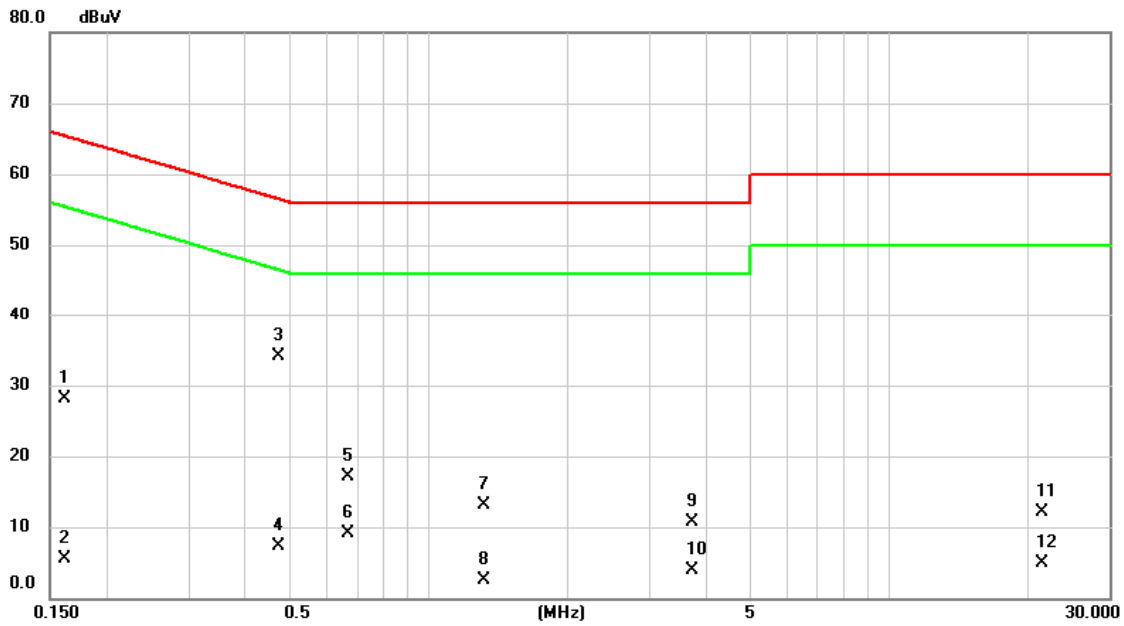

No.	Mk.	Freq. MHz	Reading Level dBuV	Correct Factor dB	Measure- ment dBuV	Limit dBuV	Over dB	Detector	Comment
1		0.1613	18.49	9.68	28.17	65.40	-37.23	QP	
2		0.1613	-4.23	9.68	5.45	55.40	-49.95	AVG	
3	*	0.4740	24.33	9.68	34.01	56.44	-22.43	QP	
4		0.4740	-2.47	9.68	7.21	46.44	-39.23	AVG	
5		0.6697	7.46	9.68	17.14	56.00	-38.86	QP	
6		0.6697	-0.63	9.68	9.05	46.00	-36.95	AVG	
7		1.3133	3.33	9.70	13.03	56.00	-42.97	QP	
8		1.3133	-7.29	9.70	2.41	46.00	-43.59	AVG	
9		3.7320	0.86	9.79	10.65	56.00	-45.35	QP	
10		3.7320	-5.95	9.79	3.84	46.00	-42.16	AVG	
11		21.4688	2.22	9.95	12.17	60.00	-47.83	QP	
12		21.4688	-5.04	9.95	4.91	50.00	-45.09	AVG	

REMARKS:

- (1) Measurement Value = Reading Level + Correct Factor.
- (2) Margin Level = Measurement Value - Limit Value.

Test Mode	Normal	Tested Date	2020/11/20
Test Frequency	-	Phase	Neutral

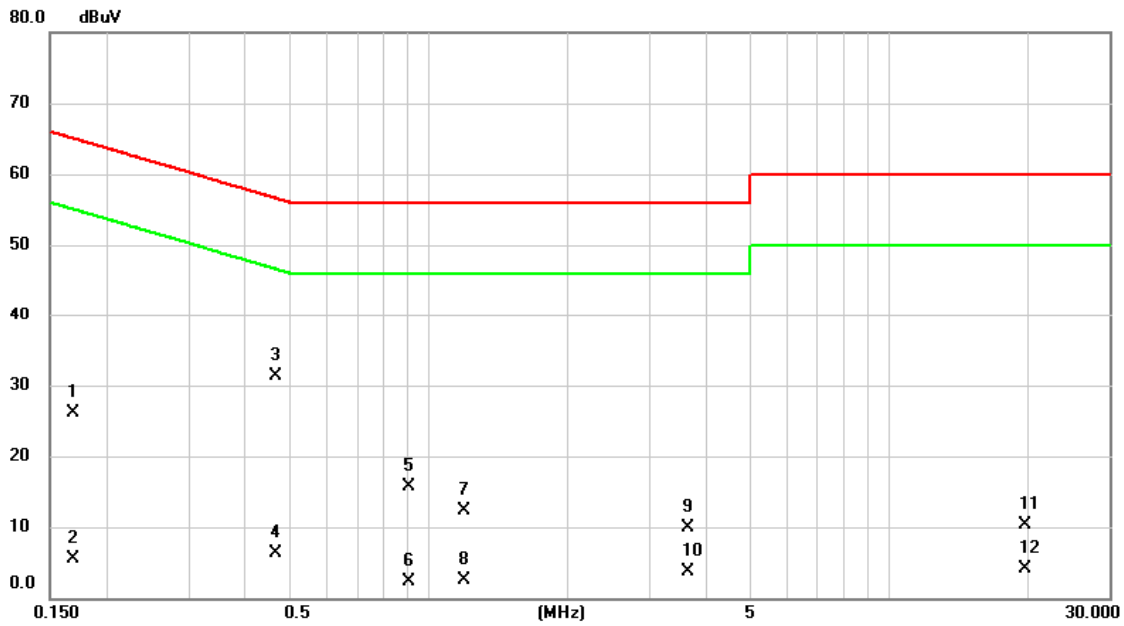

No.	Mk.	Freq. MHz	Reading Level dBuV	Correct Factor dB	Measure- ment dBuV	Limit dBuV	Over dB	Detector	Comment
1		0.1680	16.36	9.68	26.04	65.06	-39.02	QP	
2		0.1680	-4.20	9.68	5.48	55.06	-49.58	AVG	
3	*	0.4650	21.68	9.68	31.36	56.60	-25.24	QP	
4		0.4650	-3.43	9.68	6.25	46.60	-40.35	AVG	
5		0.9060	5.97	9.69	15.66	56.00	-40.34	QP	
6		0.9060	-7.36	9.69	2.33	46.00	-43.67	AVG	
7		1.1940	2.65	9.70	12.35	56.00	-43.65	QP	
8		1.1940	-7.14	9.70	2.56	46.00	-43.44	AVG	
9		3.6487	0.13	9.79	9.92	56.00	-46.08	QP	
10		3.6487	-6.07	9.79	3.72	46.00	-42.28	AVG	
11		19.7092	0.32	9.96	10.28	60.00	-49.72	QP	
12		19.7092	-5.77	9.96	4.19	50.00	-45.81	AVG	

REMARKS:

- (1) Measurement Value = Reading Level + Correct Factor.
- (2) Margin Level = Measurement Value - Limit Value.

Test Mode	Idle	Tested Date	2020/11/20
Test Frequency	-	Phase	Line

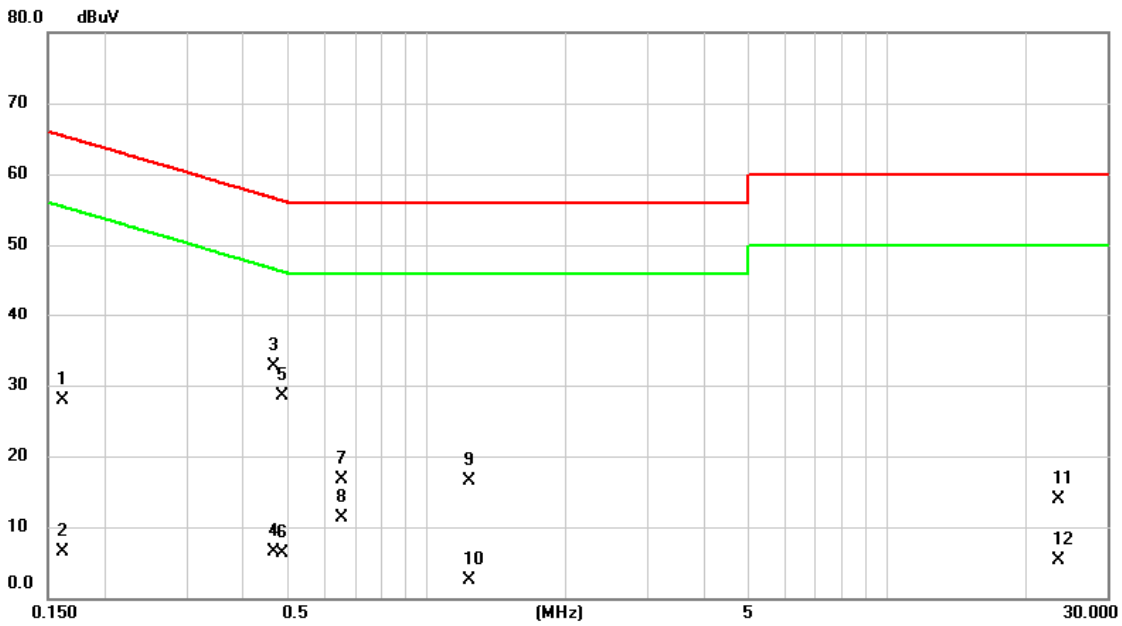

No.	Mk.	Freq. MHz	Reading Level dBuV	Correct Factor dB	Measure- ment dBuV	Limit dBuV	Over dB	Detector	Comment
1		0.1613	18.21	9.68	27.89	65.40	-37.51	QP	
2		0.1613	-3.14	9.68	6.54	55.40	-48.86	AVG	
3	*	0.4672	23.09	9.68	32.77	56.56	-23.79	QP	
4		0.4672	-3.25	9.68	6.43	46.56	-40.13	AVG	
5		0.4875	18.76	9.68	28.44	56.21	-27.77	QP	
6		0.4875	-3.39	9.68	6.29	46.21	-39.92	AVG	
7		0.6561	6.96	9.68	16.64	56.00	-39.36	QP	
8		0.6561	1.70	9.68	11.38	46.00	-34.62	AVG	
9		1.2345	6.75	9.70	16.45	56.00	-39.55	QP	
10		1.2345	-7.26	9.70	2.44	46.00	-43.56	AVG	
11		23.5725	4.04	9.95	13.99	60.00	-46.01	QP	
12		23.5725	-4.55	9.95	5.40	50.00	-44.60	AVG	

REMARKS:

- (1) Measurement Value = Reading Level + Correct Factor.
- (2) Margin Level = Measurement Value - Limit Value.

Test Mode	Idle	Tested Date	2020/11/20
Test Frequency	-	Phase	Neutral

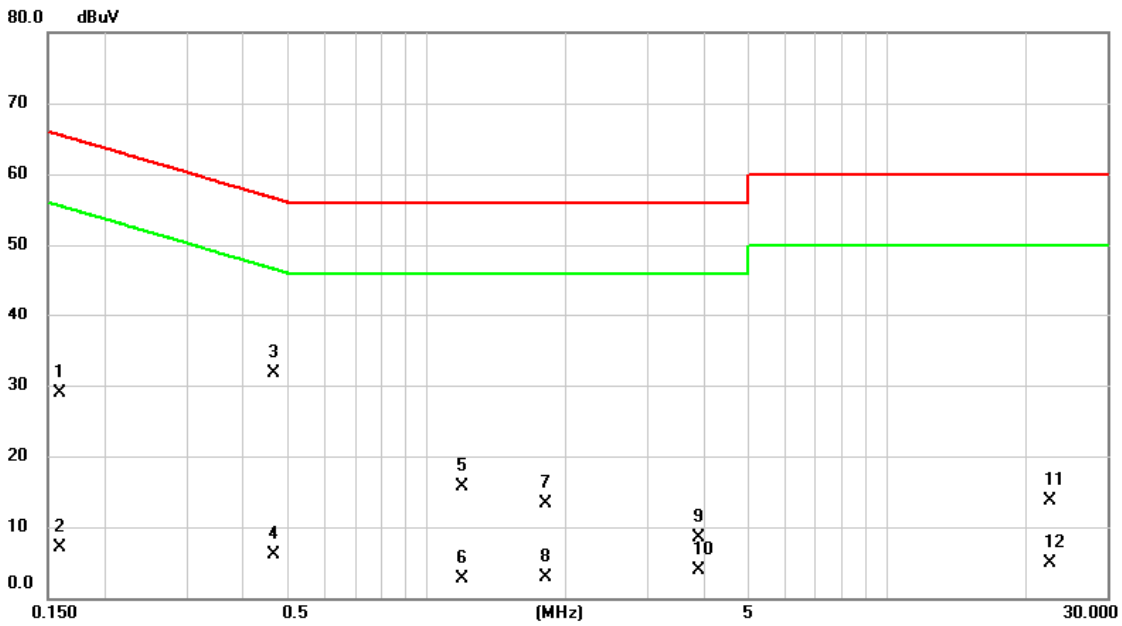

No.	Mk.	Freq. MHz	Reading Level dBuV	Correct Factor dB	Measure- ment dBuV	Limit dBuV	Over dB	Detector	Comment
1		0.1590	19.32	9.68	29.00	65.52	-36.52	QP	
2		0.1590	-2.67	9.68	7.01	55.52	-48.51	AVG	
3	*	0.4650	21.93	9.68	31.61	56.60	-24.99	QP	
4		0.4650	-3.51	9.68	6.17	46.60	-40.43	AVG	
5		1.1917	5.92	9.70	15.62	56.00	-40.38	QP	
6		1.1917	-7.04	9.70	2.66	46.00	-43.34	AVG	
7		1.8038	3.51	9.73	13.24	56.00	-42.76	QP	
8		1.8038	-6.88	9.73	2.85	46.00	-43.15	AVG	
9		3.8760	-1.19	9.79	8.60	56.00	-47.40	QP	
10		3.8760	-5.92	9.79	3.87	46.00	-42.13	AVG	
11		22.5983	3.71	9.95	13.66	60.00	-46.34	QP	
12		22.5983	-5.00	9.95	4.95	50.00	-45.05	AVG	

REMARKS:

- (1) Measurement Value = Reading Level + Correct Factor.
- (2) Margin Level = Measurement Value - Limit Value.

APPENDIX B RADIATED EMISSIONS - 30 MHZ TO 1 GHZ

Test Mode	IEEE 802.11b	Test Date	2020/12/7
Test Frequency	2437MHz	Polarization	Vertical
Temp	22°C	Hum.	65%

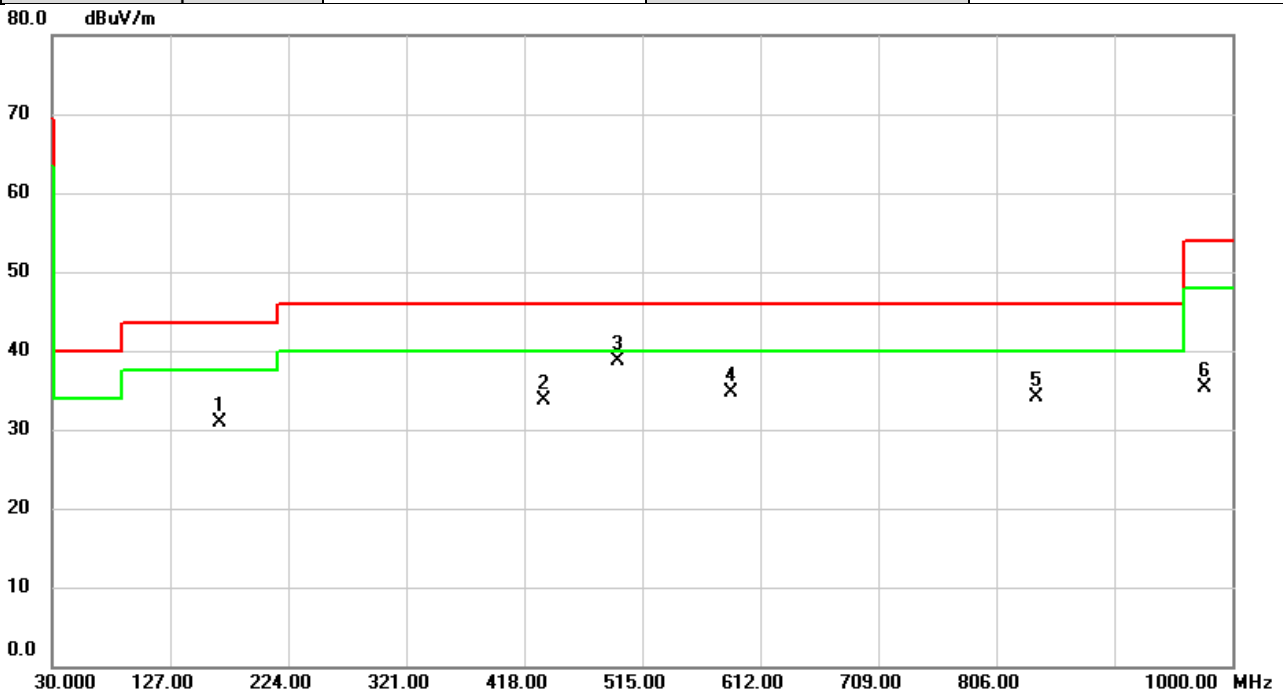

No.	Mk.	Freq. MHz	Reading Level dBuV	Correct Factor dB	Measure- ment dBuV/m	Limit dBuV/m	Over dB	Detector	Comment
1		168.3866	39.51	-8.55	30.96	43.50	-12.54	peak	
2		434.1343	37.84	-4.06	33.78	46.00	-12.22	peak	
3	*	495.0503	41.50	-2.85	38.65	46.00	-7.35	peak	
4		588.5260	35.53	-0.90	34.63	46.00	-11.37	peak	
5		838.4950	30.98	3.21	34.19	46.00	-11.81	peak	
6		977.8193	29.83	5.42	35.25	54.00	-18.75	peak	

REMARKS:

- (1) Measurement Value = Reading Level + Correct Factor.
- (2) Margin Level = Measurement Value - Limit Value.

Test Mode	IEEE 802.11b	Test Date	2020/12/7
Test Frequency	2437MHz	Polarization	Horizontal
Temp	22°C	Hum.	65%

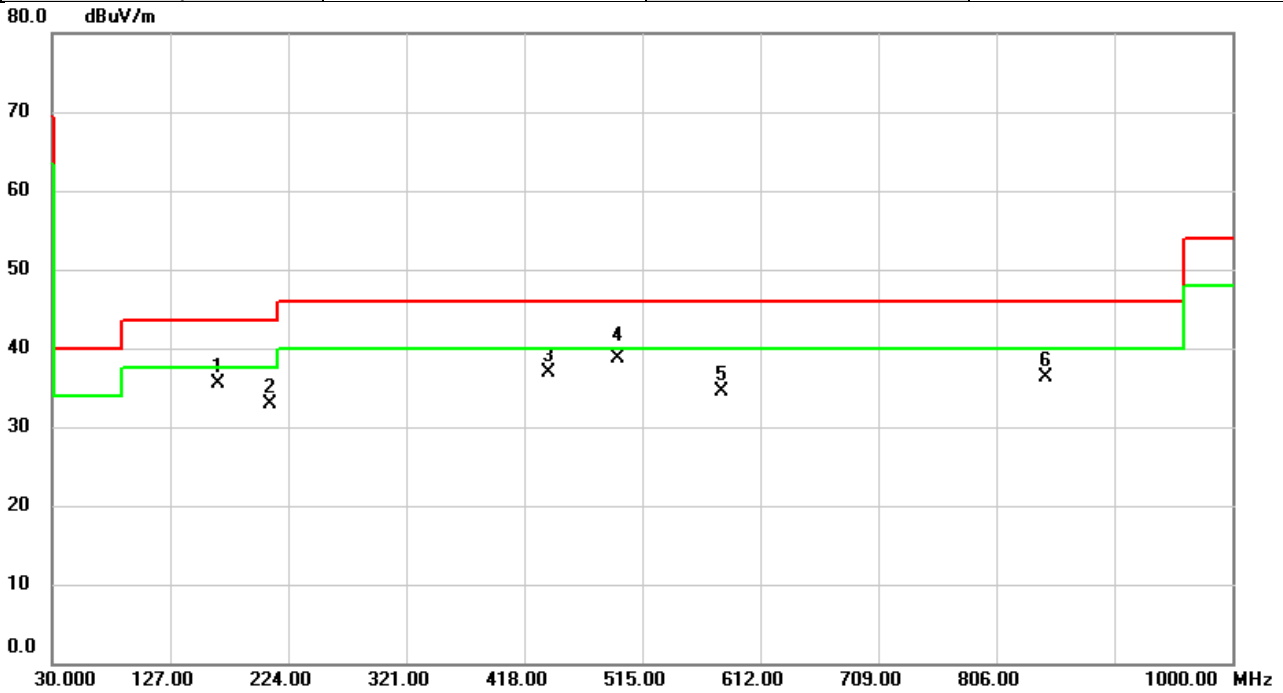

No.	Mk.	Freq.	Reading Level	Correct Factor	Measurement	Limit	Over	Detector	Comment
		MHz	dBuV	dB	dBuV/m	dBuV/m	dB		
1		166.5436	43.92	-8.47	35.45	43.50	-8.05	peak	
2		208.7386	43.73	-10.76	32.97	43.50	-10.53	peak	
3		438.2406	40.93	-3.96	36.97	46.00	-9.03	peak	
4	*	495.0503	41.55	-2.85	38.70	46.00	-7.30	QP	
5		579.8605	35.51	-1.10	34.41	46.00	-11.59	peak	
6		846.7076	32.97	3.34	36.31	46.00	-9.69	peak	

REMARKS:

- (1) Measurement Value = Reading Level + Correct Factor.
- (2) Margin Level = Measurement Value - Limit Value.

APPENDIX C RADIATED EMISSIONS - ABOVE 1 GHZ

Test Mode	IEEE 802.11b	Test Date	2020/11/26
Test Frequency	2412MHz	Polarization	Vertical
Temp	23°C	Hum.	64%

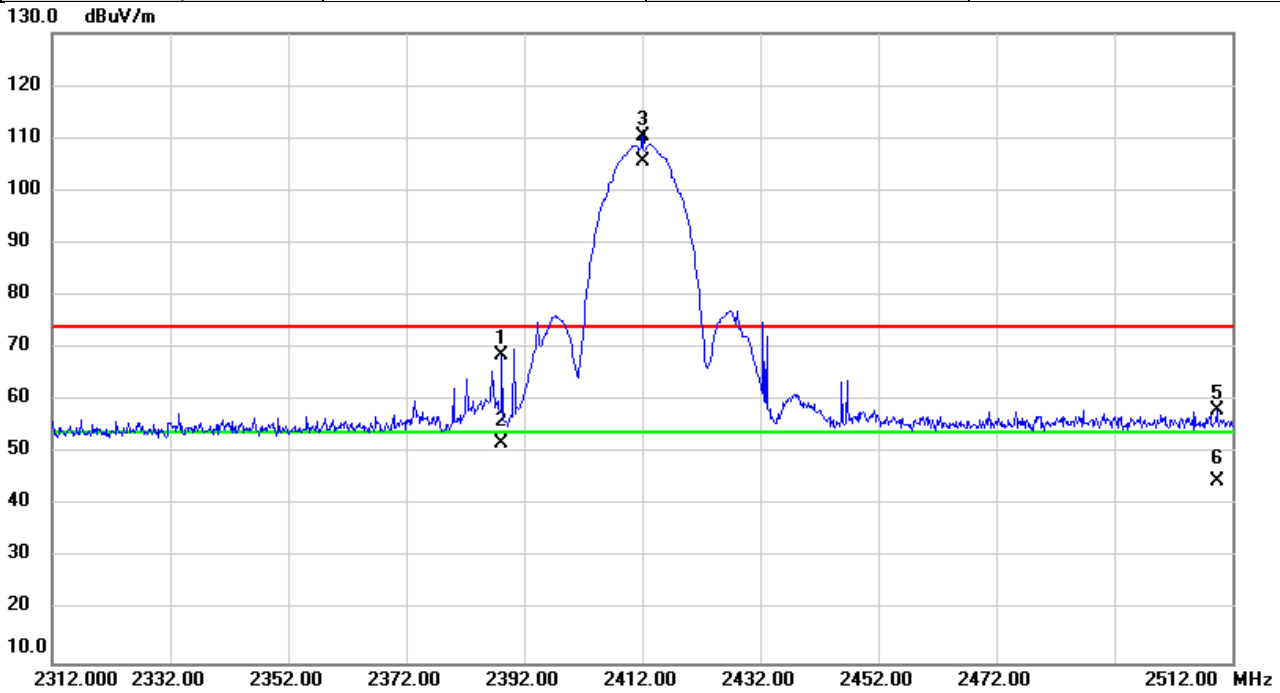

No.	Mk.	Freq. MHz	Reading Level dBuV	Correct Factor dB	Measure- ment dBuV/m	Limit dBuV/m	Over dB	Detector	Comment
1		2388.253	37.99	30.78	68.77	74.00	-5.23	peak	
2		2388.253	21.08	30.78	51.86	54.00	-2.14	AVG	
3	X	2412.000	79.38	30.88	110.26	74.00	36.26	peak	NoLimit
4	*	2412.000	74.63	30.88	105.51	54.00	51.51	AVG	NoLimit
5		2509.380	26.90	31.27	58.17	74.00	-15.83	peak	
6		2509.380	13.34	31.27	44.61	54.00	-9.39	AVG	

REMARKS:

- (1) Measurement Value = Reading Level + Correct Factor.
- (2) Margin Level = Measurement Value - Limit Value.

Test Mode	IEEE 802.11b	Test Date	2020/11/26
Test Frequency	2462MHz	Polarization	Vertical
Temp	23°C	Hum.	64%

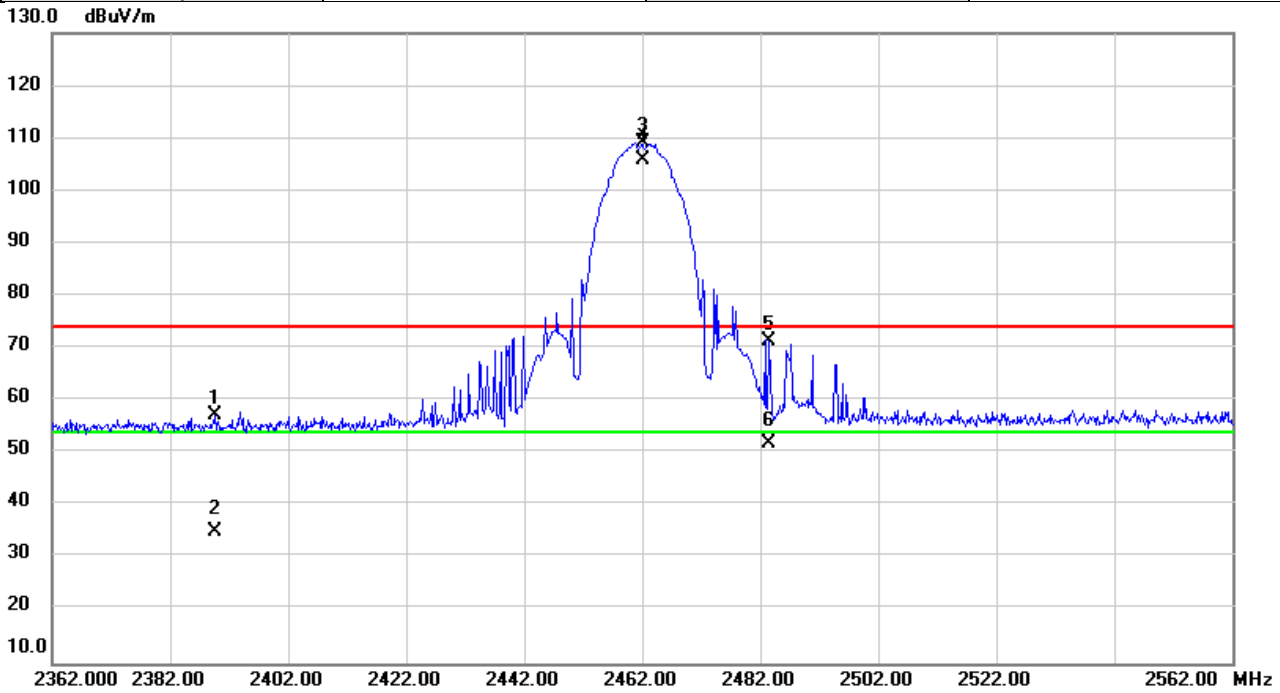

No.	Mk.	Freq.	Reading Level	Correct Factor	Measurement	Limit	Over	Detector	Comment
		MHz	dBuV	dB	dBuV/m	dBuV/m	dB		
1		2389.667	26.45	30.78	57.23	74.00	-16.77	peak	
2		2389.667	4.28	30.78	35.06	54.00	-18.94	AVG	
3	X	2462.000	77.97	31.08	109.05	74.00	35.05	peak	NoLimit
4	*	2462.000	74.88	31.08	105.96	54.00	51.96	AVG	NoLimit
5		2483.600	40.22	31.16	71.38	74.00	-2.62	peak	
6		2483.600	20.62	31.16	51.78	54.00	-2.22	AVG	

REMARKS:

- (1) Measurement Value = Reading Level + Correct Factor.
- (2) Margin Level = Measurement Value - Limit Value.

Test Mode	IEEE 802.11g	Test Date	2020/11/26
Test Frequency	2412MHz	Polarization	Vertical
Temp	23°C	Hum.	64%

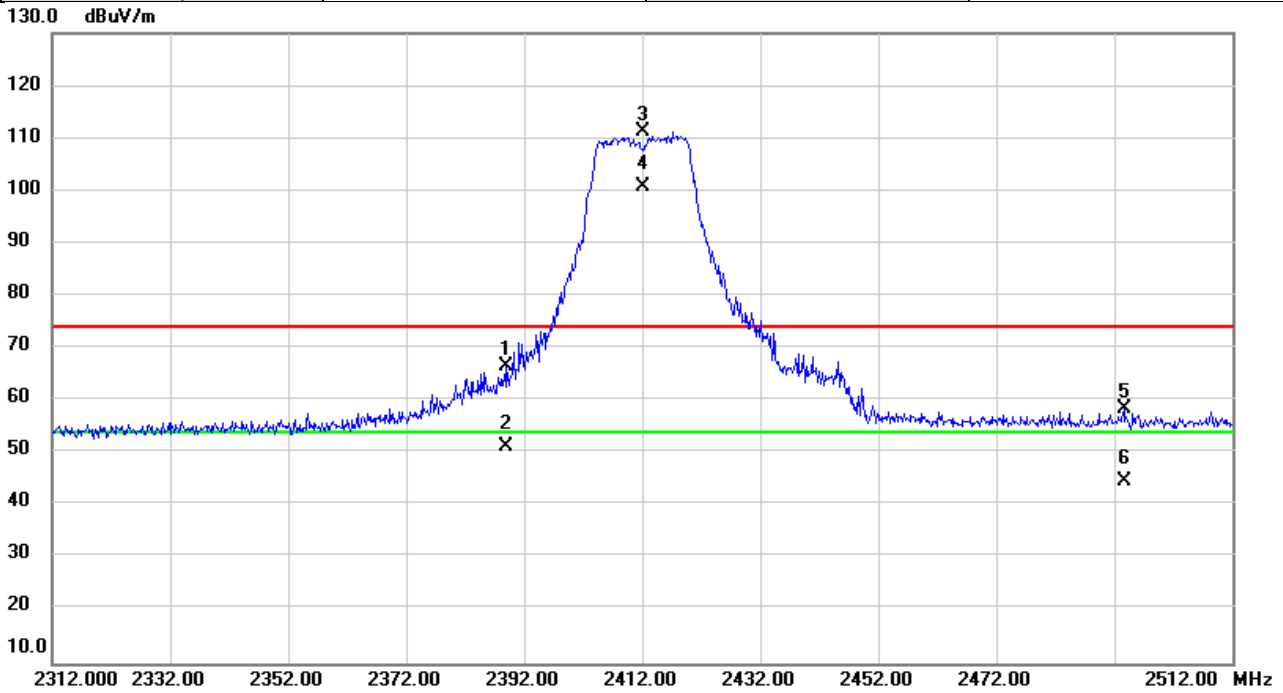

No.	Mk.	Freq.	Reading Level	Correct Factor	Measurement	Limit	Over	Detector	Comment
		MHz	dBuV	dB	dBuV/m	dBuV/m	dB		
1		2389.053	35.73	30.78	66.51	74.00	-7.49	peak	
2		2389.053	20.62	30.78	51.40	54.00	-2.60	AVG	
3	X	2412.000	80.44	30.88	111.32	74.00	37.32	peak	NoLimit
4	*	2412.000	69.84	30.88	100.72	54.00	46.72	AVG	NoLimit
5		2493.607	27.16	31.21	58.37	74.00	-15.63	peak	
6		2493.607	13.58	31.21	44.79	54.00	-9.21	AVG	

REMARKS:

- (1) Measurement Value = Reading Level + Correct Factor.
- (2) Margin Level = Measurement Value - Limit Value.

Test Mode	IEEE 802.11g	Test Date	2020/11/26
Test Frequency	2462MHz	Polarization	Vertical
Temp	23°C	Hum.	64%

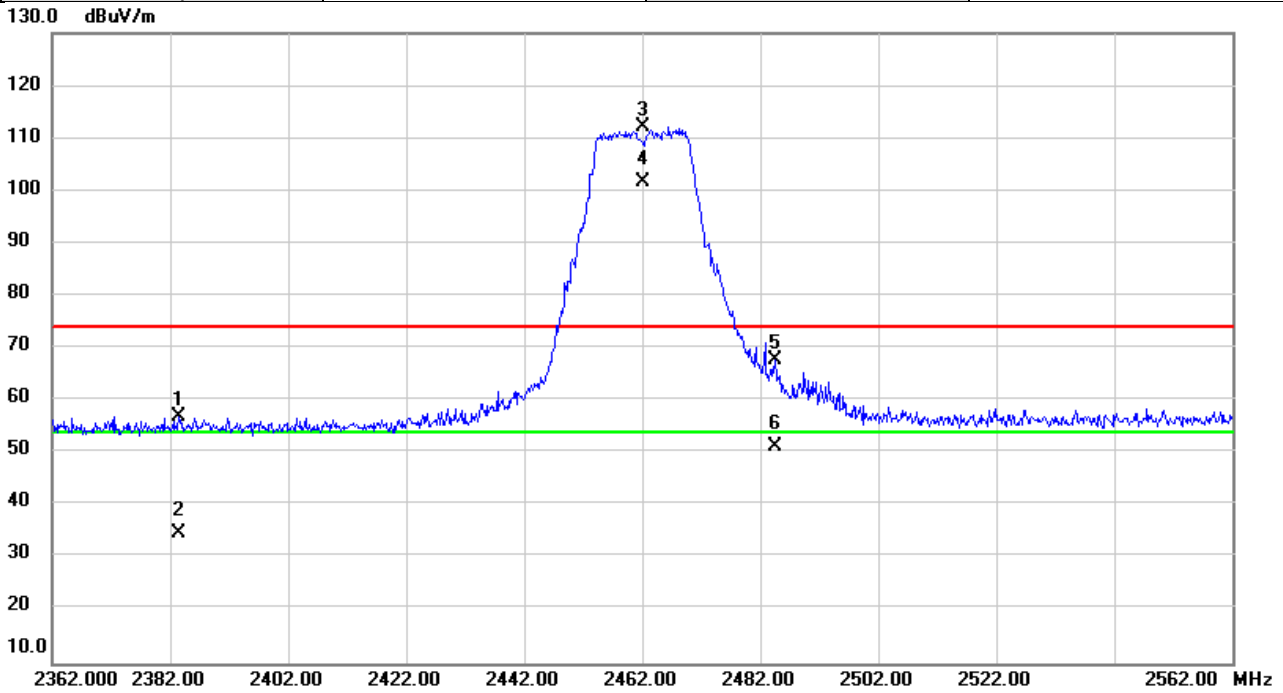

No.	Mk.	Freq.	Reading Level	Correct Factor	Measurement	Limit	Over	Detector	Comment
		MHz	dBuV	dB	dBuV/m	dBuV/m	dB		
1		2383.527	26.23	30.76	56.99	74.00	-17.01	peak	
2		2383.527	3.85	30.76	34.61	54.00	-19.39	AVG	
3	X	2462.000	81.13	31.08	112.21	74.00	38.21	peak	NoLimit
4	*	2462.000	70.49	31.08	101.57	54.00	47.57	AVG	NoLimit
5		2484.507	36.59	31.17	67.76	74.00	-6.24	peak	
6		2484.507	19.95	31.17	51.12	54.00	-2.88	AVG	

REMARKS:

- (1) Measurement Value = Reading Level + Correct Factor.
- (2) Margin Level = Measurement Value - Limit Value.

Test Mode	IEEE 802.11n(HT20)	Test Date	2020/11/26
Test Frequency	2412MHz	Polarization	Vertical
Temp	23°C	Hum.	64%

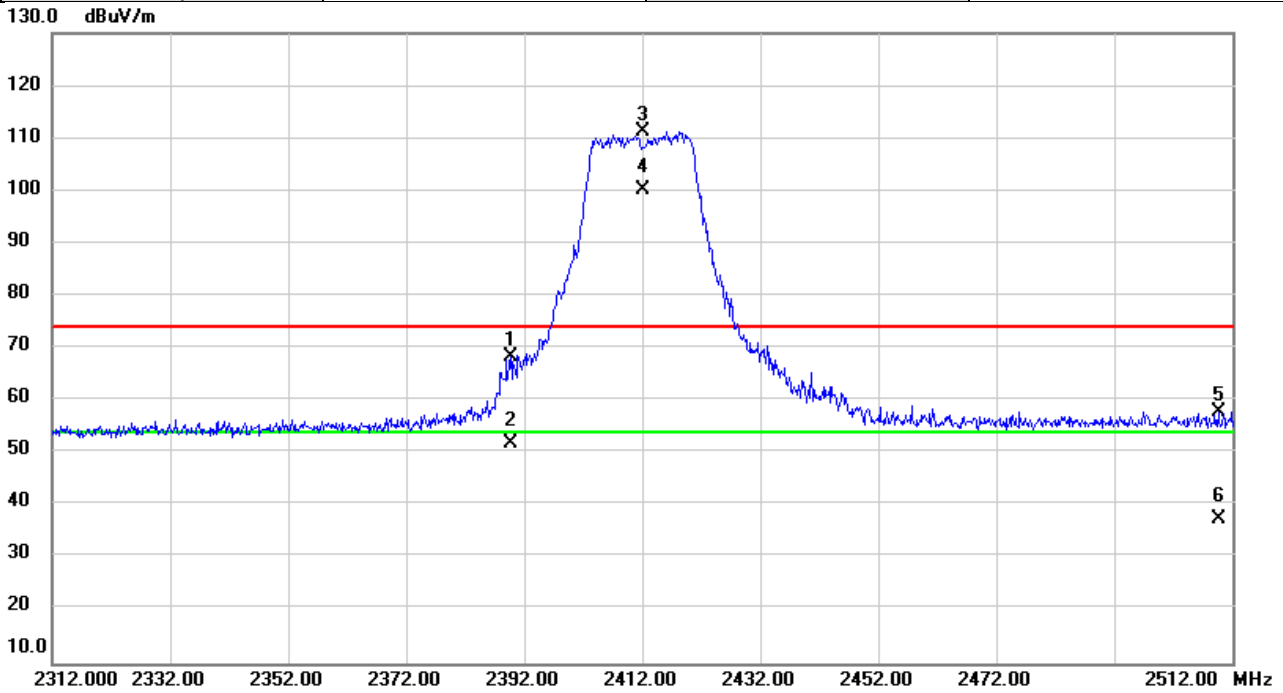

No.	Mk.	Freq. MHz	Reading Level dBuV	Correct Factor dB	Measure- ment dBuV/m	Limit dBuV/m	Over dB	Detector	Comment
1		2389.607	37.59	30.78	68.37	74.00	-5.63	peak	
2		2389.607	20.99	30.78	51.77	54.00	-2.23	AVG	
3	X	2412.000	80.27	30.88	111.15	74.00	37.15	peak	NoLimit
4	*	2412.000	69.20	30.88	100.08	54.00	46.08	AVG	NoLimit
5		2509.780	26.71	31.27	57.98	74.00	-16.02	peak	
6		2509.780	6.18	31.27	37.45	54.00	-16.55	AVG	

REMARKS:

- (1) Measurement Value = Reading Level + Correct Factor.
- (2) Margin Level = Measurement Value - Limit Value.

Test Mode	IEEE 802.11n(HT20)	Test Date	2020/11/26
Test Frequency	2462MHz	Polarization	Vertical
Temp	23°C	Hum.	64%

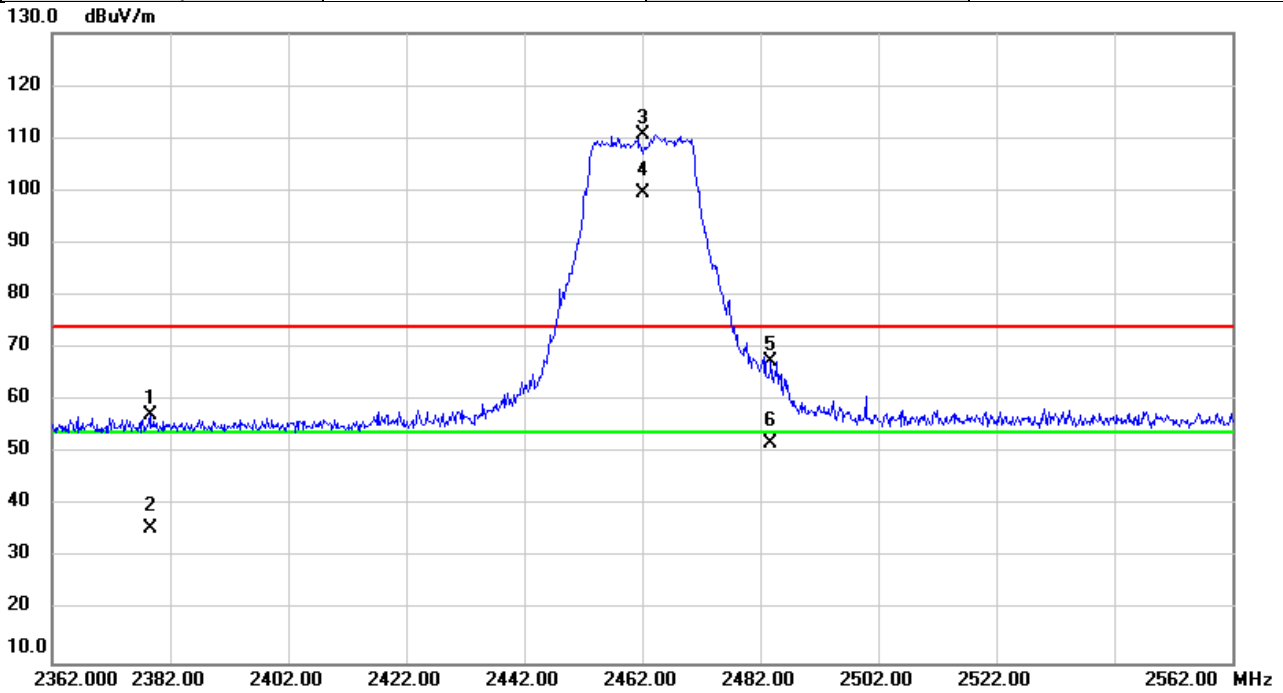

No.	Mk.	Freq.	Reading Level	Correct Factor	Measurement	Limit	Over	Detector	Comment
		MHz	dBuV	dB	dBuV/m	dBuV/m	dB		
1		2378.540	26.57	30.75	57.32	74.00	-16.68	peak	
2		2378.540	4.87	30.75	35.62	54.00	-18.38	AVG	
3	X	2462.000	79.64	31.08	110.72	74.00	36.72	peak	NoLimit
4	*	2462.000	68.37	31.08	99.45	54.00	45.45	AVG	NoLimit
5		2483.813	36.19	31.16	67.35	74.00	-6.65	peak	
6		2483.813	20.61	31.16	51.77	54.00	-2.23	AVG	

REMARKS:

- (1) Measurement Value = Reading Level + Correct Factor.
- (2) Margin Level = Measurement Value - Limit Value.

Test Mode	IEEE 802.11n(HT40)	Test Date	2020/11/26
Test Frequency	2422MHz	Polarization	Vertical
Temp	23°C	Hum.	64%

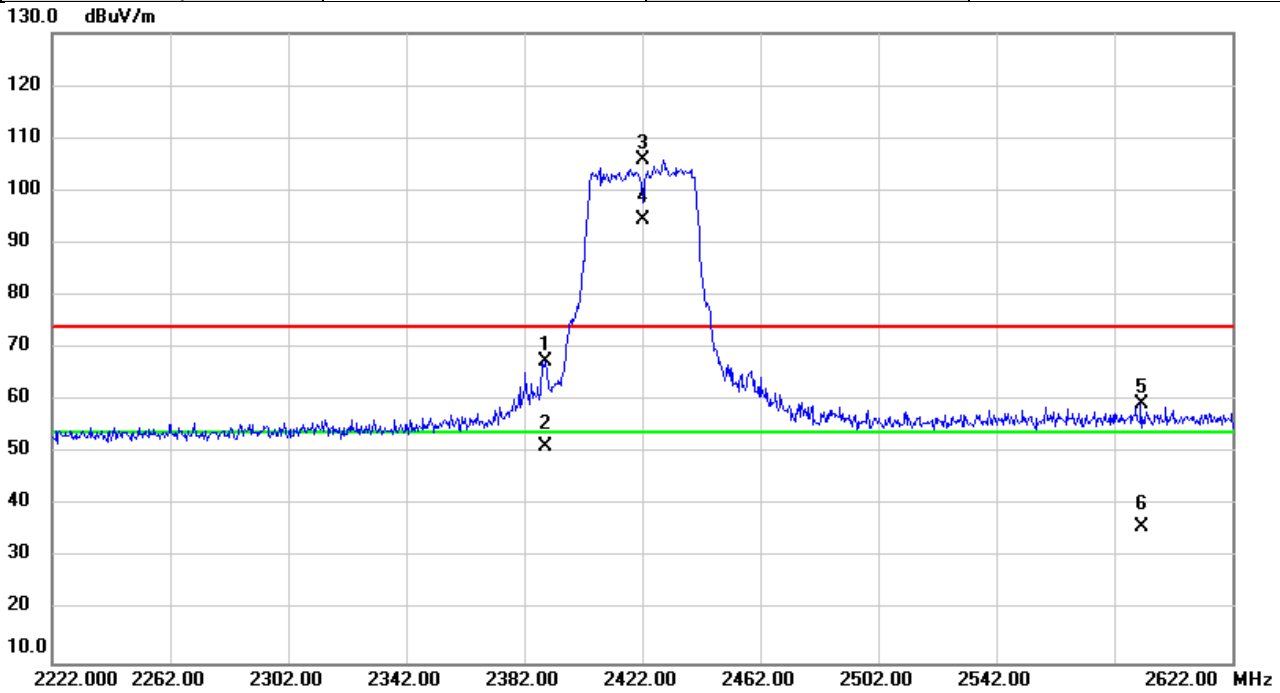

No.	Mk.	Freq.	Reading Level	Correct Factor	Measurement	Limit	Over	Detector	Comment
		MHz	dBuV	dB	dBuV/m	dBuV/m	dB		
1		2389.160	36.68	30.78	67.46	74.00	-6.54	peak	
2		2389.160	20.50	30.78	51.28	54.00	-2.72	AVG	
3	X	2422.000	74.81	30.91	105.72	74.00	31.72	peak	NoLimit
4	*	2422.000	63.65	30.91	94.56	54.00	40.56	AVG	NoLimit
5		2591.067	27.74	31.61	59.35	74.00	-14.65	peak	
6		2591.067	4.21	31.61	35.82	54.00	-18.18	AVG	

REMARKS:

- (1) Measurement Value = Reading Level + Correct Factor.
- (2) Margin Level = Measurement Value - Limit Value.

Test Mode	IEEE 802.11n(HT40)	Test Date	2020/11/26
Test Frequency	2452MHz	Polarization	Vertical
Temp	23°C	Hum.	64%

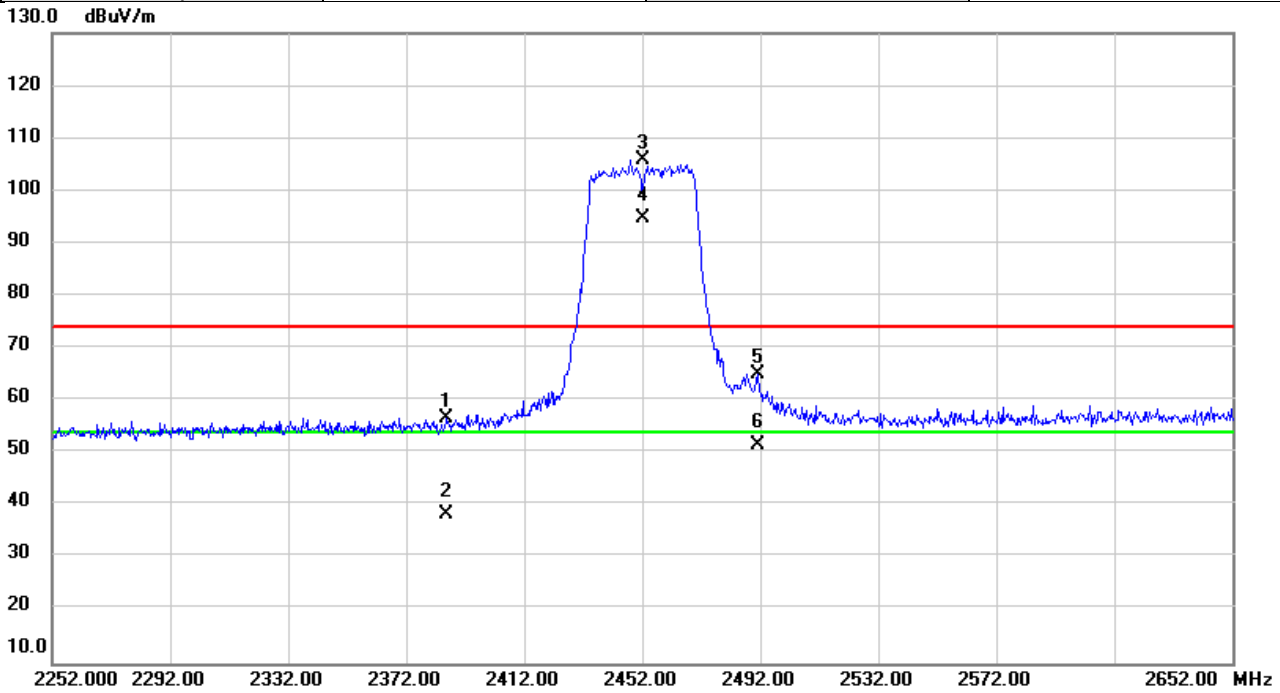

No.	Mk.	Freq.	Reading Level	Correct Factor	Measurement	Limit	Over	Detector	Comment
		MHz	dBuV	dB	dBuV/m	dBuV/m	dB		
1		2385.787	25.92	30.77	56.69	74.00	-17.31	peak	
2		2385.787	7.48	30.77	38.25	54.00	-15.75	AVG	
3	X	2452.000	74.76	31.04	105.80	74.00	31.80	peak	NoLimit
4	*	2452.000	63.64	31.04	94.68	54.00	40.68	AVG	NoLimit
5		2491.200	33.92	31.19	65.11	74.00	-8.89	peak	
6		2491.200	20.24	31.19	51.43	54.00	-2.57	AVG	

REMARKS:

- (1) Measurement Value = Reading Level + Correct Factor.
- (2) Margin Level = Measurement Value - Limit Value.

Test Mode	IEEE 802.11b	Test Date	2020/11/26
Test Frequency	2412MHz	Polarization	Vertical
Temp	23°C	Hum.	64%

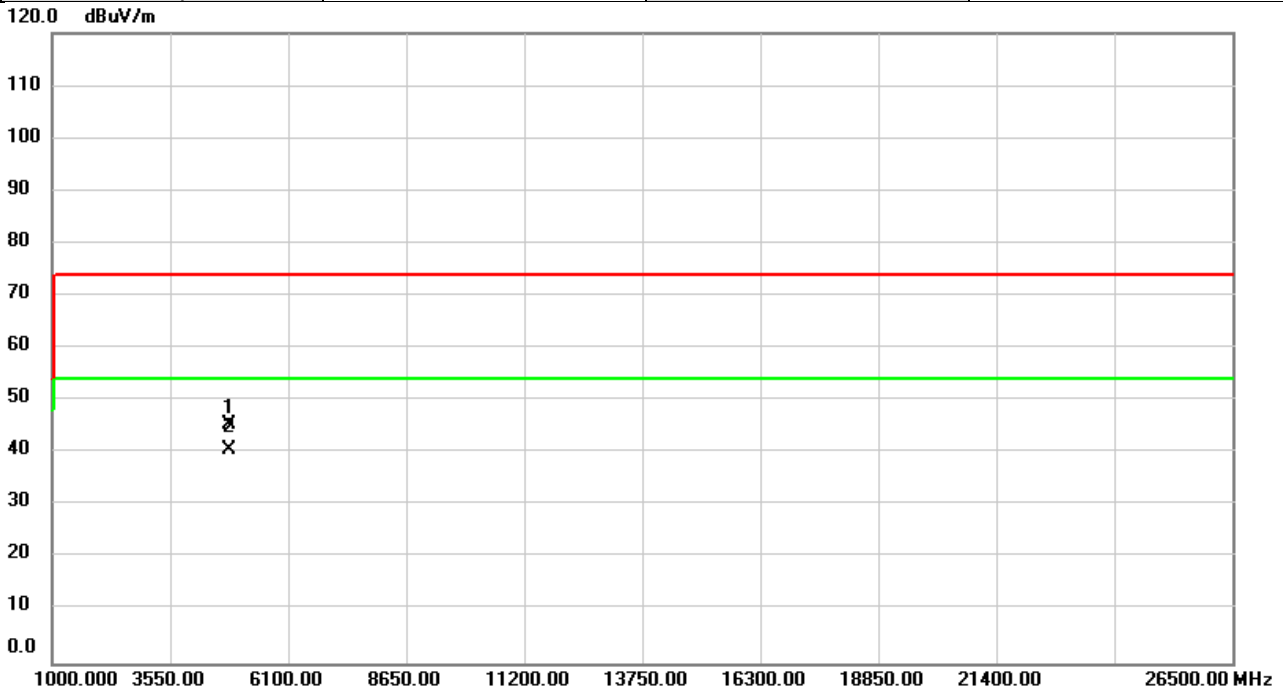

No.	Mk.	Freq. MHz	Reading Level dBuV	Correct Factor dB	Measure- ment dBuV/m	Limit dBuV/m	Over dB	Detector	Comment
1		4824.000	55.35	-9.96	45.39	74.00	-28.61	peak	
2	*	4824.000	50.67	-9.96	40.71	54.00	-13.29	AVG	

REMARKS:

- (1) Measurement Value = Reading Level + Correct Factor.
- (2) Margin Level = Measurement Value - Limit Value.

Test Mode	IEEE 802.11b	Test Date	2020/11/26
Test Frequency	2412MHz	Polarization	Horizontal
Temp	23°C	Hum.	64%

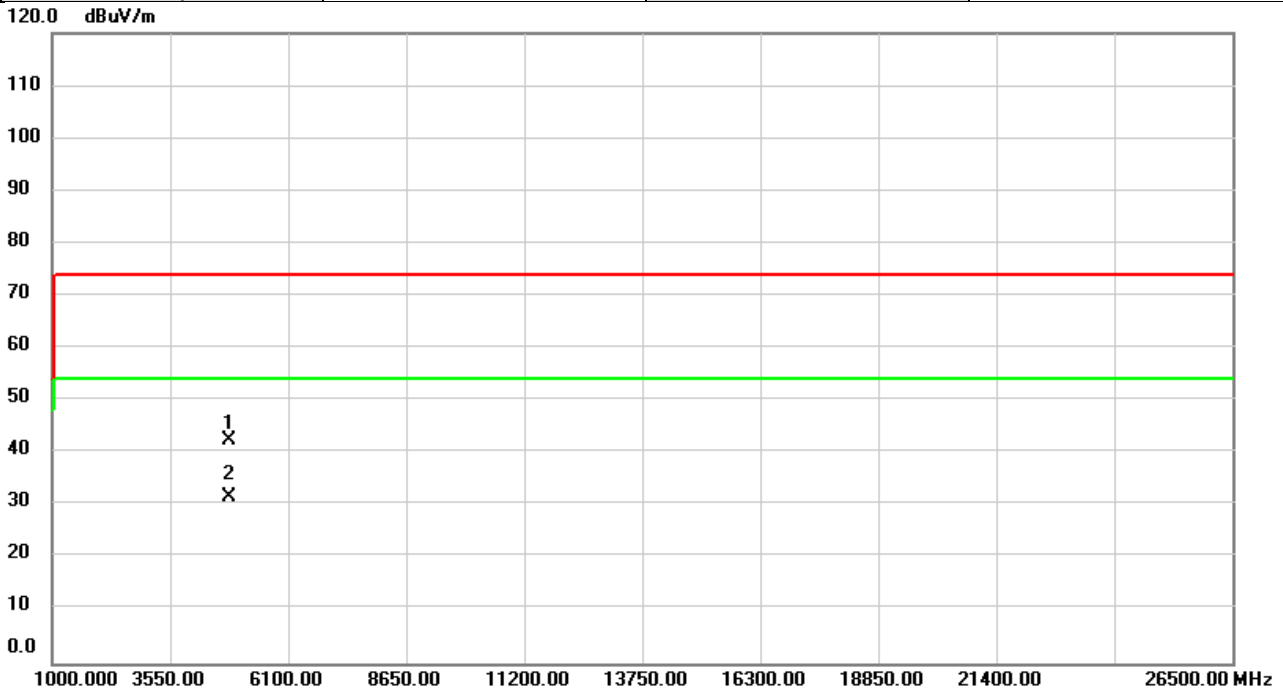

No.	Mk.	Freq. MHz	Reading Level dBuV	Correct Factor dB	Measure- ment dBuV/m	Limit dBuV/m	Over dB	Detector	Comment
1		4824.000	52.35	-9.96	42.39	74.00	-31.61	peak	
2	*	4824.000	41.60	-9.96	31.64	54.00	-22.36	AVG	

REMARKS:

- (1) Measurement Value = Reading Level + Correct Factor.
- (2) Margin Level = Measurement Value - Limit Value.

Test Mode	IEEE 802.11b	Test Date	2020/11/26
Test Frequency	2437MHz	Polarization	Vertical
Temp	23°C	Hum.	64%

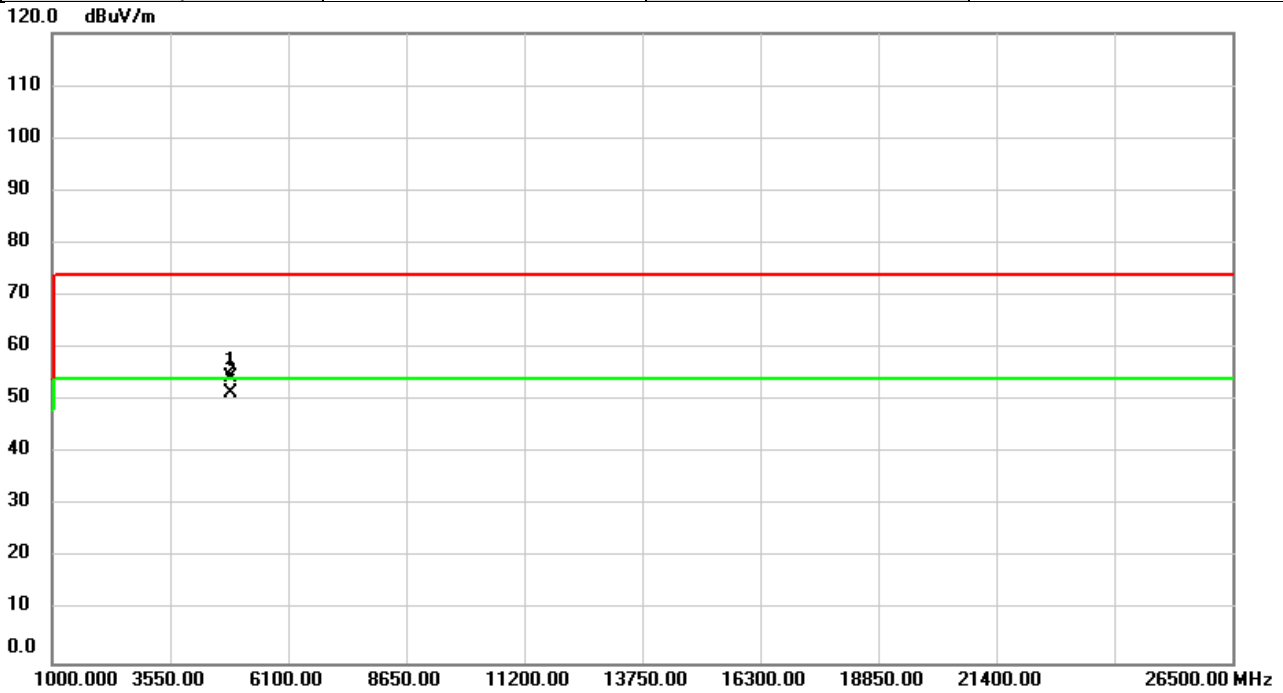

No.	Mk.	Freq. MHz	Reading Level dBuV	Correct Factor dB	Measure- ment dBuV/m	Limit dBuV/m	Over dB	Detector	Comment
1		4874.000	64.11	-9.79	54.32	74.00	-19.68	peak	
2	*	4874.000	61.26	-9.79	51.47	54.00	-2.53	AVG	

REMARKS:

- (1) Measurement Value = Reading Level + Correct Factor.
- (2) Margin Level = Measurement Value - Limit Value.

Test Mode	IEEE 802.11b	Test Date	2020/11/26
Test Frequency	2437MHz	Polarization	Horizontal
Temp	23°C	Hum.	64%

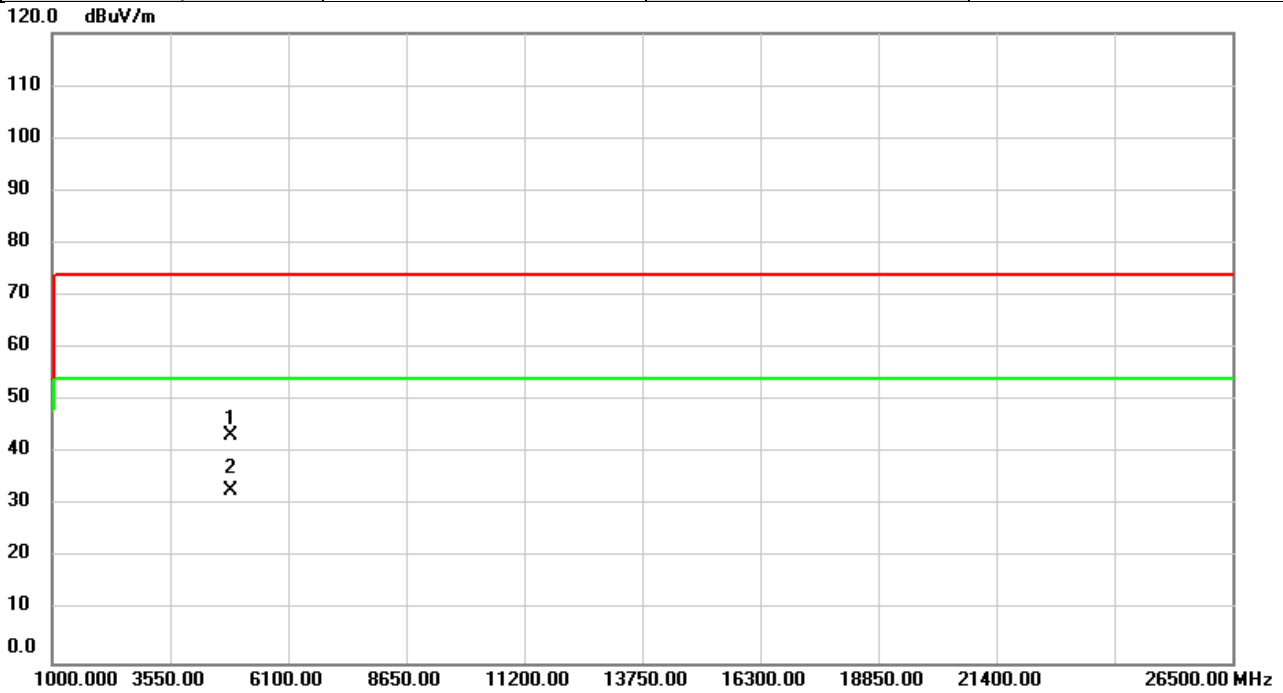

No.	Mk.	Freq.	Reading Level	Correct Factor	Measurement	Limit	Over	Detector	Comment
		MHz	dBuV	dB	dBuV/m	dBuV/m	dB		
1		4874.000	53.02	-9.79	43.23	74.00	-30.77	peak	
2	*	4874.000	42.66	-9.79	32.87	54.00	-21.13	AVG	

REMARKS:

- (1) Measurement Value = Reading Level + Correct Factor.
- (2) Margin Level = Measurement Value - Limit Value.

Test Mode	IEEE 802.11b	Test Date	2020/11/26
Test Frequency	2462MHz	Polarization	Vertical
Temp	23°C	Hum.	64%

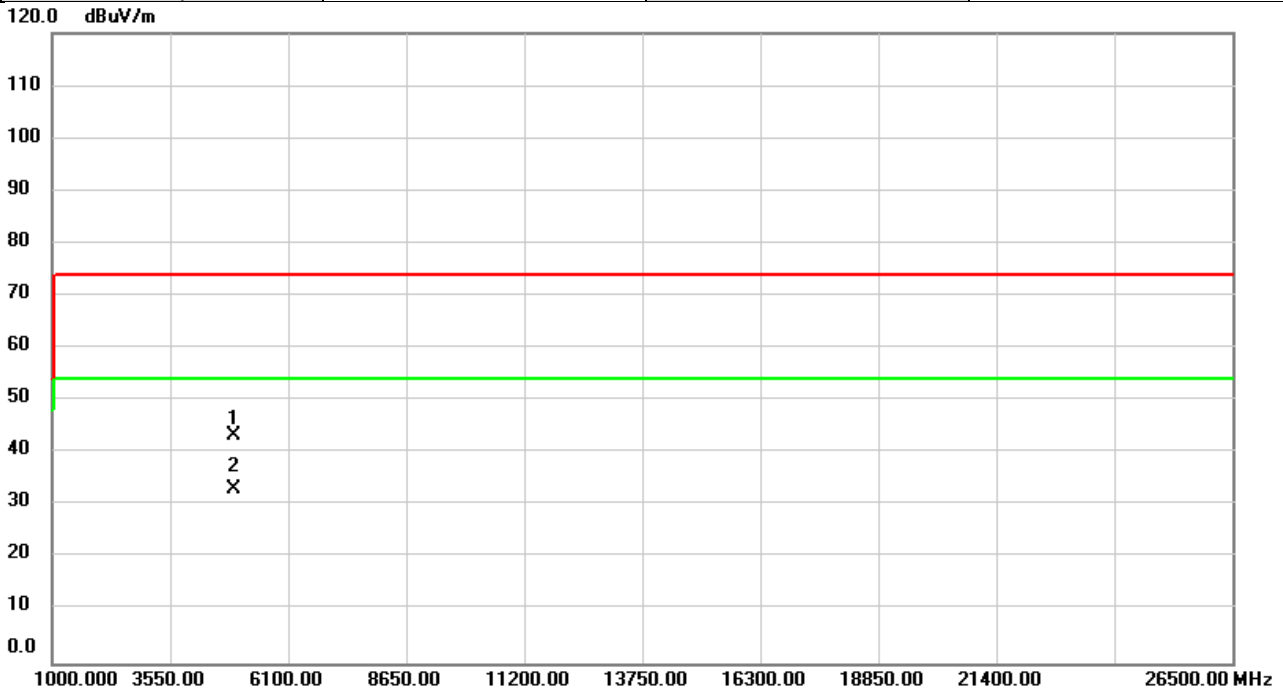

No.	Mk.	Freq. MHz	Reading Level dBuV	Correct Factor dB	Measure- ment dBuV/m	Limit dBuV/m	Over dB	Detector	Comment
1		4924.000	52.83	-9.62	43.21	74.00	-30.79	peak	
2	*	4924.000	42.70	-9.62	33.08	54.00	-20.92	AVG	

REMARKS:

- (1) Measurement Value = Reading Level + Correct Factor.
- (2) Margin Level = Measurement Value - Limit Value.

Test Mode	IEEE 802.11b	Test Date	2020/11/26
Test Frequency	2462MHz	Polarization	Horizontal
Temp	23°C	Hum.	64%

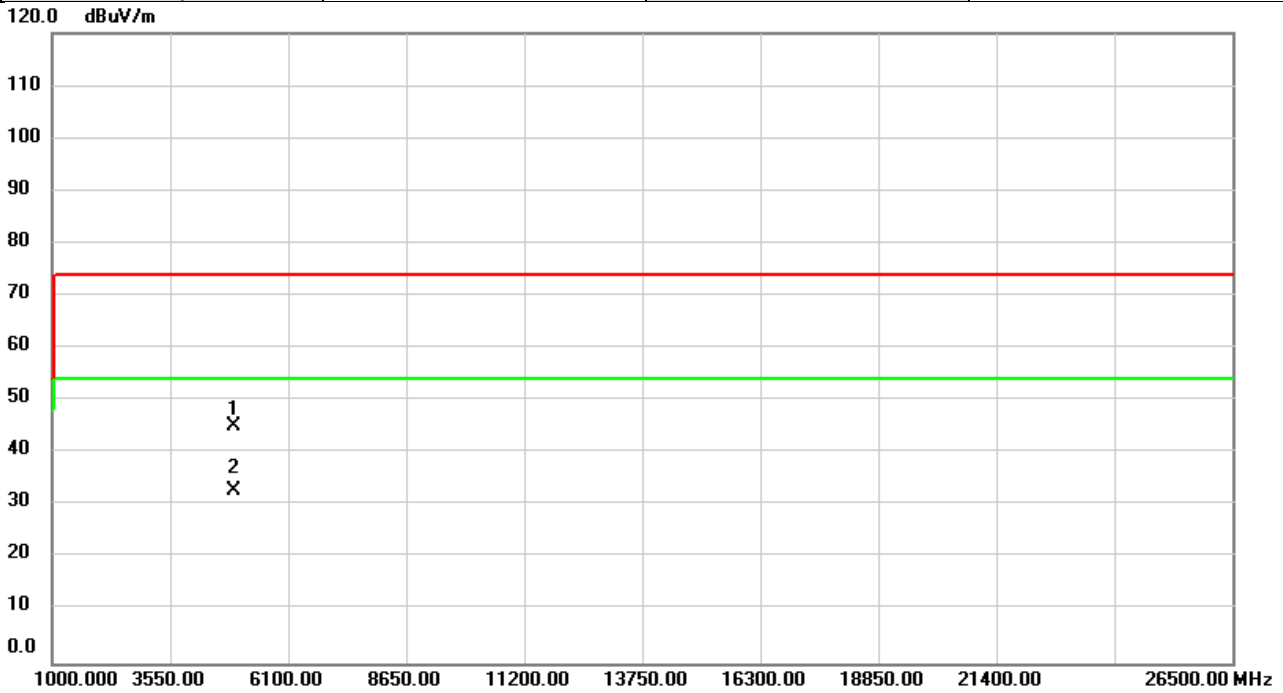

No.	Mk.	Freq. MHz	Reading Level dBuV	Correct Factor dB	Measure- ment dBuV/m	Limit dBuV/m	Over dB	Detector	Comment
1		4924.000	54.80	-9.62	45.18	74.00	-28.82	peak	
2	*	4924.000	42.37	-9.62	32.75	54.00	-21.25	AVG	

REMARKS:

- (1) Measurement Value = Reading Level + Correct Factor.
- (2) Margin Level = Measurement Value - Limit Value.

Test Mode	IEEE 802.11g	Test Date	2020/11/26
Test Frequency	2412MHz	Polarization	Vertical
Temp	23°C	Hum.	64%

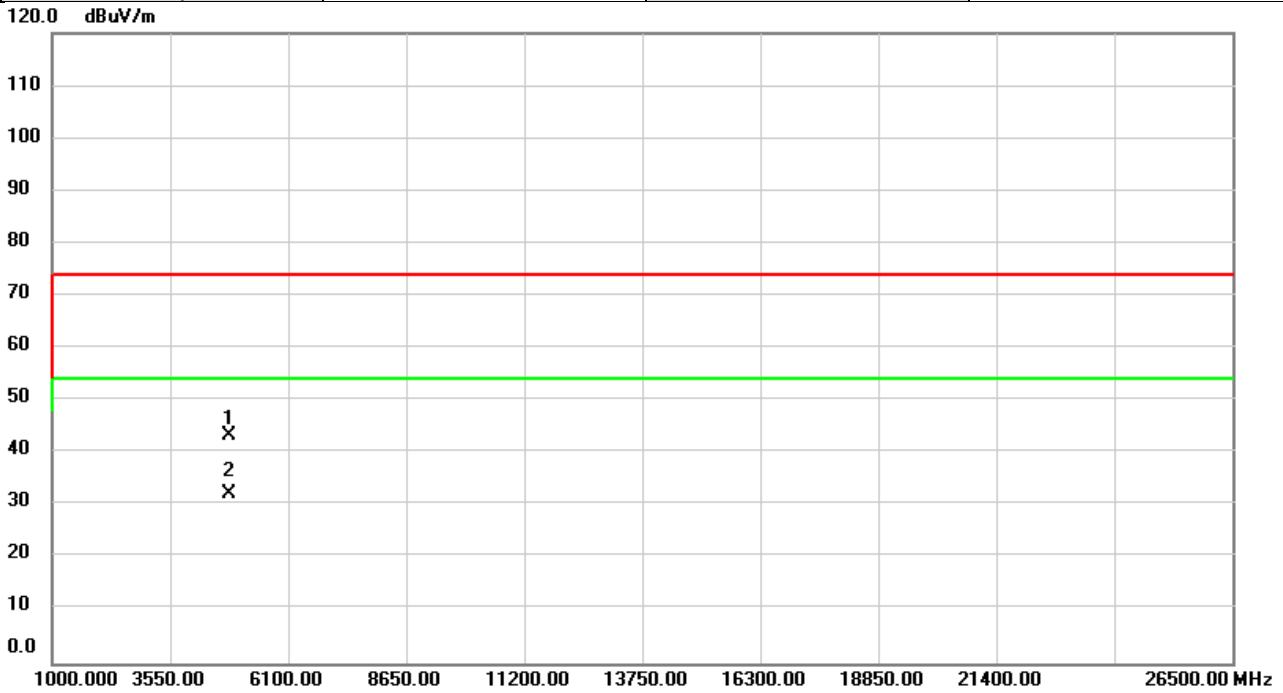

No.	Mk.	Freq. MHz	Reading Level dBuV	Correct Factor dB	Measure- ment dBuV/m	Limit dBuV/m	Over dB	Detector	Comment
1		4824.000	53.16	-9.96	43.20	74.00	-30.80	peak	
2	*	4824.000	42.12	-9.96	32.16	54.00	-21.84	AVG	

REMARKS:

- (1) Measurement Value = Reading Level + Correct Factor.
- (2) Margin Level = Measurement Value - Limit Value.

Test Mode	IEEE 802.11g	Test Date	2020/11/26
Test Frequency	2412MHz	Polarization	Horizontal
Temp	23°C	Hum.	64%

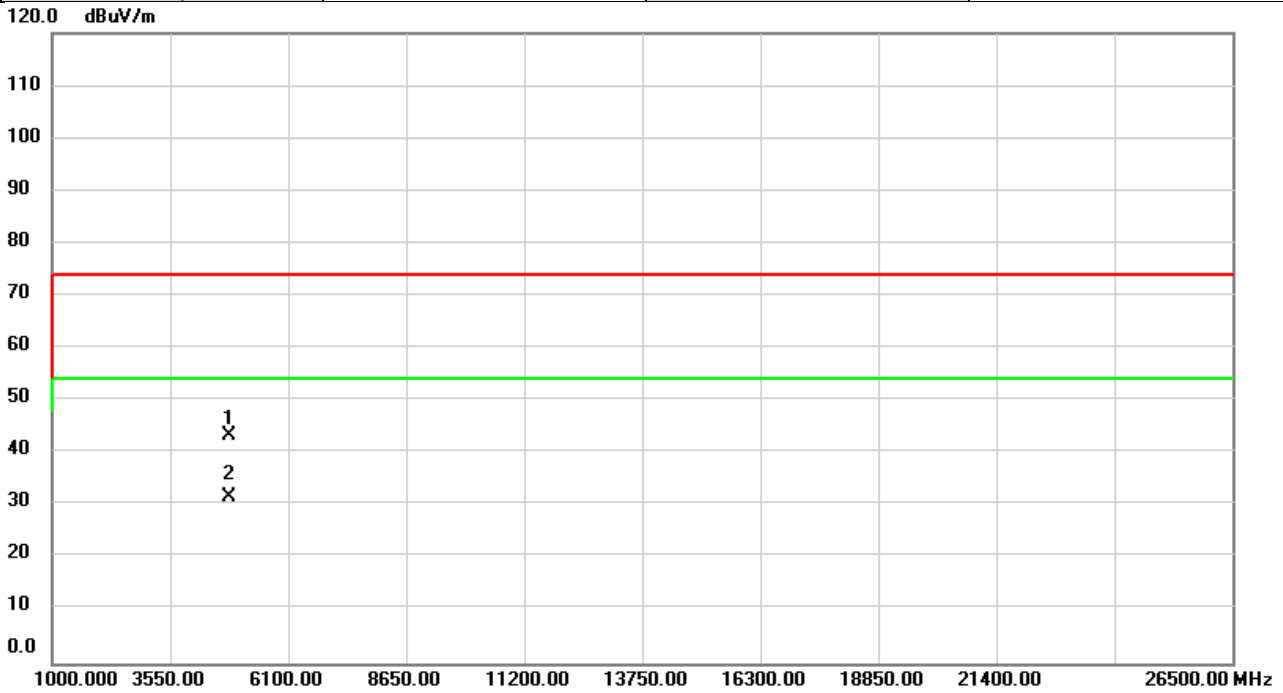

No.	Mk.	Freq. MHz	Reading Level dBuV	Correct Factor dB	Measure- ment dBuV/m	Limit dBuV/m	Over dB	Detector	Comment
1		4824.000	53.29	-9.96	43.33	74.00	-30.67	peak	
2	*	4824.000	41.60	-9.96	31.64	54.00	-22.36	AVG	

REMARKS:

- (1) Measurement Value = Reading Level + Correct Factor.
- (2) Margin Level = Measurement Value - Limit Value.

Test Mode	IEEE 802.11g	Test Date	2020/11/26
Test Frequency	2437MHz	Polarization	Vertical
Temp	23°C	Hum.	64%

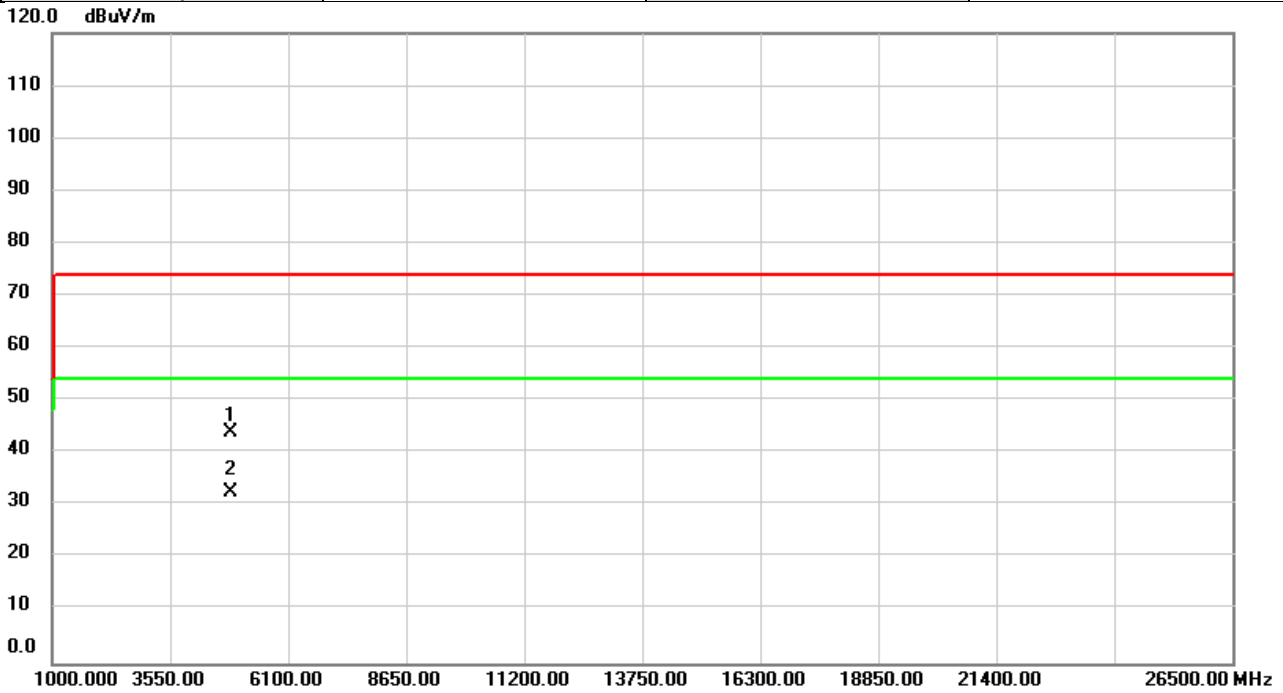

No.	Mk.	Freq.	Reading Level	Correct Factor	Measurement	Limit	Over	Detector	Comment
		MHz	dBuV	dB	dBuV/m	dBuV/m	dB		
1		4874.000	53.70	-9.79	43.91	74.00	-30.09	peak	
2	*	4874.000	42.37	-9.79	32.58	54.00	-21.42	AVG	

REMARKS:

- (1) Measurement Value = Reading Level + Correct Factor.
- (2) Margin Level = Measurement Value - Limit Value.

Test Mode	IEEE 802.11g	Test Date	2020/11/26
Test Frequency	2437MHz	Polarization	Horizontal
Temp	23°C	Hum.	64%

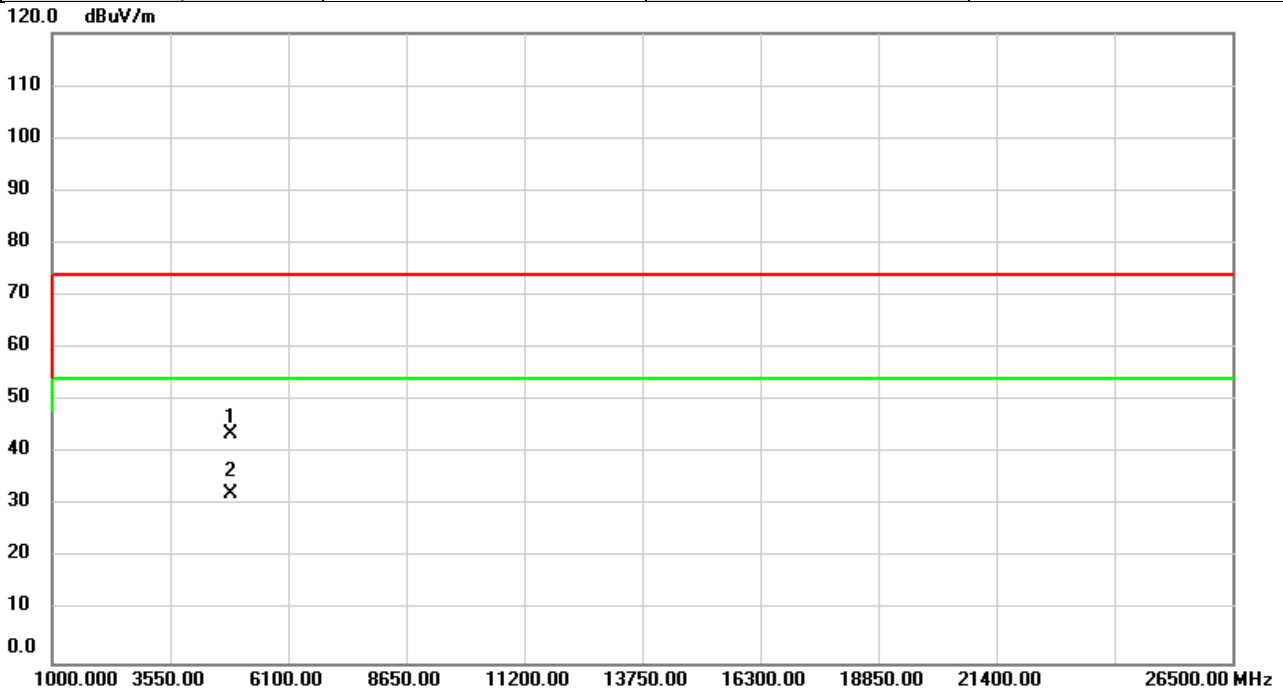

No.	Mk.	Freq. MHz	Reading Level dBuV	Correct Factor dB	Measure- ment dBuV/m	Limit dBuV/m	Over dB	Detector	Comment
1		4874.000	53.51	-9.79	43.72	74.00	-30.28	peak	
2	*	4874.000	41.97	-9.79	32.18	54.00	-21.82	AVG	

REMARKS:

- (1) Measurement Value = Reading Level + Correct Factor.
- (2) Margin Level = Measurement Value - Limit Value.

Test Mode	IEEE 802.11g	Test Date	2020/11/26
Test Frequency	2462MHz	Polarization	Vertical
Temp	23°C	Hum.	64%

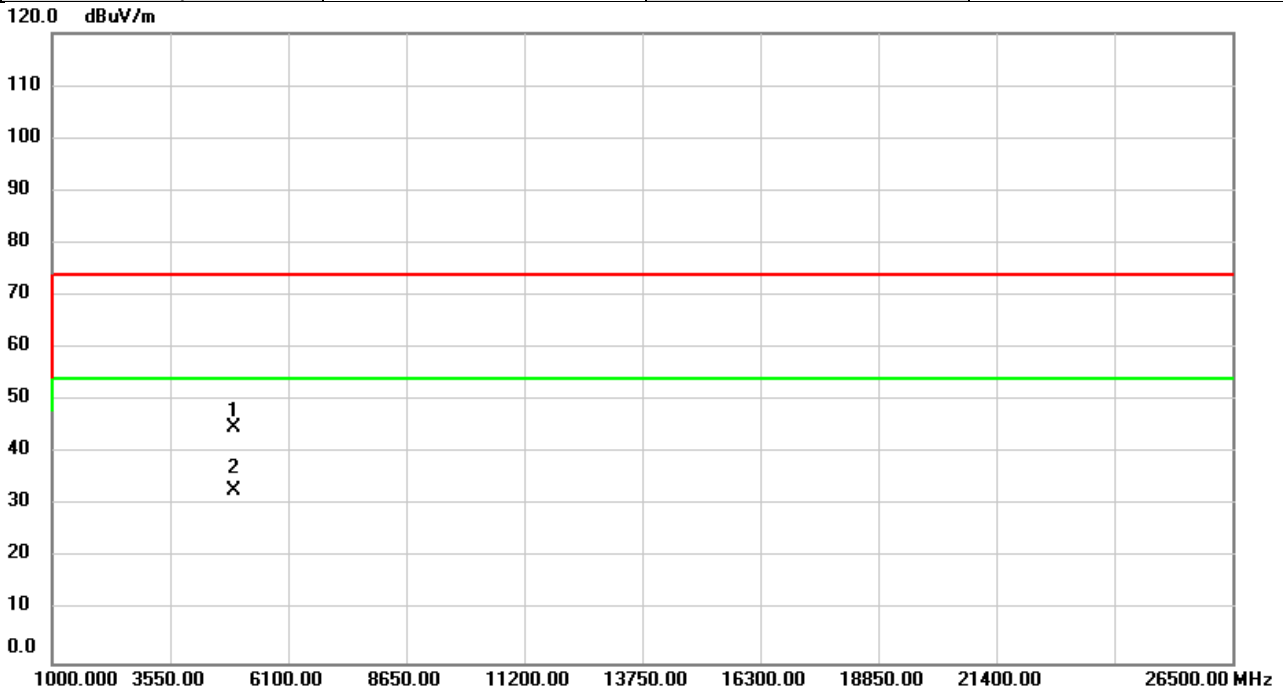

No.	Mk.	Freq. MHz	Reading Level dBuV	Correct Factor dB	Measure- ment dBuV/m	Limit dBuV/m	Over dB	Detector	Comment
1		4924.000	54.36	-9.62	44.74	74.00	-29.26	peak	
2	*	4924.000	42.56	-9.62	32.94	54.00	-21.06	AVG	

REMARKS:

- (1) Measurement Value = Reading Level + Correct Factor.
- (2) Margin Level = Measurement Value - Limit Value.

Test Mode	IEEE 802.11g	Test Date	2020/11/26
Test Frequency	2462MHz	Polarization	Horizontal
Temp	23°C	Hum.	64%

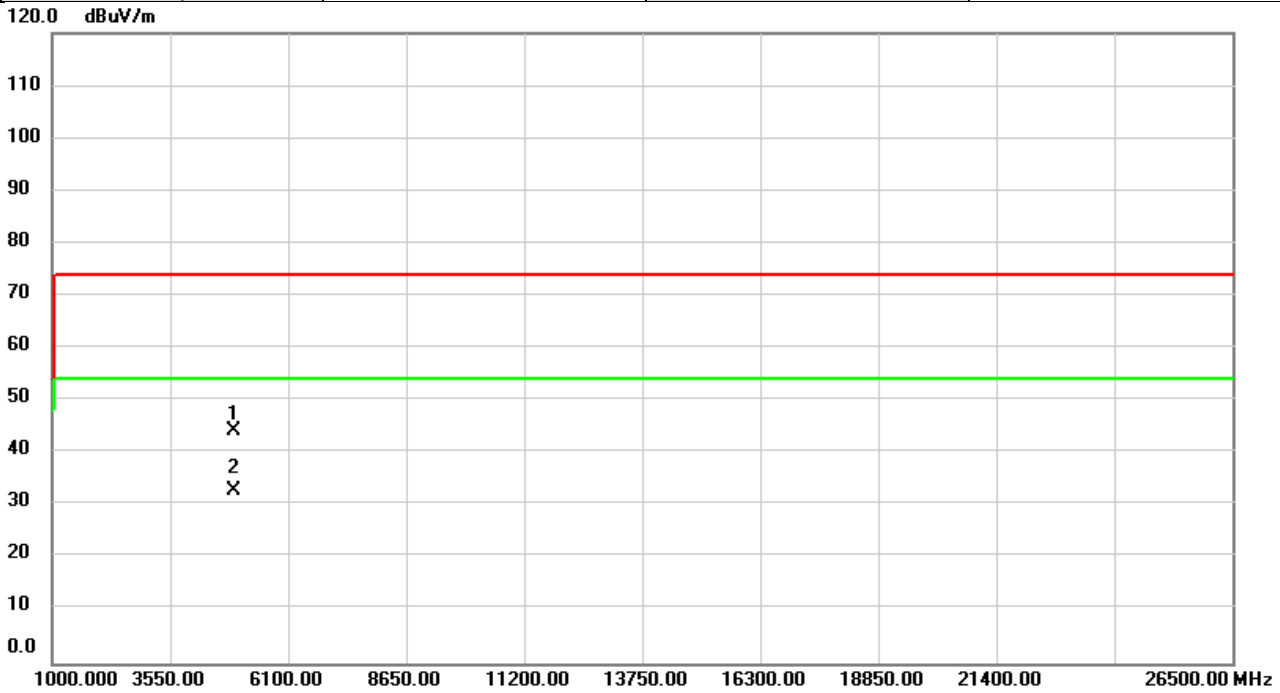

No.	Mk.	Freq. MHz	Reading Level dBuV	Correct Factor dB	Measure- ment dBuV/m	Limit dBuV/m	Over dB	Detector	Comment
1		4924.000	53.88	-9.62	44.26	74.00	-29.74	peak	
2	*	4924.000	42.35	-9.62	32.73	54.00	-21.27	AVG	

REMARKS:

- (1) Measurement Value = Reading Level + Correct Factor.
- (2) Margin Level = Measurement Value - Limit Value.

Test Mode	IEEE 802.11n(HT20)	Test Date	2020/11/26
Test Frequency	2412MHz	Polarization	Vertical
Temp	23°C	Hum.	64%

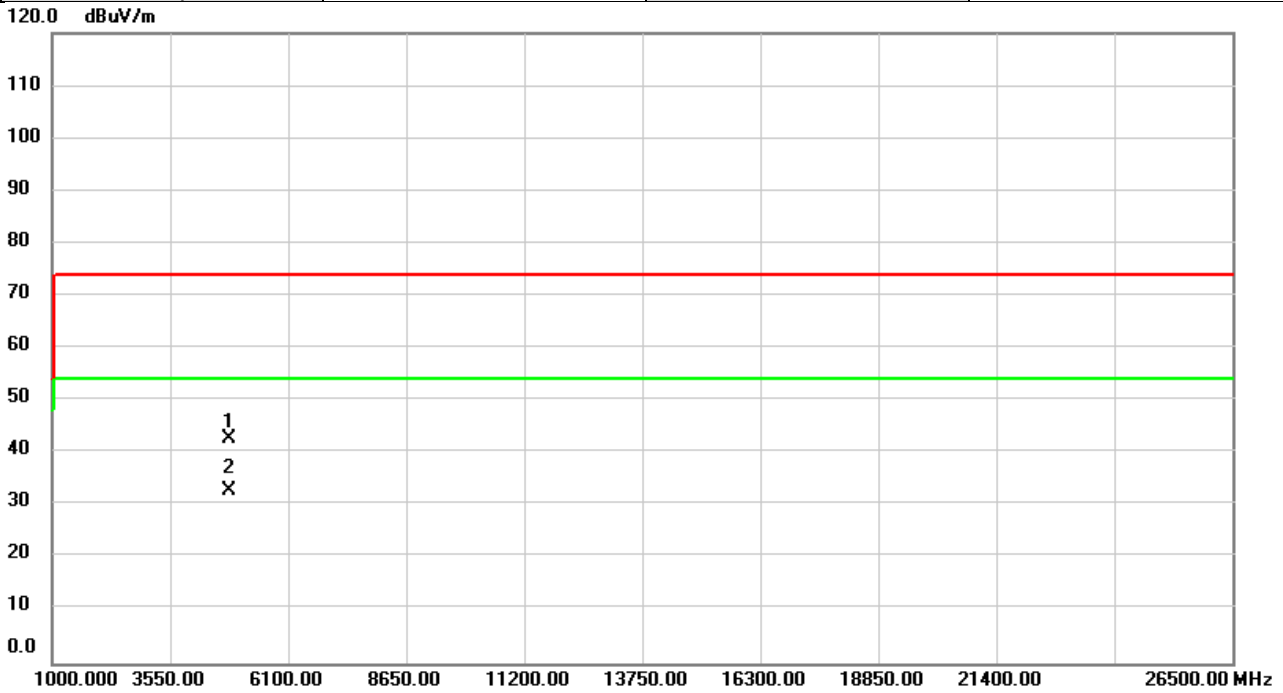

No.	Mk.	Freq.	Reading Level	Correct Factor	Measurement	Limit	Over	Detector	Comment
		MHz	dBuV	dB	dBuV/m	dBuV/m	dB		
1		4824.000	52.78	-9.96	42.82	74.00	-31.18	peak	
2	*	4824.000	42.68	-9.96	32.72	54.00	-21.28	AVG	

REMARKS:

- (1) Measurement Value = Reading Level + Correct Factor.
- (2) Margin Level = Measurement Value - Limit Value.

Test Mode	IEEE 802.11n(HT20)	Test Date	2020/11/26
Test Frequency	2412MHz	Polarization	Horizontal
Temp	23°C	Hum.	64%

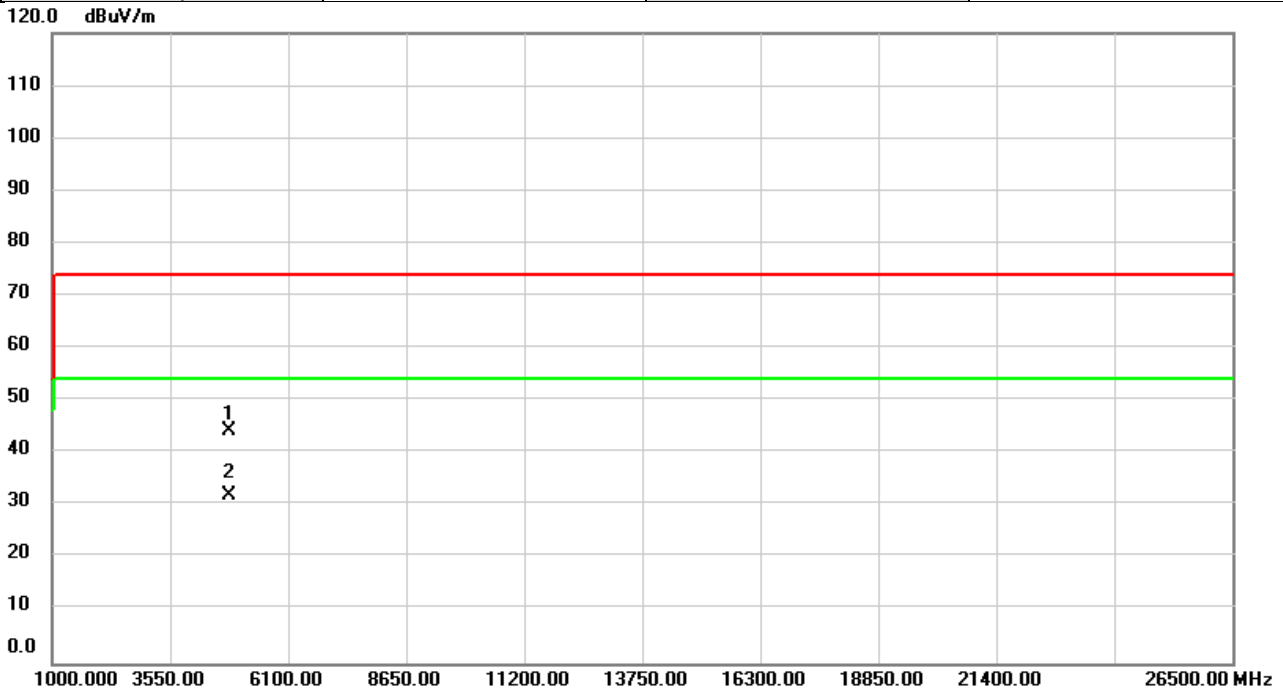

No.	Mk.	Freq. MHz	Reading Level dBuV	Correct Factor dB	Measure- ment dBuV/m	Limit dBuV/m	Over dB	Detector	Comment
1		4824.000	54.22	-9.96	44.26	74.00	-29.74	peak	
2	*	4824.000	41.86	-9.96	31.90	54.00	-22.10	AVG	

REMARKS:

- (1) Measurement Value = Reading Level + Correct Factor.
- (2) Margin Level = Measurement Value - Limit Value.

Test Mode	IEEE 802.11n(HT20)	Test Date	2020/11/26
Test Frequency	2437MHz	Polarization	Vertical
Temp	23°C	Hum.	64%

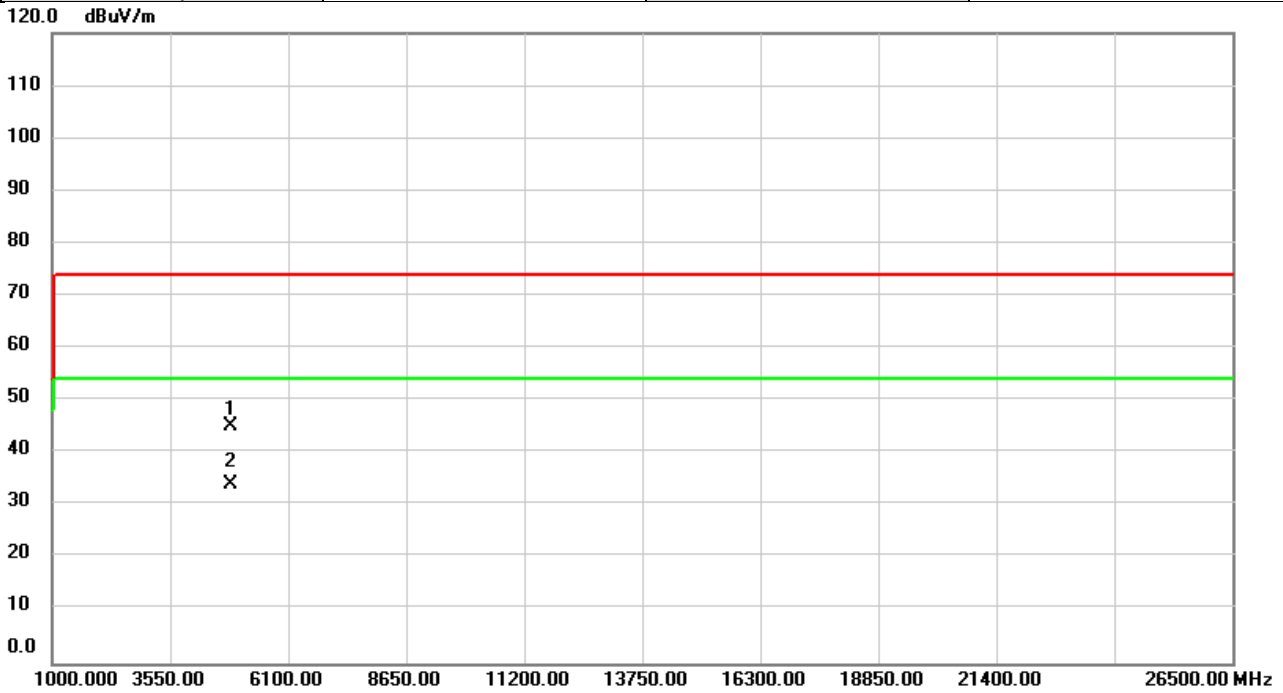

No.	Mk.	Freq. MHz	Reading Level dBuV	Correct Factor dB	Measure- ment dBuV/m	Limit dBuV/m	Over dB	Detector	Comment
1		4874.000	55.07	-9.79	45.28	74.00	-28.72	peak	
2	*	4874.000	43.77	-9.79	33.98	54.00	-20.02	AVG	

REMARKS:

- (1) Measurement Value = Reading Level + Correct Factor.
- (2) Margin Level = Measurement Value - Limit Value.

Test Mode	IEEE 802.11n(HT20)	Test Date	2020/11/26
Test Frequency	2437MHz	Polarization	Horizontal
Temp	23°C	Hum.	64%

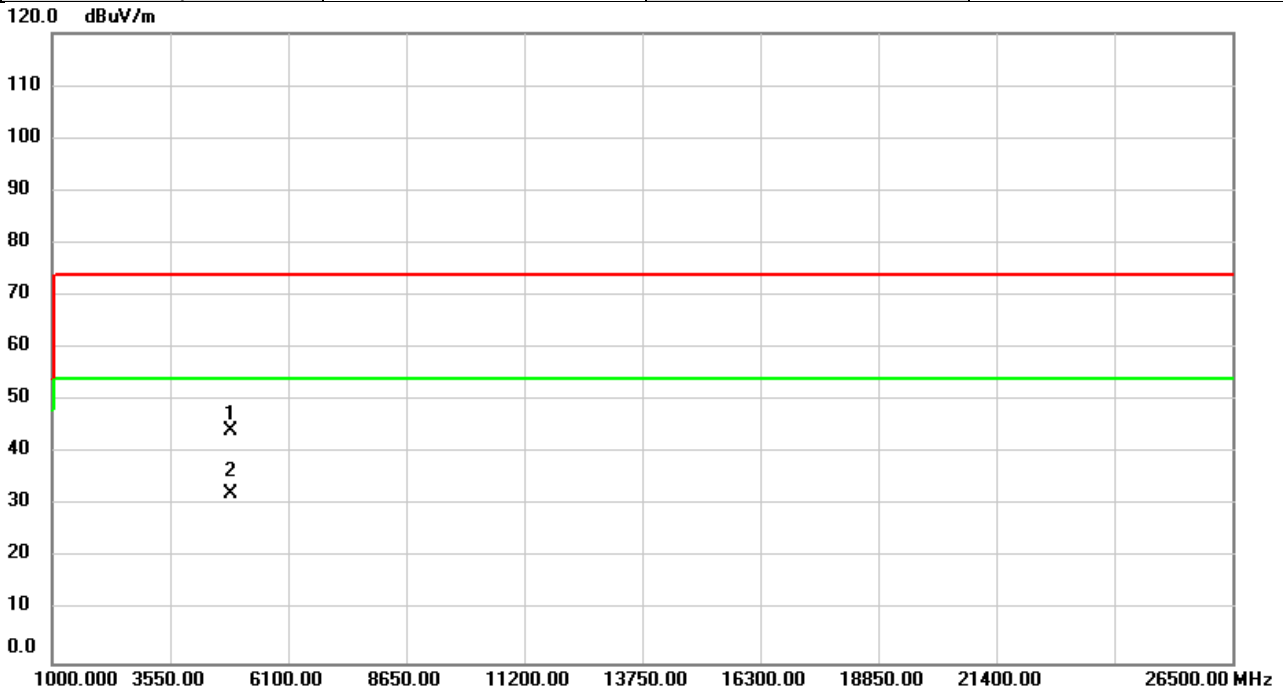

No.	Mk.	Freq.	Reading Level	Correct Factor	Measurement	Limit	Over	Detector	Comment
		MHz	dBuV	dB	dBuV/m	dBuV/m	dB		
1		4874.000	53.94	-9.79	44.15	74.00	-29.85	peak	
2	*	4874.000	42.11	-9.79	32.32	54.00	-21.68	AVG	

REMARKS:

- (1) Measurement Value = Reading Level + Correct Factor.
- (2) Margin Level = Measurement Value - Limit Value.

Test Mode	IEEE 802.11n(HT20)	Test Date	2020/11/26
Test Frequency	2462MHz	Polarization	Vertical
Temp	23°C	Hum.	64%

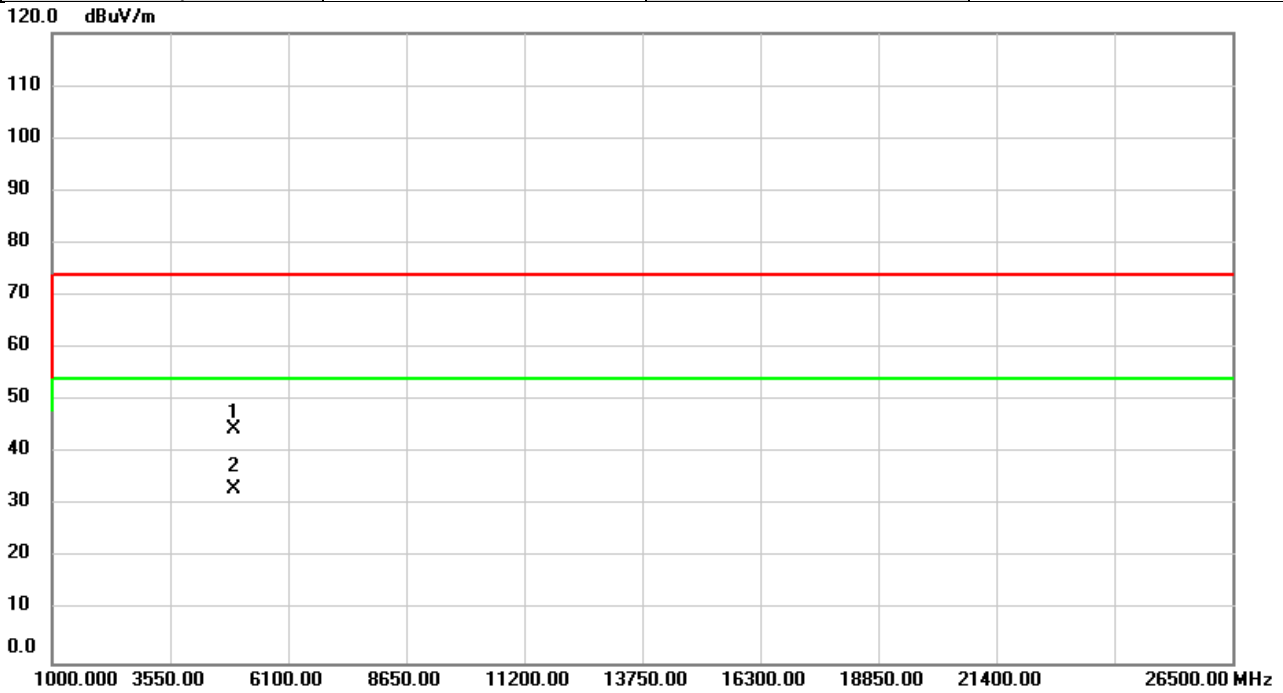

No.	Mk.	Freq.	Reading Level	Correct Factor	Measurement	Limit	Over	Detector	Comment
		MHz	dBuV	dB	dBuV/m	dBuV/m	dB		
1		4924.000	54.09	-9.62	44.47	74.00	-29.53	peak	
2	*	4924.000	42.66	-9.62	33.04	54.00	-20.96	AVG	

REMARKS:

- (1) Measurement Value = Reading Level + Correct Factor.
- (2) Margin Level = Measurement Value - Limit Value.

Test Mode	IEEE 802.11n(HT20)	Test Date	2020/11/26
Test Frequency	2462MHz	Polarization	Horizontal
Temp	23°C	Hum.	64%

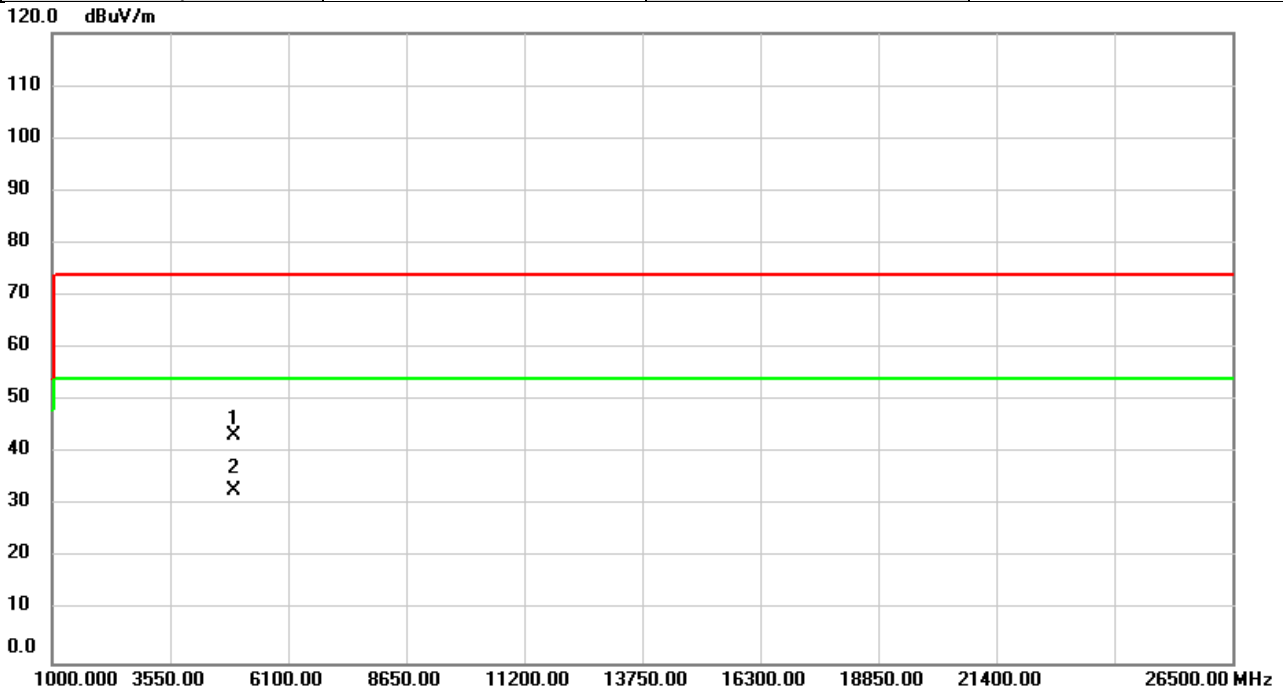

No.	Mk.	Freq. MHz	Reading Level dBuV	Correct Factor dB	Measure- ment dBuV/m	Limit dBuV/m	Over dB	Detector	Comment
1		4924.000	53.11	-9.62	43.49	74.00	-30.51	peak	
2	*	4924.000	42.41	-9.62	32.79	54.00	-21.21	AVG	

REMARKS:

- (1) Measurement Value = Reading Level + Correct Factor.
- (2) Margin Level = Measurement Value - Limit Value.

Test Mode	IEEE 802.11n(HT40)	Test Date	2020/11/26
Test Frequency	2422MHz	Polarization	Vertical
Temp	23°C	Hum.	64%

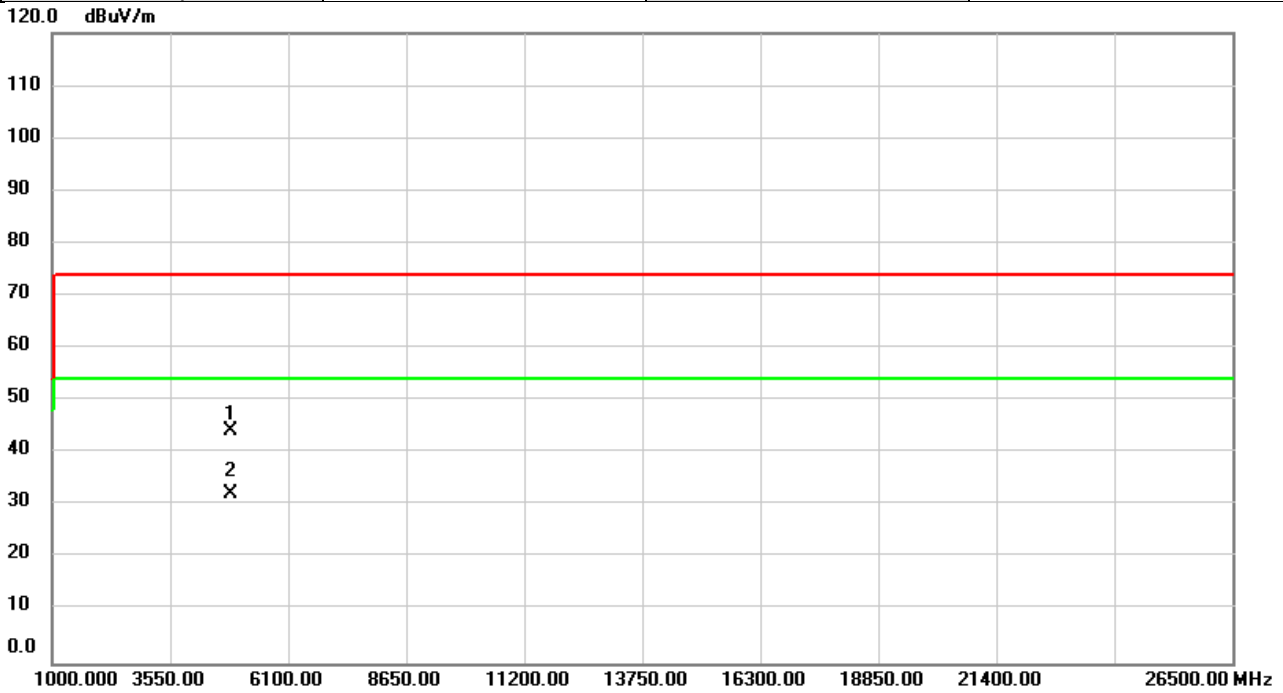

No.	Mk.	Freq.	Reading Level	Correct Factor	Measurement	Limit	Over	Detector	Comment
		MHz	dBuV	dB	dBuV/m	dBuV/m	dB		
1		4844.000	54.17	-9.89	44.28	74.00	-29.72	peak	
2	*	4844.000	42.19	-9.89	32.30	54.00	-21.70	AVG	

REMARKS:

- (1) Measurement Value = Reading Level + Correct Factor.
- (2) Margin Level = Measurement Value - Limit Value.

Test Mode	IEEE 802.11n(HT40)	Test Date	2020/11/26
Test Frequency	2422MHz	Polarization	Horizontal
Temp	23°C	Hum.	64%

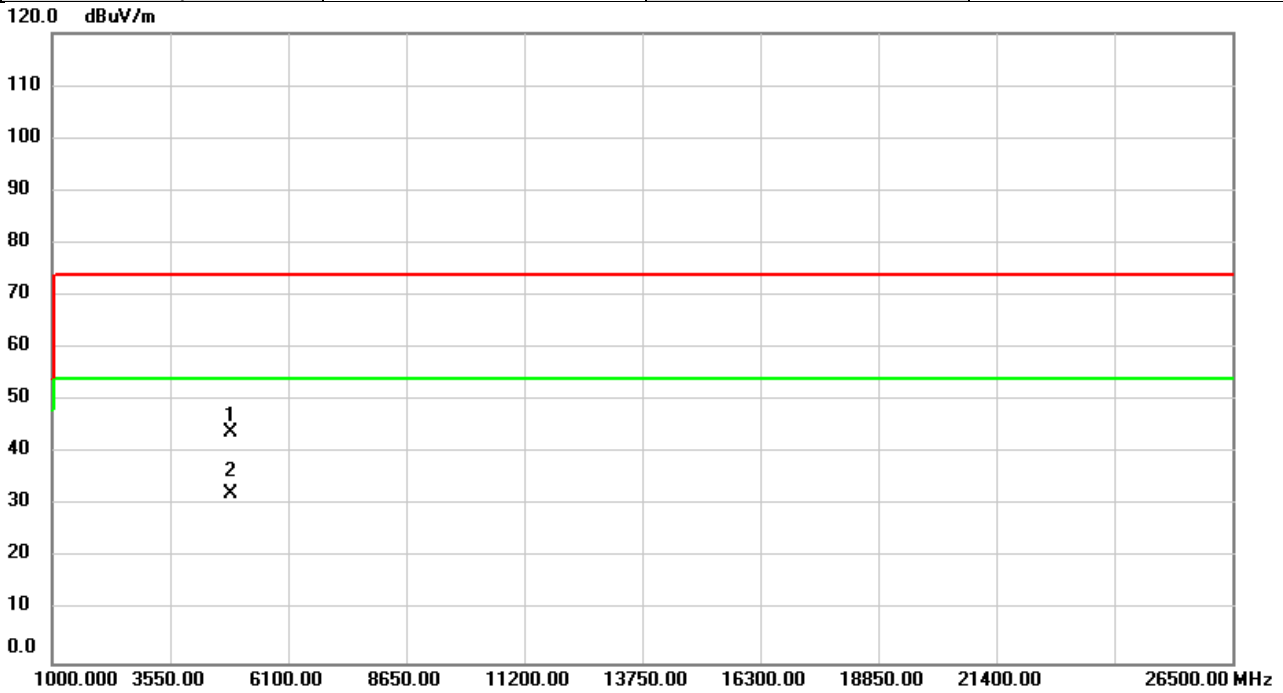

No.	Mk.	Freq.	Reading Level	Correct Factor	Measurement	Limit	Over	Detector	Comment
		MHz	dBuV	dB	dBuV/m	dBuV/m	dB		
1		4844.000	53.89	-9.89	44.00	74.00	-30.00	peak	
2	*	4844.000	42.12	-9.89	32.23	54.00	-21.77	AVG	

REMARKS:

- (1) Measurement Value = Reading Level + Correct Factor.
- (2) Margin Level = Measurement Value - Limit Value.

Test Mode	IEEE 802.11n(HT40)	Test Date	2020/11/26
Test Frequency	2437MHz	Polarization	Vertical
Temp	23°C	Hum.	64%

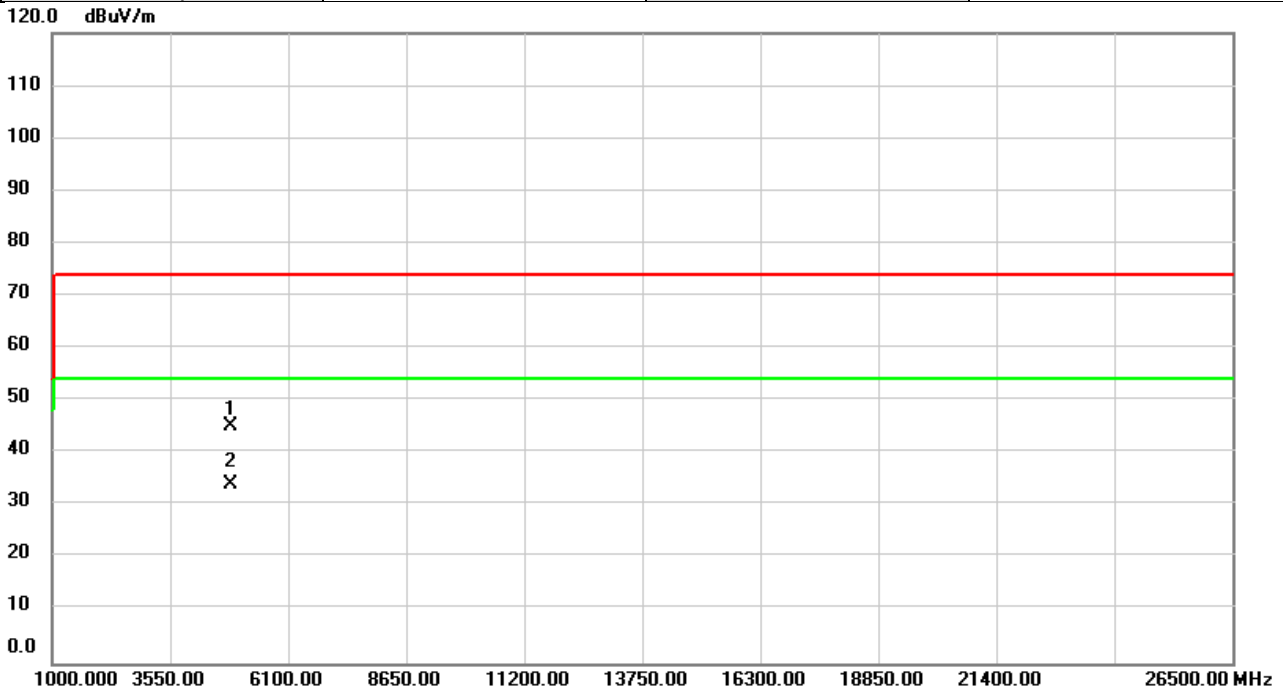

No.	Mk.	Freq.	Reading Level	Correct Factor	Measurement	Limit	Over	Detector	Comment
		MHz	dBuV	dB	dBuV/m	dBuV/m	dB		
1		4874.000	54.97	-9.79	45.18	74.00	-28.82	peak	
2	*	4874.000	43.84	-9.79	34.05	54.00	-19.95	AVG	

REMARKS:

- (1) Measurement Value = Reading Level + Correct Factor.
- (2) Margin Level = Measurement Value - Limit Value.

Test Mode	IEEE 802.11n(HT40)	Test Date	2020/11/26
Test Frequency	2437MHz	Polarization	Horizontal
Temp	23°C	Hum.	64%

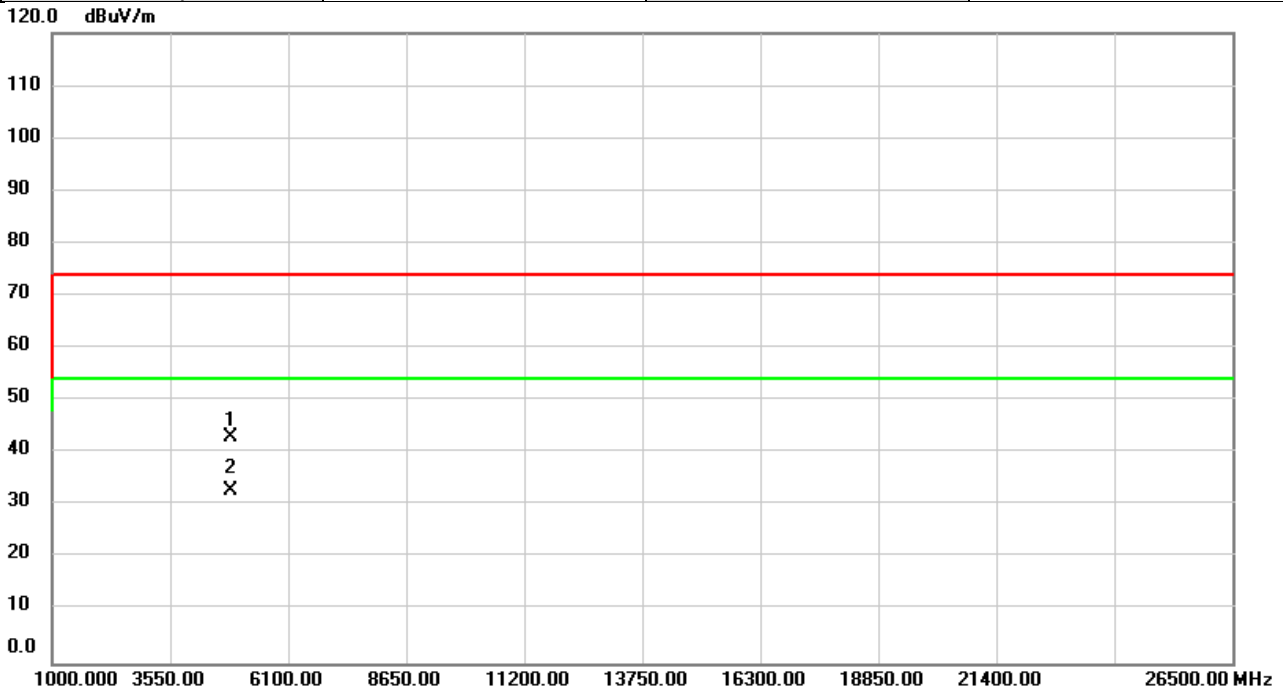

No.	Mk.	Freq.	Reading Level	Correct Factor	Measurement	Limit	Over	Detector	Comment
		MHz	dBuV	dB	dBuV/m	dBuV/m	dB		
1		4874.000	52.97	-9.79	43.18	74.00	-30.82	peak	
2	*	4874.000	42.77	-9.79	32.98	54.00	-21.02	AVG	

REMARKS:

- (1) Measurement Value = Reading Level + Correct Factor.
- (2) Margin Level = Measurement Value - Limit Value.

Test Mode	IEEE 802.11n(HT40)	Test Date	2020/11/26
Test Frequency	2452MHz	Polarization	Vertical
Temp	23°C	Hum.	64%

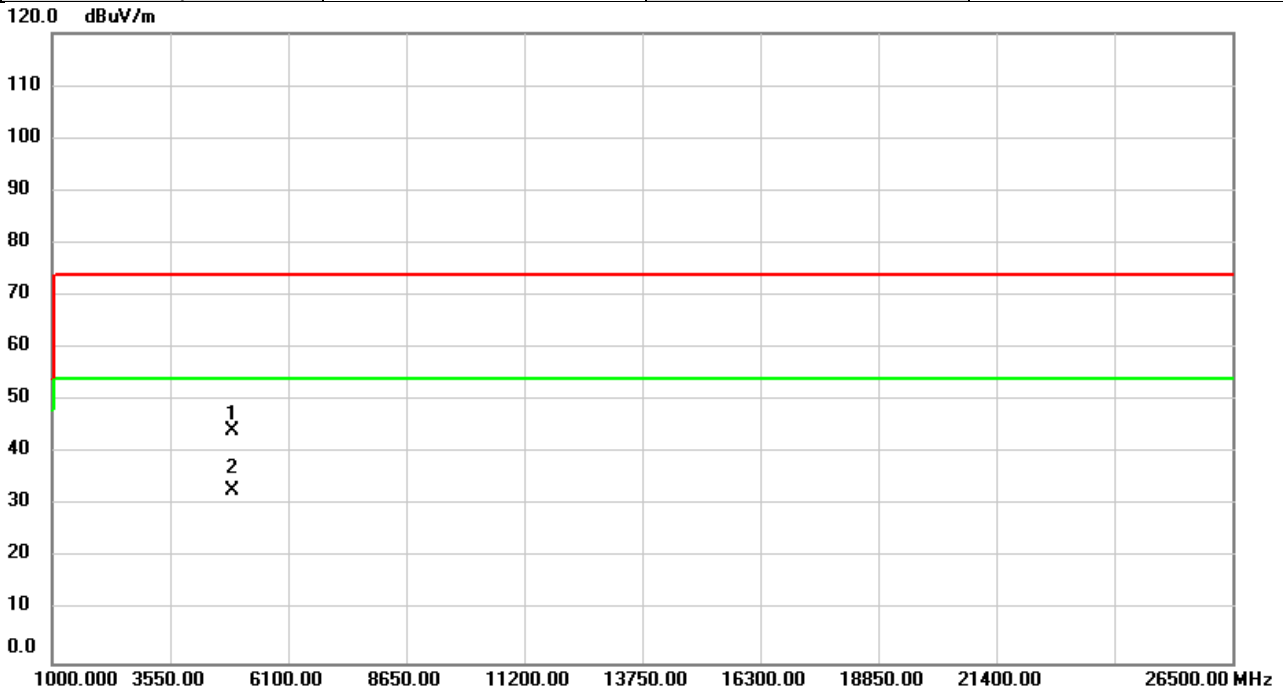

No.	Mk.	Freq. MHz	Reading Level dBuV	Correct Factor dB	Measure- ment dBuV/m	Limit dBuV/m	Over dB	Detector	Comment
1		4904.000	53.85	-9.69	44.16	74.00	-29.84	peak	
2	*	4904.000	42.50	-9.69	32.81	54.00	-21.19	AVG	

REMARKS:

- (1) Measurement Value = Reading Level + Correct Factor.
- (2) Margin Level = Measurement Value - Limit Value.

Test Mode	IEEE 802.11n(HT40)	Test Date	2020/11/26
Test Frequency	2452MHz	Polarization	Horizontal
Temp	23°C	Hum.	64%

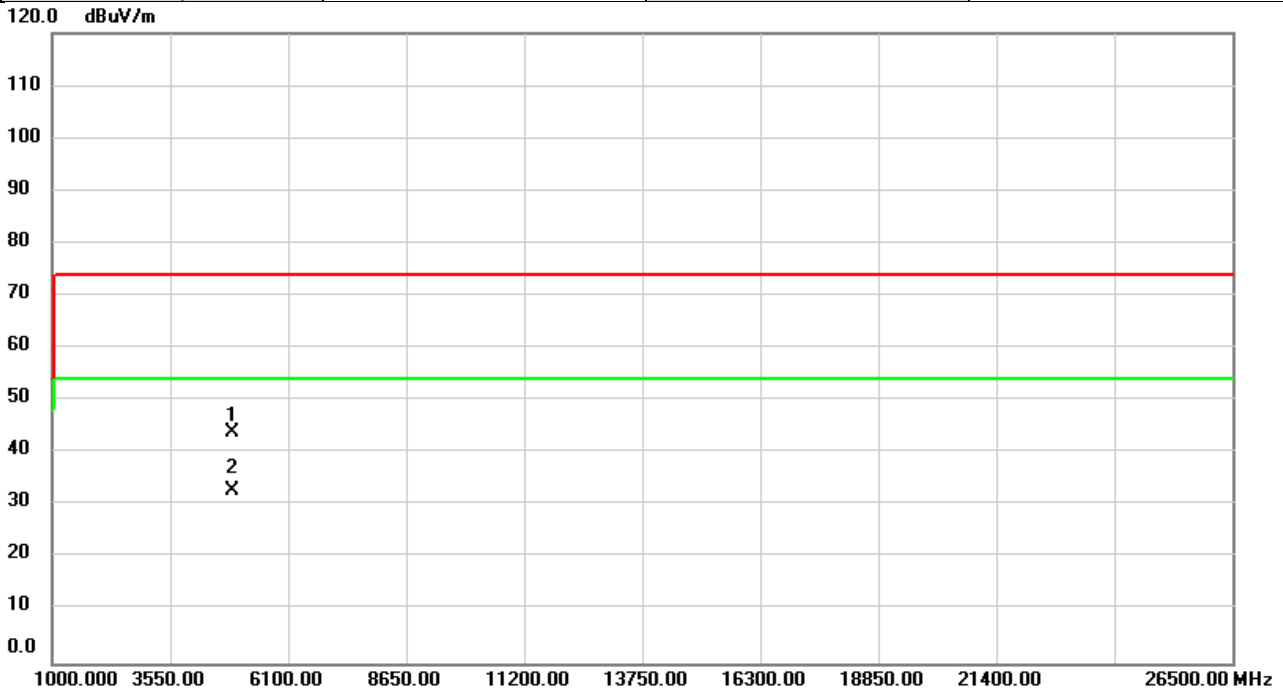

No.	Mk.	Freq. MHz	Reading Level dBuV	Correct Factor dB	Measure- ment dBuV/m	Limit dBuV/m	Over dB	Detector	Comment
1		4904.000	53.72	-9.69	44.03	74.00	-29.97	peak	
2	*	4904.000	42.46	-9.69	32.77	54.00	-21.23	AVG	

REMARKS:

- (1) Measurement Value = Reading Level + Correct Factor.
- (2) Margin Level = Measurement Value - Limit Value.

End of Test Report