

S

T

S

L

A

B



RADIO TEST REPORT

Report No:STS1812199W03

Issued for

Hangzhou Freevision Intelligent Technology Co., Ltd.

5th Floor, Building 2, No. 368 Jinpeng Street, Sandun Town,
Westlake District, Hangzhou City, China

Product Name:	Handle Gimble
Brand Name:	Freevision
Model Name:	VT21
Series Model:	VT20
FCC ID:	2ALQU-VT20
IC:	22607-VT20
Test Standard:	FCC Part 15.247
	RSS-247 Issue 2, February 2017

Any reproduction of this document must be done in full. No single part of this document may be reproduced without permission from STS, All Test Data Presented in this report is only applicable to presented Test sample.

Shenzhen STS Test Services Co., Ltd.
1/F., Building B, Zhuoke Science Park, No.190, Chongqing Road,
Fuyong Street, Bao'an District, Shenzhen, Guangdong, China
TEL: +86-755 3688 6288 FAX: +86-755 3688 6277 E-mail:sts@stsapp.com

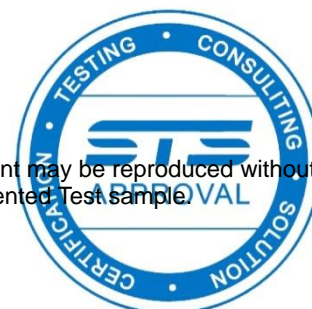



TEST RESULT CERTIFICATION

Applicant's name: Hangzhou Freevision Intelligent Technology Co., Ltd.
Address: 5th Floor, Building 2, No. 368 Jinpeng Street, Sandun Town,
 Westlake District, Hangzhou City, China
Manufacture's Name.....: Hangzhou Freevision Intelligent Technology Co., Ltd.
Address: 5th Floor, Building 2, No. 368 Jinpeng Street, Sandun Town,
 Westlake District, Hangzhou City, China

Product description

Product Name.....: Handle Gimble
Brand Name: Freevision
Model Name: VT21
Series Model.....: VT20

Test Standards.....: FCC Part15.247
 RSS-247 Issue 2, February 2017

Test procedure ANSI C63.10-2013

This device described above has been tested by STS, the test results show that the equipment under test (EUT) is in compliance with the FCC/IC requirements. And it is applicable only to the tested sample identified in the report.

This report shall not be reproduced except in full, without the written approval of STS, this document may be altered or revised by STS, personal only, and shall be noted in the revision of the document.

Date of Test:
Date (s) of performance of tests: 13 Dec.2018 ~20 Dec.2018
Date of Issue: 27 Dec.2018
Test Result.....: **Pass**

Testing Engineer : 

 (Chris chen)

Technical Manager : 

 (Sunday Hu)

Authorized Signatory : 

 (Vita Li)





Table of Contents

1. SUMMARY OF TEST RESULTS	6
1.1 TEST FACTORY	7
1.2 MEASUREMENT UNCERTAINTY	7
2. GENERAL INFORMATION	8
2.1 GENERAL DESCRIPTION OF EUT	8
2.2 DESCRIPTION OF TEST MODES	10
2.3 BLOCK DIGRAM SHOWING THE CONFIGURATION OF SYSTEM TESTED	11
2.4 DESCRIPTION OF SUPPORT UNITS(CONDUCTED MODE)	12
2.5 EQUIPMENTS LIST FOR ALL TEST ITEMS	13
3. EMC EMISSION TEST	14
3.1 CONDUCTED EMISSION MEASUREMENT	14
3.2 TEST PROCEDURE	15
3.3 TEST SETUP	15
3.4 EUT OPERATING CONDITIONS	15
3.5 TEST RESULTS	16
4. RADIATED EMISSION MEASUREMENT	18
4.1 RADIATED EMISSION LIMITS	18
4.2 TEST PROCEDURE	19
4.3 TEST SETUP	20
4.4 EUT OPERATING CONDITIONS	20
4.5 FIELD STRENGTH CALCULATION	21
4.6 TEST RESULTS	22
5. CONDUCTED SPURIOUS & BAND EDGE EMISSION	30
5.1 REQUIREMENT	30
5.2 TEST PROCEDURE	30
5.3 TEST SETUP	30
5.4 EUT OPERATION CONDITIONS	30
5.5 TEST RESULTS	31
6. POWER SPECTRAL DENSITY TEST	34
6.1 APPLIED PROCEDURES / LIMIT	34
6.2 TEST PROCEDURE	34
6.3 TEST SETUP	34
6.4 EUT OPERATION CONDITIONS	34



Table of Contents

6.5 TEST RESULTS	35
7. BANDWIDTH TEST	37
7.1 APPLIED PROCEDURES / LIMIT	37
7.2 TEST PROCEDURE	37
7.3 TEST SETUP	37
7.4 EUT OPERATION CONDITIONS	37
7.5 TEST RESULTS	38
8. PEAK OUTPUT POWER TEST	42
8.1 APPLIED PROCEDURES / LIMIT	42
8.2 TEST PROCEDURE	42
8.3 TEST SETUP	42
8.4 EUT OPERATION CONDITIONS	42
8.5 TEST RESULTS	43
9. ANTENNA REQUIREMENT	44
9.1 STANDARD REQUIREMENT	44
9.2 EUT ANTENNA	44
10.FREQUENCY STABILITY	45
10.1 LIMITS OF FREQUENCY STABILITY MEASUREMENT	45
10.2 TEST PROCEDURE	45
10.3 TEST RESULT	45
11. EUT TEST PHOTO	46



Revision History

Rev.	Issue Date	Report NO.	Effect Page	Contents
00	27 Dec.2018	STS1812199W03	ALL	Initial Issue





1. SUMMARY OF TEST RESULTS

Test procedures according to the technical standards:
KDB 558074 D01 DTS Meas Guidance v05r01

FCC Part 15.247,Subpart C RSS-247 Issue 2			
Standard Section	Test Item	Judgment	Remark
15.207 RSS-Gen Issue 5 8.8	Conducted Emission	PASS	--
15.247 (a)(2) RSS-247 Issue 2 5.2a	6dB Bandwidth	PASS	--
RSS-Gen Issue 5 6.7	99% Bandwidth	PASS	--
15.247 (b)(3) RSS-247 Issue 2 5.4d	Output Power	PASS	--
15.247 (d) RSS-247 Issue 2 5.5 RSS-Gen Issue 5 8.9 8.10	Radiated Spurious Emission	PASS	--
15.247 (d) RSS-247 Issue 2 (5.5) 15.209,15.205	Conducted Spurious & Band Edge Emission	PASS	--
15.247 (e) RSS-247 Issue 2 5.2b	Power Spectral Density	PASS	--
15.209,15.205	Restricted Band Edge Emission	PASS	--
Part 15.247(d)/part 15.209(a) RSS-247 Issue 2 5.5	Band Edge Emission	PASS	--
15.203 RSS-Gen Issue 5 6.8	Antenna Requirement	PASS	--
RSS-Gen Issue 5 6.11	Frequency Stability	PASS	--

NOTE:

- (1) "N/A" denotes test is not applicable in this Test Report
- (2) All tests are according to ANSI C63.10-2013



1.1 TEST FACTORY

Shenzhen STS Test Services Co., Ltd.

Add. : 1/F., Building B, Zhuoke Science Park, No.190, Chongqing Road,
Fuyong Street, Bao'an District, Shenzhen, Guangdong, China

FCC Registration No.: 625569

IC Registration No.: 12108A; A2LA Certificate No.: 4338.01;

1.2 MEASUREMENT UNCERTAINTY

The reported uncertainty of measurement $y \pm U$, where expanded uncertainty U is based on a standard uncertainty multiplied by a coverage factor of $k=2$, providing a level of confidence of approximately 95%.

No.	Item	Uncertainty
1	RF output power,conducted	$\pm 0.71\text{dB}$
2	Unwanted Emissions,conducted	$\pm 0.63\text{dB}$
3	All emissions,radiated 30-200MHz	$\pm 3.8\text{dB}$
4	All emissions,radiated 200MHz-1GHz	$\pm 3.97\text{dB}$
5	All emissions,radiated>1G	$\pm 3.03\text{dB}$
6	Conducted Emission(9KHz-150KHz)	$\pm 2.88\text{dB}$
7	Conducted Emission(150KHz-30MHz)	$\pm 2.67\text{dB}$



2. GENERAL INFORMATION

2.1 GENERAL DESCRIPTION OF EUT

Product Name	Handle Gimble	
Trade Name	Freevision	
Model Name	VT21	
Series Model	VT20	
Model Difference	Only different in marketing.	
Product Description	The EUT is Handle Gimble	
	Operation Frequency:	2402~2480 MHz
	Modulation Type:	GFSK
	Radio Technology	BLE
	Number Of Channel	40
	Antenna Designation:	Please see Note 3.
	Antenna Gain (dBi)	5.05 dBi
Channel List	Please refer to the Note 2.	
Battery	Battery(rating): Rated Voltage: 7.4V Charge Limit: 8.4V Capacity: 2000mAh	
Power Rating	Input:5V/2A Output:5V/1A(Wired charging and wireless charging)	
Hardware version number	V1.0	
Software version number	V02.00.00.21	
Radio Hardware version	MPLY.LR9.W1444,MD.LWTG.MP.V79.P4	
Radio Software version	SC6531_W13.04.05_Release	
Test Software	3.18.19	
RF Power Setting TEST Software (power class)	(1)2.4 GHz:GFSK(1Mbps):-6.5	
Connecting I/O Port(s)	Please refer to the User's Manual	

Note:

1. For a more detailed features description, please refer to the manufacturer's specifications or the User's Manual.



2.

Channel List							
Channel	Frequency (MHz)	Channel	Frequency (MHz)	Channel	Frequency (MHz)	Channel	Frequency (MHz)
37	2402	09	2422	18	2442	28	2462
00	2404	10	2424	19	2444	29	2464
01	2406	38	2426	20	2446	30	2466
02	2408	11	2428	21	2448	31	2468
03	2410	12	2430	22	2450	32	2470
04	2412	13	2432	23	2452	33	2472
05	2414	14	2434	24	2454	34	2474
06	2416	15	2436	25	2456	35	2476
07	2418	16	2438	26	2458	36	2478
08	2420	17	2440	27	2460	39	2480

3.

Table for Filed Antenna

Ant.	Brand	Model Name	Antenna Type	Connector	Gain (dBi)	NOTE
1	Freevision	VT21	Ceramic Antenna	N/A	5.05	BLE ANT.



2.2 DESCRIPTION OF TEST MODES

For conducted test items and radiated spurious emissions
Each of these EUT operation mode(s) or test configuration mode(s) mentioned below was evaluated respectively..

Worst Mode	Description	Data/Modulation
Mode 1	TX CH37(2402MHz)	1 MHz/GFSK
Mode 2	TX CH17(2440MHz)	1 MHz/GFSK
Mode 3	TX CH39(2480MHz)	1 MHz/GFSK

Note:

- (1) The measurements are performed at all Bit Rate of Transmitter, the worst data was reported
- (2) We have be tested for all avaiable U.S. voltage and frequencies(For 120V,50/60Hz and 240V, 50/60Hz) for which the device is capable of operation, and the worst case of 120V/60Hz is shown in the report
- (3) Controlled using a bespoke application on the laptop PC supplied by the customer. The application was used to enable a continuous transmission mode and to select the test channels, data rates and modulation schemes as required.

For AC Conducted Emission

Test Case	
AC Conducted Emission	Mode 4 : Keeping BT TX

2.3 BLOCK DIGRAM SHOWING THE CONFIGURATION OF SYSTEM TESTED

Radiated Spurious Emission Test

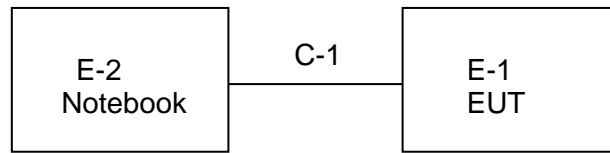

Conducted Emission Test

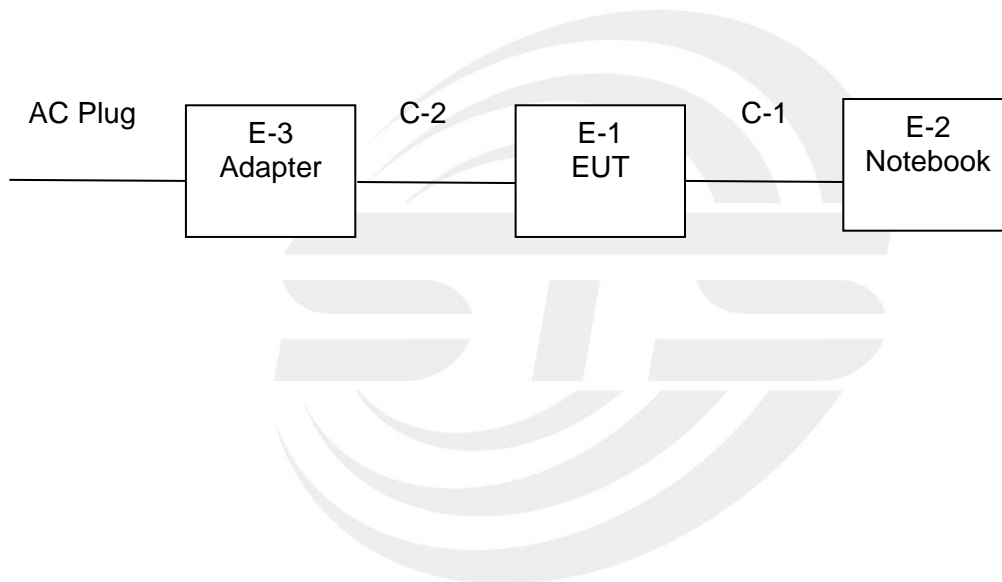



2.4 DESCRIPTION OF SUPPORT UNITS(CONDUCTED MODE)

The EUT has been tested as an independent unit together with other necessary accessories or support units. The following support units or accessories were used to form a representative test configuration during the tests.

Item	Equipment	Mfr/Brand	Model/Type No.	Serial No.	Note
E-3	Adapter	LITEON	PA-1650-86	N/A	N/A
C-2	DC Cable	N/A	N/A	N/A	N/A

Item	Shielded Type	Ferrite Core	Length	Note
E-2	Notebook	HP	500-320cx	N/A
C-1	USB Cable	N/A	100cm	N/A

Note:

- (1) The support equipment was authorized by SDOC.
- (2) For detachable type I/O cable should be specified the length in cm in 『Length』 column.
- (3) “YES” is means “shielded” “with core”; “NO” is means “unshielded” “without core”.



2.5 EQUIPMENTS LIST FOR ALL TEST ITEMS

Radiation Test equipment

Kind of Equipment	Manufacturer	Type No.	Serial No.	Last calibration	Calibrated until
Test Receiver	R&S	ESCI	101427	2018.10.13	2019.10.12
Signal Analyzer	Agilent	N9020A	MY51110105	2018.03.08	2019.03.07
Active loop Antenna	ZHINAN	ZN30900C	16035	2018.03.11	2021.03.10
Bilog Antenna	TESEQ	CBL6111D	34678	2017.11.02	2020.11.01
Horn Antenna	SCHWARZ BECK	BBHA 9120D(1201)	9120D-1343	2018.10.19	2021.10.18
SHF-EHF Horn Antenna (15G-40GHz)	A-INFO	LB-180400-KF	J211020657	2018.03.11	2019.03.10
Pre-mpplier(0.1M-3GHz)	EM	EM330	060665	2018.10.13	2019.10.12
PreAmplifier (1G-18GHz)	SKET	LNPA-01018G-4 5	SK2018080901	2018.10.13	2019.10.12
Temperature & Humidity	HH660	Mieo	N/A	2018.10.11	2019.10.10
turn table	EM	SC100_1	60531	N/A	N/A
Antenna mast	EM	SC100	N/A	N/A	N/A

Conduction Test equipment

Kind of Equipment	Manufacturer	Type No.	Serial No.	Last calibration	Calibrated until
Test Receiver	R&S	ESCI	101427	2018.10.13	2019.10.12
LISN	R&S	ENV216	101242	2018.10.11	2019.10.10
LISN	EMCO	3810/2NM	23625	2018.10.11	2019.10.10
Temperature & Humidity	HH660	Mieo	N/A	2018.10.11	2019.10.10

RF Connected Test

Kind of Equipment	Manufacturer	Type No.	Serial No.	Last calibration	Calibrated until
USB RF power sensor	DARE	RPR3006W	15I00041SNOO 3	2018.10.13	2019.10.12
Signal Analyzer	Agilent	N9020A	MY49100060	2018.10.13	2019.10.12
Temperature & Humidity	HH660	Mieo	N/A	2018.10.11	2019.10.10



3. EMC EMISSION TEST

3.1 CONDUCTED EMISSION MEASUREMENT

3.1.1 POWER LINE CONDUCTED EMISSION LIMITS

operating frequency band. In case the emission fall within the restricted band specified on Part 207(a) and RSS-Gen Issue 5 limit in the table below has to be followed.

FREQUENCY (MHz)	Conducted Emission limit (dBuV)	
	Quasi-peak	Average
0.15 -0.5	66 - 56 *	56 - 46 *
0.50 -5.0	56.00	46.00
5.0 -30.0	60.00	50.00

Note:

- (1) The tighter limit applies at the band edges.
- (2) The limit of " * " marked band means the limitation decreases linearly with the logarithm of the frequency in the range.

The following table is the setting of the receiver

Receiver Parameters	Setting
Attenuation	10 dB
Start Frequency	0.15 MHz
Stop Frequency	30 MHz
IF Bandwidth	9 kHz

3.2 TEST PROCEDURE

- a. The EUT was 0.8 meters from the horizontal ground plane and 0.4 meters from the vertical ground plane with EUT being connected to the power mains through a line impedance stabilization network (LISN). All other support equipments powered from additional LISN(s). The LISN provide 50 Ohm/ 50uH of coupling impedance for the measuring instrument.
- b. Interconnecting cables that hang closer than 40 cm to the ground plane shall be folded back and forth in the center forming a bundle 30 to 40 cm long.
- c. I/O cables that are not connected to a peripheral shall be bundled in the center. The end of the cable may be terminated, if required, using the correct terminating impedance. The overall length shall not exceed 1 m.
- d. LISN at least 80 cm from nearest part of EUT chassis.
- e. For the actual test configuration, please refer to the related Item –EUT Test Photos.

3.3 TEST SETUP

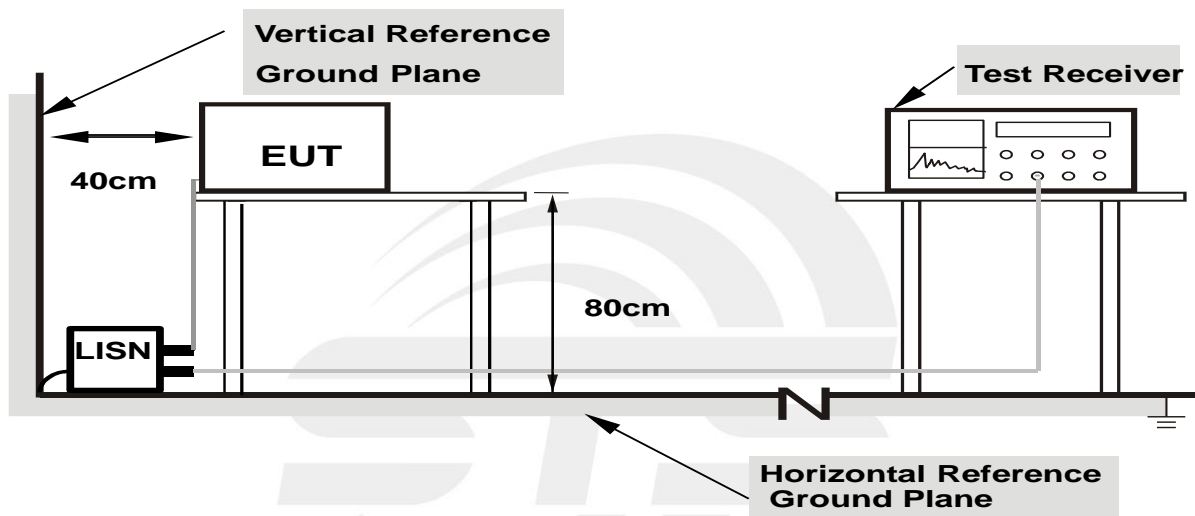

- Note: 1.Support units were connected to second LISN.**
2.Both of LISNs (AMN) are 80 cm from EUT and at least 80 from other units and other metal planes

3.4 EUT OPERATING CONDITIONS

The EUT was configured for testing in a typical fashion (as a customer would normally use it). The EUT has been programmed to continuously transmit during test. This operating condition was tested and used to collect the included data.



3.5 TEST RESULTS

Temperature:	23.4 °C	Relative Humidity:	56%
Test Voltage:	AC 120V/60Hz	Phase:	L
Test Mode:	Mode 4		

Frequency (MHz)	Reading (dBuV)	Correct Factor(dB)	Result (dBuV)	Limit (dBuV)	Margin (dB)	Remark
0.2184	24.81	20.32	45.13	62.88	-17.75	QP
0.2184	6.76	20.32	27.08	52.88	-25.80	AVG
0.4500	23.29	20.49	43.78	56.88	-13.10	QP
0.4500	12.34	20.49	32.83	46.88	-14.05	AVG
1.2980	21.31	20.13	41.44	56.00	-14.56	QP
1.2980	8.96	20.13	29.09	46.00	-16.91	AVG
3.6340	20.68	19.96	40.64	56.00	-15.36	QP
3.6340	8.53	19.96	28.49	46.00	-17.51	AVG
5.2740	20.52	19.93	40.45	60.00	-19.55	QP
5.2740	7.33	19.93	27.26	50.00	-22.74	AVG
11.2380	14.62	20.10	34.72	60.00	-25.28	QP
11.2380	2.77	20.10	22.87	50.00	-27.13	AVG

Remark:

1. All readings are Quasi-Peak and Average values.
2. Margin = Result (Result =Reading + Factor)–Limit

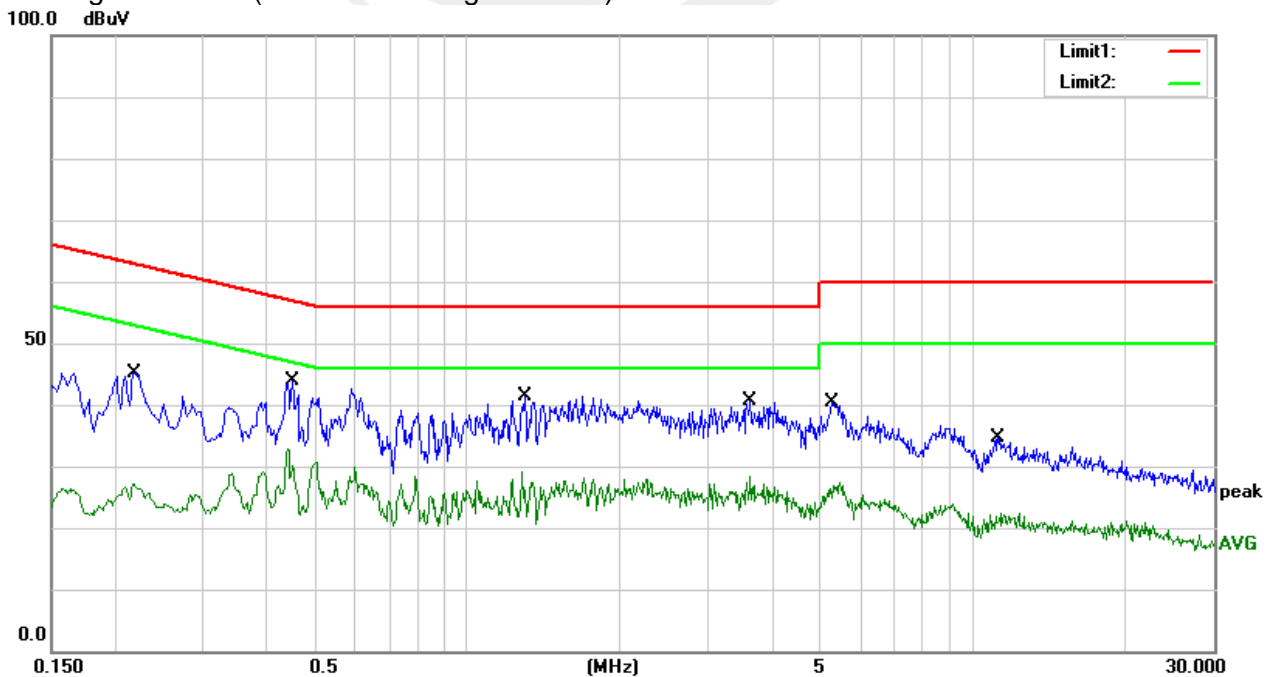



Temperature:	23.4°C	Relative Humidity:	56%
Test Voltage:	AC 120V/60Hz	Phase:	N
Test Mode:	Mode 4		

Frequency (MHz)	Reading (dBuV)	Correct Factor(dB)	Result (dBuV)	Limit (dBuV)	Margin (dB)	Remark
0.4420	26.29	20.49	46.78	57.02	-10.24	QP
0.4420	13.48	20.49	33.97	47.02	-13.05	AVG
0.5900	26.68	20.37	47.05	56.00	-8.95	QP
0.5900	13.48	20.37	33.85	46.00	-12.15	AVG
1.7660	25.09	20.08	45.17	56.00	-10.83	QP
1.7660	9.44	20.08	29.52	46.00	-16.48	AVG
3.6340	25.61	19.96	45.57	56.00	-10.43	QP
3.6340	13.00	19.96	32.96	46.00	-13.04	AVG
9.1340	22.10	20.07	42.17	60.00	-17.83	QP
9.1340	6.14	20.07	26.21	50.00	-23.79	AVG
22.2620	16.70	19.69	36.39	60.00	-23.61	QP
22.2620	4.37	19.69	24.06	50.00	-25.94	AVG

Remark:

1. All readings are Quasi-Peak and Average values.
2. Margin = Result (Result = Reading + Factor) – Limit

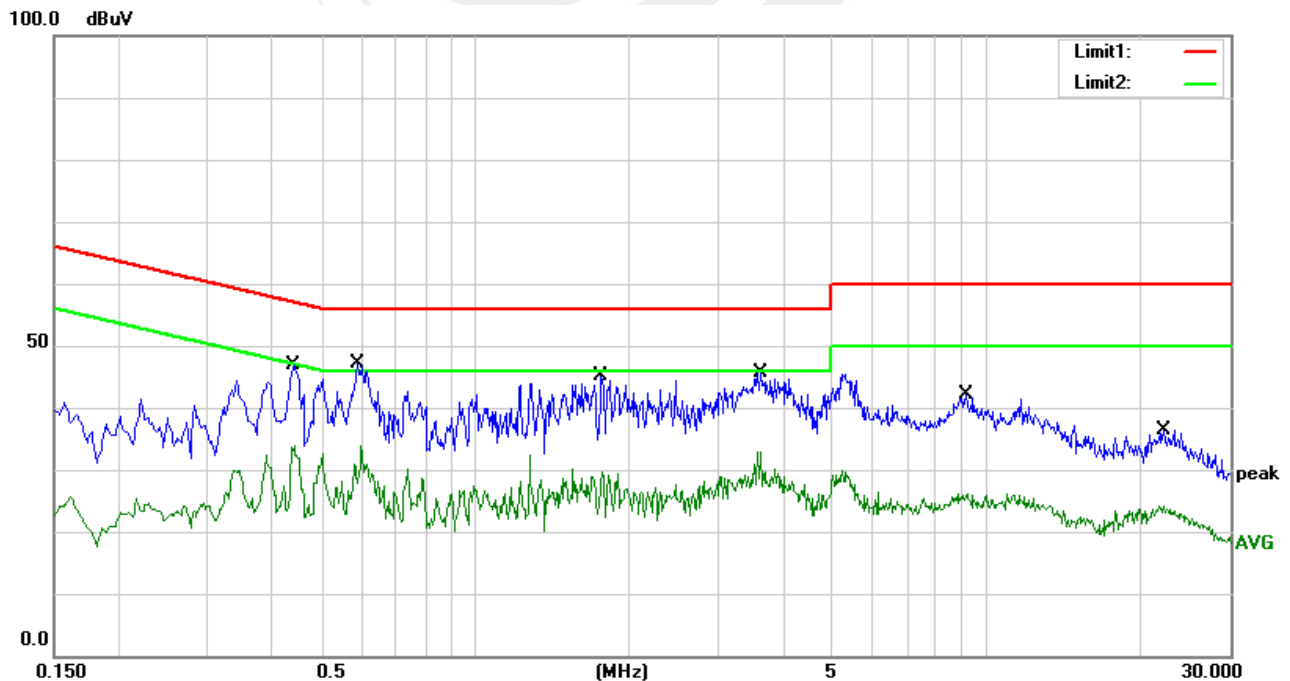



4. RADIATED EMISSION MEASUREMENT

4.1 RADIATED EMISSION LIMITS

in any 100 kHz bandwidth outside the operating frequency band. In case the emission fall within the Restricted band specified on Part15.205(a)&209(a) and RSS-247 Issue 2 limit in the table and according to ANSI C63.10-2013 below has to be followed.

LIMITS OF RADIATED EMISSION MEASUREMENT (Frequency Range 9kHz-1000MHz)

Frequencies (MHz)	Field Strength (micorvolts/meter)	Measurement Distance (meters)
0.009~0.490	2400/F(KHz)	300
0.490~1.705	24000/F(KHz)	30
1.705~30.0	30	30
30~88	100	3
88~216	150	3
216~960	200	3
Above 960	500	3

LIMITS OF RADIATED EMISSION MEASUREMENT (Above 1000MHz)

FREQUENCY (MHz)	(dBuV/m) (at 3M)	
	PEAK	AVERAGE
Above 1000	74	54

Notes:

- (1) The limit for radiated test was performed according to FCC PART 15C.
- (2) The tighter limit applies at the band edges.
- (3) Emission level (dBuV/m)=20log Emission level (uV/m).

For Radiated Emission

Spectrum Parameter	Setting
Attenuation	Auto
Detector	Peak
Start Frequency	1000 MHz(Peak/AV)
Stop Frequency	10th carrier hamonic(Peak/AV)
RB / VB (emission in restricted band)	1 MHz / 3 MHz

For Band edge

Spectrum Parameter	Setting
Detector	Peak
Start/Stop Frequency	Lower Band Edge: 2300 to 2403 MHz Upper Band Edge: 2479 to 2500 MHz
RB / VB (emission in restricted band)	1 MHz / 3 MHz



Receiver Parameter	Setting
Start ~ Stop Frequency	9kHz~90kHz / RB 200Hz for PK & AV
Start ~ Stop Frequency	90kHz~110kHz / RB 200Hz for QP
Start ~ Stop Frequency	110kHz~490kHz / RB 200Hz/9kHz for PK & AV
Start ~ Stop Frequency	490kHz~30MHz / RB 9kHz for QP
Start ~ Stop Frequency	30MHz~1000MHz / RB 120kHz for QP

4.2 TEST PROCEDURE

- a. The measuring distance of at 3 m shall be used for measurements at frequency 0.009MHz up to 1GHz, and above 1GHz.
- b. The EUT was placed on the top of a rotating table 0.8 meters(above 1GHz is 1.5 m) above the ground at a 3 meter anechoic chamber. The table was rotated 360 degrees to determine the position of the highest radiation.
- c. The height of the equipment shall be 0.8 m(above 1GHz is 1.5 m); the height of the test antenna shall vary between 1 m to 4 m. Horizontal and vertical polarizations of the antenna are set to make the measurement
- d. The initial step in collecting conducted emission data is a spectrum analyzer peak detector mode pre-scanning the measurement frequency range. Significant peaks are then marked and then Quasi Peak detector mode re-measured.
- e. If the Peak Mode measured value compliance with and lower than Quasi Peak Mode Limit, the EUT shall be deemed to meet QP Limits and then no additional QP Mode measurement performed.
- f. For the actual test configuration, please refer to the related Item –EUT Test Photos.

Note:

Both horizontal and vertical antenna polarities were tested and performed pretest to three orthogonal axis. The worst case emissions were reported.

4.3 TEST SETUP

(A) Radiated Emission Test-Up Frequency Below 30MHz

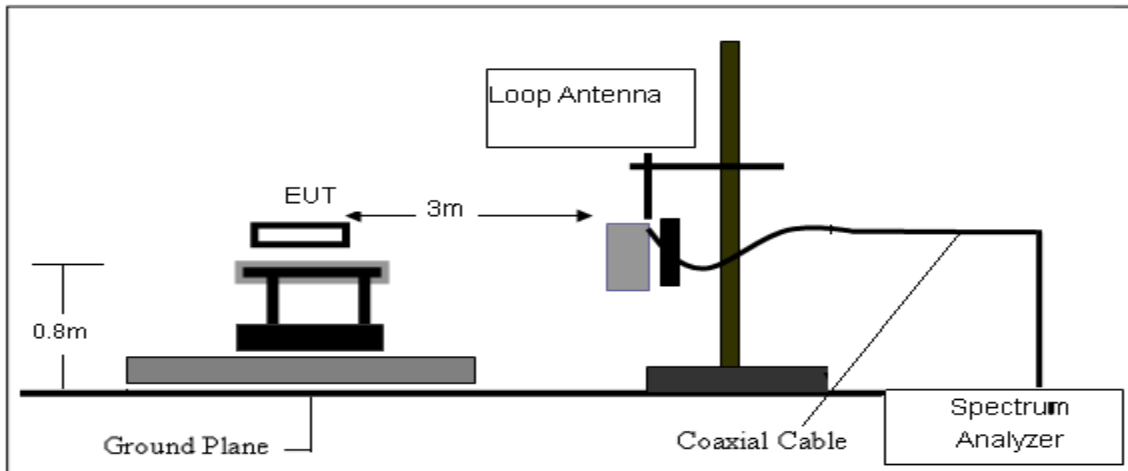

(B) Radiated Emission Test-Up Frequency 30MHz~1GHz

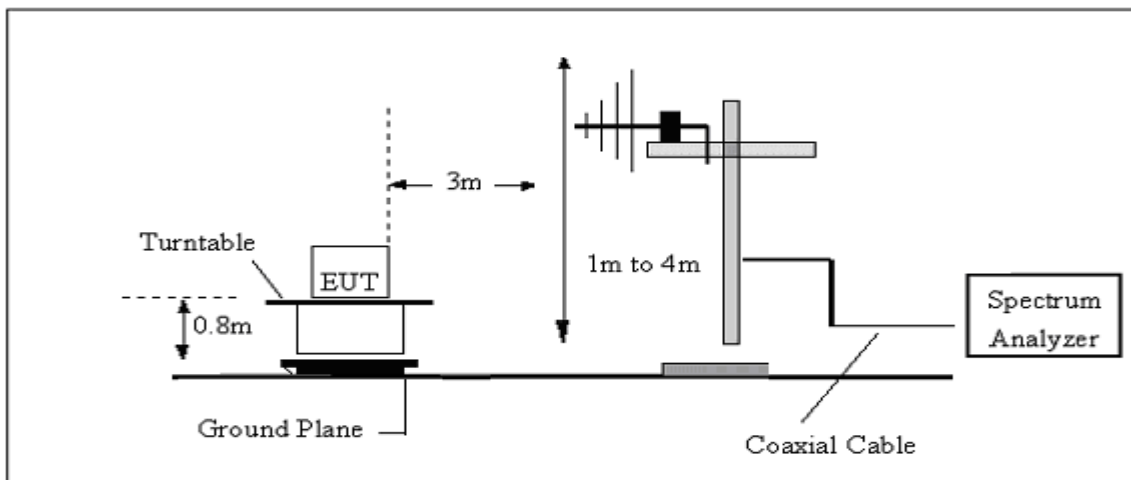

(C) Radiated Emission Test-Up Frequency Above 1GHz

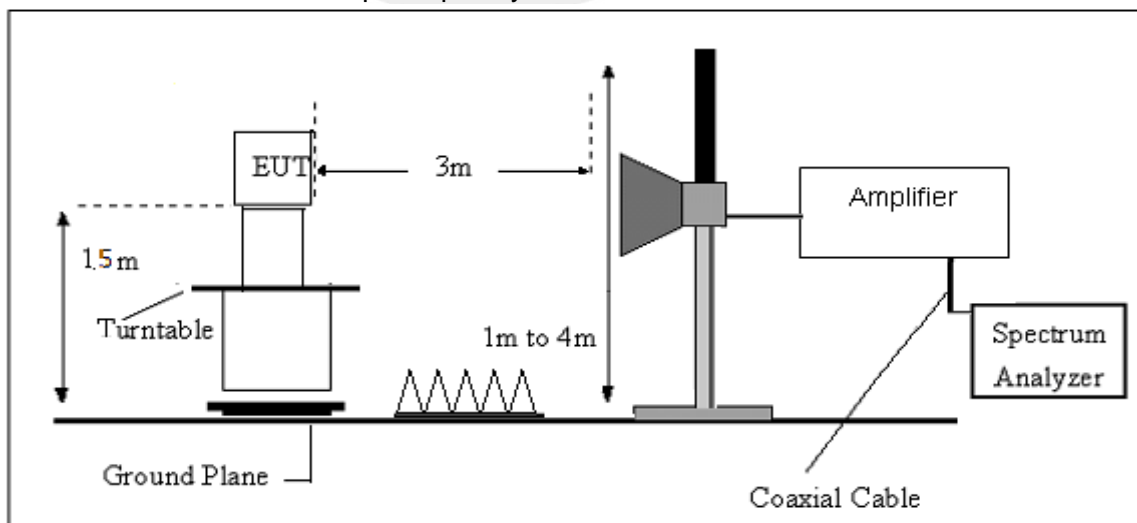

4.4 EUT OPERATING CONDITIONS

The EUT tested system was configured as the statements of 2.3 Unless otherwise a special operating condition is specified in the follows during the testing.



4.5 FIELD STRENGTH CALCULATION

The field strength is calculated by adding the Antenna Factor and Cable Factor and subtracting the Amplifier Gain and Duty Cycle Correction Factor (if any) from the measured reading. The basic equation with a sample calculation is as follows:

$$FS = RA + AF + CL - AG$$

Where

FS = Field Strength

CL = Cable Attenuation Factor (Cable Loss)

RA = Reading Amplitude

AG = Amplifier Gain

AF = Antenna Factor

For example

Frequency (MHz)	FS (dB μ V/m)	RA (dB μ V/m)	AF (dB)	CL (dB)	AG (dB)	Factor (dB)
300	40	58.1	12.2	1.6	31.9	-18.1

$$\text{Factor} = \text{AF} + \text{CL} - \text{AG}$$





4.6 TEST RESULTS

(Between 9KHz – 30 MHz)

Temperature:	24.6 °C	Relative Humidity:	55%
Test Voltage:	AC 120V/60Hz	Polarization:	--
Test Mode:	TX Mode		

Freq. (MHz)	Reading (dBuV/m)	Limit (dBuV/m)	Margin (dB)	State P/F
--	--	--	--	PASS
--	--	--	--	PASS

Note:

The amplitude of spurious emissions which are attenuated by more than 20dB below the permissible value has no need to be reported.

Distance extrapolation factor = $40 \log(\text{specific distance}/\text{test distance})$ (dB);

Limit line = specific limits(dBuv) + distance extrapolation factor.

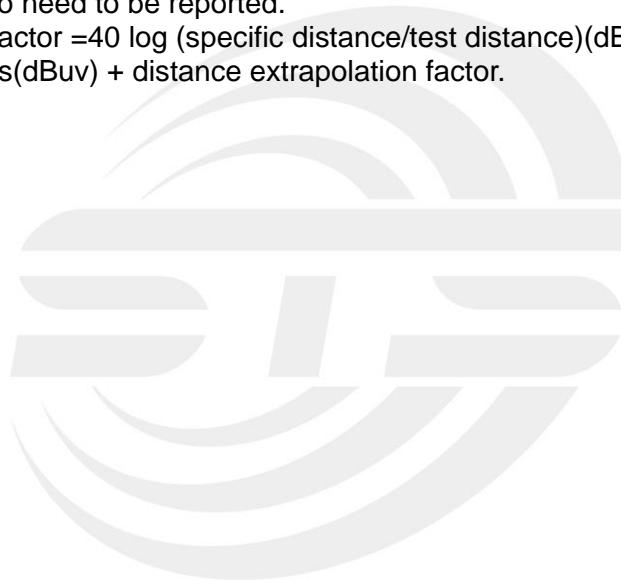



(30MHz -1000MHz)

Temperature:	24.6 °C	Relative Humidity:	55%
Test Voltage:	AC 120V/60HZ	Phase:	Horizontal
Test Mode:	Mode1/2/3(Mode 1-1M worst mode)		

Frequency (MHz)	Reading (dBuV)	Correct Factor(dB/m)	Result (dBuV/m)	Limit (dBuV/m)	Margin (dB)	Remark
73.1025	48.35	-23.66	24.69	40.00	-15.31	QP
108.6470	50.02	-18.46	31.56	43.50	-11.94	QP
176.2684	56.03	-19.41	36.62	43.50	-6.88	QP
390.7225	51.44	-11.87	39.57	46.00	-6.43	QP
531.9633	45.24	-7.75	37.49	46.00	-8.51	QP
824.5968	43.41	-3.34	40.07	46.00	-5.93	QP

Remark:

1. Margin = Result (Result =Reading + Factor)–Limit

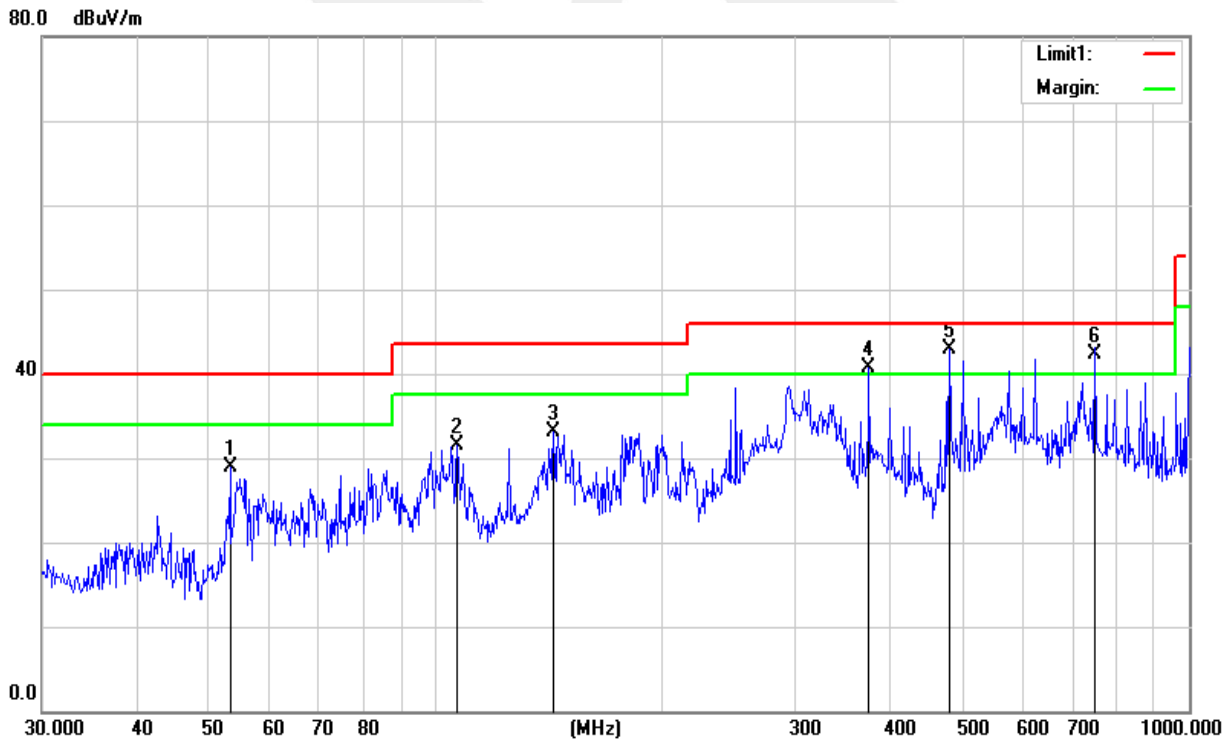



Temperature:	24.6°C	Relative Humidity:	55%
Test Voltage:	AC 120V/60Hz	Phase:	Vertical
Test Mode:	Mode1/2/3(Mode 1-1M worst mode)		

Frequency (MHz)	Reading (dBuV)	Correct Factor(dB/m)	Result (dBuV/m)	Limit (dBuV/m)	Margin (dB)	Remark
42.4508	33.52	-17.59	15.93	40.00	-24.07	QP
108.6470	41.17	-18.46	22.71	43.50	-20.79	QP
185.7880	47.95	-19.91	28.04	43.50	-15.46	QP
346.8091	54.54	-13.72	40.82	46.00	-5.18	QP
584.7894	40.45	-6.82	33.63	46.00	-12.37	QP
912.8620	40.98	-1.82	39.16	46.00	-6.84	QP

Remark:

1. Margin = Result (Result =Reading + Factor)–Limit

80.0 dBuV/m

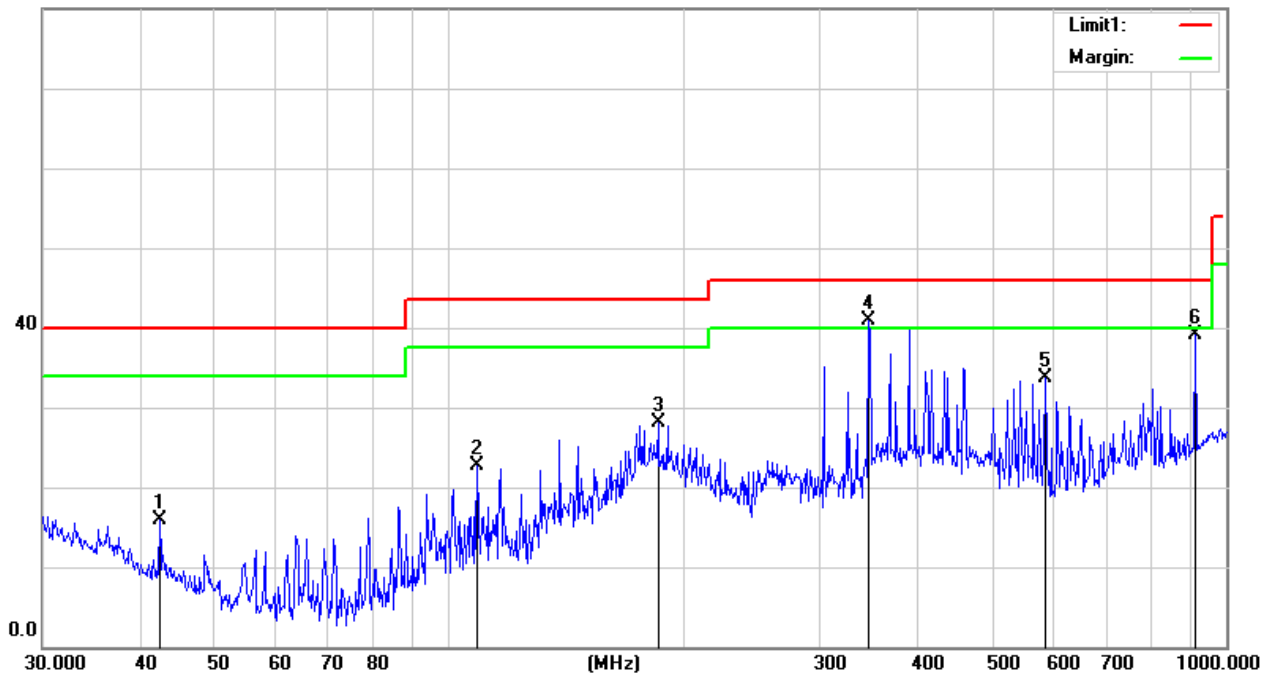



(1GHz-25GHz)Restricted band and Spurious emission Requirements

Low Channel

Frequency (MHz)	Reading (dBμV)	Amplifier (dB)	Loss (dB)	Antenna Factor (dB/m)	Corrected Factor (dB)	Emission Level (dBμV/m)	Limits (dBμV/m)	Margin (dB)	Detector Type	Comment
Low Channel (2402 MHz)										
3264.74	61.06	44.70	6.70	28.20	-9.80	51.26	74.00	-22.74	PK	Vertical
3264.74	51.63	44.70	6.70	28.20	-9.80	41.83	54.00	-12.17	AV	Vertical
3264.69	60.85	44.70	6.70	28.20	-9.80	51.05	74.00	-22.95	PK	Horizontal
3264.69	50.43	44.70	6.70	28.20	-9.80	40.63	54.00	-13.37	AV	Horizontal
4804.40	58.79	44.20	9.04	31.60	-3.56	55.23	74.00	-18.77	PK	Vertical
4804.40	50.15	44.20	9.04	31.60	-3.56	46.59	54.00	-7.41	AV	Vertical
4804.32	59.46	44.20	9.04	31.60	-3.56	55.90	74.00	-18.10	PK	Horizontal
4804.32	49.65	44.20	9.04	31.60	-3.56	46.09	54.00	-7.91	AV	Horizontal
5359.87	49.25	44.20	9.86	32.00	-2.34	46.91	74.00	-27.09	PK	Vertical
5359.87	39.73	44.20	9.86	32.00	-2.34	37.39	54.00	-16.61	AV	Vertical
5359.85	47.45	44.20	9.86	32.00	-2.34	45.11	74.00	-28.89	PK	Horizontal
5359.85	38.18	44.20	9.86	32.00	-2.34	35.84	54.00	-18.16	AV	Horizontal
7205.72	53.74	43.50	11.40	35.50	3.40	57.14	74.00	-16.86	PK	Vertical
7205.72	43.94	43.50	11.40	35.50	3.40	47.34	54.00	-6.66	AV	Vertical
7205.91	54.33	43.50	11.40	35.50	3.40	57.73	74.00	-16.27	PK	Horizontal
7205.91	44.53	43.50	11.40	35.50	3.40	47.93	54.00	-6.07	AV	Horizontal



Mid Channel

Frequency (MHz)	Reading (dBμV)	Amplifier (dB)	Loss (dB)	Antenna Factor (dB/m)	Corrected Factor (dB)	Emission Level (dBμV/m)	Limits (dBμV/m)	Margin (dB)	Detector Type	Comment
Mid Channel (2440 MHz)										
3264.76	62.12	44.70	6.70	28.20	-9.80	52.32	74.00	-21.68	PK	Vertical
3264.76	50.79	44.70	6.70	28.20	-9.80	40.99	54.00	-13.01	AV	Vertical
3264.58	61.44	44.70	6.70	28.20	-9.80	51.64	74.00	-22.36	PK	Horizontal
3264.58	51.03	44.70	6.70	28.20	-9.80	41.23	54.00	-12.77	AV	Horizontal
4880.36	58.20	44.20	9.04	31.60	-3.56	54.64	74.00	-19.36	PK	Vertical
4880.36	50.04	44.20	9.04	31.60	-3.56	46.48	54.00	-7.52	AV	Vertical
4880.38	59.55	44.20	9.04	31.60	-3.56	55.99	74.00	-18.01	PK	Horizontal
4880.38	49.23	44.20	9.04	31.60	-3.56	45.67	54.00	-8.33	AV	Horizontal
5359.67	49.20	44.20	9.86	32.00	-2.34	46.86	74.00	-27.14	PK	Vertical
5359.67	39.69	44.20	9.86	32.00	-2.34	37.35	54.00	-16.65	AV	Vertical
5359.63	48.23	44.20	9.86	32.00	-2.34	45.89	74.00	-28.11	PK	Horizontal
5359.63	38.41	44.20	9.86	32.00	-2.34	36.07	54.00	-17.93	AV	Horizontal
7310.77	54.30	43.50	11.40	35.50	3.40	57.70	74.00	-16.30	PK	Vertical
7310.77	44.54	43.50	11.40	35.50	3.40	47.94	54.00	-6.06	AV	Vertical
7310.84	54.83	43.50	11.40	35.50	3.40	58.23	74.00	-15.77	PK	Horizontal
7310.84	43.94	43.50	11.40	35.50	3.40	47.34	54.00	-6.66	AV	Horizontal



High Channel

Frequency (MHz)	Reading (dBμV)	Amplifier (dB)	Loss (dB)	Antenna	Corrected	Emission		Margin (dB)	Detector Type	Comment
				Factor (dB/m)	Factor (dB)	Level (dBμV/m)	Limits (dBμV/m)			
High Channel (2480 MHz)										
3264.62	61.58	44.70	6.70	28.20	-9.80	51.78	74.00	-22.22	PK	Vertical
3264.62	51.27	44.70	6.70	28.20	-9.80	41.47	54.00	-12.53	AV	Vertical
3264.72	61.20	44.70	6.70	28.20	-9.80	51.40	74.00	-22.60	PK	Horizontal
3264.72	50.05	44.70	6.70	28.20	-9.80	40.25	54.00	-13.75	AV	Horizontal
4960.55	58.84	44.20	9.04	31.60	-3.56	55.28	74.00	-18.72	PK	Vertical
4960.55	49.46	44.20	9.04	31.60	-3.56	45.90	54.00	-8.10	AV	Vertical
4960.37	59.52	44.20	9.04	31.60	-3.56	55.96	74.00	-18.04	PK	Horizontal
4960.37	49.44	44.20	9.04	31.60	-3.56	45.88	54.00	-8.12	AV	Horizontal
5359.76	49.33	44.20	9.86	32.00	-2.34	46.99	74.00	-27.01	PK	Vertical
5359.76	39.34	44.20	9.86	32.00	-2.34	37.00	54.00	-17.00	AV	Vertical
5359.85	48.52	44.20	9.86	32.00	-2.34	46.18	74.00	-27.82	PK	Horizontal
5359.85	38.41	44.20	9.86	32.00	-2.34	36.07	54.00	-17.93	AV	Horizontal
7439.78	53.65	43.50	11.40	35.50	3.40	57.05	74.00	-16.95	PK	Vertical
7439.78	44.47	43.50	11.40	35.50	3.40	47.87	54.00	-6.13	AV	Vertical
7439.92	53.85	43.50	11.40	35.50	3.40	57.25	74.00	-16.75	PK	Horizontal
7439.92	44.09	43.50	11.40	35.50	3.40	47.49	54.00	-6.51	AV	Horizontal

Note:

1) Factor = Antenna Factor + Cable Loss – Pre-amplifier.

Emission Level = Reading + Factor

2) The frequency emission of peak points that did not show above the forms are at least 20dB below the limit, the frequency emission is mainly from the environment noise.



4.6 TEST RESULTS (Restricted Bands Requirements)

GFSK-Low
Horizontal

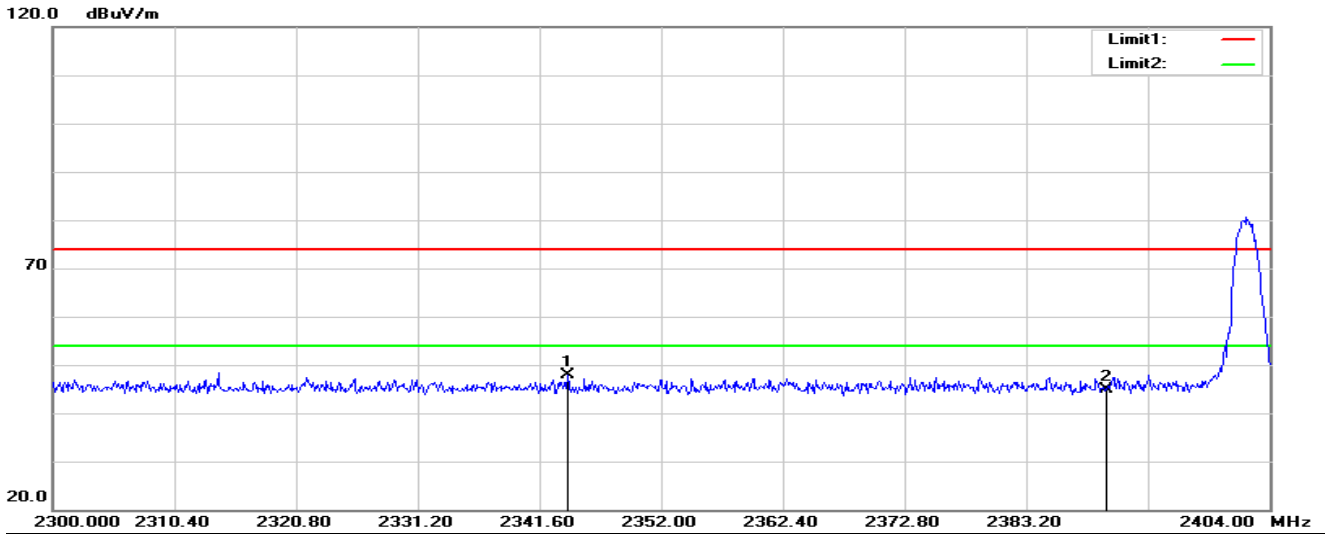

No.	Frequency (MHz)	Reading (dBuV)	Correct Factor(dB/m)	Result (dBuV/m)	Limit (dBuV/m)	Margin (dB)	Remark
1	2343.992	58.91	-11.05	47.86	74.00	-26.14	peak
2	2390.000	55.68	-10.75	44.93	74.00	-29.07	peak

Vertical

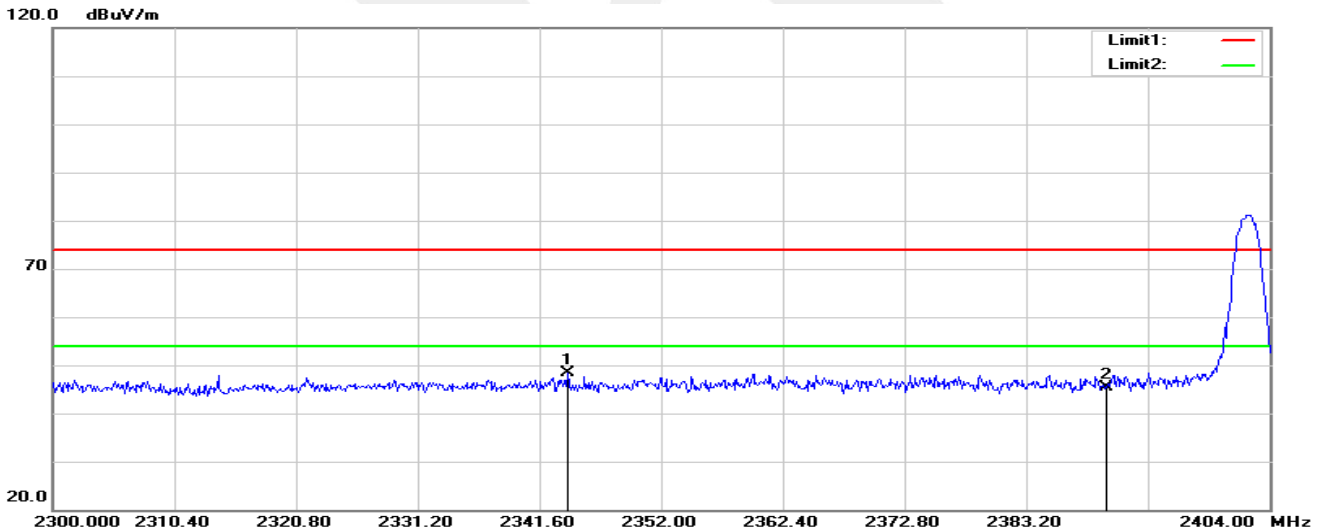

No.	Frequency (MHz)	Reading (dBuV)	Correct Factor(dB/m)	Result (dBuV/m)	Limit (dBuV/m)	Margin (dB)	Remark
1	2343.992	59.41	-11.05	48.36	74.00	-25.64	peak
2	2390.000	56.18	-10.75	45.43	74.00	-28.57	peak



GFSK-High
Horizontal

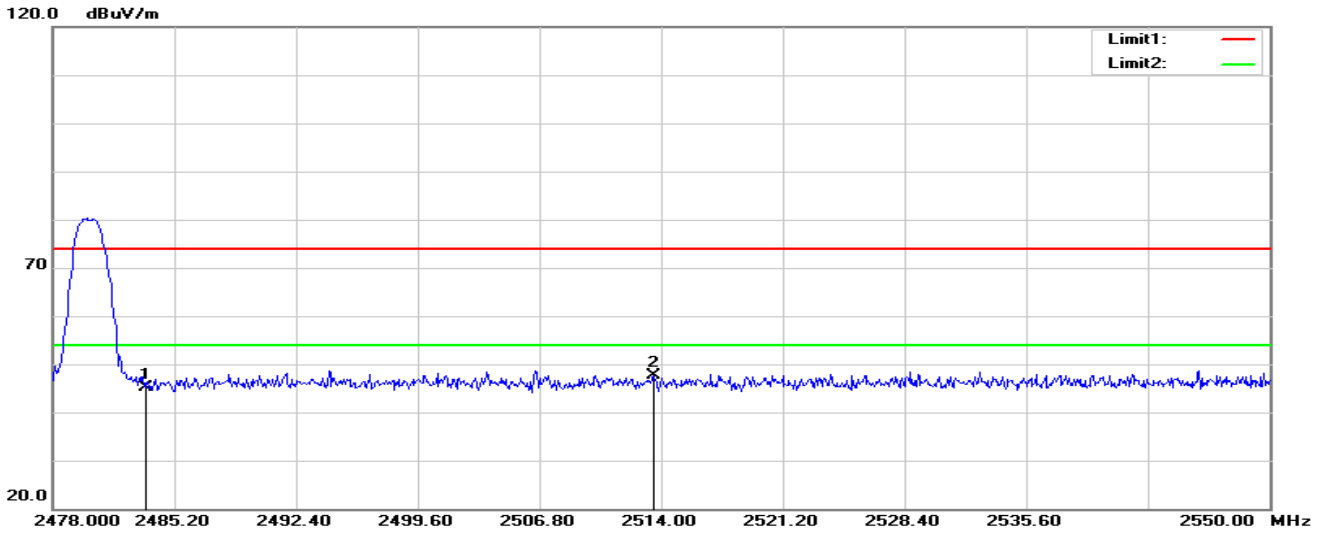

No.	Frequency (MHz)	Reading (dBuV)	Correct Factor(dB/m)	Result (dBuV/m)	Limit (dBuV/m)	Margin (dB)	Remark
1	2483.500	55.51	-10.29	45.22	74.00	-28.78	peak
2	2513.568	57.69	-10.17	47.52	74.00	-26.48	peak

Vertical

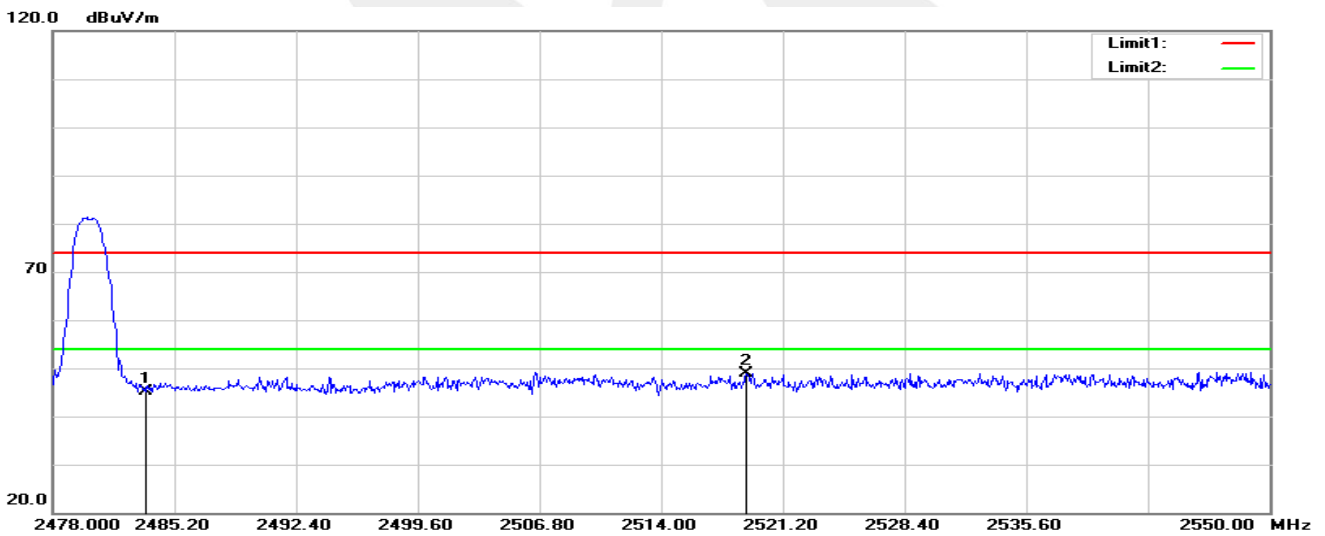

No.	Frequency (MHz)	Reading (dBuV)	Correct Factor(dB/m)	Result (dBuV/m)	Limit (dBuV/m)	Margin (dB)	Remark
1	2483.500	55.51	-10.29	45.22	74.00	-28.78	peak
2	2519.040	59.00	-10.16	48.84	74.00	-25.16	peak

5. CONDUCTED SPURIOUS & BAND EDGE EMISSION

5.1 REQUIREMENT

According to FCC section 15.247(d) and RSS-247 Issue 2, in any 100kHz bandwidth outside the frequency band in which the spread spectrum or digitally modulated intentional radiator is operating, the radio frequency power that is produced by the intentional radiator shall be at least 20dB below that in the 100kHz bandwidth within the band that contains the highest level of the desired power, based on either an RF conducted or a radiated measurement.

5.2 TEST PROCEDURE

Spectrum Parameter	Setting
Detector	Peak
Start/Stop Frequency	30 MHz to 10th carrier harmonic
RB / VB (emission in restricted band)	100 KHz/300 KHz
Trace-Mode:	Max hold

For Band edge

Spectrum Parameter	Setting
Detector	Peak
Start/Stop Frequency	Lower Band Edge: 2300 – 2403 MHz Upper Band Edge: 2479 – 2500 MHz
RB / VB (emission in restricted band)	100 KHz/300 KHz
Trace-Mode:	Max hold

5.3 TEST SETUP

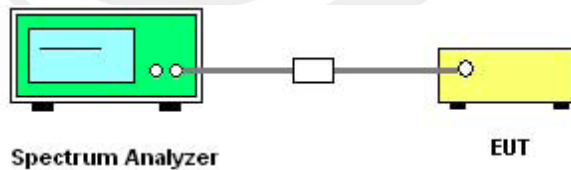

The EUT which is powered by the Battery, is coupled to the Spectrum Analyzer; the RF load attached to the EUT antenna terminal is 50 Ohm; the path loss as the factor is calibrated to correct the reading. Make the measurement with the spectrum analyzer's resolution bandwidth(RBW) = 100 kHz. In order to make an accurate measurement, set the span greater than RBW.

5.4 EUT OPERATION CONDITIONS

The EUT tested system was configured as the statements of 2.3 Unless otherwise a special operating condition is specified in the follows during the testing.



5.5 TEST RESULTS

Temperature:	25 °C	Relative Humidity:	50%
Test Voltage:	DC 7.4V	Test Mode:	TX Mode /CH37, CH17, CH39

CH 37

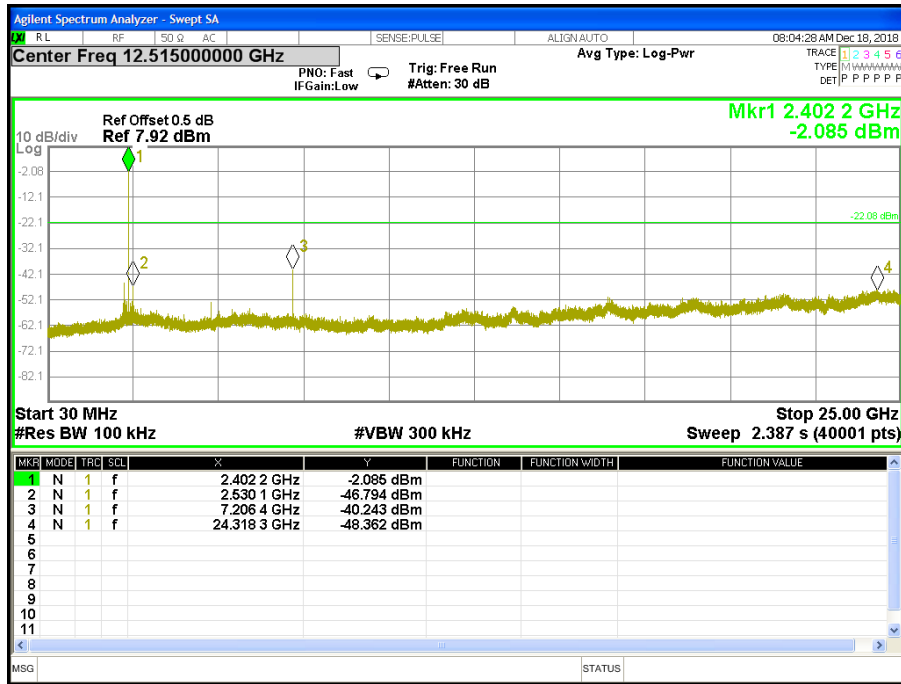



CH 17

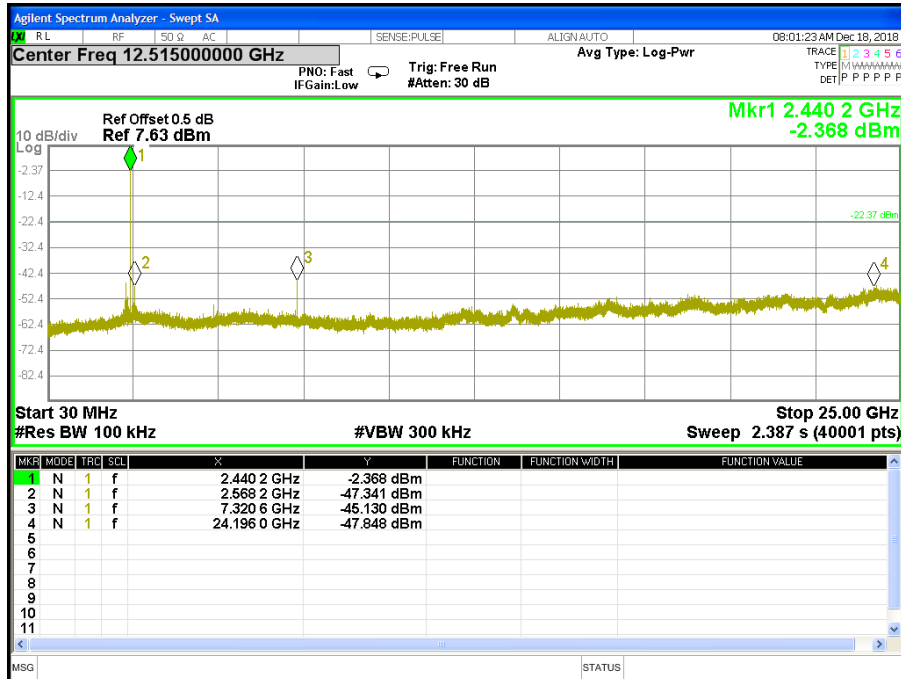

CH 39

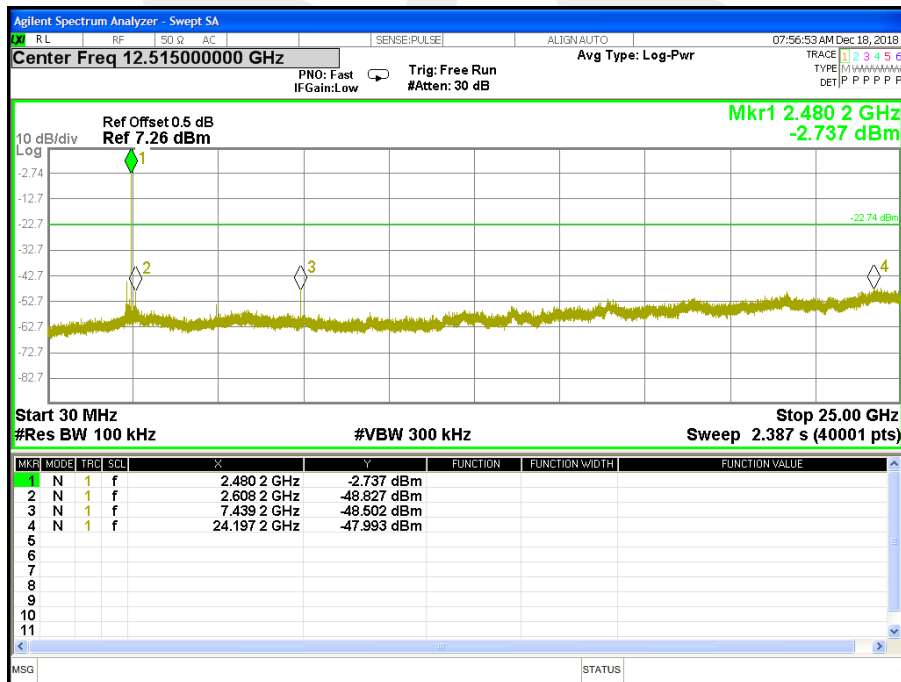



For Band edge

CH 37

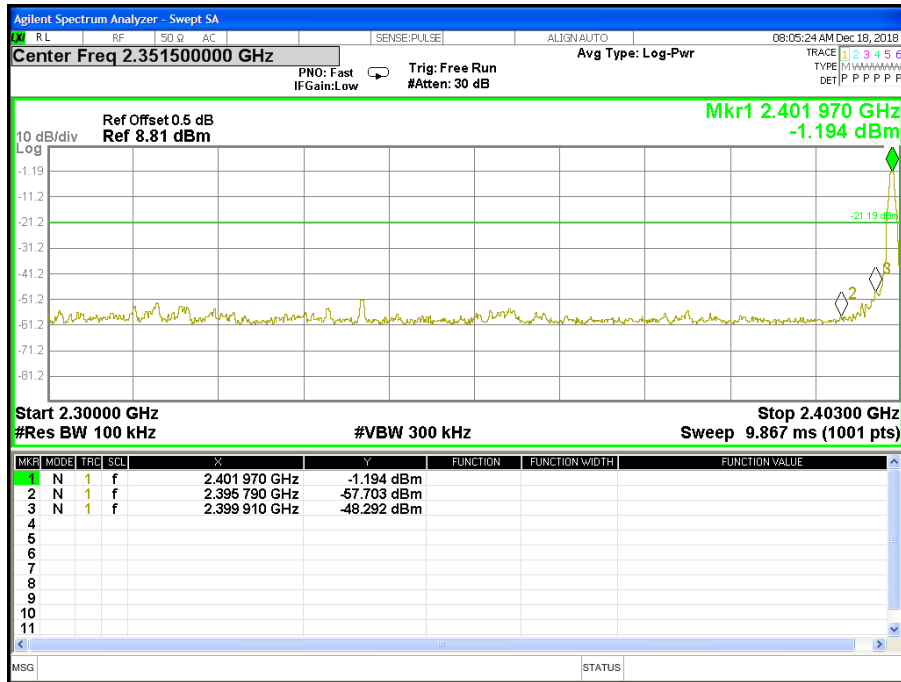

CH 39

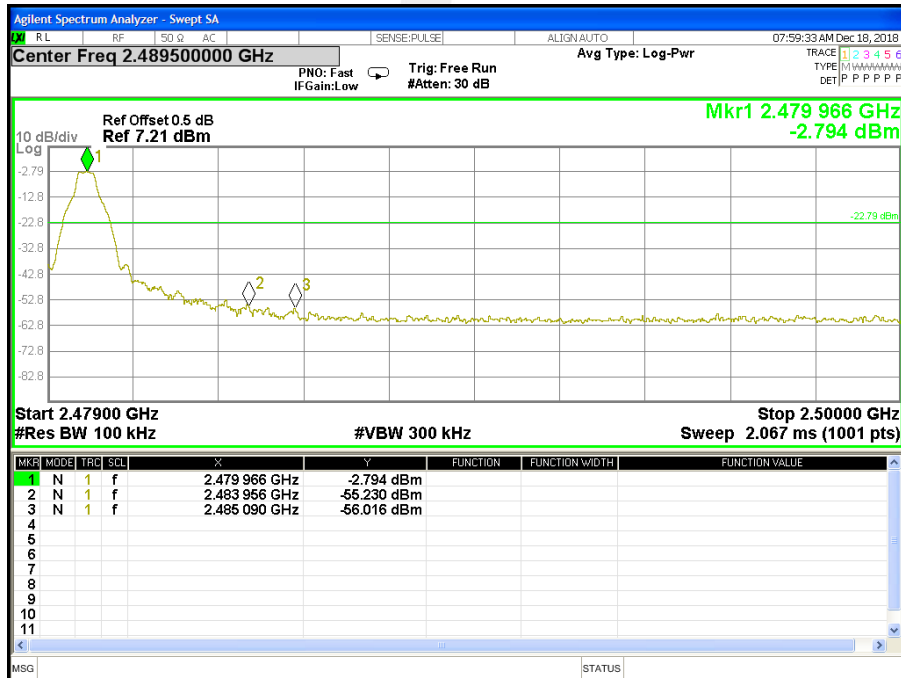



6. POWER SPECTRAL DENSITY TEST

6.1 APPLIED PROCEDURES / LIMIT

FCC Part 15.247, Subpart C RSS-247 Issue 2				
Section	Test Item	Limit	Frequency Range (MHz)	Result
15.247(e) RSS-247 Issue 2	Power Spectral Density	≤ 8 dBm (RBW ≥ 3 KHz)	2400-2483.5	PASS

6.2 TEST PROCEDURE

1. Set analyzer center frequency to DTS channel center frequency.
2. Set the span to 1.5 times the DTS channel bandwidth.
3. Set the RBW to: $100 \text{ kHz} \geq \text{RBW} \geq 3 \text{ kHz}$.
4. Set the VBW $\geq 3 \times \text{RBW}$.
5. Detector = peak.
6. Sweep time = auto couple.
7. Trace mode = max hold.
8. Allow trace to fully stabilize.
9. Use the peak marker function to determine the maximum amplitude level.
10. If measured value exceeds limit, reduce RBW (no less than 3 kHz) and repeat.

6.3 TEST SETUP

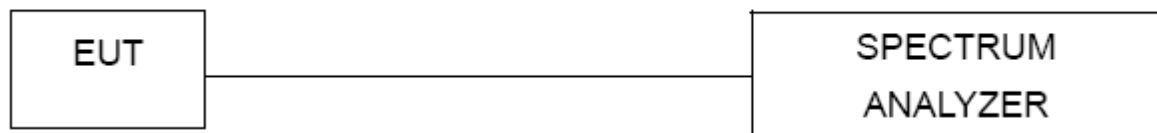

6.4 EUT OPERATION CONDITIONS

The EUT tested system was configured as the statements of 2.3 Unless otherwise a special operating condition is specified in the follows during the testing.



6.5 TEST RESULTS

Temperature:	25 °C	Relative Humidity:	60%
Test Voltage:	DC 7.4V	Test Mode:	TX Mode /CH37, CH17, CH39

Frequency	Power Density (dBm/3kHz)	Limit (dBm/3KHz)	Result
2402 MHz	-12.326	≤8	PASS
2440 MHz	-11.759	≤8	PASS
2480 MHz	-12.668	≤8	PASS

TX CH37

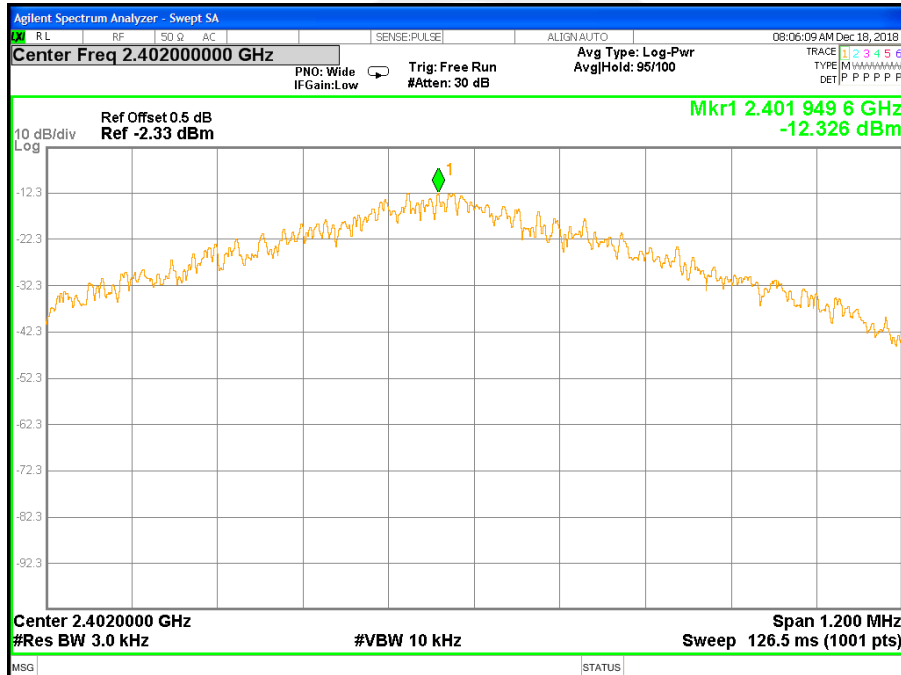



TX CH17

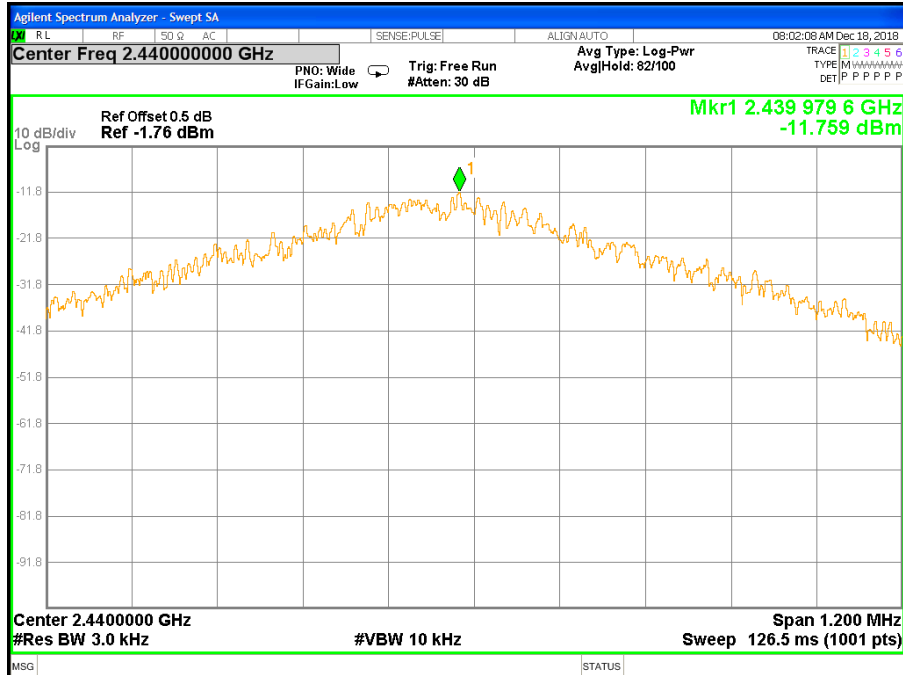

TX CH39

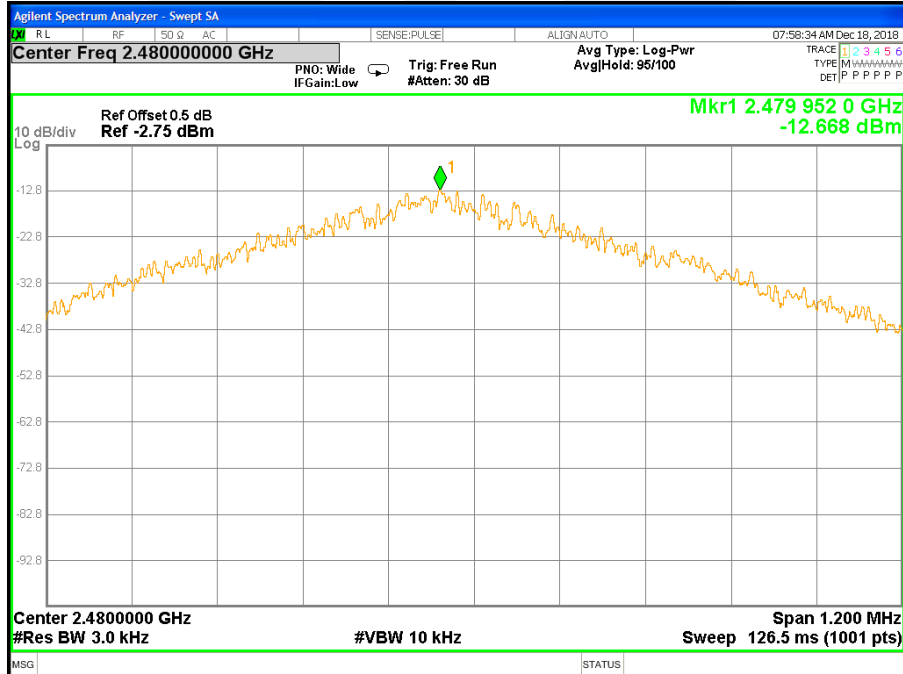

7. BANDWIDTH TEST

7.1 APPLIED PROCEDURES / LIMIT

FCC Part 15.247, Subpart C RSS-Gen Clause 6.7				
Section	Test Item	Limit	Frequency Range (MHz)	Result
15.247(a)(2)	6dB Bandwidth	$\geq 500\text{KHz}$	2400-2483.5	PASS
RSS-Gen Clause 6.7	99% Bandwidth	For reporting purposes only.	2400-2483.5	PASS

7.2 TEST PROCEDURE

Connect the UUT to the spectrum analyser and use the following settings:

Center Frequency	The centre frequency of the channel under test
Detector	Peak
RBW	For 6 dB Bandwidth : 100KHz For 99% Bandwidth : 1% to 5% of the occupied bandwidth
VBW	For 6dB Bandwidth : $\geq 3 \times \text{RBW}$ For 99% Bandwidth : approximately $3 \times \text{RBW}$
Trace	Max hold
Sweep	Auto

Allow the trace to stabilize and measure the maximum width of the emission that is constrained by the frequencies associated with the two outermost amplitude points (upper and lower frequencies) that are attenuated by 6 dB and 99% relative to the maximum level measured in the fundamental emission.

7.3 TEST SETUP

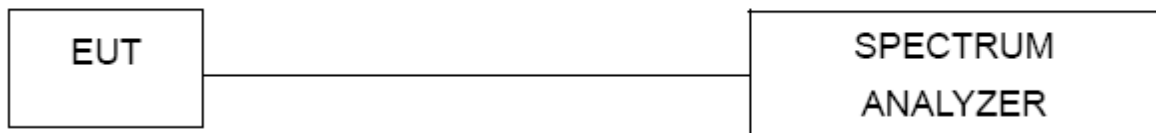

7.4 EUT OPERATION CONDITIONS

The EUT tested system was configured as the statements of 2.3 Unless otherwise a special operating condition is specified in the follows during the testing.



7.5 TEST RESULTS

Temperature:	25 °C	Relative Humidity:	60%
Test Voltage:	DC 7.4V	Test Mode:	TX Mode /CH37, CH17, CH39

Frequency	6dB Bandwidth (MHz)	99% Bandwidth (MHz)	Channel Separation (MHz)	Result
2402 MHz	0.520	0.910	>=500KHz	PASS
2440 MHz	0.516	0.920	>=500KHz	PASS
2480 MHz	0.519	0.915	>=500KHz	PASS

6dB Bandwidth TX CH 37

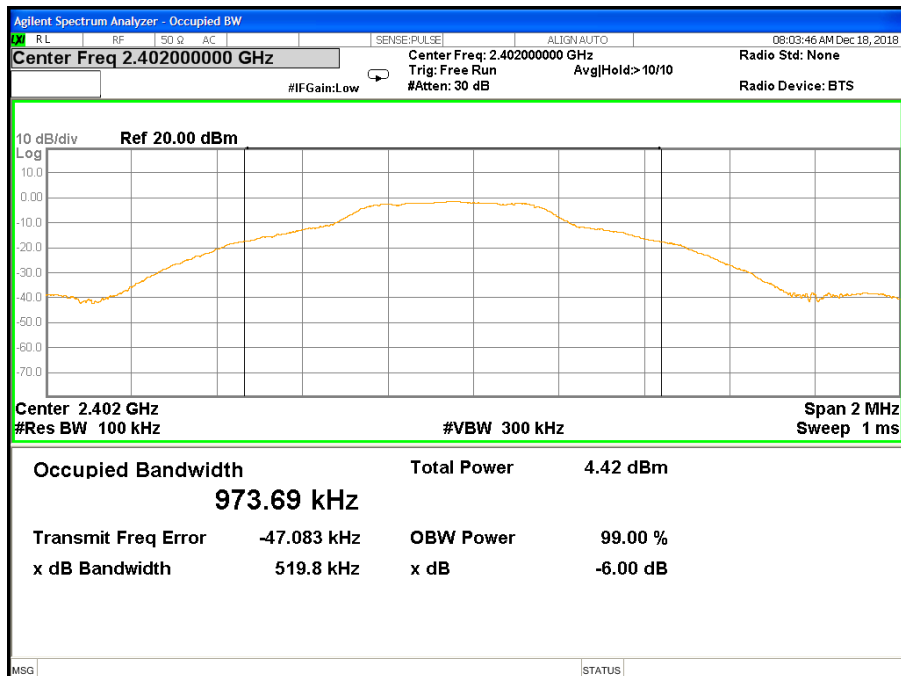



6dB Bandwidth TX CH 17

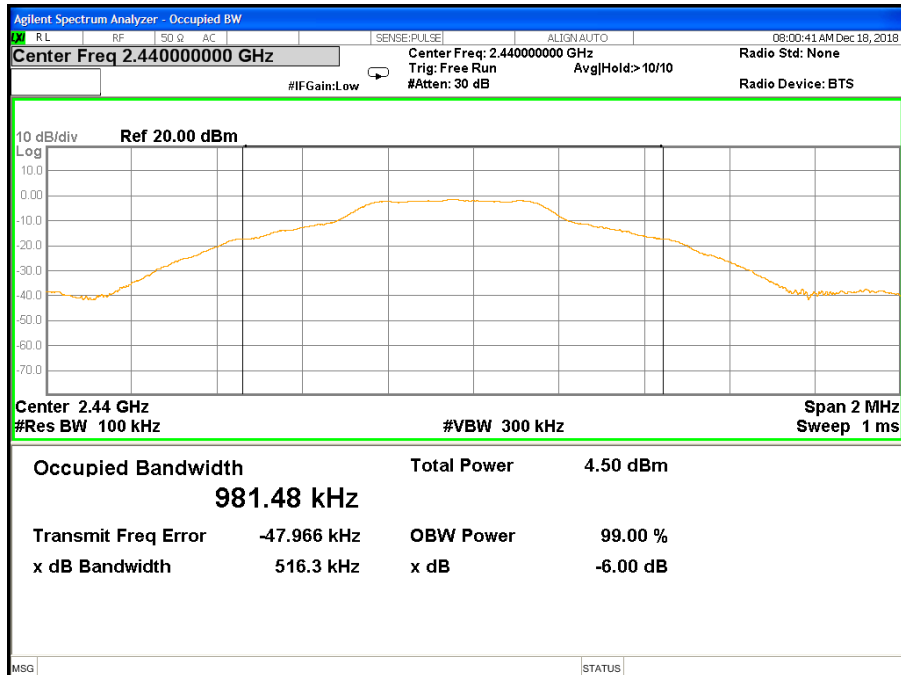

6dB Bandwidth TX CH 39

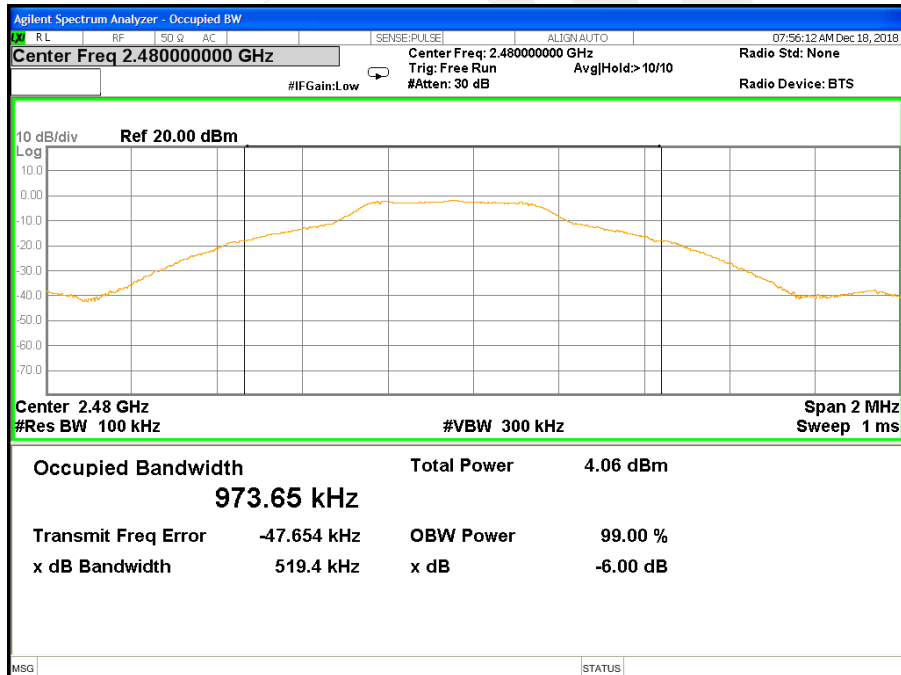



99% Bandwidth TX CH 37

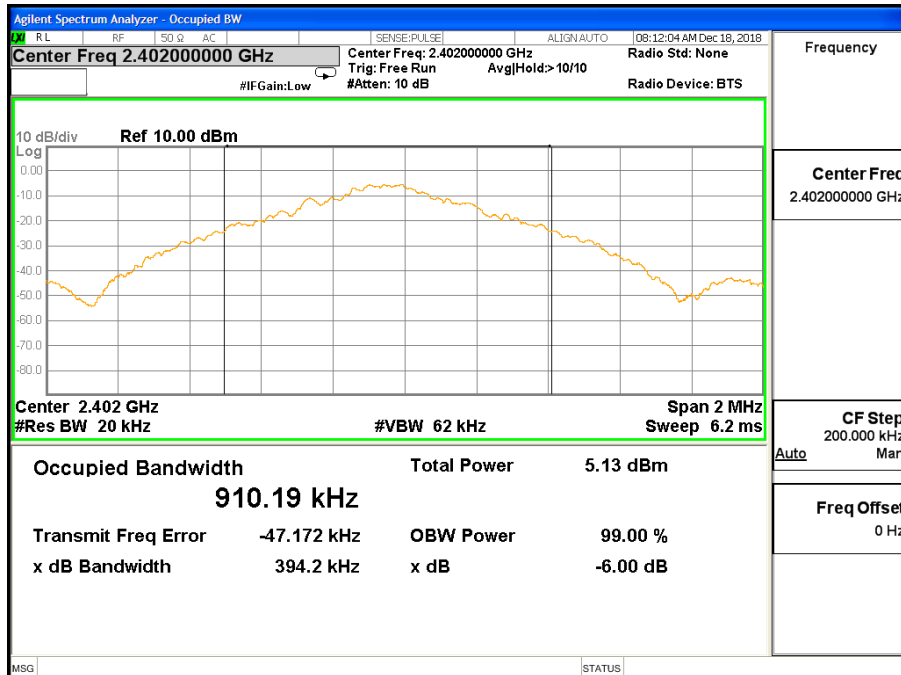

99% Bandwidth TX CH 17

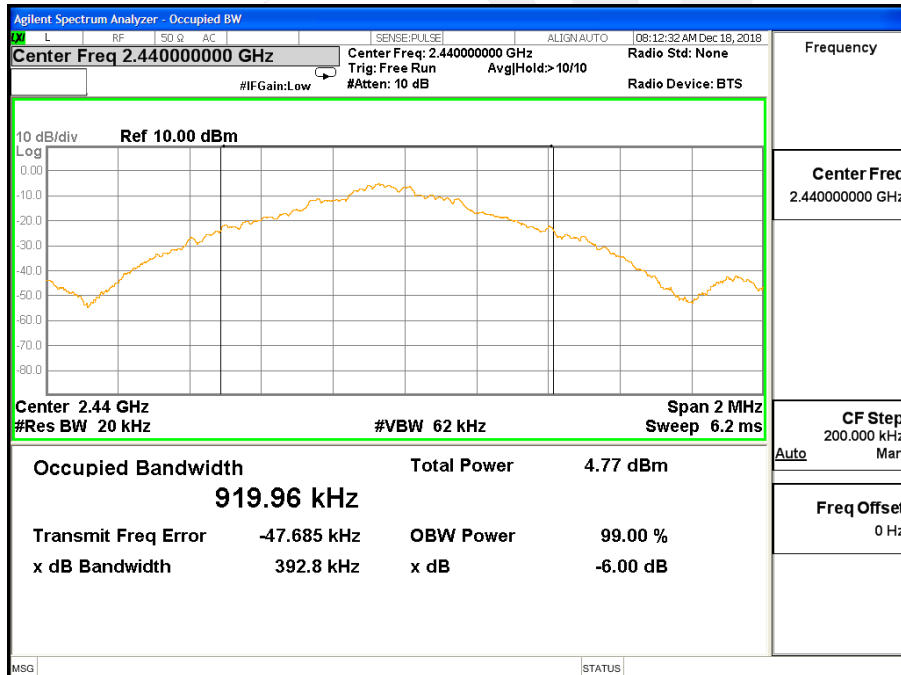



99% Bandwidth TX CH 39

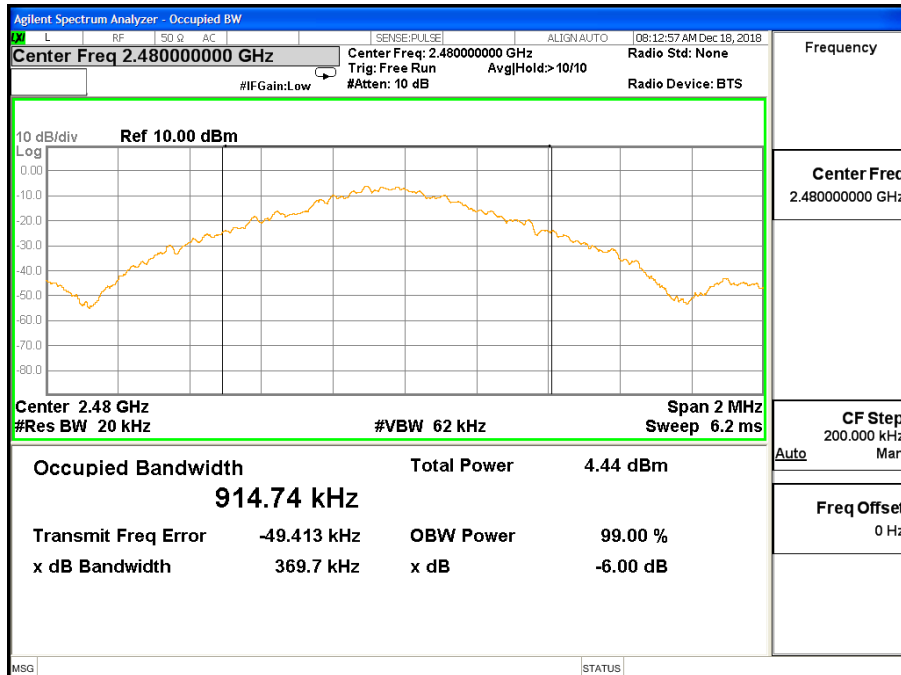



8. PEAK OUTPUT POWER TEST

8.1 APPLIED PROCEDURES / LIMIT

FCC Part 15.247, Subpart C RSS-247 Issue 2				
Section	Test Item	Limit	Frequency Range (MHz)	Result
15.247(b)(3) RSS 247 Issue 2	Output Power	1 watt or 30dBm	2400-2483.5	PASS

8.2 TEST PROCEDURE

- a. The EUT was directly connected to the Power Meter

8.3 TEST SETUP



8.4 EUT OPERATION CONDITIONS

The EUT tested system was configured as the statements of 2.3 Unless otherwise a special operating condition is specified in the follows during the testing.



8.5 TEST RESULTS

Temperature:	25 °C	Relative Humidity:	60%
Test Voltage:	DC 7.4V	Test Mode:	TX Mode /CH37, CH17, CH39

TX Mode				
Test Channel	Frequency	Conducted Output Power		LIMIT
	(MHz)	Peak (dBm)	AVG (dBm)	dBm
CH37	2402	-0.664	-2.815	30
CH17	2440	-0.720	-2.913	30
CH39	2480	-0.943	-3.011	30





9. ANTENNA REQUIREMENT

9.1 STANDARD REQUIREMENT

15.203 and RSS-GenIssue 5 requirement: For intentional device, according to 15.203 and RSS-GenIssue 5: an intentional radiator shall be designed to ensure that no antenna other than that furnished by the responsible party shall be used with the device.

9.2 EUT ANTENNA

The EUT antenna is Ceramic Antenna. It comply with the standard requirement.





10.FREQUENCY STABILITY

10.1 LIMITS OF FREQUENCY STABILITY MEASUREMENT

The frequency tolerance of the carrier signal shall be maintained within +/-0.02% of the operating frequency over a temperature variation of -30 degrees to 50 degrees C at normal supply voltage, and for a variation in primary supply voltage from 85% to 115% of the rated supply voltage at a temperature of 20 degrees.

10.2 TEST PROCEDURE

- 1.The EUT was placed inside the environmental test chamber and powered by nominal DC voltage.
- 2.Turn the EUT on and couple its output to spectrum analyzer.
- 3.Turn the EUT off and set the chamber to the highest temperature specified.
- 4.Allow sufficient time (approximately 30 min) for the temperature of the chamber to stabilize,turn the EUT on and measure the operating frequency after 2,5,and 10 minutes.
- 5.Repeat step 2 and 3 with the temperature chamber set to the lowest temperature.
- 6.The test chamber was allowed to stabilize at +20 degree C for a minimum of 30 minutes.The supply voltage was then adjusted on the EUT from 85% to 115% and the frequency record.

10.3 TEST RESULT

Channel 17 (2440MHz)

Voltage vs. Frequency Stability

Voltage vs. Frequency Stability Voltage(V)	Measurement Frequency(MHz)
8.51	2440.0023
7.4	2440.0016
6.29	2440.0015
Max.Deviation(MHz)	0.0023
Max.Deviation(ppm)	0.94

Rated working voltage:DC 7.4V

Temperature vs. Frequency Stability

Temperature(°C)	Measurement Frequency(MHz)
-30	2440.0033
-20	2440.0026
-10	2440.0030
0	2440.0029
10	2440.0025
20	2440.0026
30	2440.0025
40	2440.0031
50	2440.0033
Max.Deviation(MHz)	0.0033
Max.Deviation(ppm)	1.35



11. EUT TEST PHOTO

Note: See test photos in setup photo document for the actual connections between Product and support equipment.

*****END OF THE REPORT*****

