



FCC RADIO TEST REPORT

FCC ID:2ALLP-ECLIPSE1

Product : Tablet projector

Trade Mark : HEXA

Model Name : Eclipse 1

Serial Model : N/A

Report No. : NTEK-2016NT12220836F5

Prepared for

Hallmark Global LTD DBA HEXA

Unit 218, 1110 Finch ave West, Toronto, Ontario, Canada, M3J 2T2

Prepared by

NTEK Testing Technology Co., Ltd.

1/F, Building E, Fenda Science Park, Sanwei Community,
Xixiang Street Bao'an District, Shenzhen 518126 P.R. China

Tel.: +86-755-6115 6588

Fax.: +86-755-6115 6599

Website:<http://www.ntek.org.cn>

TEST RESULT CERTIFICATION

Applicant's name : Hallmark Global LTD DBA HEXA
Address : Unit 218, 1110 Finch ave West, Toronto, Ontario, Canada, M3J 2T2
Manufacturer's Name..... : Hallmark Global LTD DBA HEXA
Address : Unit 218, 1110 Finch ave West, Toronto, Ontario, Canada, M3J 2T2

Product description

Product name..... : Tablet projector
Model and/or type reference : Eclipse 1
Serial Model : N/A

Standards : FCC Part15.407: 01 Oct. 2015

Test procedure ANSI C63.10-2013 and KDB 789033 D02 General UNII Test Procedures New Rules v01r01
FCC KDB 662911 D01 Multiple Transmitter Output v02r01
FCC KDB 662911 D02 MIMO With Cross Polarized Antenna V01

This device described above has been tested by NTEK, and the test results show that the equipment under test (EUT) is in compliance with the FCC requirements/ the Industry Canada requirements.. And it is applicable only to the tested sample identified in the report.

This report shall not be reproduced except in full, without the written approval of NTEK, this document may be altered or revised by NTEK, personnel only, and shall be noted in the revision of the document.

Date of Test

Date (s) of performance of tests 22 Dec. 2016 ~ 16 Mar. 2017

Date of Issue..... 16 Mar. 2017

Test Result..... **Pass**

Testing Engineer : *Susan Su*
(Susan Su)

Technical Manager : *Jason Chen*
(Jason Chen)

Authorized Signatory : *Sam. Chen*
(Sam Chen)

Table of Contents

	Page
5.4 TEST RESULTS	53
6 . MINIMUM 6 DB BANDWIDTH	61
6.1 APPLIED PROCEDURES / LIMIT	61
6.2 TEST PROCEDURE	61
6.3 DEVIATION FROM STANDARD	61
6.4 TEST SETUP	61
6.5 EUT OPERATION CONDITIONS	61
6.6 TEST RESULTS	62
7 . MAXIMUM CONDUCTED OUTPUT POWER	70
7.1 PPLIED PROCEDURES / LIMIT	70
7.2 TEST PROCEDURE	70
7.3 DEVIATION FROM STANDARD	72
7.4 TEST SETUP	72
7.5 EUT OPERATION CONDITIONS	72
7.6 TEST RESULTS	73
8 . OUT OF BAND EMISSIONS	75
8.1 APPLICABLE STANDARD	75
8.2 TEST PROCEDURE	75
8.3 DEVIATION FROM STANDARD	75
8.4 TEST SETUP	75
8.5 EUT OPERATION CONDITIONS	75
8.6 TEST RESULTS	76
9.SPURIOUS RF CONDUCTED EMISSIONS	82
9.1CONFORMANCE LIMIT	82
9.2MEASURING INSTRUMENTS	82
9.3TEST SETUP	82
9.4TEST PROCEDURE	82
9.5TEST RESULTS	82
10. FREQUENCY STABILITY MEASUREMENT	97
10.1 LIMIT	97
10.2 TEST PROCEDURES	97
10.3 TEST SETUP LAYOUT	97
10.4 EUT OPERATION DURING TEST	97
10.5 TEST RESULTS	98
11. ANTENNA REQUIREMENT	104
11.1 STANDARD REQUIREMENT	104
11.2 EUT ANTENNA	104
APPENDIX-PHOTOGRAPHS OF EUT CONSTRUCTIONAL DETAILS	

1. SUMMARY OF TEST RESULTS

Test procedures according to the technical standards:

FCC Part15 (15.407) , Subpart E			
Standard Section	Test Item	Judgment	Remark
15.207	AC Power Line Conducted Emissions	PASS	
15.209(a), 15.407 (b)(1) 15.407 (b)(4) 15.407 (b)(6)	Spurious Radiated Emissions	PASS	
15.407 (a)(1) 15.407 (a)(3) 15.1049	26 dB and 99% Emission Bandwidth	PASS	
15.407(e)	Minimum 6 dB bandwidth	PASS	
15.407 (a)(1) 15.407 (a)(3)	Maximum Conducted Output Power	PASS	
2.1051, 15.407(b)(1) 15.407(b)(4)	Band Edges	PASS	
15.407 (a)(1) 15.407 (a)(3)	Power Spectral Density	PASS	
2.1051, 15.407(b)	Spurious Emissions at Antenna Terminals	PASS	
15.203	Antenna Requirement	PASS	

NOTE:

(1) "N/A" denotes test is not applicable in this Test Report

1.1 TEST FACILITY

NTEK Testing Technology Co., Ltd

Add.: 1/F, Building E, Fenda Science Park, Sanwei Community, Xixiang Street Bao'an District, Shenzhen 518126 P.R. China

FCC Registration No.:238937; IC Registration No.:9270A-1

CNAS Registration No.:L5516

1.2 MEASUREMENT UNCERTAINTY

The reported uncertainty of measurement $y \pm U$, where expanded uncertainty U is based on a standard uncertainty multiplied by a coverage factor of $k=2$, providing a level of confidence of approximately **95 %**.

No.	Item	Uncertainty
1	Conducted Emission Test	$\pm 1.38\text{dB}$
2	RF power,conducted	$\pm 0.16\text{dB}$
3	Spurious emissions,conducted	$\pm 0.21\text{dB}$
4	All emissions,radiated(<1G)	$\pm 4.68\text{dB}$
5	All emissions,radiated(>1G)	$\pm 4.89\text{dB}$
6	Temperature	$\pm 0.5\text{C}$
7	Humidity	$\pm 2\%$

The EUT has two types of antenna.

Tx Antenna

Antenna	Antenna Type	Antenna Gain(dBi)	
		2.4G	5.0G
A(main)	FPCB	1	1
B(aux)	FPCB	only aux receive	only aux receive

Note: The EUT has two types of antenna.
A antenna is transmitted, and B antenna is only aux receive.

2.2 DESCRIPTION OF TEST MODES

To investigate the maximum EMI emission characteristics generates from EUT, the test system was pre-scanning tested base on the consideration of following EUT operation mode or test configuration mode which possible have effect on EMI emission level. Each of these EUT operation mode(s) or test configuration mode(s) mentioned above was evaluated respectively.

Pretest Mode	Description
Mode 1	Link Mode
Mode 2	802.11a / n/ ac 20 CH36/ CH40/ CH 48 802.11a /n/ ac 20 CH149/ CH157/ CH 165
Mode 3	802.11n/ ac40 CH38/ CH 46 802.11n/ ac40 CH 151 / CH 159
Mode 4	802.11 ac80 CH42/CH 155

For Radiated Emission	
Final Test Mode	Description
Mode 1	Link Mode
Mode 2	802.11a / n/ ac 20 CH36/ CH40/ CH 48 802.11a /n/ ac 20 CH149/ CH157/ CH 165
Mode 3	802.11n/ ac40 CH38/ CH 46 802.11n/ ac40 CH 151 / CH 159
Mode 4	802.11 ac80 CH42/CH 155

Note:

- (1) The measurements are performed at the highest, middle, lowest available channels.
- (2) The measurements are performed at all Bit Rate of Transmitter, the worst data was reported

2.3 BLOCK DIGRAM SHOWING THE CONFIGURATION OF SYSTEM TESTED

For AC Conducted Emission Mode

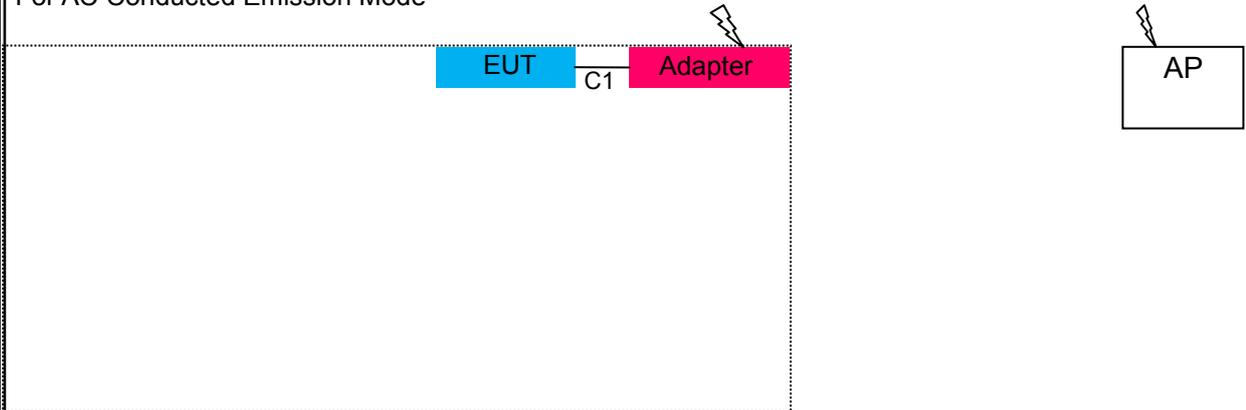

Radiated Spurious Emission Test

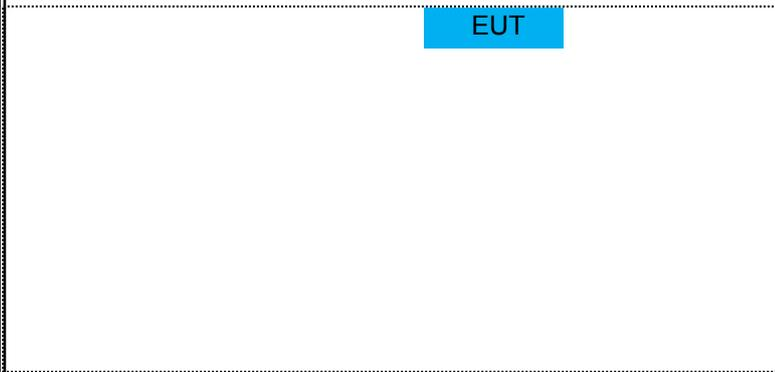

For Conducted Test Cases

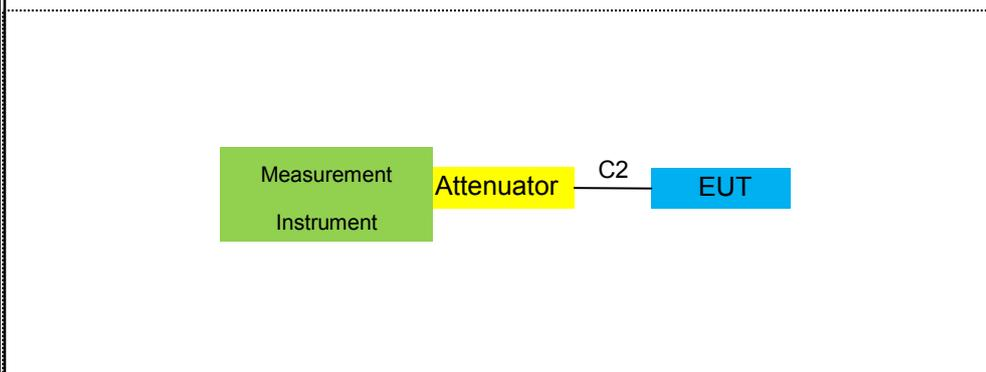

2.4 DESCRIPTION OF SUPPORT UNITS(CONDUCTED MODE)

The EUT has been tested as an independent unit together with other necessary accessories or support units. The following support units or accessories were used to form a representative test configuration during the tests.

Item	Equipment	Brand	Model/Type No.	Series No.	Note
E-1	Tablet projector	HEXA	Eclipse 1	N/A	EUT
E-2	Adapter	N/A	SUN-1900300	N/A	Peripherals

Item	Cable Type	Shielded Type	Ferrite Core	Length	Note
C-1	Power Cable	NO	NO	1.0m	
C-2	RF Cable	NO	NO	0.5m	

Note:

- (1) The support equipment was authorized by Declaration of Confirmation.
- (2) For detachable type I/O cable should be specified the length in cm in 『Length』 column.

Conduction Test equipment

Item	Kind of Equipment	Manufacturer	Type No.	Serial No.	Last calibration	Calibrated until	Calibration period
1	Test Receiver	R&S	ESCI	101160	2016.07.06	2017.07.05	1 year
2	LISN	R&S	ENV216	101313	2016.08.24	2017.08.23	1 year
3	LISN	EMCO	3816/2	00042990	2016.07.06	2017.07.05	1 year
4	50Ω Coaxial Switch	Anritsu	MP59B	6200264417	2016.07.06	2017.07.05	1 year
5	Passive Voltage Probe	R&S	ESH2-Z3	100196	2016.07.06	2017.07.05	1 year
6	Absorbing clamp	R&S	MOS-21	100423	2016.07.06	2017.07.05	1 year
7	Test Cable	N/A	C01	N/A	2016.06.08	2017.06.07	1 year
8	Test Cable	N/A	C02	N/A	2016.06.08	2017.06.07	1 year
9	Test Cable	N/A	C03	N/A	2016.06.08	2017.06.07	1 year

1	Attenuation	MCE	24-10-34	BN9258	2016.07.06	2017.07.05	1 year
---	-------------	-----	----------	--------	------------	------------	--------

3. EMC EMISSION TEST

3.1 CONDUCTED EMISSION MEASUREMENT

3.1.1 POWER LINE CONDUCTED EMISSION Limits (Frequency Range 150KHz-30MHz)

FREQUENCY (MHz)	Class A (dBuV)		Class B (dBuV)		Standard
	Quasi-peak	Average	Quasi-peak	Average	
0.15 -0.5	79.00	66.00	66 - 56 *	56 - 46 *	CISPR
0.50 -5.0	73.00	60.00	56.00	46.00	CISPR
5.0 -30.0	73.00	60.00	60.00	50.00	CISPR

0.15 -0.5	79.00	66.00	66 - 56 *	56 - 46 *	FCC/ RSS-247
0.50 -5.0	73.00	60.00	56.00	46.00	FCC/ RSS-247
5.0 -30.0	73.00	60.00	60.00	50.00	FCC/ RSS-247

Note:

- (1) The tighter limit applies at the band edges.
- (2) The limit of " * " marked band means the limitation decreases linearly with the logarithm of the frequency in the range.

The following table is the setting of the receiver

Receiver Parameters	Setting
Attenuation	10 dB
Start Frequency	0.15 MHz
Stop Frequency	30 MHz
IF Bandwidth	9 kHz

3.1.2 TEST PROCEDURE

- a. The EUT was placed 0.8 meters from the horizontal ground plane with EUT being connected to the power mains through a line impedance stabilization network (LISN). All other support equipments powered from additional LISN(s). The LISN provide 50 Ohm/ 50uH of coupling impedance for the measuring instrument.
- b. Interconnecting cables that hang closer than 40 cm to the ground plane shall be folded back and forth in the center forming a bundle 30 to 40 cm long.
- c. I/O cables that are not connected to a peripheral shall be bundled in the center. The end of the cable may be terminated, if required, using the correct terminating impedance. The overall length shall not exceed 1 m.
- d. LISN at least 80 cm from nearest part of EUT chassis.
- e. For the actual test configuration, please refer to the related Item –EUT Test Photos.

3.1.3 DEVIATION FROM TEST STANDARD

No deviation

3.1.4 TEST SETUP

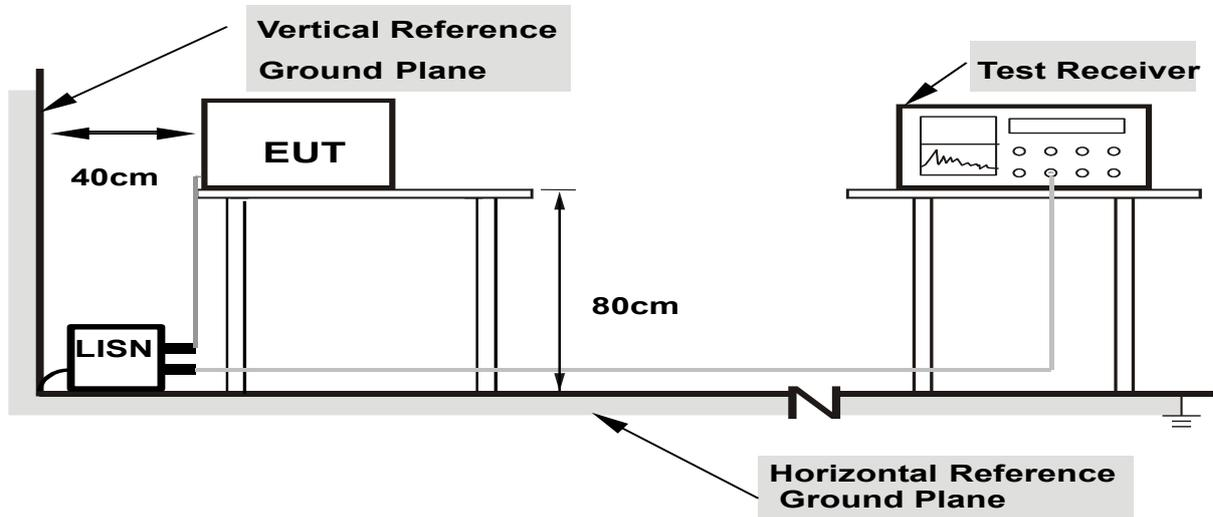

- Note:**
- 1.Support units were connected to second LISN.
 - 2.Both of LISNs (AMN) are 80 cm from EUT and at least 80 from other units and other metal planes

3.1.5 EUT OPERATING CONDITIONS

The EUT was configured for testing in a typical fashion (as a customer would normally use it). The EUT has been programmed to continuously transmit during test. This operating condition was tested and used to collect the included data.

(a) For radiated emissions below 30MHz

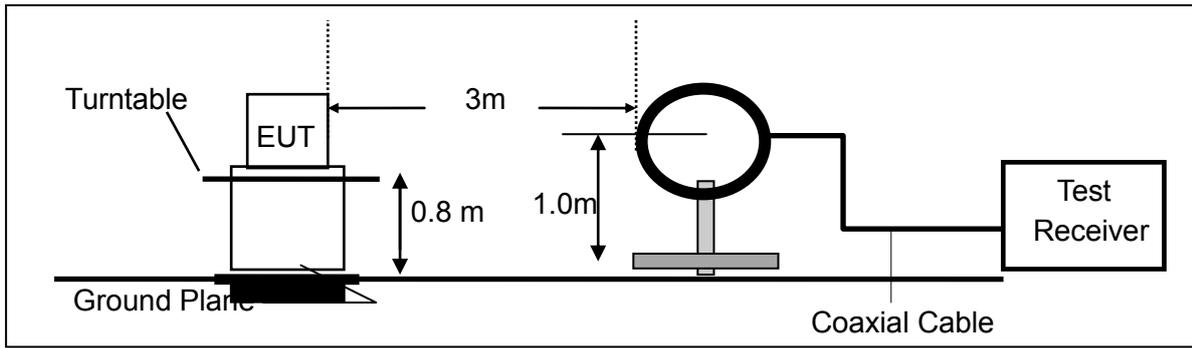

(b) For radiated emissions from 30MHz to 1000MHz

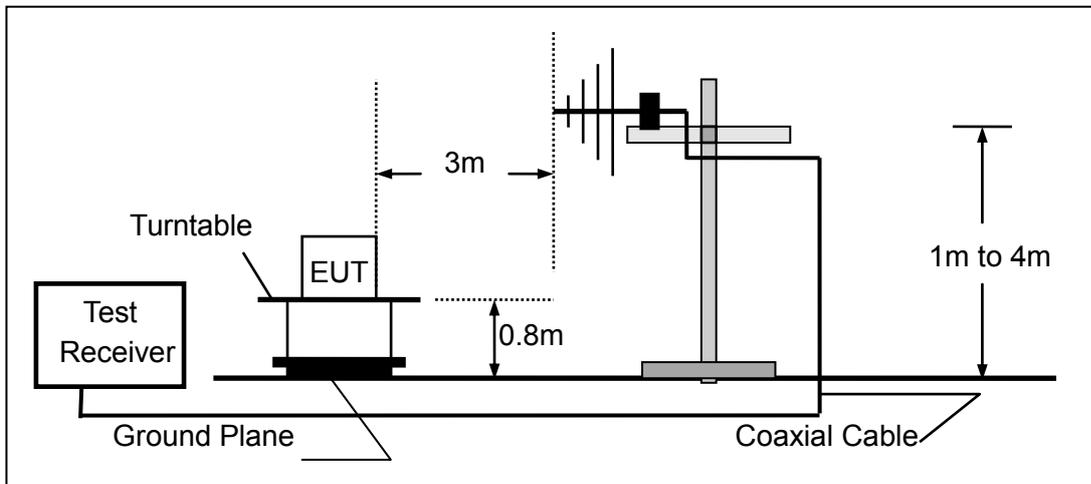

(c) For radiated emissions above 1000MHz

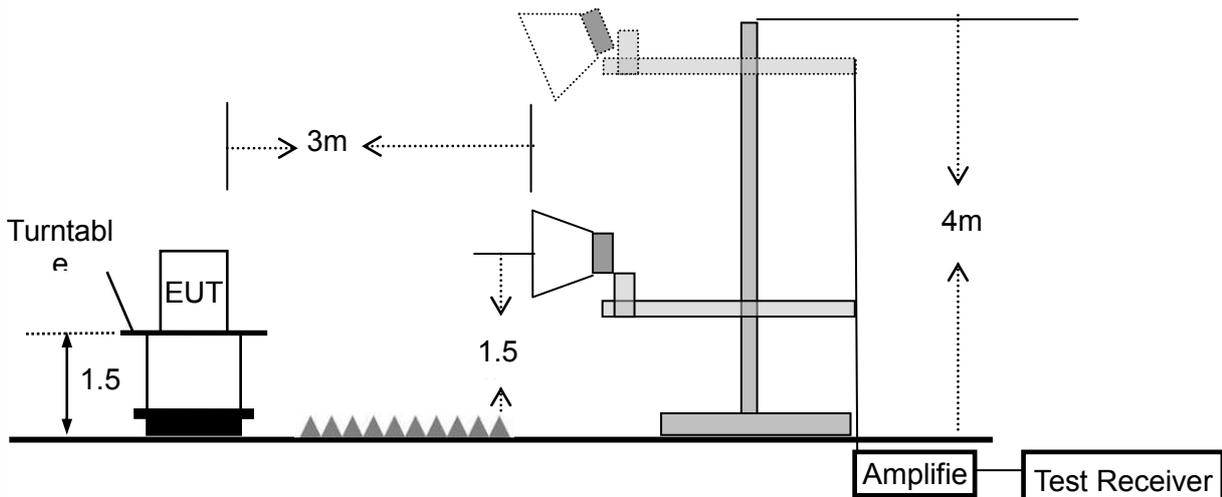

3.2.6 TEST RESULTS (BETWEEN 9KHZ – 30 MHZ)

EUT:	Tablet projector	Model Name. :	Eclipse 1
Temperature:	20 °C	Relative Humidity:	48%
Pressure:	1010 hPa	Test Voltage :	DC 11.4V
Test Mode :	TX	Polarization :	--

Freq. (MHz)	Reading (dBuV/m)	Limit (dBuV/m)	Margin (dB)	State P/F
--	--	--	--	N/A
--	--	--	--	N/A

NOTE:

The amplitude of spurious emissions which are attenuated by more than 20dB below the permissible value has no need to be reported.

Distance extrapolation factor = $40 \log(\text{specific distance}/\text{test distance})$ (dB);

Limit line = specific limits(dBuv) + distance extrapolation factor.

Polar (H/V)	Frequency	Meter Reading	Factor	Emission Level	Limits	Margin	Remark
	(MHz)	(dBuV)	(dB)	(dBuV/m)	(dBuV/m)	(dB)	
H	92.4624	16.95	11.05	28	43.5	-15.5	QP
H	166.6511	21.02	11.76	32.78	43.5	-10.72	QP
H	207.8497	27.19	11.01	38.2	43.5	-5.3	QP
H	311.0867	22.48	16.62	39.1	46	-6.9	QP
H	396.2412	16.76	20.04	36.8	46	-9.2	QP
H	533.8318	11.69	23.75	35.44	46	-10.56	QP

Remark:

Absolute Level= ReadingLevel+ Factor, Margin= Absolute Level - Limit

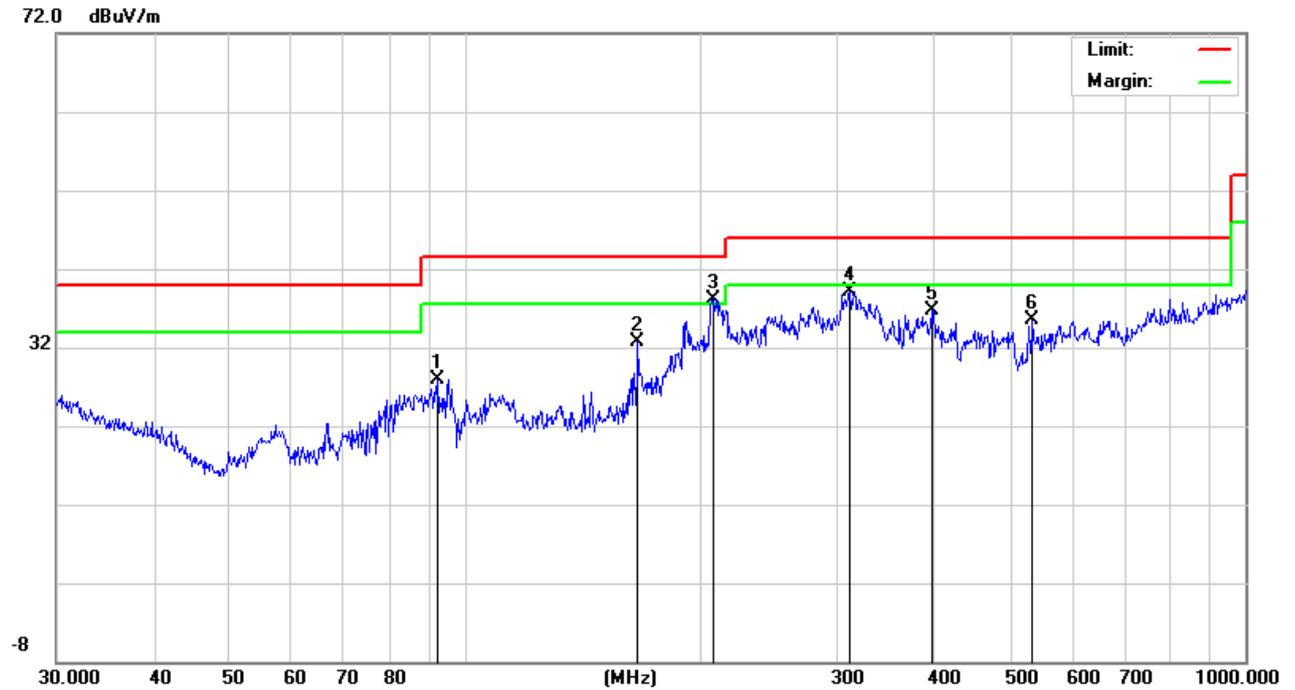

Polar (H/V)	Frequency	Meter Reading	Factor	Emission Level	Limits	Margin	Remark
	(MHz)	(dBuV)	(dB)	(dBuV/m)	(dBuV/m)	(dB)	
H	57.7961	16.91	6.69	23.6	40	-16.4	QP
H	90.2205	17.62	10.68	28.3	43.5	-15.2	QP
H	119.8555	16.25	13.86	30.11	43.5	-13.39	QP
H	234.9909	21.6	12.7	34.3	46	-11.7	QP
H	300.3672	23.29	16.29	39.58	46	-6.42	QP
H	586.8437	11	24.64	35.64	46	-10.36	QP

Remark:

Absolute Level= ReadingLevel+ Factor, Margin= Absolute Level - Limit

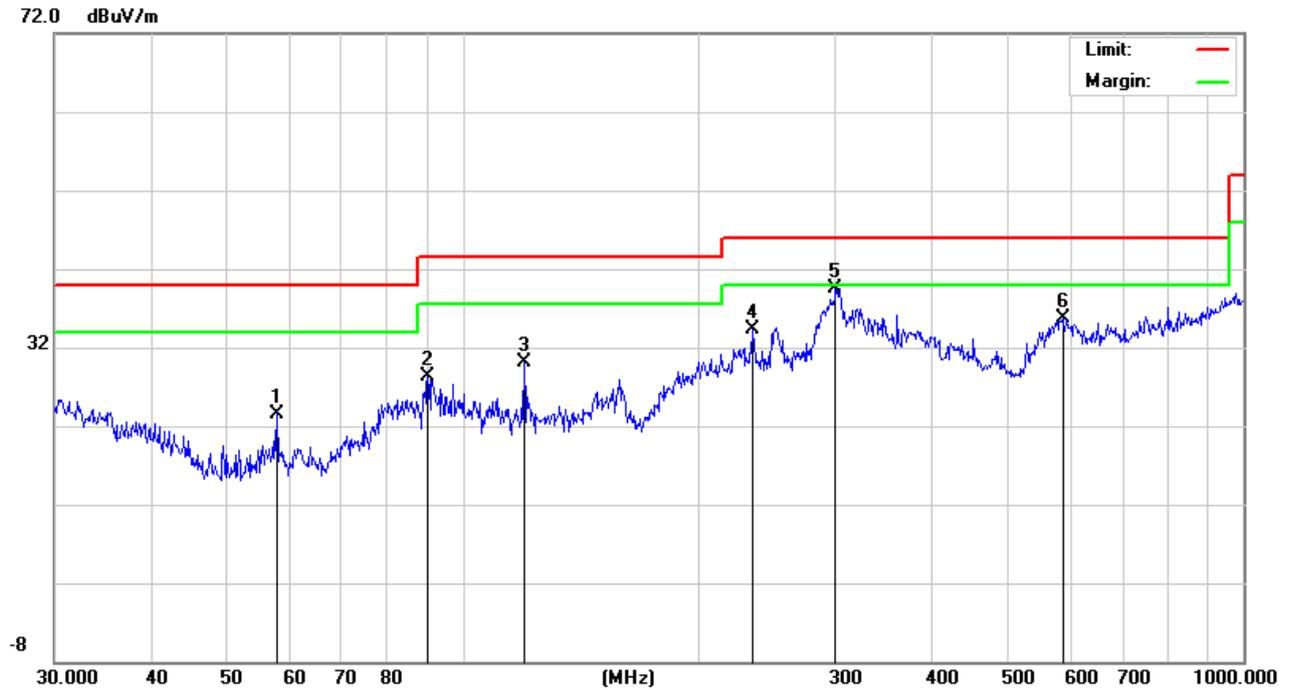

Note: "802.11N(20)(5G)" mode is the worst mode. PK value is lower than the Average value limit, So average didn't record.

The amplitude of spurious emissions that are attenuated by more than 20dB below the permissible value has no need to be reported.

Emission level (dBuV/m) = 20 log Emission level (uV/m).

Corrected Reading: Antenna Factor + Cable Loss + Read Level - Preamp Factor = Level.

Note: "802.11N(20)(5G)" mode is the worst mode. PK value is lower than the Average value limit, So average didn't record.

The amplitude of spurious emissions that are attenuated by more than 20dB below the permissible value has no need to be reported.

Emission level (dBuV/m) = 20 log Emission level (uV/m).

Corrected Reading: Antenna Factor + Cable Loss + Read Level - Preamp Factor = Level.

TEST RESULTS (18GHz-40GHz)

EUT :	Tablet projector	Model Name :	Eclipse 1
Temperature :	20 °C	Relative Humidity :	48%
Pressure :	1010 hPa	Test Voltage :	DC 11.4V
Test Mode :	TX (5.2G)-802.11N(20) 5180MHz~5240MHz , TX (5.8G) -802.11N(20) 5745MHz~5825MHz		

All the modulation modes have been tested, and the worst result was report as below:
 Channel (5180 MHz) 18-26.5G

Horizontal

FCC Electric Field Strength 18-26.5GHz

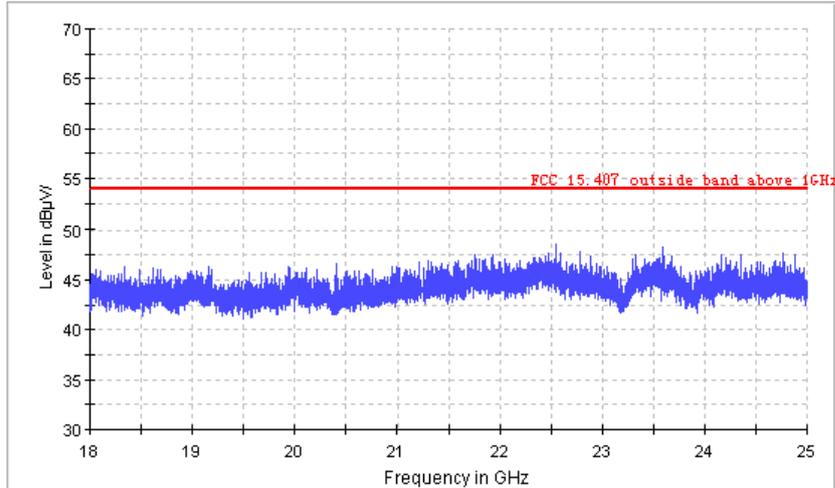

Vertical

FCC Electric Field Strength 18-26.5GHz

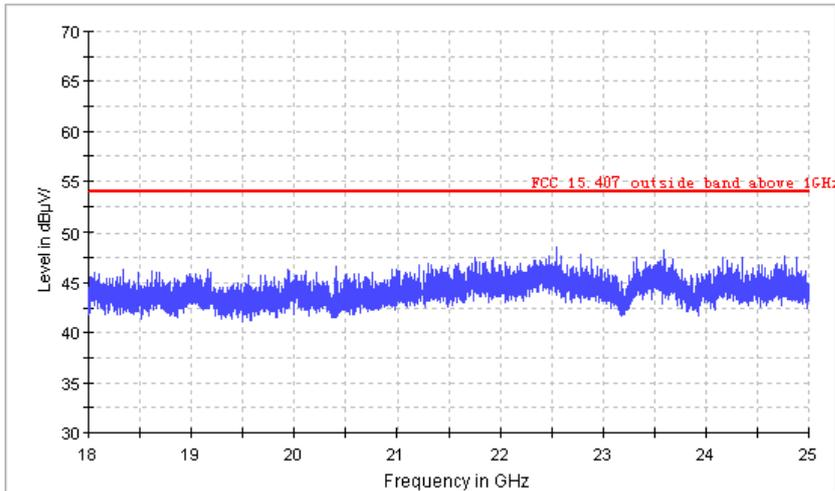

Channel (5180 MHz) 26.5-40G

Horizontal

FCC Electric Field Strength 26.5-40GHz

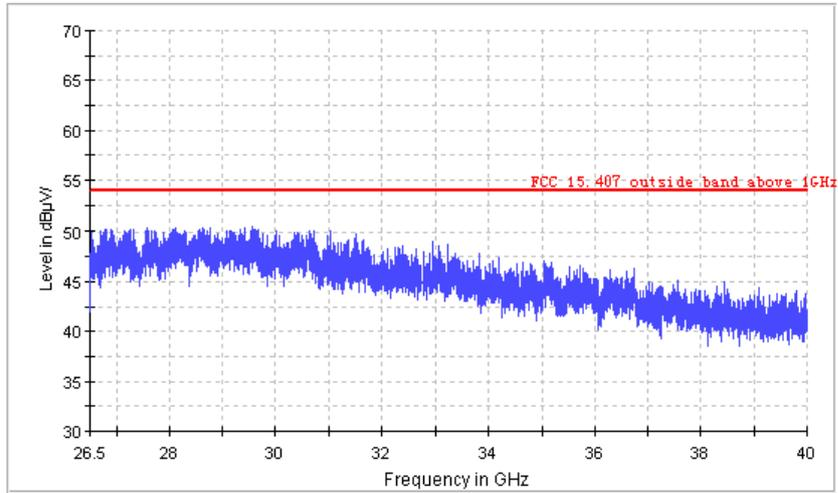

Vertical

FCC Electric Field Strength 26.5-40GHz

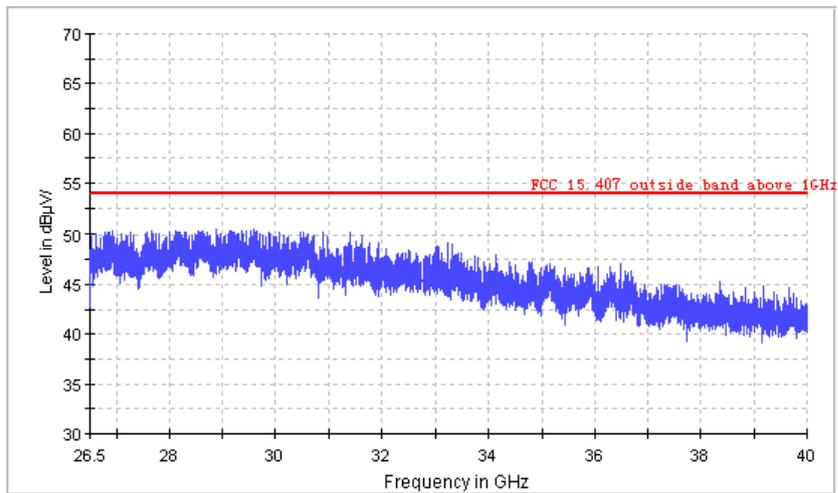

Channel (5745 MHz) 18-26.5G

Horizontal

FCC Electric Field Strength 18-26.5GHz

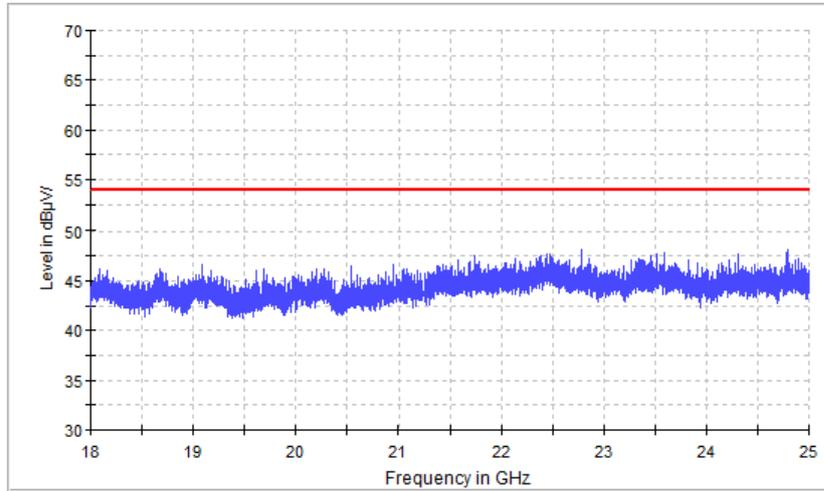

Vertical

FCC Electric Field Strength 18-26.5GHz

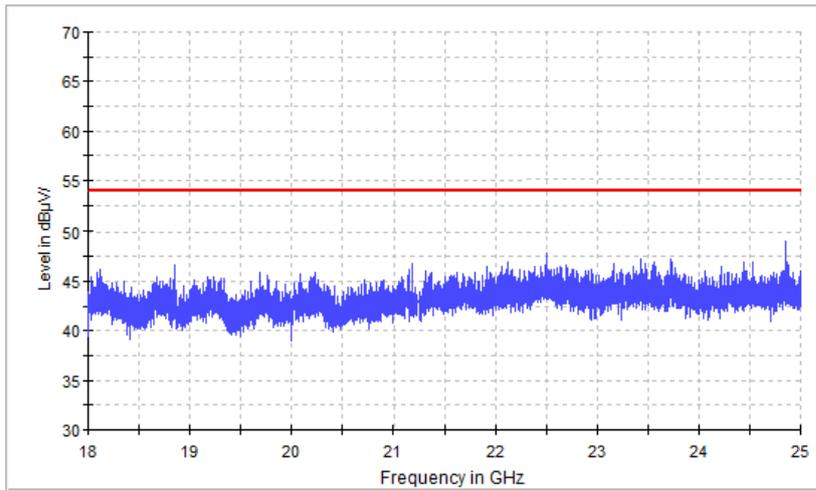

Channel (5745 MHz) 26.5-40G

Horizontal

FCC Electric Field Strength 26.5-40GHz

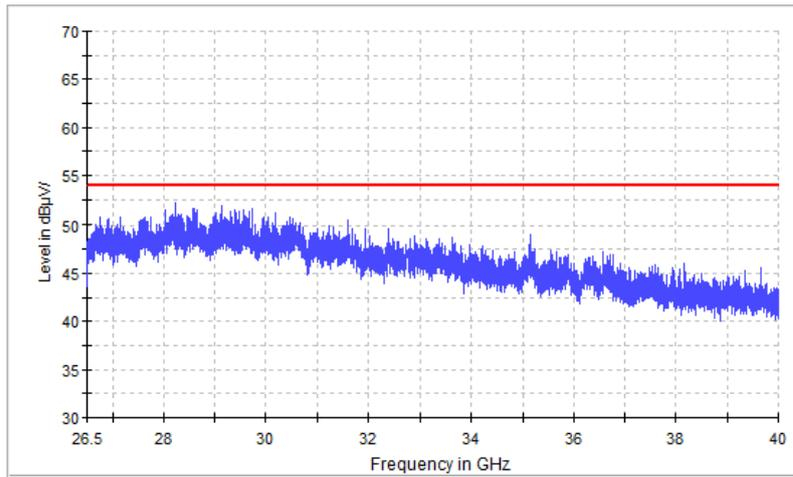

Vertical

FCC Electric Field Strength 26.5-40GHz

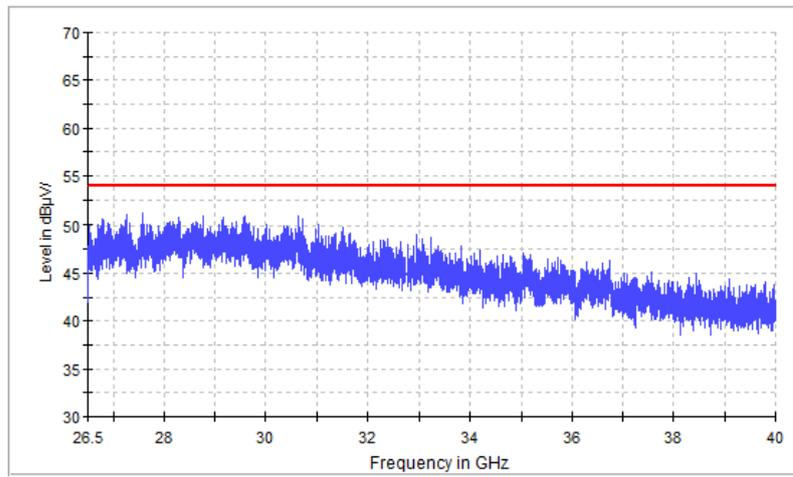

4. POWER SPECTRAL DENSITY TEST

4.1 APPLIED PROCEDURES / LIMIT

According to FCC §15.407(a)(3)

For the band 5.15-5.25 GHz,

(i) For an outdoor access point operating in the band 5.15-5.25 GHz, the maximum power spectral density shall not exceed 17 dBm in any 1 megahertz band. If transmitting antennas of directional gain greater than 6 dBi are used, both the maximum conducted output power and the maximum power spectral density shall be reduced by the amount in dB that the directional gain of the antenna exceeds 6 dBi. The maximum e.i.r.p. at any elevation angle above 30 degrees as measured from the horizon must not exceed 125 mW (21 dBm).

(ii) For an indoor access point operating in the band 5.15-5.25 GHz, the maximum power spectral density shall not exceed 17 dBm in any 1 megahertz band. If transmitting antennas of directional gain greater than 6 dBi are used, both the maximum conducted output power and the maximum power spectral density shall be reduced by the amount in dB that the directional gain of the antenna exceeds 6 dBi.

(iii) For fixed point-to-point access points operating in the band 5.15-5.25 GHz, the maximum power spectral density shall not exceed 17 dBm in any 1 megahertz band. Fixed point-to-point U-NII devices may employ antennas with directional gain up to 23 dBi without any corresponding reduction in the maximum conducted output power or maximum power spectral density. For fixed point-to-point transmitters that employ a directional antenna gain greater than 23 dBi, a 1 dB reduction in maximum conducted output power and maximum power spectral density is required for each 1 dB of antenna gain in excess of 23 dBi. Fixed, point-to-point operations exclude the use of point-to-multipoint systems, omnidirectional applications, and multiple collocated transmitters transmitting the same information. The operator of the U-NII device, or if the equipment is professionally installed, the installer, is responsible for ensuring that systems employing high gain directional antennas are used exclusively for fixed, point-to-point operations.

(iv) For mobile and portable client devices in the 5.15-5.25 GHz band, the maximum power spectral density shall not exceed 11 dBm in any 1 megahertz band. If transmitting antennas of directional gain greater than 6 dBi are used, both the maximum conducted output power and the maximum power spectral density shall be reduced by the amount in dB that the directional gain of the antenna exceeds 6 dBi.

For the band 5.725-5.85 GHz

(3) For the band 5.725-5.85 GHz, the maximum power spectral density shall not exceed 30 dBm in any 500-kHz band. If transmitting antennas of directional gain greater than 6 dBi are used, both the maximum conducted output power and the maximum power spectral density shall be reduced by the amount in dB that the directional gain of the antenna exceeds 6 dBi.

4.2 TEST PROCEDURE

For devices operating in the bands 5.15-5.25 GHz, 5.25-5.35 GHz, and 5.47-5.725 GHz, the above procedures make use of 1 MHz RBW to satisfy directly the 1 MHz reference bandwidth specified in § 15.407(a)(5). For devices operating in the band 5.725-5.85 GHz, the rules specify a measurement bandwidth of 500 kHz. Many spectrum analyzers do not have 500 kHz RBW, thus a narrower RBW may need to be used. The rules permit the use of a RBWs less than 1 MHz, or 500 kHz, “provided that the measured power is integrated over the full reference bandwidth” to show the total power over the specified measurement bandwidth (i.e., 1 MHz, or 500 kHz). If measurements are performed using a reduced resolution bandwidth (< 1 MHz, or < 500 kHz) and integrated over 1 MHz, or 500 KHz bandwidth, the following adjustments to the procedures apply:

- a) Set $RBW \geq 1/T$, where T is defined in section II.B.I.a).
- b) Set $VBW \geq 3 RBW$.
- c) If measurement bandwidth of Maximum PSD is specified in 500 kHz, add $10\log(500\text{kHz}/RBW)$ to the measured result, whereas RBW (< 500 KHz) is the reduced resolution bandwidth of the spectrum analyzer set during measurement.
- d) If measurement bandwidth of Maximum PSD is specified in 1 MHz, add $10\log(1\text{MHz}/RBW)$ to the measured result, whereas RBW (< 1 MHz) is the reduced resolution bandwidth of spectrum analyzer set during measurement.
- e) Care must be taken to ensure that the measurements are performed during a period of continuous transmission or are corrected upward for duty cycle.

Note: As a practical matter, it is recommended to use reduced RBW of 100 KHz for the sections 5.c) and 5.d) above, since RBW=100 KHZ is available on nearly all spectrum analyzers.

4.3 DEVIATION FROM STANDARD

No deviation.

4.4 TEST SETUP



4.5 EUT OPERATION CONDITIONS

The EUT tested system was configured as the statements of 2.1 Unless otherwise a special operating condition is specified in the follows during the testing.

4.6 TEST RESULTS

EUT :	Tablet projector	Model Name :	Eclipse 1
Temperature :	25 °C	Relative Humidity :	56%
Pressure :	1015 hPa	Test Voltage :	DC 11.4V
Test Mode :	TX Frequency (5150-5250MHz)		

Mode	Frequency	Measured Power Density (dBm)	Limit (dBm)	Result
802.11 a	5185 MHz	2.161	11	PASS
	5200 MHz	2.255	11	PASS
	5240 MHz	1.965	11	PASS
802.11 n20	5185 MHz	0.358	11	PASS
	5200 MHz	0.595	11	PASS
	5240 MHz	-0.125	11	PASS
802.11 n40	5190 MHz	-2.753	11	PASS
	5230 MHz	-3.266	11	PASS
802.11 AC20	5185 MHz	0.745	11	PASS
	5200 MHz	0.682	11	PASS
	5240 MHz	0.542	11	PASS
802.11 AC40	5190 MHz	-2.530	11	PASS
	5230 MHz	-3.495	11	PASS
802.11 AC80	5210 MHz	-6.691	11	PASS

Note: 1. Calculate power density= Measured Power Density+10log(1MHz/RBW)
 RBW=1MHz

(802.11ac40) PSD plot on channel 38



(802.11ac80) PSD plot on channel 42



(802.11ac40) PSD plot on channel 46



(802.11n40) PSD plot on channel 151



(802.11ac20) PSD plot on channel 149



(802.11n40) PSD plot on channel 159



(802.11ac20) PSD plot on channel 157



(802.11ac20) PSD plot on channel 165

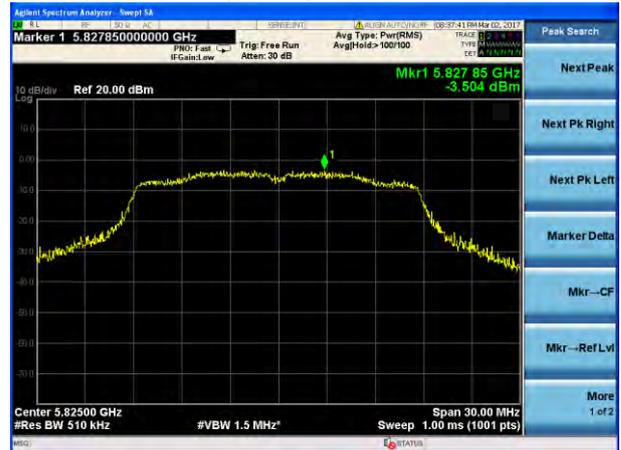

(802.11ac40) PSD plot on channel 151



(802.11ac80) PSD plot on channel 155



(802.11ac40) PSD plot on channel 159



5. 26 DB & 99% EMISSION BANDWIDTH

5.1 APPLIED PROCEDURES / LIMIT

The maximum power spectral density is measured as a conducted emission by direct connection of a calibrated test instrument to the equipment under test. If the device cannot be connected directly, alternative techniques acceptable to the Commission may be used. Measurements in the 5.725-5.85 GHz band are made over a reference bandwidth of 500 kHz or the 26 dB emission bandwidth of the device, whichever is less. Measurements in the 5.15-5.25 GHz, 5.25-5.35 GHz, and the 5.47-5.725 GHz bands are made over a bandwidth of 1 MHz or the 26 dB emission bandwidth of the device, whichever is less. A narrower resolution bandwidth can be used, provided that the measured power is integrated over the full reference bandwidth.

5.2 TEST PROCEDURE

- a) Set RBW = approximately 1% of the emission bandwidth.
- b) Set the VBW > RBW.
- c) Detector = Peak.
- d) Trace mode = max hold.
- e) Measure the maximum width of the emission that is 26 dB down from the maximum of the emission. Compare this with the RBW setting of the analyzer. Readjust RBW and repeat measurement as needed until the RBW/EBW ratio is approximately 1%.

The following procedure shall be used for measuring (99 %) power bandwidth:

1. Set center frequency to the nominal EUT channel center frequency.
2. Set span = 1.5 times to 5.0 times the OBW.
3. Set RBW = 1 % to 5 % of the OBW
4. Set VBW $\geq 3 \cdot$ RBW
5. Video averaging is not permitted. Where practical, a sample detection and single sweep mode shall be used. Otherwise, peak detection and max hold mode (until the trace stabilizes) shall be used.
6. Use the 99 % power bandwidth function of the instrument (if available).
7. If the instrument does not have a 99 % power bandwidth function, the trace data points are recovered and directly summed in power units. The recovered amplitude data points, beginning at the lowest frequency, are placed in a running sum until 0.5 % of the total is reached; that frequency is recorded as the lower frequency. The process is repeated until 99.5 % of the total is reached; that frequency is recorded as the upper frequency. The 99% occupied bandwidth is the difference between these two frequencies.

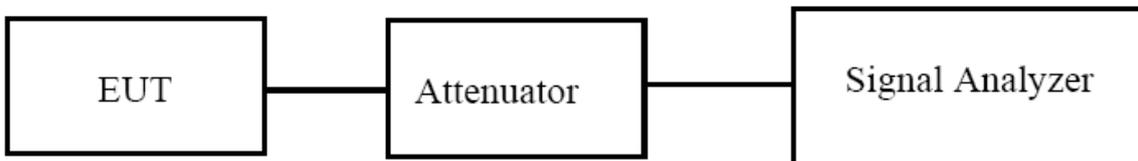

5.3 EUT OPERATION CONDITIONS

The EUT tested system was configured as the statements of 2.4 Unless otherwise a special operating condition is specified in the follows during the testing.

5.4 TEST RESULTS

EUT :	Tablet projector	Model Name :	Eclipse 1
Temperature :	25 °C	Relative Humidity :	56%
Pressure :	1012 hPa	Test Voltage :	DC 11.4V
Test Mode :	TX Frequency (5150-5250MHz)		

Mode	Channel	Frequency (MHz)	99% bandwidth (MHz)	26dB bandwidth (MHz)	Result
802.11a	CH36	5180	16.670	23.65	Pass
	CH40	5200	16.722	23.46	Pass
	CH48	5240	16.936	26.80	Pass
802.11 n20	CH36	5180	17.762	23.60	Pass
	CH40	5200	17.843	25.75	Pass
	CH48	5240	17.996	27.36	Pass
802.11 n40	CH 38	5190	36.046	41.77	Pass
	CH 46	5230	36.160	48.68	Pass
802.11 AC20	CH36	5180	17.819	24.06	Pass
	CH40	5200	17.818	25.75	Pass
	CH48	5240	18.053	26.90	Pass
802.11 AC40	CH 38	5190	36.182	54.11	Pass
	CH 46	5230	36.131	47.72	Pass
802.11 AC80	CH 42	5210	75.607	100.0	Pass

(802.11ac40) -26dB&99% Bandwidth plot on channel 38

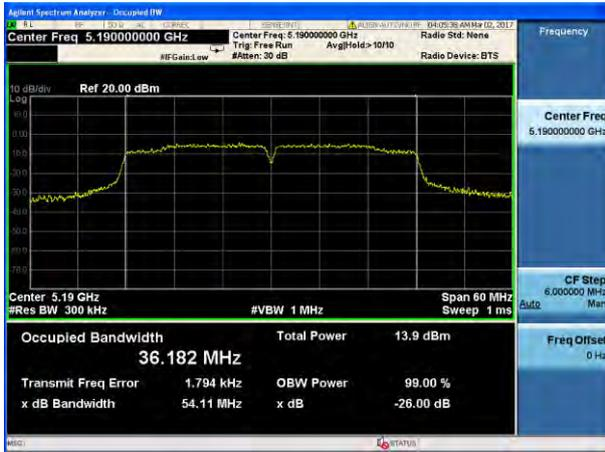

(802.11ac80) -26dB&99% Bandwidth plot on channel 42

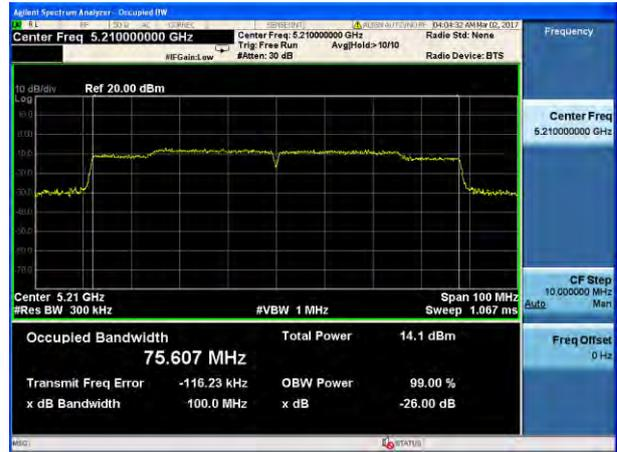

(802.11ac40) -26dB&99% Bandwidth plot on channel 46



EUT :	Tablet projector	Model Name :	Eclipse 1
Temperature :	25 °C	Relative Humidity :	56%
Pressure :	1012 hPa	Test Voltage :	DC 11.4V
Test Mode :	TX Frequency (5745-5850MHz)		

Mode	Channel	Frequency (MHz)	99% bandwidth (MHz)	26dB bandwidth (MHz)	Result
802.11a	CH149	5745	16.700	23.33	Pass
	CH157	5785	16.753	24.75	Pass
	CH165	5825	16.732	26.05	Pass
802.11 n20	CH149	5745	17.809	25.09	Pass
	CH157	5785	17.913	25.88	Pass
	CH165	5825	18.253	29.49	Pass
802.11 n40	CH151	5755	36.117	47.54	Pass
	CH159	5795	36.074	45.23	Pass
802.11 AC20	CH149	5745	17.801	24.25	Pass
	CH157	5785	17.883	26.51	Pass
	CH165	5825	17.945	27.19	Pass
802.11 AC40	CH151	5755	36.025	44.17	Pass
	CH159	5795	36.070	44.47	Pass
802.11 AC80	CH155	5775	75.530	97.56	Pass

(802.11ac40) -26dB&99% Bandwidth plot on channel 151



(802.11ac80) -26dB&99% Bandwidth plot on channel 155

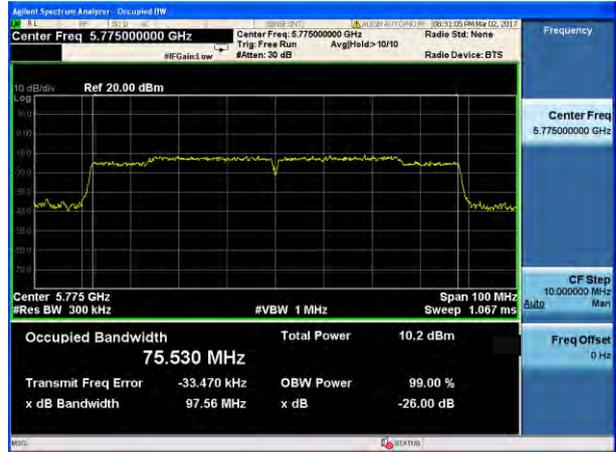

(802.11ac40) -26dB&99% Bandwidth plot on channel 159

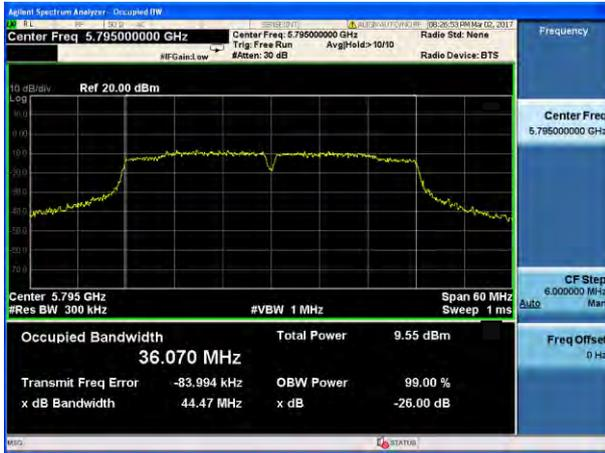

6. MINIMUM 6 DB BANDWIDTH

6.1 APPLIED PROCEDURES / LIMIT

According to FCC §15.407(e)

(e) Within the 5.725-5.85 GHz band, the minimum 6 dB bandwidth of U-NII devices shall be at least 500 kHz.

6.2 TEST PROCEDURE

Section 15.407(e) specifies the minimum 6 dB emission bandwidth of at least 500 KHz for the band 5.715-5.85 GHz. The following procedure shall be used for measuring this bandwidth:

- a) Set RBW = 100 kHz.
- b) Set the video bandwidth (VBW) $\geq 3 \times$ RBW.
- c) Detector = Peak.
- d) Trace mode = max hold.
- e) Sweep = auto couple.
- f) Allow the trace to stabilize.
- g) Measure the maximum width of the emission that is constrained by the frequencies associated with the two outermost amplitude points (upper and lower frequencies) that are attenuated by 6 dB relative to the maximum level measured in the fundamental emission.

6.3 DEVIATION FROM STANDARD

No deviation.

6.4 TEST SETUP

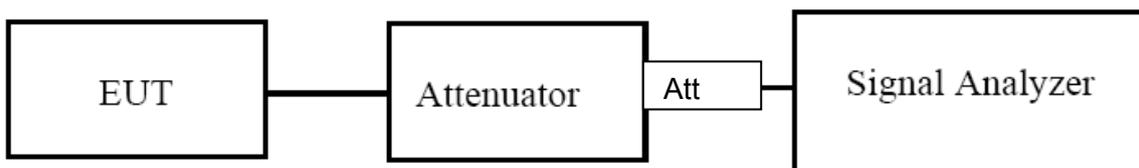

6.5 EUT OPERATION CONDITIONS

The EUT tested system was configured as the statements of 2.4 Unless otherwise a special operating condition is specified in the follows during the testing.

6.6 TEST RESULTS

EUT :	Tablet projector	Model Name :	Eclipse 1
Temperature :	25 °C	Relative Humidity :	56%
Pressure :	1012 hPa	Test Voltage :	DC 11.4V
Test Mode :	TX Frequency (5150-5250MHz)		

Mode	Channel	Frequency (MHz)	-6dB bandwidth(MHz)	Result
802.11a	CH36	5180	15.15	Pass
	CH40	5200	15.16	Pass
	CH48	5240	15.16	Pass
802.11 n20	CH36	5180	15.37	Pass
	CH40	5200	15.08	Pass
	CH48	5240	15.13	Pass
802.11 n40	CH 38	5190	35.13	Pass
	CH 46	5230	35.16	Pass
802.11 AC20	CH36	5180	15.15	Pass
	CH40	5200	15.16	Pass
	CH48	5240	15.16	Pass
802.11 AC40	CH 38	5190	35.17	Pass
	CH 46	5230	35.16	Pass
802.11 AC80	CH 42	5210	75.21	Pass

(802.11ac40) -6dB Bandwidth plot on channel 151

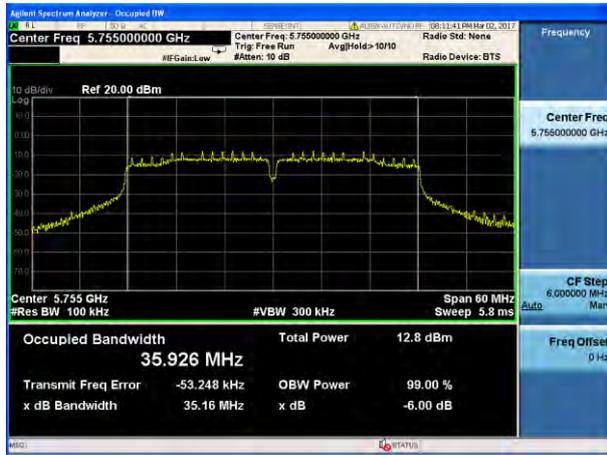

(802.11ac80) -6dB Bandwidth plot on channel 155

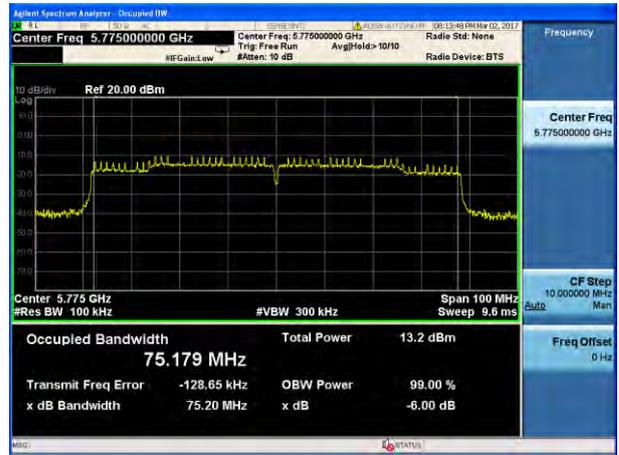

(802.11ac40) -6dB Bandwidth plot on channel 159

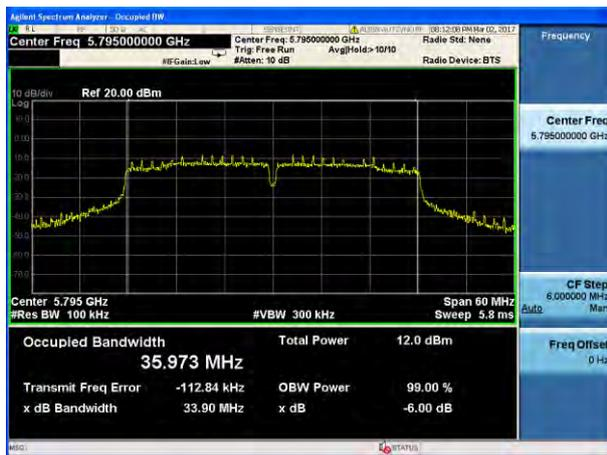

7. MAXIMUM CONDUCTED OUTPUT POWER

7.1 PPLIED PROCEDURES / LIMIT

According to FCC §15.407

According to FCC §15.407

The maximum conducted output power should not exceed:

Frequency Band(MHz)	Limit
5150~5250	250mW
5725~5850	1W

The maximum e.i.r.p should not exceed:

Frequency Band(MHz)	Limit
5150~5250	200mW or 10dBm +10logB whichever is less
5725~5850	N/A

Note: Where “B” is the 99% emission bandwidth in MHz

7.2 TEST PROCEDURE

· Maximum conducted output power may be measured using a spectrum analyzer/EMI receiver or an RF power meter.

1. Device Configuration

If possible, configure or modify the operation of the EUT so that it transmits continuously at its maximum power control level (see section II.B.).

a) The intent is to test at 100 percent duty cycle; however a small reduction in duty cycle (to no lower than 98 percent) is permitted if required by the EUT for amplitude control purposes. Manufacturers are expected to provide software to the test lab to permit such continuous operation.

b) If continuous transmission (or at least 98 percent duty cycle) cannot be achieved due to hardware limitations (e.g., overheating), the EUT shall be operated at its maximum power control level with the transmit duration as long as possible and the duty cycle as high as possible.

2. Measurement using a Spectrum Analyzer or EMI Receiver (SA)

Measurement of maximum conducted output power using a spectrum analyzer requires integrating the spectrum across a frequency span that encompasses, at a minimum, either the EBW or the 99-percent occupied bandwidth of the signal.¹ However, the EBW must be used to determine bandwidth dependent limits on maximum conducted output power in accordance with § 15.407(a).

a) The test method shall be selected as follows: (i) Method SA-1 or SA-1 Alternative (averaging with the EUT transmitting at full power throughout each sweep) shall be applied if either of the following conditions can be satisfied:

- The EUT transmits continuously (or with a duty cycle ≥ 98 percent).
- Sweep triggering or gating can be implemented in a way that the device transmits at the maximum power control level throughout the duration of each of the instrument sweeps to be averaged. This condition can generally be achieved by triggering the instrument's sweep if the duration of the sweep (with the analyzer configured as in Method SA-1, below) is equal to or shorter than the duration T of each transmission from the EUT and if those transmissions exhibit full power throughout their durations.

(ii) Method SA-2 or SA-2 Alternative (averaging across on and off times of the EUT transmissions, followed by duty cycle correction) shall be applied if the conditions of (i) cannot be achieved and the transmissions exhibit a constant duty cycle during the measurement duration. Duty cycle will be considered to be constant if variations are less than ± 2 percent.

(iii) Method SA-3 (RMS detection with max hold) or SA-3 Alternative (reduced VBW with max hold) shall be applied if the conditions of (i) and (ii) cannot be achieved.

b) Method SA-1 (trace averaging with the EUT transmitting at full power throughout each sweep): (i) Set span to encompass the entire emission bandwidth (EBW) (or, alternatively, the entire 99% occupied bandwidth) of the signal.

(ii) Set RBW = 1 MHz.

(iii) Set VBW ≥ 3 MHz.

(iv) Number of points in sweep ≥ 2 Span / RBW. (This ensures that bin-to-bin spacing is \leq RBW/2, so that narrowband signals are not lost between frequency bins.)

(v) Sweep time = auto.

(vi) Detector = RMS (i.e., power averaging), if available. Otherwise, use sample detector mode.

(vii) If transmit duty cycle < 98 percent, use a video trigger with the trigger level set to enable triggering only on full power pulses. Transmitter must operate at maximum power control level for the entire duration of every sweep. If the EUT transmits continuously (i.e., with no off intervals) or at duty cycle ≥ 98 percent, and if each transmission is entirely at the maximum power control level, then the trigger shall be set to "free run".

(viii) Trace average at least 100 traces in power averaging (i.e., RMS) mode.

(ix) Compute power by integrating the spectrum across the EBW (or, alternatively, the entire 99% occupied bandwidth) of the signal using the instrument's band power measurement function with band limits set equal to the EBW (or occupied bandwidth) band edges. If the instrument does not have a band power function, sum the spectrum

7.3 DEVIATION FROM STANDARD

No deviation.

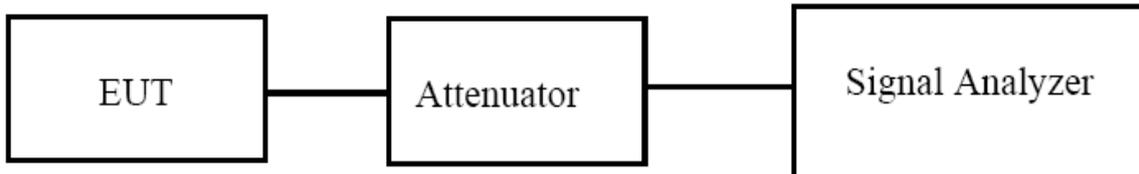
7.4 TEST SETUP**7.5 EUT OPERATION CONDITIONS**

The EUT tested system was configured as the statements of 2.4 Unless otherwise a special operating condition is specified in the follows during the testing.

8. OUT OF BAND EMISSIONS

8.1 APPLICABLE STANDARD

According to FCC §15.407(b)

Undesirable emission limits. Except as shown in paragraph (b)(7) of this section, the maximum emissions outside of the frequency bands of operation shall be attenuated in accordance with the following limits:

(1) For transmitters operating in the 5.15-5.25 GHz band: All emissions outside of the 5.15-5.35 GHz band shall not exceed an e.i.r.p. of -27 dBm/MHz.

(2) For transmitters operating in the 5.725-5.85 GHz band: All emissions shall be limited to a level of -27 dBm/MHz at 75 MHz or more above or below the band edge increasing linearly to 10 dBm/MHz at 25 MHz above or below the band edge, and from 25 MHz above or below the band edge increasing linearly to a level of 15.6 dBm/MHz at 5 MHz above or below the band edge, and from 5 MHz above or below the band edge increasing linearly to a level of 27 dBm/MHz at the band edge.

8.2 TEST PROCEDURE

1. Check the calibration of the measuring instrument using either an internal calibrator or a known signal from an external generator.
2. Position the EUT without connection to measurement instrument. Turn on the EUT and connect its antenna terminal to measurement instrument via a low loss cable. Then set it to any one measured frequency within its operating range, and make sure the instrument is operated in its linear range.
3. Set RBW of spectrum analyzer to 1 MHz with a convenient frequency span.
4. Measure the highest amplitude appearing on spectral display and set it as a reference level. Plot the graph with marking the highest point and edge frequency.
5. Repeat above procedures until all measured frequencies were complete.

8.3 DEVIATION FROM STANDARD

No deviation.

8.4 TEST SETUP



8.5 EUT OPERATION CONDITIONS

The EUT tested system was configured as the statements of 2.4 Unless otherwise a special operating condition is specified in the follows during the testing.

8.6 TEST RESULTS

EUT :	Tablet projector	Model Name :	Eclipse 1
Temperature :	25 °C	Relative Humidity :	56%
Pressure :	1012 hPa	Test Voltage :	DC 11.4V

5.2G

5.15~5.25 GHz

(802.11a) Band Edge, Left Side



(802.11n20) Band Edge, Left Side

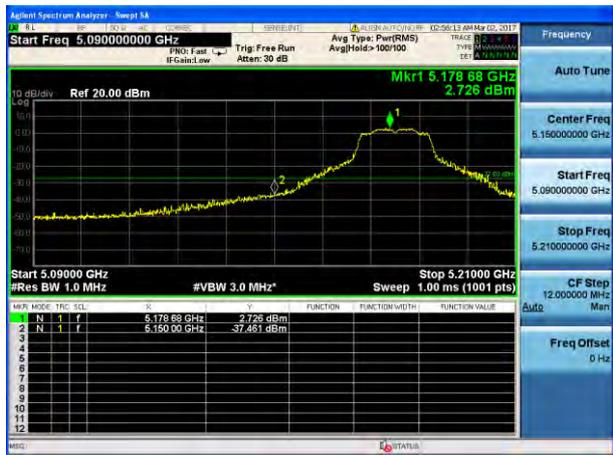

(802.11a) Band Edge, Right Side

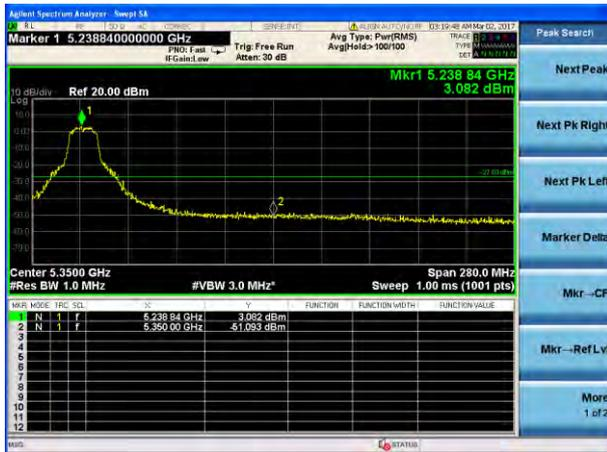

(802.11n20) Band Edge, Right Side

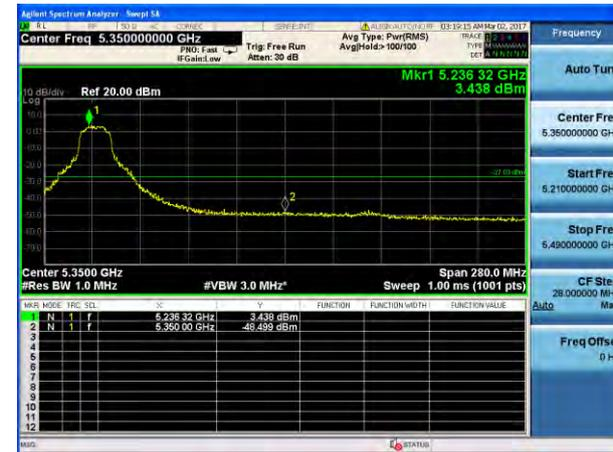

9.SPURIOUS RF CONDUCTED EMISSIONS

9.1 CONFORMANCE LIMIT

1. Below -20dB of the highest emission level in operating band.
2. Fall in the restricted bands listed in section 15.205. The maximum permitted average field strength is listed in section 15.209.

9.2 MEASURING INSTRUMENTS

The Measuring equipment is listed in the section 6.3 of this test report.

9.3 TEST SETUP

Please refer to Section 6.1 of this test report.

9.4 TEST PROCEDURE

The Spurious RF conducted emissions compliance of RF radiated emission should be measured by following the guidance in ANSI C63.10-2013 with respect to maximizing the emission by rotating the EUT, measuring the emission while the EUT is situated in three orthogonal planes (if appropriate), adjusting the measurement antenna height and polarization etc. Set RBW=100kHz and VBW= 300KHz to measure the peak field strength , and mwasure frequeny range from 9KHz to 26.5GHz.

9.5 TEST RESULTS

Remark: The measurement frequency range is from 9KHz to the 10th harmonic of the fundamental frequency. The lowest, middle and highest channels are tested to verify the spurious emissions and bandedge measurement data.

5.2G Test Plot

802.11a on channel 36

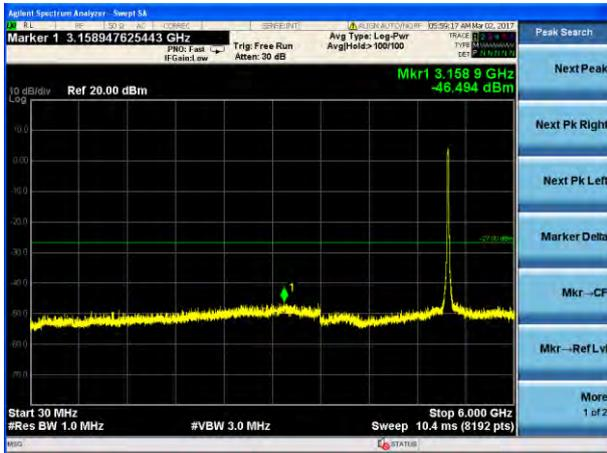

802.11a on channel 40

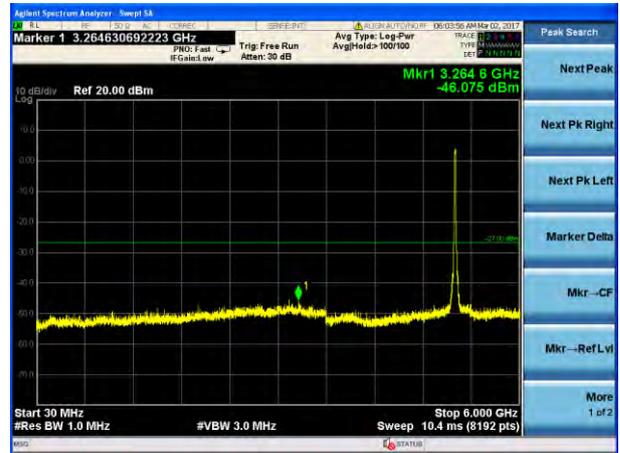

802.11a on channel 36



802.11a on channel 40



Test Plot

802.11a on channel 48

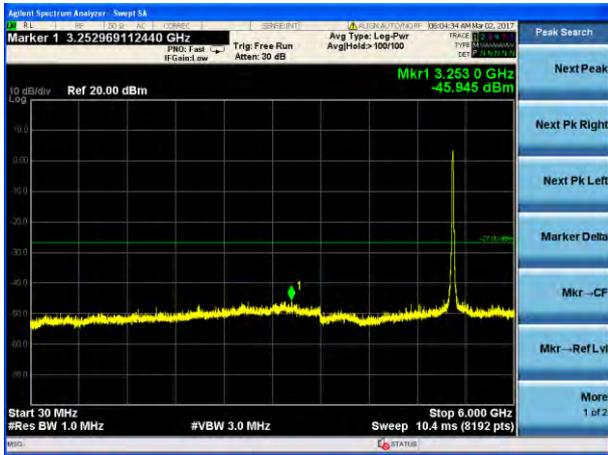

802.11n20 on channel 36

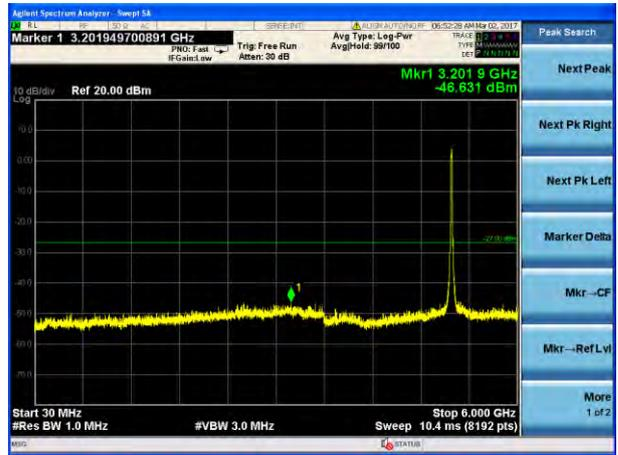

802.11a on channel 48



802.11n20 on channel 36



Test Plot

802.11n20 on channel 40

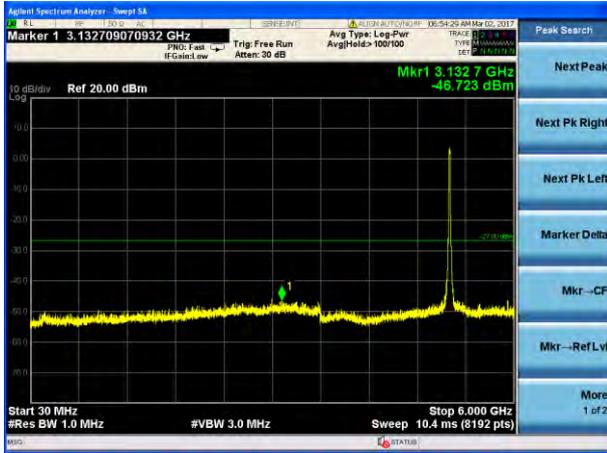

802.11n20 on channel 48

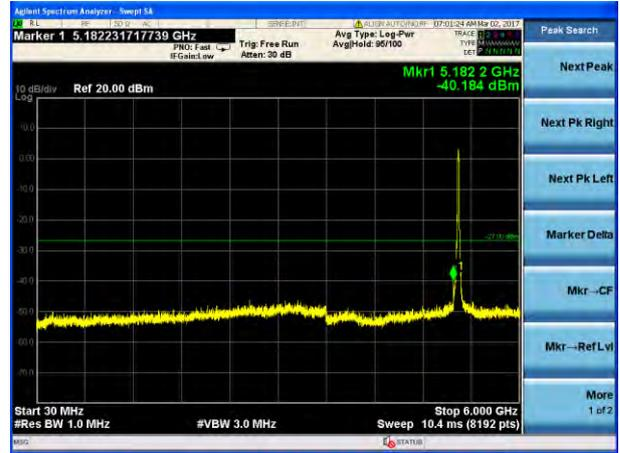

802.11n20 on channel 40



802.11n20 on channel 48



Test Plot

802.11ac20 on channel 36



802.11ac20 on channel 40



802.11ac20 on channel 36



802.11ac20 on channel 40



5.8G Test Plot

802.11a on channel 149

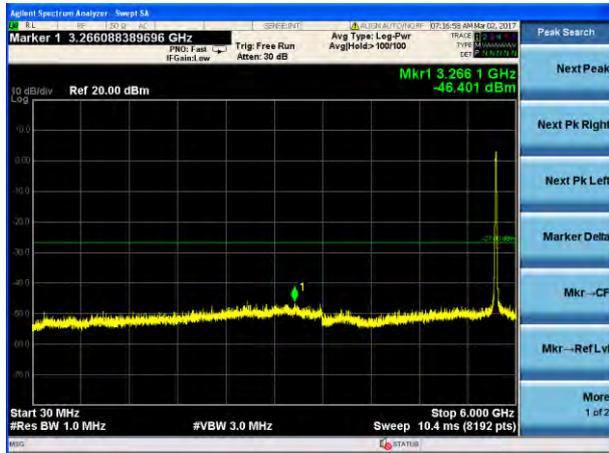

802.11a on channel 157

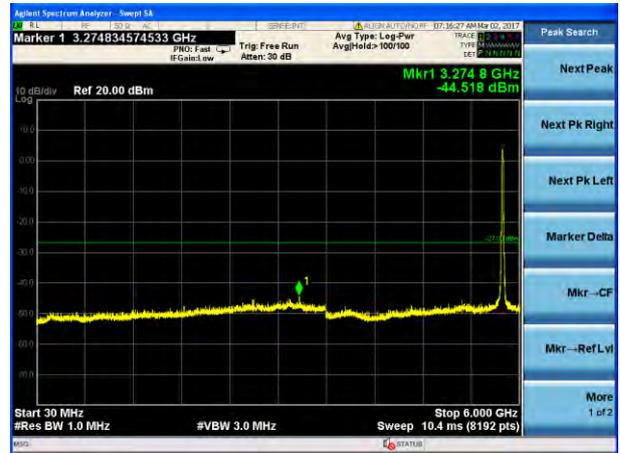

802.11a on channel 149



802.11a on channel 157



Test Plot

802.11a on channel 165

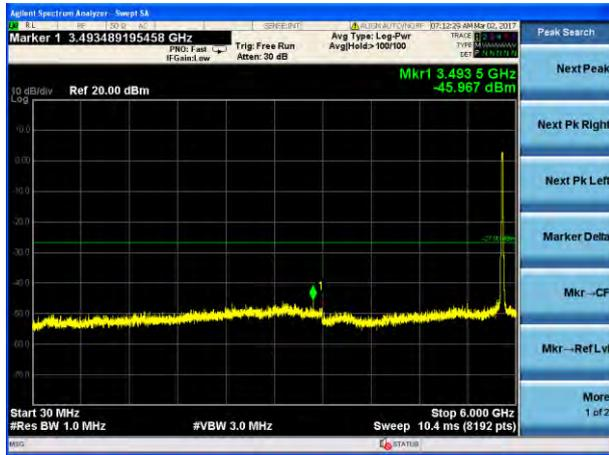

802.11n20 on channel 149

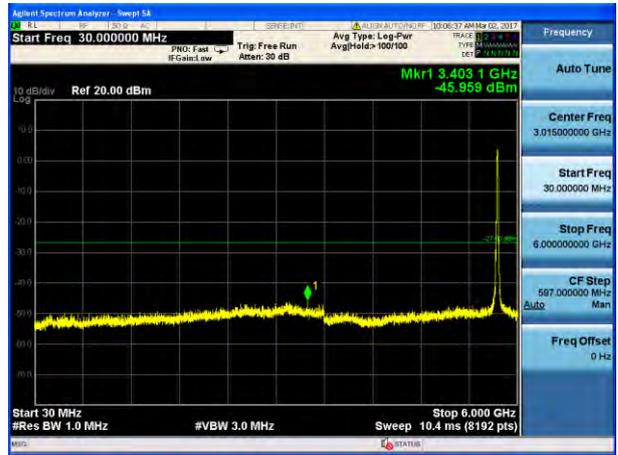

802.11a on channel 165



802.11n20 on channel 149



Test Plot

802.11n20 on channel 157

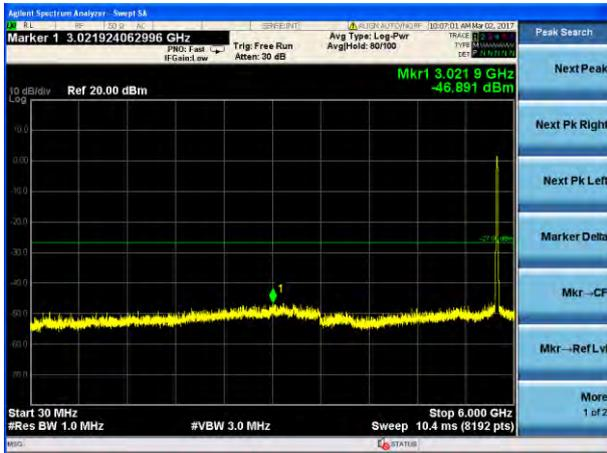

802.11n20 on channel 165

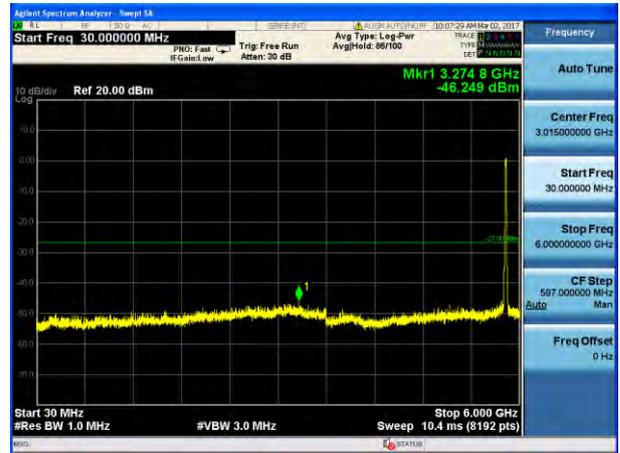

802.11n20 on channel 157



802.11n20 on channel 165



Test Plot

802.11ac40 on channel 159

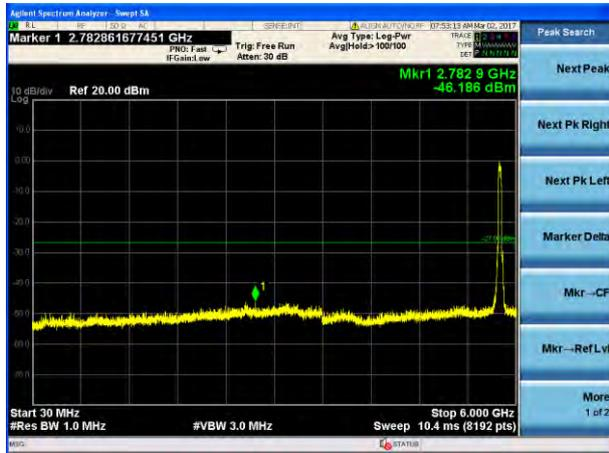

802.11ac80 on channel 155

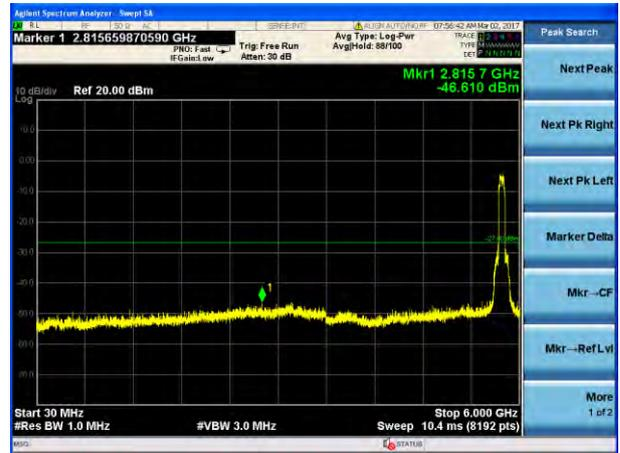

802.11 ac40 on channel 159



802.11 ac80 on channel 155



10. Frequency Stability Measurement

10.1 LIMIT

Manufacturers of U-NII devices are responsible for ensuring frequency stability such that an emission is maintained within the band of operation under all conditions of normal operation as specified in the user's manual.

The transmitter center frequency tolerance shall be ± 20 ppm maximum for the 5 GHz band (IEEE 802.11n specification).

10.2 TEST PROCEDURES

1. The transmitter output (antenna port) was connected to the spectrum analyzer.
2. EUT have transmitted absence of modulation signal and fixed channelize.
3. Set the spectrum analyzer span to view the entire absence of modulation emissions bandwidth.
4. Set RBW = 10 kHz, VBW = 10 kHz with peak detector and maxhold settings.
5. f_c is declaring of channel frequency. Then the frequency error formula is $(f_c - f) / f_c \times 10^6$ ppm and the limit is less than ± 20 ppm (IEEE 802.11n specification).
6. The test extreme voltage is to change the primary supply voltage from 85 to 115 percent of the nominal value
7. Extreme temperature is $-20^\circ\text{C} \sim 70^\circ\text{C}$.

10.3 TEST SETUP LAYOUT

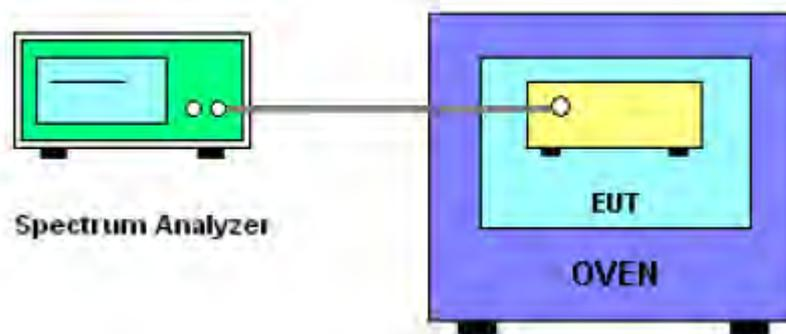

10.4 EUT OPERATION DURING TEST

The EUT was programmed to be in continuously un-modulation transmitting mode.

10.5 TEST RESULTS

EUT :	Tablet projector	Model Name :	Eclipse 1
Temperature :	25 °C	Relative Humidity :	60%
Pressure :	1015 hPa	Test Voltage :	DC 3.7V
Test Mode :	TX Frequency(5150-5250MHz)		

Voltage vs. Frequency Stability

TEST CONDITIONS				Reference Frequency: 5180MHz			
				f	fc	Max. Deviation (MHz)	Max. Deviation (ppm)
T nom (°C)	20	V nom (V)	3.70	5180.01165	5180	0.01165	-2.2490
		V max (V)	4.26	5180.00981	5180	0.00981	-1.8938
		V min (V)	3.15	5180.01171	5180	0.01171	-2.2606
Limits				± 20 ppm			
Result				Complies			

Temperature vs. Frequency Stability

TEST CONDITIONS				Reference Frequency: 5180MHz			
				f	fc	Max. Deviation (MHz)	Max. Deviation (ppm)
V nom (V)	11.4	T (°C)	-20	5180.01068	5180	0.01068	-2.0618
		T (°C)	-10	5180.01065	5180	0.01065	-2.0560
		T (°C)	0	5180.01182	5180	0.01182	-2.2819
		T (°C)	10	5180.01195	5180	0.01195	-2.3069
		T (°C)	20	5180.01172	5180	0.01172	-2.2625
		T (°C)	30	5180.01271	5180	0.01271	-2.4537
		T (°C)	40	5180.01216	5180	0.01216	-2.3475
		T (°C)	50	5180.01224	5180	0.01224	-2.3629
		T (°C)	60	5180.01319	5180	0.01319	-2.5463
		T (°C)	70	5180.01481	5180	0.01481	-2.8591
Limits				± 20 ppm			
Result				Complies			

Voltage vs. Frequency Stability

TEST CONDITIONS				Reference Frequency: 5200MHz			
				f	fc	Max. Deviation (MHz)	Max. Deviation (ppm)
T nom (°C)	20	V nom (V)	3.70	5200.02264	5200	0.02264	-4.3538
		V max (V)	4.26	5200.02165	5200	0.02165	-4.1635
		V min (V)	3.15	5200.02259	5200	0.02259	-4.3442
Limits				± 20 ppm			
Result				Complies			

Temperature vs. Frequency Stability

TEST CONDITIONS				Reference Frequency: 5200MHz			
				f	fc	Max. Deviation (MHz)	Max. Deviation (ppm)
V nom (V)	11.4	T (°C)	-20	5200.00218	5200	0.00218	-0.4192
		T (°C)	-10	5200.00619	5200	0.00619	-1.1904
		T (°C)	0	5200.01658	5200	0.01658	-3.1885
		T (°C)	10	5200.01195	5200	0.01195	-2.2981
		T (°C)	20	5200.01752	5200	0.01752	-3.3692
		T (°C)	30	5200.02116	5200	0.02116	-4.0692
		T (°C)	40	5200.02058	5200	0.02058	-3.9577
		T (°C)	50	5200.02568	5200	0.02568	-4.9385
		T (°C)	60	5200.02273	5200	0.02273	-4.3712
		T (°C)	70	5200.02259	5200	0.02259	-4.3442
Limits				± 20 ppm			

Voltage vs. Frequency Stability

TEST CONDITIONS				Reference Frequency: 5240MHz			
				f	fc	Max. Deviation (MHz)	Max. Deviation (ppm)
T nom (°C)	20	V nom (V)	3.70	5240.00165	5240	0.00165	-0.3149
		V max (V)	4.26	5240.00118	5240	0.00118	-0.2252
		V min (V)	3.15	5240.00681	5240	0.00681	-1.2996
Limits				± 20 ppm			
Result				Complies			

Temperature vs. Frequency Stability

TEST CONDITIONS				Reference Frequency: 5240MHz			
				f	fc	Max. Deviation (MHz)	Max. Deviation (ppm)
V nom (V)	11.4	T (°C)	-20	5240.01182	5240	0.01182	-2.2557
		T (°C)	-10	5240.00367	5240	0.00367	-0.7004
		T (°C)	0	5240.01182	5240	0.01182	-2.2557
		T (°C)	10	5240.01219	5240	0.01219	-2.3263
		T (°C)	20	5240.01167	5240	0.01167	-2.2271
		T (°C)	30	5240.01362	5240	0.01362	-2.5992
		T (°C)	40	5240.01229	5240	0.01229	-2.3454
		T (°C)	50	5240.01215	5240	0.01215	-2.3187
		T (°C)	60	5240.00336	5240	0.00336	-0.6412
		T (°C)	70	5240.01216	5240	0.01216	-2.3206
Limits				± 20 ppm			

EUT :	Tablet projector	Model Name :	Eclipse 1
Temperature :	25 °C	Relative Humidity :	60%
Pressure :	1015 hPa	Test Voltage :	DC 3.7V
Test Mode :	TX Frequency(5745-5850MHz)		

Voltage vs. Frequency Stability

TEST CONDITIONS				Reference Frequency: 5745MHz			
				f	fc	Max. Deviation (MHz)	Max. Deviation (ppm)
T nom (°C)	20	V nom (V)	3.70	5745.01521	5745	0.01521	-2.6475
		V max (V)	4.26	5745.01354	5745	0.01354	-2.3568
		V min (V)	3.15	5745.01472	5745	0.01472	-2.5622
Limits				± 20 ppm			
Result				Complies			

Temperature vs. Frequency Stability

TEST CONDITIONS				Reference Frequency: 5745MHz			
				f	fc	Max. Deviation (MHz)	Max. Deviation (ppm)
V nom (V)	11.4	T (°C)	-20	5745.01225	5745	0.01225	-2.1323
		T (°C)	-10	5745.01143	5745	0.01143	-1.9896
		T (°C)	0	5745.01657	5745	0.01657	-2.8842
		T (°C)	10	5745.01263	5745	0.01263	-2.1984
		T (°C)	20	5745.01551	5745	0.01551	-2.6997
		T (°C)	30	5745.01752	5745	0.01752	-3.0496
		T (°C)	40	5745.01216	5745	0.01216	-2.1166
		T (°C)	50	5745.01627	5745	0.01627	-2.8320
		T (°C)	60	5745.01323	5745	0.01323	-2.3029
		T (°C)	70	5745.01742	5745	0.01742	-3.0322
Limits				± 20 ppm			
Result				Complies			

Voltage vs. Frequency Stability

TEST CONDITIONS				Reference Frequency: 5785MHz			
				f	fc	Max. Deviation (MHz)	Max. Deviation (ppm)
T nom (°C)	20	V nom (V)	3.70	5785.02517	5785	0.02517	-4.3509
		V max (V)	4.26	5785.03052	5785	0.03052	-5.2757
		V min (V)	3.15	5785.02945	5785	0.02945	-5.0908
Limits				± 20 ppm			
Result				Complies			

Temperature vs. Frequency Stability

TEST CONDITIONS				Reference Frequency: 5785MHz			
				f	fc	Max. Deviation (MHz)	Max. Deviation (ppm)
V nom (V)	11.4	T (°C)	-20	5785.01218	5785	0.01218	-2.1054
		T (°C)	-10	5785.01619	5785	0.01619	-2.7986
		T (°C)	0	5785.01625	5785	0.01625	-2.8090
		T (°C)	10	5785.01192	5785	0.01192	-2.0605
		T (°C)	20	5785.01714	5785	0.01714	-2.9628
		T (°C)	30	5785.01757	5785	0.01757	-3.0372
		T (°C)	40	5785.01645	5785	0.01645	-2.8436
		T (°C)	50	5785.01847	5785	0.01847	-3.1927
		T (°C)	60	5785.01959	5785	0.01959	-3.3863
		T (°C)	70	5785.01856	5785	0.01856	-3.2083
Limits				± 20 ppm			
Result				Complies			

Voltage vs. Frequency Stability

TEST CONDITIONS				Reference Frequency: 5825MHz			
				f	fc	Max. Deviation (MHz)	Max. Deviation (ppm)
T nom (°C)	20	V nom (V)	3.70	5825.01853	5825	0.01853	-3.1811
		V max (V)	4.26	5825.01285	5825	0.01285	-2.2060
		V min (V)	3.15	5825.01346	5825	0.01346	-2.3107
Limits				± 20 ppm			
Result				Complies			

Temperature vs. Frequency Stability

TEST CONDITIONS				Reference Frequency: 5825MHz			
				f	fc	Max. Deviation (MHz)	Max. Deviation (ppm)
V nom (V)	11.4	T (°C)	-20	5825.01458	5825	0.01458	-2.5030
		T (°C)	-10	5825.01552	5825	0.01552	-2.6644
		T (°C)	0	5825.01182	5825	0.01182	-2.0292
		T (°C)	10	5825.01263	5825	0.01263	-2.1682
		T (°C)	20	5825.01127	5825	0.01127	-1.9348
		T (°C)	30	5825.01362	5825	0.01362	-2.3382
		T (°C)	40	5825.01229	5825	0.01229	-2.1099
		T (°C)	50	5825.01263	5825	0.01263	-2.1682
		T (°C)	60	5825.01334	5825	0.01334	-2.2901
		T (°C)	70	5825.01216	5825	0.01216	-2.0876
Limits				± 20 ppm			
Result				Complies			

11. ANTENNA REQUIREMENT

11.1 STANDARD REQUIREMENT

15.203 requirement: For intentional device, according to 15.203: an intentional radiator shall be designed to ensure that no antenna other than that furnished by the responsible party shall be used with the device.

11.2 EUT ANTENNA

The EUT antenna is permanent attached FPCB antenna. It comply with the standard requirement.

END OF REPORT