

## 7.4. Output Power Measurement

### 7.4.1. Test Limit

#### For FCC Output Power Measurement Limit

For an outdoor access point operating in the band 5.15-5.25 GHz, the maximum conducted output power over the frequency band of operation shall not exceed 1 W provided the maximum antenna gain does not exceed 6 dBi.

For the band 5.725-5.85 GHz, the maximum conducted output power over the frequency band of operation shall not exceed 1 W (30dBm).

If transmitting antennas of directional gain greater than 6dBi are used, the maximum conducted output power shall be reduced by the amount in dB that the directional gain of the antenna exceeds 6dBi.

#### For IC Output Power Measurement Limit

For the band 5.15-5.25 GHz, the maximum e.i.r.p. shall not exceed 200 mW (23.01dBm) or  $10 + 10 \log_{10} B$ , dBm, whichever power is less. B is the 99% emission bandwidth in MHz.

For the 5.725-5.85 GHz band, the maximum conducted output power shall not exceed 1 W.

If transmitting antennas of directional gain greater than 6dBi are used, the maximum conducted output power shall be reduced by the amount in dB that the directional gain of the antenna exceeds 6dBi.

#### IC EIRP Limit Calculation as below:

For 5150-5250MHz

802.11a:  $10 + 10 \log_{10} (18.63\text{MHz}) = 22.14\text{dBm} < 23.01\text{dBm}$ ;

802.11n-HT20:  $10 + 10 \log_{10} (18.75\text{MHz}) = 22.45\text{dBm} < 23.01\text{dBm}$ ;

802.11ac-VHT20:  $10 + 10 \log_{10} (18.76\text{MHz}) = 22.45\text{dBm} < 23.01\text{dBm}$ ;

802.11n-HT40/ac-VHT40/ac-VHT80:  $10 + 10 \log_{10} B > 23.01\text{dBm}$ ;

#### 7.4.2. Test Procedure Used

KDB 789033 D02v02r01- Section E)3)b) Method PM-G

#### 7.4.3. Test Setting

Average power measurements were performed only when the EUT was transmitting at its maximum power control level using a broadband power meter with a pulse sensor. The power meter implemented triggering and gating capabilities which were set up such that power measurements were recorded only during the ON time of the transmitter.

#### 7.4.4. Test Setup



### 7.4.5. Test Result

Power output test was verified over all data rates of each mode shown as below table, and then choose the maximum power output (gray marker) for final test of each channel.

Test Mode	Bandwidth	Channel	Frequency (MHz)	Data Rate/ MCS	Average Power (dBm)
802.11a	20	36	5180	6Mbps	13.66
				24Mbps	13.58
				54Mbps	13.49
802.11n	20	36	5180	MCS0	14.10
				MCS3	13.92
				MCS7	13.86
802.11n	40	38	5190	MCS0	15.64
				MCS3	15.57
				MCS7	15.49
802.11ac	20	36	5180	MCS0	13.94
				MCS4	13.87
				MCS8	13.74
802.11ac	40	38	5190	MCS0	15.60
				MCS4	15.52
				MCS9	15.49
802.11ac	80	42	5210	MCS0	15.13
				MCS4	15.05
				MCS9	14.92



Product	Cassia	Temperature	24°C
Test Engineer	Hunk Li	Relative Humidity	59%
Test Site	SR2	Test Date	2017/11/26
Test Item	FCC Output Power Test		

Test Mode	Data Rate/ MCS	Channel No.	Freq. (MHz)	Average Power (dBm)	Average Power Limit (dBm)	Result
11a	6Mbps	36	5180	13.66	≤ 29.40	Pass
11a	6Mbps	44	5220	13.82	≤ 29.40	Pass
11a	6Mbps	48	5240	14.02	≤ 29.40	Pass
11a	6Mbps	149	5745	15.30	≤ 28.70	Pass
11a	6Mbps	157	5785	15.78	≤ 28.70	Pass
11a	6Mbps	165	5825	15.17	≤ 28.70	Pass
11n-HT20	MCS0	36	5180	14.10	≤ 29.40	Pass
11n-HT20	MCS0	44	5220	14.10	≤ 29.40	Pass
11n-HT20	MCS0	48	5240	14.22	≤ 29.40	Pass
11n-HT20	MCS0	149	5745	15.15	≤ 28.70	Pass
11n-HT20	MCS0	157	5785	15.45	≤ 28.70	Pass
11n-HT20	MCS0	165	5825	15.46	≤ 28.70	Pass
11n-HT40	MCS0	38	5190	15.64	≤ 29.40	Pass
11n-HT40	MCS0	46	5230	15.57	≤ 29.40	Pass
11n-HT40	MCS0	151	5755	15.59	≤ 28.70	Pass
11n-HT40	MCS0	159	5795	15.69	≤ 28.70	Pass
11ac-VHT20	MCS0	36	5180	13.94	≤ 29.40	Pass
11ac-VHT20	MCS0	44	5220	14.17	≤ 29.40	Pass
11ac-VHT20	MCS0	48	5240	14.26	≤ 29.40	Pass
11ac-VHT20	MCS0	149	5745	15.17	≤ 28.70	Pass
11ac-VHT20	MCS0	157	5785	15.56	≤ 28.70	Pass
11ac-VHT20	MCS0	165	5825	15.42	≤ 28.70	Pass
11ac-VHT40	MCS0	38	5190	15.60	≤ 29.40	Pass
11ac-VHT40	MCS0	46	5230	14.97	≤ 29.40	Pass
11ac-VHT40	MCS0	151	5755	15.81	≤ 28.70	Pass
11ac-VHT40	MCS0	159	5795	15.26	≤ 28.70	Pass
11ac-VHT80	MCS0	42	5210	15.13	≤ 29.40	Pass
11ac-VHT80	MCS0	155	5775	15.04	≤ 28.70	Pass

Note: For UNII-1 band, the limit (dBm) = 30 dBm – (6.6 dBi – 6.0 dBi) = 29.4 dBm.

For UNII-3 band, the limit (dBm) = 30 dBm – (7.3 dBi – 6.0 dBi) = 28.7 dBm.



Product	Cassia	Temperature	24°C
Test Engineer	Hunk Li	Relative Humidity	59%
Test Site	SR2	Test Date	2017/11/26
Test Item	IC Output Power Test		

Test Mode	Data Rate/ MCS	Channel No.	Freq. (MHz)	Average Power (dBm)	Limit (dBm)	EIRP (dBm)	EIRP Limit (dBm)	Result
11a	6Mbps	36	5180	13.66	--	20.26	≤ 22.70	Pass
11a	6Mbps	44	5220	13.82	--	20.42	≤ 22.70	Pass
11a	6Mbps	48	5240	14.02	--	20.62	≤ 22.70	Pass
11a	6Mbps	149	5745	15.30	≤ 28.70	--	--	Pass
11a	6Mbps	157	5785	15.78	≤ 28.70	--	--	Pass
11a	6Mbps	165	5825	15.17	≤ 28.70	--	--	Pass
11n-HT20	MCS0	36	5180	14.10	--	20.70	≤ 22.73	Pass
11n-HT20	MCS0	44	5220	14.10	--	20.70	≤ 22.73	Pass
11n-HT20	MCS0	48	5240	14.22	--	20.82	≤ 22.73	Pass
11n-HT20	MCS0	149	5745	15.15	≤ 28.70	--	--	Pass
11n-HT20	MCS0	157	5785	15.45	≤ 28.70	--	--	Pass
11n-HT20	MCS0	165	5825	15.46	≤ 28.70	--	--	Pass
11n-HT40	MCS0	38	5190	15.64	--	22.24	≤ 23.01	Pass
11n-HT40	MCS0	46	5230	15.57	--	22.17	≤ 23.01	Pass
11n-HT40	MCS0	151	5755	15.59	≤ 28.70	--	--	Pass
11n-HT40	MCS0	159	5795	15.69	≤ 28.70	--	--	Pass
11ac-VHT20	MCS0	36	5180	13.94	--	20.54	≤ 22.73	Pass
11ac-VHT20	MCS0	44	5220	14.17	--	20.77	≤ 22.73	Pass
11ac-VHT20	MCS0	48	5240	14.26	--	20.86	≤ 22.73	Pass
11ac-VHT20	MCS0	149	5745	15.17	≤ 28.70	--	--	Pass
11ac-VHT20	MCS0	157	5785	15.56	≤ 28.70	--	--	Pass
11ac-VHT20	MCS0	165	5825	15.42	≤ 28.70	--	--	Pass
11ac-VHT40	MCS0	38	5190	15.60	--	22.20	≤ 23.01	Pass
11ac-VHT40	MCS0	46	5230	14.97	--	21.57	≤ 23.01	Pass
11ac-VHT40	MCS0	151	5755	15.81	≤ 28.70	--	--	Pass
11ac-VHT40	MCS0	159	5795	15.26	≤ 28.70	--	--	Pass
11ac-VHT80	MCS0	42	5210	15.13	--	21.73	≤ 23.01	Pass
11ac-VHT80	MCS0	155	5775	15.04	≤ 28.70	--	--	Pass

Note: For UNII-3 band, the limit (dBm) = 30 dBm – (7.3 dBi – 6.0 dBi) = 28.7 dBm.

## 7.5. Transmit Power Control

### 7.5.1. Test Limit

The U-NII device is required to have the capability to operate at least 6 dB below the mean EIRP value of 30 dBm.

### 7.5.2. Test Procedure Used

KDB 789033 D02v02r01- Section E)3)b) Method PM-G

### 7.5.3. Test Setting

Average power measurements were performed only when the EUT was transmitting at its maximum power control level using a broadband power meter with a pulse sensor. The power meter implemented triggering and gating capabilities which were set up such that power measurements were recorded only during the ON time of the transmitter.

### 7.5.4. Test Setup

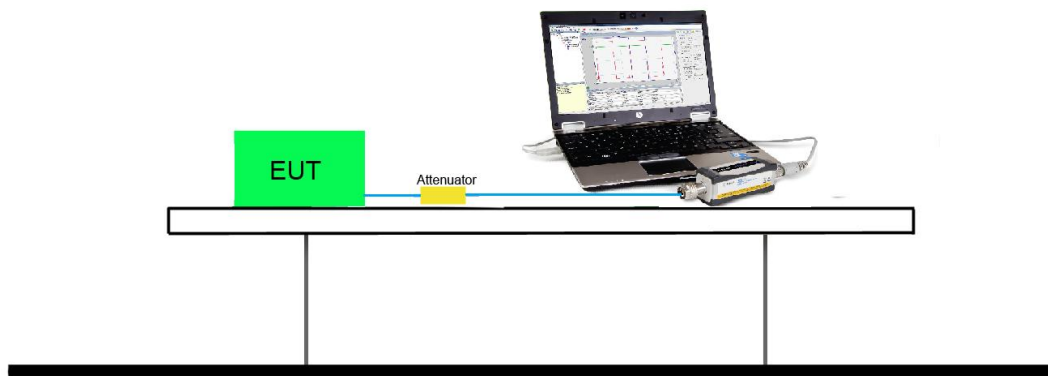

### 7.5.5. Test Result

U-NII devices operating in the 5.15-5.25 GHz band and the 5.725-5.85 GHz band have no requirement for a TPC mechanism.

## **7.6. Power Spectral Density Measurement**

### **7.6.1. Test Limit**

#### **For FCC Power Spectral Density Measurement Limit**

For an outdoor access point operating in the band 5.15-5.25 GHz, the maximum power spectral density shall not exceed 17 dBm in any 1 megahertz band.

For the band 5.725-5.85 GHz, the maximum power spectral density shall not exceed 30 dBm in any 500-kHz band.

If transmitting antennas of directional gain greater than 6dBi are used, the peak power spectral density shall be reduced by the amount in dB that the directional gain of the antenna exceeds 6dBi.

#### **For IC Power Spectral Density Measurement Limit**

For the band 5.15-5.25 GHz, the e.i.r.p. spectral density shall not exceed 10 dBm in any 1.0 MHz band.

For the 5.725-5.85 GHz band, the power spectral density shall not exceed 30 dBm in any 500 kHz band. If transmitting antennas of directional gain greater than 6dBi are used, the peak power spectral density shall be reduced by the amount in dB that the directional gain of the antenna exceeds 6dBi.

### **7.6.2. Test Procedure Used**

KDB 789033 D02v02r01 – Section F

### **7.6.3. Test Setting**

1. Analyzer was set to the center frequency of the UNII channel under investigation
2. Span was set to encompass the entire 26dB EBW of the signal.
3. RBW = 1MHz, if measurement bandwidth of Maximum PSD is specified in 500 kHz,  
RBW = 100 kHz
4. VBW = 3MHz
5. Number of sweep points  $\geq 2 \times (\text{span} / \text{RBW})$
6. Detector = power averaging (Average)
7. Sweep time = auto
8. Trigger = free run
9. Use the peak search function on the instrument to find the peak of the spectrum and record its value.
10. Add  $10 \cdot \log(1/x)$ , where x is the duty cycle, to the measured power in order to compute the

average power during the actual transmission times (because the measurement represents an average over both the on and off times of the transmission). For example, add  $10 \cdot \log(1/0.25) = 6$  dB if the duty cycle is 25 percent.

11. When the measurement bandwidth of Maximum PSD is specified in 500 kHz, add a constant factor  $10 \cdot \log(500\text{kHz}/100\text{kHz}) = 6.99$  dB to the measured result.

#### 7.6.4. Test Setup

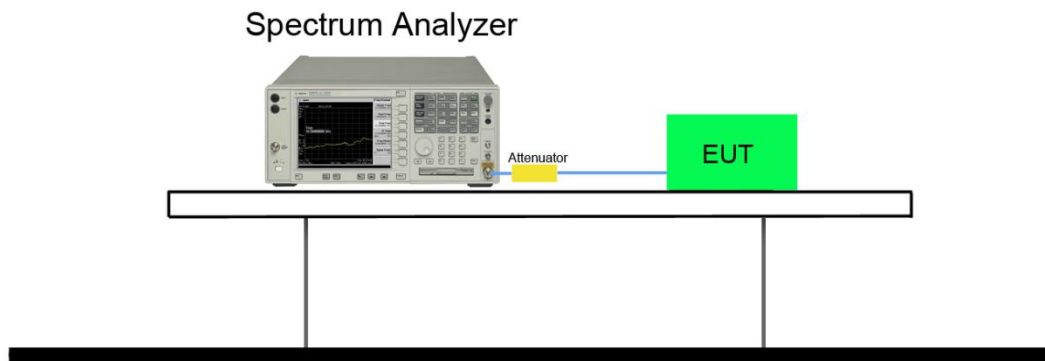



**7.6.5. Test Result**

Product	Cassia	Temperature	22°C
Test Engineer	Will Yan	Relative Humidity	54%
Test Site	TR3	Test Date	2017/12/10
Test Item	Power Spectral Dencity (For FCC & IC bands UNII-1)		

Test Mode	Data Rate/MCS	Channel No.	Freq. (MHz)	PSD (dBm/MHz)	Duty Cycle (%)	Final PSD (dBm/MHz)	Final PSD Limit (dBm/MHz)	EIRP PSD (dBm/MHz)	EIRP PSD Limit (dBm/MHz)	Result
11a	6Mbps	36	5180	2.43	93.07	2.74	≤ 16.40	9.34	≤ 10.00	Pass
11a	6Mbps	44	5220	2.53	93.07	2.84	≤ 16.40	9.44	≤ 10.00	Pass
11a	6Mbps	48	5240	2.73	93.07	3.04	≤ 16.40	9.64	≤ 10.00	Pass
11n-HT20	MCS0	36	5180	2.58	92.22	2.93	≤ 16.40	9.53	≤ 10.00	Pass
11n-HT20	MCS0	44	5220	2.31	92.22	2.66	≤ 16.40	9.26	≤ 10.00	Pass
11n-HT20	MCS0	48	5240	2.90	92.22	3.25	≤ 16.40	9.85	≤ 10.00	Pass
11n-HT40	MCS0	38	5190	-3.10	89.86	-2.64	≤ 16.40	3.96	≤ 10.00	Pass
11n-HT40	MCS0	46	5230	-3.81	89.86	-3.35	≤ 16.40	3.25	≤ 10.00	Pass
11ac-VHT20	MCS0	36	5180	2.30	92.61	2.63	≤ 16.40	9.23	≤ 10.00	Pass
11ac-VHT20	MCS0	44	5220	2.76	92.61	3.09	≤ 16.40	9.69	≤ 10.00	Pass
11ac-VHT20	MCS0	48	5240	2.64	92.61	2.97	≤ 16.40	9.57	≤ 10.00	Pass
11ac-VHT40	MCS0	38	5190	1.12	85.86	1.78	≤ 16.40	8.38	≤ 10.00	Pass
11ac-VHT40	MCS0	46	5230	0.14	85.86	0.81	≤ 16.40	7.41	≤ 10.00	Pass
11ac-VHT80	MCS0	42	5210	0.42	76.24	1.60	≤ 16.40	8.20	≤ 10.00	Pass

Note 1: When EUT duty cycle < 98%, the Final PSD (dBm/MHz) = PSD (dBm/MHz) + 10\*log(1/Duty Cycle).

Note 2: EIRP PSD (dBm/MHz) = Final PSD (dBm/MHz) + Antenna Gain (dBi).

Note 3: Conducted PSD Limit (dBm/MHz) = 17 (dBm/MHz) – (6.6 dBi – 6.0 dBi) = 16.4 (dBm/MHz).

Product	Cassia	Temperature	22°C
Test Engineer	Will Yan	Relative Humidity	54%
Test Site	TR3	Test Date	2017/12/10
Test Item	Power Spectral Density (FCC and IC UNII-Band 3)		

Test Mode	Data Rate/MCS	Channel No.	Freq. (MHz)	PSD (dBm/100KHz)	Duty Cycle (%)	Constant Factor	Final PSD (dBm/MHz)	PSD Limit (dBm/MHz)	Result
11a	6Mbps	149	5745	-4.28	93.07	6.99	3.02	≤ 28.70	Pass
11a	6Mbps	157	5785	-4.21	93.07	6.99	3.09	≤ 28.70	Pass
11a	6Mbps	165	5825	-3.88	93.07	6.99	3.42	≤ 28.70	Pass
11n-HT20	MCS0	149	5745	-4.58	92.22	6.99	2.76	≤ 28.70	Pass
11n-HT20	MCS0	157	5785	-4.26	92.22	6.99	3.08	≤ 28.70	Pass
11n-HT20	MCS0	165	5825	-4.64	92.22	6.99	2.70	≤ 28.70	Pass
11n-HT40	MCS0	151	5755	-9.77	89.86	6.99	-2.32	≤ 28.70	Pass
11n-HT40	MCS0	159	5795	-11.24	89.86	6.99	-3.79	≤ 28.70	Pass
11ac-VHT20	MCS0	149	5745	-4.85	92.61	6.99	2.47	≤ 28.70	Pass
11ac-VHT20	MCS0	157	5785	-4.08	92.61	6.99	3.24	≤ 28.70	Pass
11ac-VHT20	MCS0	165	5825	-4.67	92.61	6.99	2.65	≤ 28.70	Pass
11ac-VHT40	MCS0	151	5755	-8.21	85.86	6.99	-0.56	≤ 28.70	Pass
11ac-VHT40	MCS0	159	5795	-7.74	85.86	6.99	-0.09	≤ 28.70	Pass
11ac-VHT80	MCS0	155	5775	-14.07	76.24	6.99	-5.90	≤ 28.70	Pass

Note 1: When EUT duty cycle < 98%, the Final PSD (dBm/MHz) = PSD (dBm/100k Hz) + 10\*log(1/Duty Cycle) + Constant Factor.

Note 2: Conducted PSD Limit (dBm/MHz) = 30 (dBm/MHz) – (7.3 dBi – 6.0 dBi) = 28.7 (dBm/MHz).

### 802.11a Power Spectral Density

**Channel 36 (5180MHz)**

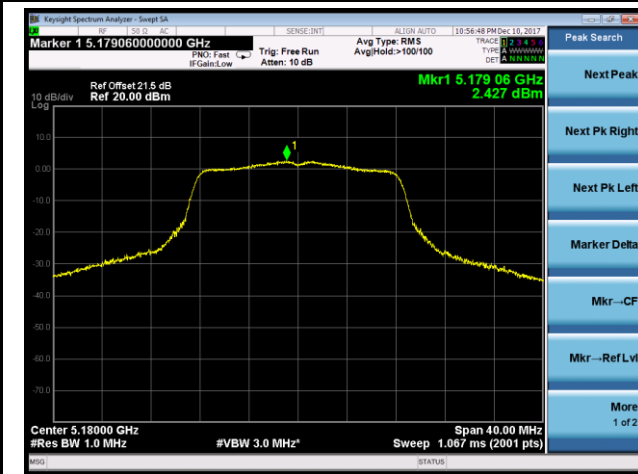

**Channel 44 (5220MHz)**

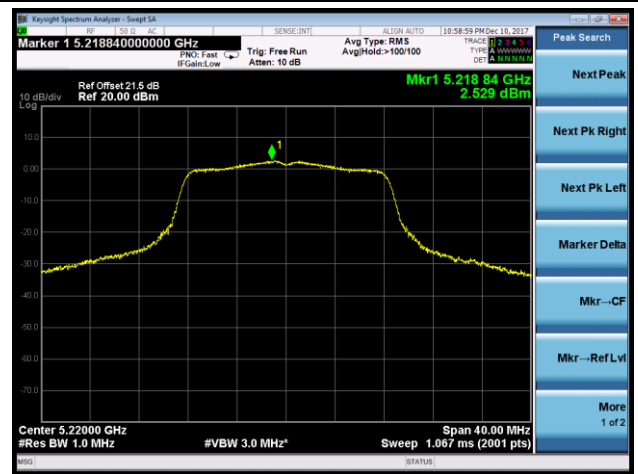

**Channel 48 (5240MHz)**

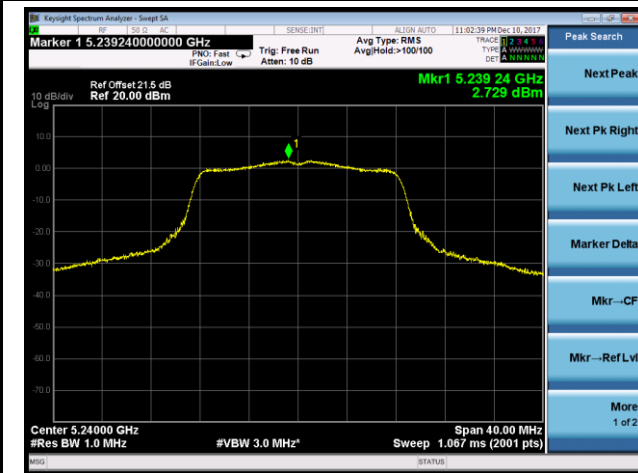

**Channel 149 (5745MHz)**

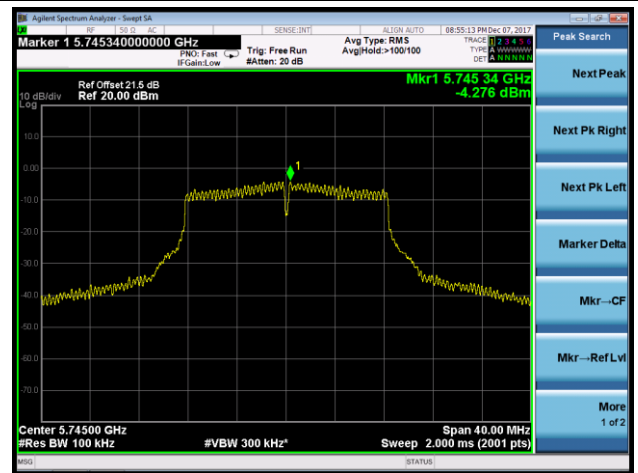

**Channel 157 (5785MHz)**

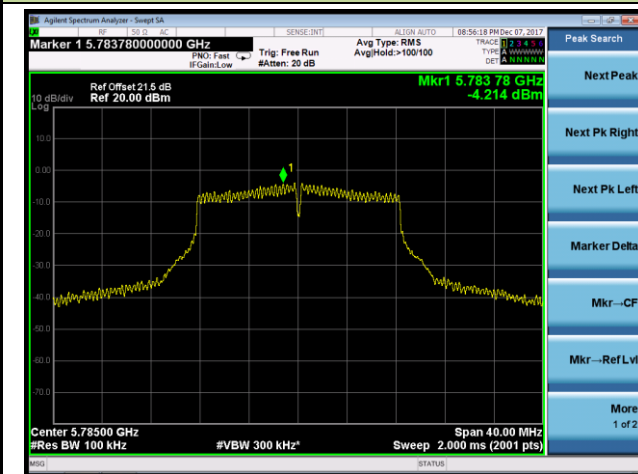

**Channel 165 (5825MHz)**

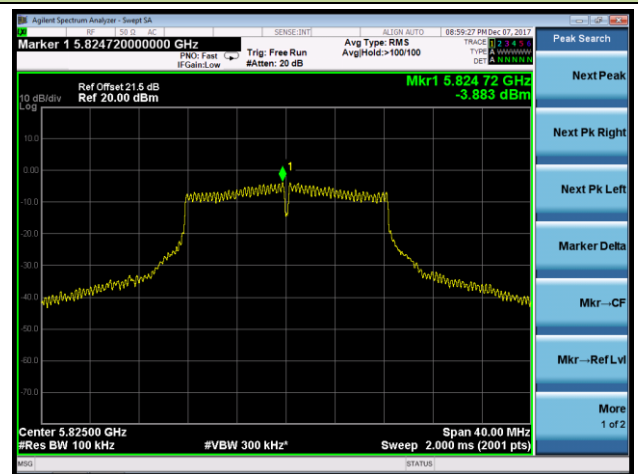

### 802.11n-HT20 Power Spectral Density

**Channel 36 (5180MHz)**

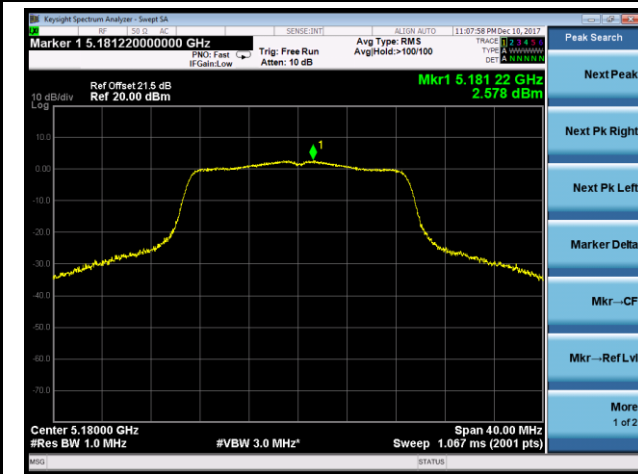

**Channel 44 (5220MHz)**

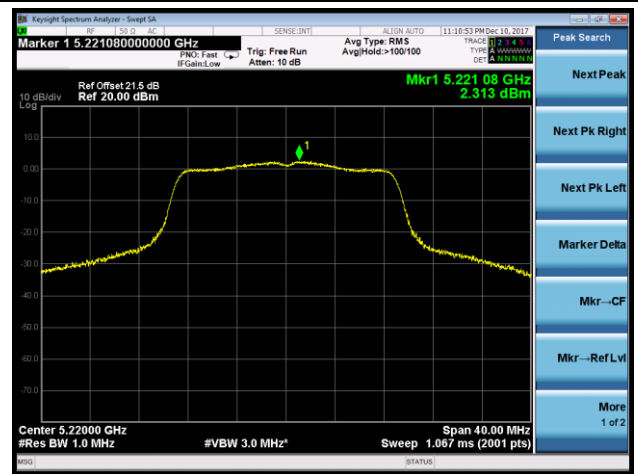

**Channel 48 (5240MHz)**

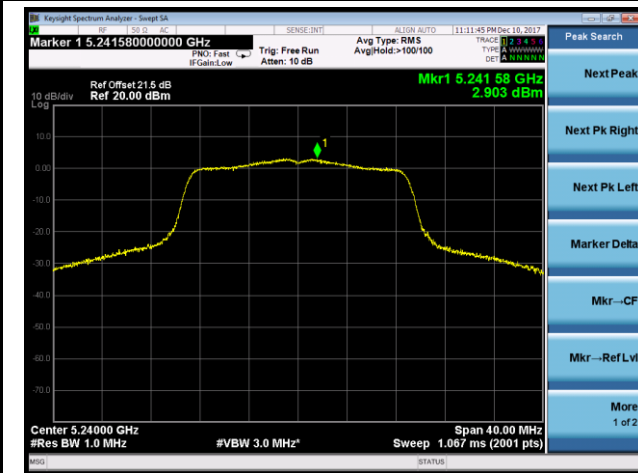

**Channel 149 (5745MHz)**

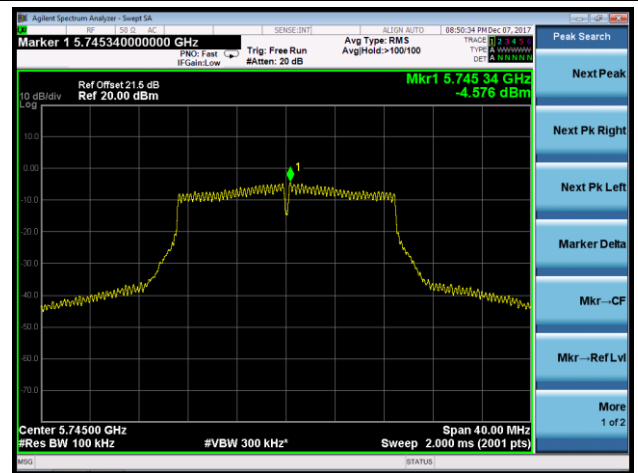

**Channel 157 (5785MHz)**

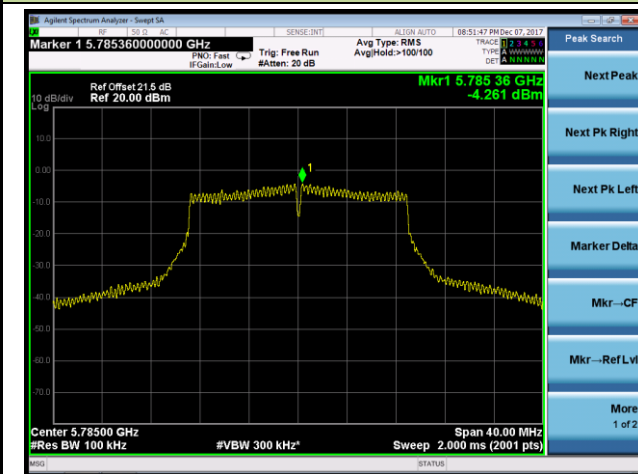

**Channel 165 (5825MHz)**

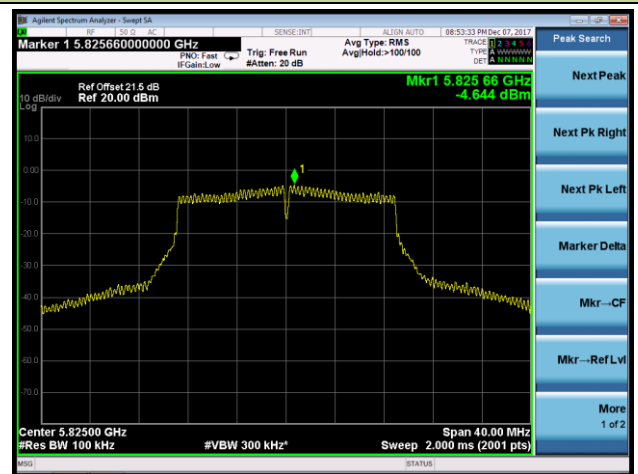

### 802.11n-HT40 Power Spectral Density

**Channel 38 (5190MHz)**

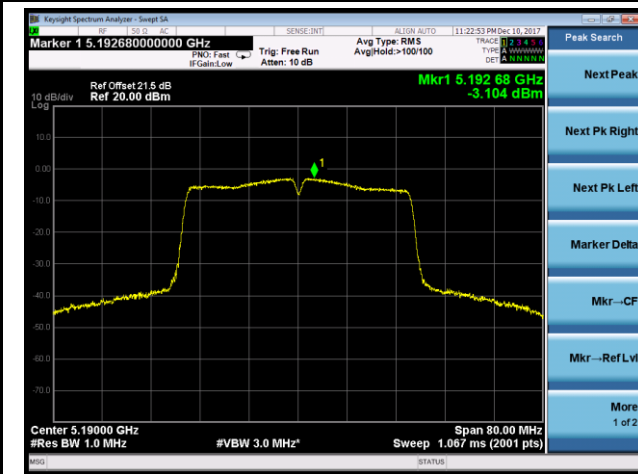

**Channel 46 (5230MHz)**

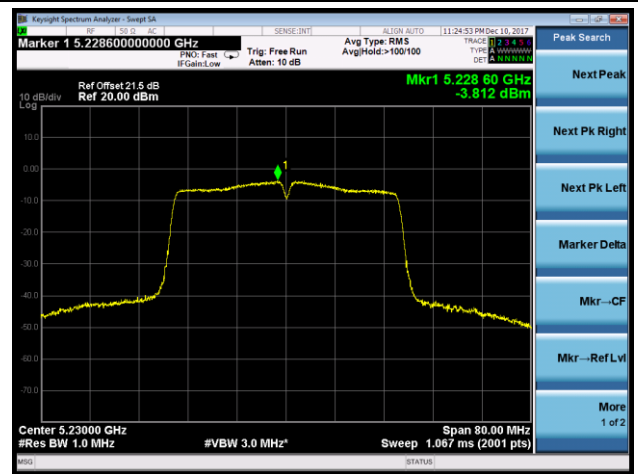

**Channel 151 (5755MHz)**

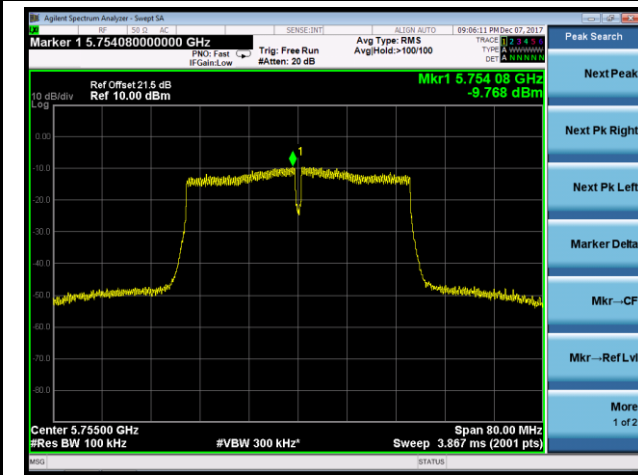

**Channel 159 (5795MHz)**

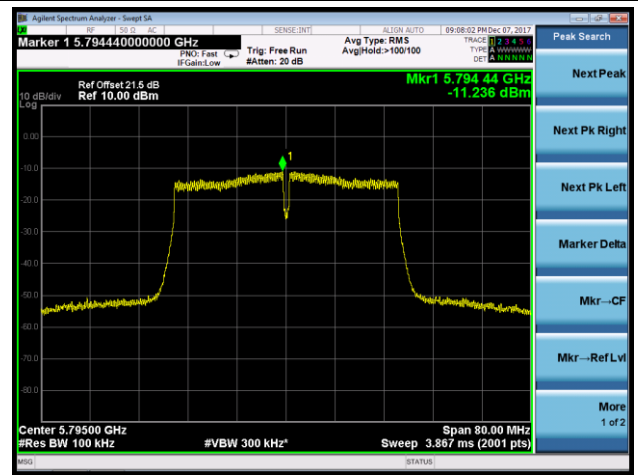

### 802.11ac-VHT20 Power Spectral Density

**Channel 36 (5180MHz)**

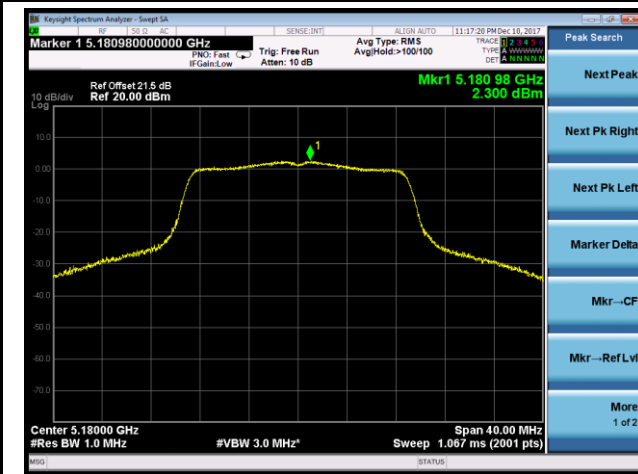

**Channel 44 (5220MHz)**

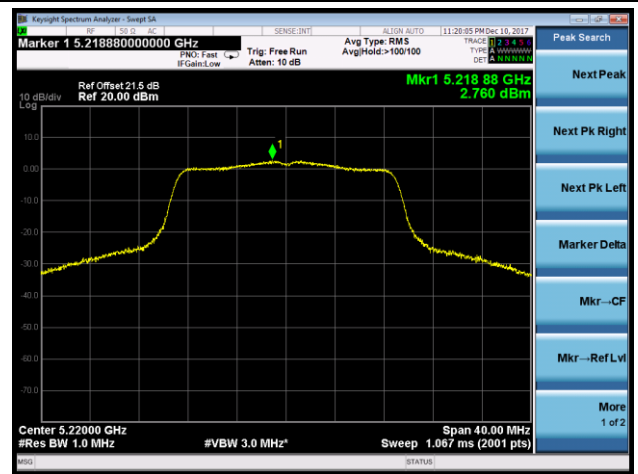

**Channel 48 (5240MHz)**

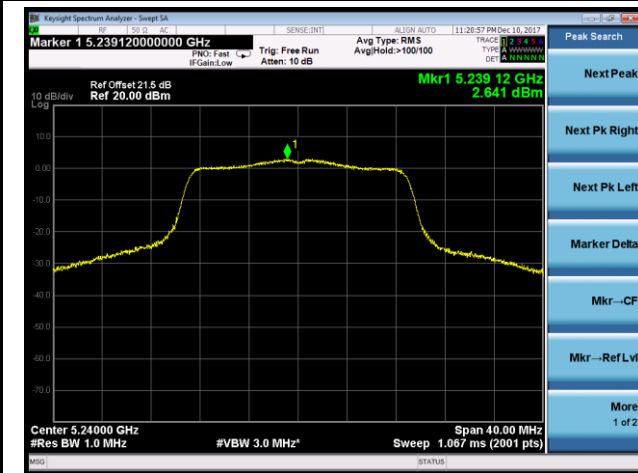

**Channel 149 (5745MHz)**



**Channel 157 (5785MHz)**

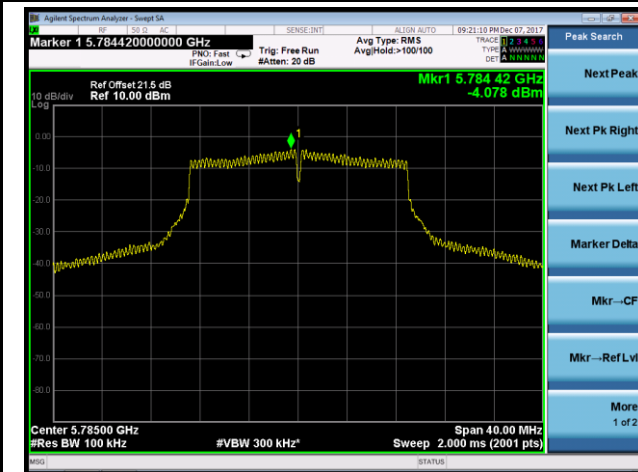

**Channel 165 (5825MHz)**



### 802.11ac-VHT40 Power Spectral Density

**Channel 38 (5190MHz)**

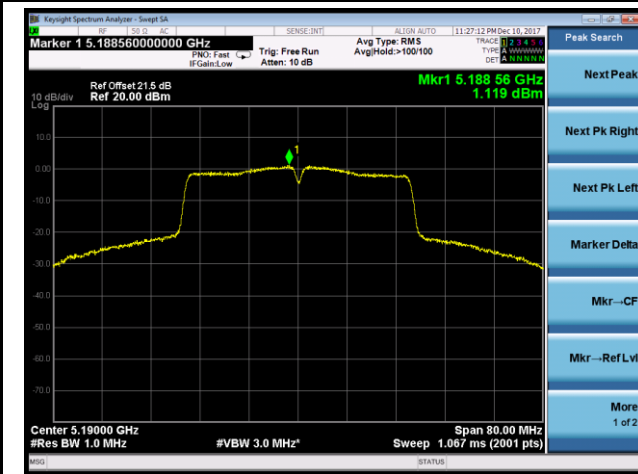

**Channel 46 (5230MHz)**

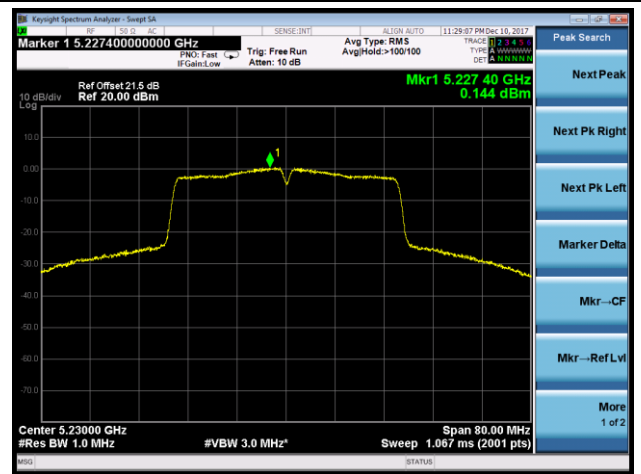

**Channel 151 (5755MHz)**

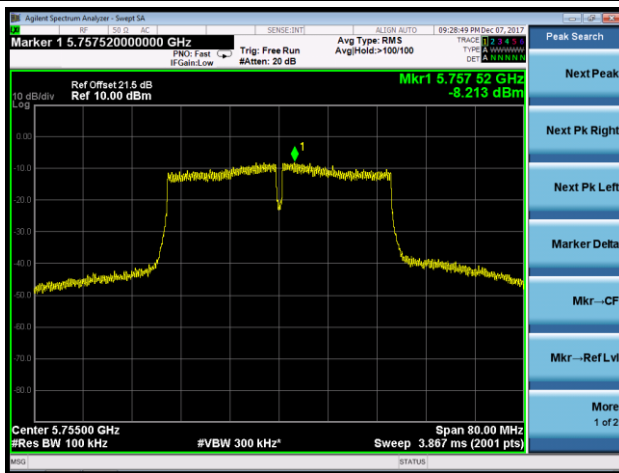

**Channel 159 (5795MHz)**

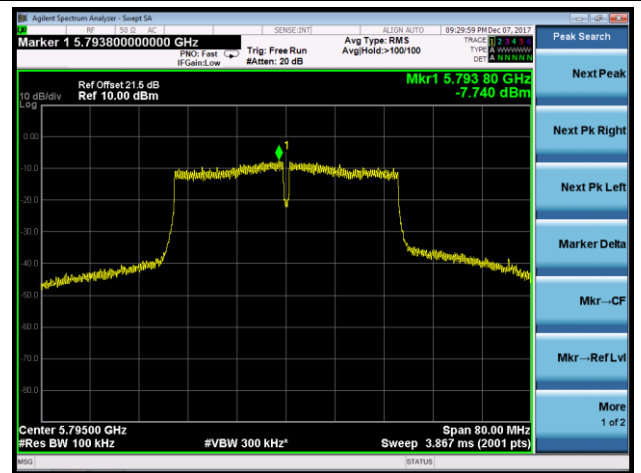

### 802.11ac-VHT80 Power Spectral Density

**Channel 42 (5210MHz)**

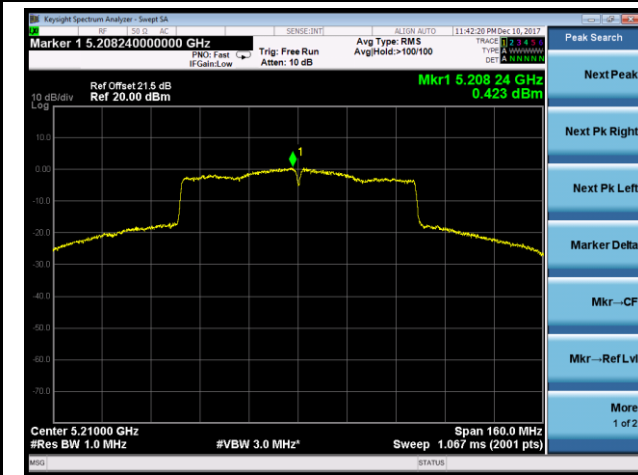

**Channel 155 (5775MHz)**



## **7.7. Frequency Stability Measurement**

### **7.7.1. Test Limit**

Manufactures of U-NII devices are responsible for ensuring frequency stability such that an emission is maintained within the band of operation under all conditions of normal operation as specified in the user's manual.

The transmitter center frequency tolerance shall be  $\pm 20$  ppm maximum for the 5GHz band (IEEE 802.11 specification).

### **7.7.2. Test Procedure Used**

#### **Frequency Stability Under Temperature Variations:**

The equipment under test was connected to an external AC or DC power supply and input rated voltage. RF output was connected to a frequency counter or spectrum analyzer via feed through attenuators. The EUT was placed inside the temperature chamber. Set the spectrum analyzer RBW low enough to obtain the desired frequency resolution and measure EUT 20°C operating frequency as reference frequency. Turn EUT off and set the chamber temperature to highest. After the temperature stabilized for approximately 30 minutes recorded the frequency. Repeat step measure with 10°C decreased per stage until the lowest temperature reached.

#### **Frequency Stability Under Voltage Variations:**

Set chamber temperature to 20°C. Use a variable AC power supply / DC power source to power the EUT and set the voltage to rated voltage. Set the spectrum analyzer RBW low enough to obtain the desired frequency resolution and recorded the frequency.

Reduce the input voltage to specify extreme voltage variation ( $\pm 15\%$ ) and endpoint, record the maximum frequency change.



### 7.7.3. Test Setup

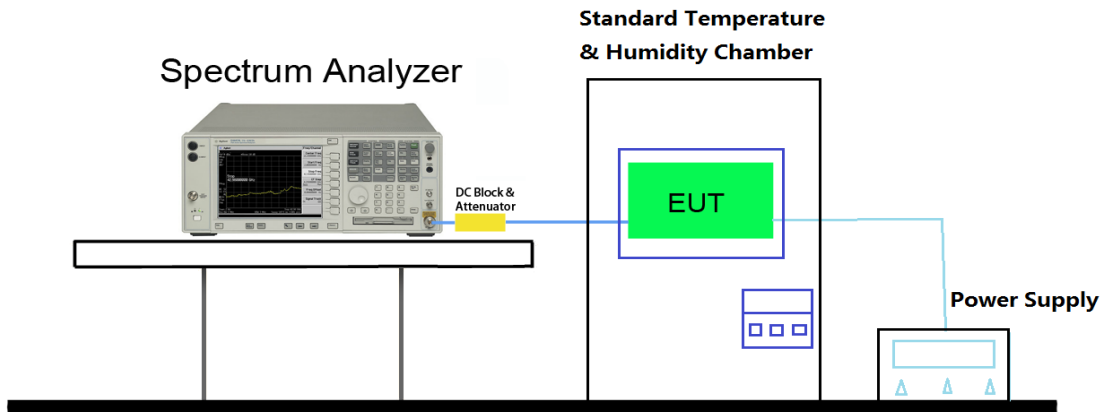

**7.7.4. Test Result**

Test Engineer	Hunk Li	Temperature	-30 ~ 50°C
Test Time	2017/11/28	Relative Humidity	48 ~ 55%RH
Test Mode	5180MHz (Carrier Mode)	Test Site	SR2

Voltage (%)	Power (VAC)	Temp (°C)	Frequency Tolerance (ppm)			
			0 minutes	2 minutes	5 minutes	10 minutes
100%	120	- 30	-6.92	-3.55	-5.14	-6.18
		- 20	-3.86	-4.07	-5.18	-5.83
		- 10	-3.85	-5.24	-5.44	-6.06
		0	-5.03	-5.43	-6.98	-6.00
		+ 10	-5.41	-5.71	-7.25	-7.20
		+ 20 (Ref)	-5.93	-6.25	-7.41	-8.44
		+ 30	-6.68	-7.51	-8.12	-8.35
		+ 40	-6.85	-7.58	-8.48	-9.30
		+ 50	-6.91	-8.21	-8.35	-8.90
115%	138	+ 20	-6.78	-6.70	-8.84	-8.76
85%	102	+ 20	-4.83	-6.15	-7.53	-8.96

Note: Frequency Tolerance (ppm) =  $\{[\text{Measured Frequency (Hz)} - \text{Declared Frequency (Hz)}] / \text{Declared Frequency (Hz)}\} * 10^6$ .

## 7.8. Radiated Spurious Emission Measurement

### 7.8.1. Test Limit

All out of band emissions appearing in a restricted band as specified in Section 8.10 of the RSS-Gen Issue 4 must not exceed the limits shown in Table per Section 8.9.

RSS-Gen Issue4 Section 8.9		
Frequency [MHz]	Field Strength [V/m]	Measured Distance [Meters]
0.009 - 0.490	2400/F (kHz)	300
0.490 - 1.705	24000/F (kHz)	30
1.705 - 30	30	30
30 - 88	100	3
88 - 216	150	3
216 - 960	200	3
Above 960	500	3

### 7.8.2. Test Procedure Used

ANSI C63.10 Section 6.3 (General Requirements)

ANSI C63.10 Section 6.4 (Standard test method below 30MHz)

ANSI C63.10 Section 6.5 (Standard test method above 30MHz to 1GHz)

ANSI C63.10 Section 6.6 (Standard test method above 1GHz)

### 7.8.3. Test Setting

Table 1 - RBW as a function of frequency

Frequency	RBW
9 ~ 150 kHz	200 ~ 300 Hz
0.15 ~ 30 MHz	9 ~ 10 kHz
30 ~ 1000 MHz	100 ~ 120 kHz

**Quasi-Peak Measurements below 1GHz**

1. Analyzer center frequency was set to the frequency of the radiated spurious emission of interest
2. Span was set greater than 1MHz
3. RBW = as specified in Table 1
4. Detector = CISPR quasi-peak
5. Sweep time = auto couple
6. Trace was allowed to stabilize

**Peak Measurements above 1GHz**

1. Analyzer center frequency was set to the frequency of the radiated spurious emission of interest
2. RBW = 1MHz
3. VBW = 3MHz
4. Detector = peak
5. Sweep time = auto couple
6. Trace mode = max hold
7. Trace was allowed to stabilize

**Average Measurements above 1GHz (Method VB)**

1. Analyzer center frequency was set to the frequency of the radiated spurious emission of interest
2. RBW = 1MHz
3. VBW; If the EUT is configured to transmit with duty cycle  $\geq 98\%$ , set VBW = 10 Hz. If the EUT duty cycle is  $< 98\%$ , set  $VBW \geq 1/T$ . T is the minimum transmission duration.
4. Detector = Peak
5. Sweep time = auto
6. Trace mode = max hold
7. Trace was allowed to stabilize

### 7.8.4. Test Setup

#### 9kHz ~30MHz Test Setup:

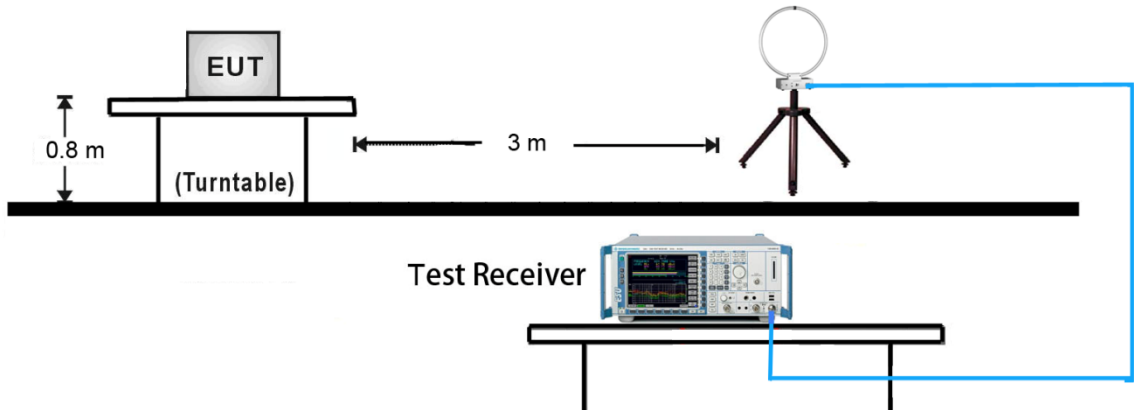

#### 30MHz ~ 1GHz Test Setup:

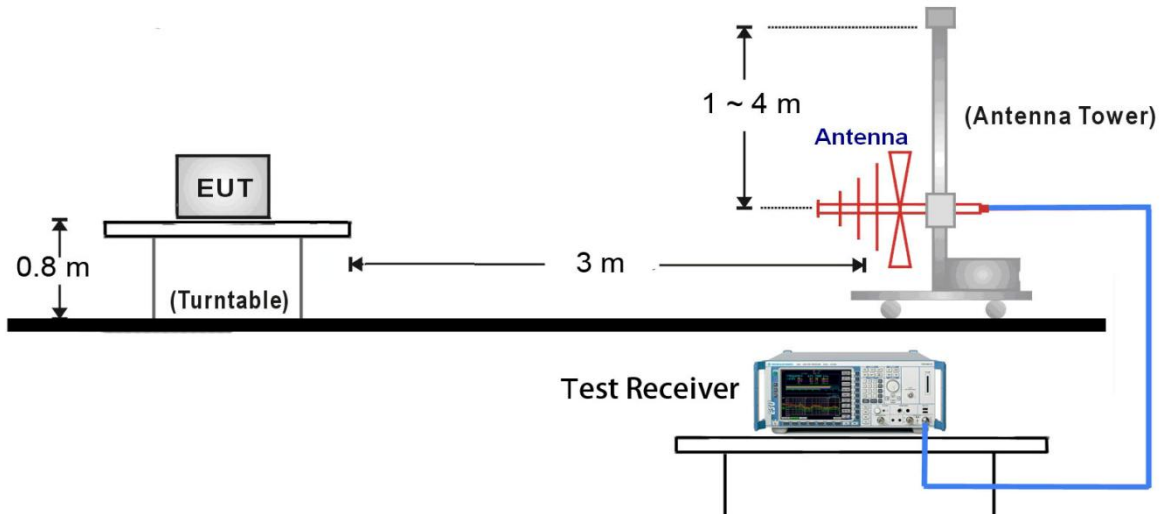

1GHz ~18GHz Test Setup:

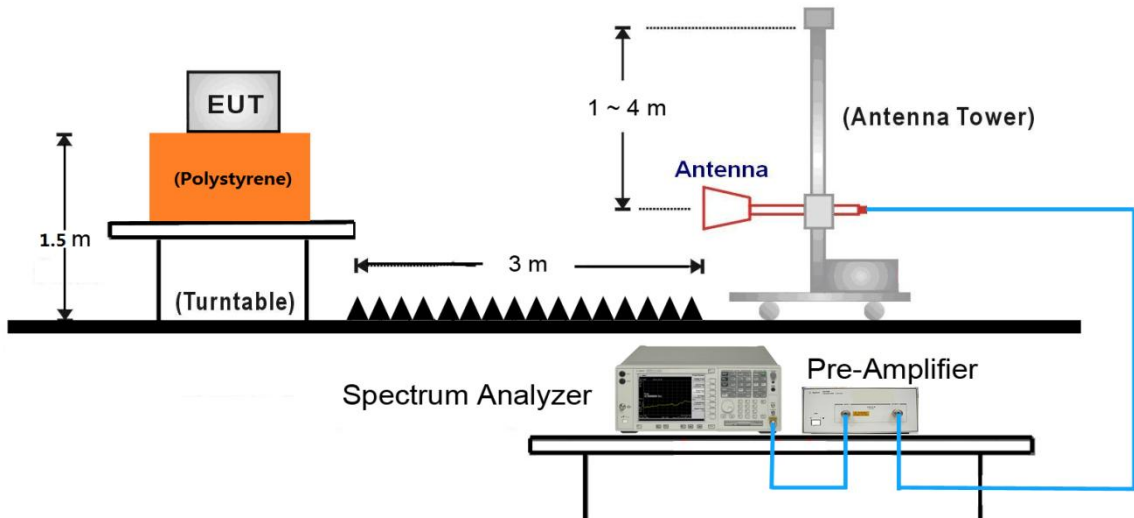

18GHz ~40GHz Test Setup:

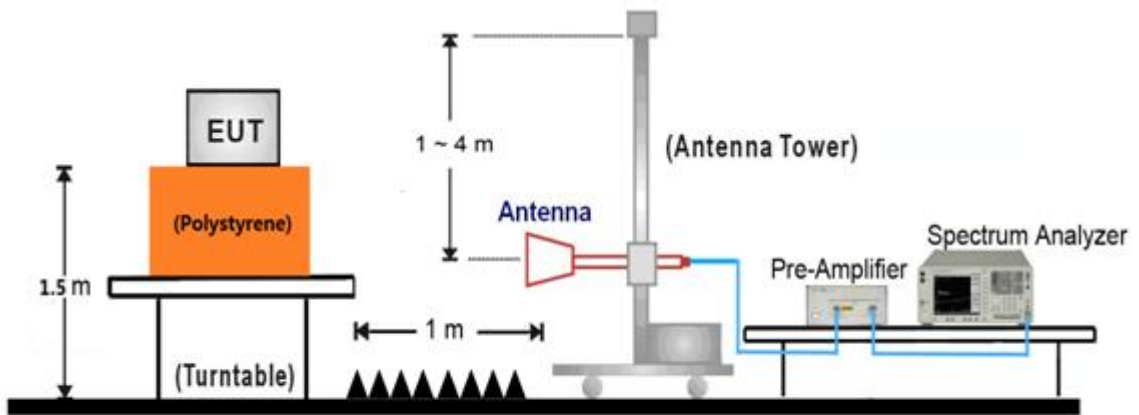

**7.8.5. Test Result**

Product	Cassia	Temperature	26°C
Test Engineer	Snake Ni	Relative Humidity	57 %
Test Site	AC1	Test Date	2017/11/30
Test Mode:	802.11a	Test Channel:	36
Remark:	1. Average measurement was not performed if peak level lower than average limit. 2. Other frequency was 20dB below limit line within 1-18GHz, there is not show in the report.		

Mark	Frequency (MHz)	Reading Level (dBμV)	Factor (dB)	Measure Level (dBμV/m)	Limit (dBμV/m)	Margin (dB)	Detector	Polarization
	7365.6	33.3	7.9	41.2	74.0	-32.8	Peak	Horizontal
*	8946.5	33.5	9.0	42.5	68.2	-25.7	Peak	Horizontal
	9473.8	32.1	10.5	42.6	74.0	-31.4	Peak	Horizontal
*	12762.6	32.9	11.7	44.6	68.2	-23.6	Peak	Horizontal
	7485.4	34.3	8.2	42.5	74.0	-31.5	Peak	Vertical
*	8864.6	33.1	9.1	42.2	68.2	-26.0	Peak	Vertical
	9472.6	33.1	10.5	43.6	74.0	-30.4	Peak	Vertical
*	12715.3	33.0	11.7	44.7	68.2	-23.5	Peak	Vertical

Note 1: "\*" is not in restricted band, its limit is -27dBm/MHz. At a distance of 3 meters, the field strength limit in dBμV/m can be determined by adding a "conversion" factor of 95.2dB to the EIRP limit of -27dBm/MHz to obtain the limit for out of band spurious emissions.

Note 2: Measure Level (dBμV/m) = Reading Level (dBμV) + Factor (dB)

Factor (dB) = Cable Loss (dB) + Antenna Factor (dB/m) - Pre\_Amplifier Gain (dB)

Product	Cassia	Temperature	26°C
Test Engineer	Snake Ni	Relative Humidity	57 %
Test Site	AC1	Test Date	2017/11/30
Test Mode:	802.11a	Test Channel:	44
Remark:	1. Average measurement was not performed if peak level lower than average limit. 2. Other frequency was 20dB below limit line within 1-18GHz, there is not show in the report.		

Mark	Frequency (MHz)	Reading Level (dBμV)	Factor (dB)	Measure Level (dBμV/m)	Limit (dBμV/m)	Margin (dB)	Detector	Polarization
	7648.6	33.7	8.0	41.7	74.0	-32.3	Peak	Horizontal
*	8679.8	33.9	9.0	42.9	68.2	-25.3	Peak	Horizontal
	9416.6	32.8	10.6	43.4	74.0	-30.6	Peak	Horizontal
*	12762.6	32.9	11.7	44.6	68.2	-23.6	Peak	Horizontal
	7349.9	33.2	8.0	41.2	74.0	-32.8	Peak	Vertical
*	8653.1	34.2	8.8	43.0	68.2	-25.2	Peak	Vertical
	9463.9	32.7	10.5	43.2	74.0	-30.8	Peak	Vertical
*	12865.6	33.8	12.0	45.8	68.2	-22.4	Peak	Vertical

Note 1: "\*" is not in restricted band, its limit is -27dBm/MHz. At a distance of 3 meters, the field strength limit in dBμV/m can be determined by adding a "conversion" factor of 95.2dB to the EIRP limit of -27dBm/MHz to obtain the limit for out of band spurious emissions.

Note 2: Measure Level (dBμV/m) = Reading Level (dBμV) + Factor (dB)

Factor (dB) = Cable Loss (dB) + Antenna Factor (dB/m) - Pre\_Amplifier Gain (dB)



Product	Cassia	Temperature	26°C
Test Engineer	Snake Ni	Relative Humidity	57 %
Test Site	AC1	Test Date	2017/11/30
Test Mode:	802.11a	Test Channel:	48
Remark:	1. Average measurement was not performed if peak level lower than average limit. 2. Other frequency was 20dB below limit line within 1-18GHz, there is not show in the report.		

Mark	Frequency (MHz)	Reading Level (dBμV)	Factor (dB)	Measure Level (dBμV/m)	Limit (dBμV/m)	Margin (dB)	Detector	Polarization
	7625.6	33.5	8.0	41.5	74.0	-32.5	Peak	Horizontal
*	8643.3	33.3	8.8	42.1	68.2	-26.1	Peak	Horizontal
	9152.6	33.9	9.8	43.7	74.0	-30.3	Peak	Horizontal
*	12746.8	33.8	11.7	45.5	68.2	-22.7	Peak	Horizontal
	7346.2	33.3	8.0	41.3	74.0	-32.7	Peak	Vertical
*	8643.3	33.6	8.8	42.4	68.2	-25.8	Peak	Vertical
	9152.6	33.1	9.8	42.9	74.0	-31.1	Peak	Vertical
*	12715.6	32.5	11.7	44.2	68.2	-24.0	Peak	Vertical

Note 1: "\*" is not in restricted band, its limit is -27dBm/MHz. At a distance of 3 meters, the field strength limit in dBμV/m can be determined by adding a "conversion" factor of 95.2dB to the EIRP limit of -27dBm/MHz to obtain the limit for out of band spurious emissions.

Note 2: Measure Level (dBμV/m) = Reading Level (dBμV) + Factor (dB)

Factor (dB) = Cable Loss (dB) + Antenna Factor (dB/m) - Pre\_Amplifier Gain (dB)

Product	Cassia	Temperature	26°C
Test Engineer	Snake Ni	Relative Humidity	57 %
Test Site	AC1	Test Date	2017/11/30
Test Mode:	802.11a	Test Channel:	149
Remark:	1. Average measurement was not performed if peak level lower than average limit. 2. Other frequency was 20dB below limit line within 1-18GHz, there is not show in the report.		

Mark	Frequency (MHz)	Reading Level (dBμV)	Factor (dB)	Measure Level (dBμV/m)	Limit (dBμV/m)	Margin (dB)	Detector	Polarization
	7684.2	34.0	8.0	42.0	74.0	-32.0	Peak	Horizontal
*	8642.6	34.0	8.8	42.8	68.2	-25.4	Peak	Horizontal
	11525.6	32.7	12.7	45.4	74.0	-28.6	Peak	Horizontal
*	17235.0	38.5	15.9	54.4	68.2	-13.8	Peak	Horizontal
	7494.6	32.8	8.2	41.0	74.0	-33.0	Peak	Vertical
*	8643.3	33.3	8.8	42.1	68.2	-26.1	Peak	Vertical
	9473.7	32.5	10.5	43.0	74.0	-31.0	Peak	Vertical
*	12748.6	32.5	11.7	44.2	68.2	-24.0	Peak	Vertical

Note 1: "\*" is not in restricted band, its limit is -27dBm/MHz or -17dBm/MHz. At a distance of 3 meters, the field strength limit in dBμV/m can be determined by adding a "conversion" factor of 95.2dB to the EIRP limit of -27dBm/MHz to obtain the limit for out of band spurious emissions.

Note 2: Measure Level (dBμV/m) = Reading Level (dBμV) + Factor (dB)

Factor (dB) = Cable Loss (dB) + Antenna Factor (dB/m) - Pre\_Amplifier Gain (dB)

Product	Cassia	Temperature	26°C
Test Engineer	Snake Ni	Relative Humidity	57 %
Test Site	AC1	Test Date	2017/11/30
Test Mode:	802.11a	Test Channel:	157
Remark:	1. Average measurement was not performed if peak level lower than average limit. 2. Other frequency was 20dB below limit line within 1-18GHz, there is not show in the report.		

Mark	Frequency (MHz)	Reading Level (dBμV)	Factor (dB)	Measure Level (dBμV/m)	Limit (dBμV/m)	Margin (dB)	Detector	Polarization
	7625.4	33.6	8.0	41.6	74.0	-32.4	Peak	Horizontal
*	8643.7	33.4	8.8	42.2	68.2	-26.0	Peak	Horizontal
	9425.8	33.8	10.6	44.4	74.0	-29.6	Peak	Horizontal
*	12745.4	33.3	11.7	45.0	68.2	-23.2	Peak	Horizontal
	7695.6	34.5	8.0	42.5	74.0	-31.5	Peak	Vertical
*	9246.4	32.5	10.2	42.7	68.2	-25.5	Peak	Vertical
	11453.3	33.0	12.7	45.7	74.0	-28.3	Peak	Vertical
*	12746.6	32.8	11.7	44.5	68.2	-23.7	Peak	Vertical

Note 1: "\*" is not in restricted band, its limit is -27dBm/MHz or -17dBm/MHz. At a distance of 3 meters, the field strength limit in dBμV/m can be determined by adding a "conversion" factor of 95.2dB to the EIRP limit of -27dBm/MHz to obtain the limit for out of band spurious emissions.

Note 2: Measure Level (dBμV/m) = Reading Level (dBμV) + Factor (dB)

Factor (dB) = Cable Loss (dB) + Antenna Factor (dB/m) - Pre\_Amplifier Gain (dB)

Product	Cassia	Temperature	26°C
Test Engineer	Snake Ni	Relative Humidity	57 %
Test Site	AC1	Test Date	2017/11/30
Test Mode:	802.11a	Test Channel:	165
Remark:	1. Average measurement was not performed if peak level lower than average limit. 2. Other frequency was 20dB below limit line within 1-18GHz, there is not show in the report.		

Mark	Frequency (MHz)	Reading Level (dBμV)	Factor (dB)	Measure Level (dBμV/m)	Limit (dBμV/m)	Margin (dB)	Detector	Polarization
	7645.3	32.7	8.0	40.7	74.0	-33.3	Peak	Horizontal
*	8645.3	33.2	8.8	42.0	68.2	-26.2	Peak	Horizontal
	11425.6	32.4	12.6	45.0	74.0	-29.0	Peak	Horizontal
*	12745.7	32.4	11.7	44.1	68.2	-24.1	Peak	Horizontal
	7652.3	32.6	8.0	40.6	74.0	-33.4	Peak	Vertical
*	9274.6	32.8	10.3	43.1	68.2	-25.1	Peak	Vertical
	11523.7	32.7	12.7	45.4	74.0	-28.6	Peak	Vertical
*	12745.4	32.7	11.7	44.4	68.2	-23.8	Peak	Vertical

Note 1: "\*" is not in restricted band, its limit is -27dBm/MHz or -17dBm/MHz. At a distance of 3 meters, the field strength limit in dBμV/m can be determined by adding a "conversion" factor of 95.2dB to the EIRP limit of -27dBm/MHz to obtain the limit for out of band spurious emissions.

Note 2: Measure Level (dBμV/m) = Reading Level (dBμV) + Factor (dB)

Factor (dB) = Cable Loss (dB) + Antenna Factor (dB/m) - Pre\_Amplifier Gain (dB)

Product	Cassia	Temperature	26°C
Test Engineer	Snake Ni	Relative Humidity	57 %
Test Site	AC1	Test Date	2017/11/30
Test Mode:	802.11n-HT20	Test Channel:	36
Remark:	1. Average measurement was not performed if peak level lower than average limit. 2. Other frequency was 20dB below limit line within 1-18GHz, there is not show in the report.		

Mark	Frequency (MHz)	Reading Level (dBμV)	Factor (dB)	Measure Level (dBμV/m)	Limit (dBμV/m)	Margin (dB)	Detector	Polarization
	7642.6	32.9	8.0	40.9	74.0	-33.1	Peak	Horizontal
*	9253.7	31.8	10.2	42.0	68.2	-26.2	Peak	Horizontal
	11527.9	32.7	12.7	45.4	74.0	-28.6	Peak	Horizontal
*	12763.7	32.4	11.7	44.1	68.2	-24.1	Peak	Horizontal
	7642.4	33.4	8.0	41.4	74.0	-32.6	Peak	Vertical
*	8642.4	33.2	8.8	42.0	68.2	-26.2	Peak	Vertical
	9472.3	32.6	10.5	43.1	74.0	-30.9	Peak	Vertical
*	12715.4	33.1	11.7	44.8	68.2	-23.4	Peak	Vertical

Note 1: "\*" is not in restricted band, its limit is -27dBm/MHz. At a distance of 3 meters, the field strength limit in dBμV/m can be determined by adding a "conversion" factor of 95.2dB to the EIRP limit of -27dBm/MHz to obtain the limit for out of band spurious emissions.

Note 2: Measure Level (dBμV/m) = Reading Level (dBμV) + Factor (dB)

Factor (dB) = Cable Loss (dB) + Antenna Factor (dB/m) - Pre\_Amplifier Gain (dB)

Product	Cassia	Temperature	26°C
Test Engineer	Snake Ni	Relative Humidity	57 %
Test Site	AC1	Test Date	2017/11/30
Test Mode:	802.11n-HT20	Test Channel:	44
Remark:	1. Average measurement was not performed if peak level lower than average limit. 2. Other frequency was 20dB below limit line within 1-18GHz, there is not show in the report.		

Mark	Frequency (MHz)	Reading Level (dBμV)	Factor (dB)	Measure Level (dBμV/m)	Limit (dBμV/m)	Margin (dB)	Detector	Polarization
	7685.6	33.9	8.0	41.9	74.0	-32.1	Peak	Horizontal
*	8625.6	34.0	8.8	42.8	68.2	-25.4	Peak	Horizontal
	9473.6	32.4	10.5	42.9	74.0	-31.1	Peak	Horizontal
*	12752.6	33.0	11.7	44.7	68.2	-23.5	Peak	Horizontal
	7365.6	33.3	7.9	41.2	74.0	-32.8	Peak	Vertical
*	9253.7	32.9	10.2	43.1	68.2	-25.1	Peak	Vertical
	9425.6	33.0	10.6	43.6	74.0	-30.4	Peak	Vertical
*	12754.6	32.5	11.7	44.2	68.2	-24.0	Peak	Vertical

Note 1: "\*" is not in restricted band, its limit is -27dBm/MHz. At a distance of 3 meters, the field strength limit in dBμV/m can be determined by adding a "conversion" factor of 95.2dB to the EIRP limit of -27dBm/MHz to obtain the limit for out of band spurious emissions.

Note 2: Measure Level (dBμV/m) = Reading Level (dBμV) + Factor (dB)

Factor (dB) = Cable Loss (dB) + Antenna Factor (dB/m) - Pre\_Amplifier Gain (dB)

Product	Cassia	Temperature	26°C
Test Engineer	Snake Ni	Relative Humidity	57 %
Test Site	AC1	Test Date	2017/11/30
Test Mode:	802.11n-HT20	Test Channel:	48
Remark:	1. Average measurement was not performed if peak level lower than average limit. 2. Other frequency was 20dB below limit line within 1-18GHz, there is not show in the report.		

Mark	Frequency (MHz)	Reading Level (dBμV)	Factor (dB)	Measure Level (dBμV/m)	Limit (dBμV/m)	Margin (dB)	Detector	Polarization
	7698.7	33.7	8.0	41.7	74.0	-32.3	Peak	Horizontal
*	9654.6	32.8	11.0	43.8	68.2	-24.4	Peak	Horizontal
	11986.6	33.5	11.9	45.4	74.0	-28.6	Peak	Horizontal
*	12745.7	32.8	11.7	44.5	68.2	-23.7	Peak	Horizontal
	7635.6	33.6	8.0	41.6	74.0	-32.4	Peak	Vertical
*	9247.9	32.5	10.2	42.7	68.2	-25.5	Peak	Vertical
	11523.7	33.5	12.7	46.2	74.0	-27.8	Peak	Vertical
*	12754.7	32.3	11.7	44.0	68.2	-24.2	Peak	Vertical

Note 1: "\*" is not in restricted band, its limit is -27dBm/MHz. At a distance of 3 meters, the field strength limit in dBμV/m can be determined by adding a "conversion" factor of 95.2dB to the EIRP limit of -27dBm/MHz to obtain the limit for out of band spurious emissions.

Note 2: Measure Level (dBμV/m) = Reading Level (dBμV) + Factor (dB)

Factor (dB) = Cable Loss (dB) + Antenna Factor (dB/m) - Pre\_Amplifier Gain (dB)

Product	Cassia	Temperature	26°C
Test Engineer	Snake Ni	Relative Humidity	57 %
Test Site	AC1	Test Date	2017/11/30
Test Mode:	802.11n-HT20	Test Channel:	149
Remark:	1. Average measurement was not performed if peak level lower than average limit. 2. Other frequency was 20dB below limit line within 1-18GHz, there is not show in the report.		

Mark	Frequency (MHz)	Reading Level (dBμV)	Factor (dB)	Measure Level (dBμV/m)	Limit (dBμV/m)	Margin (dB)	Detector	Polarization
	7658.9	33.5	8.0	41.5	74.0	-32.5	Peak	Horizontal
*	9276.7	34.2	10.3	44.5	68.2	-23.7	Peak	Horizontal
	9422.7	33.2	10.6	43.8	74.0	-30.2	Peak	Horizontal
*	17235.0	37.2	15.9	53.1	68.2	-15.1	Peak	Horizontal
	7682.6	33.1	8.0	41.1	74.0	-32.9	Peak	Vertical
*	8694.2	33.5	9.0	42.5	68.2	-25.7	Peak	Vertical
	9472.8	32.8	10.5	43.3	74.0	-30.7	Peak	Vertical
*	12768.7	32.9	11.7	44.6	68.2	-23.6	Peak	Vertical

Note 1: "\*" is not in restricted band, its limit is -27dBm/MHz or -17dBm/MHz. At a distance of 3 meters, the field strength limit in dBμV/m can be determined by adding a "conversion" factor of 95.2dB to the EIRP limit of -27dBm/MHz to obtain the limit for out of band spurious emissions.

Note 2: Measure Level (dBμV/m) = Reading Level (dBμV) + Factor (dB)

Factor (dB) = Cable Loss (dB) + Antenna Factor (dB/m) - Pre\_Amplifier Gain (dB)



Product	Cassia	Temperature	26°C
Test Engineer	Snake Ni	Relative Humidity	57 %
Test Site	AC1	Test Date	2017/11/30
Test Mode:	802.11n-HT20	Test Channel:	157
Remark:	1. Average measurement was not performed if peak level lower than average limit. 2. Other frequency was 20dB below limit line within 1-18GHz, there is not show in the report.		

Mark	Frequency (MHz)	Reading Level (dBμV)	Factor (dB)	Measure Level (dBμV/m)	Limit (dBμV/m)	Margin (dB)	Detector	Polarization
	7625.6	33.4	8.0	41.4	74.0	-32.6	Peak	Horizontal
*	9253.7	32.3	10.2	42.5	68.2	-25.7	Peak	Horizontal
	11527.7	32.8	12.7	45.5	74.0	-28.5	Peak	Horizontal
*	12714.6	32.3	11.7	44.0	68.2	-24.2	Peak	Horizontal
	7652.5	32.7	8.0	40.7	74.0	-33.3	Peak	Vertical
*	8649.7	33.3	8.8	42.1	68.2	-26.1	Peak	Vertical
	9463.7	33.1	10.5	43.6	74.0	-30.4	Peak	Vertical
*	12764.7	32.6	11.7	44.3	68.2	-23.9	Peak	Vertical

Note 1: "\*" is not in restricted band, its limit is -27dBm/MHz or -17dBm/MHz. At a distance of 3 meters, the field strength limit in dBμV/m can be determined by adding a "conversion" factor of 95.2dB to the EIRP limit of -27dBm/MHz to obtain the limit for out of band spurious emissions.

Note 2: Measure Level (dBμV/m) = Reading Level (dBμV) + Factor (dB)

Factor (dB) = Cable Loss (dB) + Antenna Factor (dB/m) - Pre\_Amplifier Gain (dB)

Product	Cassia	Temperature	26°C
Test Engineer	Snake Ni	Relative Humidity	57 %
Test Site	AC1	Test Date	2017/11/30
Test Mode:	802.11n-HT20	Test Channel:	165
Remark:	1. Average measurement was not performed if peak level lower than average limit. 2. Other frequency was 20dB below limit line within 1-18GHz, there is not show in the report.		

Mark	Frequency (MHz)	Reading Level (dBμV)	Factor (dB)	Measure Level (dBμV/m)	Limit (dBμV/m)	Margin (dB)	Detector	Polarization
	7643.6	33.1	8.0	41.1	74.0	-32.9	Peak	Horizontal
*	8672.2	32.8	8.9	41.7	68.2	-26.5	Peak	Horizontal
	9425.3	33.7	10.6	44.3	74.0	-29.7	Peak	Horizontal
*	12716.4	32.9	11.7	44.6	68.2	-23.6	Peak	Horizontal
	7648.6	33.7	8.0	41.7	74.0	-32.3	Peak	Vertical
*	8624.7	33.6	8.8	42.4	68.2	-25.8	Peak	Vertical
	9153.6	33.4	9.8	43.2	74.0	-30.8	Peak	Vertical
*	12942.7	32.3	12.1	44.4	68.2	-23.8	Peak	Vertical

Note 1: "\*" is not in restricted band, its limit is -27dBm/MHz or -17dBm/MHz. At a distance of 3 meters, the field strength limit in dBμV/m can be determined by adding a "conversion" factor of 95.2dB to the EIRP limit of -27dBm/MHz to obtain the limit for out of band spurious emissions.

Note 2: Measure Level (dBμV/m) = Reading Level (dBμV) + Factor (dB)

Factor (dB) = Cable Loss (dB) + Antenna Factor (dB/m) - Pre\_Amplifier Gain (dB)

Product	Cassia	Temperature	26°C
Test Engineer	Snake Ni	Relative Humidity	57 %
Test Site	AC1	Test Date	2017/11/30
Test Mode:	802.11n-HT40	Test Channel:	38
Remark:	1. Average measurement was not performed if peak level lower than average limit. 2. Other frequency was 20dB below limit line within 1-18GHz, there is not show in the report.		

Mark	Frequency (MHz)	Reading Level (dBμV)	Factor (dB)	Measure Level (dBμV/m)	Limit (dBμV/m)	Margin (dB)	Detector	Polarization
	7684.7	33.9	8.0	41.9	74.0	-32.1	Peak	Horizontal
*	8648.7	32.9	8.8	41.7	68.2	-26.5	Peak	Horizontal
	9482.5	33.1	10.6	43.7	74.0	-30.3	Peak	Horizontal
*	12746.7	32.9	11.7	44.6	68.2	-23.6	Peak	Horizontal
	7543.7	32.8	8.3	41.1	74.0	-32.9	Peak	Vertical
*	8649.6	34.7	8.8	43.5	68.2	-24.7	Peak	Vertical
	9471.0	32.7	10.5	43.2	74.0	-30.8	Peak	Vertical
*	12953.5	33.1	12.1	45.2	68.2	-23.0	Peak	Vertical

Note 1: "\*" is not in restricted band, its limit is -27dBm/MHz. At a distance of 3 meters, the field strength limit in dBμV/m can be determined by adding a "conversion" factor of 95.2dB to the EIRP limit of -27dBm/MHz to obtain the limit for out of band spurious emissions.

Note 2: Measure Level (dBμV/m) = Reading Level (dBμV) + Factor (dB)

Factor (dB) = Cable Loss (dB) + Antenna Factor (dB/m) - Pre\_Amplifier Gain (dB)

Product	Cassia	Temperature	26°C
Test Engineer	Snake Ni	Relative Humidity	57 %
Test Site	AC1	Test Date	2017/11/30
Test Mode:	802.11n-HT40	Test Channel:	46
Remark:	1. Average measurement was not performed if peak level lower than average limit. 2. Other frequency was 20dB below limit line within 1-18GHz, there is not show in the report.		

Mark	Frequency (MHz)	Reading Level (dBμV)	Factor (dB)	Measure Level (dBμV/m)	Limit (dBμV/m)	Margin (dB)	Detector	Polarization
	7541.3	33.1	8.3	41.4	74.0	-32.6	Peak	Horizontal
*	8652.6	33.6	8.8	42.4	68.2	-25.8	Peak	Horizontal
	9452.0	33.4	10.5	43.9	74.0	-30.1	Peak	Horizontal
*	12872.6	33.6	12.0	45.6	68.2	-22.6	Peak	Horizontal
	7485.7	33.4	8.2	41.6	74.0	-32.4	Peak	Vertical
*	8745.2	32.8	9.0	41.8	68.2	-26.4	Peak	Vertical
	9462.7	33.2	10.5	43.7	74.0	-30.3	Peak	Vertical
*	12748.6	32.6	11.7	44.3	68.2	-23.9	Peak	Vertical

Note 1: "\*" is not in restricted band, its limit is -27dBm/MHz. At a distance of 3 meters, the field strength limit in dBμV/m can be determined by adding a "conversion" factor of 95.2dB to the EIRP limit of -27dBm/MHz to obtain the limit for out of band spurious emissions.

Note 2: Measure Level (dBμV/m) = Reading Level (dBμV) + Factor (dB)

Factor (dB) = Cable Loss (dB) + Antenna Factor (dB/m) - Pre\_Amplifier Gain (dB)

Product	Cassia	Temperature	26°C
Test Engineer	Snake Ni	Relative Humidity	57 %
Test Site	AC1	Test Date	2017/11/30
Test Mode:	802.11n-HT40	Test Channel:	151
Remark:	1. Average measurement was not performed if peak level lower than average limit. 2. Other frequency was 20dB below limit line within 1-18GHz, there is not show in the report.		

Mark	Frequency (MHz)	Reading Level (dBμV)	Factor (dB)	Measure Level (dBμV/m)	Limit (dBμV/m)	Margin (dB)	Detector	Polarization
	7526.8	32.9	8.3	41.2	74.0	-32.8	Peak	Horizontal
*	8647.1	33.8	8.8	42.6	68.2	-25.6	Peak	Horizontal
	9471.3	32.7	10.5	43.2	74.0	-30.8	Peak	Horizontal
*	12714.6	31.8	11.7	43.5	68.2	-24.7	Peak	Horizontal
	7652.6	32.6	8.0	40.6	74.0	-33.4	Peak	Vertical
*	9254.6	32.1	10.2	42.3	68.2	-25.9	Peak	Vertical
	11428.0	33.2	12.6	45.8	74.0	-28.2	Peak	Vertical
*	12712.6	32.5	11.7	44.2	68.2	-24.0	Peak	Vertical

Note 1: "\*" is not in restricted band, its limit is -27dBm/MHz or -17dBm/MHz. At a distance of 3 meters, the field strength limit in dBμV/m can be determined by adding a "conversion" factor of 95.2dB to the EIRP limit of -27dBm/MHz to obtain the limit for out of band spurious emissions.

Note 2: Measure Level (dBμV/m) = Reading Level (dBμV) + Factor (dB)

Factor (dB) = Cable Loss (dB) + Antenna Factor (dB/m) - Pre\_Amplifier Gain (dB)

Product	Cassia	Temperature	26°C
Test Engineer	Snake Ni	Relative Humidity	57 %
Test Site	AC1	Test Date	2017/11/30
Test Mode:	802.11n-HT40	Test Channel:	159
Remark:	1. Average measurement was not performed if peak level lower than average limit. 2. Other frequency was 20dB below limit line within 1-18GHz, there is not show in the report.		

Mark	Frequency (MHz)	Reading Level (dBμV)	Factor (dB)	Measure Level (dBμV/m)	Limit (dBμV/m)	Margin (dB)	Detector	Polarization
	7628.9	33.2	8.0	41.2	74.0	-32.8	Peak	Horizontal
*	8625.5	33.1	8.8	41.9	68.2	-26.3	Peak	Horizontal
	11742.6	32.8	11.9	44.7	74.0	-29.3	Peak	Horizontal
*	17235.0	37.5	15.9	53.4	68.2	-14.8	Peak	Horizontal
	7641.8	33.2	8.0	41.2	74.0	-32.8	Peak	Vertical
*	8625.6	33.1	8.8	41.9	68.2	-26.3	Peak	Vertical
	9435.5	33.1	10.5	43.6	74.0	-30.4	Peak	Vertical
*	12745.7	32.3	11.7	44.0	68.2	-24.2	Peak	Vertical

Note 1: "\*" is not in restricted band, its limit is -27dBm/MHz or -17dBm/MHz. At a distance of 3 meters, the field strength limit in dBμV/m can be determined by adding a "conversion" factor of 95.2dB to the EIRP limit of -27dBm/MHz to obtain the limit for out of band spurious emissions.

Note 2: Measure Level (dBμV/m) = Reading Level (dBμV) + Factor (dB)

Factor (dB) = Cable Loss (dB) + Antenna Factor (dB/m) - Pre\_Amplifier Gain (dB)

Product	Cassia	Temperature	26°C
Test Engineer	Snake Ni	Relative Humidity	57 %
Test Site	AC1	Test Date	2017/11/30
Test Mode:	802.11ac-VHT20	Test Channel:	36
Remark:	1. Average measurement was not performed if peak level lower than average limit. 2. Other frequency was 20dB below limit line within 1-18GHz, there is not show in the report.		

Mark	Frequency (MHz)	Reading Level (dBμV)	Factor (dB)	Measure Level (dBμV/m)	Limit (dBμV/m)	Margin (dB)	Detector	Polarization
	7641.8	32.9	8.0	40.9	74.0	-33.1	Peak	Horizontal
*	8642.6	33.3	8.8	42.1	68.2	-26.1	Peak	Horizontal
	9125.6	35.3	9.7	45.0	74.0	-29.0	Peak	Horizontal
*	12746.4	33.0	11.7	44.7	68.2	-23.5	Peak	Horizontal
	7635.2	33.1	8.0	41.1	74.0	-32.9	Peak	Vertical
*	8647.2	33.0	8.8	41.8	68.2	-26.4	Peak	Vertical
	9471.0	33.3	10.5	43.8	74.0	-30.2	Peak	Vertical
*	12714.6	32.6	11.7	44.3	68.2	-23.9	Peak	Vertical

Note 1: "\*" is not in restricted band, its limit is -27dBm/MHz. At a distance of 3 meters, the field strength limit in dBμV/m can be determined by adding a "conversion" factor of 95.2dB to the EIRP limit of -27dBm/MHz to obtain the limit for out of band spurious emissions.

Note 2: Measure Level (dBμV/m) = Reading Level (dBμV) + Factor (dB)

Factor (dB) = Cable Loss (dB) + Antenna Factor (dB/m) - Pre\_Amplifier Gain (dB)

Product	Cassia	Temperature	26°C
Test Engineer	Snake Ni	Relative Humidity	57 %
Test Site	AC1	Test Date	2017/11/30
Test Mode:	802.11ac-VHT20	Test Channel:	44
Remark:	1. Average measurement was not performed if peak level lower than average limit. 2. Other frequency was 20dB below limit line within 1-18GHz, there is not show in the report.		

Mark	Frequency (MHz)	Reading Level (dBμV)	Factor (dB)	Measure Level (dBμV/m)	Limit (dBμV/m)	Margin (dB)	Detector	Polarization
	7614.8	33.4	8.1	41.5	74.0	-32.5	Peak	Horizontal
*	8614.7	33.6	8.8	42.4	68.2	-25.8	Peak	Horizontal
	9413.1	33.2	10.6	43.8	74.0	-30.2	Peak	Horizontal
*	12743.7	32.8	11.7	44.5	68.2	-23.7	Peak	Horizontal
	7542.8	33.6	8.3	41.9	74.0	-32.1	Peak	Vertical
*	8647.2	33.5	8.8	42.3	68.2	-25.9	Peak	Vertical
	9427.2	32.9	10.5	43.4	74.0	-30.6	Peak	Vertical
*	11724.6	32.5	11.9	44.4	68.2	-23.8	Peak	Vertical

Note 1: "\*" is not in restricted band, its limit is -27dBm/MHz. At a distance of 3 meters, the field strength limit in dBμV/m can be determined by adding a "conversion" factor of 95.2dB to the EIRP limit of -27dBm/MHz to obtain the limit for out of band spurious emissions.

Note 2: Measure Level (dBμV/m) = Reading Level (dBμV) + Factor (dB)

Factor (dB) = Cable Loss (dB) + Antenna Factor (dB/m) - Pre\_Amplifier Gain (dB)



Product	Cassia	Temperature	26°C
Test Engineer	Snake Ni	Relative Humidity	57 %
Test Site	AC1	Test Date	2017/11/30
Test Mode:	802.11ac-VHT20	Test Channel:	48
Remark:	1. Average measurement was not performed if peak level lower than average limit. 2. Other frequency was 20dB below limit line within 1-18GHz, there is not show in the report.		

Mark	Frequency (MHz)	Reading Level (dBμV)	Factor (dB)	Measure Level (dBμV/m)	Limit (dBμV/m)	Margin (dB)	Detector	Polarization
	7514.9	32.7	8.3	41.0	74.0	-33.0	Peak	Horizontal
*	8625.8	32.7	8.8	41.5	68.2	-26.7	Peak	Horizontal
	9473.8	32.6	10.5	43.1	74.0	-30.9	Peak	Horizontal
*	12716.4	31.7	11.7	43.4	68.2	-24.8	Peak	Horizontal
	7593.5	32.6	8.1	40.7	74.0	-33.3	Peak	Vertical
*	8617.5	33.1	8.8	41.9	68.2	-26.3	Peak	Vertical
	9427.3	33.1	10.5	43.6	74.0	-30.4	Peak	Vertical
*	12714.6	32.7	11.7	44.4	68.2	-23.8	Peak	Vertical

Note 1: "\*" is not in restricted band, its limit is -27dBm/MHz. At a distance of 3 meters, the field strength limit in dBμV/m can be determined by adding a "conversion" factor of 95.2dB to the EIRP limit of -27dBm/MHz to obtain the limit for out of band spurious emissions.

Note 2: Measure Level (dBμV/m) = Reading Level (dBμV) + Factor (dB)

Factor (dB) = Cable Loss (dB) + Antenna Factor (dB/m) - Pre\_Amplifier Gain (dB)

Product	Cassia	Temperature	26°C
Test Engineer	Snake Ni	Relative Humidity	57 %
Test Site	AC1	Test Date	2017/11/30
Test Mode:	802.11ac-VHT20	Test Channel:	149
Remark:	1. Average measurement was not performed if peak level lower than average limit. 2. Other frequency was 20dB below limit line within 1-18GHz, there is not show in the report.		

Mark	Frequency (MHz)	Reading Level (dBμV)	Factor (dB)	Measure Level (dBμV/m)	Limit (dBμV/m)	Margin (dB)	Detector	Polarization
	7645.6	33.4	8.0	41.4	74.0	-32.6	Peak	Horizontal
*	8642.7	33.5	8.8	42.3	68.2	-25.9	Peak	Horizontal
	9427.7	33.2	10.5	43.7	74.0	-30.3	Peak	Horizontal
*	12748.4	33.4	11.7	45.1	68.2	-23.1	Peak	Horizontal
	7625.4	33.2	8.0	41.2	74.0	-32.8	Peak	Vertical
*	8624.3	32.9	8.8	41.7	68.2	-26.5	Peak	Vertical
	9417.8	32.1	10.6	42.7	74.0	-31.3	Peak	Vertical
*	12714.0	32.4	11.7	44.1	68.2	-24.1	Peak	Vertical

Note 1: "\*" is not in restricted band, its limit is -27dBm/MHz or -17dBm/MHz. At a distance of 3 meters, the field strength limit in dBμV/m can be determined by adding a "conversion" factor of 95.2dB to the EIRP limit of -27dBm/MHz to obtain the limit for out of band spurious emissions.

Note 2: Measure Level (dBμV/m) = Reading Level (dBμV) + Factor (dB)

Factor (dB) = Cable Loss (dB) + Antenna Factor (dB/m) - Pre\_Amplifier Gain (dB)

Product	Cassia	Temperature	26°C
Test Engineer	Snake Ni	Relative Humidity	57 %
Test Site	AC1	Test Date	2017/11/30
Test Mode:	802.11ac-VHT20	Test Channel:	157
Remark:	1. Average measurement was not performed if peak level lower than average limit. 2. Other frequency was 20dB below limit line within 1-18GHz, there is not show in the report.		

Mark	Frequency (MHz)	Reading Level (dBμV)	Factor (dB)	Measure Level (dBμV/m)	Limit (dBμV/m)	Margin (dB)	Detector	Polarization
	7315.6	33.4	8.0	41.4	74.0	-32.6	Peak	Horizontal
*	8671.6	34.1	8.9	43.0	68.2	-25.2	Peak	Horizontal
	9438.7	34.2	10.5	44.7	74.0	-29.3	Peak	Horizontal
*	12714.6	33.4	11.7	45.1	68.2	-23.1	Peak	Horizontal
	7648.1	31.8	8.0	39.8	74.0	-34.2	Peak	Vertical
*	8624.7	32.8	8.8	41.6	68.2	-26.6	Peak	Vertical
	9427.7	32.3	10.5	42.8	74.0	-31.2	Peak	Vertical
*	12764.8	32.8	11.7	44.5	68.2	-23.7	Peak	Vertical

Note 1: "\*" is not in restricted band, its limit is -27dBm/MHz or -17dBm/MHz. At a distance of 3 meters, the field strength limit in dBμV/m can be determined by adding a "conversion" factor of 95.2dB to the EIRP limit of -27dBm/MHz to obtain the limit for out of band spurious emissions.

Note 2: Measure Level (dBμV/m) = Reading Level (dBμV) + Factor (dB)

Factor (dB) = Cable Loss (dB) + Antenna Factor (dB/m) - Pre\_Amplifier Gain (dB)

Product	Cassia	Temperature	26°C
Test Engineer	Snake Ni	Relative Humidity	57 %
Test Site	AC1	Test Date	2017/11/30
Test Mode:	802.11ac-VHT20	Test Channel:	165
Remark:	1. Average measurement was not performed if peak level lower than average limit. 2. Other frequency was 20dB below limit line within 1-18GHz, there is not show in the report.		

Mark	Frequency (MHz)	Reading Level (dBμV)	Factor (dB)	Measure Level (dBμV/m)	Limit (dBμV/m)	Margin (dB)	Detector	Polarization
	7614.6	33.4	8.1	41.5	74.0	-32.5	Peak	Horizontal
*	8615.3	33.0	8.8	41.8	68.2	-26.4	Peak	Horizontal
	9413.1	33.3	10.6	43.9	74.0	-30.1	Peak	Horizontal
*	12762.6	32.3	11.7	44.0	68.2	-24.2	Peak	Horizontal
	7514.2	33.8	8.3	42.1	74.0	-31.9	Peak	Vertical
*	8613.5	34.9	8.8	43.7	68.2	-24.5	Peak	Vertical
	9142.6	34.1	9.8	43.9	74.0	-30.1	Peak	Vertical
*	12714.7	33.5	11.7	45.2	68.2	-23.0	Peak	Vertical

Note 1: "\*" is not in restricted band, its limit is -27dBm/MHz or -17dBm/MHz. At a distance of 3 meters, the field strength limit in dBμV/m can be determined by adding a "conversion" factor of 95.2dB to the EIRP limit of -27dBm/MHz to obtain the limit for out of band spurious emissions.

Note 2: Measure Level (dBμV/m) = Reading Level (dBμV) + Factor (dB)

Factor (dB) = Cable Loss (dB) + Antenna Factor (dB/m) - Pre\_Amplifier Gain (dB)

Product	Cassia	Temperature	26°C
Test Engineer	Snake Ni	Relative Humidity	57 %
Test Site	AC1	Test Date	2017/11/30
Test Mode:	802.11ac-VHT40	Test Channel:	38
Remark:	1. Average measurement was not performed if peak level lower than average limit. 2. Other frequency was 20dB below limit line within 1-18GHz, there is not show in the report.		

Mark	Frequency (MHz)	Reading Level (dBμV)	Factor (dB)	Measure Level (dBμV/m)	Limit (dBμV/m)	Margin (dB)	Detector	Polarization
	7642.8	33.2	8.0	41.2	74.0	-32.8	Peak	Horizontal
*	8647.8	33.2	8.8	42.0	68.2	-26.2	Peak	Horizontal
	9426.7	33.0	10.5	43.5	74.0	-30.5	Peak	Horizontal
*	12716.4	32.7	11.7	44.4	68.2	-23.8	Peak	Horizontal
	7548.7	33.8	8.3	42.1	74.0	-31.9	Peak	Vertical
*	8653.8	34.3	8.8	43.1	68.2	-25.1	Peak	Vertical
	11726.6	32.3	11.9	44.2	74.0	-29.8	Peak	Vertical
*	12715.6	33.0	11.7	44.7	68.2	-23.5	Peak	Vertical

Note 1: "\*" is not in restricted band, its limit is -27dBm/MHz. At a distance of 3 meters, the field strength limit in dBμV/m can be determined by adding a "conversion" factor of 95.2dB to the EIRP limit of -27dBm/MHz to obtain the limit for out of band spurious emissions.

Note 2: Measure Level (dBμV/m) = Reading Level (dBμV) + Factor (dB)

Factor (dB) = Cable Loss (dB) + Antenna Factor (dB/m) - Pre\_Amplifier Gain (dB)

Product	Cassia	Temperature	26°C
Test Engineer	Snake Ni	Relative Humidity	57 %
Test Site	AC1	Test Date	2017/11/30
Test Mode:	802.11ac-VHT40	Test Channel:	46
Remark:	1. Average measurement was not performed if peak level lower than average limit. 2. Other frequency was 20dB below limit line within 1-18GHz, there is not show in the report.		

Mark	Frequency (MHz)	Reading Level (dBμV)	Factor (dB)	Measure Level (dBμV/m)	Limit (dBμV/m)	Margin (dB)	Detector	Polarization
	7692.6	33.7	8.0	41.7	74.0	-32.3	Peak	Horizontal
*	8564.7	33.7	8.7	42.4	68.2	-25.8	Peak	Horizontal
	9427.6	33.5	10.5	44.0	74.0	-30.0	Peak	Horizontal
*	12715.6	33.4	11.7	45.1	68.2	-23.1	Peak	Horizontal
	7642.5	33.3	8.0	41.3	74.0	-32.7	Peak	Vertical
*	8647.6	34.2	8.8	43.0	68.2	-25.2	Peak	Vertical
	9415.6	33.1	10.6	43.7	74.0	-30.3	Peak	Vertical
*	12715.6	33.2	11.7	44.9	68.2	-23.3	Peak	Vertical

Note 1: "\*" is not in restricted band, its limit is -27dBm/MHz. At a distance of 3 meters, the field strength limit in dBμV/m can be determined by adding a "conversion" factor of 95.2dB to the EIRP limit of -27dBm/MHz to obtain the limit for out of band spurious emissions.

Note 2: Measure Level (dBμV/m) = Reading Level (dBμV) + Factor (dB)

Factor (dB) = Cable Loss (dB) + Antenna Factor (dB/m) - Pre\_Amplifier Gain (dB)

Product	Cassia	Temperature	26°C
Test Engineer	Snake Ni	Relative Humidity	57 %
Test Site	AC1	Test Date	2017/11/30
Test Mode:	802.11ac-VHT40	Test Channel:	151
Remark:	1. Average measurement was not performed if peak level lower than average limit. 2. Other frequency was 20dB below limit line within 1-18GHz, there is not show in the report.		

Mark	Frequency (MHz)	Reading Level (dBμV)	Factor (dB)	Measure Level (dBμV/m)	Limit (dBμV/m)	Margin (dB)	Detector	Polarization
	7648.3	33.0	8.0	41.0	74.0	-33.0	Peak	Horizontal
*	8649.0	32.7	8.8	41.5	68.2	-26.7	Peak	Horizontal
	9416.4	33.7	10.6	44.3	74.0	-29.7	Peak	Horizontal
*	12715.4	32.0	11.7	43.7	68.2	-24.5	Peak	Horizontal
	7516.7	33.8	8.3	42.1	74.0	-31.9	Peak	Vertical
*	8615.2	34.3	8.8	43.1	68.2	-25.1	Peak	Vertical
	9142.4	33.7	9.8	43.5	74.0	-30.5	Peak	Vertical
*	12725.7	32.5	11.7	44.2	68.2	-24.0	Peak	Vertical

Note 1: "\*" is not in restricted band, its limit is -27dBm/MHz or -17dBm/MHz. At a distance of 3 meters, the field strength limit in dBμV/m can be determined by adding a "conversion" factor of 95.2dB to the EIRP limit of -27dBm/MHz to obtain the limit for out of band spurious emissions.

Note 2: Measure Level (dBμV/m) = Reading Level (dBμV) + Factor (dB)

Factor (dB) = Cable Loss (dB) + Antenna Factor (dB/m) - Pre\_Amplifier Gain (dB)

Product	Cassia	Temperature	26°C
Test Engineer	Snake Ni	Relative Humidity	57 %
Test Site	AC1	Test Date	2017/11/30
Test Mode:	802.11ac-VHT40	Test Channel:	159
Remark:	1. Average measurement was not performed if peak level lower than average limit. 2. Other frequency was 20dB below limit line within 1-18GHz, there is not show in the report.		

Mark	Frequency (MHz)	Reading Level (dBμV)	Factor (dB)	Measure Level (dBμV/m)	Limit (dBμV/m)	Margin (dB)	Detector	Polarization
	7542.3	33.0	8.3	41.3	74.0	-32.7	Peak	Horizontal
*	8645.6	33.8	8.8	42.6	68.2	-25.6	Peak	Horizontal
	9163.8	33.4	9.8	43.2	74.0	-30.8	Peak	Horizontal
*	12742.7	32.8	11.7	44.5	68.2	-23.7	Peak	Horizontal
	7514.7	33.3	8.3	41.6	74.0	-32.4	Peak	Vertical
*	8642.6	33.3	8.8	42.1	68.2	-26.1	Peak	Vertical
	9416.5	33.3	10.6	43.9	74.0	-30.1	Peak	Vertical
*	12713.6	33.0	11.7	44.7	68.2	-23.5	Peak	Vertical

Note 1: "\*" is not in restricted band, its limit is -27dBm/MHz or -17dBm/MHz. At a distance of 3 meters, the field strength limit in dBμV/m can be determined by adding a "conversion" factor of 95.2dB to the EIRP limit of -27dBm/MHz to obtain the limit for out of band spurious emissions.

Note 2: Measure Level (dBμV/m) = Reading Level (dBμV) + Factor (dB)

Factor (dB) = Cable Loss (dB) + Antenna Factor (dB/m) - Pre\_Amplifier Gain (dB)



Product	Cassia	Temperature	26°C
Test Engineer	Snake Ni	Relative Humidity	57 %
Test Site	AC1	Test Date	2017/11/30
Test Mode:	802.11ac-VHT80	Test Channel:	42
Remark:	1. Average measurement was not performed if peak level lower than average limit. 2. Other frequency was 20dB below limit line within 1-18GHz, there is not show in the report.		

Mark	Frequency (MHz)	Reading Level (dBμV)	Factor (dB)	Measure Level (dBμV/m)	Limit (dBμV/m)	Margin (dB)	Detector	Polarization
	7642.4	33.7	8.0	41.7	74.0	-32.3	Peak	Horizontal
*	8642.6	33.4	8.8	42.2	68.2	-26.0	Peak	Horizontal
	9426.1	33.8	10.6	44.4	74.0	-29.6	Peak	Horizontal
*	12736.5	32.7	11.7	44.4	68.2	-23.8	Peak	Horizontal
	7648.7	33.3	8.0	41.3	74.0	-32.7	Peak	Vertical
*	8624.2	33.8	8.8	42.6	68.2	-25.6	Peak	Vertical
	9142.7	33.3	9.8	43.1	74.0	-30.9	Peak	Vertical
*	12712.1	32.8	11.7	44.5	68.2	-23.7	Peak	Vertical

Note 1: "\*" is not in restricted band, its limit is -27dBm/MHz. At a distance of 3 meters, the field strength limit in dBμV/m can be determined by adding a "conversion" factor of 95.2dB to the EIRP limit of -27dBm/MHz to obtain the limit for out of band spurious emissions.

Note 2: Measure Level (dBμV/m) = Reading Level (dBμV) + Factor (dB)

Factor (dB) = Cable Loss (dB) + Antenna Factor (dB/m) - Pre\_Amplifier Gain (dB)

Product	Cassia	Temperature	26°C
Test Engineer	Snake Ni	Relative Humidity	57 %
Test Site	AC1	Test Date	2017/11/30
Test Mode:	802.11ac-VHT80	Test Channel:	155
Remark:	1. Average measurement was not performed if peak level lower than average limit. 2. Other frequency was 20dB below limit line within 1-18GHz, there is not show in the report.		

Mark	Frequency (MHz)	Reading Level (dBμV)	Factor (dB)	Measure Level (dBμV/m)	Limit (dBμV/m)	Margin (dB)	Detector	Polarization
	7614.3	32.8	8.1	40.9	74.0	-33.1	Peak	Horizontal
*	8647.2	33.2	8.8	42.0	68.2	-26.2	Peak	Horizontal
	9425.9	33.3	10.6	43.9	74.0	-30.1	Peak	Horizontal
*	12765.7	32.8	11.7	44.5	68.2	-23.7	Peak	Horizontal
	7625.6	33.0	8.0	41.0	74.0	-33.0	Peak	Vertical
*	8658.9	32.9	8.8	41.7	68.2	-26.5	Peak	Vertical
	9125.6	34.6	9.7	44.3	74.0	-29.7	Peak	Vertical
*	12754.6	33.6	11.7	45.3	68.2	-22.9	Peak	Vertical

Note 1: "\*" is not in restricted band, its limit is -27dBm/MHz or -17dBm/MHz. At a distance of 3 meters, the field strength limit in dBμV/m can be determined by adding a "conversion" factor of 95.2dB to the EIRP limit of -27dBm/MHz to obtain the limit for out of band spurious emissions.

Note 2: Measure Level (dBμV/m) = Reading Level (dBμV) + Factor (dB)

Factor (dB) = Cable Loss (dB) + Antenna Factor (dB/m) - Pre\_Amplifier Gain (dB)

**The worst case of Radiated Emission below 1GHz:**

Site: AC1	Time: 2017/12/13 - 00:20
Limit: FCC Part15.209_RE(3m)	Engineer: Hunk Li
Probe: VULB 9168_20-2000MHz	Polarity: Horizontal
EUT: Cassia Bluetooth Router	Power: AC 120V/60Hz

**Note: There is the worst case within frequency range 30MHz~1GHz.**

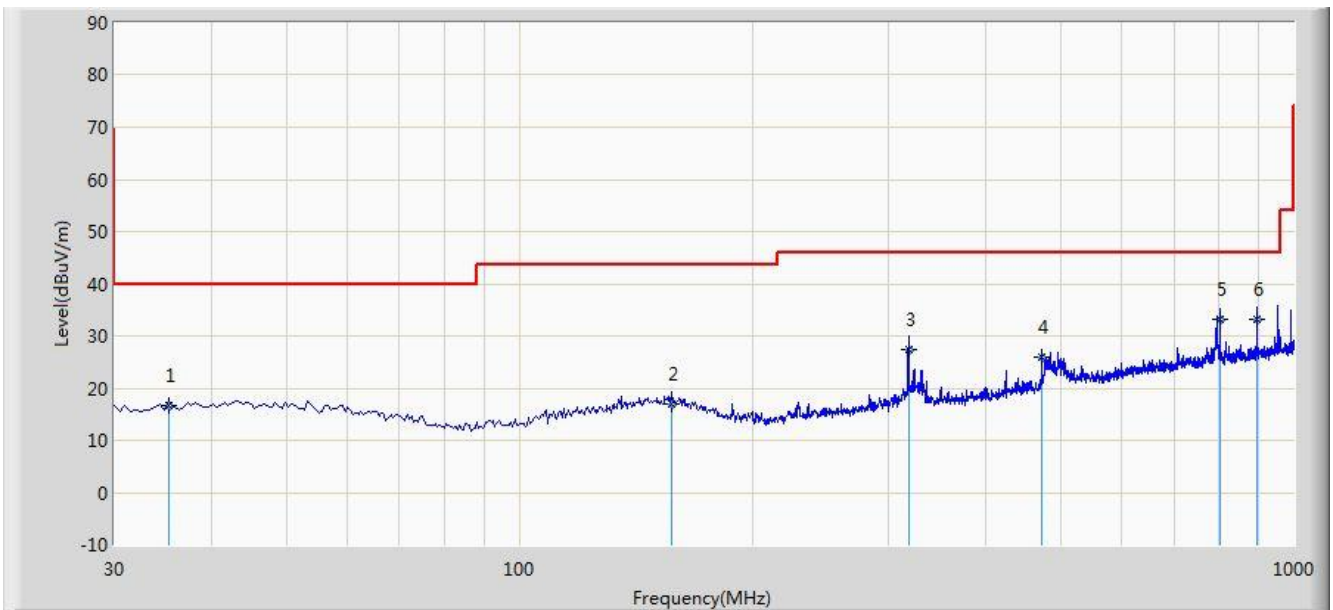

No	Flag	Mark	Frequency (MHz)	Measure Level (dBuV/m)	Reading Level (dBuV)	Margin (dB)	Limit (dBuV/m)	Factor (dB)	Type
1			35.335	16.737	2.724	-23.263	40.000	14.013	QP
2			157.070	16.931	1.635	-26.569	43.500	15.296	QP
3			318.090	27.528	12.636	-18.472	46.000	14.893	QP
4			472.320	26.010	7.824	-19.990	46.000	18.186	QP
5			803.090	33.207	9.865	-12.793	46.000	23.342	QP
6		*	897.150	33.321	8.935	-12.679	46.000	24.386	QP

Note 1: Measure Level (dB $\mu$ V/m) = Reading Level (dB $\mu$ V) + Factor (dB)

Factor (dB) = Cable Loss (dB) + Antenna Factor (dB/m)

Note 2: The test trace is same as the ambient noise and the amplitude of the emissions are attenuated more than 20dB below the permissible (the test frequency range: 9kHz ~ 30MHz, 18GHz ~ 40GHz), therefore no data appear in the report.

Site: AC1	Time: 2017/12/13 - 00:23
Limit: FCC Part15.209_RE(3m)	Engineer: Hunk Li
Probe: VULB 9168_20-2000MHz	Polarity: Vertical
EUT: Cassia Bluetooth Router	Power: AC 120V/60Hz

**Note: There is the worst case within frequency range 30MHz~1GHz.**

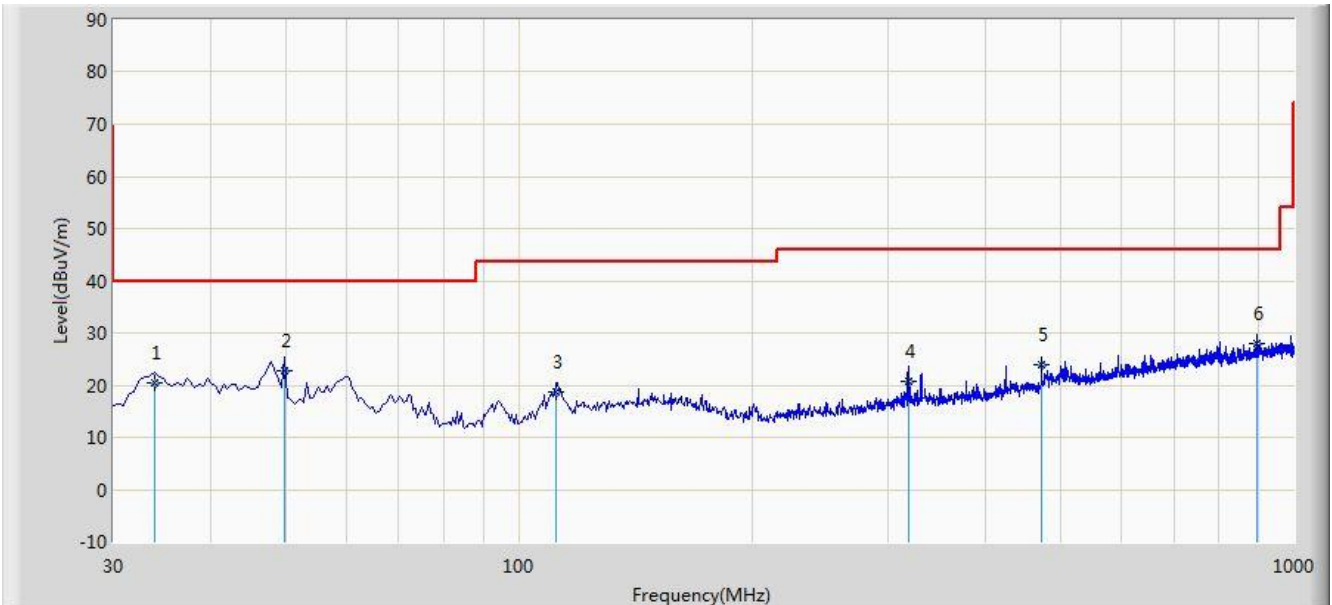

No	Flag	Mark	Frequency (MHz)	Measure Level (dBuV/m)	Reading Level (dBuV)	Margin (dB)	Limit (dBuV/m)	Factor (dB)	Type
1			33.880	20.526	6.635	-19.474	40.000	13.892	QP
2		*	49.885	22.611	8.424	-17.389	40.000	14.187	QP
3			111.965	18.840	6.520	-24.660	43.500	12.320	QP
4			318.090	20.616	5.724	-25.384	46.000	14.893	QP
5			472.320	23.821	5.635	-22.179	46.000	18.186	QP
6			897.665	28.042	3.650	-17.958	46.000	24.392	QP

Note 1: Measure Level (dB $\mu$ V/m) = Reading Level (dB $\mu$ V) + Factor (dB)

Factor (dB) = Cable Loss (dB) + Antenna Factor (dB/m)

Note 2: The test trace is same as the ambient noise and the amplitude of the emissions are attenuated more than 20dB below the permissible (the test frequency range: 9kHz ~ 30MHz, 18GHz ~ 40GHz), therefore no data appear in the report.

## 7.9. Radiated RestrictedBand Edge Measurement

### 7.9.1. Test Limit

#### **For 15.205 requirement:**

Radiated emissions which fall in the restricted bands, as defined in Section 15.205(a) of FCC part 15, must also comply with the radiated emission limits specified in Section 15.209(a).

Frequency (MHz)	Frequency (MHz)	Frequency (MHz)	Frequency (GHz)
0.090 - 0.110	16.42-16.423	399.9 - 410	4.5-5.15
<sup>1</sup> 0.495 - 0.505	16.69475-16.69525	608 - 614	5.35-5.46
2.1735-2.1905	16.80425-16.80475	960 - 1240	7.25-7.75
4.125-4.128	25.5 -25.67	1300 - 1427	8.25 - 8.5
4.17725-4.17775	37.5-38.25	1435-1626.5	9.0-9.2
4.20725-4.20775	73-74.6	1645.5-1646.5	9.3-9.5
6.215-6.218	74.8-75.2	1660 - 1710	10.6-12.7
6.26775-6.26825	108-121.94	1718.8-1722.2	13.25-13.4
6.31175-6.31225	123 - 138	2200 - 2300	14.47-14.5
8.291-8.294	149.9-150.05	2310-2390	15.35-16.2
8.362-8.366	156.52475-156.525	2483.5 - 2500	17.7-21.4
8.37625-8.38675	156.7-156.9	2690 - 2900	22.01-23.12
8.41425-8.41475	162.0125-167.17	3260 - 3267	23.6-24.0
12.29-12.293	167.72-173.2	3332 - 3339	31.2-31.8
12.51975-12.52025	240 - 285	3345.8 - 3358	36.43-36.5
12.57675-12.57725	322-335.4	3600 - 4400	( <sup>2</sup> )
13.36-13.41	--	--	--

#### **For 15.407(b) requirement:**

For transmitters operating in the 5.15-5.25 GHz band: All emissions outside of the 5.15-5.35 GHz band shall not exceed an e.i.r.p. of -27 dBm/MHz.

For transmitters operating in the 5.725-5.85 GHz band: All emissions within the frequency range from the band edge to 10 MHz above or below the band edge shall not exceed an e.i.r.p. of -17 dBm/MHz; for frequencies 10 MHz or greater above or below the band edge, emissions shall not exceed an e.i.r.p. of -27 dBm/MHz.

Refer to KDB 789033 D02v02r01 G)2)c), as specified in § 15.407(b), emissions above 1000 MHz that are outside of the restricted bands are subject to a maximum emission limit of -27 dBm/MHz (or

-17 dBm/MHz as specified in § 15.407(b)(4)). However, an out-of-band emission that complies with both the peak and average limits of § 15.209 is not required to satisfy the -27 dBm/MHz or -17 dBm/MHz maximum emission limit.

All out of band emissions appearing in a restricted band as specified in Section 15.205 of the Title 47CFR must not exceed the limits shown in Table per Section 15.209.

FCC Part 15 Subpart C Paragraph 15.209		
Frequency [MHz]	Field Strength [uV/m]	Measured Distance [Meters]
0.009 – 0.490	2400/F (kHz)	300
0.490 – 1.705	24000/F (kHz)	30
1.705 - 30	30	30
30 - 88	100	3
88 - 216	150	3
216 - 960	200	3
Above 960	500	3

**For RSS-Gen Section 8.10 Requirement:**

Radiated emissions which fall in the restricted bands, as defined in Section 8.10 of RSS-Gen, must also comply with the radiated emission limits specified in Section 8.9.

Frequency (MHz)	Frequency (MHz)	Frequency (GHz)
0.009 ~ 0.110	240 ~ 285	9.0 ~ 9.2
2.1735 ~ 2.1905	322 ~ 335.4	9.3 ~ 9.5
3.020 ~ 3.026	399.9 ~ 410	10.6 ~ 12.7
4.125 ~ 4.128	608 ~ 614	13.25 ~ 13.4
4.17725 ~ 4.17775	960 ~ 1427	14.47 ~ 14.5
4.20725 ~ 4.20775	1435 ~ 1626.5	15.35 ~ 16.2
5.677 ~ 5.683	1645.5 ~ 1646.5	17.7 ~ 21.4
6.215 ~ 6.218	1660 ~ 1710	22.01 ~ 23.12
6.26775 ~ 6.26825	1718.8 ~ 1722.2	23.6 ~ 24.0
6.31175 ~ 6.31225	2200 ~ 2300	31.2 ~ 31.8
8.291 ~ 8.294	2310 ~ 2390	36.43 ~ 36.5
8.362 ~ 8.366	2655 ~ 2900	Above 38.6
8.37625 ~ 8.38675	3260 ~ 3267	--
8.41425 ~ 8.41475	3332 ~ 3339	
12.29 ~ 12.293	334.5 ~ 3358	
12.51975 ~ 12.52025	3500 ~ 4400	
12.57675 ~ 12.57725	4500 ~ 5150	
13.36 ~ 13.41	5350 ~ 5460	
16.42 ~ 16.423	7250 ~ 7750	
16.69475 ~ 16.69525	8025 ~ 8500	
16.80425 ~ 16.80475		
25.5 ~ 25.67		
37.5 ~ 38.25		
73 ~ 74.6		
74.8 ~ 75.2	--	
108 ~ 138		
156.52475 ~ 156.525225		
156.7 ~ 156.9		

Note: \*Certain frequency bands listed in Table 6 and in bands above 38.6 GHz are designated for licence-exempt applications. These frequency bands and the requirements that apply to the devices are set out in the 200- and 300-series of RSSs, such as RSS-210 and RSS-310, which contain the

requirements that apply to licence-exempt radio apparatus.

**For RSS-247 Section 6.2 Requirement:**

For transmitters operating in the 5.15-5.25 GHz band: All emissions outside of the 5.15-5.25 GHz band shall not exceed an e.i.r.p. of  $-27$  dBm/MHz.

For transmitters operating in the 5.25-5.35 GHz band: All emissions outside of the 5.25-5.35 GHz band shall not exceed an e.i.r.p. of  $-27$  dBm/MHz.

For transmitters operating in the 5.47-5.725 GHz band: All emissions outside of the 5.47-5.725 GHz band shall not exceed an e.i.r.p. of  $-27$  dBm/MHz.

Operating Frequency Band (MHz)	EIRP Limit (dBm/MHz)	Equivalent Field Strength at 3m (dBuV/m)
5150 - 5250	-27	68.2
5250 - 5350	-27	68.2
5470 - 5725	-27	68.2

Note: As specified in section 6.2 of RSS-247, emissions above 1000 MHz that are outside of the restricted bands are subject to a maximum emission limit of  $-27$ dBm/MHz. However, an out-of-band emission that complies with both the peak and average limits of 8.9 in RSS-Gen is not required to satisfy the  $-27$  dBm/MHz.



All out of band emissions appearing in a restricted band as specified in Section 8.10 of the RSS-Gen must not exceed the limits shown in Table per Section 8.9.

RSS-Gen Section 8.9		
Frequency [MHz]	Field Strength [V/m]	Measured Distance [Meters]
0.009 - 0.490	2400/F (kHz)	300
0.490 - 1.705	24000/F (kHz)	30
1.705 - 30	30	30
30 - 88	100	3
88 - 216	150	3
216 - 960	200	3
Above 960	500	3

### 7.9.2. Test Result

Site: AC1	Time: 2017/12/02 - 11:29
Limit: FCC_Part15.209_RE(3m)	Engineer: Bruce Wang
Probe: BBHA9120D_1-18GHz	Polarity: Horizontal
EUT: Cassia Bluetooth Router	Power: AC 120V/60Hz
Note: Transmit by 802.11a at Channel 5180MHz	

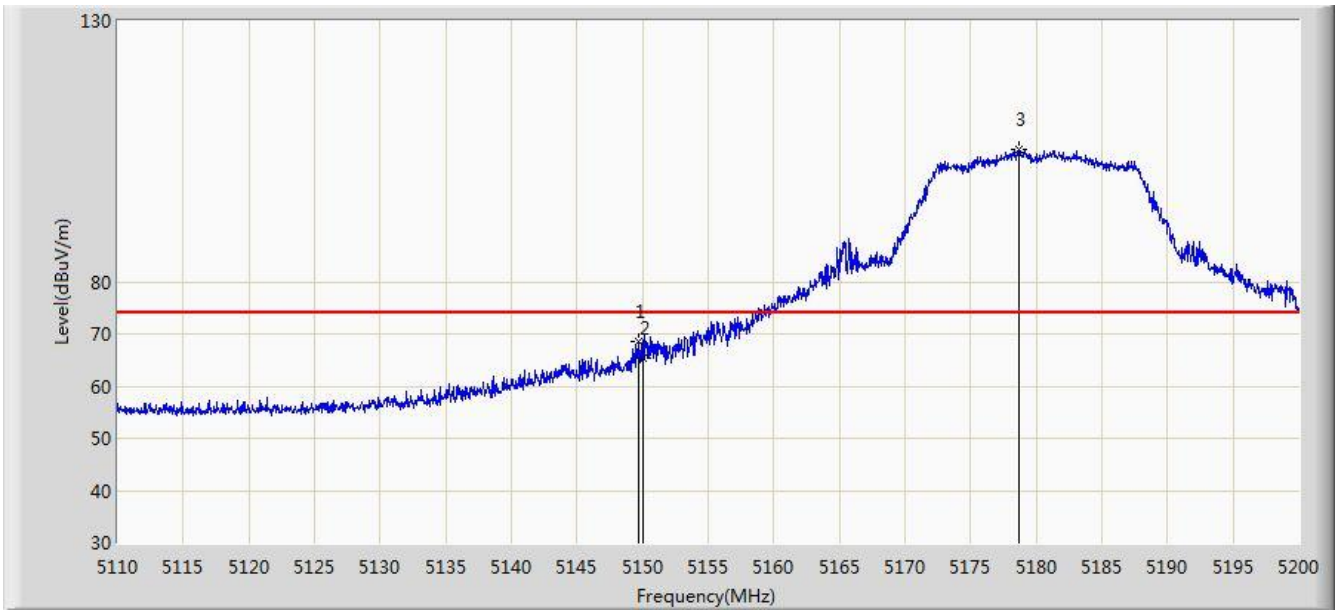

No	Flag	Mark	Frequency (MHz)	Measure Level (dBuV/m)	Reading Level (dBuV)	Over Limit (dB)	Limit (dBuV/m)	Factor (dB)	Type
1			5149.735	68.583	65.274	-5.417	74.000	3.308	PK
2			5150.000	65.373	62.064	-8.627	74.000	3.309	PK
3		*	5178.670	105.403	102.129	N/A	N/A	3.274	PK

Note: Measure Level (dB $\mu$ V/m) = Reading Level (dB $\mu$ V) + Factor (dB)

Factor (dB) = Cable Loss (dB) + Antenna Factor (dB) (dB/m) - Pre\_Amplifier Gain (dB)

Site: AC1	Time: 2017/12/02 - 11:46
Limit: FCC_Part15.209_RE(3m)	Engineer: Bruce Wang
Probe: BBHA9120D_1-18GHz	Polarity: Horizontal
EUT: Cassia Bluetooth Router	Power: AC 120V/60Hz
Note: Transmit by 802.11a at Channel 5180MHz	

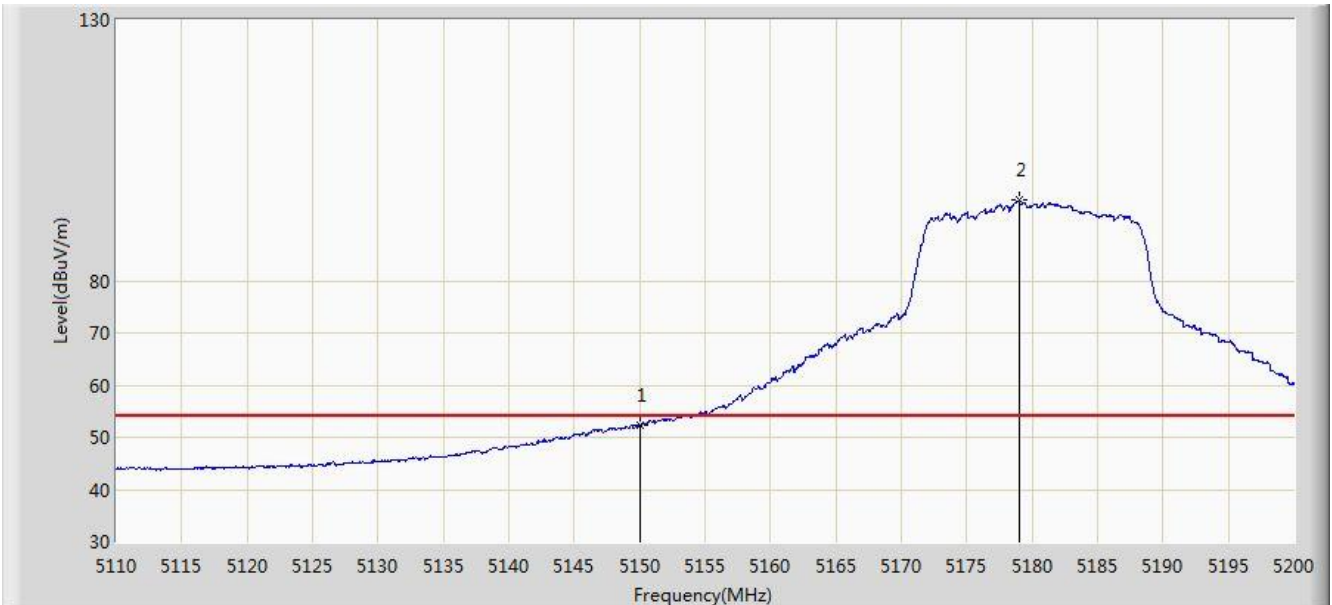

No	Flag	Mark	Frequency (MHz)	Measure Level (dBuV/m)	Reading Level (dBuV)	Over Limit (dB)	Limit (dBuV/m)	Factor (dB)	Type
1			5150.000	52.414	49.105	-1.586	54.000	3.309	AV
2		*	5178.985	95.385	92.111	N/A	N/A	3.274	AV

Note: Measure Level (dBμV/m) = Reading Level (dBμV) + Factor (dB)

Factor (dB) = Cable Loss (dB) + Antenna Factor (dB) (dB/m) - Pre\_Amplifier Gain (dB)

Site: AC1	Time: 2017/12/02 - 11:48
Limit: FCC_Part15.209_RE(3m)	Engineer: Bruce Wang
Probe: BBHA9120D_1-18GHz	Polarity: Vertical
EUT: Cassia Bluetooth Router	Power: AC 120V/60Hz
Note: Transmit by 802.11a at Channel 5180MHz	

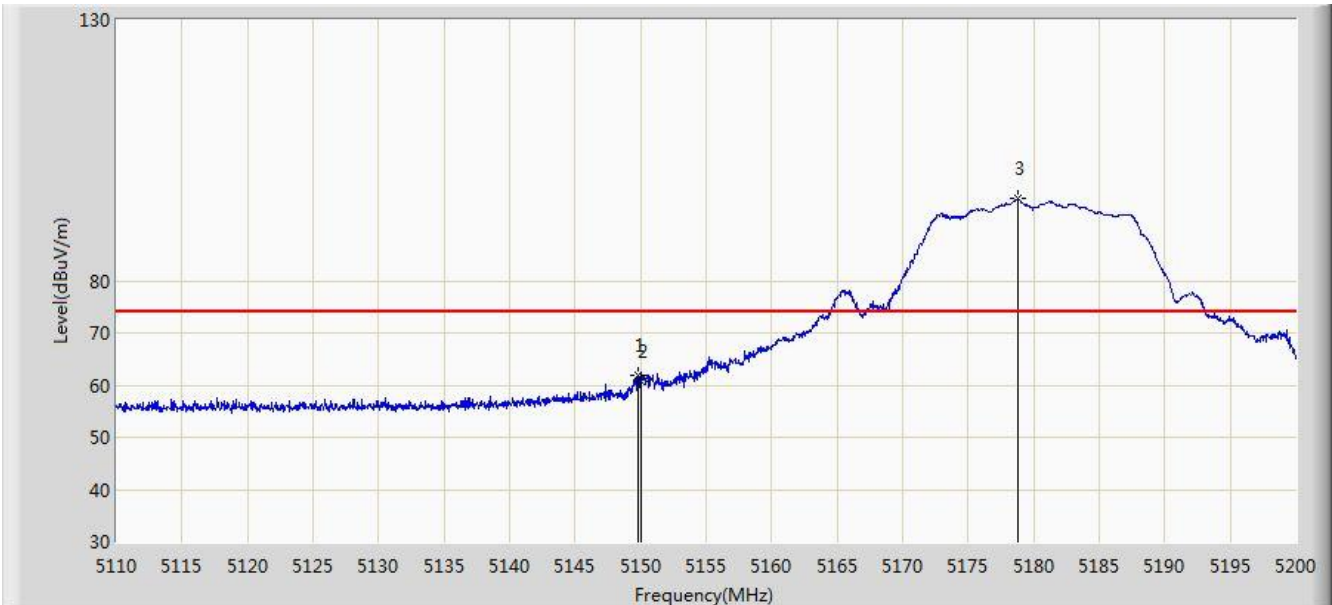

No	Flag	Mark	Frequency (MHz)	Measure Level (dBuV/m)	Reading Level (dBuV)	Over Limit (dB)	Limit (dBuV/m)	Factor (dB)	Type
1			5149.780	61.998	58.689	-12.002	74.000	3.309	PK
2			5150.000	60.608	57.299	-13.392	74.000	3.309	PK
3		*	5178.850	95.705	92.431	N/A	N/A	3.274	PK

Note: Measure Level (dB $\mu$ V/m) = Reading Level (dB $\mu$ V) + Factor (dB)

Factor (dB) = Cable Loss (dB) + Antenna Factor (dB) (dB/m) - Pre\_Amplifier Gain (dB)

Site: AC1	Time: 2017/12/02 - 11:50
Limit: FCC_Part15.209_RE(3m)	Engineer: Bruce Wang
Probe: BBHA9120D_1-18GHz	Polarity: Vertical
EUT: Cassia Bluetooth Router	Power: AC 120V/60Hz
Note: Transmit by 802.11a at Channel 5180MHz	

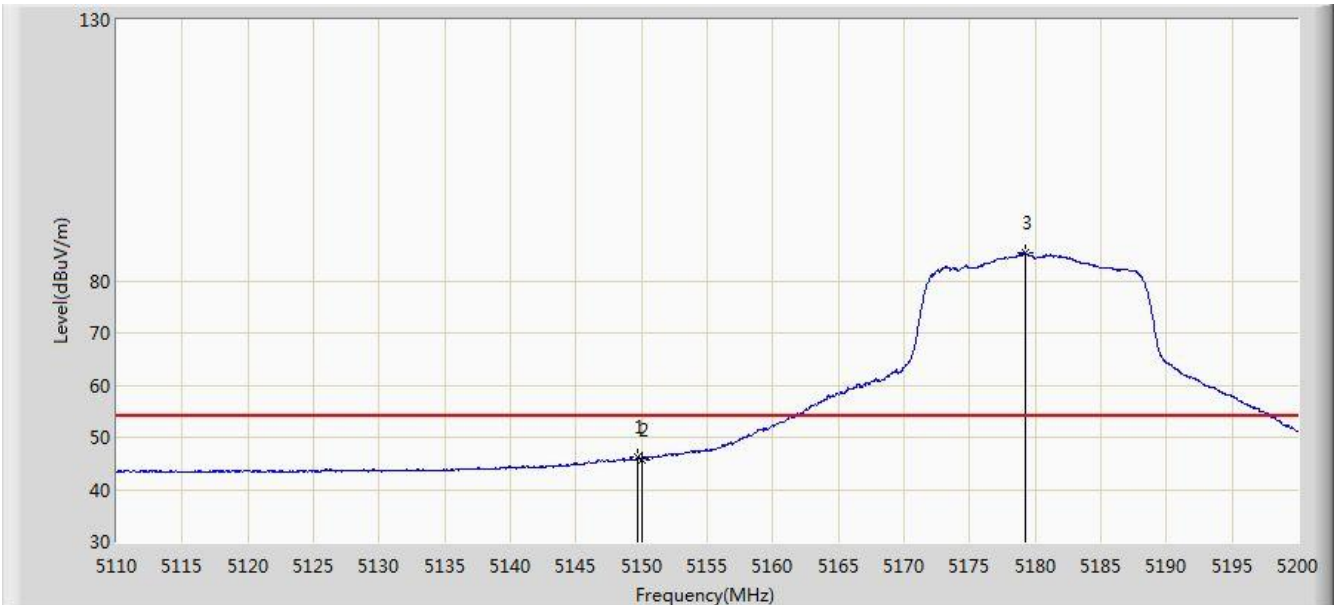

No	Flag	Mark	Frequency (MHz)	Measure Level (dBuV/m)	Reading Level (dBuV)	Over Limit (dB)	Limit (dBuV/m)	Factor (dB)	Type
1			5149.735	46.119	42.810	-7.881	54.000	3.308	AV
2			5150.000	45.773	42.464	-8.227	54.000	3.309	AV
3		*	5179.210	85.341	82.067	N/A	N/A	3.274	AV

Note: Measure Level (dBuV/m) = Reading Level (dBuV) + Factor (dB)

Factor (dB) = Cable Loss (dB) + Antenna Factor (dB) (dB/m) - Pre\_Amplifier Gain (dB)

Site: AC1	Time: 2017/12/02 - 11:54
Limit: FCC_Part15.407_RE(3m)	Engineer: Bruce Wang
Probe: BBHA9120D_1-18GHz	Polarity: Horizontal
EUT: Cassia Bluetooth Router	Power: AC 120V/60Hz
Note: Transmit by 802.11a at Channel 5745MHz	

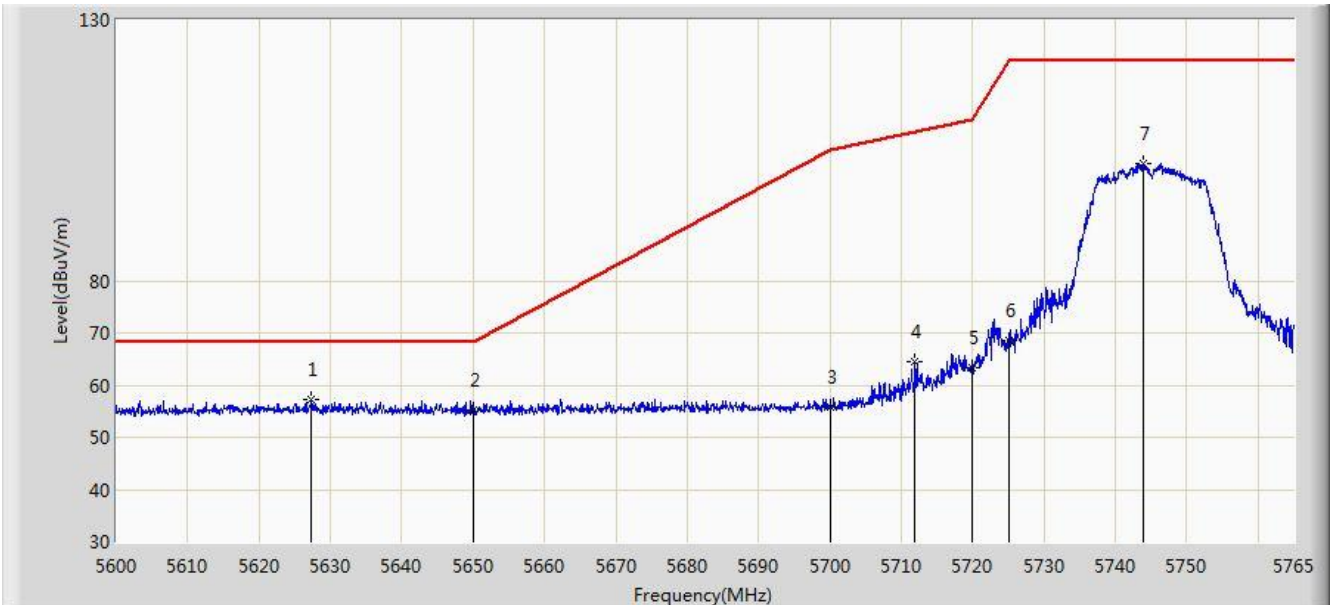

No	Flag	Mark	Frequency (MHz)	Measure Level (dBuV/m)	Reading Level (dBuV)	Over Limit (dB)	Limit (dBuV/m)	Factor (dB)	Type
1		*	5627.390	57.291	53.726	-10.909	68.200	3.565	PK
2			5650.000	55.298	51.671	-12.902	68.200	3.627	PK
3			5700.000	55.832	52.113	-49.368	105.200	3.719	PK
4			5711.953	64.561	60.809	-43.988	108.549	3.752	PK
5			5720.000	63.340	59.564	-47.460	110.800	3.776	PK
6			5725.000	68.685	64.894	-53.515	122.200	3.791	PK
7			5743.962	102.503	98.654	N/A	N/A	3.849	PK

Note: Measure Level (dBμV/m) = Reading Level (dBμV) + Factor (dB)

Factor (dB) = Cable Loss (dB) + Antenna Factor (dB) (dB/m) - Pre\_Amplifier Gain (dB)

Site: AC1	Time: 2017/12/02 - 11:57
Limit: FCC_Part15.407_RE(3m)	Engineer: Bruce Wang
Probe: BBHA9120D_1-18GHz	Polarity: Vertical
EUT: Cassia Bluetooth Router	Power: AC 120V/60Hz
Note: Transmit by 802.11a at Channel 5745MHz	

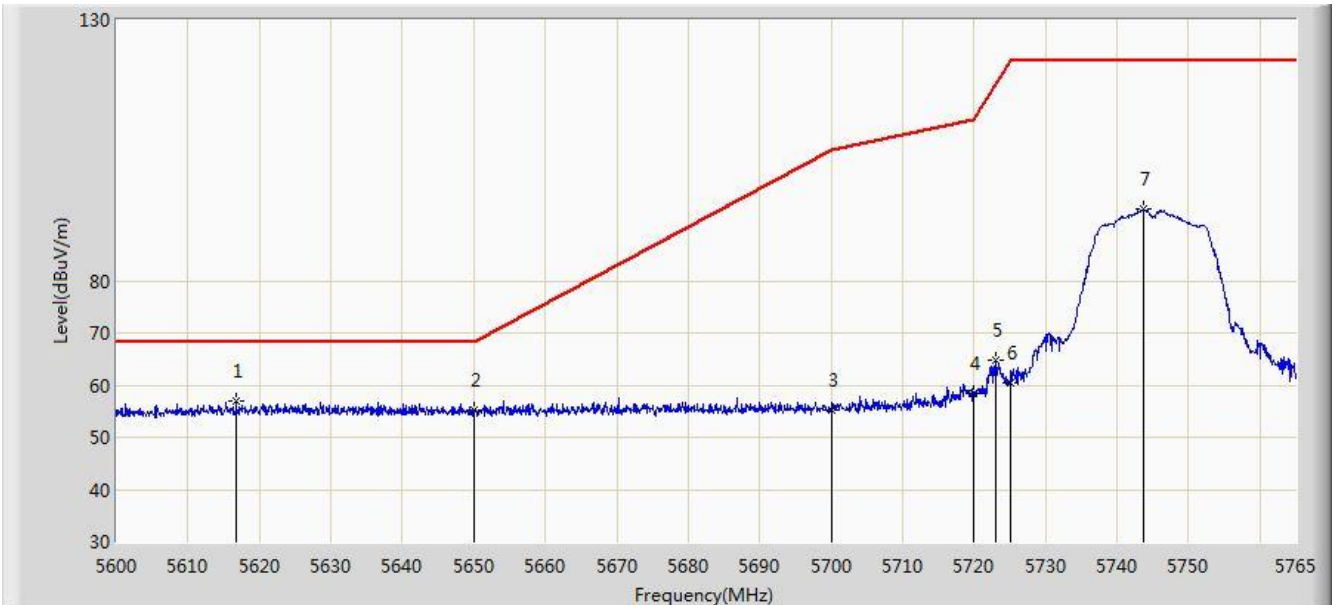

No	Flag	Mark	Frequency (MHz)	Measure Level (dBuV/m)	Reading Level (dBuV)	Over Limit (dB)	Limit (dBuV/m)	Factor (dB)	Type
1		*	5616.748	56.901	53.369	-11.299	68.200	3.531	PK
2			5650.000	55.111	51.484	-13.089	68.200	3.627	PK
3			5700.000	55.331	51.612	-49.869	105.200	3.719	PK
4			5720.000	58.295	54.519	-52.505	110.800	3.776	PK
5			5723.007	64.646	60.861	-53.011	117.657	3.784	PK
6			5725.000	60.444	56.653	-61.756	122.200	3.791	PK
7			5743.797	93.680	89.832	N/A	N/A	3.848	PK

Note: Measure Level (dBμV/m) = Reading Level (dBμV) + Factor (dB)

Factor (dB) = Cable Loss (dB) + Antenna Factor (dB) (dB/m) - Pre\_Amplifier Gain (dB)

Site: AC1	Time: 2017/12/02 - 11:58
Limit: FCC_Part15.407_RE(3m)	Engineer: Bruce Wang
Probe: BBHA9120D_1-18GHz	Polarity: Horizontal
EUT: Cassia Bluetooth Router	Power: AC 120V/60Hz
Note: Transmit by 802.11a at Channel 5825MHz	

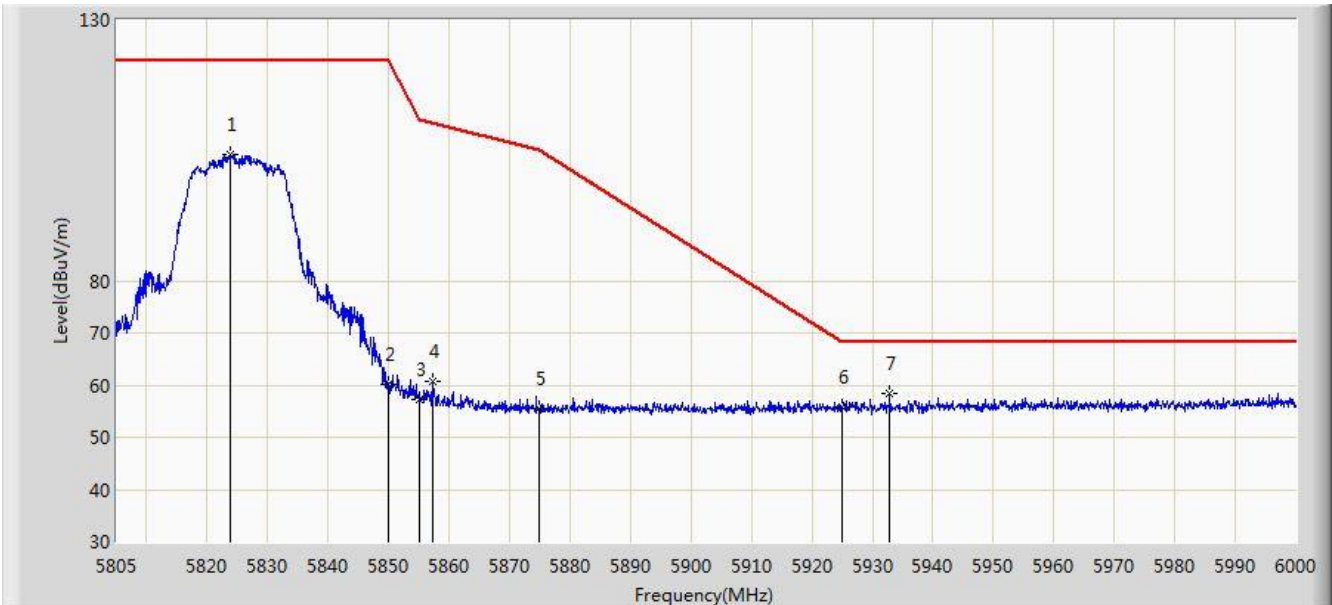

No	Flag	Mark	Frequency (MHz)	Measure Level (dBuV/m)	Reading Level (dBuV)	Over Limit (dB)	Limit (dBuV/m)	Factor (dB)	Type
1			5823.817	104.295	100.292	N/A	N/A	4.003	PK
2			5850.000	60.218	56.161	-61.982	122.200	4.058	PK
3			5855.000	57.153	53.093	-53.647	110.800	4.060	PK
4			5857.260	60.663	56.601	-49.504	110.166	4.062	PK
5			5875.000	55.417	51.312	-49.783	105.200	4.105	PK
6			5925.000	55.822	51.569	-12.378	68.200	4.254	PK
7		*	5932.920	58.396	54.129	-9.804	68.200	4.268	PK

Note: Measure Level (dBμV/m) = Reading Level (dBμV) + Factor (dB)

Factor (dB) = Cable Loss (dB) + Antenna Factor (dB) (dB/m) - Pre\_Amplifier Gain (dB)



Site: AC1	Time: 2017/12/02 - 12:00
Limit: FCC_Part15.407_RE(3m)	Engineer: Bruce Wang
Probe: BBHA9120D_1-18GHz	Polarity: Vertical
EUT: Cassia Bluetooth Router	Power: AC 120V/60Hz
Note: Transmit by 802.11a at Channel 5825MHz	

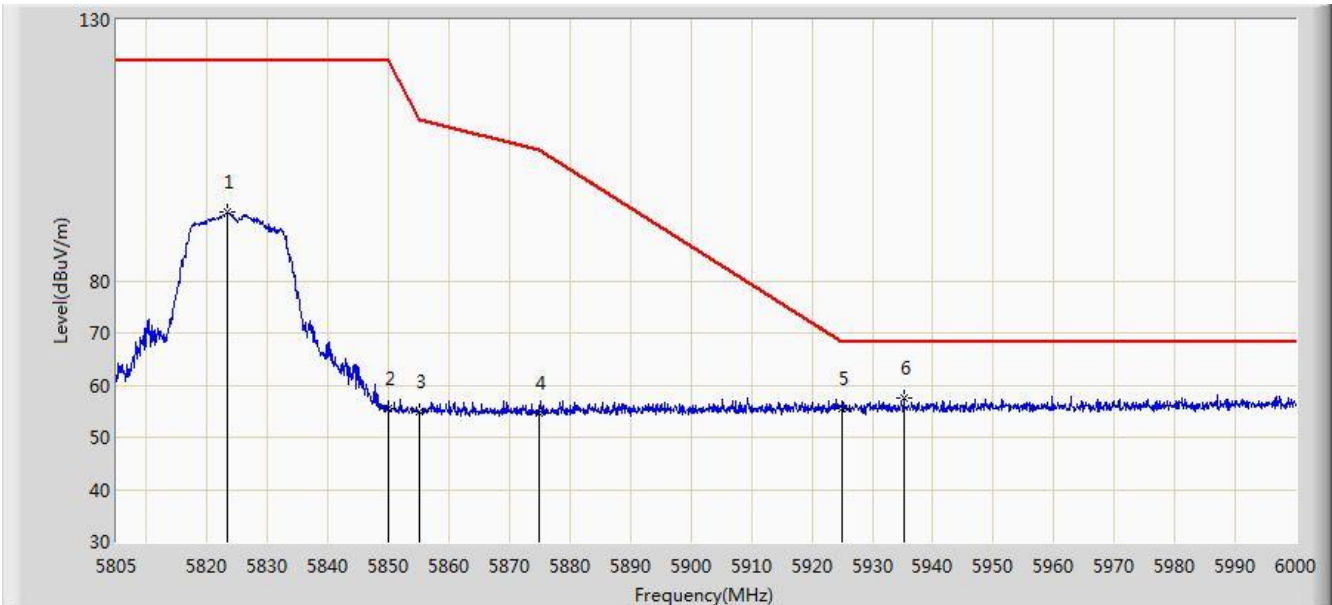

No	Flag	Mark	Frequency (MHz)	Measure Level (dBuV/m)	Reading Level (dBuV)	Over Limit (dB)	Limit (dBuV/m)	Factor (dB)	Type
1			5823.232	93.048	89.047	N/A	N/A	4.001	PK
2			5850.000	55.462	51.405	-66.738	122.200	4.058	PK
3			5855.000	55.003	50.943	-55.797	110.800	4.060	PK
4			5875.000	54.636	50.531	-50.564	105.200	4.105	PK
5			5925.000	55.633	51.380	-12.567	68.200	4.254	PK
6		*	5935.260	57.593	53.325	-10.607	68.200	4.269	PK

Note: Measure Level (dB $\mu$ V/m) = Reading Level (dB $\mu$ V) + Factor (dB)

Factor (dB) = Cable Loss (dB) + Antenna Factor (dB) (dB/m) - Pre\_Amplifier Gain (dB)

Site: AC1	Time: 2017/12/02 - 12:04
Limit: FCC_Part15.209_RE(3m)	Engineer: Bruce Wang
Probe: BBHA9120D_1-18GHz	Polarity: Horizontal
EUT: Cassia Bluetooth Router	Power: AC 120V/60Hz
Note: Transmit by 802.11n-HT20 at Channel 5180MHz	

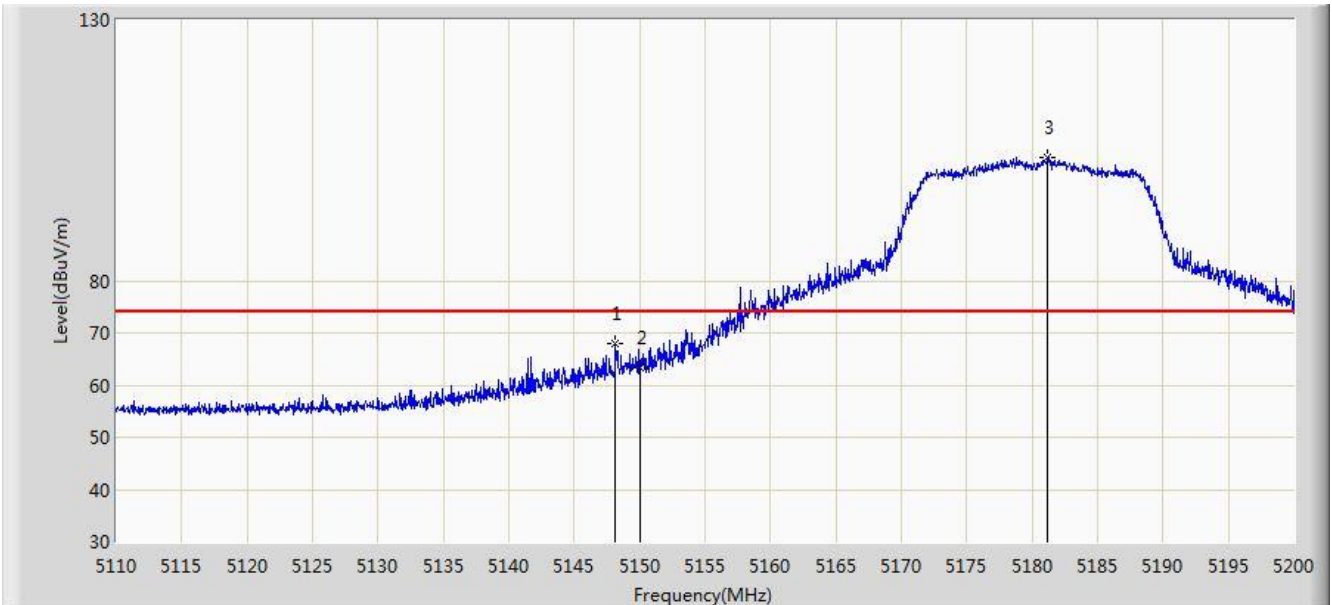

No	Flag	Mark	Frequency (MHz)	Measure Level (dBuV/m)	Reading Level (dBuV)	Over Limit (dB)	Limit (dBuV/m)	Factor (dB)	Type
1			5148.115	67.929	64.620	-6.071	74.000	3.309	PK
2			5150.000	63.199	59.890	-10.801	74.000	3.309	PK
3		*	5181.190	103.530	100.258	N/A	N/A	3.272	PK

Note: Measure Level (dBμV/m) = Reading Level (dBμV) + Factor (dB)

Factor (dB) = Cable Loss (dB) + Antenna Factor (dB) (dB/m) - Pre\_Amplifier Gain (dB)

Site: AC1	Time: 2017/12/02 - 12:09
Limit: FCC_Part15.209_RE(3m)	Margin: 0
Probe: BBHA9120D_1-18GHz	Polarity: Horizontal
EUT: Cassia Bluetooth Router	Power: AC 120V/60Hz
Note: Transmit by 802.11n-HT20 at Channel 5180MHz	

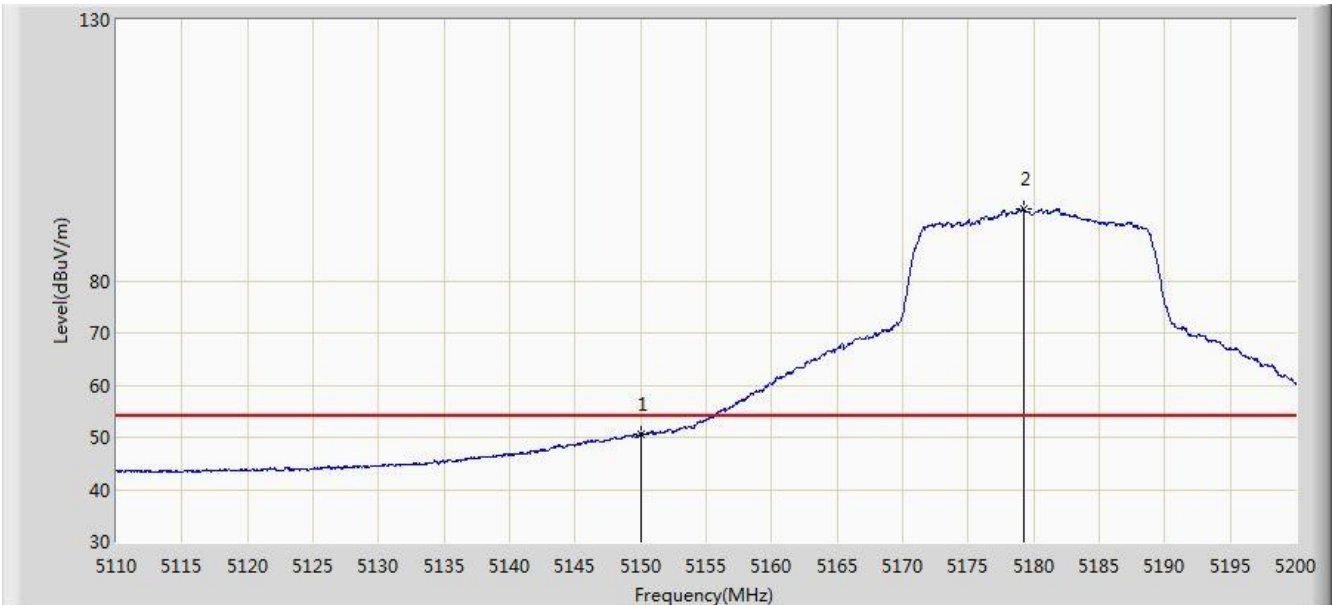

No	Flag	Mark	Frequency (MHz)	Measure Level (dBuV/m)	Reading Level (dBuV)	Over Limit (dB)	Limit (dBuV/m)	Factor (dB)	Type
1			5150.000	50.714	47.405	-3.286	54.000	3.309	AV
2		*	5179.255	93.787	90.513	N/A	N/A	3.274	AV

Note: Measure Level (dB $\mu$ V/m) = Reading Level (dB $\mu$ V) + Factor (dB)

Factor (dB) = Cable Loss (dB) + Antenna Factor (dB) (dB/m) - Pre\_Amplifier Gain (dB)

Site: AC1	Time: 2017/12/02 - 12:10
Limit: FCC_Part15.209_RE(3m)	Engineer: Bruce Wang
Probe: BBHA9120D_1-18GHz	Polarity: Vertical
EUT: Cassia Bluetooth Router	Power: AC 120V/60Hz
Note: Transmit by 802.11n-HT20 at Channel 5180MHz	

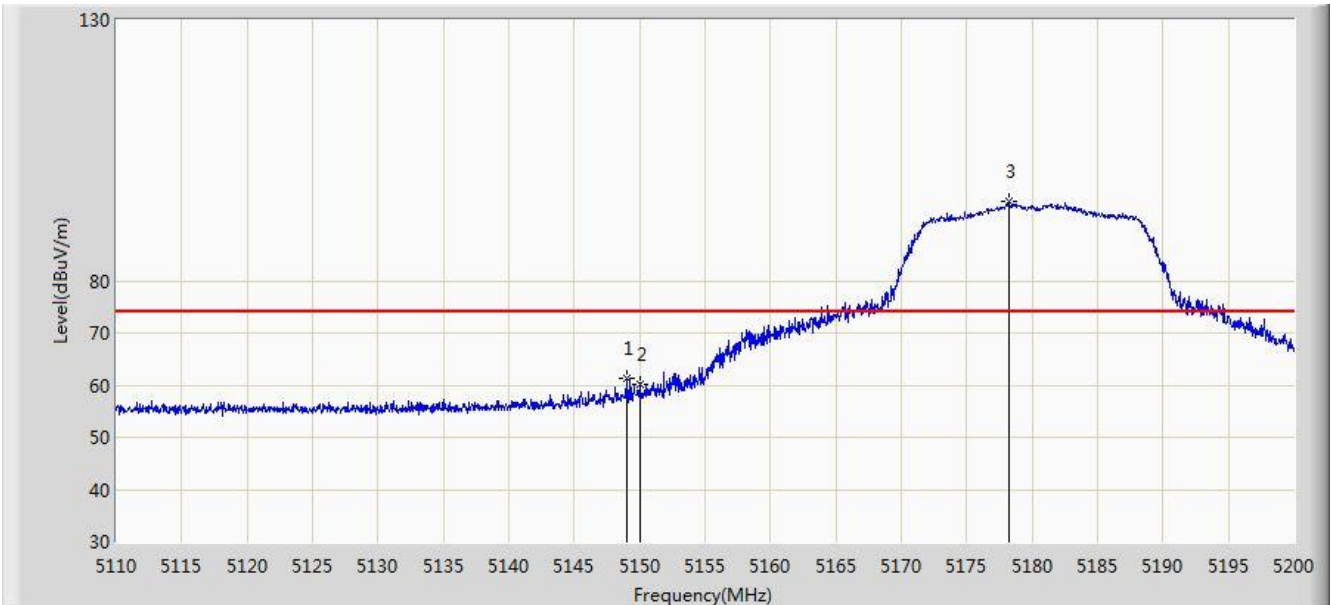

No	Flag	Mark	Frequency (MHz)	Measure Level (dBuV/m)	Reading Level (dBuV)	Over Limit (dB)	Limit (dBuV/m)	Factor (dB)	Type
1			5148.970	61.214	57.905	-12.786	74.000	3.308	PK
2			5150.000	60.186	56.877	-13.814	74.000	3.309	PK
3		*	5178.265	95.274	92.000	N/A	N/A	3.275	PK

Note: Measure Level (dB $\mu$ V/m) = Reading Level (dB $\mu$ V) + Factor (dB)

Factor (dB) = Cable Loss (dB) + Antenna Factor (dB) (dB/m) - Pre\_Amplifier Gain (dB)

Site: AC1	Time: 2017/12/02 - 12:12
Limit: FCC_Part15.209_RE(3m)	Engineer: Bruce Wang
Probe: BBHA9120D_1-18GHz	Polarity: Vertical
EUT: Cassia Bluetooth Router	Power: AC 120V/60Hz
Note: Transmit by 802.11n-HT20 at Channel 5180MHz	

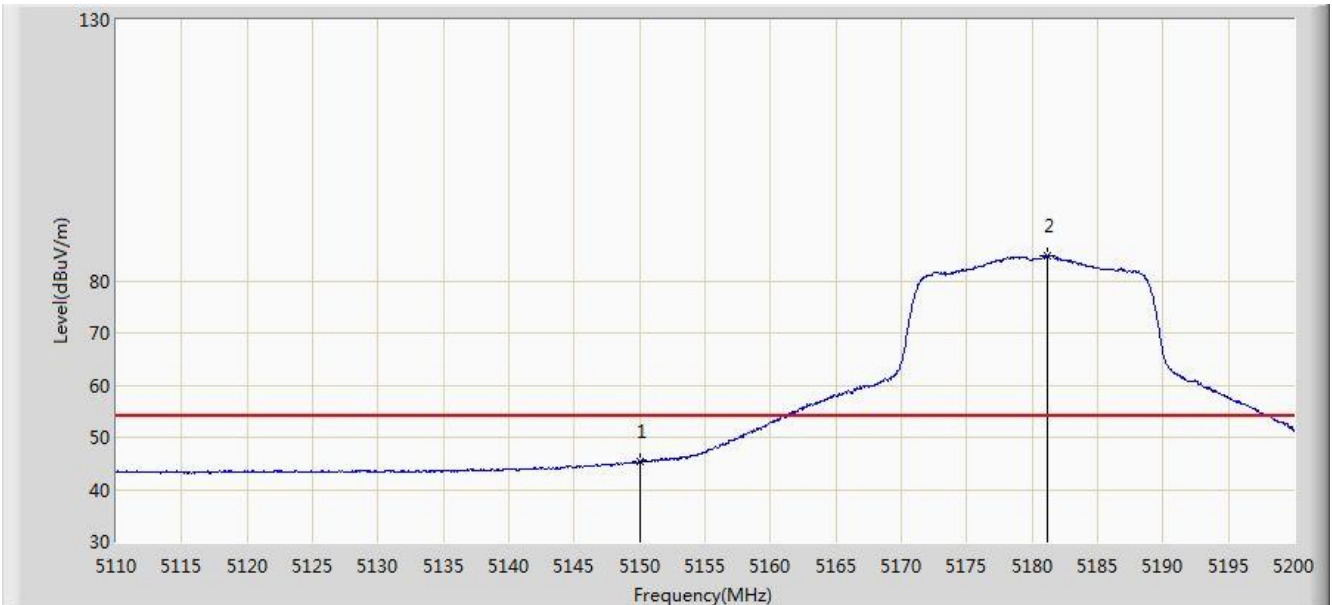

No	Flag	Mark	Frequency (MHz)	Measure Level (dBuV/m)	Reading Level (dBuV)	Over Limit (dB)	Limit (dBuV/m)	Factor (dB)	Type
1			5150.000	45.419	42.110	-8.581	54.000	3.309	AV
2		*	5181.145	84.779	81.507	N/A	N/A	3.272	AV

Note: Measure Level (dB $\mu$ V/m) = Reading Level (dB $\mu$ V) + Factor (dB)

Factor (dB) = Cable Loss (dB) + Antenna Factor (dB) (dB/m) - Pre\_Amplifier Gain (dB)

Site: AC1	Time: 2017/12/02 - 12:15
Limit: FCC_Part15.407_RE(3m)	Engineer: Bruce Wang
Probe: BBHA9120D_1-18GHz	Polarity: Horizontal
EUT: Cassia Bluetooth Router	Power: AC 120V/60Hz
Note: Transmit by 802.11n-HT20 at Channel 5745MHz	

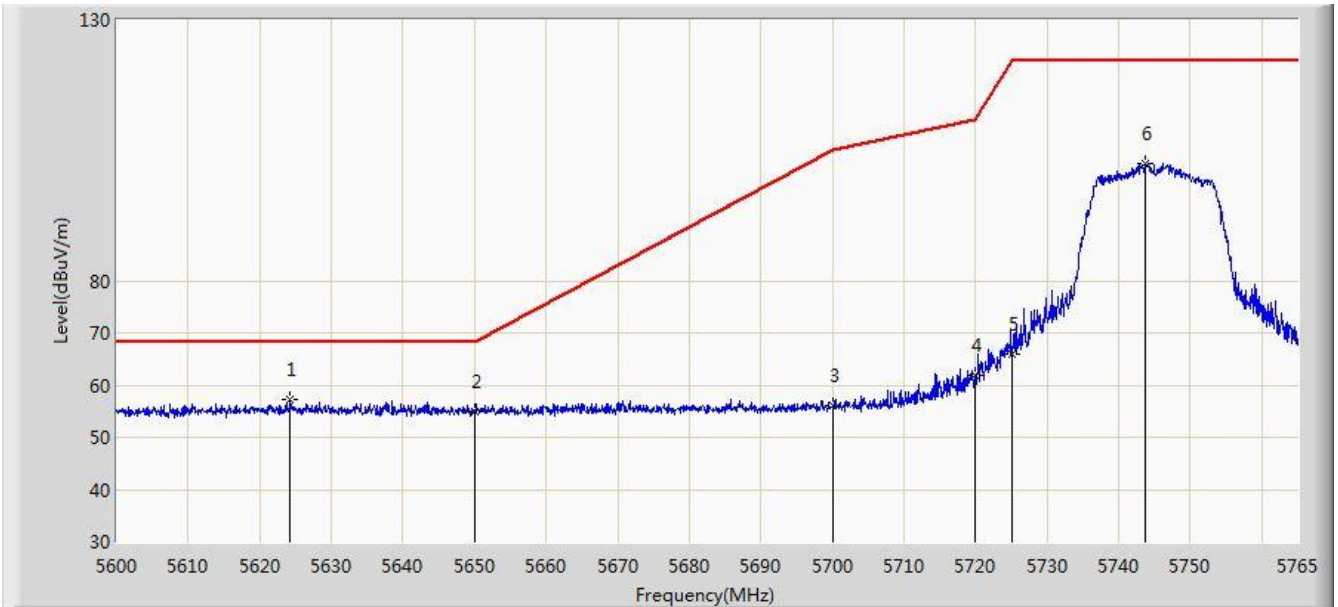

No	Flag	Mark	Frequency (MHz)	Measure Level (dBuV/m)	Reading Level (dBuV)	Over Limit (dB)	Limit (dBuV/m)	Factor (dB)	Type
1		*	5624.255	57.391	53.837	-10.809	68.200	3.553	PK
2			5650.000	55.072	51.445	-13.128	68.200	3.627	PK
3			5700.000	56.097	52.378	-49.103	105.200	3.719	PK
4			5720.000	62.024	58.248	-48.776	110.800	3.776	PK
5			5725.000	65.896	62.105	-56.304	122.200	3.791	PK
6			5743.797	102.545	98.697	N/A	N/A	3.848	PK

Note: Measure Level (dB $\mu$ V/m) = Reading Level (dB $\mu$ V) + Factor (dB)

Factor (dB) = Cable Loss (dB) + Antenna Factor (dB) (dB/m) - Pre\_Amplifier Gain (dB)

Site: AC1	Time: 2017/12/02 - 12:17
Limit: FCC_Part15.407_RE(3m)	Engineer: Bruce Wang
Probe: BBHA9120D_1-18GHz	Polarity: Vertical
EUT: Cassia Bluetooth Router	Power: AC 120V/60Hz
Note: Transmit by 802.11n-HT20 at Channel 5745MHz	

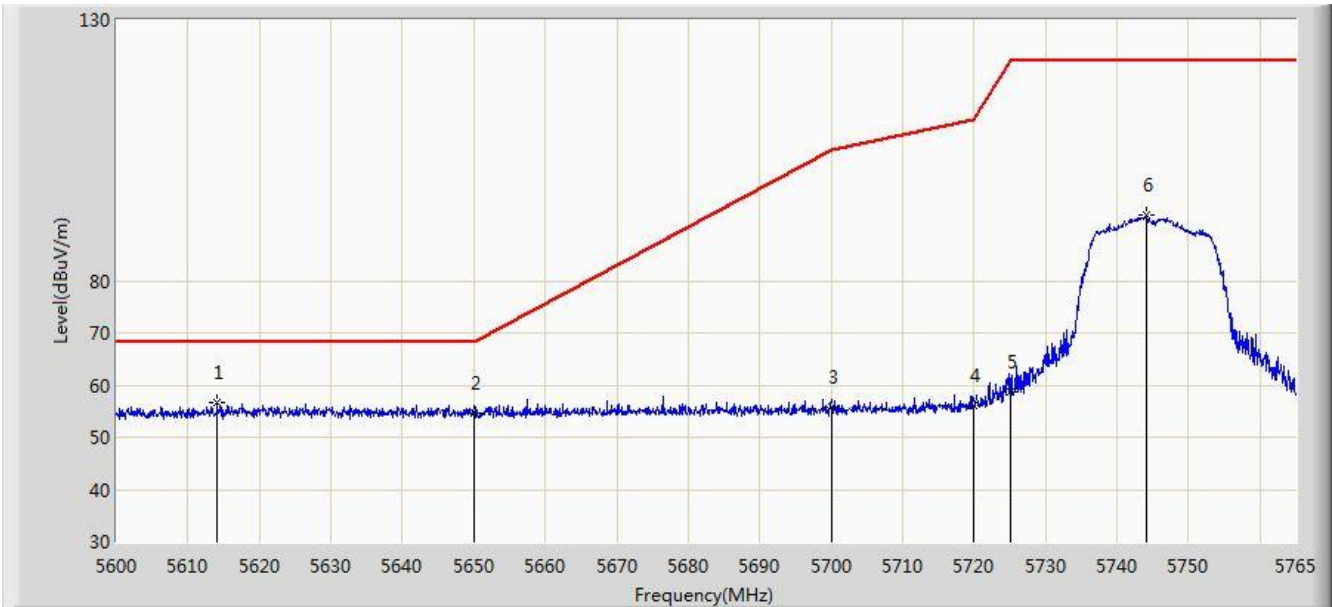

No	Flag	Mark	Frequency (MHz)	Measure Level (dBuV/m)	Reading Level (dBuV)	Over Limit (dB)	Limit (dBuV/m)	Factor (dB)	Type
1		*	5614.107	56.522	52.998	-11.678	68.200	3.524	PK
2			5650.000	54.660	51.033	-13.540	68.200	3.627	PK
3			5700.000	55.717	51.998	-49.483	105.200	3.719	PK
4			5720.000	56.088	52.312	-54.712	110.800	3.776	PK
5			5725.000	58.591	54.800	-63.609	122.200	3.791	PK
6			5744.045	92.616	88.767	N/A	N/A	3.849	PK

Note: Measure Level (dB $\mu$ V/m) = Reading Level (dB $\mu$ V) + Factor (dB)

Factor (dB) = Cable Loss (dB) + Antenna Factor (dB) (dB/m) - Pre\_Amplifier Gain (dB)

Site: AC1	Time: 2017/12/02 - 12:19
Limit: FCC_Part15.407_RE(3m)	Engineer: Bruce Wang
Probe: BBHA9120D_1-18GHz	Polarity: Horizontal
EUT: Cassia Bluetooth Router	Power: AC 120V/60Hz
Note: Transmit by 802.11n-HT20 at Channel 5825MHz, Power=18	

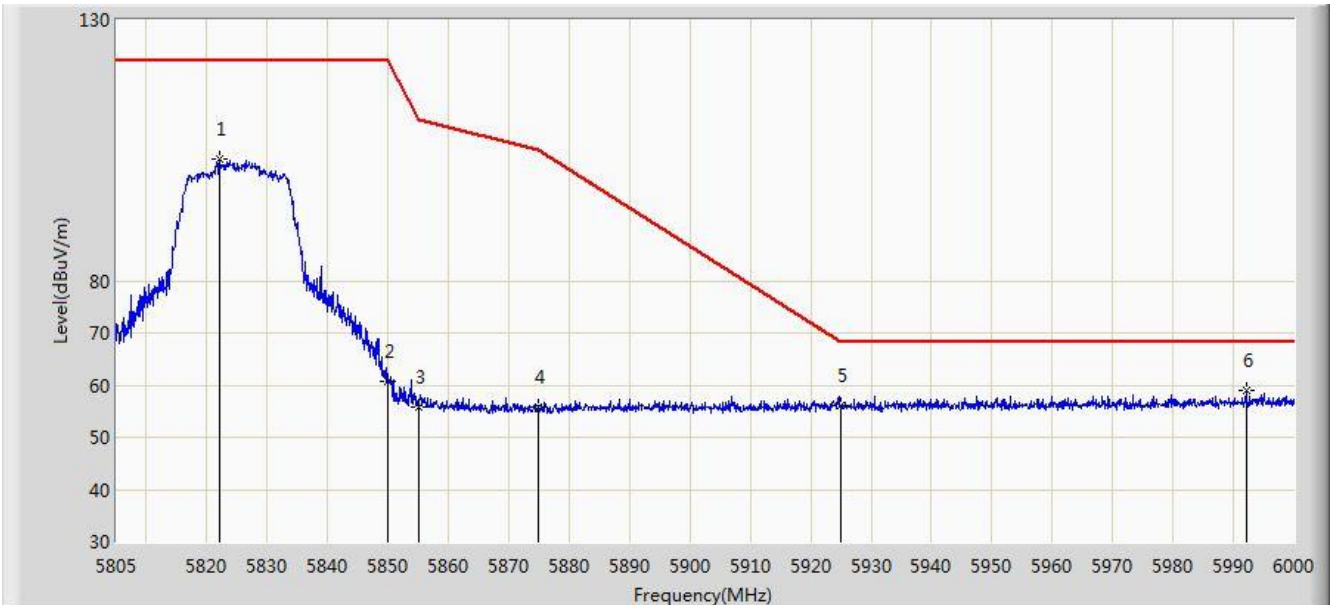

No	Flag	Mark	Frequency (MHz)	Measure Level (dBuV/m)	Reading Level (dBuV)	Over Limit (dB)	Limit (dBuV/m)	Factor (dB)	Type
1			5822.160	103.404	99.405	N/A	N/A	3.999	PK
2			5850.000	60.673	56.616	-61.527	122.200	4.058	PK
3			5855.000	55.914	51.854	-54.886	110.800	4.060	PK
4			5875.000	55.721	51.616	-49.479	105.200	4.105	PK
5			5925.000	55.978	51.725	-12.222	68.200	4.254	PK
6		*	5992.200	58.934	54.672	-9.266	68.200	4.262	PK

Note: Measure Level (dBμV/m) = Reading Level (dBμV) + Factor (dB)

Factor (dB) = Cable Loss (dB) + Antenna Factor (dB) (dB/m) - Pre\_Amplifier Gain (dB)



Site: AC1	Time: 2017/12/02 - 12:21
Limit: FCC_Part15.407_RE(3m)	Engineer: Bruce Wang
Probe: BBHA9120D_1-18GHz	Polarity: Vertical
EUT: Cassia Bluetooth Router	Power: AC 120V/60Hz
Note: Transmit by 802.11n-HT20 at Channel 5825MHz, Power=18	

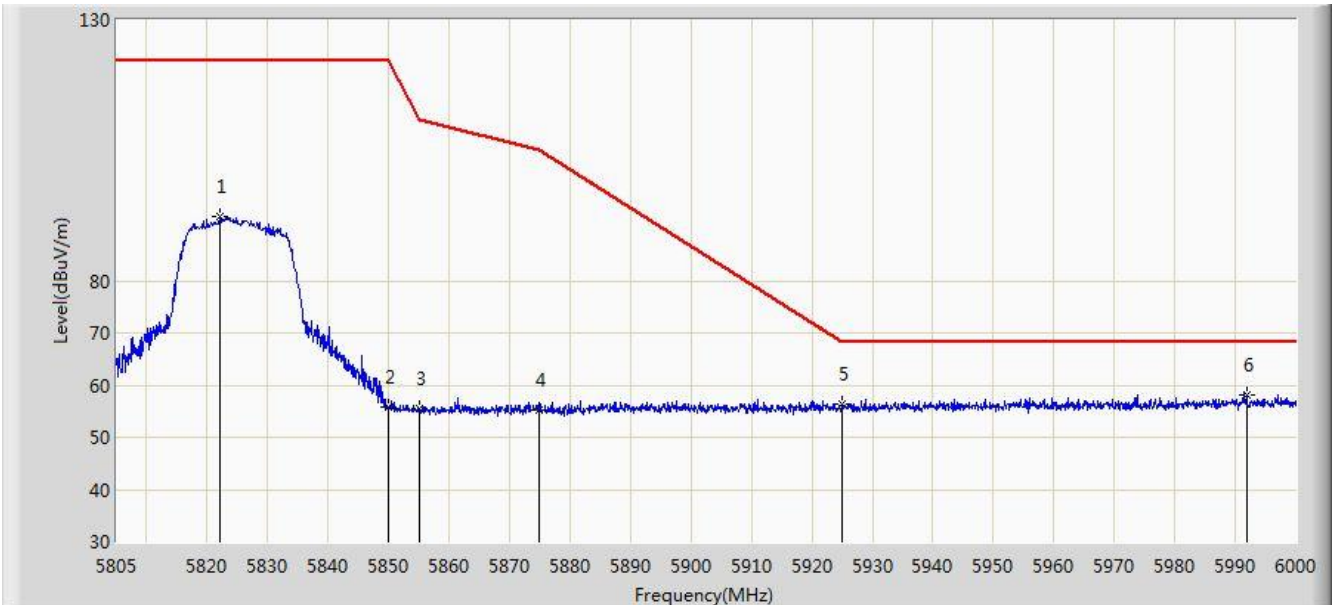

No	Flag	Mark	Frequency (MHz)	Measure Level (dBuV/m)	Reading Level (dBuV)	Over Limit (dB)	Limit (dBuV/m)	Factor (dB)	Type
1			5822.160	92.340	88.341	N/A	N/A	3.999	PK
2			5850.000	55.714	51.657	-66.486	122.200	4.058	PK
3			5855.000	55.408	51.348	-55.392	110.800	4.060	PK
4			5875.000	55.162	51.057	-50.038	105.200	4.105	PK
5			5925.000	56.293	52.040	-11.907	68.200	4.254	PK
6		*	5991.908	58.184	53.922	-10.016	68.200	4.262	PK

Note: Measure Level (dB $\mu$ V/m) = Reading Level (dB $\mu$ V) + Factor (dB)

Factor (dB) = Cable Loss (dB) + Antenna Factor (dB) (dB/m) - Pre\_Amplifier Gain (dB)

Site: AC1	Time: 2017/12/02 - 12:37
Limit: FCC_Part15.209_RE(3m)	Engineer: Bruce Wang
Probe: BBHA9120D_1-18GHz	Polarity: Horizontal
EUT: Cassia Bluetooth Router	Power: AC 120V/60Hz
Note: Transmit by 802.11n-HT40 at Channel 5190MHz	

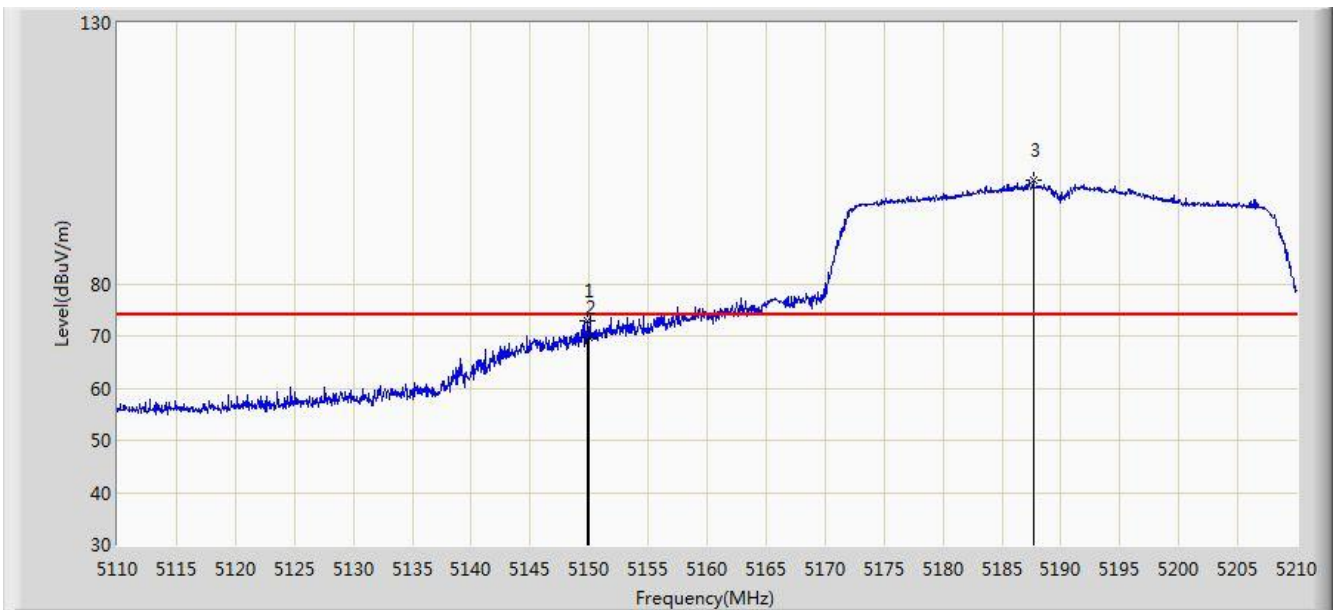

No	Flag	Mark	Frequency (MHz)	Measure Level (dBuV/m)	Reading Level (dBuV)	Over Limit (dB)	Limit (dBuV/m)	Factor (dB)	Type
1			5149.800	73.028	69.719	-0.972	74.000	3.309	PK
2			5150.000	69.779	66.470	-4.221	74.000	3.309	PK
3		*	5187.650	99.849	96.585	25.849	74.000	3.264	PK

Note: Measure Level (dB $\mu$ V/m) = Reading Level (dB $\mu$ V) + Factor (dB)

Factor (dB) = Cable Loss (dB) + Antenna Factor (dB) (dB/m) - Pre\_Amplifier Gain (dB)

Site: AC1	Time: 2017/12/02 - 12:36
Limit: FCC_Part15.209_RE(3m)	Engineer: Bruce Wang
Probe: BBHA9120D_1-18GHz	Polarity: Horizontal
EUT: Cassia Bluetooth Router	Power: AC 120V/60Hz
Note: Transmit by 802.11n-HT40 at Channel 5190MHz	

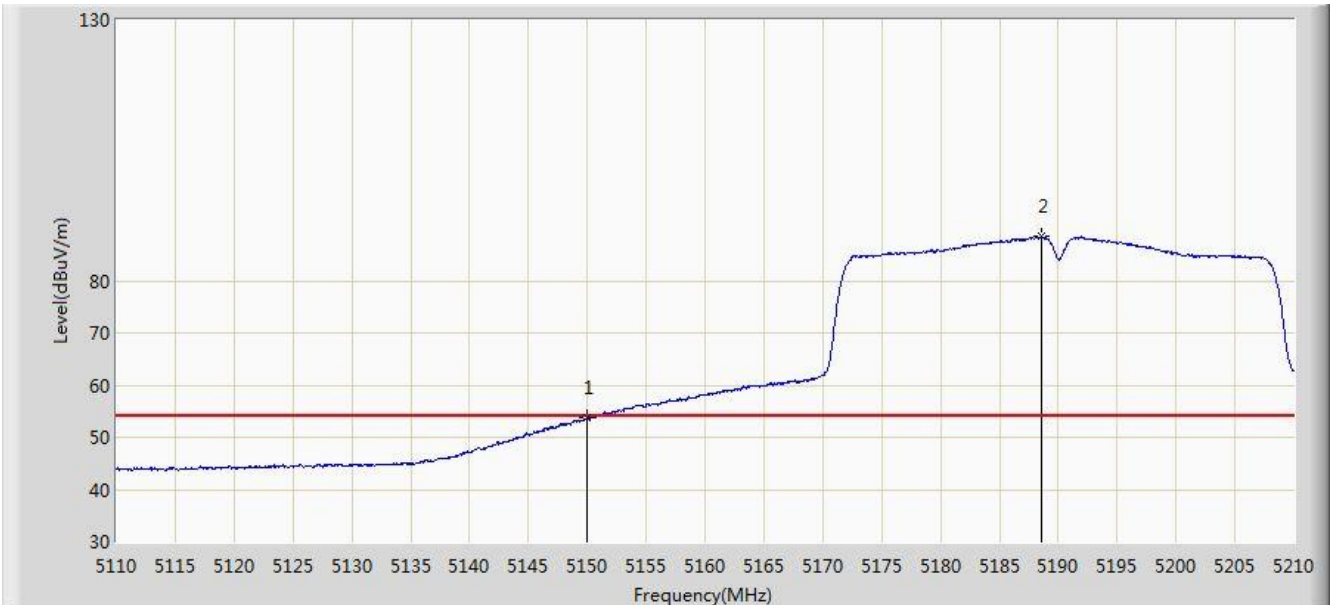

No	Flag	Mark	Frequency (MHz)	Measure Level (dBuV/m)	Reading Level (dBuV)	Over Limit (dB)	Limit (dBuV/m)	Factor (dB)	Type
1			5150.000	53.690	50.381	-0.310	54.000	3.309	AV
2		*	5188.550	88.462	85.200	N/A	N/A	3.263	AV

Note: Measure Level (dB $\mu$ V/m) = Reading Level (dB $\mu$ V) + Factor (dB)

Factor (dB) = Cable Loss (dB) + Antenna Factor (dB) (dB/m) - Pre\_Amplifier Gain (dB)

Site: AC1	Time: 2017/12/02 - 12:38
Limit: FCC_Part15.209_RE(3m)	Engineer: Bruce Wang
Probe: BBHA9120D_1-18GHz	Polarity: Vertical
EUT: Cassia Bluetooth Router	Power: AC 120V/60Hz
Note: Transmit by 802.11n-HT40 at Channel 5190MHz	

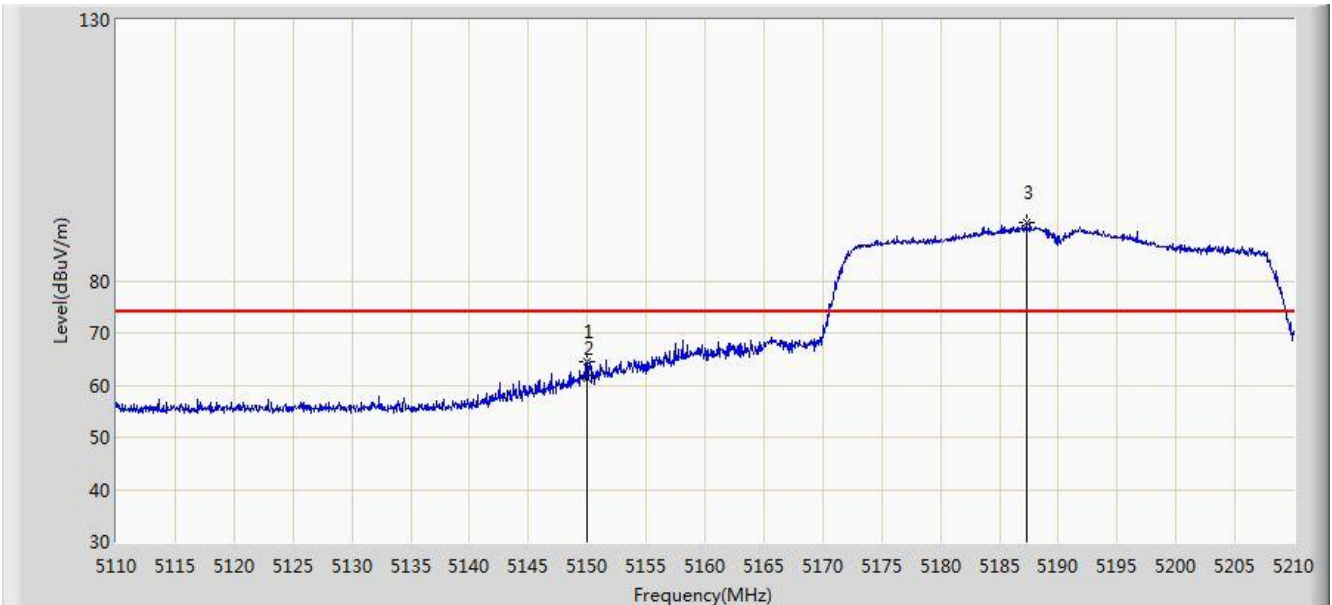

No	Flag	Mark	Frequency (MHz)	Measure Level (dBuV/m)	Reading Level (dBuV)	Over Limit (dB)	Limit (dBuV/m)	Factor (dB)	Type
1			5149.950	64.628	61.319	-9.372	74.000	3.309	PK
2			5150.000	61.355	58.046	-12.645	74.000	3.309	PK
3		*	5187.300	91.180	87.916	N/A	N/A	3.265	PK

Note: Measure Level (dB $\mu$ V/m) = Reading Level (dB $\mu$ V) + Factor (dB)

Factor (dB) = Cable Loss (dB) + Antenna Factor (dB) (dB/m) - Pre\_Amplifier Gain (dB)

Site: AC1	Time: 2017/12/02 - 12:41
Limit: FCC_Part15.209_RE(3m)	Engineer: Bruce Wang
Probe: BBHA9120D_1-18GHz	Polarity: Vertical
EUT: Cassia Bluetooth Router	Power: AC 120V/60Hz
Note: Transmit by 802.11n-HT40 at Channel 5190MHz	

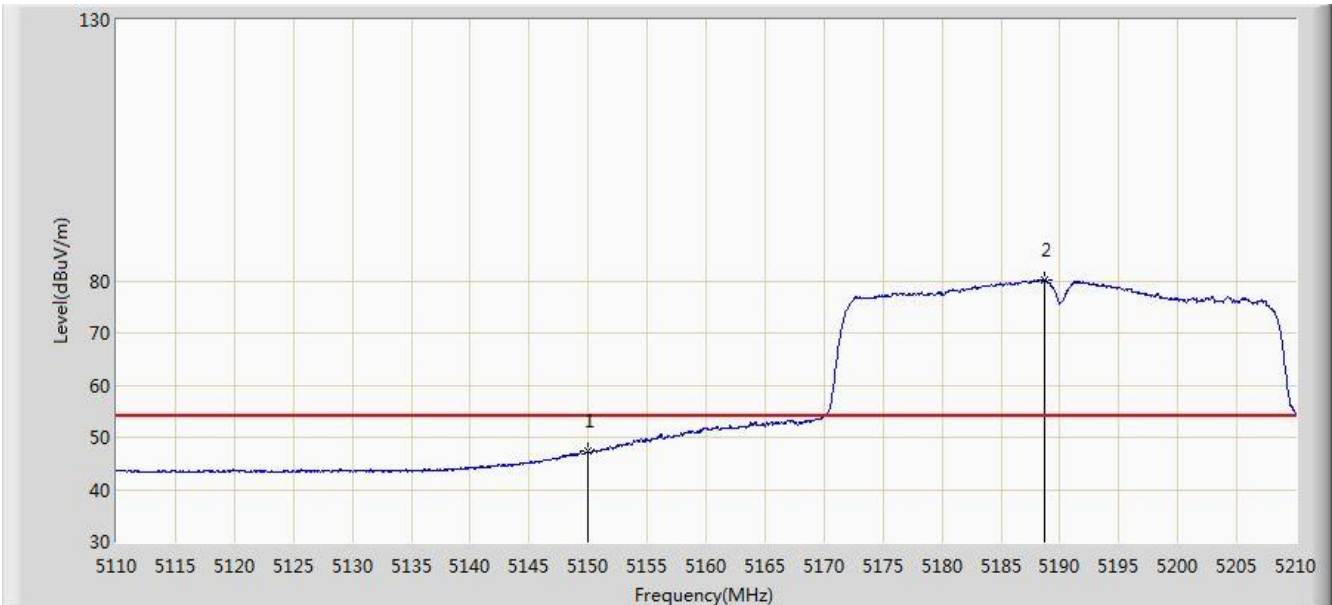

No	Flag	Mark	Frequency (MHz)	Measure Level (dBuV/m)	Reading Level (dBuV)	Over Limit (dB)	Limit (dBuV/m)	Factor (dB)	Type
1			5150.000	47.259	43.950	-6.741	54.000	3.309	AV
2		*	5188.700	80.168	76.906	N/A	N/A	3.262	AV

Note: Measure Level (dB $\mu$ V/m) = Reading Level (dB $\mu$ V) + Factor (dB)

Factor (dB) = Cable Loss (dB) + Antenna Factor (dB) (dB/m) - Pre\_Amplifier Gain (dB)

Site: AC1	Time: 2017/12/02 - 12:45
Limit: FCC_Part15.407_RE(3m)	Engineer: Bruce Wang
Probe: BBHA9120D_1-18GHz	Polarity: Horizontal
EUT: Cassia Bluetooth Router	Power: AC 120V/60Hz
Note: Transmit by 802.11n-HT40 at Channel 5755MHz	

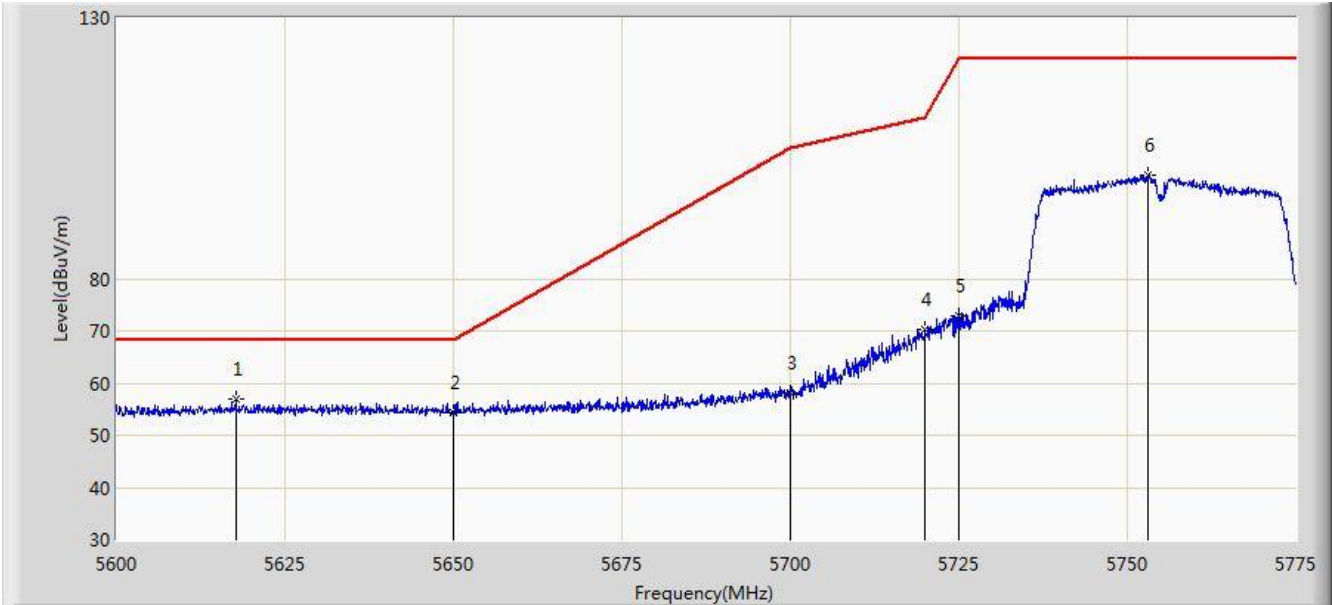

No	Flag	Mark	Frequency (MHz)	Measure Level (dBuV/m)	Reading Level (dBuV)	Over Limit (dB)	Limit (dBuV/m)	Factor (dB)	Type
1		*	5617.675	56.915	53.381	-11.285	68.200	3.534	PK
2			5650.000	54.322	50.695	-13.878	68.200	3.627	PK
3			5700.000	57.994	54.275	-47.206	105.200	3.719	PK
4			5720.000	70.196	66.420	-40.604	110.800	3.776	PK
5			5725.000	72.767	68.976	-49.433	122.200	3.791	PK
6			5753.125	99.971	96.088	N/A	N/A	3.883	PK

Note: Measure Level (dBμV/m) = Reading Level (dBμV) + Factor (dB)

Factor (dB) = Cable Loss (dB) + Antenna Factor (dB) (dB/m) - Pre\_Amplifier Gain (dB)

Site: AC1	Time: 2017/12/02 - 12:46
Limit: FCC_Part15.407_RE(3m)	Engineer: Bruce Wang
Probe: BBHA9120D_1-18GHz	Polarity: Vertical
EUT: Cassia Bluetooth Router	Power: AC 120V/60Hz
Note: Transmit by 802.11n-HT40 at Channel 5755MHz	

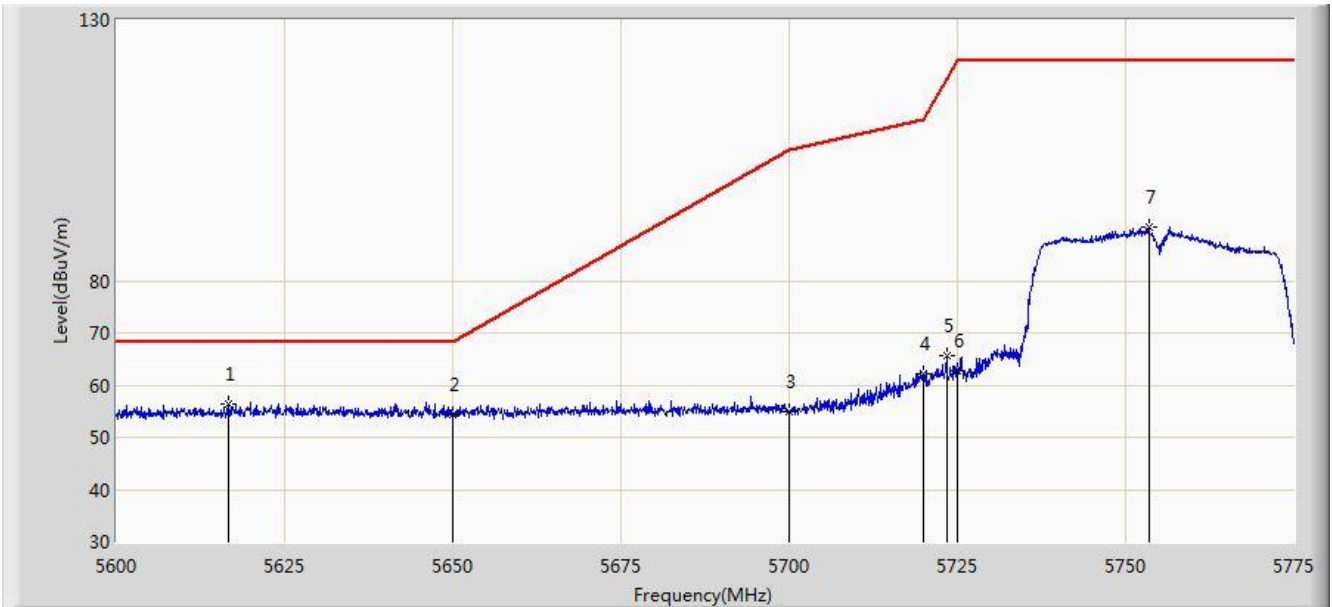

No	Flag	Mark	Frequency (MHz)	Measure Level (dBuV/m)	Reading Level (dBuV)	Over Limit (dB)	Limit (dBuV/m)	Factor (dB)	Type
1		*	5616.712	56.515	52.983	-11.685	68.200	3.531	PK
2			5650.000	54.449	50.822	-13.751	68.200	3.627	PK
3			5700.000	54.923	51.204	-50.277	105.200	3.719	PK
4			5720.000	62.218	58.442	-48.582	110.800	3.776	PK
5			5723.462	65.788	62.002	-52.906	118.694	3.786	PK
6			5725.000	62.730	58.939	-59.470	122.200	3.791	PK
7			5753.475	90.248	86.364	N/A	N/A	3.884	PK

Note: Measure Level (dB $\mu$ V/m) = Reading Level (dB $\mu$ V) + Factor (dB)

Factor (dB) = Cable Loss (dB) + Antenna Factor (dB) (dB/m) - Pre\_Amplifier Gain (dB)

Site: AC1	Time: 2017/12/02 - 12:49
Limit: FCC_Part15.407_RE(3m)	Engineer: Bruce Wang
Probe: BBHA9120D_1-18GHz	Polarity: Horizontal
EUT: Cassia Bluetooth Router	Power: AC 120V/60Hz
Note: Transmit by 802.11n-HT40 at Channel 5795MHz	

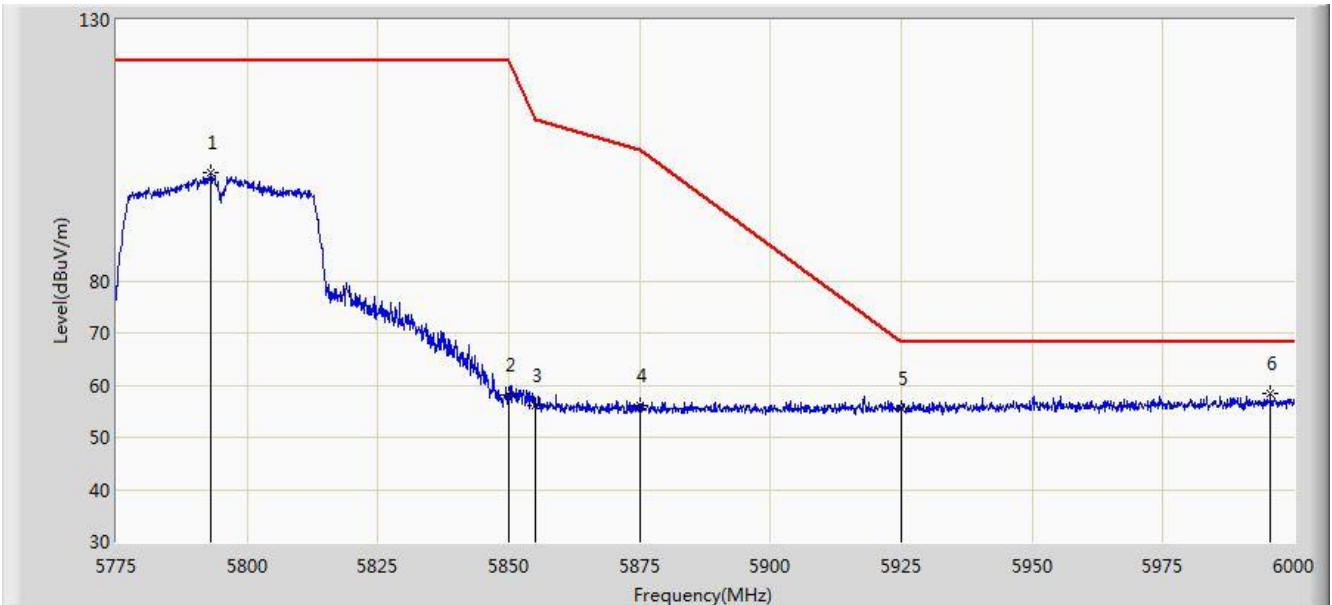

No	Flag	Mark	Frequency (MHz)	Measure Level (dBuV/m)	Reading Level (dBuV)	Over Limit (dB)	Limit (dBuV/m)	Factor (dB)	Type
1			5793.112	100.662	96.711	N/A	N/A	3.951	PK
2			5850.000	58.244	54.187	-63.956	122.200	4.058	PK
3			5855.000	56.110	52.050	-54.690	110.800	4.060	PK
4			5875.000	55.952	51.847	-49.248	105.200	4.105	PK
5			5925.000	55.397	51.144	-12.803	68.200	4.254	PK
6		*	5995.612	58.537	54.281	-9.663	68.200	4.256	PK

Note: Measure Level (dB $\mu$ V/m) = Reading Level (dB $\mu$ V) + Factor (dB)

Factor (dB) = Cable Loss (dB) + Antenna Factor (dB) (dB/m) - Pre\_Amplifier Gain (dB)



Site: AC1	Time: 2017/12/02 - 12:51
Limit: FCC_Part15.407_RE(3m)	Engineer: Bruce Wang
Probe: BBHA9120D_1-18GHz	Polarity: Vertical
EUT: Cassia Bluetooth Router	Power: AC 120V/60Hz
Note: Transmit by 802.11n-HT40 at Channel 5795MHz	

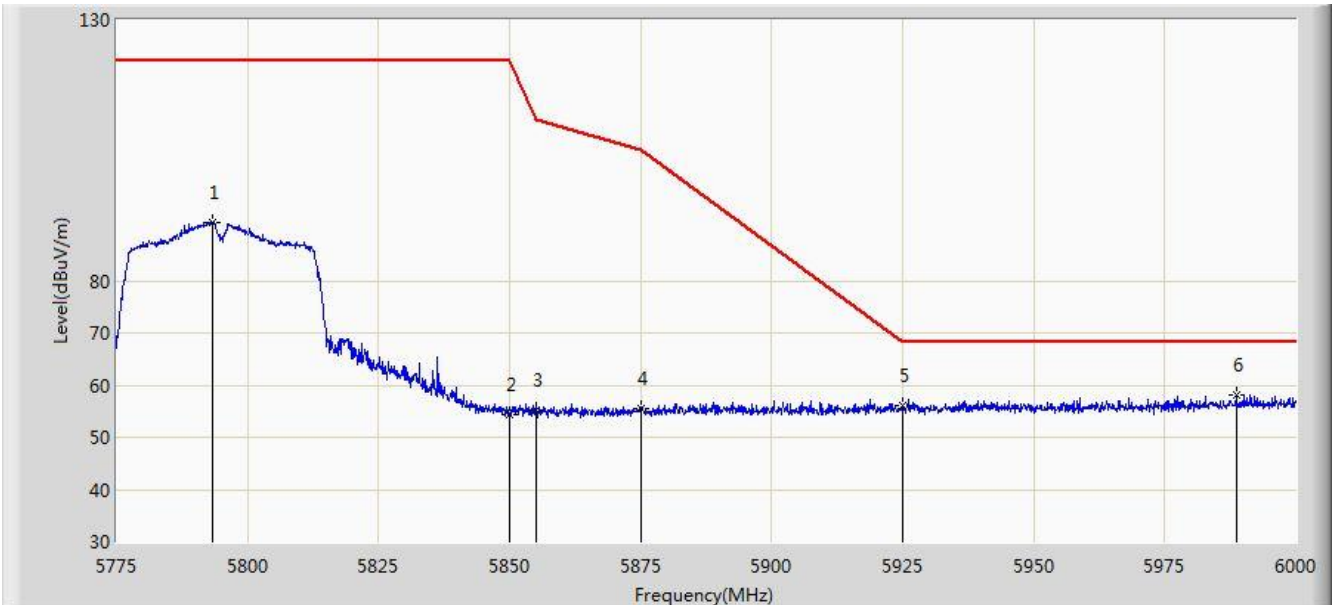

No	Flag	Mark	Frequency (MHz)	Measure Level (dBuV/m)	Reading Level (dBuV)	Over Limit (dB)	Limit (dBuV/m)	Factor (dB)	Type
1			5793.450	91.286	87.334	N/A	N/A	3.952	PK
2			5850.000	54.237	50.180	-67.963	122.200	4.058	PK
3			5855.000	55.200	51.140	-55.600	110.800	4.060	PK
4			5875.000	55.520	51.415	-49.680	105.200	4.105	PK
5			5925.000	56.093	51.840	-12.107	68.200	4.254	PK
6		*	5988.638	58.204	53.936	-9.996	68.200	4.268	PK

Note: Measure Level (dB $\mu$ V/m) = Reading Level (dB $\mu$ V) + Factor (dB)

Factor (dB) = Cable Loss (dB) + Antenna Factor (dB) (dB/m) - Pre\_Amplifier Gain (dB)

Site: AC1	Time: 2017/12/02 - 12:52
Limit: FCC_Part15.209_RE(3m)	Engineer: Bruce Wang
Probe: BBHA9120D_1-18GHz	Polarity: Horizontal
EUT: Cassia Bluetooth Router	Power: AC 120V/60Hz
Note: Transmit by 802.11ac-VHT20 at Channel 5180MHz	

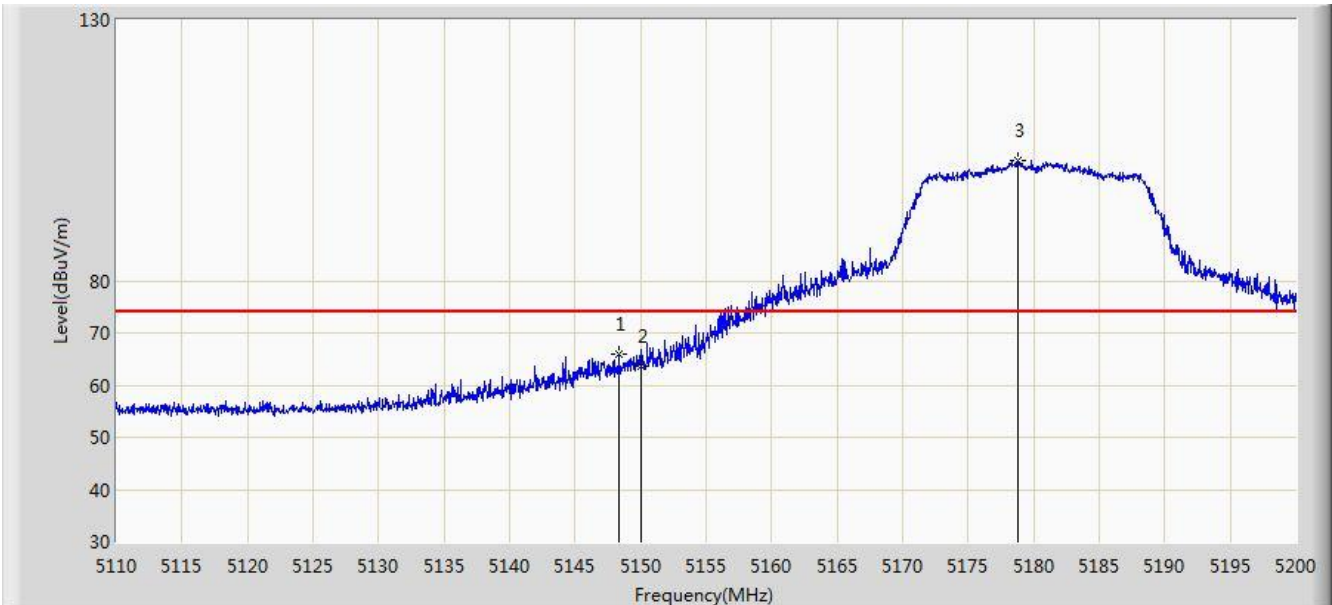

No	Flag	Mark	Frequency (MHz)	Measure Level (dBuV/m)	Reading Level (dBuV)	Over Limit (dB)	Limit (dBuV/m)	Factor (dB)	Type
1			5148.340	65.914	62.605	-8.086	74.000	3.308	PK
2			5150.000	63.565	60.256	-10.435	74.000	3.309	PK
3		*	5178.760	102.985	99.711	N/A	N/A	3.273	PK

Note: Measure Level (dBμV/m) = Reading Level (dBμV) + Factor (dB)

Factor (dB) = Cable Loss (dB) + Antenna Factor (dB) (dB/m) - Pre\_Amplifier Gain (dB)

Site: AC1	Time: 2017/12/02 - 12:59
Limit: FCC_Part15.209_RE(3m)	Engineer: Bruce Wang
Probe: BBHA9120D_1-18GHz	Polarity: Horizontal
EUT: Cassia Bluetooth Router	Power: AC 120V/60Hz
Note: Transmit by 802.11ac-VHT20 at Channel 5180MHz	

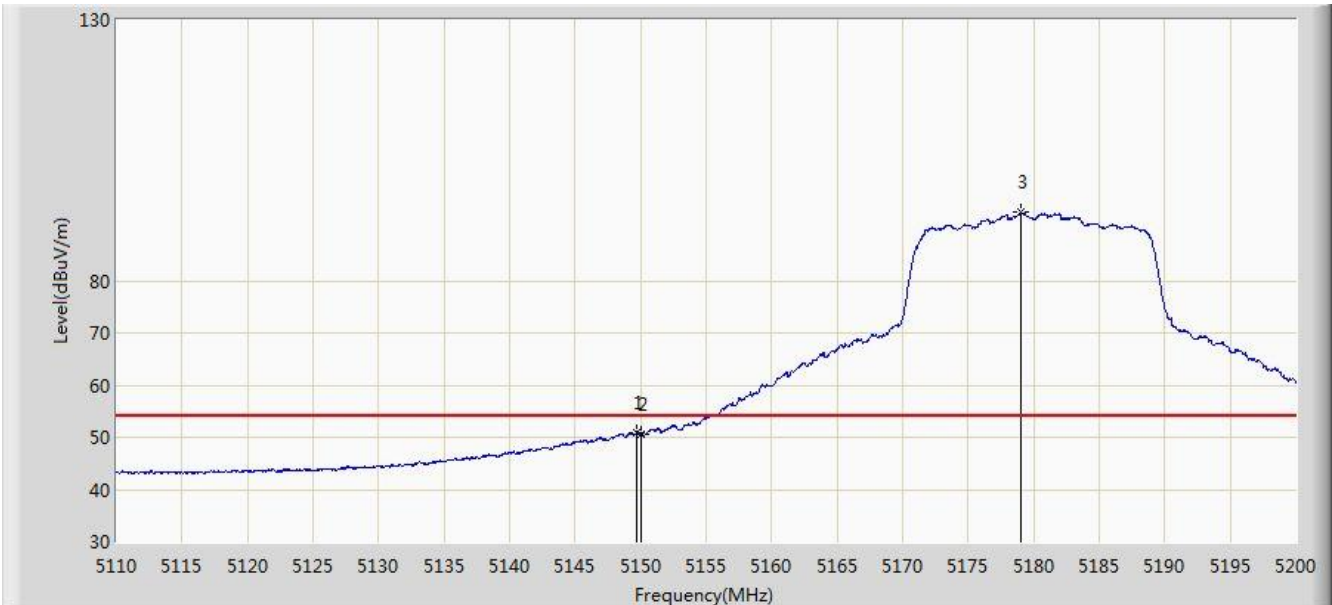

No	Flag	Mark	Frequency (MHz)	Measure Level (dBuV/m)	Reading Level (dBuV)	Over Limit (dB)	Limit (dBuV/m)	Factor (dB)	Type
1			5149.690	51.007	47.698	-2.993	54.000	3.308	AV
2			5150.000	50.572	47.263	-3.428	54.000	3.309	AV
3		*	5179.030	93.099	89.825	N/A	N/A	3.274	AV

Note: Measure Level (dB $\mu$ V/m) = Reading Level (dB $\mu$ V) + Factor (dB)

Factor (dB) = Cable Loss (dB) + Antenna Factor (dB) (dB/m) - Pre\_Amplifier Gain (dB)

Site: AC1	Time: 2017/12/02 - 13:01
Limit: FCC_Part15.209_RE(3m)	Engineer: Bruce Wang
Probe: BBHA9120D_1-18GHz	Polarity: Vertical
EUT: Cassia Bluetooth Router	Power: AC 120V/60Hz
Note: Transmit by 802.11ac-VHT20 at Channel 5180MHz	

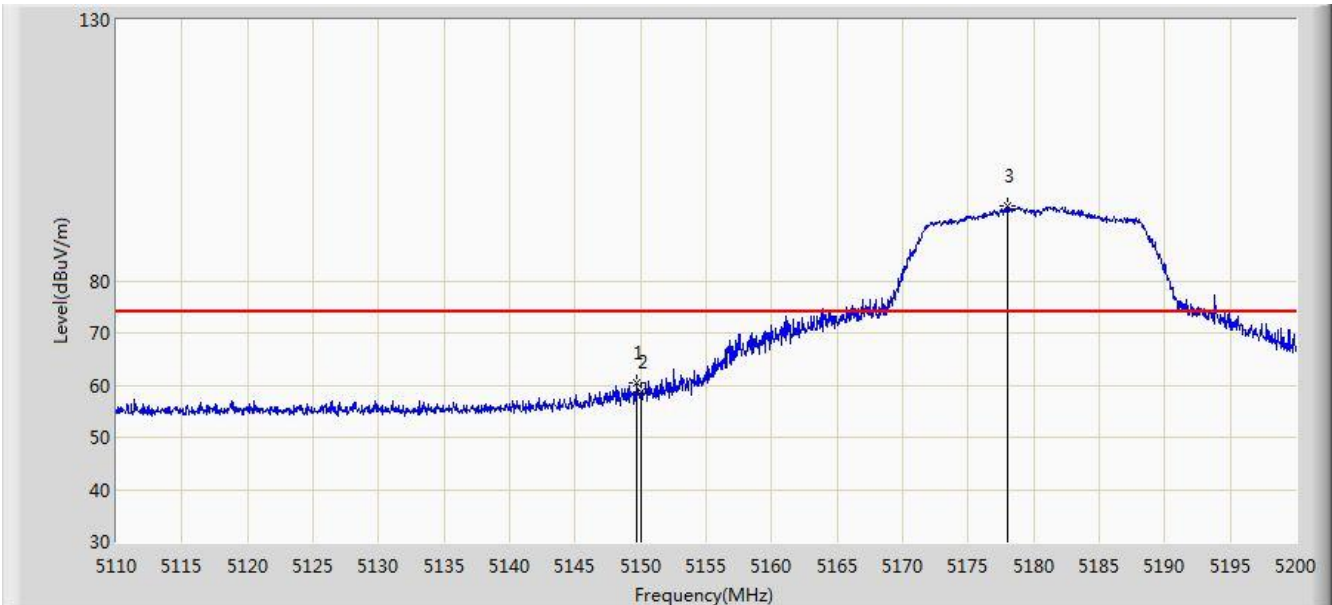

No	Flag	Mark	Frequency (MHz)	Measure Level (dBuV/m)	Reading Level (dBuV)	Over Limit (dB)	Limit (dBuV/m)	Factor (dB)	Type
1			5149.645	60.474	57.165	-13.526	74.000	3.308	PK
2			5150.000	58.653	55.344	-15.347	74.000	3.309	PK
3		*	5178.040	94.306	91.031	N/A	N/A	3.274	PK

Note: Measure Level (dBuV/m) = Reading Level (dBuV) + Factor (dB)

Factor (dB) = Cable Loss (dB) + Antenna Factor (dB) (dB/m) - Pre\_Amplifier Gain (dB)

Site: AC1	Time: 2017/12/02 - 13:03
Limit: FCC_Part15.209_RE(3m)	Engineer: Bruce Wang
Probe: BBHA9120D_1-18GHz	Polarity: Vertical
EUT: Cassia Bluetooth Router	Power: AC 120V/60Hz
Note: Transmit by 802.11ac-VHT20 at Channel 5180MHz	

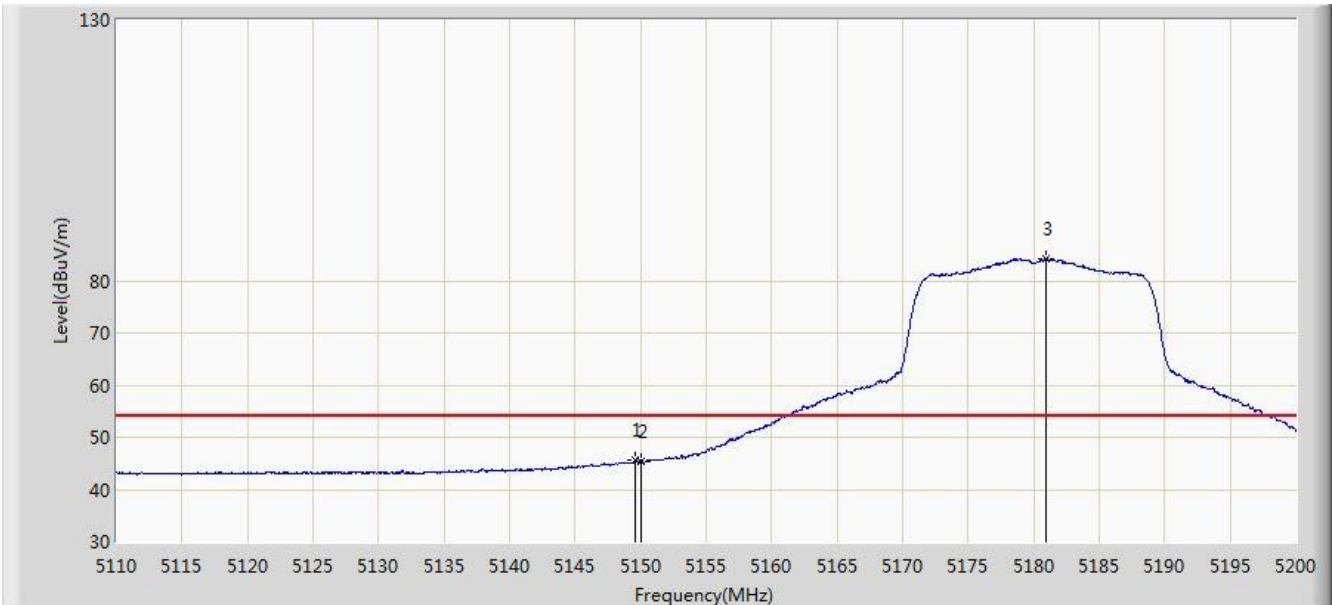

No	Flag	Mark	Frequency (MHz)	Measure Level (dBuV/m)	Reading Level (dBuV)	Over Limit (dB)	Limit (dBuV/m)	Factor (dB)	Type
1			5149.555	45.691	42.382	-8.309	54.000	3.309	AV
2			5150.000	45.381	42.072	-8.619	54.000	3.309	AV
3		*	5180.965	84.264	80.992	N/A	N/A	3.273	AV

Note: Measure Level (dBμV/m) = Reading Level (dBμV) + Factor (dB)

Factor (dB) = Cable Loss (dB) + Antenna Factor (dB) (dB/m) - Pre\_Amplifier Gain (dB)

Site: AC1	Time: 2017/12/02 - 13:05
Limit: FCC_Part15.407_RE(3m)	Engineer: Bruce Wang
Probe: BBHA9120D_1-18GHz	Polarity: Horizontal
EUT: Cassia Bluetooth Router	Power: AC 120V/60Hz
Note: Transmit by 802.11ac-VHT20 at Channel 5745MHz	

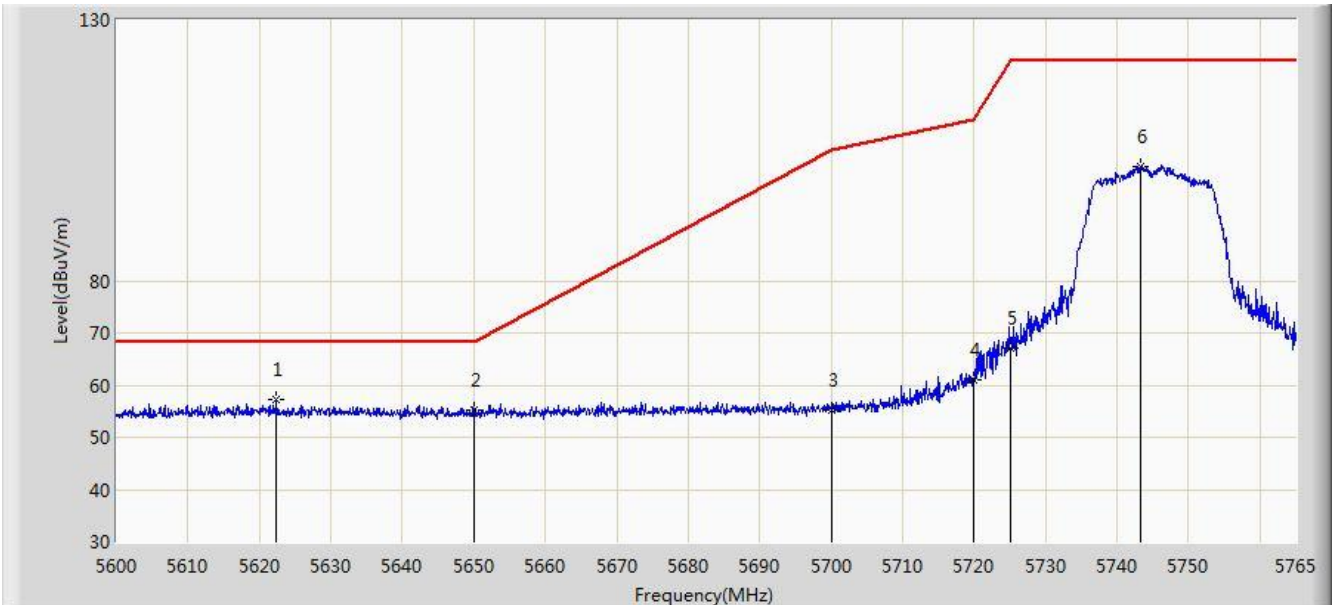

No	Flag	Mark	Frequency (MHz)	Measure Level (dBuV/m)	Reading Level (dBuV)	Over Limit (dB)	Limit (dBuV/m)	Factor (dB)	Type
1		*	5622.357	57.121	53.573	-11.079	68.200	3.548	PK
2			5650.000	55.350	51.723	-12.850	68.200	3.627	PK
3			5700.000	55.349	51.630	-49.851	105.200	3.719	PK
4			5720.000	60.948	57.172	-49.852	110.800	3.776	PK
5			5725.000	67.169	63.378	-55.031	122.200	3.791	PK
6			5743.303	101.924	98.078	N/A	N/A	3.846	PK

Note: Measure Level (dBμV/m) = Reading Level (dBμV) + Factor (dB)

Factor (dB) = Cable Loss (dB) + Antenna Factor (dB) (dB/m) - Pre\_Amplifier Gain (dB)

Site: AC1	Time: 2017/12/02 - 13:06
Limit: FCC_Part15.407_RE(3m)	Engineer: Bruce Wang
Probe: BBHA9120D_1-18GHz	Polarity: Vertical
EUT: Cassia Bluetooth Router	Power: AC 120V/60Hz
Note: Transmit by 802.11ac-VHT20 at Channel 5745MHz	

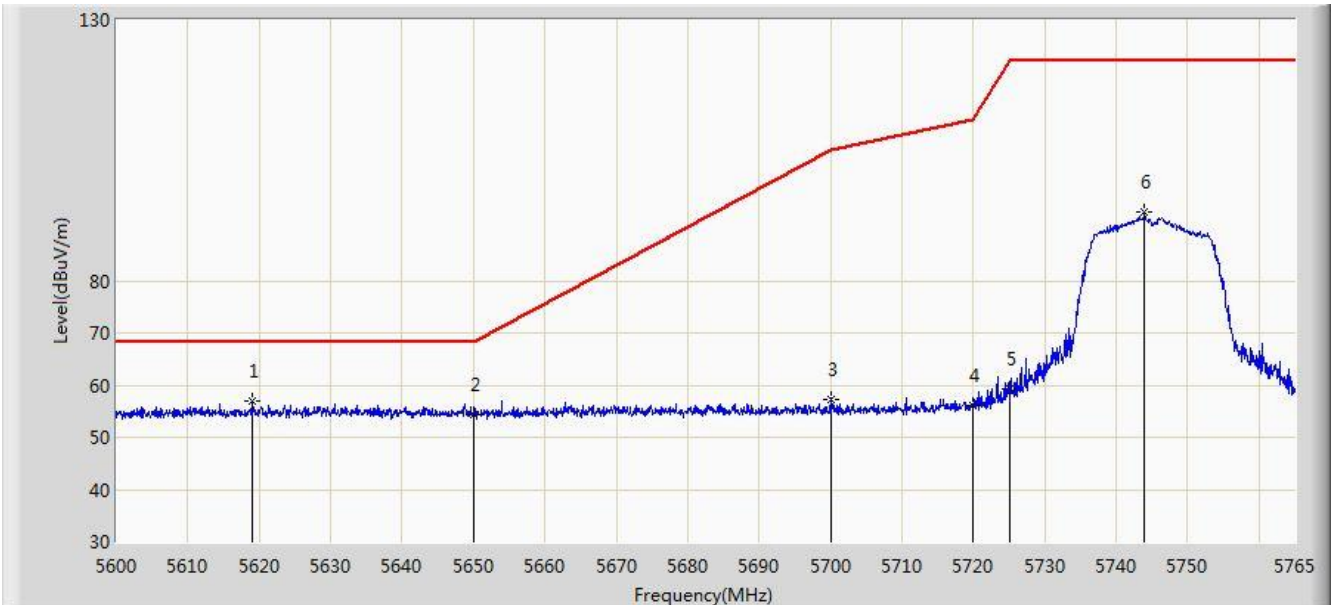

No	Flag	Mark	Frequency (MHz)	Measure Level (dBuV/m)	Reading Level (dBuV)	Over Limit (dB)	Limit (dBuV/m)	Factor (dB)	Type
1		*	5618.975	56.918	53.380	-11.282	68.200	3.538	PK
2			5650.000	54.325	50.698	-13.875	68.200	3.627	PK
3			5700.000	57.236	53.517	-47.964	105.200	3.719	PK
4			5720.000	56.138	52.362	-54.662	110.800	3.776	PK
5			5725.000	59.292	55.501	-62.908	122.200	3.791	PK
6			5743.962	93.254	89.405	N/A	N/A	3.849	PK

Note: Measure Level (dBμV/m) = Reading Level (dBμV) + Factor (dB)

Factor (dB) = Cable Loss (dB) + Antenna Factor (dB) (dB/m) - Pre\_Amplifier Gain (dB)

Site: AC1	Time: 2017/12/02 - 13:09
Limit: FCC_Part15.407_RE(3m)	Engineer: Bruce Wang
Probe: BBHA9120D_1-18GHz	Polarity: Horizontal
EUT: Cassia Bluetooth Router	Power: AC 120V/60Hz
Note: Transmit by 802.11ac-VHT20 at Channel 5825MHz	

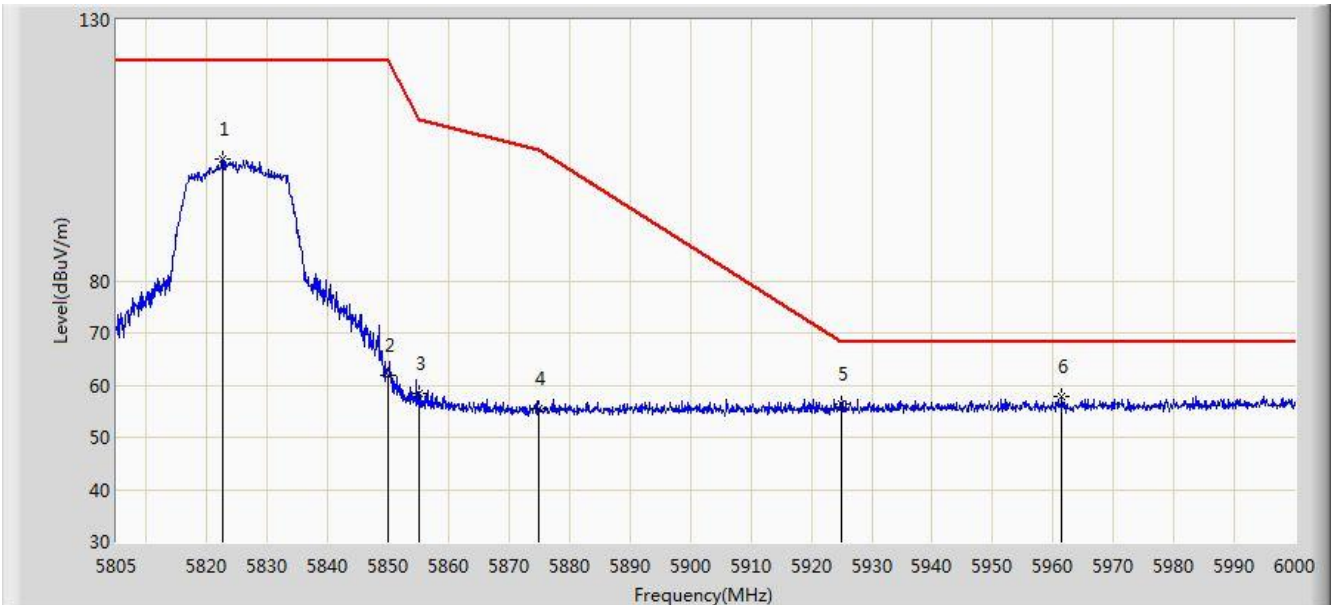

No	Flag	Mark	Frequency (MHz)	Measure Level (dBuV/m)	Reading Level (dBuV)	Over Limit (dB)	Limit (dBuV/m)	Factor (dB)	Type
1			5822.550	103.365	99.365	N/A	N/A	4.000	PK
2			5850.000	61.951	57.894	-60.249	122.200	4.058	PK
3			5855.000	58.502	54.442	-52.298	110.800	4.060	PK
4			5875.000	55.531	51.426	-49.669	105.200	4.105	PK
5			5925.000	56.357	52.104	-11.843	68.200	4.254	PK
6		*	5961.487	57.917	53.615	-10.283	68.200	4.302	PK

Note: Measure Level (dBμV/m) = Reading Level (dBμV) + Factor (dB)

Factor (dB) = Cable Loss (dB) + Antenna Factor (dB) (dB/m) - Pre\_Amplifier Gain (dB)



Site: AC1	Time: 2017/12/02 - 13:10
Limit: FCC_Part15.407_RE(3m)	Engineer: Bruce Wang
Probe: BBHA9120D_1-18GHz	Polarity: Vertical
EUT: Cassia Bluetooth Router	Power: AC 120V/60Hz
Note: Transmit by 802.11ac-VHT20 at Channel 5825MHz	

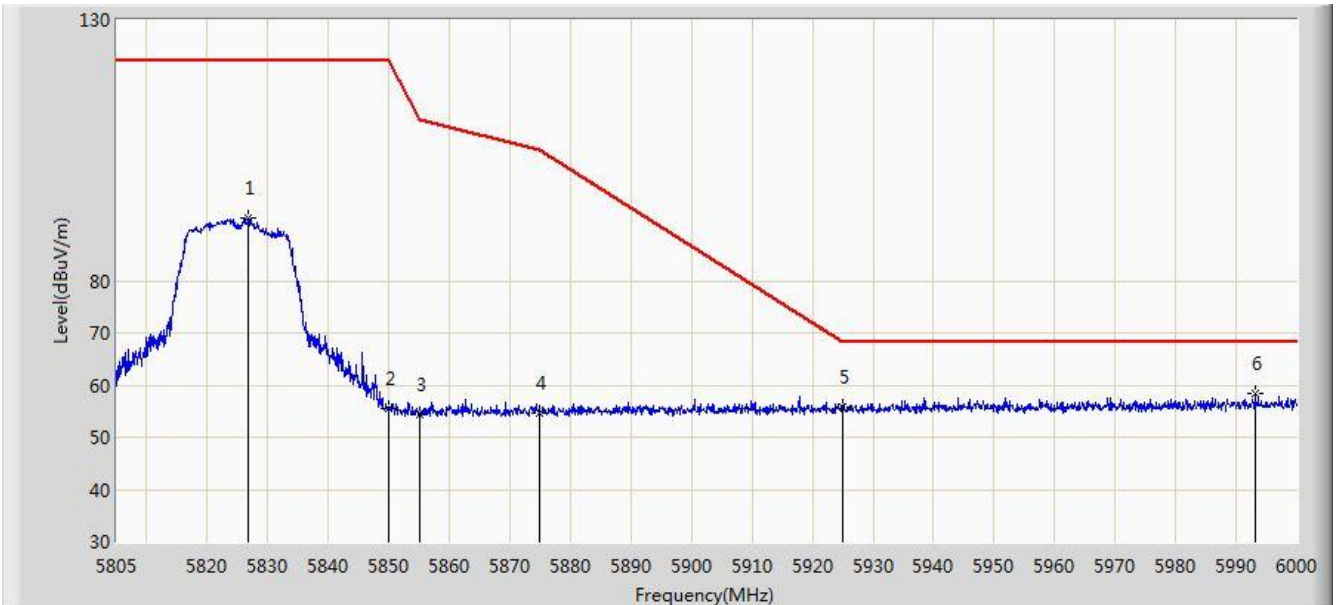

No	Flag	Mark	Frequency (MHz)	Measure Level (dBuV/m)	Reading Level (dBuV)	Over Limit (dB)	Limit (dBuV/m)	Factor (dB)	Type
1			5826.840	92.155	88.146	N/A	N/A	4.009	PK
2			5850.000	55.417	51.360	-66.783	122.200	4.058	PK
3			5855.000	54.418	50.358	-56.382	110.800	4.060	PK
4			5875.000	54.616	50.511	-50.584	105.200	4.105	PK
5			5925.000	55.938	51.685	-12.262	68.200	4.254	PK
6		*	5993.175	58.425	54.165	-9.775	68.200	4.260	PK

Note: Measure Level (dB $\mu$ V/m) = Reading Level (dB $\mu$ V) + Factor (dB)

Factor (dB) = Cable Loss (dB) + Antenna Factor (dB) (dB/m) - Pre\_Amplifier Gain (dB)

## 7.10. AC Conducted Emissions Measurement

### 7.10.1. Test Limit

FCC Part 15.207 Limits		
Frequency (MHz)	QP (dB $\mu$ V)	AV (dB $\mu$ V)
0.15 - 0.50	66 - 56	56 – 46
0.50 - 5.0	56	46
5.0 - 30	60	50

Note 1: The lower limit shall apply at the transition frequencies.

Note 2: The limit decreases linearly with the logarithm of the frequency in the range 0.15MHz to 0.5MHz.

### 7.10.2. Test Procedure

The EUT was setup according to ANSI C63.10, 2013 for compliance to RSS-Gen Issue 4 requirements. The EUT was placed on a platform of nominal size, 1 m by 1.5 m, raised 80 cm above the conducting ground plane. The vertical conducting plane was located 40 cm to the rear of the EUT. All other surfaces of EUT were at least 80 cm from any other grounded conducting surface. The EUT and simulators are connected to the main power through a line impedance stabilization network (LISN). The LISN provides a 50 ohm /50uH coupling impedance for the measuring equipment. The peripheral devices are also connected to the main power through a LISN. (Please refer to the block diagram of the test setup and photographs) Each current-carrying conductor of the EUT power cord, except the ground (safety) conductor, was individually connected through a LISN to the input power source.

The excess length of the power cord between the EUT and the LISN receptacle were folded back and forth at the center of the lead to form a bundle not exceeding 40 cm in length.

Conducted emissions were investigated over the frequency range from 0.15MHz to 30MHz using a receiver bandwidth of 9 kHz.

### 7.10.3. Test Setup

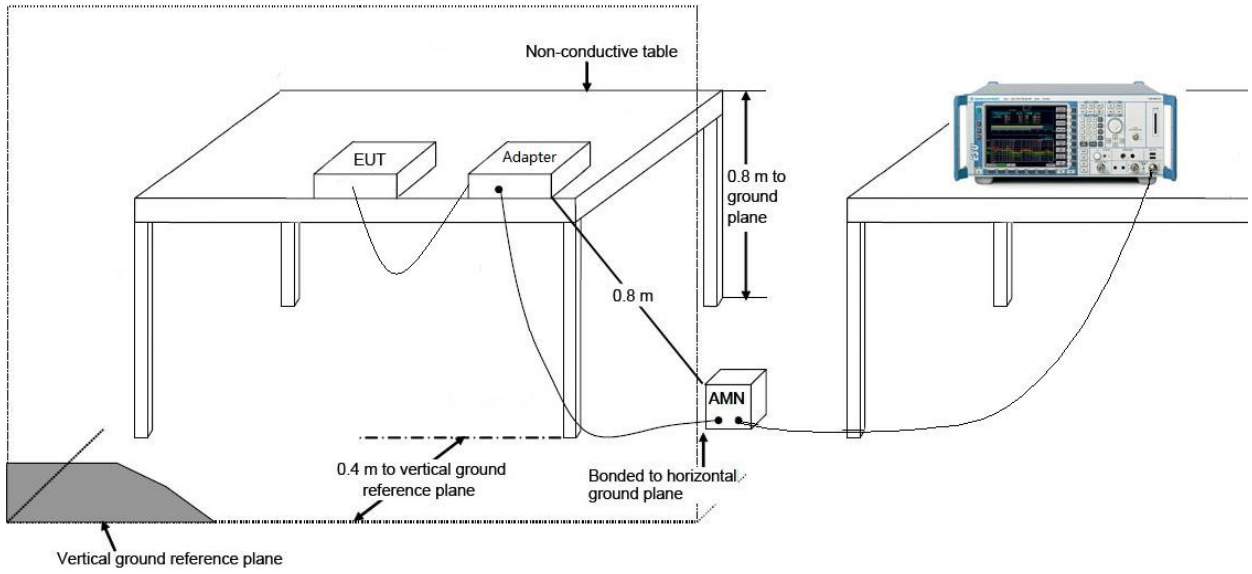

**7.10.4. Test Result**

Site: SR2	Time: 2017/12/13 - 15:48
Limit: FCC_Part 15.207_CE Main	Engineer: Hunk Li
Probe: ENV216_101683_Filter On	Polarity: Line
EUT: Cassia Bluetooth Router	Power: AC 120V/60Hz
Test Mode: Mode 1	

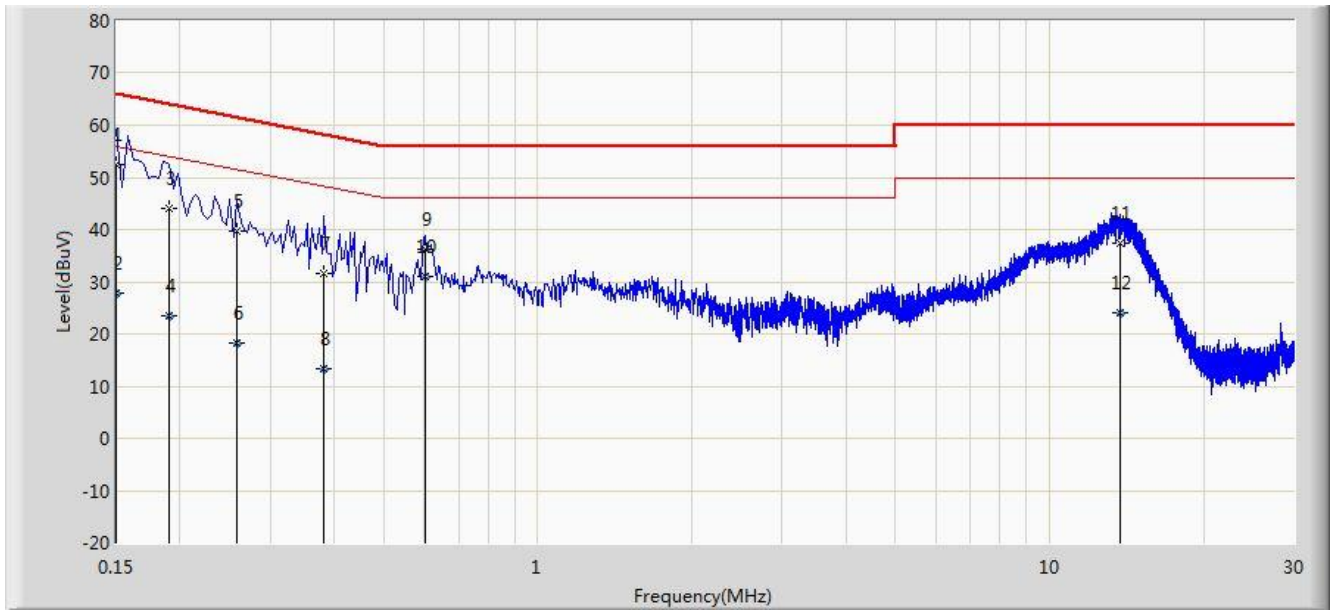

No	Flag	Mark	Frequency (MHz)	Measure Level (dBuV)	Reading Level (dBuV)	Margin (dB)	Limit (dBuV)	Factor (dB)	Type
1		*	0.150	52.517	41.348	-13.483	66.000	11.168	QP
2			0.150	27.758	16.589	-28.242	56.000	11.168	AV
3			0.190	44.067	34.038	-19.970	64.037	10.029	QP
4			0.190	23.502	13.473	-30.535	54.037	10.029	AV
5			0.258	39.681	29.710	-21.815	61.496	9.970	QP
6			0.258	18.318	8.348	-33.177	51.496	9.970	AV
7			0.382	31.593	21.523	-26.643	58.236	10.071	QP
8			0.382	13.418	3.347	-34.818	48.236	10.071	AV
9			0.602	36.295	26.181	-19.705	56.000	10.114	QP
10			0.602	30.969	20.855	-15.031	46.000	10.114	AV
11			13.722	37.510	27.455	-22.490	60.000	10.055	QP
12			13.722	24.087	14.032	-25.913	50.000	10.055	AV

Note: Measure Level (dBμV) = Reading Level (dBμV) + Factor (dB)

Factor (dB) = Cable Loss (dB) + LISN Factor (dB)

Site: SR2	Time: 2017/12/13 - 15:53
Limit: FCC_Part 15.207_CE Main	Engineer: Hunk Li
Probe: ENV216_101683_Filter On	Polarity: Neutral
EUT: Cassia Bluetooth Router	Power: AC 120V/60Hz
Test Mode: Mode 1	

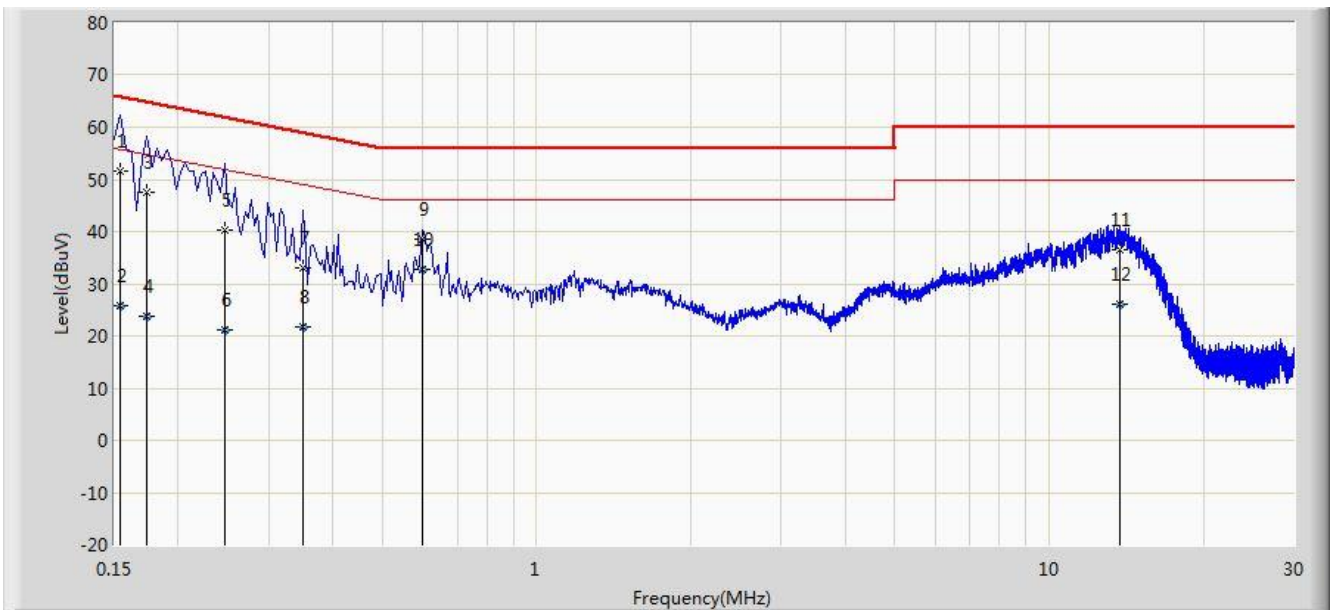

No	Flag	Mark	Frequency (MHz)	Measure Level (dBuV)	Reading Level (dBuV)	Margin (dB)	Limit (dBuV)	Factor (dB)	Type
1			0.154	51.645	40.929	-14.136	65.781	10.716	QP
2			0.154	25.855	15.139	-29.927	55.781	10.716	AV
3			0.174	47.591	37.534	-17.176	64.767	10.057	QP
4			0.174	23.773	13.716	-30.994	54.767	10.057	AV
5			0.246	40.188	30.190	-21.703	61.891	9.998	QP
6			0.246	21.252	11.254	-30.639	51.891	9.998	AV
7			0.350	33.124	23.049	-25.839	58.962	10.074	QP
8			0.350	21.793	11.718	-27.170	48.962	10.074	AV
9			0.598	38.583	28.451	-17.417	56.000	10.132	QP
10		*	0.598	32.756	22.623	-13.244	46.000	10.132	AV
11			13.730	36.638	26.543	-23.362	60.000	10.095	QP
12			13.730	26.093	15.997	-23.907	50.000	10.095	AV

Note: Measure Level (dBμV) = Reading Level (dBμV) + Factor (dB)

Factor (dB) = Cable Loss (dB) + LISN Factor (dB)

## 8. CONCLUSION

The data collected relate only the item(s) tested and show that the **Cassia Bluetooth Router** is in compliance with RSS-247 Section 6 of the IC Rules.

————— The End —————