

## RF Test Report

Applicant : Emplus Technologies, Inc  
Product Type : Dual Band AC1300 Access Point  
Trade Name : emplus, EnGenius  
Model Number : WAP551, ECW115  
Applicable Standard : FCC 47 CFR PART 15 SUBPART C  
ANSI C63.10:2013  
Receive Date : Aug. 22, 2019  
Test Period : Sep. 02 ~ Oct. 04, 2019  
Issue Date : Oct. 08, 2019

### Issue by

A Test Lab Techno Corp.  
No. 140-1, Changan Street, Bade District,  
Taoyuan City 33465, Taiwan (R.O.C.)  
Tel : +886-3-2710188 / Fax : +886-3-2710190



Taiwan Accreditation Foundation accreditation number: 1330  
Test Firm MRA designation number: TW0010

#### **Note:**

- 1.The test results are valid only for samples provided by customers and under the test conditions described in this report.
- 2.This report shall not be reproduced except in full, without the written approval of A Test Lab Technology Corporation.
- 3.The relevant information is provided by customers in this test report. According to the correctness, appropriateness or completeness of the information provided by the customer, if there is any doubt or error in the information which affects the validity of the test results, the laboratory does not take the responsibility.



### Revision History

Rev.	Issue Date	Revisions	Revised By
00	Oct. 08, 2019	Initial Issue	Nina Lin

## Verification of Compliance

Issued Date: Oct. 08, 2019

Applicant : Emplus Technologies, Inc

Product Type : Dual Band AC1300 Access Point

Trade Name : emplus, EnGenius

Model Number : WAP551, ECW115

FCC ID : 2AL6XWAP551

EUT Rated Voltage : DC 12 V, 1 A (DC Jack in)  
DC 54 V, 0.6 A (PoE In)  
DC 50 V, 0.275 mA (PoE Out)

Test Voltage : 120 Vac / 60 Hz

Applicable Standard : FCC 47 CFR PART 15 SUBPART C  
ANSI C63.10:2013

Test Result : Complied

Performing Lab. : A Test Lab Techno Corp.  
No. 140-1, Changan Street, Bade District,  
Taoyuan City 33465, Taiwan (R.O.C.)  
Tel : +886-3-2710188 / Fax : +886-3-2710190



Taiwan Accreditation Foundation accreditation number: 1330  
<http://www.atl-lab.com.tw/e-index.htm>

A Test Lab Techno Corp. tested the above equipment in accordance with the requirements set forth in the above standards. All indications of Pass/Fail in this report are opinions expressed by A Test Lab Techno Corp. based on interpretations and/or observations of test results. The test results show that the equipment tested is capable of demonstrating compliance with the requirements as documented in this report.

Approved By



(Manager)

(Jet Lu)



## TABLE OF CONTENTS

<b>1</b>	<b>General Information .....</b>	<b>5</b>
1.1.	Summary of Test Result .....	5
1.2.	Measurement Uncertainty .....	6
<b>2</b>	<b>EUT Description.....</b>	<b>7</b>
<b>3</b>	<b>Test Methodology.....</b>	<b>8</b>
3.1.	Mode of Operation.....	8
3.2.	EUT Test Step.....	13
3.3.	Configuration of Test System Details.....	14
3.4.	Test Instruments .....	15
3.5.	Test Site Environment.....	16
<b>4</b>	<b>Measurement Procedure.....</b>	<b>17</b>
4.1.	AC Power Line Conducted Emission Measurement.....	17
4.2.	Radiated Emission Measurement.....	19
4.3.	Maximum Conducted Output Power Measurement.....	23
4.4.	6 dB RF Bandwidth Measurement.....	24
4.5.	Maximum Power Spectral Density Measurement.....	25
4.6.	Out of Band Conducted Emissions Measurement.....	26
4.7.	Antenna Measurement .....	27
<b>5</b>	<b>Test Results .....</b>	<b>28</b>
Annex A.	Conducted Emission .....	28
Annex B.	Conducted Test Results .....	30
Annex C.	Radiated Emission Measurement.....	95



# 1 General Information

## 1.1. Summary of Test Result

Standard	Item	Result	Remark
15.207	AC Power Conducted Emission	PASS	----
15.247(d)	Transmitter Radiated Emissions	PASS	----
15.247(b)(3)	Max. Output Power	PASS	----
15.247(a)(2)	6 dB RF Bandwidth	PASS	----
15.247(e)	Maximum Power Spectral Density	PASS	----
15.247(d)	Out of Band Conducted Spurious Emission	PASS	----
15.203	Antenna Requirement	PASS	----

Standard	Description
CFR47, Part 15, Subpart C	Intentional Radiators
ANSI C63. 10: 2013	American National Standard of Procedures for Compliance Testing of Unlicensed Wireless Devices
KDB 558074 D01 15.247 Meas Guidance v05r02	GUIDANCE FOR COMPLIANCE MEASUREMENTS ON DIGITAL TRANSMISSION SYSTEM, FREQUENCY HOPPING SPREAD SPECTRUM SYSTEM, AND HYBRID SYSTEM DEVICES OPERATING UNDER SECTION 15.247 OF THE FCC RULES
KDB 662911 D01 v02r01	Emissions Testing of Transmitters with Multiple Outputs in the Same Band (e.g., MIMO, Smart Antenna, etc)



## 1.2. Measurement Uncertainty

Test Item	Frequency Range	Uncertainty (dB)
Conducted Emission	150 kHz ~ 30 MHz	2.8
Radiated Emission	9 kHz ~ 30 MHz	1.7
	30 MHz ~ 1000 MHz	5.7
	1000 MHz ~ 18000 MHz	5.6
	18000 MHz ~ 26500 MHz	4.9
	26500 MHz ~ 40000 MHz	4.8
Conducted Output Power	+0.27 dB / -0.28 dB	
RF Bandwidth	4.96 %	
Power Spectral Density	+0.71 dB / -0.77 dB	

Decision Rule

- Uncertainty is not included.
- Uncertainty is included.



## 2 EUT Description

Applicant	Emplus Technologies, Inc Bld B, 10F, No.209 Nangang Rd., Taipei City, Taiwan			
Manufacturer	Emplus Technologies, Inc 10F., Building B, No.209, Sec. 1, Nangang Rd., Nangang Dist., Taipei City 115, Taiwan (R.O.C.)			
Product Type	Dual Band AC1300 Access Point			
Trade Name	emplus, EnGenius			
Model Number	WAP551, ECW115			
Difference description of trade name/model number	Differences are due to selling region. * WAP551 for emplus apply, ECW115 for EnGenius apply.			
FCC ID	2AL6XWAP551			
Operate Freq. Band	Frequency Range (MHz)	Modulation	Channel Bandwidth	Data Rate 400 / 800 GI (ns)
IEEE 802.11b	2412 ~ 2462	DSSS	20 MHz	Up to 11 Mbps
IEEE 802.11g	2412 ~ 2462	OFDM	20 MHz	Up to 54 Mbps
IEEE 802.11n 2.4 GHz 20 MHz	2412 ~ 2462	OFDM (256QAM)	20 MHz	Up to 173.4 Mbps
IEEE 802.11n 2.4 GHz 40 MHz	2422 ~ 2452	OFDM (256QAM)	40 MHz	Up to 400 Mbps
Antenna information	ANT	Model Number	Type	Max. Gain (dBi)
	ANT-0	5718A0434300	Metal PCB Antenna	3.24
	ANT-1	5718A0435300	Metal PCB Antenna	3.58
Antenna Delivery	See section 3.1			
Operate Temp. Range	0 ~ +40 °C			

Frequency Band	Max. RF Output Power (W)
IEEE 802.11b	0.087
IEEE 802.11g	0.137
IEEE 802.11n 2.4 GHz 20 MHz	0.138
IEEE 802.11n 2.4 GHz 40 MHz	0.066

Beamforming on

Frequency Band	Max. RF Output Power (W)
IEEE 802.11n 2.4 GHz 20 MHz	0.064
IEEE 802.11n 2.4 GHz 40 MHz	0.028

### 3 Test Methodology

#### 3.1. Mode of Operation

Decision of Test ATL has verified the construction and function in typical operation. All the test modes were carried out with the EUT in normal operation, which was shown in this test report and defined as:

Test Mode
Mode 1: Transmit mode
Mode 2: IEEE 802.11b Continuous TX mode
Mode 3: IEEE 802.11g Continuous TX mode
Mode 4: IEEE 802.11n 2.4 GHz 20 MHz Continuous TX mode
Mode 5: IEEE 802.11n 2.4 GHz 40 MHz Continuous TX mode

Software used to control the EUT for staying in continuous transmitting mode was programmed.

After verification, all tests were carried out with the worst case test modes.

By preliminary testing and verifying three axis (X, Y and Z) position of EUT transmitted status, it was found that "X axis" position was the worst, then the final test was executed the worst condition and test data were recorded in this report.

Test Mode	ANT-0	ANT-1	ANT-0+1
Mode 2	V	V	V
Mode 3	V	V	V
Mode 4	V	V	V
Mode 5	V	V	V

Test Mode	Antenna Delivery	Data Rate (Mbps)	Test Channel
Mode 2	2TX (CDD)	1	1, 6, 11
Mode 3	2TX (CDD)	6	1, 6, 11
Mode 4	2TX (MIMO/Beamforming on)	13	1, 6, 11
Mode 5	2TX (MIMO/Beamforming on)	27	3, 6, 9





**Duty cycle**

Test Mode	Frequency (MHz)	on time (ms)	on+off time (ms)	Duty cycle	Duty Factor (dB)	1/T Minimum VBW (kHz)
Mode 2	2412.0	10.000	10.000	1.000	0.000	0.010
Mode 3	2412.0	2.068	2.143	0.965	0.155	0.484
Mode 4	2412.0	5.040	5.085	0.991	0.039	0.010
Mode 5	2422.0	2.460	2.520	0.976	0.105	0.407

**Beamforming on**

Test Mode	Frequency (MHz)	on time (ms)	on+off time (ms)	Duty cycle	Duty Factor (dB)	1/T Minimum VBW (kHz)
Mode 4	2412.0	5.040	5.085	0.991	0.039	0.010
Mode 5	2422.0	2.460	2.520	0.976	0.105	0.407

Duty Cycle Graphs

Mode 2: IEEE 802.11b Continuous TX mode

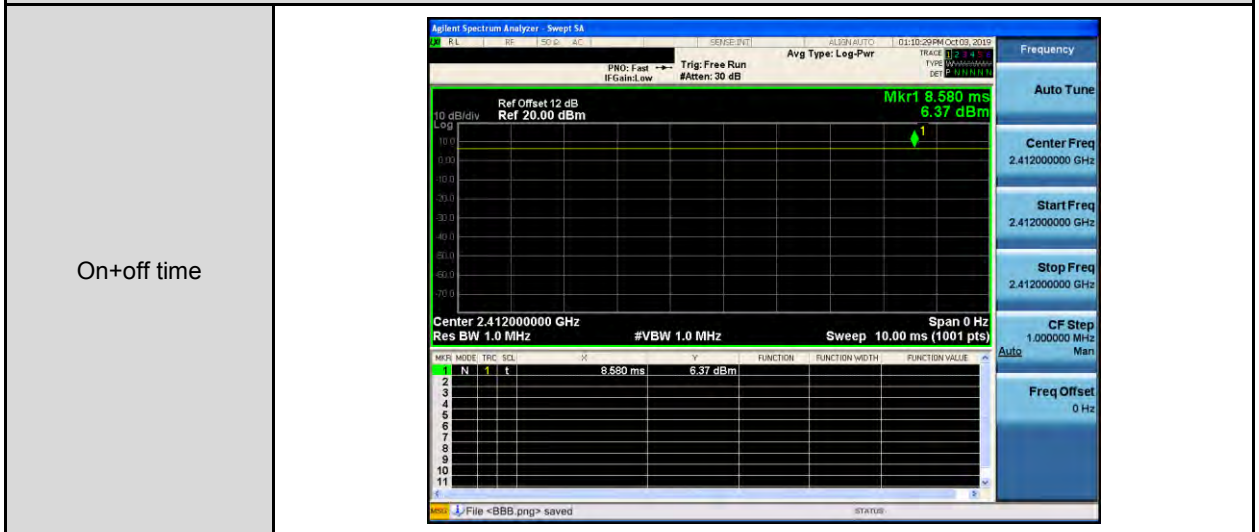

Mode 3: IEEE 802.11g Continuous TX mode

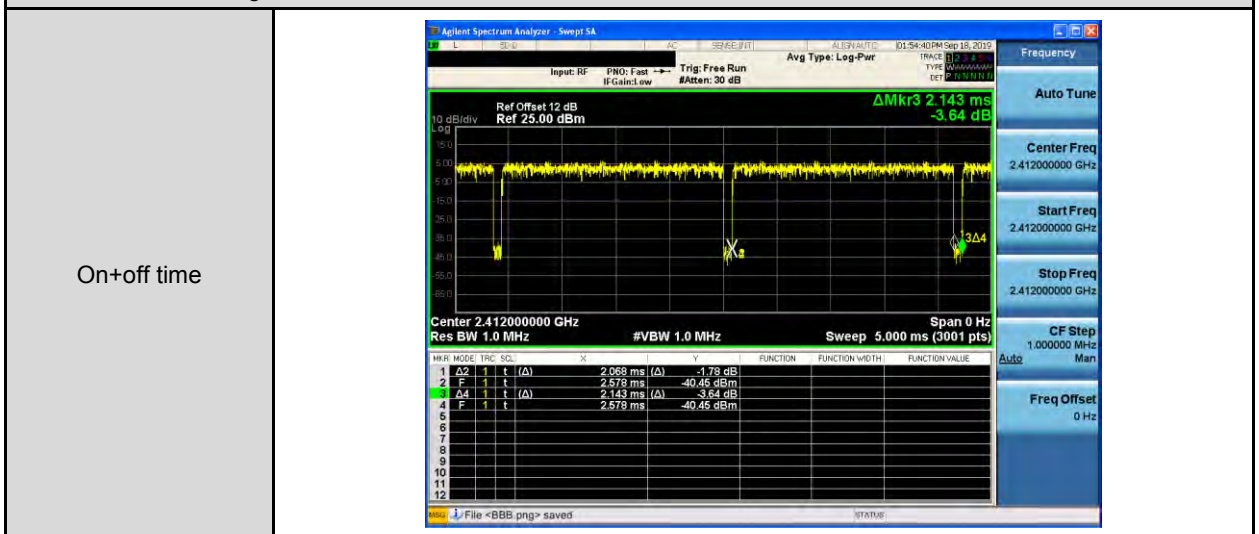

Mode 4: IEEE 802.11n 2.4 GHz 20 MHz Continuous TX mode

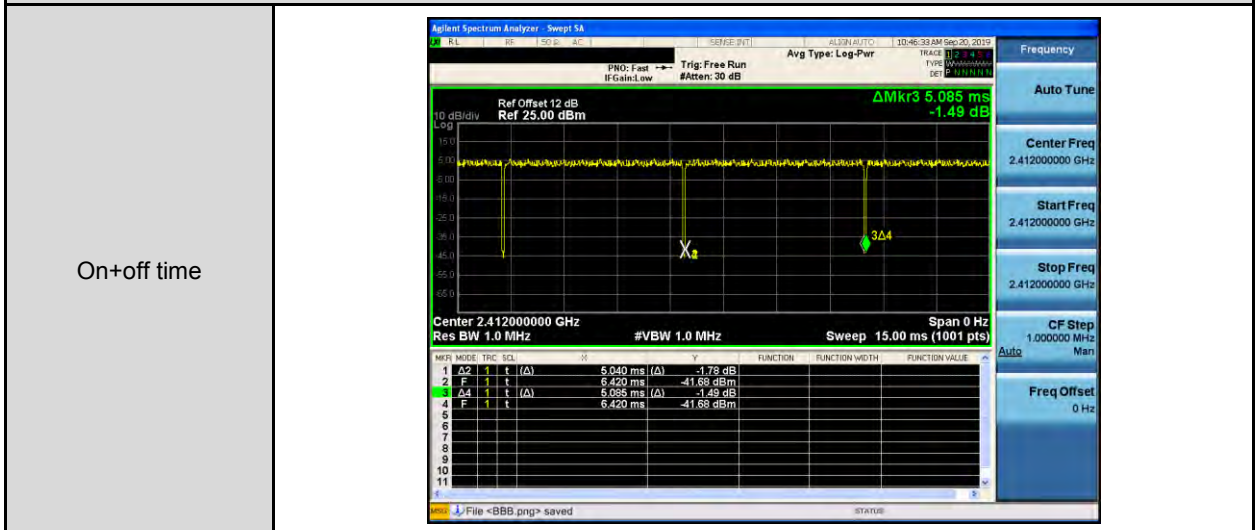

Mode 5: IEEE 802.11n 2.4 GHz 40 MHz Continuous TX mode

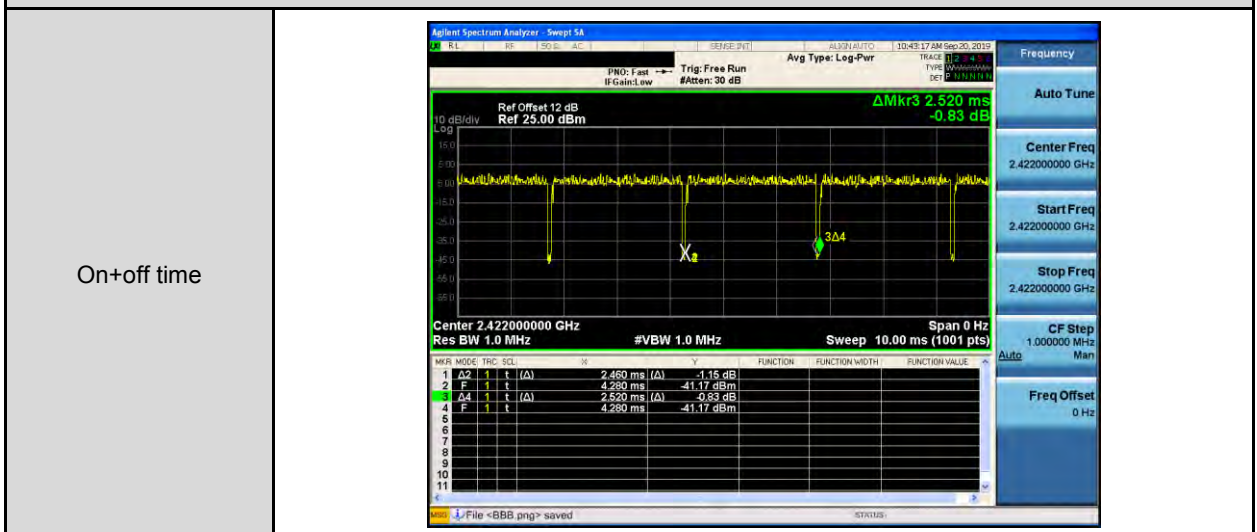

Beamforming on

Mode 4: IEEE 802.11n 2.4 GHz 20 MHz Continuous TX mode

On+off time

MKR	MODE	TRIG	SCL	X	Y	FUNCTION	FUNCTION WIDTH	FUNCTION VALUE
1	A2	1	t	(A)	5.040 ms	(A)		3.33 dB
2	F	1	t	(A)	6.630 ms			-44.47 dBm
3	A4	1	t	(A)	5.085 ms	(A)		0.75 dB
4	F	1	t	(A)	6.630 ms			-44.47 dBm

Mode 5: IEEE 802.11n 2.4 GHz 40 MHz Continuous TX mode

On+off time

MKR	MODE	TRIG	SCL	X	Y	FUNCTION	FUNCTION WIDTH	FUNCTION VALUE
1	A2	1	t	(A)	2.460 ms	(A)		2.21 dB
2	F	1	t	(A)	3.840 ms			-45.13 dBm
3	A4	1	t	(A)	2.520 ms	(A)		3.26 dB
4	F	1	t	(A)	3.840 ms			-45.13 dBm



### 3.2. EUT Test Step

1.	Setup the EUT shown on "Configuration of Test System Details".
2.	Turn on the power of all equipment.
3.	Turn on TX function
4.	EUT run test program.

Measurement Software			
No.	Description	Software	Version
1	Conducted Emission	EZ EMC	1.1.4.3
2	Radiated Emission	EZ EMC	1.1.4.4

### 3.3. Configuration of Test System Details

Conducted Emissions

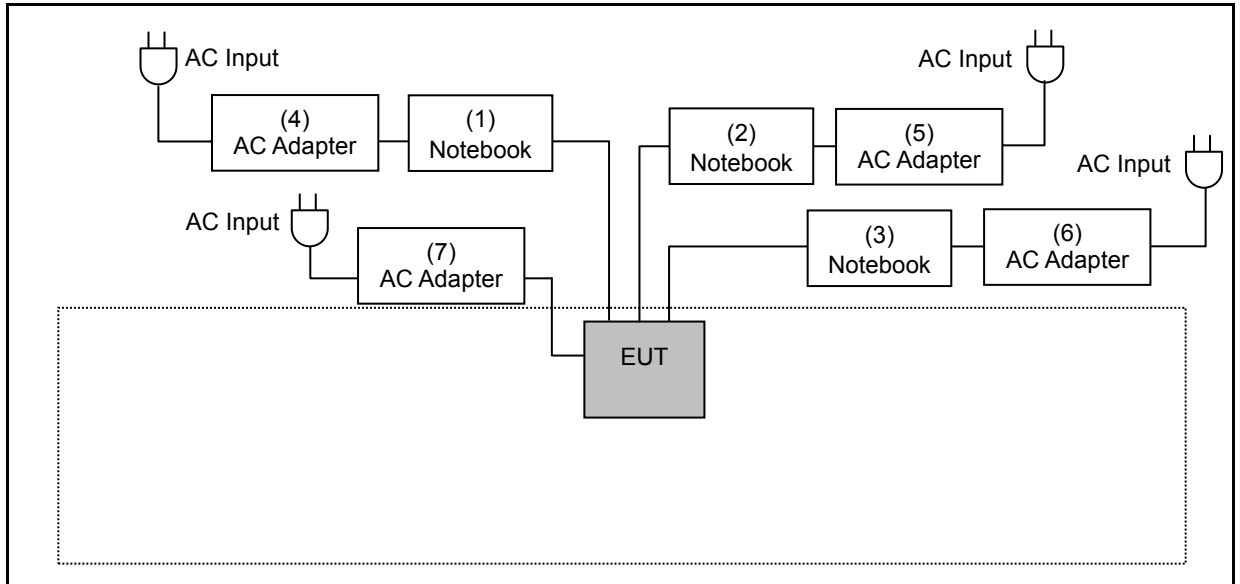

Radiated Emission

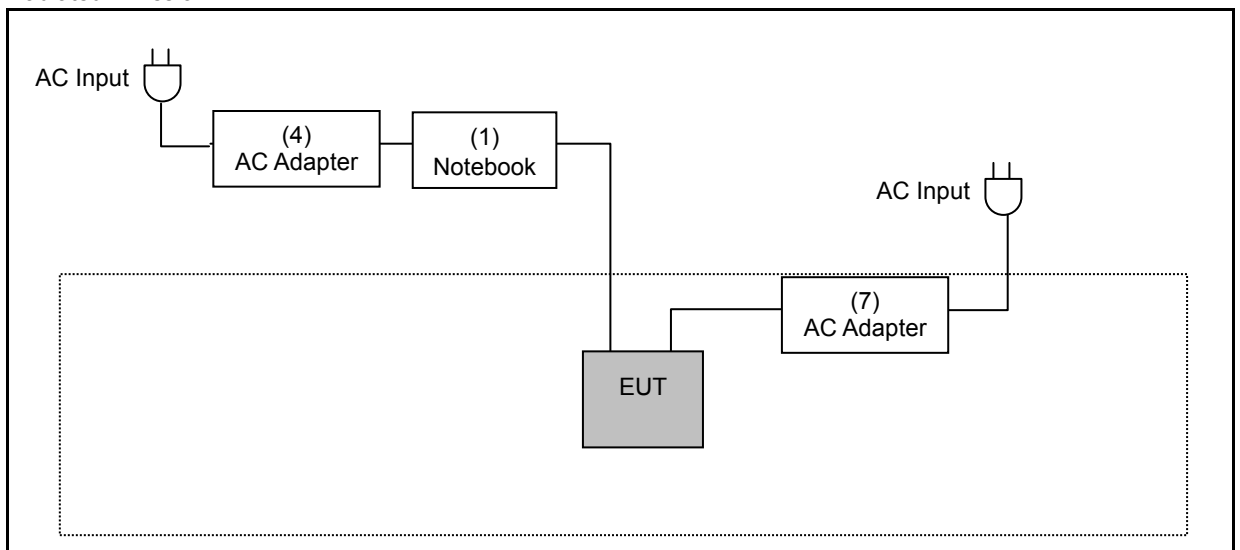



Devices Description					
	Product	Manufacturer	Model Number	Serial Number	Remark
(1)	Notebook	DELL	LATITUDE E5440	BRTQXY1	---
(2)	Notebook	DELL	LATITUDE E6440	5HZBD72	---
(3)	Notebook	DELL	LATITUDE E6440	48GBD72	---
(4)	AC Adapter	DELL	HA65NM130	---	Non-Shielded, 0.8 m
(5)	AC Adapter	DELL	HA65NM130	---	Non-Shielded, 0.8 m
(6)	AC Adapter	DELL	HA65NM130	---	Non-Shielded, 0.8 m
(7)	AC Adapter	Powertron Electronics Corp.	PS1012-120HUB100	---	I/P: 100-240 VAC, 50-60 Hz, 0.4 A O/P: 12 VDC, 1.25 A
(8)	PoE Adapter	emplus	EPA5006GP	---	I/P: 100-240 VAC, 50-60 Hz, 0.8 A O/P: 54 VDC, 0.6 A

Note : The device used two models of adapter, adapter number: PS1012-120HUB100 is worst case to perform testing.

### 3.4. Test Instruments

For Conducted Emission

Test Period: Oct. 04, 2019

Testing Engineer: Louis Shen

Equipment	Manufacturer	Model Number	Serial Number	Cal. Date	Cal. Period
Test Receiver	R&S	ESCI	100367	05/23/2019	1 year
LISN	R&S	ENV216	101040	04/03/2019	1 year
LISN	R&S	ENV216	101041	03/28/2019	1 year
RF Cable	Woken	00100D1380194M	TE-02-03	05/23/2019	1 year



For Radiated Emissions

Test Period: Sep. 02 ~ Sep. 28, 2019

Testing Engineer: Ricky Liu

Equipment	Manufacturer	Model Number	Serial Number	Cal. Date	Cal. Period
Spectrum Analyzer (10 Hz~44 GHz)	Keysight	N9010A	MY52221312	01/14/2019	1 year
Pre Amplifier (1~26.5 GHz)	Agilent	8449B	3008A02237	10/16/2018	1 year
Pre Amplifier (100 kHz~1.3 GHz)	Agilent	8447D	2944A11119	01/14/2019	1 year
Broadband Antenna	Schwarzbeck	VULB9168	416	10/19/2018	1 year
Horn Antenna (1~18 GHz)	SCHWARZBECK MESS-ELEKTRONIK	BBHA9120D	9120D-550	08/22/2019	1 year
Broadband Horn Antenna (18~40 GHz)	SCHWARZBECK MESS-ELEKTRONIK	BBHA9170	9170-320	08/14/2019	1 year
Loop Antenna	COM-POWER CORPORATION	AL-130	121014	03/29/2019	1 year
RF Cable	EMCI	EMC104-N-N-6000	TE01-1	02/20/2019	1 year
Microwave Cable	EMCI	EMC104-SM-SM-1 3000	170814	10/30/2018	1 year
Microwave Cable	EMCI	EMC102-KM-KM-1 4000	151001	02/20/2019	1 year

For Conducted

Test Period: Sep. 20 ~ Oct. 03, 2019

Testing Engineer: Negi Chiu

Equipment	Manufacturer	Model Number	Serial Number	Cal. Date	Cal. Period
Spectrum Analyzer (20 Hz~26.5 GHz)	Agilent	N9020A	US47520902	09/18/2019	1 year
Power Sensor	Anritsu	MA2411B	1126022	09/03/2019	1 year
Power Meter	Anritsu	ML2495A	1135009	09/03/2019	1 year

Note: N.C.R. = No Calibration Request.

### 3.5. Test Site Environment

Items	Required (IEC 60068-1)	Actual
Temperature (°C)	15-35	26
Humidity (%RH)	25-75	60
Barometric pressure (mbar)	860-1060	990



## 4 Measurement Procedure

### 4.1. AC Power Line Conducted Emission Measurement

#### ■ Limit

Frequency (MHz)	Quasi-peak	Average
0.15 - 0.5	66 to 56	56 to 46
0.50 - 5.0	56	46
5.0 - 30.0	60	50

#### ■ Test Setup

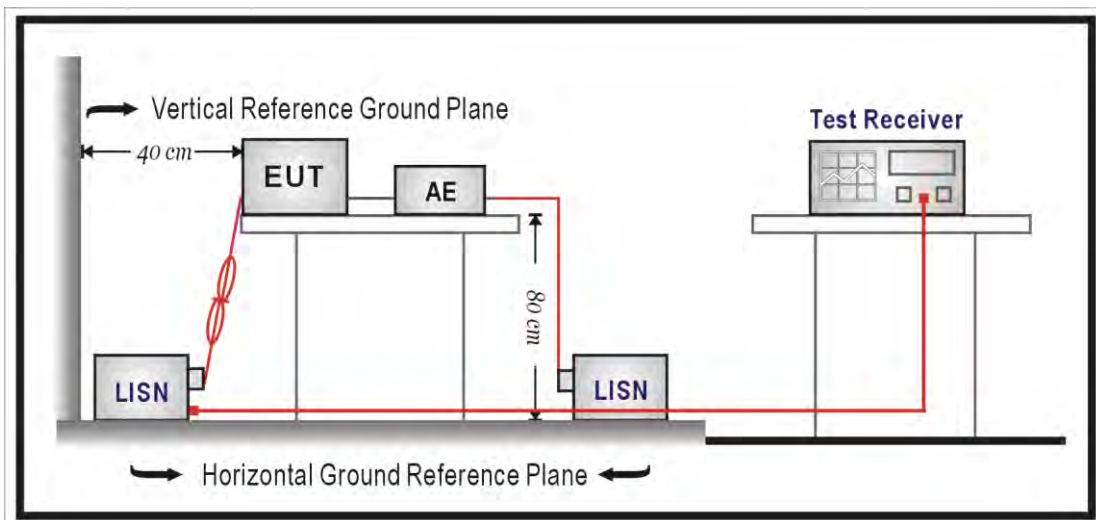

### ■ Test Procedure

The EUT and simulators are connected to the main power through a line impedance stabilization network (L.I.S.N.). This provides a  $50 \Omega // 50 \mu\text{H}$  coupling impedance for the measuring equipment. The peripheral devices are also connected to the main power through a LISN that provides a  $50 \Omega // 50 \mu\text{H}$  coupling impedance with 50 ohm termination.

Tabletop device shall be placed on a non-conducting platform, of nominal size 1 m by 1.5 m, raised 80 cm above the reference ground plane. The wall of screened room shall be located 40 cm to the rear of the EUT. Other surfaces of tabletop or floor standing EUT shall be at least 80 cm from any other ground conducting surface including one or more LISNs. For floor-standing device shall be placed under the EUT with a 12 mm insulating material.

Conducted emissions were investigated over the frequency range from 0.15 MHz to 30 MHz using a resolution bandwidth of 9 kHz. The equipment under test (EUT) shall be meet the limits in section 4.1, as applicable, including the average limit and the quasi-peak limit when using respectively, an average detector and quasi-peak detector measured in accordance with the methods described of related standard. When all of peak value were complied with quasi-peak and average limit from 150 kHz to 30 MHz then quasi-peak and average measurement was unnecessary.

The AMN shall be placed 0.8 m from the boundary of the unit under test and bonded to a ground reference plane for AMNs mounted on top of the ground reference plane. This distance is between the closest points of the AMN and the EUT. All other units of the EUT and associated equipment shall be at least 0.8 m from the AMN. If the mains power cable is longer than 1 m then the cable shall be folded back and forth at the centre of the lead to form a bundle no longer than 0.4 m. All of interconnecting cables that hang closer than 40 cm to the ground plane shall be folded back and forth in the center forming a bundle 30 cm to 40 cm long. All of EUT and AE shall be separate place more than 0.1 m. All  $50 \Omega$  ports of the LISN shall be resistively terminated into  $50 \Omega$  loads when not connected to the measuring instrument.

If the reading of the measuring receiver shows fluctuations close to the limit, the reading shall be observed for at least 15 s at each measurement frequency; the higher reading shall be recorded with the exception of any brief isolated high reading which shall be ignored.

## 4.2. Radiated Emission Measurement

### ■ Limit

According to §15.209(a), except as provided elsewhere in this subpart, the emissions from an intentional radiator shall not exceed the field strength levels specified in the following table:

Frequency (MHz)	Field Strength ( $\mu\text{V}/\text{m}$ at meter)	Measurement Distance (meters)
0.009 – 0.490	$2400 / F$ (kHz)	300
0.490 – 1.705	$24000 / F$ (kHz)	30
1.705 – 30.0	30	30
30 - 88	100**	3
88-216	150**	3
216-960	200**	3
Above 960	500	3

\*\* Except as provided in paragraph (g), fundamental emissions from intentional radiators operating under this Section shall not be located in the frequency bands 54-72 MHz, 76-88 MHz, 174-216 MHz or 470-806 MHz. However, operation within these frequency bands is permitted under other sections of this Part, e.g., Sections 15.231 and 15.241.

### ■ Setup

9 kHz ~ 30 MHz

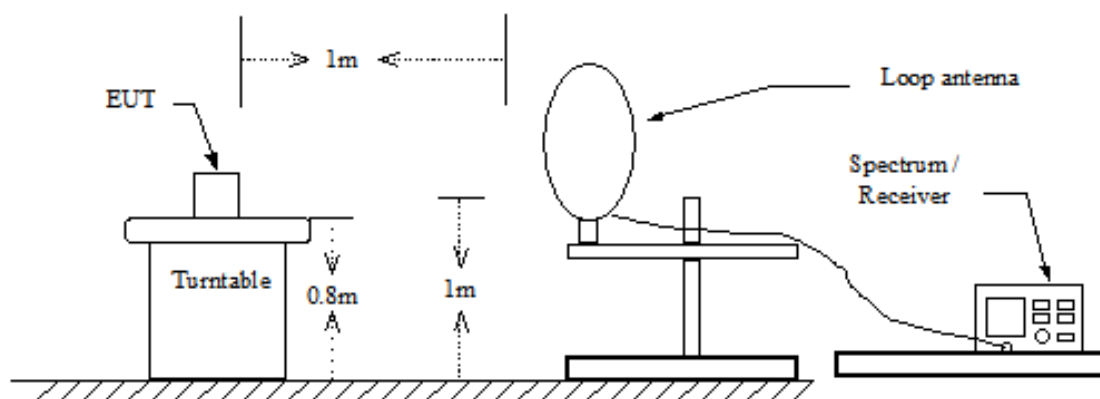

Below 1 GHz

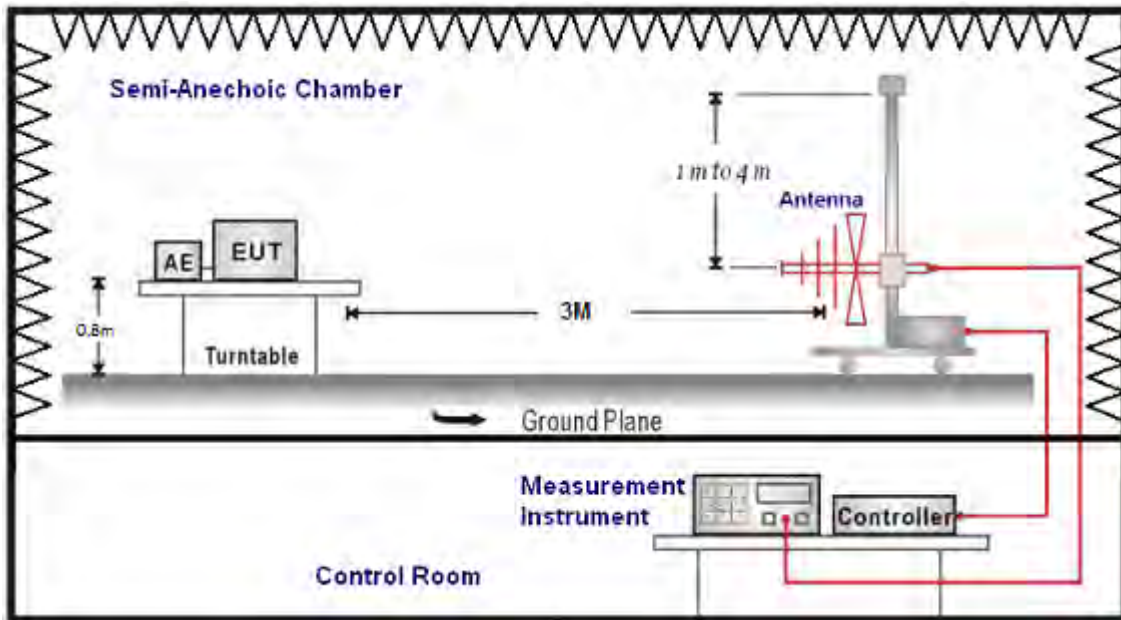

Above 1 GHz

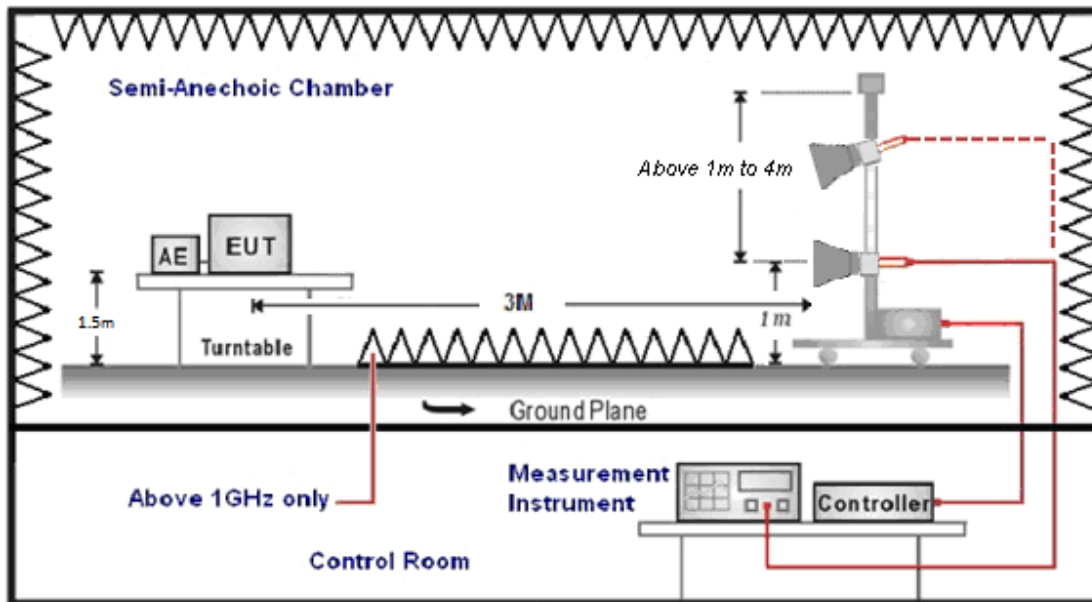

### ■ Test Procedure

Final radiation measurements were made on a three-meter, Semi Anechoic Chamber. The EUT system was placed on a nonconductive turntable which is 0.8 or 1.5 meters height, top surface 1.0 x 1.5 meter. The spectrum was examined from 250 MHz to 2.5 GHz in order to cover the whole spectrum below 10th harmonic which could generate from the EUT. During the test, EUT was set to transmit continuously & Measurements spectrum range from 9 kHz to 26.5 GHz is investigated.

For measurements below 1 GHz the resolution bandwidth is set to 100 kHz for peak detection measurements or 120 kHz for quasi-peak detection measurements. Peak detection is used unless otherwise noted as quasi-peak.

For measurements above 1 GHz the resolution bandwidth is set to 1 MHz, and then the video bandwidth is set to 3 MHz for peak measurements and 10 Hz for average measurements when Duty cycle  $>0.98$  /  $1/T$  for average measurements when Duty cycle  $<0.98$ . A nonconductive material surrounded the EUT to supporting the EUT for standing on three orthogonal planes. At each condition, the EUT was rotated 360 degrees, and the antenna was raised and lowered from one to four meters to find the maximum emission levels. Measurements were taken using both horizontal and vertical antenna polarization.

SCHWARZBECK MESS-ELEKTRONIK Biconilog Antenna at 3 Meter and the SCHWARZBECK Double Ridged Guide Antenna was used in frequencies 1 –26.5 GHz at a distance of 3 meter. The antenna at an angle toward the source of the emission. All test results were extrapolated to equivalent signal at 3 meters utilizing an inverse linear distance extrapolation Factor (20 dB/decade).

For testing above 1 GHz, the emission level of the EUT in peak mode was 20 dB lower than average limit (that means the emission level in peak mode also complies with the limit in average mode), then testing will be stopped and peak values of EUT will be reported, otherwise, the emissions will be measured in average mode again and reported.

Appropriate preamplifiers were used for improving sensitivity and precautions were taken to avoid overloading or desensitizing the spectrum analyzer. No post – detector video filters were used in the test.

The spectrum analyzer's 6 dB bandwidth was set to 1 MHz, and the analyzer was operated in the peak detection mode, for frequencies both below and up 1 GHz. The average levels were obtained by subtracting the duty cycle correction factor from the peak readings.

The following procedures were used to convert the emission levels measured in decibels referenced to 1 microvolt (dBuV) into field intensity in micro volts pre meter (uV/m).

The actual field intensity in decibels referenced to 1 microvolt in to field intensity in micro volts per meter (dBuV/m).



The actual field intensity in referenced to 1 microvolt per meter (dBuV/m) is determined by algebraically adding the measured reading in dBuV, the antenna factor (dB), and cable loss (dB) and Subtracting the gain of preamplifier (dB) is auto calculate in spectrum analyzer.

(1)  $\text{Amplitude (dBuV/m)} = \text{FI (dBuV)} + \text{AF (dBuV)} + \text{CL (dBuV)} - \text{Gain (dB)}$

FI= Reading of the field intensity.

AF= Antenna factor.

CL= Cable loss.

P.S Amplitude is auto calculate in spectrum analyzer.

(2)  $\text{Actual Amplitude (dBuV/m)} = \text{Amplitude (dBuV)} - \text{Dis(dB)}$

The FCC specified emission limits were calculated according the EUT operating frequency and by following linear interpolation equations:

(a) For fundamental frequency : Transmitter Output < +30 dBm

(b) For spurious frequency : Spurious emission limits = fundamental emission limit /10

Data of measurement within this frequency range without mark in the table above means the reading of emissions are attenuated more than 20 dB below the permissible limits or the field strength is too small to be measured.

### 4.3. Maximum Conducted Output Power Measurement

#### ■ Limit

For systems using digital modulation in the 2400-2483.5 MHz, the limit for maximum output power is 30 dBm.

And According to 15.247 (b), if transmitting antennas of directional gain greater than 6 dBi are used, the power shall be reduced by the amount in dB that the directional gain of the antenna exceeds 6 dBi.

IEEE 802.11b / IEEE 802.11g

#### CDD mode:

Directional Gain =  $G_{ANT} = 10 \cdot \log\left\{\frac{10^{G1/10} + 10^{G2/10} + \dots + 10^{Gn/10}}{NANT}\right\} = 3.41 \text{ dBi} < 6 \text{ dBi}$

IEEE 802.11n 2.4 GHz 20 MHz / IEEE 802.11n 2.4 GHz 40 MHz

#### MIMO/BF mode:

Directional Gain =  $10 \cdot \log\left\{\frac{10^{G1/20} + 10^{G2/20} + \dots + 10^{Gn/20}}{NANT}\right\}^2 = 6.42 \text{ dBi} > 6 \text{ dBi}$

\* power limit shall be reduced =  $30 - 0.42 = 29.58 \text{ dBm}$

#### ■ Test Setup

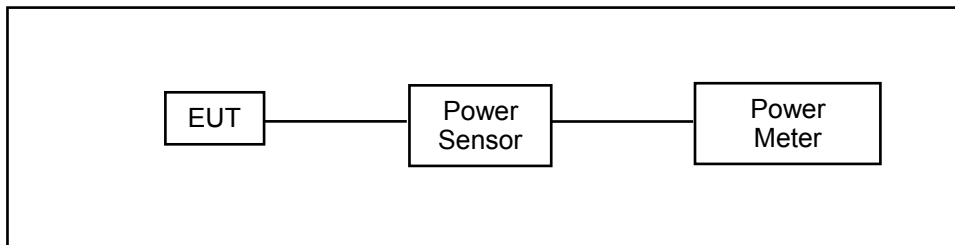

#### ■ Test Procedure

The testing follows the Measurement Procedure of ANSI C63.10:2013 section 11.9.2.3.2 Method AVGPM.

The tests below are run with the EUT's transmitter set at high power in TX mode. The EUT is needed to force selection of output power level and channel number. While testing, EUT was set to transmit continuously. Remove the Subjective device's antenna and connect the RF output port to power sensor.

#### 4.4. 6 dB RF Bandwidth Measurement

■ **Limit**

6 dB RF Bandwidth: Systems using digital modulation techniques may operate in the 2400–2483.5 MHz bands. The minimum 6 dB band-width shall be at least 500 kHz.

■ **Test Setup**

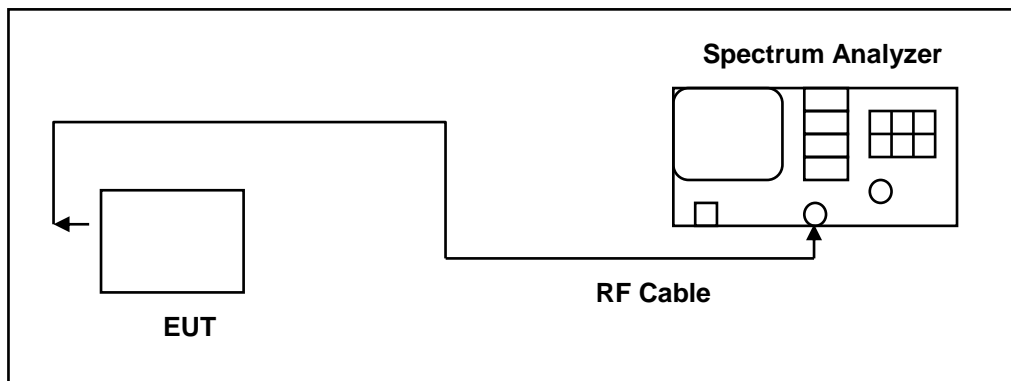

■ **Test Procedure**

The EUT tested to DTS test procedure of ANSI C63.10:2013 section 11.8.2 option2 for compliance to FCC 47CFR 15.247 requirements.

6 dB RF Bandwidth: The antenna port of the EUT was connected to the input of a spectrum analyzer. Analyzer RBW was set to 100 kHz. For each RF output channel investigated, the spectrum analyzer center frequency was set to the channel carrier. A peak output reading was taken, a DISPLAY line was drawn 6 dB lower than peak level. The 6 dB bandwidth was determined from where the channel output spectrum intersected the display line.

The test was performed at 3 channels (Channel low, middle, high)



## 4.5. Maximum Power Spectral Density Measurement

### ■ Limit

For digitally modulated systems, the power spectral density conducted from the intentional radiator to the antenna shall not be greater than 8 dBm in any 3 kHz band during any time interval of continuous transmission.

IEEE 802.11b / IEEE 802.11g / IEEE 802.11n 2.4 GHz 20 MHz / IEEE 802.11n 2.4 GHz 40 MHz

### CDD/MIMO/BF mode:

Directional Gain =  $10 \cdot \log\{[10^{(G1/20)} + 10^{(G2/20)} + \dots + 10^{(Gn/20)}]^2 / NANT\}$  = 6.42 dBi > 6 dBi

\* power spectral density limit shall be reduced =  $8 - 0.42 = 7.58$  dBm/MHz

### ■ Test Setup

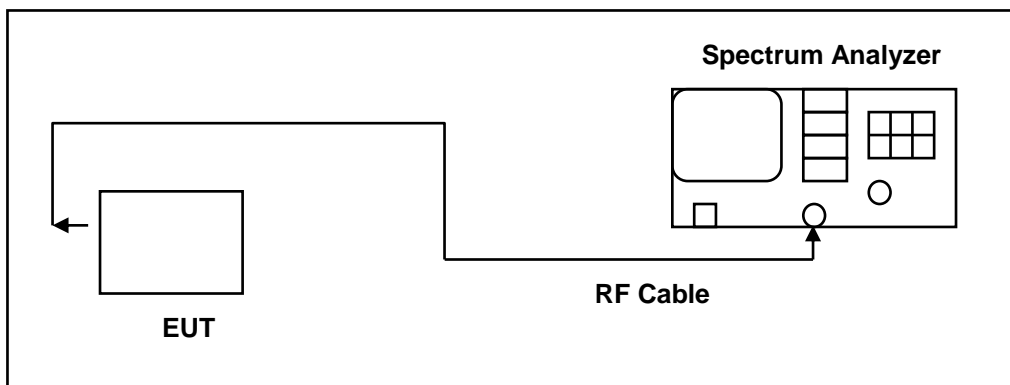

### ■ Test Procedure

The EUT tested to DTS test procedure of ANSI C63.10:2013 section 11.10.2 Method PKPSD for compliance to FCC 47CFR 15.247 requirements.

1. Set analyzer center frequency to DTS channel center frequency.
2. Set the span to 1.5 times the DTS bandwidth.
3. Set the RBW to:  $3 \text{ kHz} \leq \text{RBW} \leq 100 \text{ kHz}$ .
4. Set the VBW  $\geq 3 \times \text{RBW}$ .
5. Detector = peak.
6. Sweep time = auto couple.
7. Trace mode = max hold.
8. Allow trace to fully stabilize.
9. Use the peak marker function to determine the maximum amplitude level within the RBW.
10. If measured value exceeds limit, reduce RBW (no less than 3 kHz) and repeat.

#### 4.6. Out of Band Conducted Emissions Measurement

##### ■ Limit

In any 100 kHz bandwidth outside the frequency band in which the spread spectrum or digitally modulated intentional radiator is operating, the radio frequency power that is produced by the intentional radiator shall be at least 30 dB below that in the 100 kHz bandwidth within the band that contains the highest level of the desired power

##### ■ Test Setup

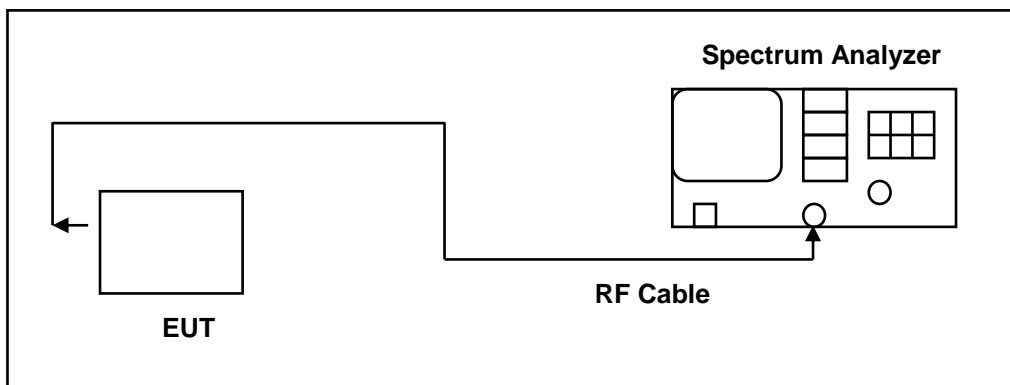

##### ■ Test Procedure

In any 100 kHz bandwidth outside the EUT pass band, the RF power produced by the modulation products of the spreading sequence, the information sequence, and the carrier frequency shall be at least 30 dB below that of the maximum in-band 100 kHz emission, antenna output of the EUT was coupled directly to spectrum analyzer; if an external attenuator and/or cable was used, these losses are compensated for with the analyzer OFFSET function. All other types of emissions from the EUT shall meet the general limits for radiated frequencies outside the pass band. The test was performed at 3 channels.



## 4.7. Antenna Measurement

### ■ Limit

For intentional device, according to 15.203, an intentional radiator shall be designed to ensure that no antenna other than that furnished by the responsible party shall be used with the device.

And According to 15.247 (b), if transmitting antennas of directional gain greater than 6 dBi are used, the power shall be reduced by the amount in dB that the directional gain of the antenna exceeds 6 dBi.

### ■ Antenna Description

See section 2 – antenna information.

### ■ Directional Gain Calculated

#### For Maximum Conducted Output Power

Operate Freq. Band	Directional Gain (dBi)
IEEE 802.11b Continuous TX mode	3.41
IEEE 802.11g Continuous TX mode	3.41
IEEE 802.11n 2.4 GHz 20 MHz	6.42
IEEE 802.11n 2.4 GHz 40 MHz	6.42

#### For Maximum Power Density

Operate Freq. Band	Directional Gain (dBi)
IEEE 802.11b Continuous TX mode	6.42
IEEE 802.11g Continuous TX mode	6.42
IEEE 802.11n 2.4 GHz 20 MHz	6.42
IEEE 802.11n 2.4 GHz 40 MHz	6.42

Beamforming on

#### For Maximum Conducted Output Power

Operate Freq. Band	Directional Gain (dBi)
IEEE 802.11n 2.4 GHz 20 MHz	6.42
IEEE 802.11n 2.4 GHz 40 MHz	6.42

#### For Maximum Power Density

Operate Freq. Band	Directional Gain (dBi)
IEEE 802.11n 2.4 GHz 20 MHz	6.42
IEEE 802.11n 2.4 GHz 40 MHz	6.42

## 5 Test Results

### Annex A. Conducted Emission

Standard:	FCC Part 15.247	Line:	L1
Test item:	Conducted Emission	Power:	AC 120 V/60 Hz
Mode:	Mode 1	Temp.(°C)/Hum.(%RH):	26(°C)/60 %RH
Description:			

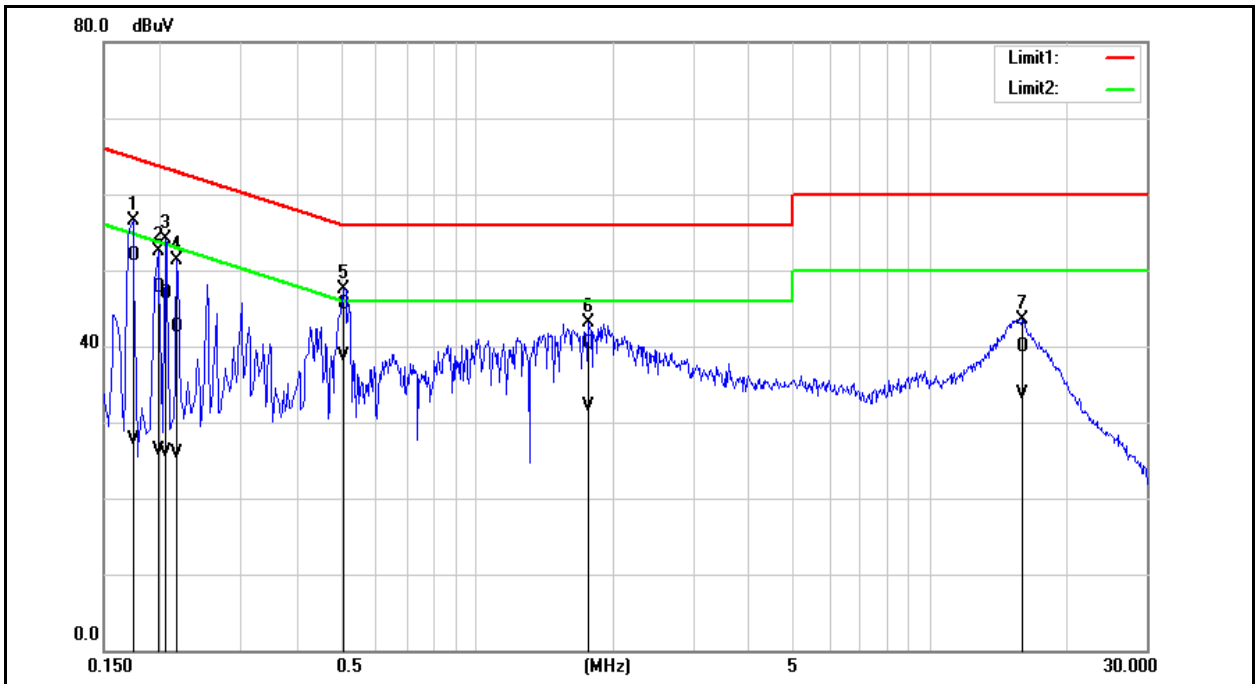

No.	Frequency (MHz)	QP reading (dBuV)	AVG reading (dBuV)	Correction factor (dB)	QP result (dBuV)	AVG result (dBuV)	QP limit (dBuV)	AVG limit (dBuV)	QP margin (dB)	AVG margin (dB)	Remark
1	0.1740	42.33	18.01	9.65	51.98	27.66	64.77	54.77	-12.79	-27.11	Pass
2	0.1980	38.01	16.62	9.64	47.65	26.26	63.69	53.69	-16.04	-27.43	Pass
3	0.2060	37.20	16.50	9.64	46.84	26.14	63.37	53.37	-16.53	-27.23	Pass
4	0.2180	32.81	16.17	9.64	42.45	25.81	62.89	52.89	-20.44	-27.08	Pass
5	0.5100	35.94	29.00	9.66	45.60	38.66	56.00	46.00	-10.40	-7.34	Pass
6	1.7700	30.65	22.46	9.71	40.36	32.17	56.00	46.00	-15.64	-13.83	Pass
7	15.9140	30.01	23.79	9.99	40.00	33.78	60.00	50.00	-20.00	-16.22	Pass

Note: 1. Result (dBuV) = Correction factor (dB) + Reading(dBuV).  
2. Correction factor (dB) = Cable loss (dB) + L.I.S.N. factor (dB).



Standard:	FCC Part 15.247	Line:	N
Test item:	Conducted Emission	Power:	AC 120 V/60 Hz
Mode:	Mode 1	Temp.(°C)/Hum.(%RH):	26(°C)/60 %RH
Description:			

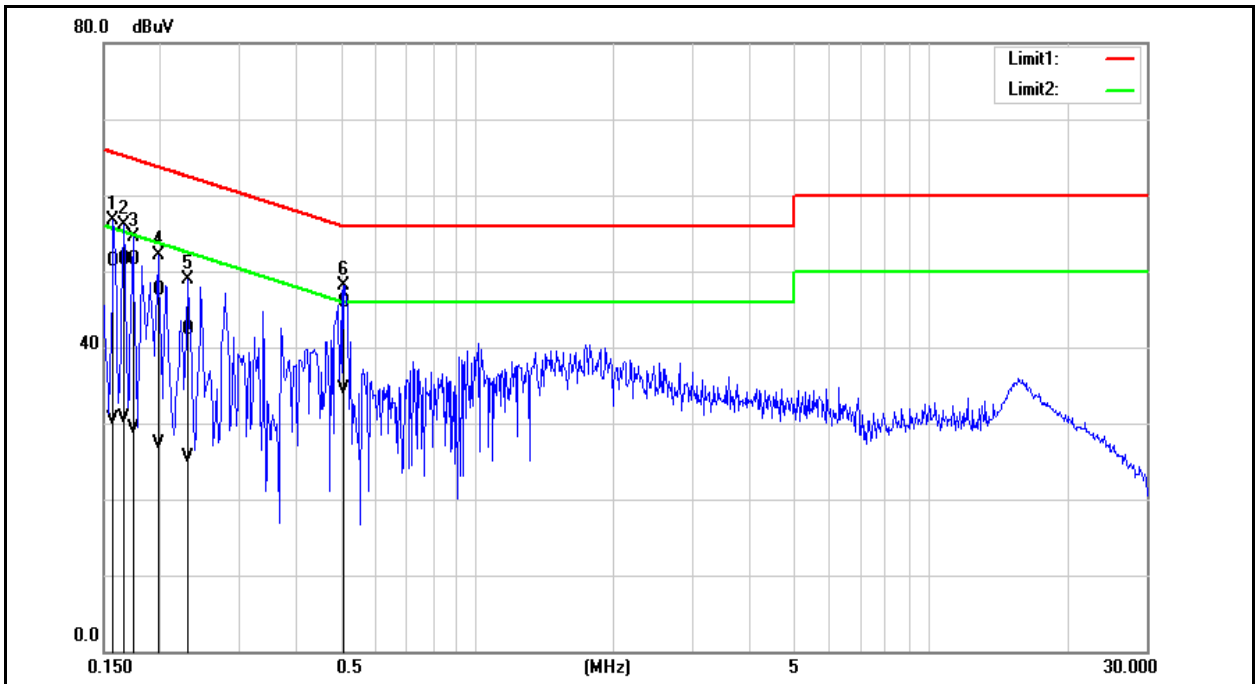

No.	Frequency (MHz)	QP reading (dBuV)	AVG reading (dBuV)	Correction factor (dB)	QP result (dBuV)	AVG result (dBuV)	QP limit (dBuV)	AVG limit (dBuV)	QP margin (dB)	AVG margin (dB)	Remark
1	0.1580	41.54	20.91	9.68	51.22	30.59	65.57	55.57	-14.35	-24.98	Pass
2	0.1660	41.74	21.02	9.68	51.42	30.70	65.16	55.16	-13.74	-24.46	Pass
3	0.1740	41.81	19.66	9.68	51.49	29.34	64.77	54.77	-13.28	-25.43	Pass
4	0.1980	37.92	17.72	9.67	47.59	27.39	63.69	53.69	-16.10	-26.30	Pass
5	0.2300	32.62	15.74	9.67	42.29	25.41	62.45	52.45	-20.16	-27.04	Pass
6	0.5100	36.28	24.77	9.69	45.97	34.46	56.00	46.00	-10.03	-11.54	Pass

Note: 1. Result (dBuV) = Correction factor (dB) + Reading(dBuV).  
2. Correction factor (dB) = Cable loss (dB) + L.I.S.N. factor (dB).

## Annex B. Conducted Test Results

### Maximum Conducted Output Power Measurement

ANT-0					
Test Mode	Frequency (MHz)	Data Rate	Average Output Power		
			Measurement Results		Limit
			dBm	W	dBm
Mode 2	2412	1 M	15.57	0.036	≤ 30
	2437		15.35	0.034	≤ 30
	2462		16.43	0.044	≤ 30
Mode 3	2412	6 M	16.12	0.041	≤ 30
	2437		18.50	0.071	≤ 30
	2462		15.72	0.037	≤ 30
Mode 4	2412	13 M	15.57	0.036	≤ 29.58
	2437		18.58	0.072	≤ 29.58
	2462		15.52	0.036	≤ 29.58
Mode 5	2422	27 M	15.09	0.032	≤ 29.58
	2437		15.08	0.032	≤ 29.58
	2452		15.28	0.034	≤ 29.58

ANT-1					
Test Mode	Frequency (MHz)	Data Rate	Average Output Power		
			Measurement Results		Limit
			dBm	W	dBm
Mode 2	2412	1 M	15.33	0.034	≤ 30
	2437		15.19	0.033	≤ 30
	2462		16.37	0.043	≤ 30
Mode 3	2412	6 M	16.27	0.042	≤ 30
	2437		18.20	0.066	≤ 30
	2462		15.64	0.037	≤ 30
Mode 4	2412	13 M	15.41	0.035	≤ 29.58
	2437		18.18	0.066	≤ 29.58
	2462		15.30	0.034	≤ 29.58
Mode 5	2422	27 M	15.17	0.033	≤ 29.58
	2437		14.93	0.031	≤ 29.58
	2452		15.03	0.032	≤ 29.58

Note: The relevant measured result has the offset with cable loss already.



ANT-0+1					
Test Mode	Frequency (MHz)	Data Rate	Average Output Power		
			Measurement Results		Limit
			dBm	W	dBm
Mode 2	2412	1 M	18.46	0.070	≤ 30
	2437		18.28	0.067	≤ 30
	2462		<b>19.41</b>	<b>0.087</b>	≤ 30
Mode 3	2412	6 M	19.21	0.083	≤ 30
	2437		<b>21.36</b>	<b>0.137</b>	≤ 30
	2462		18.69	0.074	≤ 30
Mode 4	2412	13 M	18.50	0.071	≤ 29.58
	2437		<b>21.39</b>	<b>0.138</b>	≤ 29.58
	2462		18.42	0.070	≤ 29.58
Mode 5	2422	27 M	18.14	0.065	≤ 29.58
	2437		18.02	0.063	≤ 29.58
	2452		<b>18.17</b>	<b>0.066</b>	≤ 29.58

Note: The relevant measured result has the offset with cable loss already.



Beamforming on

ANT-0					
Test Mode	Frequency (MHz)	Data Rate	Average Output Power		
			Measurement Results		Limit
			dBm	W	dBm
Mode 4	2412	13 M	12.21	0.017	≤ 30
	2437		15.32	0.034	≤ 30
	2462		11.87	0.015	≤ 30
Mode 5	2422	27 M	11.41	0.014	≤ 30
	2437		11.37	0.014	≤ 30
	2452		11.69	0.015	≤ 30

ANT-1					
Test Mode	Frequency (MHz)	Data Rate	Average Output Power		
			Measurement Results		Limit
			dBm	W	dBm
Mode 4	2412	13 M	12.10	0.016	≤ 30
	2437		14.79	0.030	≤ 30
	2462		11.76	0.015	≤ 30
Mode 5	2422	27 M	11.52	0.014	≤ 30
	2437		11.30	0.013	≤ 30
	2452		11.33	0.014	≤ 30

ANT-0+1					
Test Mode	Frequency (MHz)	Data Rate	Average Output Power		
			Measurement Results		Limit
			dBm	W	dBm
Mode 4	2412	13 M	15.17	0.033	≤ 30
	2437		<b>18.07</b>	<b>0.064</b>	≤ 30
	2462		14.83	0.030	≤ 30
Mode 5	2422	27 M	14.48	0.028	≤ 30
	2437		14.35	0.027	≤ 30
	2452		<b>14.52</b>	<b>0.028</b>	≤ 30

Note: The relevant measured result has the offset with cable loss already.





**6 dB RF Bandwidth Measurement**

Test Mode	Frequency (MHz)	Measurement (kHz)		Limit (kHz)
		ANT-0	ANT-1	
Mode 2	2412	8585	8093	≥ 500
	2437	9063	8097	≥ 500
	2462	9068	8100	≥ 500
Mode 3	2412	16360	16360	≥ 500
	2437	16350	16340	≥ 500
	2462	16360	16370	≥ 500
Mode 4	2412	17590	17590	≥ 500
	2437	17590	17580	≥ 500
	2462	17600	17580	≥ 500
Mode 5	2422	35190	35200	≥ 500
	2437	35200	35170	≥ 500
	2452	35160	35160	≥ 500

Beamforming on

Test Mode	Frequency (MHz)	Measurement (kHz)		Limit (kHz)
		ANT-0	ANT-1	
Mode 4	2412	17600	17600	≥ 500
	2437	17590	17610	≥ 500
	2462	17590	17620	≥ 500
Mode 5	2422	35170	35170	≥ 500
	2437	35170	35130	≥ 500
	2452	35180	35170	≥ 500



■ Test Graphs

Mode 2: IEEE 802.11b Continuous TX mode\_ANT-0

2412 MHz



2437 MHz



2462 MHz





Mode 3: IEEE 802.11g Continuous TX mode\_ANT-0

2412 MHz

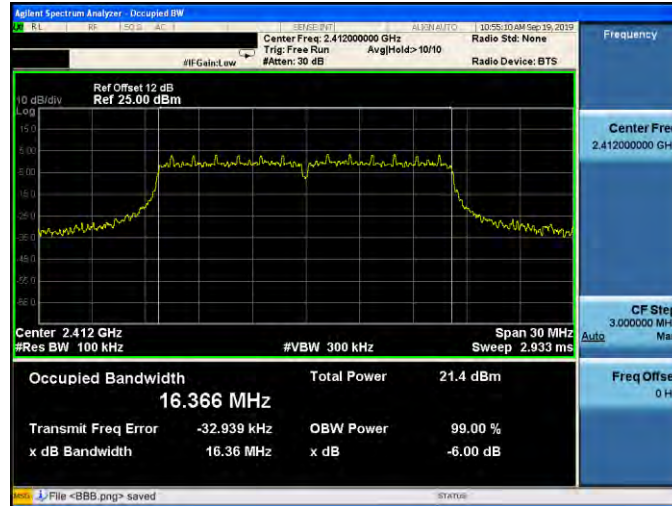

2437 MHz

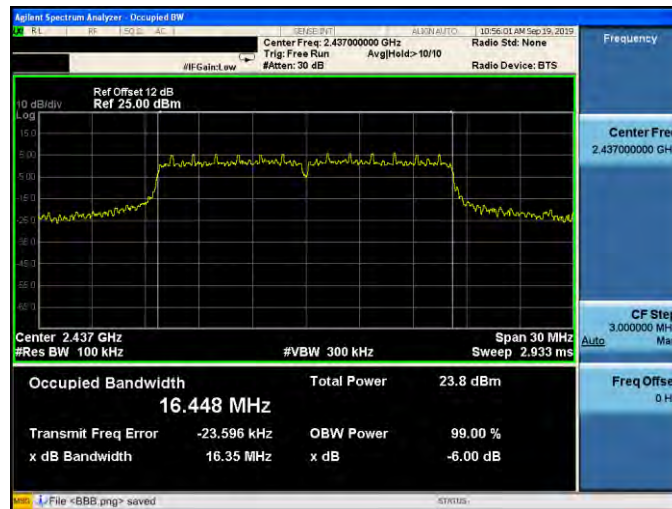

2462 MHz





Mode 4: IEEE 802.11n 2.4 GHz 20 MHz Continuous TX mode \_ANT-0

2412 MHz



2437 MHz

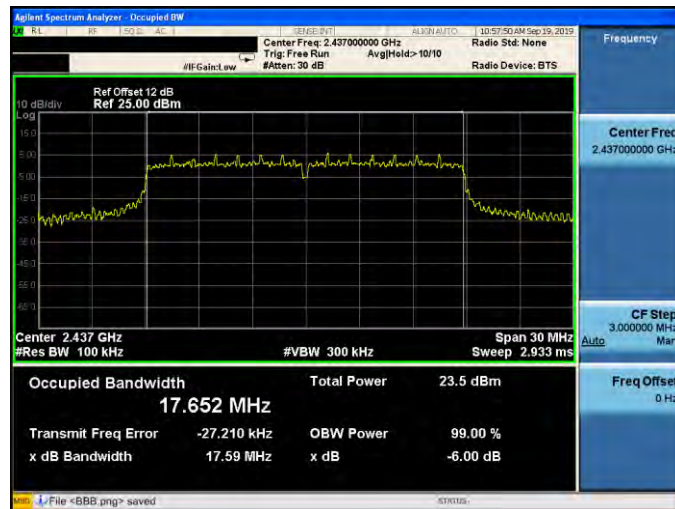

2462 MHz

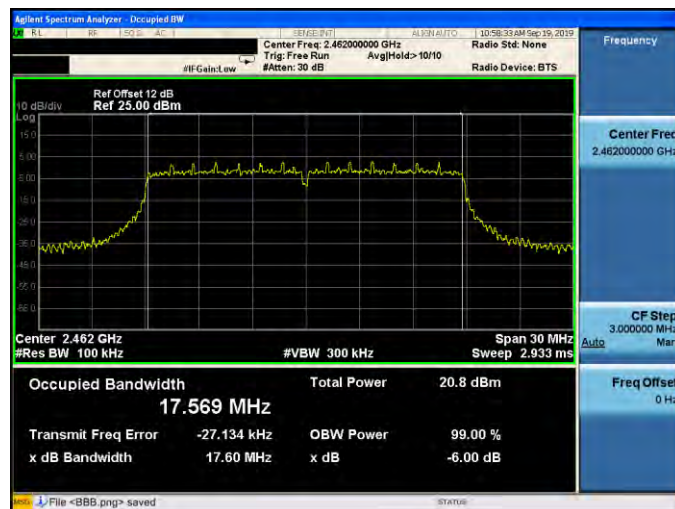





Mode 5: IEEE 802.11n 2.4 GHz 40 MHz Continuous TX mode\_ANT-0

2422 MHz

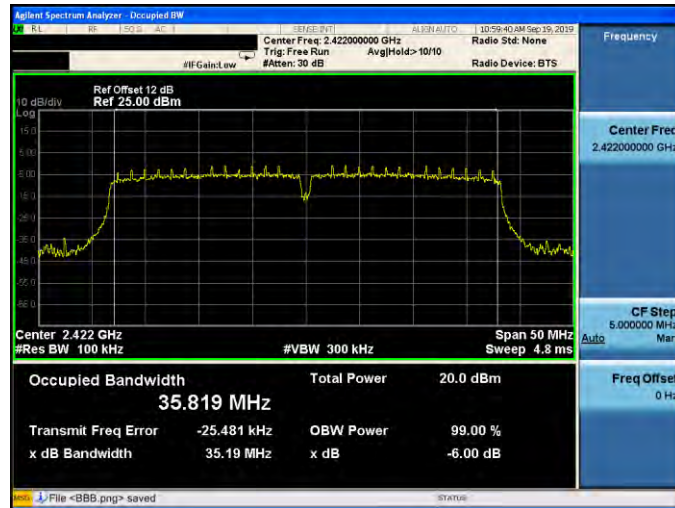

2437 MHz

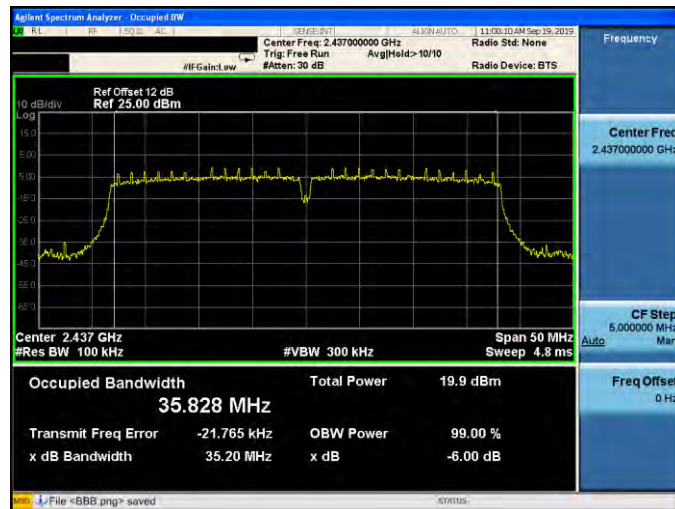

2452 MHz

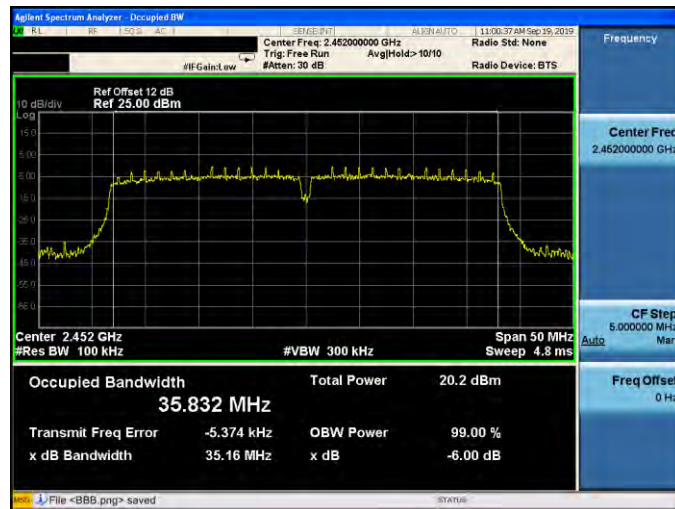



Mode 2: IEEE 802.11b Continuous TX mode\_ANT-1

2412 MHz



2437 MHz



2462 MHz





Mode 3: IEEE 802.11g Continuous TX mode\_ANT-1

2412 MHz

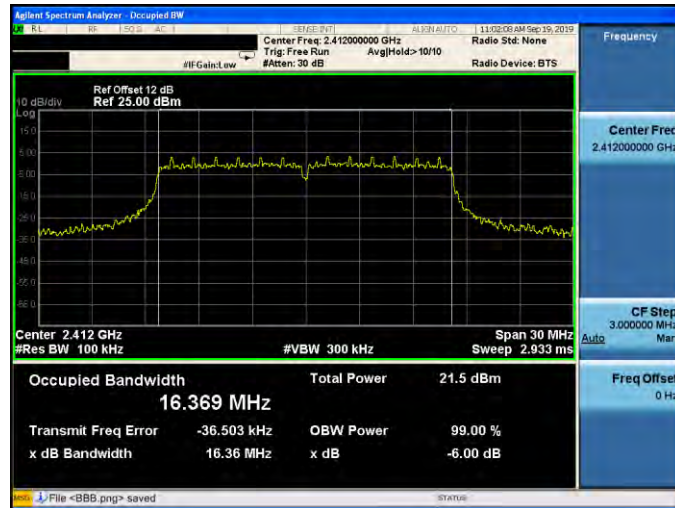

2437 MHz

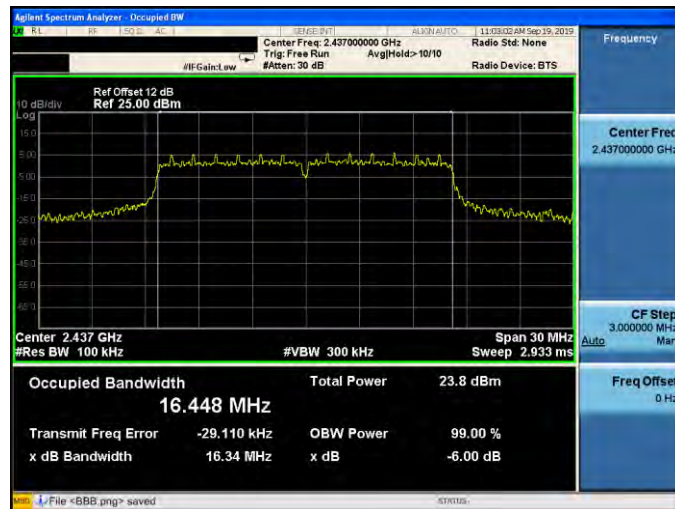

2462 MHz







Mode 4: IEEE 802.11n 2.4 GHz 20 MHz Continuous TX mode\_ANT-1

2412 MHz

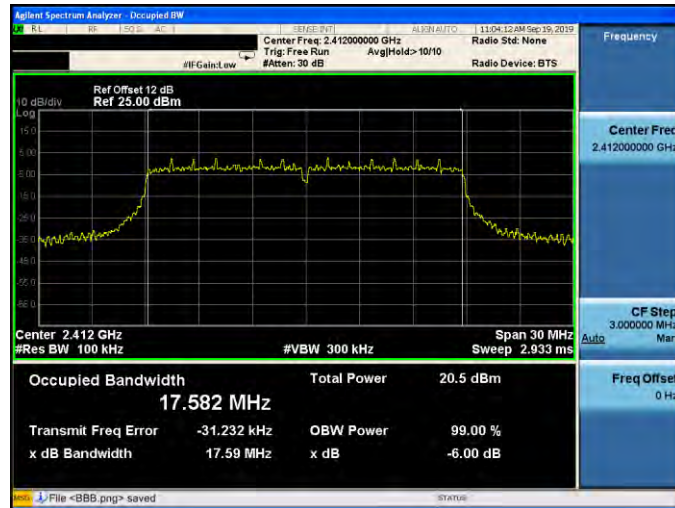

2437 MHz

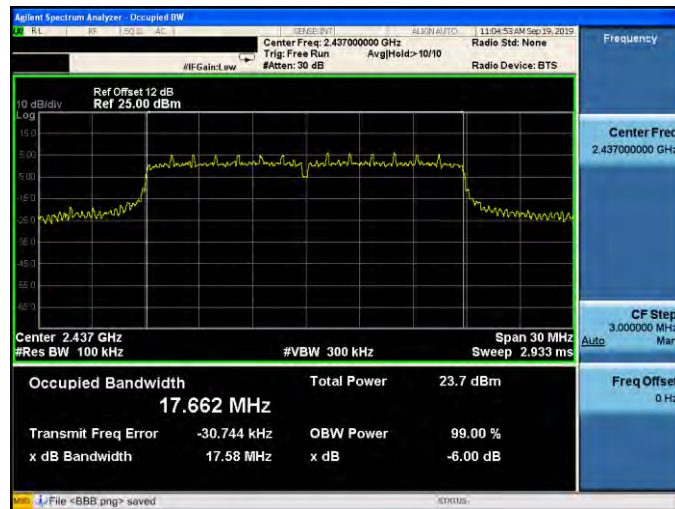

2462 MHz

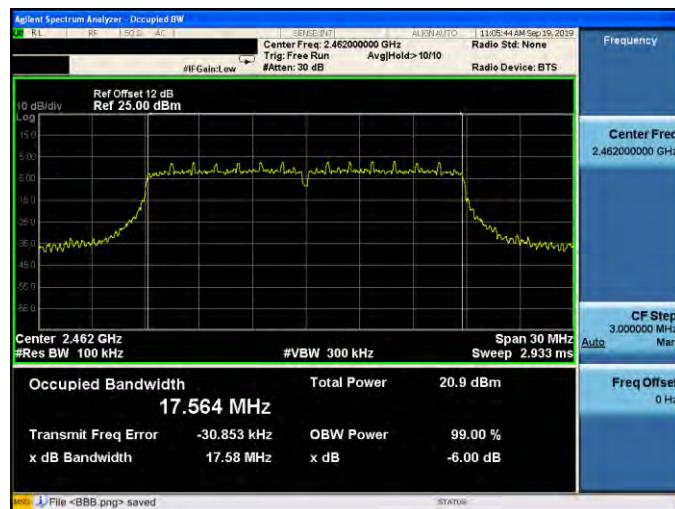





Mode 5: IEEE 802.11n 2.4 GHz 40 MHz Continuous TX mode\_ANT-1

2422 MHz

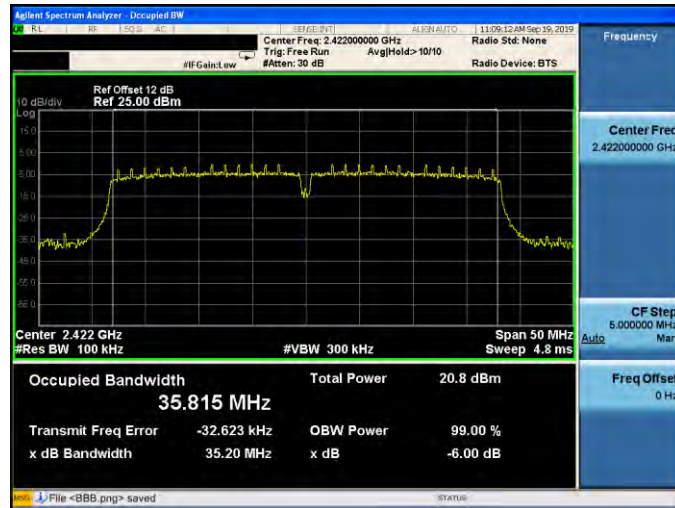

2437 MHz

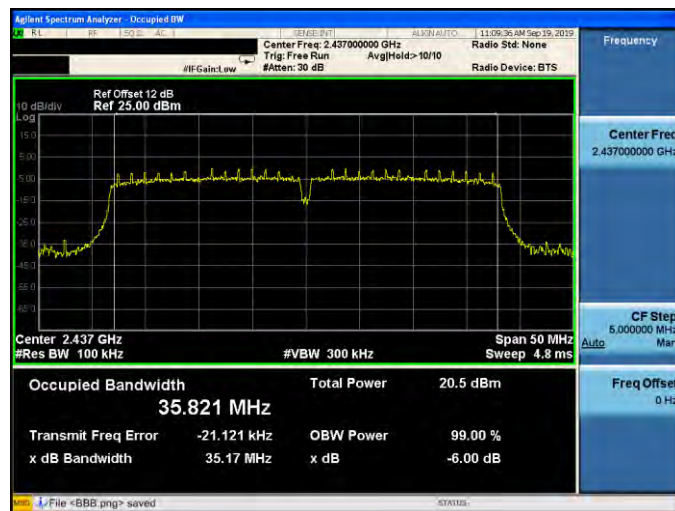

2452 MHz

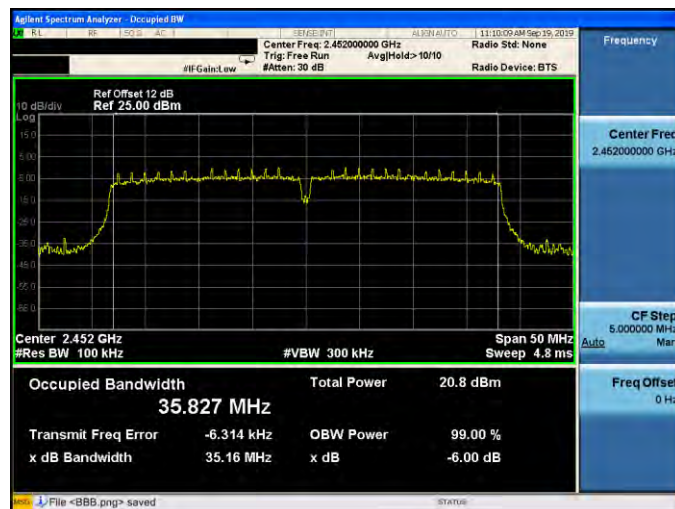



Beamforming on

Mode 4: IEEE 802.11n 2.4 GHz 20 MHz Continuous TX mode\_ANT-0

2412 MHz	<p>Agilent Spectrum Analyzer - Occupied BW</p> <p>Center Freq: 2.412000000 GHz</p> <p>Occupied Bandwidth: 17.557 MHz</p> <p>Total Power: 16.2 dBm</p> <p>Transmit Freq Error: -33.440 kHz</p> <p>x dB Bandwidth: 17.60 MHz</p>
2437 MHz	<p>Agilent Spectrum Analyzer - Occupied BW</p> <p>Center Freq: 2.437000000 GHz</p> <p>Occupied Bandwidth: 17.569 MHz</p> <p>Total Power: 19.1 dBm</p> <p>Transmit Freq Error: -34.269 kHz</p> <p>x dB Bandwidth: 17.59 MHz</p>
2462 MHz	<p>Agilent Spectrum Analyzer - Occupied BW</p> <p>Center Freq: 2.462000000 GHz</p> <p>Occupied Bandwidth: 17.569 MHz</p> <p>Total Power: 15.6 dBm</p> <p>Transmit Freq Error: -28.397 kHz</p> <p>x dB Bandwidth: 17.59 MHz</p>



Mode 5: IEEE 802.11n 2.4 GHz 40 MHz Continuous TX mode\_ANT-0

2422 MHz

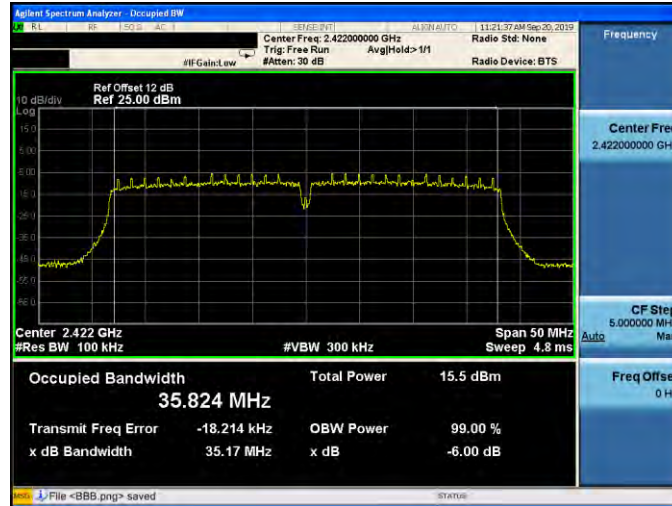

2437 MHz



2452 MHz

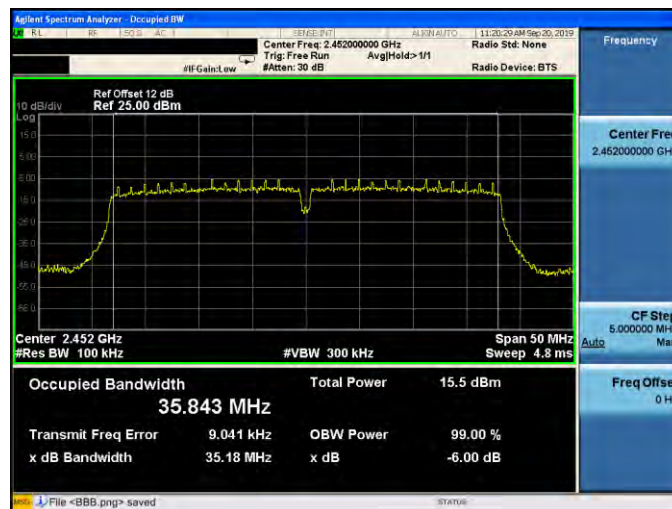





Mode 4: IEEE 802.11n 2.4 GHz 20 MHz Continuous TX mode\_ANT-1

2412 MHz

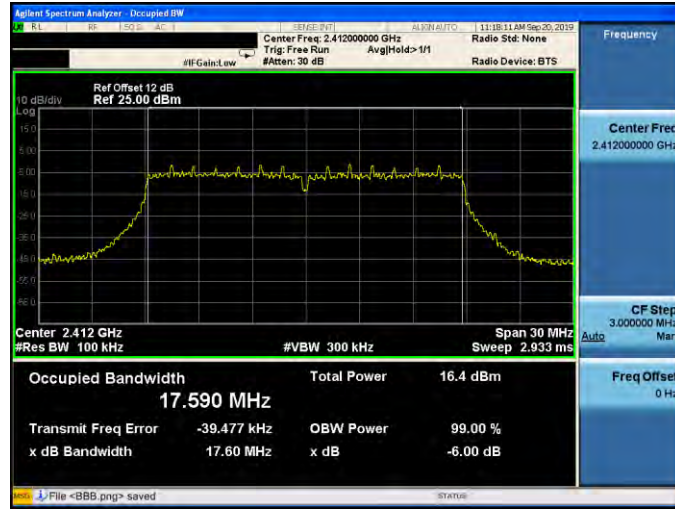

2437 MHz

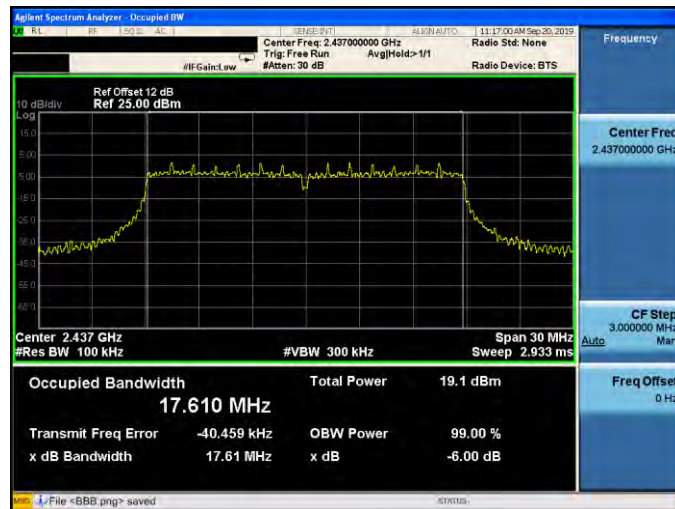

2462 MHz

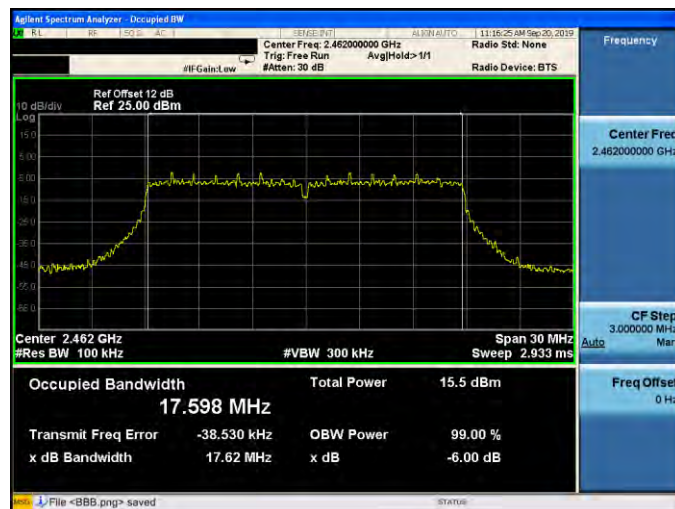



Mode 5: IEEE 802.11n 2.4 GHz 40 MHz Continuous TX mode \_ANT-1

2422 MHz

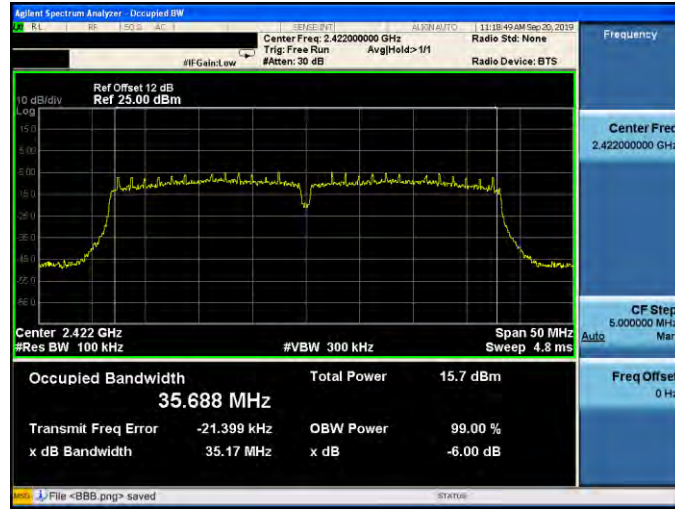

2437 MHz

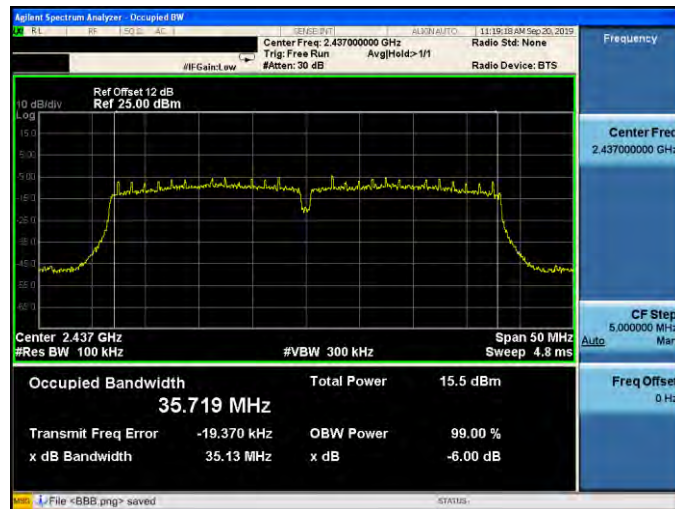

2452 MHz

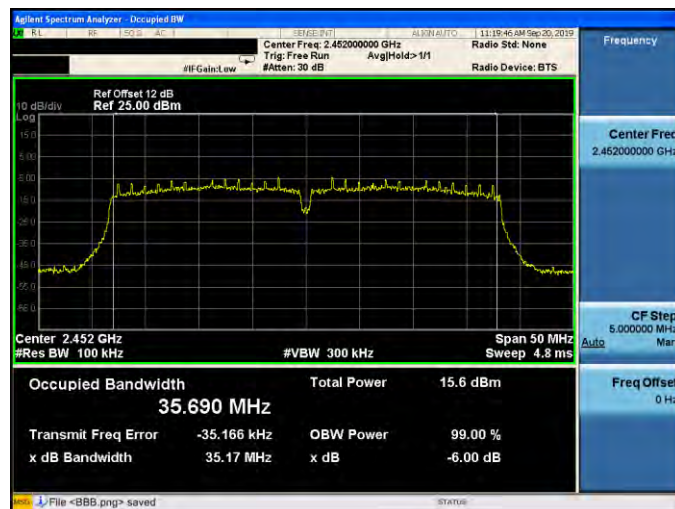



**Maximum Power Spectral Density Measurement**

Test Mode	Frequency (MHz)	Measurement (dBm/3 kHz)			Limit (dBm/ 3 kHz)
		ANT-0	ANT-1	ANT-0+1	
Mode 2	2412	-9.393	-9.574	-6.472	≤ 7.58
	2437	-9.271	-9.641	-6.442	≤ 7.58
	2462	-8.166	-8.438	-5.290	≤ 7.58
Mode 3	2412	-12.697	-12.685	-9.681	≤ 7.58
	2437	-10.206	-10.595	-7.386	≤ 7.58
	2462	-13.127	-13.293	-10.199	≤ 7.58
Mode 4	2412	-13.235	-13.407	-10.310	≤ 7.58
	2437	-10.669	-10.835	-7.741	≤ 7.58
	2462	-13.369	-13.340	-10.344	≤ 7.58
Mode 5	2422	-15.344	-15.155	-12.238	≤ 7.58
	2437	-15.348	-15.387	-12.357	≤ 7.58
	2452	-15.140	-15.328	-12.223	≤ 7.58

Beamforming on

Test Mode	Frequency (MHz)	Measurement (dBm/3 kHz)			Limit (dBm/ 3 kHz)
		ANT-0	ANT-1	ANT-0+1	
Mode 4	2412	-16.831	-16.962	-13.886	≤ 7.58
	2437	-14.155	-14.284	-11.209	≤ 7.58
	2462	-17.068	-17.099	-14.073	≤ 7.58
Mode 5	2422	-19.090	-18.592	-15.824	≤ 7.58
	2437	-19.339	-19.025	-16.169	≤ 7.58
	2452	-19.238	-19.110	-16.163	≤ 7.58



Mode 2: IEEE 802.11b Continuous TX mode\_ANT-0

2412 MHz



2437 MHz



2462 MHz







Mode 3: IEEE 802.11g Continuous TX mode\_ANT-0

2412 MHz

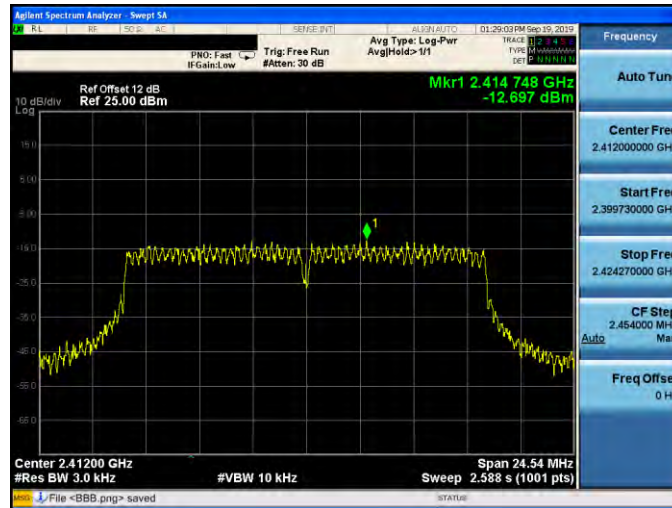

2437 MHz

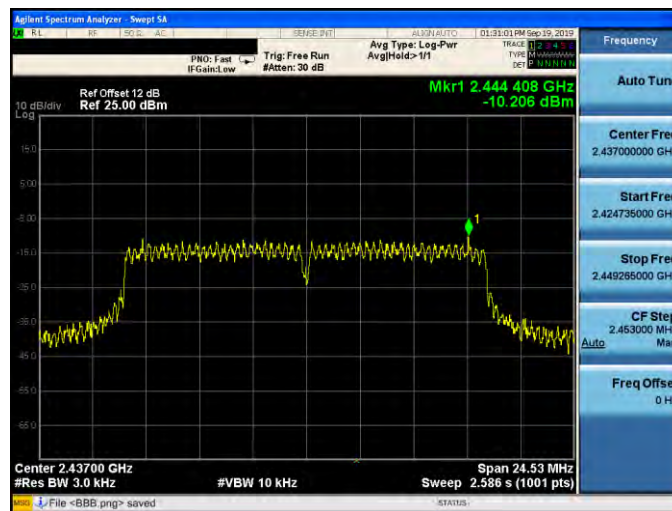

2462 MHz

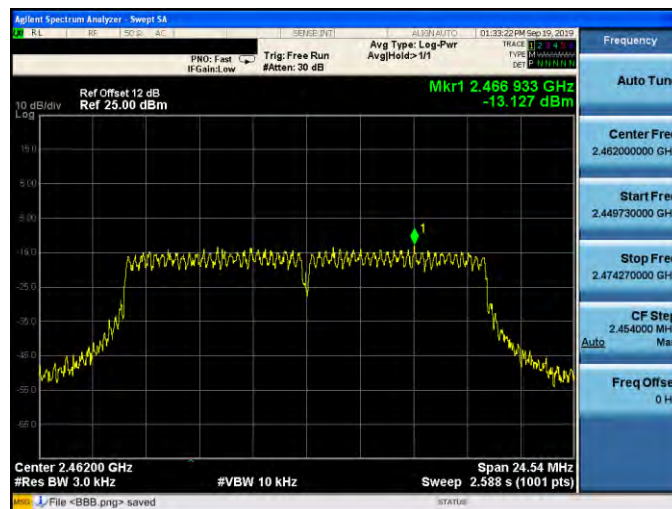





Mode 4: IEEE 802.11n 2.4 GHz 20 MHz Continuous TX mode \_ANT-0

2412 MHz

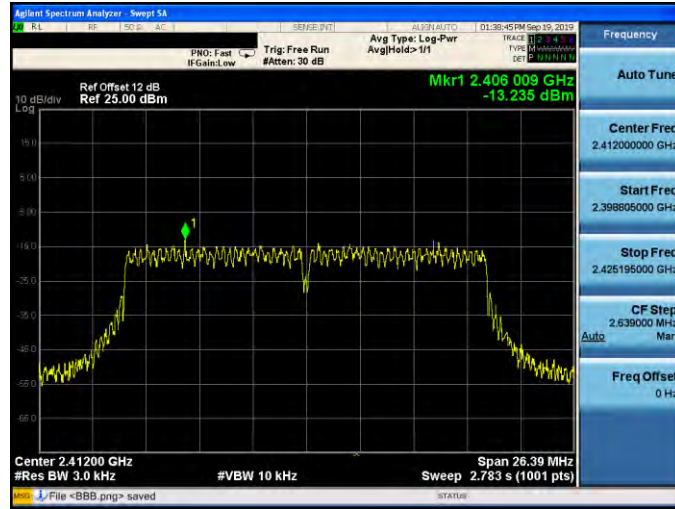

2437 MHz

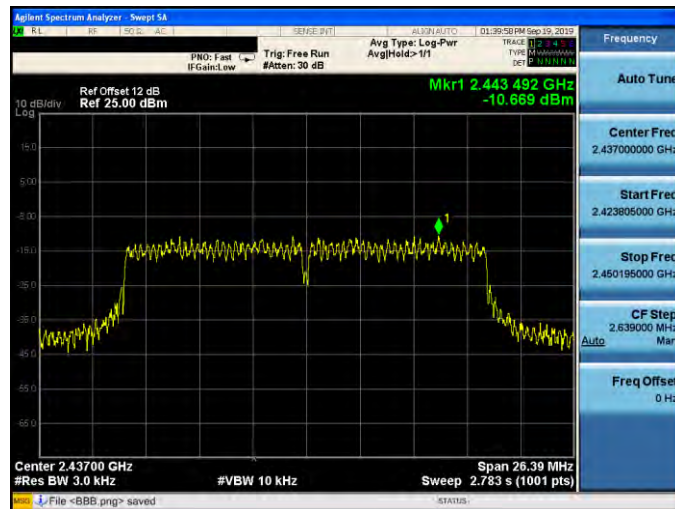

2462 MHz

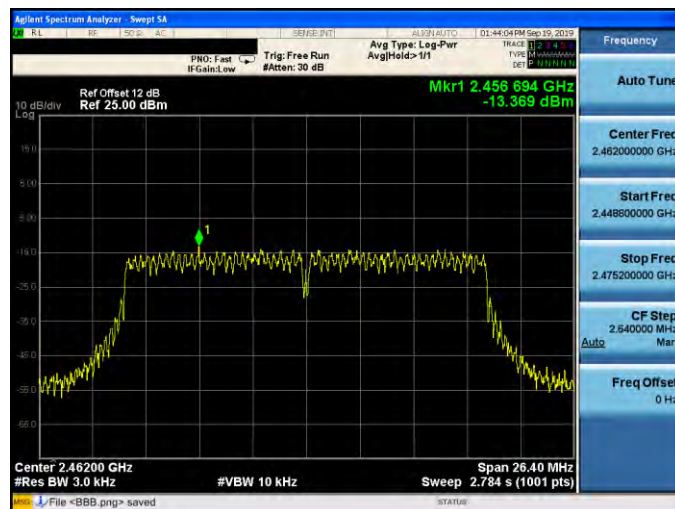



Mode 5: IEEE 802.11n 2.4 GHz 40 MHz Continuous TX mode \_ANT-0

2422 MHz

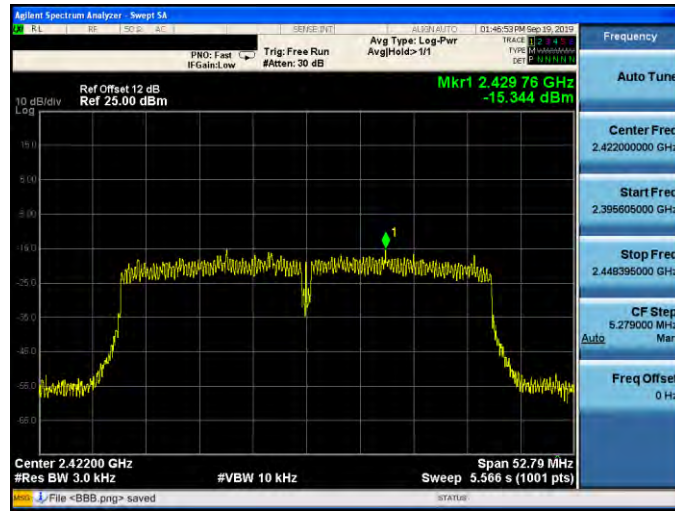

2437 MHz

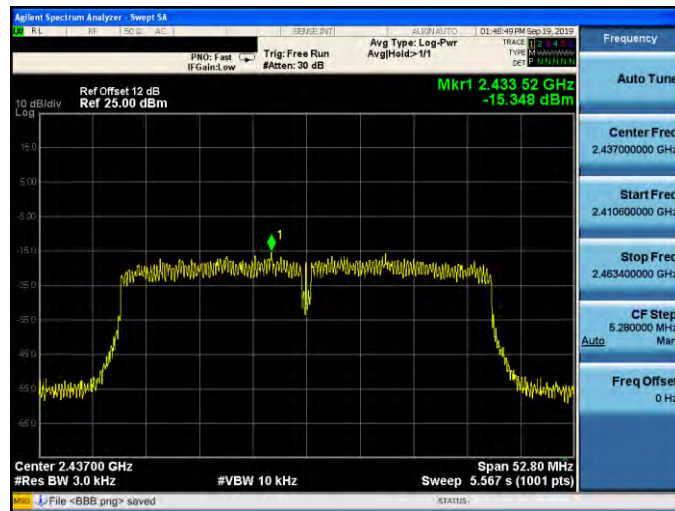

2452 MHz

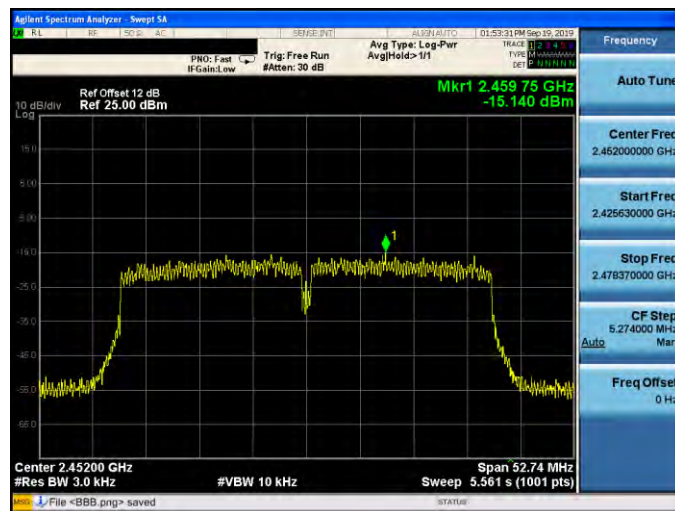



Mode 2: IEEE 802.11b Continuous TX mode\_ANT-1

2412 MHz



2437 MHz



2462 MHz







Mode 3: IEEE 802.11g Continuous TX mode\_ANT-1

2412 MHz

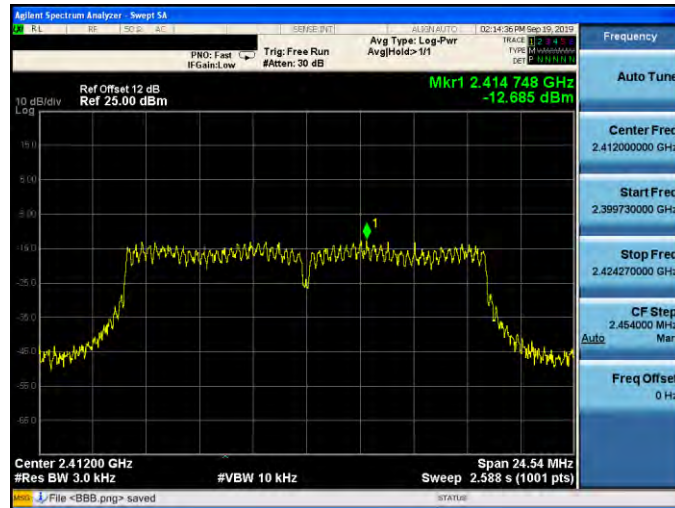

2437 MHz

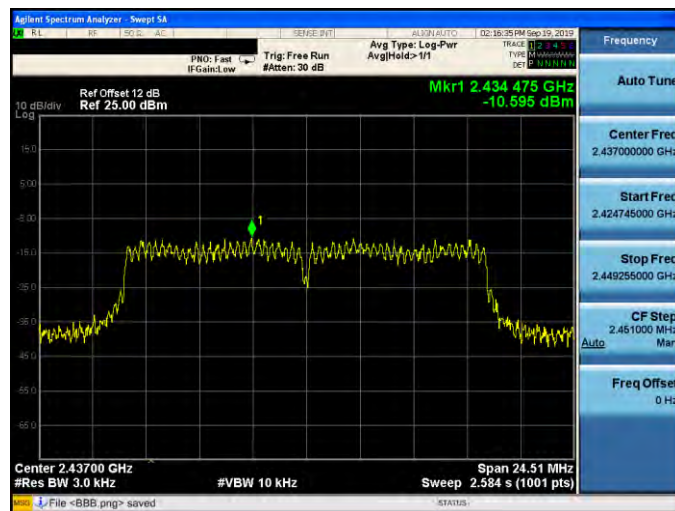

2462 MHz

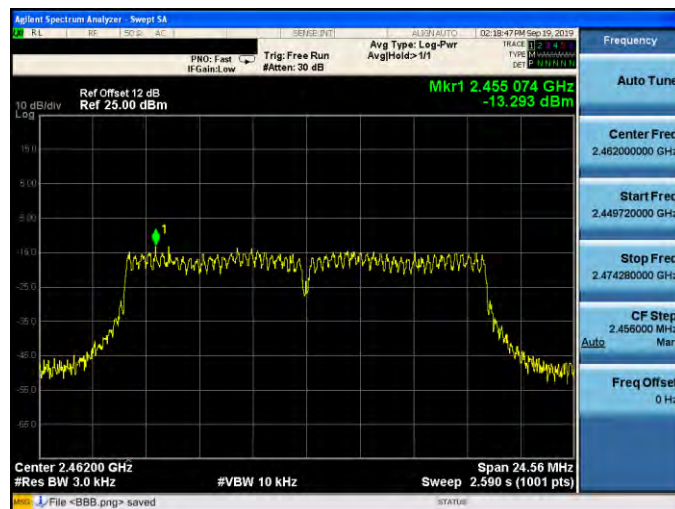



Mode 4: IEEE 802.11n 2.4 GHz 20 MHz Continuous TX mode\_ANT-1

2412 MHz

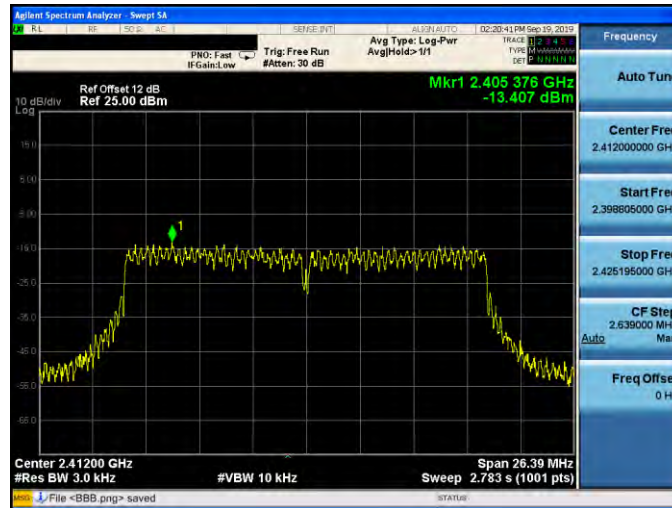

2437 MHz

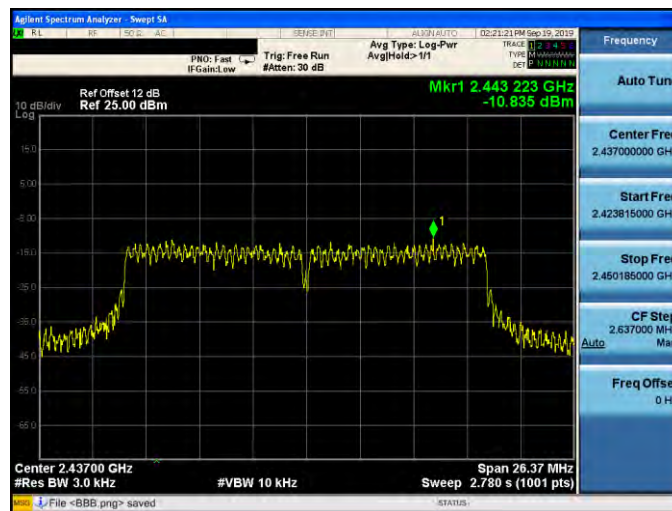

2462 MHz

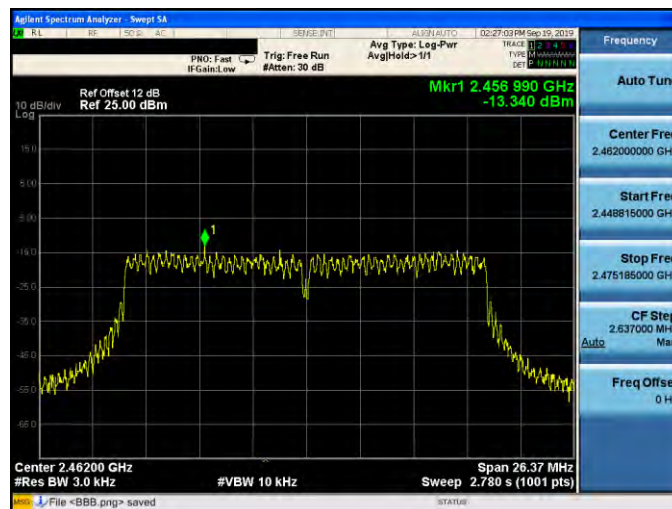



Mode 5: IEEE 802.11n 2.4 GHz 40 MHz Continuous TX mode \_ANT-1

2422 MHz

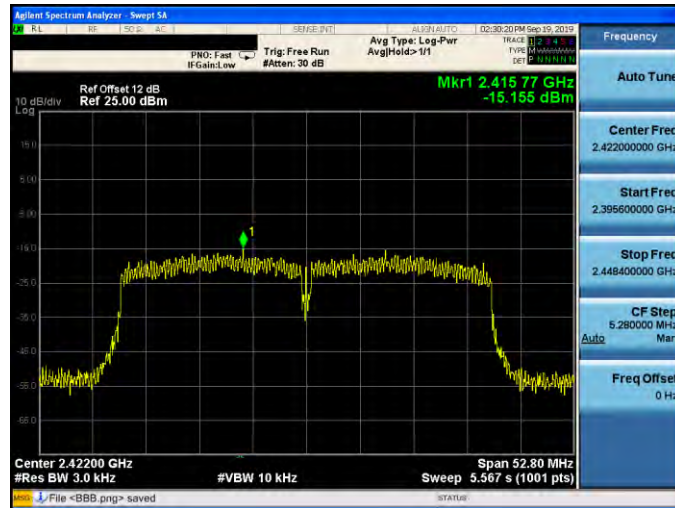

2437 MHz

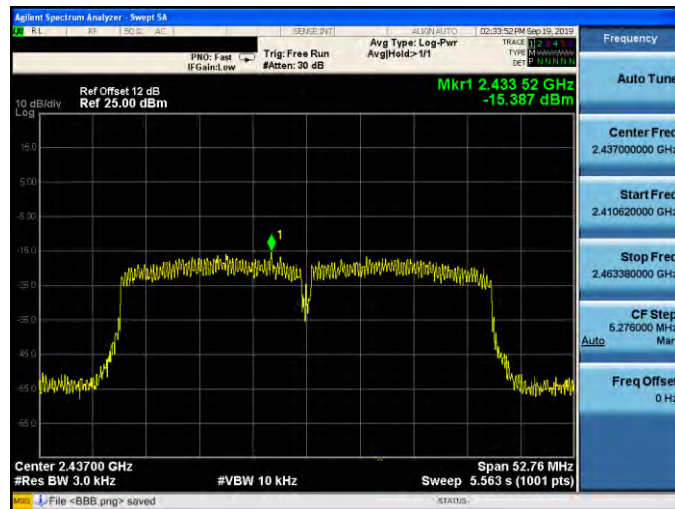

2452 MHz

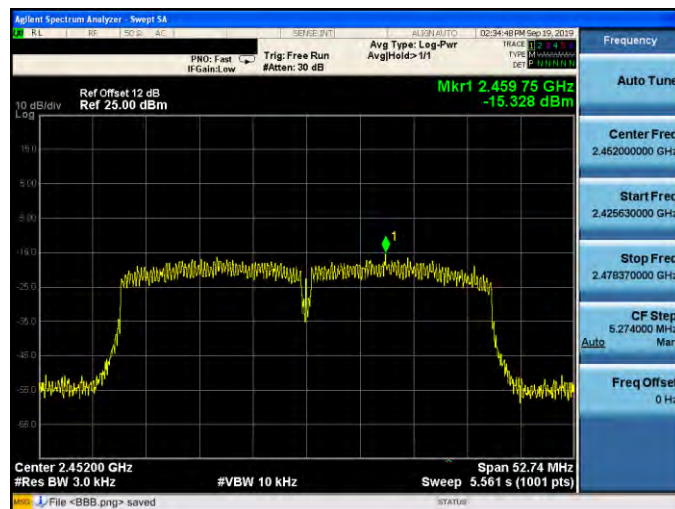





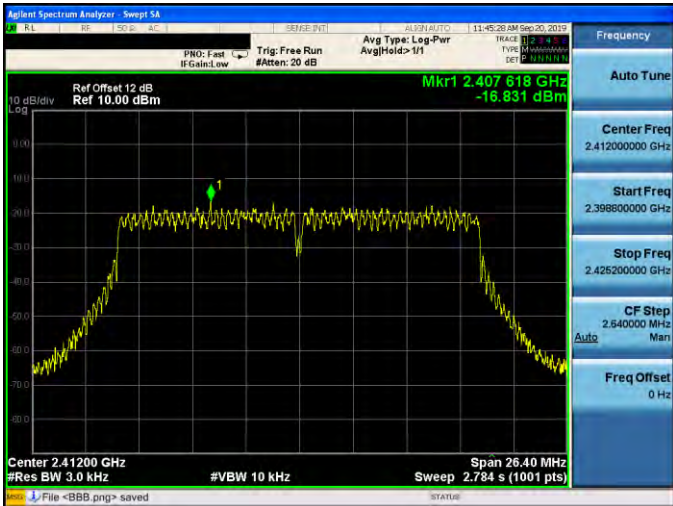

Beamforming on

Mode 4: IEEE 802.11n 2.4 GHz 20 MHz Continuous TX mode\_ANT-0

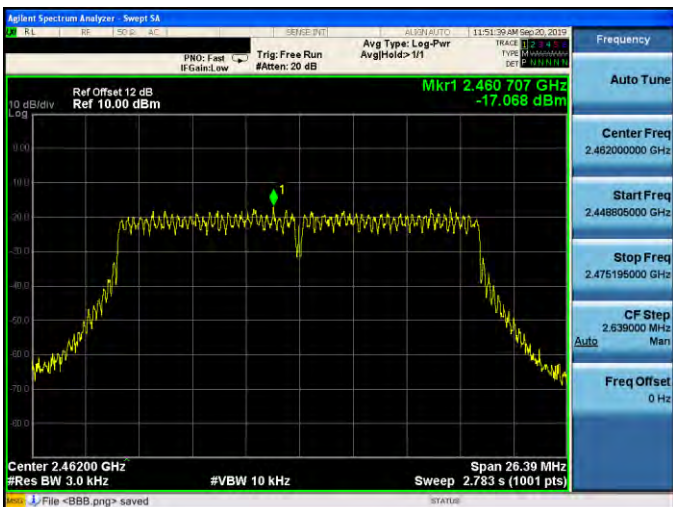
2412 MHz	 <p>Agilent Spectrum Analyzer Sweep SA</p> <p>AL331 AUTO 11:45:28 AM Sep 20, 2019</p> <p>Ref Offset 12 dB Ref 10.00 dBm</p> <p>Mkr1 2.407 818 GHz -16.831 dBm</p> <p>Center 2.41200 GHz Span 26.40 MHz #Res BW 3.0 kHz #VBW 10 kHz Sweep 2.784 s (1001 pts)</p> <p>Frequency</p> <p>Auto Tune</p> <p>Center Freq 2.41200000 GHz</p> <p>Start Freq 2.39860000 GHz</p> <p>Stop Freq 2.42520000 GHz</p> <p>CF Step 2.640000 MHz Auto Man</p> <p>Freq Offset 0 Hz</p>
2437 MHz	 <p>Agilent Spectrum Analyzer Sweep SA</p> <p>AL331 AUTO 11:49:36 AM Sep 20, 2019</p> <p>Ref Offset 12 dB Ref 10.00 dBm</p> <p>Mkr1 2.439 745 GHz -14.155 dBm</p> <p>Center 2.43700 GHz Span 26.39 MHz #Res BW 3.0 kHz #VBW 10 kHz Sweep 2.783 s (1001 pts)</p> <p>Frequency</p> <p>Auto Tune</p> <p>Center Freq 2.43700000 GHz</p> <p>Start Freq 2.42380500 GHz</p> <p>Stop Freq 2.45019500 GHz</p> <p>CF Step 2.639000 MHz Auto Man</p> <p>Freq Offset 0 Hz</p>
2462 MHz	 <p>Agilent Spectrum Analyzer Sweep SA</p> <p>AL331 AUTO 11:51:30 AM Sep 20, 2019</p> <p>Ref Offset 12 dB Ref 10.00 dBm</p> <p>Mkr1 2.460 707 GHz -17.068 dBm</p> <p>Center 2.46200 GHz Span 26.39 MHz #Res BW 3.0 kHz #VBW 10 kHz Sweep 2.783 s (1001 pts)</p> <p>Frequency</p> <p>Auto Tune</p> <p>Center Freq 2.46200000 GHz</p> <p>Start Freq 2.44880500 GHz</p> <p>Stop Freq 2.47519500 GHz</p> <p>CF Step 2.639000 MHz Auto Man</p> <p>Freq Offset 0 Hz</p>



Mode 5: IEEE 802.11n 2.4 GHz 40 MHz Continuous TX mode \_ANT-0

2422 MHz



2437 MHz

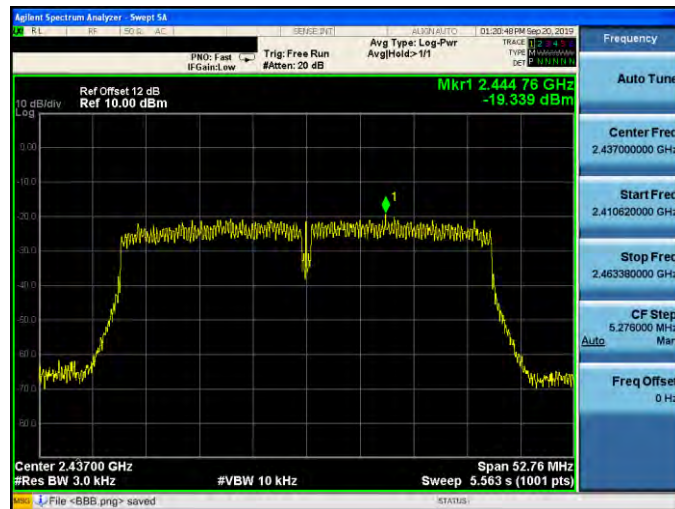

2452 MHz

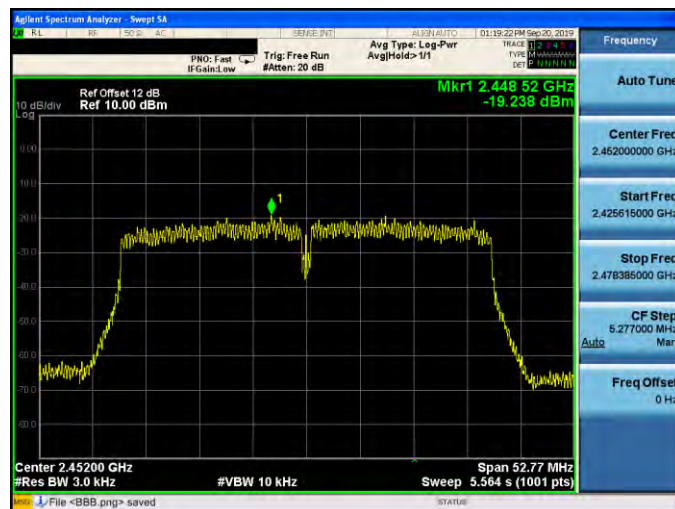





Mode 4: IEEE 802.11n 2.4 GHz 20 MHz Continuous TX mode\_ANT-1

2412 MHz

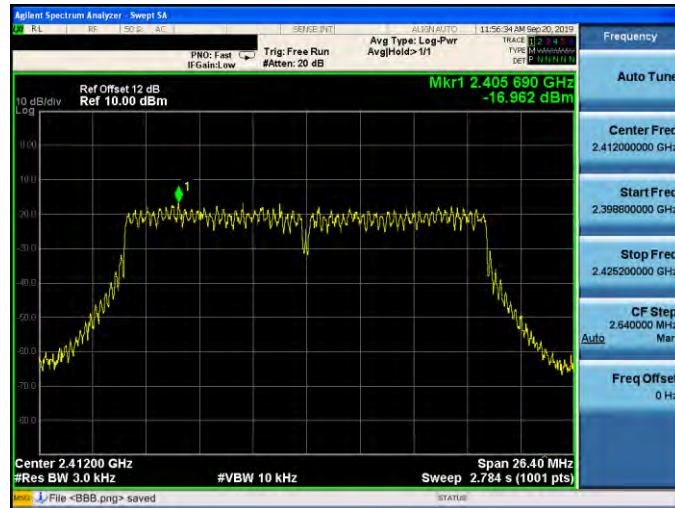

2437 MHz



2462 MHz

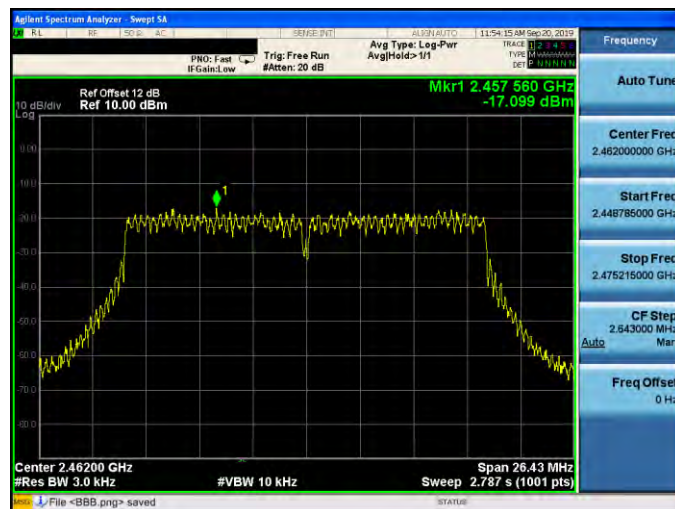



Mode 5: IEEE 802.11n 2.4 GHz 40 MHz Continuous TX mode\_ANT-1

2422 MHz



2437 MHz



2452 MHz

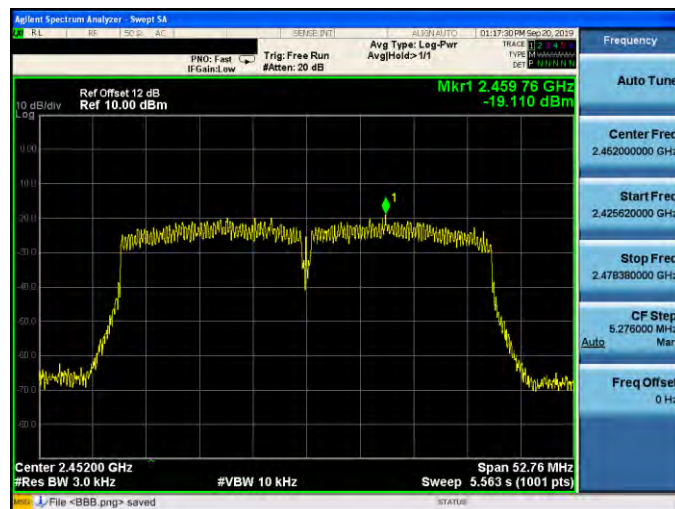

### Out of Band Conducted Emissions Measurement

■ Test Graphs

Reference level

Mode 2: IEEE 802.11b Continuous TX mode\_ANT-0

<p>2412 MHz</p>	
<p>2437 MHz</p>	
<p>2462 MHz</p>	





Mode 3: IEEE 802.11g Continuous TX mode\_ANT-0

2412 MHz

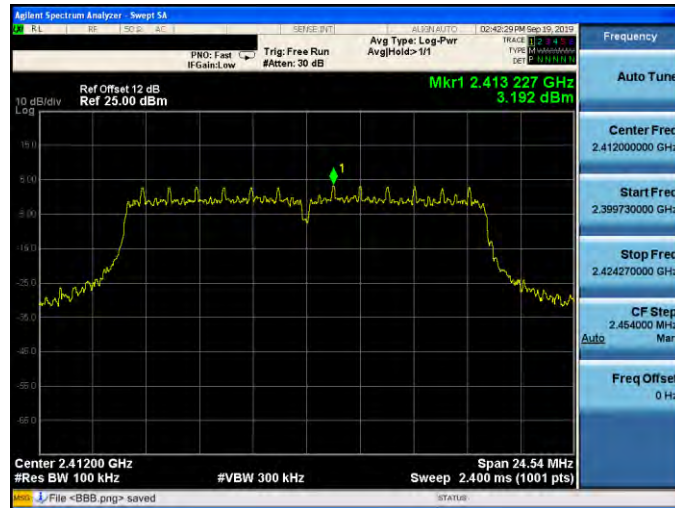

2437 MHz

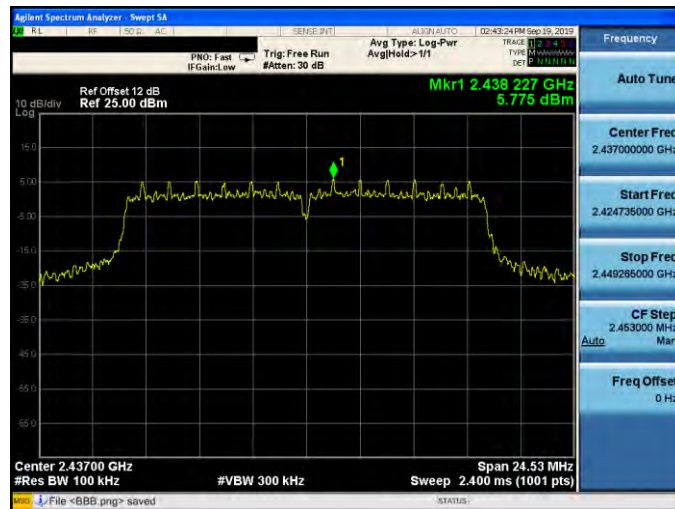

2462 MHz





Mode 4: IEEE 802.11n 2.4 GHz 20 MHz Continuous TX mode \_ANT-0

2412 MHz

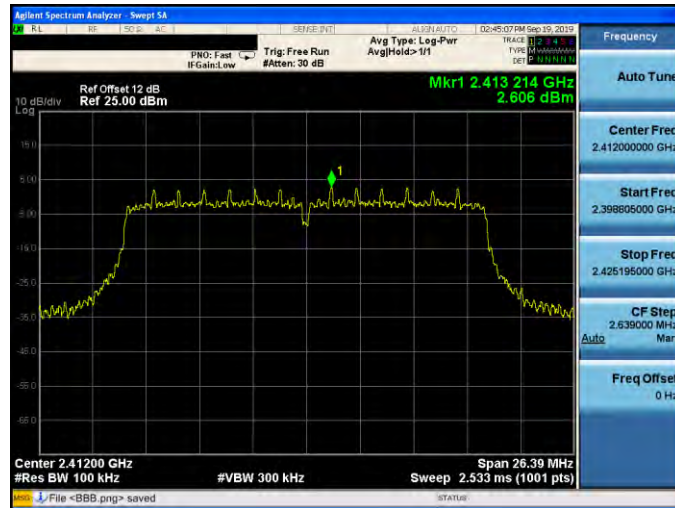

2437 MHz

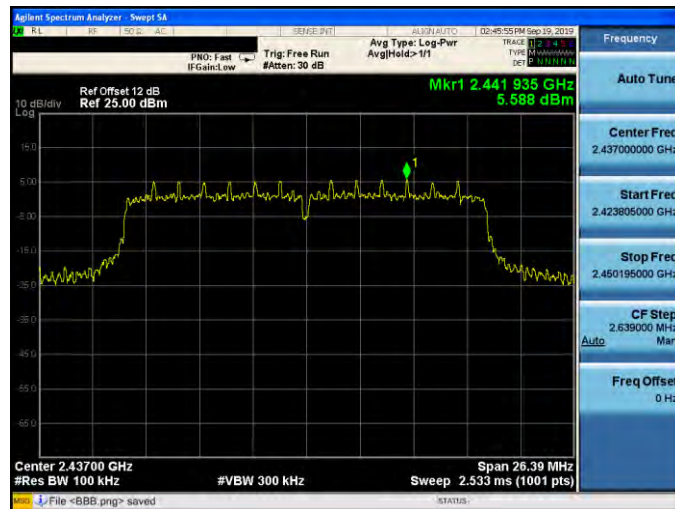

2462 MHz

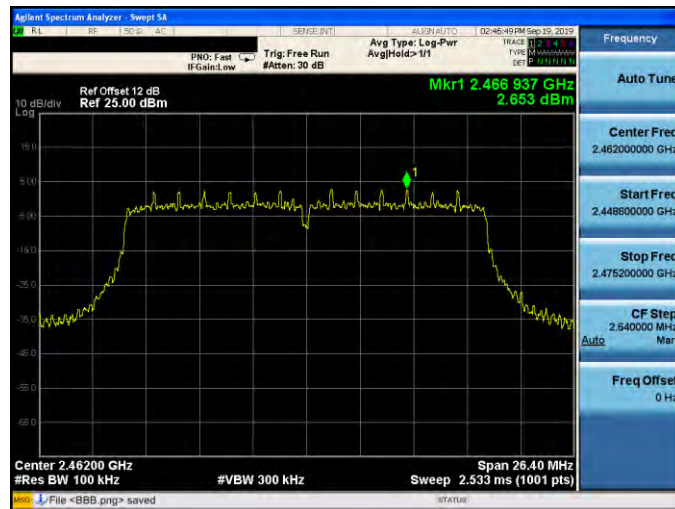



Mode 5: IEEE 802.11n 2.4 GHz 40 MHz Continuous TX mode \_ANT-0

2422 MHz

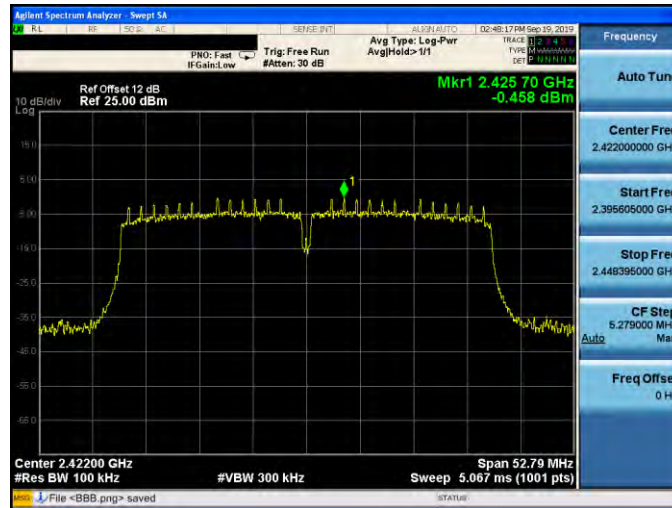

2437 MHz

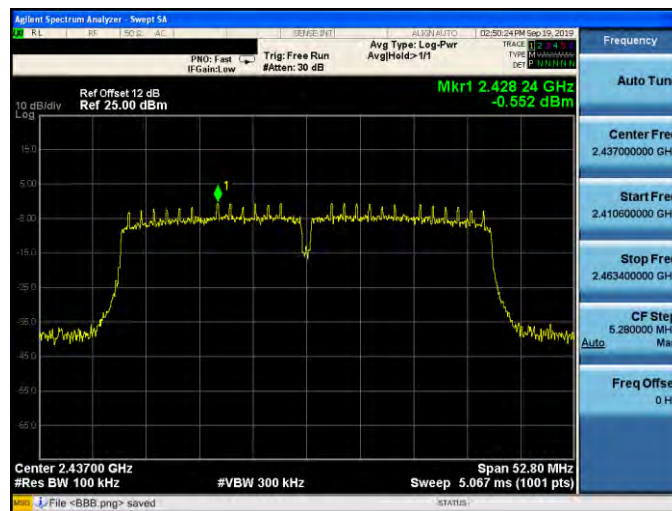

2452 MHz

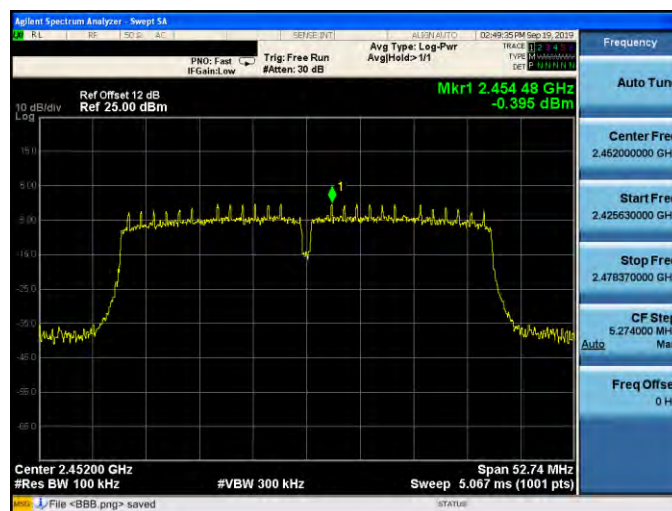



Mode 2: IEEE 802.11b Continuous TX mode\_ANT-1

2412 MHz



2437 MHz

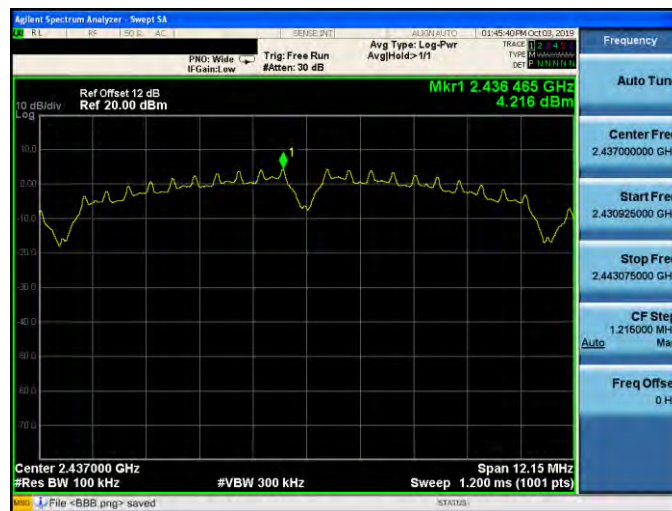

2462 MHz







Mode 3: IEEE 802.11g Continuous TX mode\_ANT-1

2412 MHz

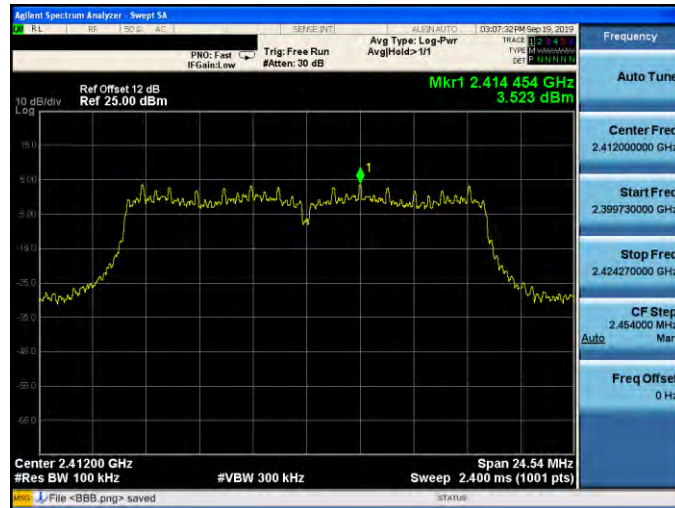

2437 MHz

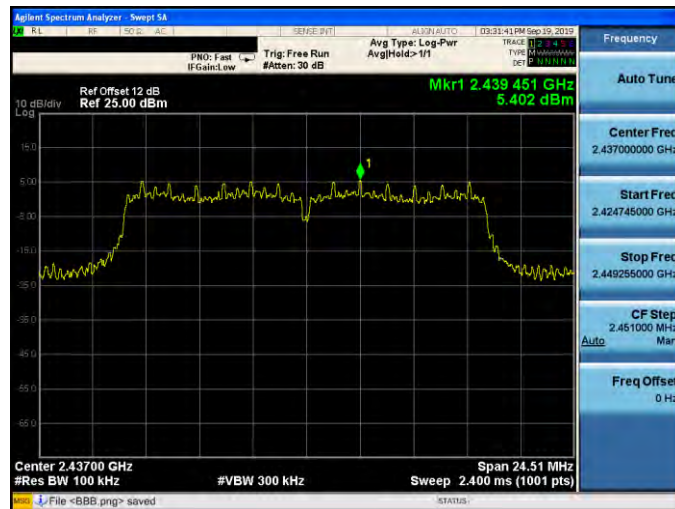

2462 MHz







Mode 4: IEEE 802.11n 2.4 GHz 20 MHz Continuous TX mode \_ANT-1

2412 MHz

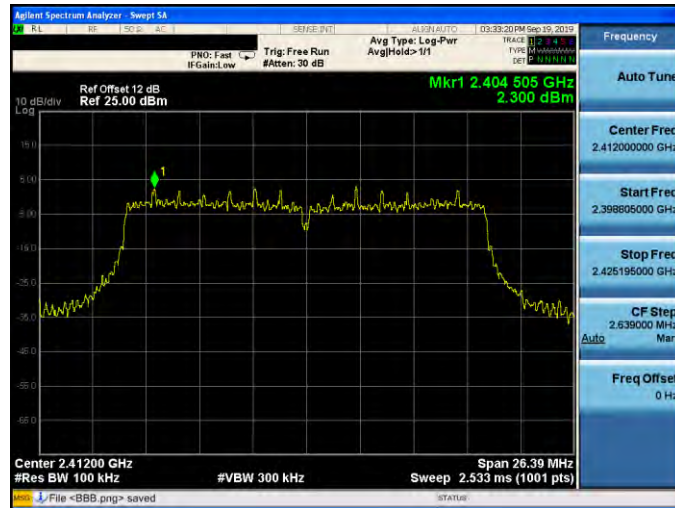

2437 MHz

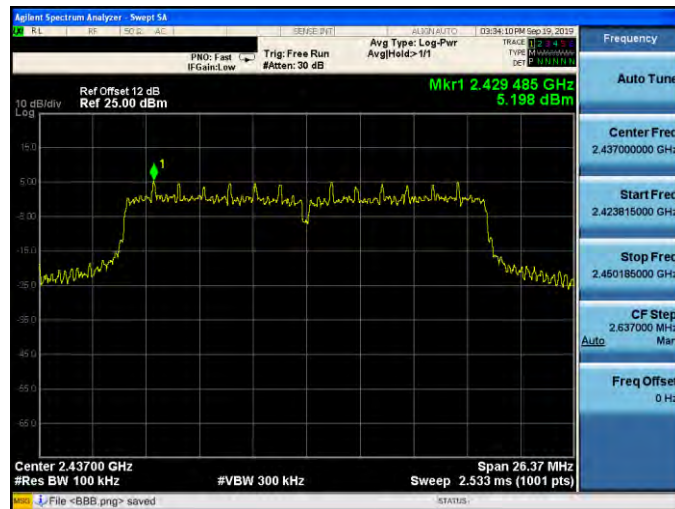

2462 MHz

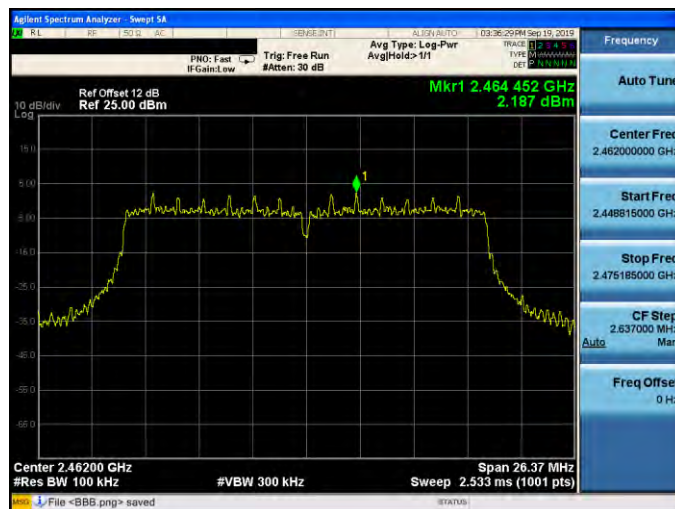



Mode 5: IEEE 802.11n 2.4 GHz 40 MHz Continuous TX mode \_ANT-1

2422 MHz

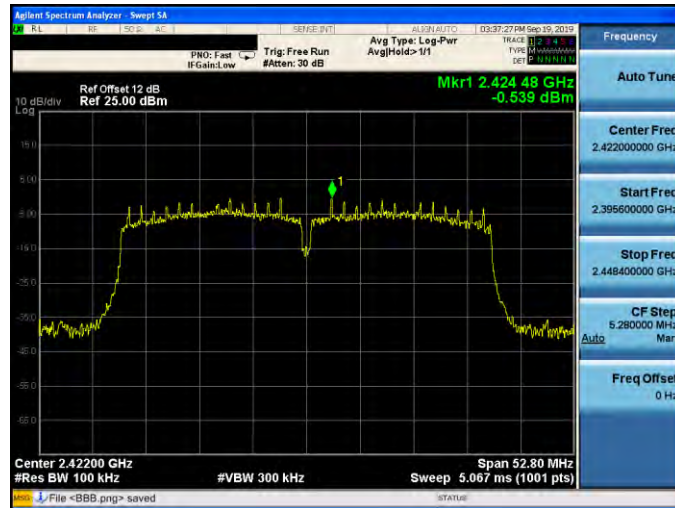

2437 MHz

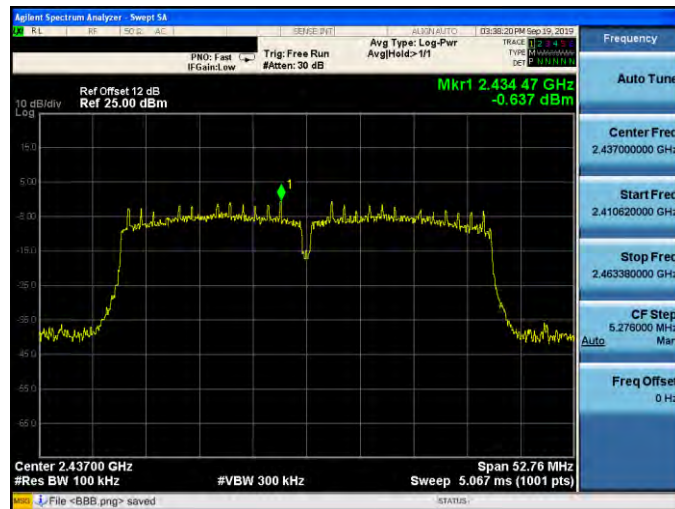

2452 MHz

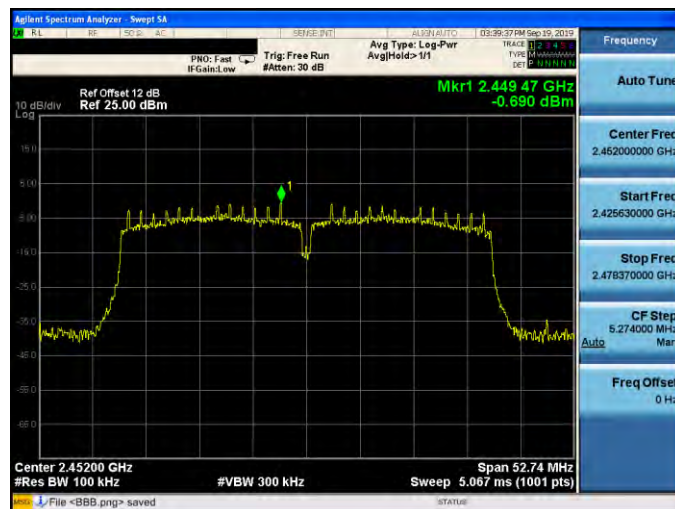



Out of Band Conducted Emissions

Mode 2: IEEE 802.11b Continuous TX mode\_ANT-0

2412 MHz

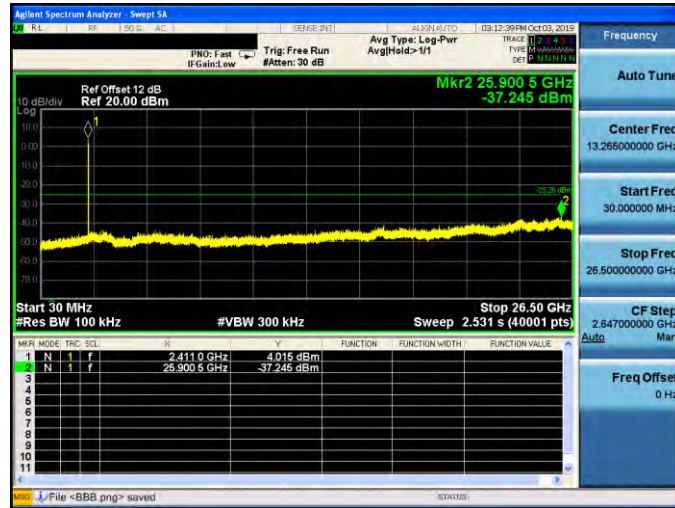

2437 MHz

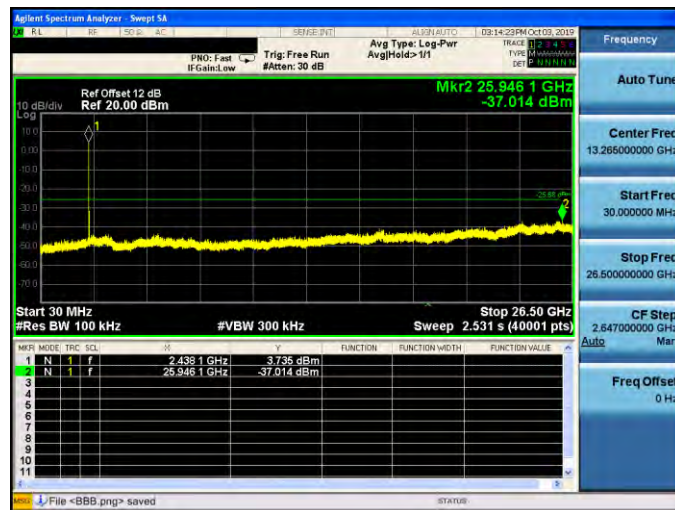

2462 MHz

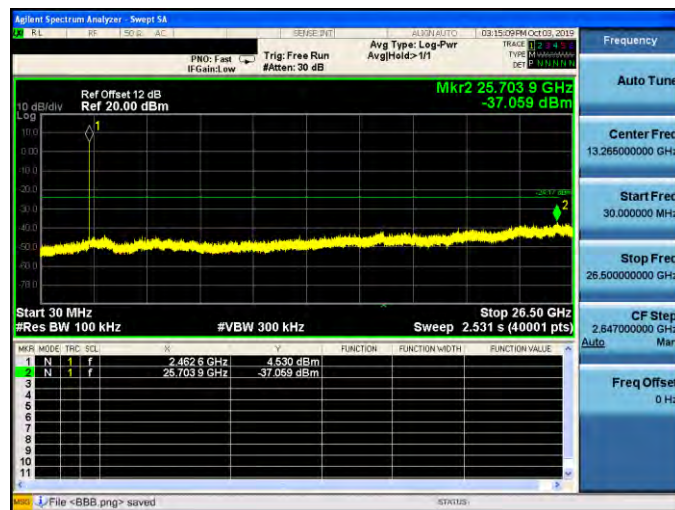





Mode 3: IEEE 802.11g Continuous TX mode\_ANT-0

2412 MHz

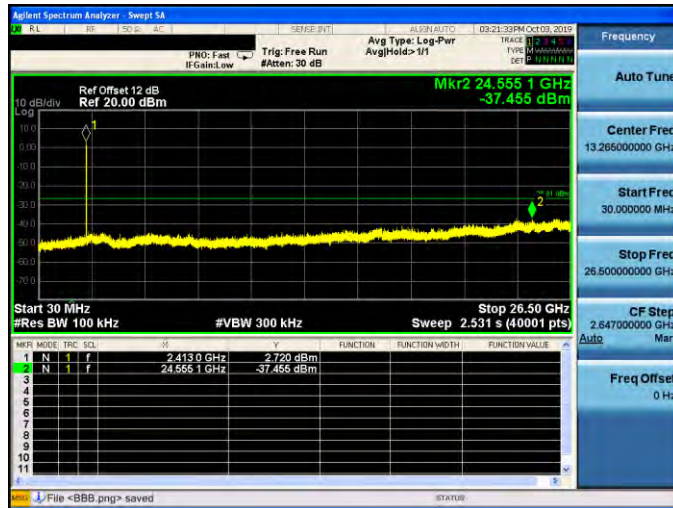

2437 MHz

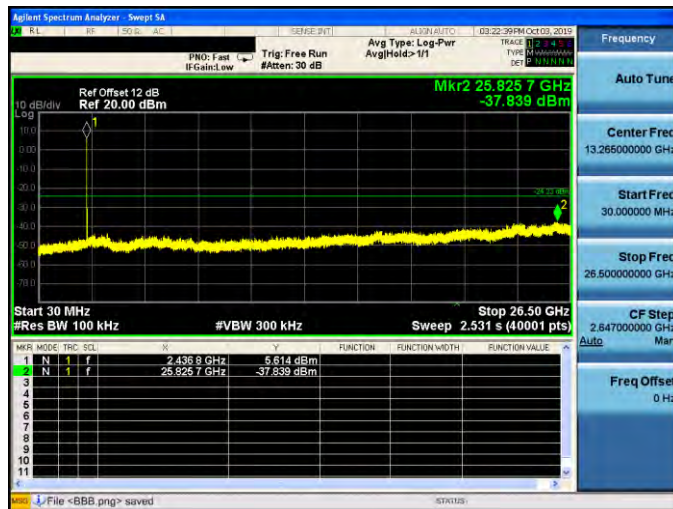

2462 MHz

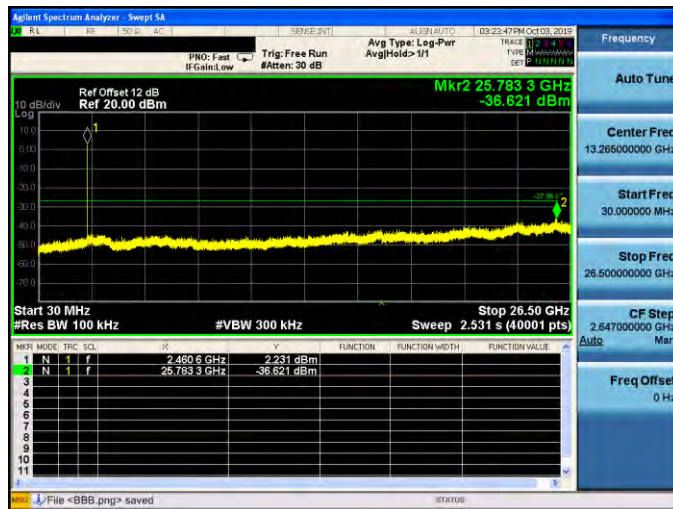



Mode 4: IEEE 802.11n 2.4 GHz 20 MHz Continuous TX mode\_ANT-0

2412 MHz

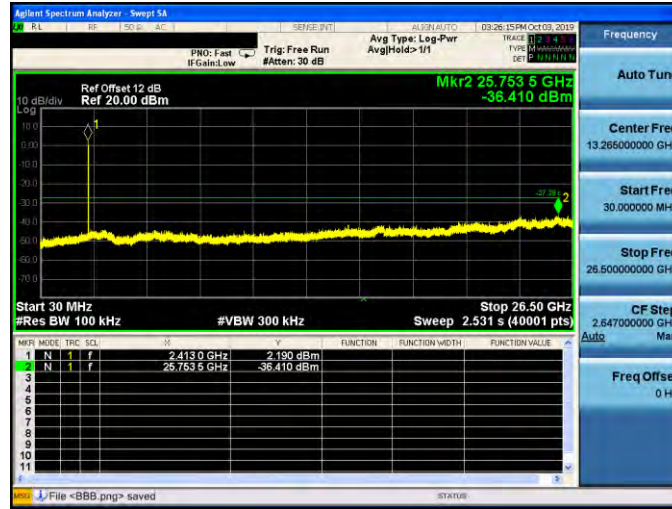

2437 MHz

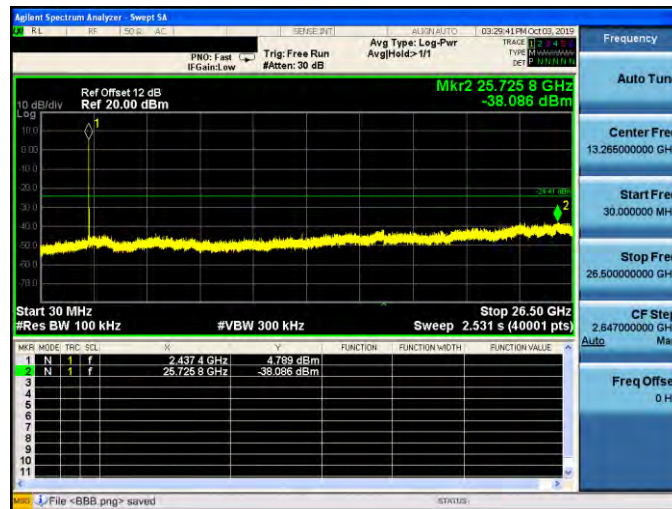

2462 MHz

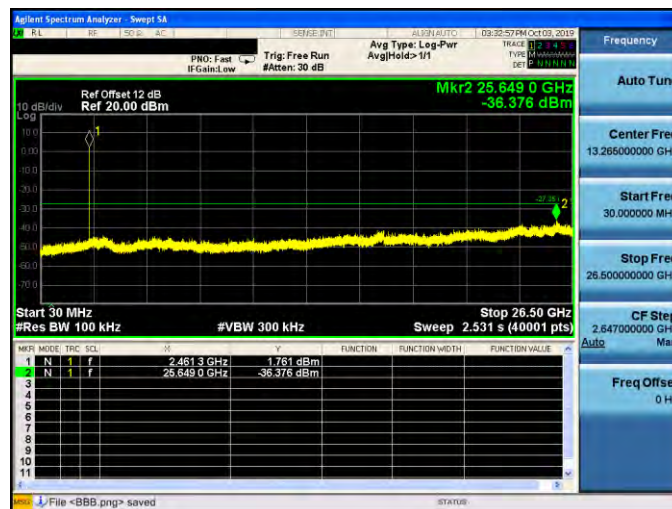



Mode 5: IEEE 802.11n 2.4 GHz 40 MHz Continuous TX mode \_ANT-0

2422 MHz

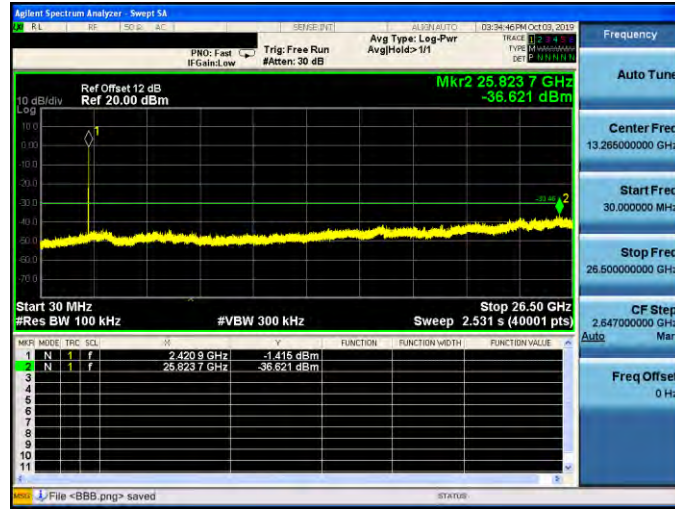

2437 MHz

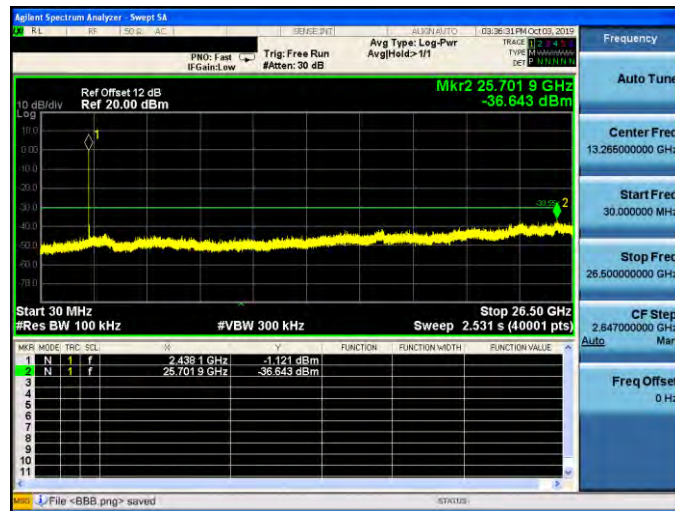

2452 MHz

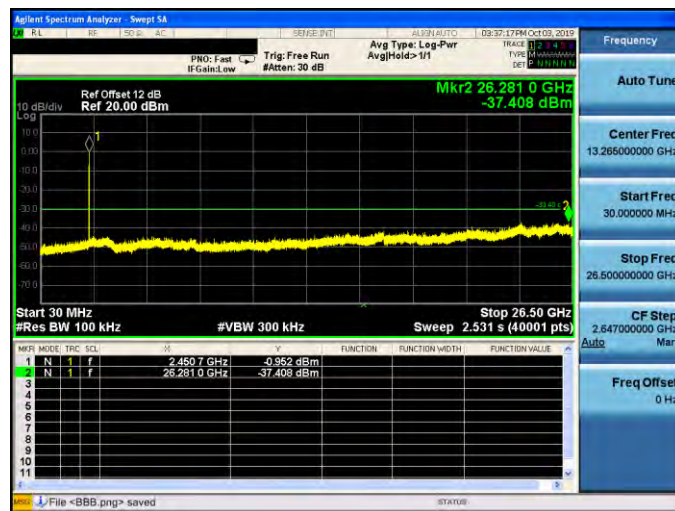





Mode 2: IEEE 802.11b Continuous TX mode\_ANT-1

2412 MHz

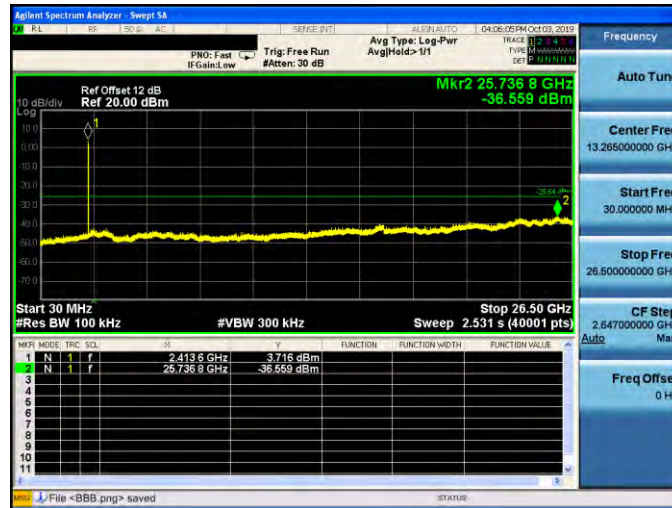

2437 MHz

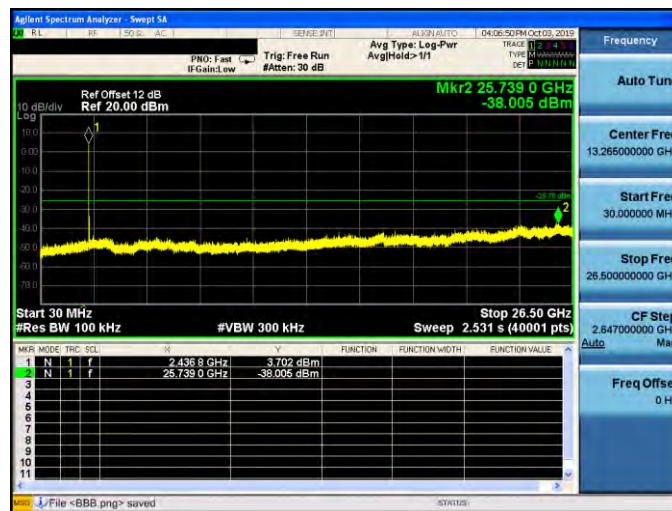

2462 MHz

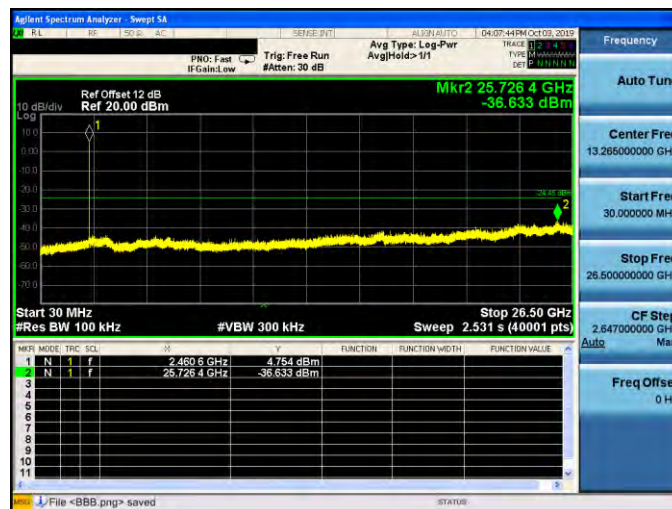



Mode 3: IEEE 802.11g Continuous TX mode\_ANT-1

2412 MHz

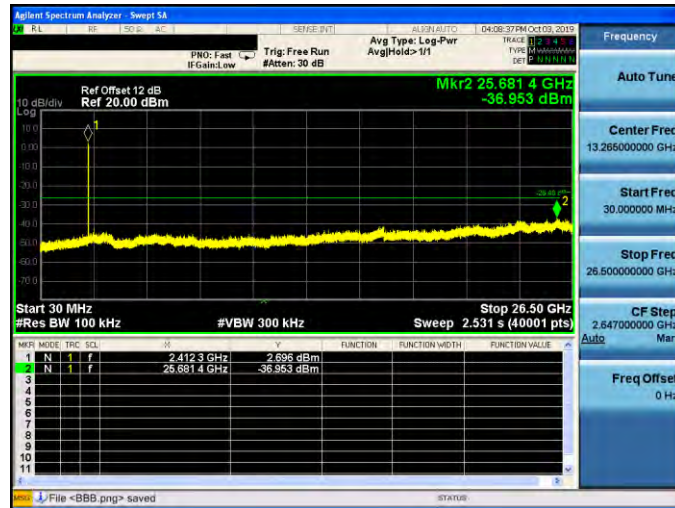

2437 MHz

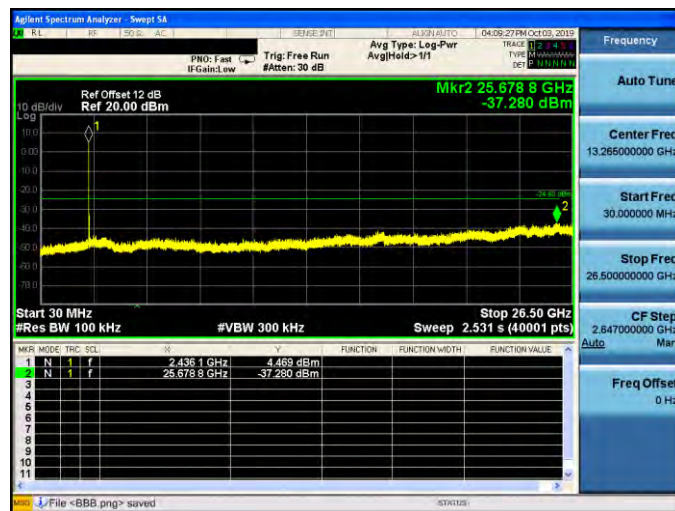

2462 MHz

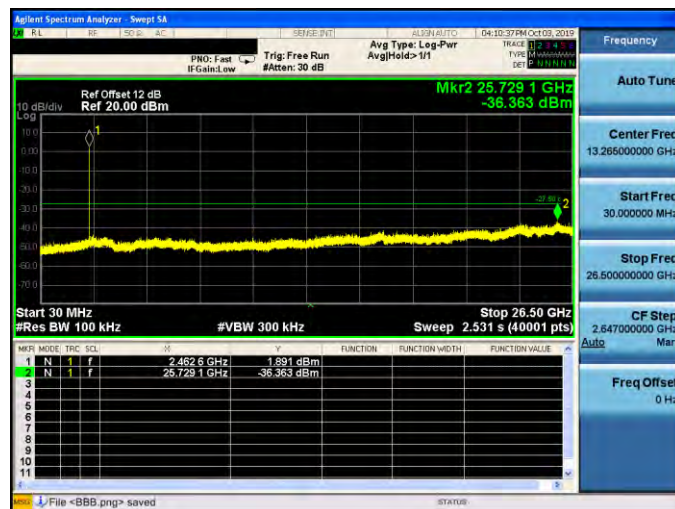





Mode 4: IEEE 802.11n 2.4 GHz 20 MHz Continuous TX mode\_ANT-1

2412 MHz

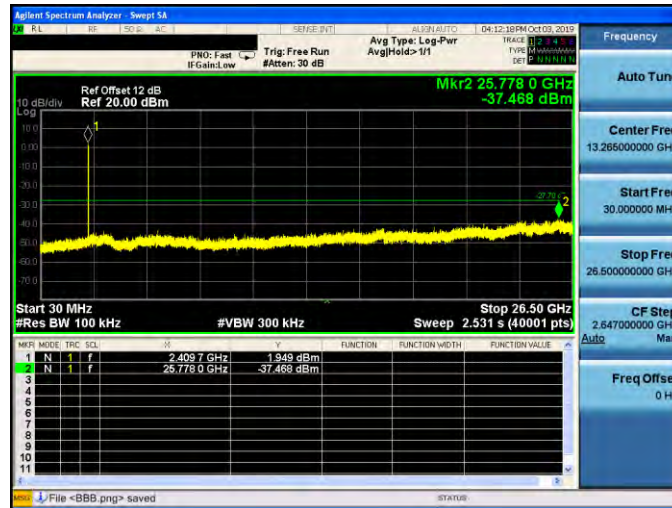

2437 MHz

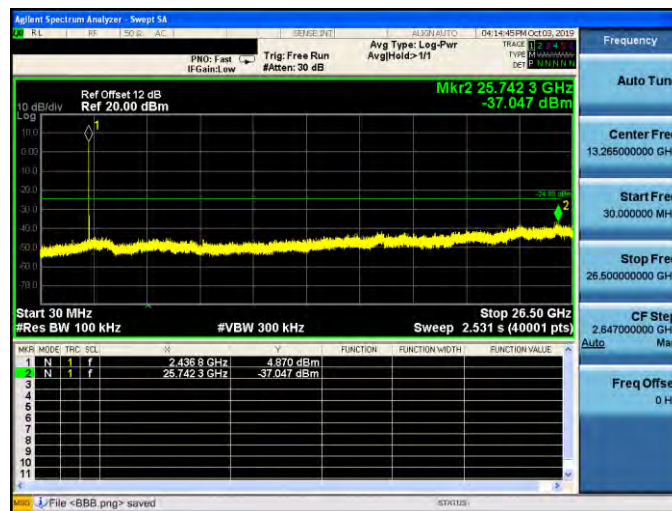

2462 MHz

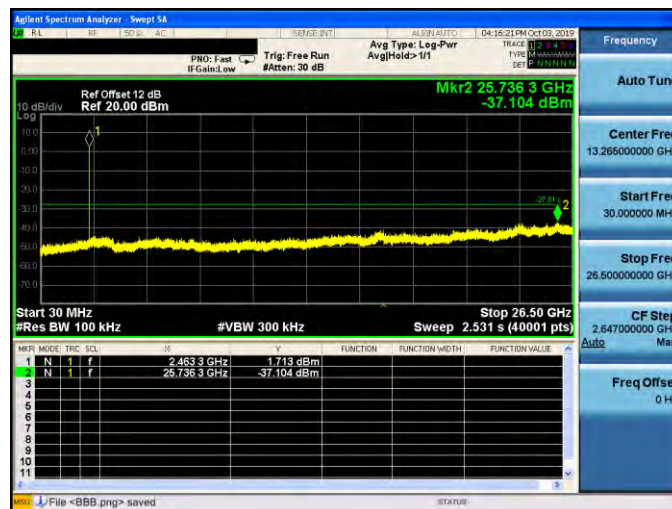



Mode 5: IEEE 802.11n 2.4 GHz 40 MHz Continuous TX mode\_ANT-1

2422 MHz

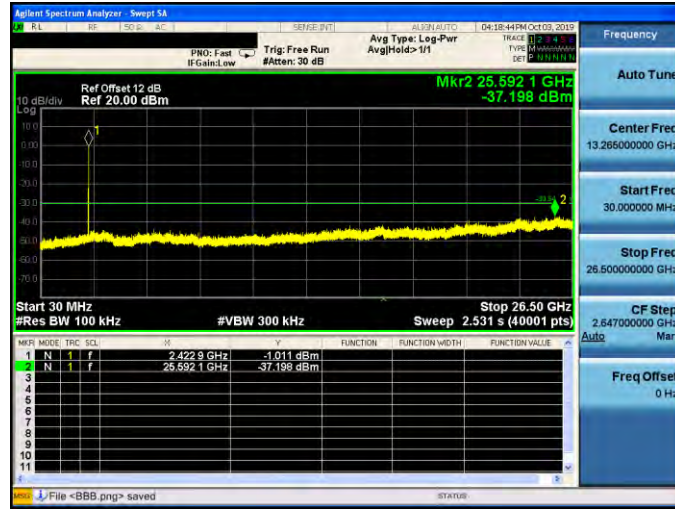

2437 MHz

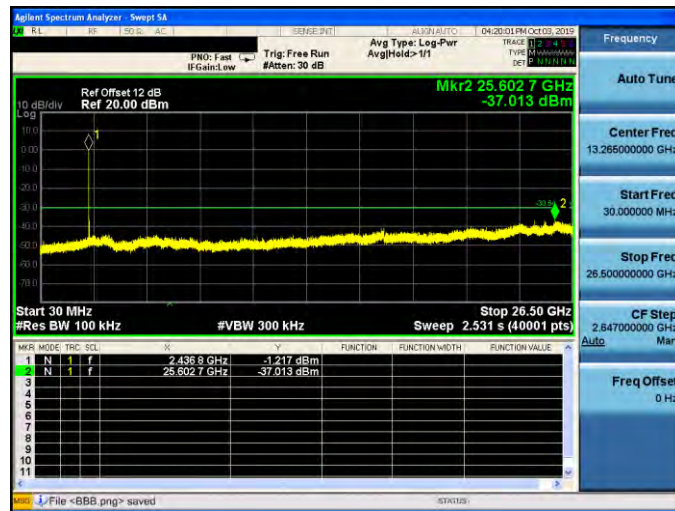

2452 MHz

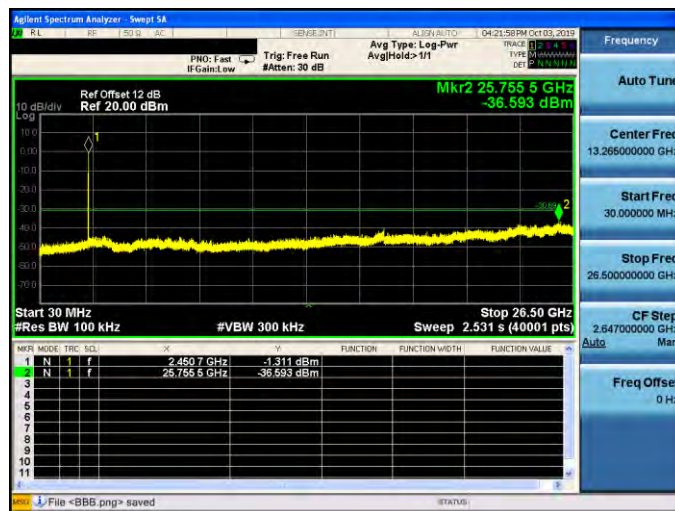

**Conducted Band Edge**

Mode 2: IEEE 802.11b Continuous TX mode\_ANT-0

2412 MHz

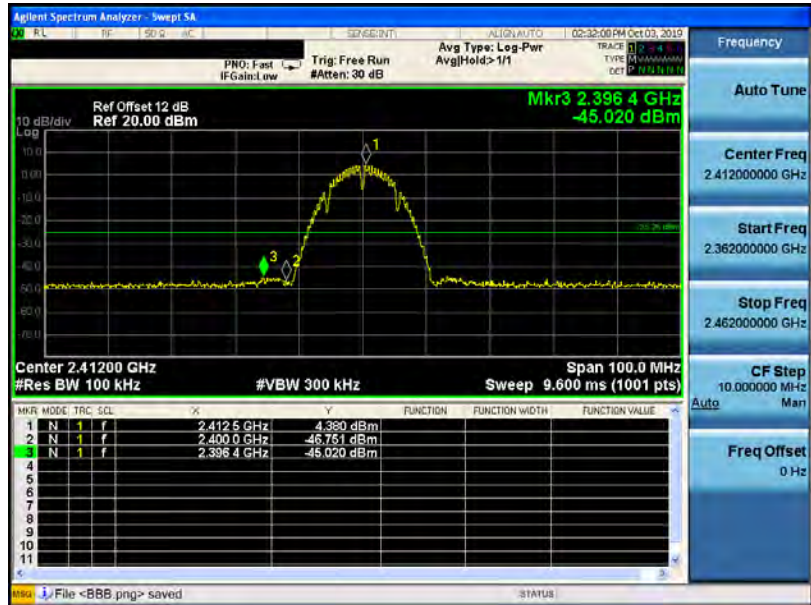

2462 MHz

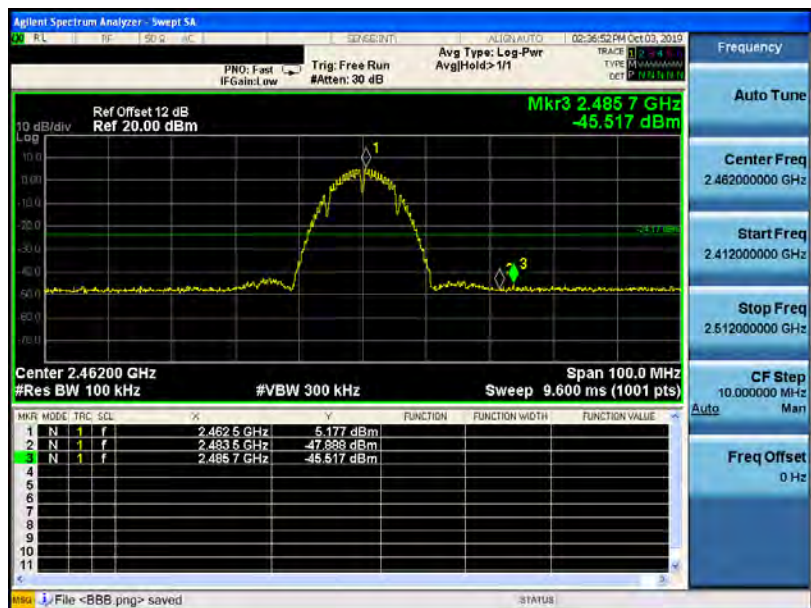





Mode 3: IEEE 802.11g Continuous TX mode\_ANT-0

2412 MHz

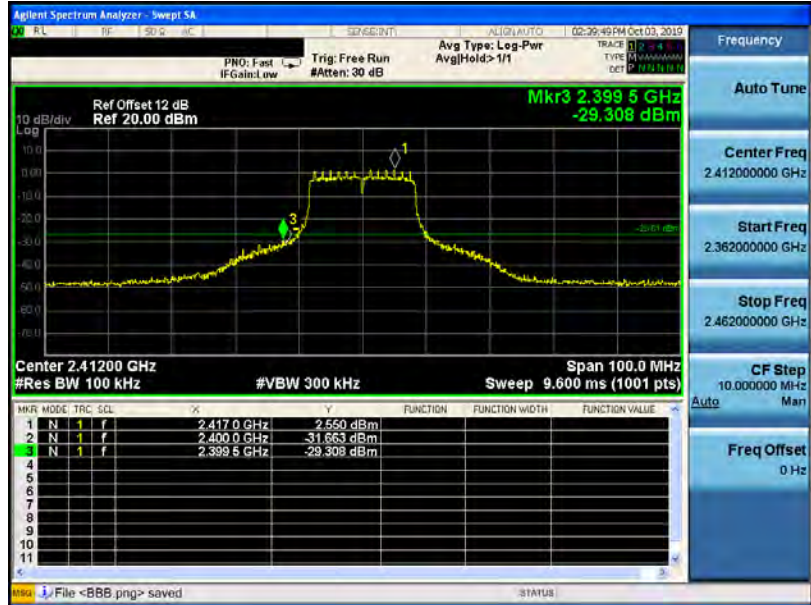

2462 MHz

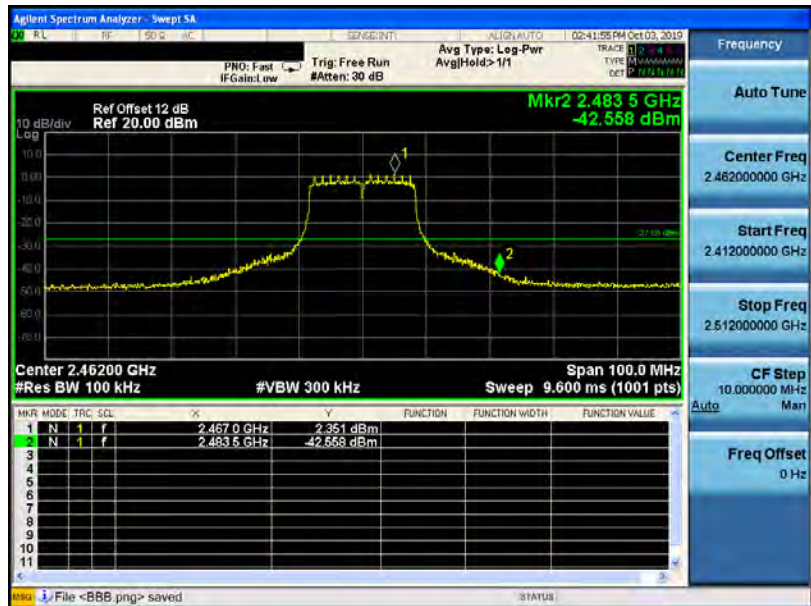



Mode 4: IEEE 802.11n 2.4 GHz 20 MHz Continuous TX mode ANT-0

2412 MHz

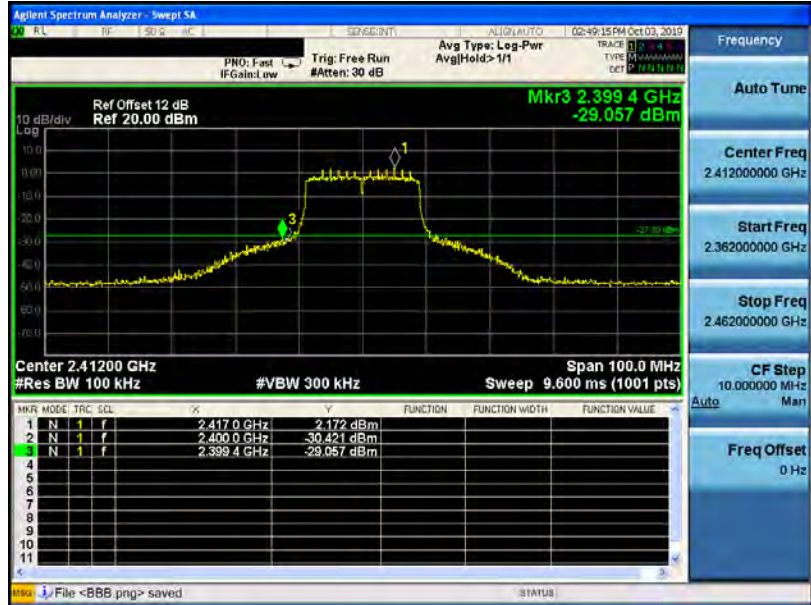

2462 MHz

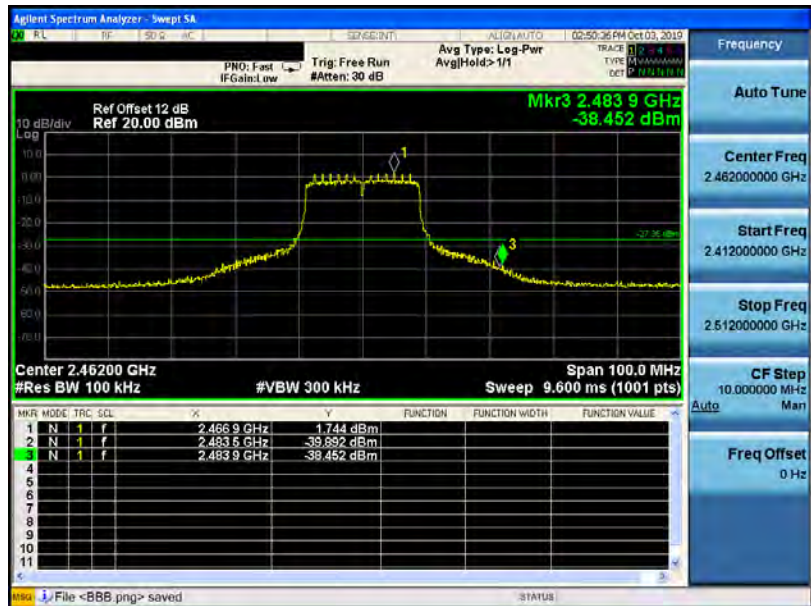



Mode 5: IEEE 802.11n 2.4 GHz 40 MHz Continuous TX mode\_ANT-0

2422 MHz



2452 MHz







Mode 2: IEEE 802.11b Continuous TX mode\_ANT-1

2412 MHz

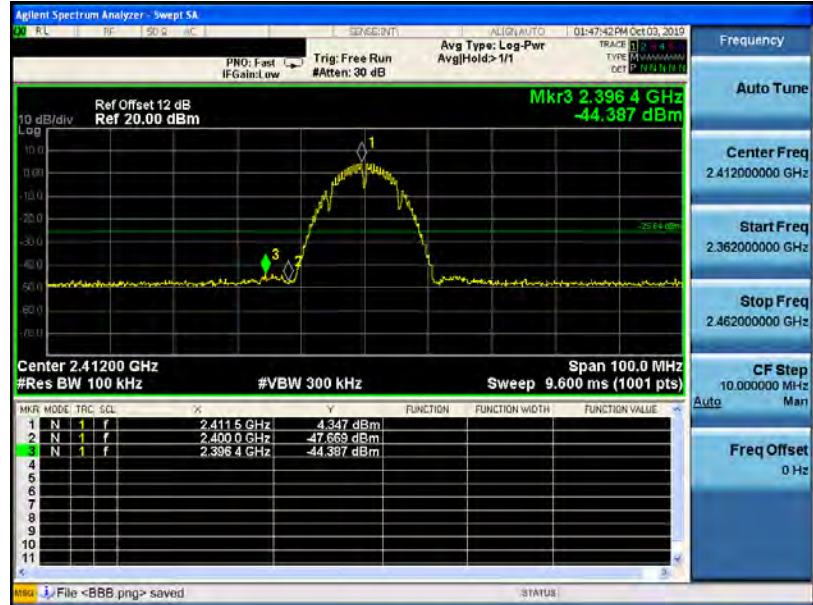

2462 MHz

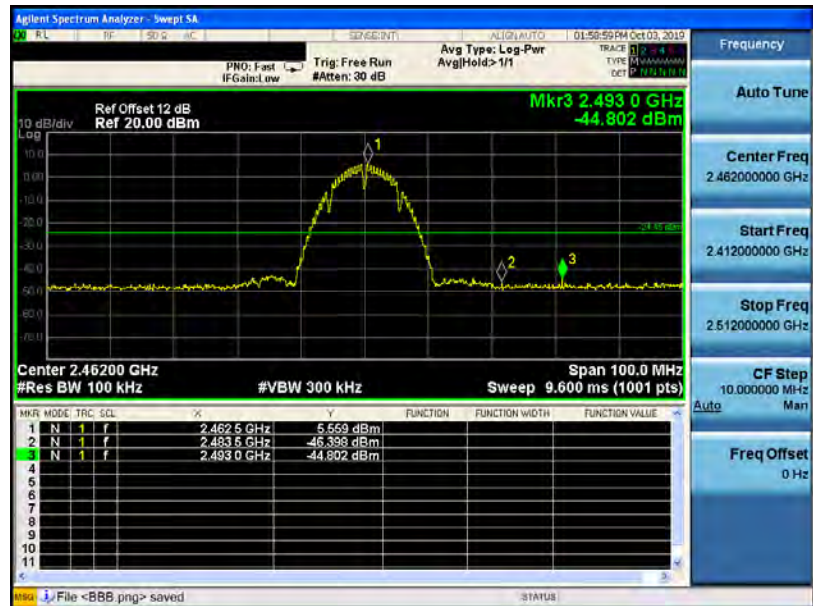





Mode 3: IEEE 802.11g Continuous TX mode\_ANT-1

2412 MHz

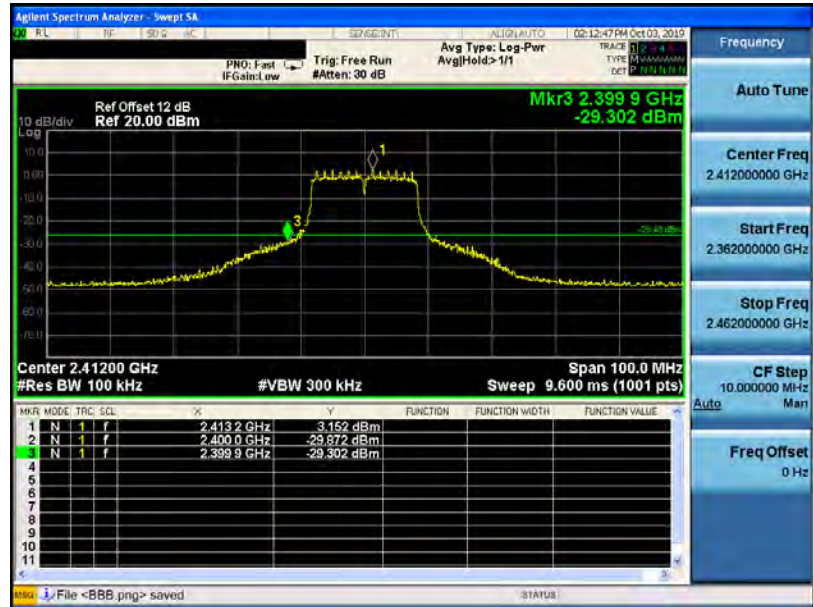

2462 MHz

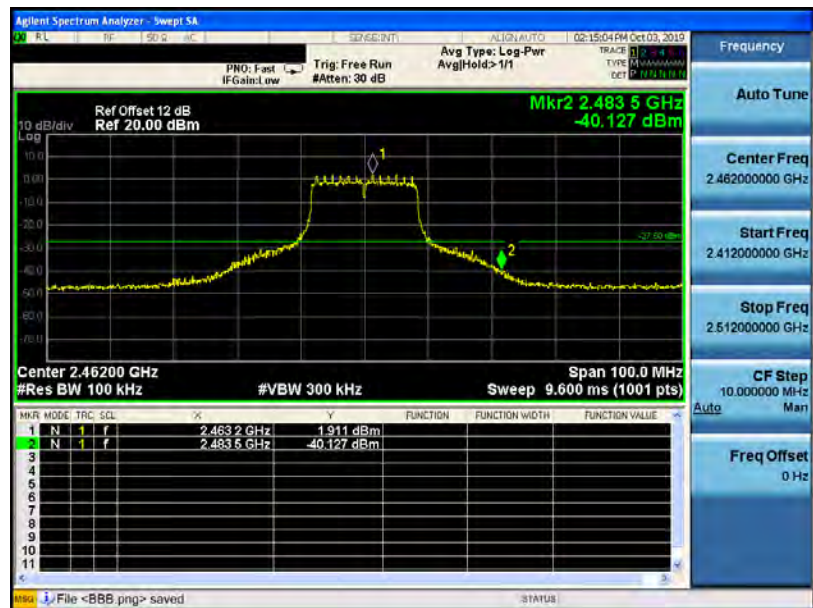

Mode 4: IEEE 802.11n 2.4 GHz 20 MHz Continuous TX mode\_ANT-1

2412 MHz



2462 MHz

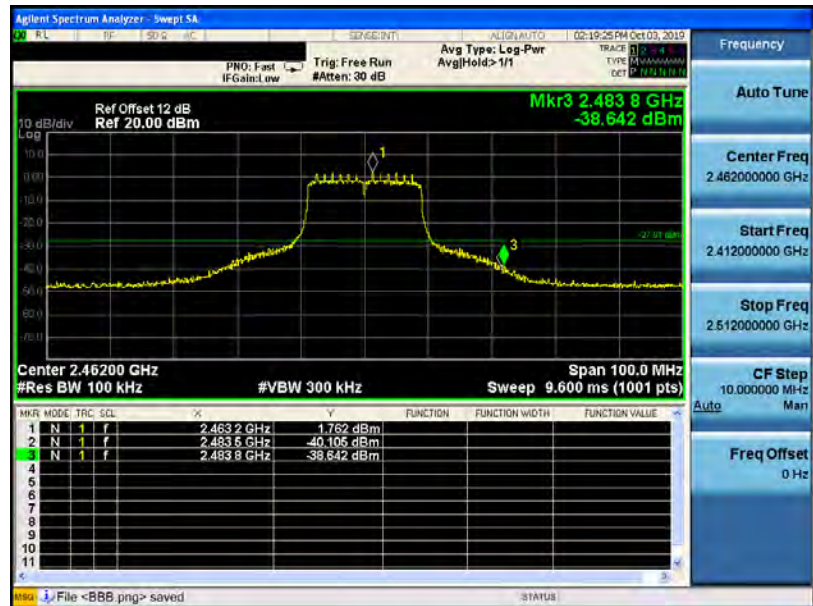

Mode 5: IEEE 802.11n 2.4 GHz 40 MHz Continuous TX mode\_ANT-1

2422 MHz



2452 MHz

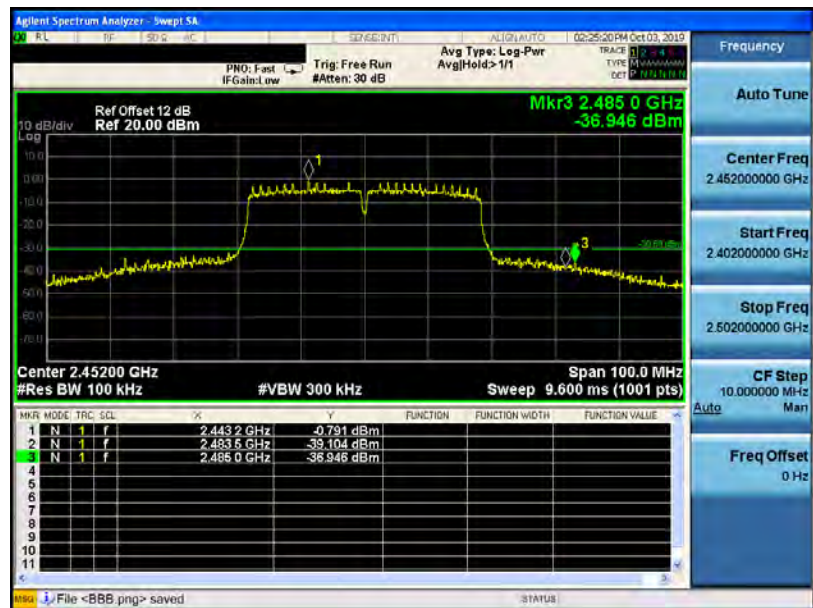



Beamforming on

Reference level

Mode 4: IEEE 802.11n 2.4 GHz 20 MHz Continuous TX mode\_ANT-0

2412 MHz	
2437 MHz	
2462 MHz	



Mode 5: IEEE 802.11n 2.4 GHz 40 MHz Continuous TX mode \_ANT-0

2422 MHz

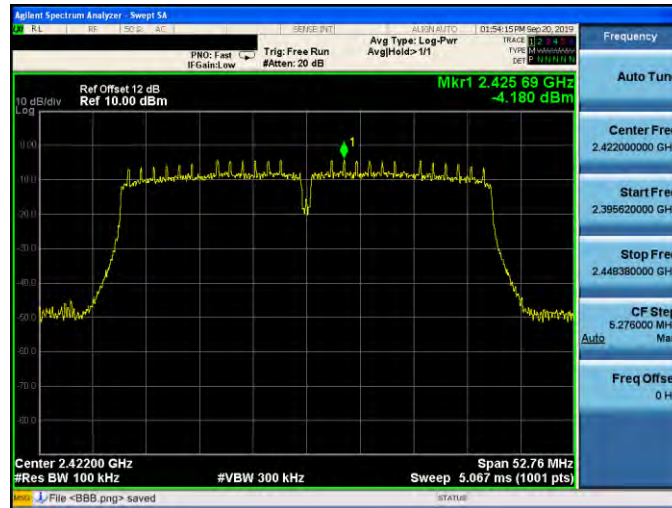

2437 MHz

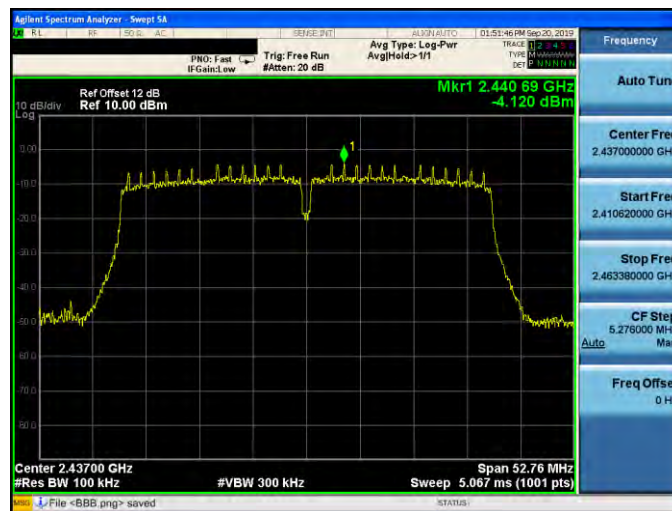

2452 MHz







Mode 4: IEEE 802.11n 2.4 GHz 20 MHz Continuous TX mode\_ANT-1

2412 MHz



2437 MHz



2462 MHz





Mode 5: IEEE 802.11n 2.4 GHz 40 MHz Continuous TX mode\_ANT-1

2422 MHz



2437 MHz



2452 MHz

