

# FCC SAR EVALUATION REPORT

**In accordance with the requirements of  
FCC 47 CFR Part 2(2.1093) and  
IEEE Std 1528-2013**

**Product Name :** Bluetooth 4.2+AC650M Nano Wireless USB Adapter

**Trademark :** N/A

**Model Name :** BL-WN650BT

**Family Model :** N/A

**Report No. :** S24102109901001

**FCC ID :** 2AL6KBL-WN650BT

**Prepared for**

Shenzhen Bilian Electronic Co.,Ltd.

Room 501, Building 3, No. 32, Dafu Road, Zhangge Community, Fucheng Street, Longhua District, Shenzhen City,China

**Prepared by**

Shenzhen NTEK Testing Technology Co., Ltd.

No. 24 Xinfu East Road, Xiangshan Community, Xinqiao Street, Baoan District, Shenzhen Guangdong, People's Republic of China

Tel. 0755-23200050 Website: <http://www.ntek.org.cn>

## TEST RESULT CERTIFICATION

**Applicant's name** ..... Shenzhen Bilian Electronic Co.,Ltd.  
**Address** ..... Room 501, Building 3, No. 32, Dafu Road, Zhangge Community, Fucheng Street, Longhua District, Shenzhen City,China

**Manufacturer's Name** ..... Shenzhen Bilian Electronic Co.,Ltd.  
**Address** ..... Room 501, Building 3, No. 32, Dafu Road, Zhangge Community, Fucheng Street, Longhua District, Shenzhen City,China

**Product description**

**Product name**..... Bluetooth 4.2+AC650M Nano Wireless USB Adapter  
**Trademark** ..... N/A  
**Model Name** ..... BL-WN650BT  
**Family Model**..... N/A

FCC 47 CFR Part 2(2.1093)

**Standards**..... IEEE Std 1528-2013

Published RF exposure KDB procedures

This device described above has been tested by Shenzhen NTEK. In accordance with the measurement methods and procedures specified in IEEE Std 1528-2013 and KDB 865664 D01. Testing has shown that this device is capable of compliance with localized specific absorption rate (SAR) specified in FCC 47 CFR Part 2(2.1093). The test results in this report apply only to the tested sample of the stated device/equipment. Other similar device/equipment will not necessarily produce the same results due to production tolerance and measurement uncertainties.

This report shall not be reproduced except in full, without the written approval of Shenzhen NTEK, this document may be altered or revised by Shenzhen NTEK, personal only, and shall be noted in the revision of the document.

**Test Sample Number** ..... S241021099001

**Date of Test**

**Date (s) of performance of tests**... Oct. 25, 2024~ Nov. 05, 2024

**Date of Issue** ..... Nov. 13, 2024

**Test Result** ..... **Pass**

Prepared By : Owen Xiao  
 Owen Xiao  
 (Project Engineer)

Reviewed By : Aaron Cheng  
 Aaron Cheng  
 (Supervisor)

Approved By : Alex Li  
 Alex Li  
 (Manager)

※ ※ Revision History ※ ※

REV.	DESCRIPTION	ISSUED DATE	REMARK
Rev.1.0	Initial Test Report Release	Oct.10, 2024	Owen Xiao

## TABLE OF CONTENTS

1. General Information .....	6
1.1. RF exposure limits.....	6
1.2. Statement of Compliance .....	7
1.3. EUT Description .....	7
1.4. Test specification(s) .....	8
1.5. Ambient Condition.....	8
2. SAR Measurement System .....	9
2.1. SATIMO SAR Measurement Set-up Diagram .....	9
2.2. Robot .....	10
2.3. E-Field Probe.....	11
2.3.1. E-Field Probe Calibration .....	11
2.4. SAM phantoms .....	12
2.4.1. Technical Data .....	13
2.5. Device Holder .....	14
2.6. Test Equipment List .....	15
3. SAR Measurement Procedures .....	17
3.1. Power Reference .....	17
3.2. Area scan & Zoom scan.....	17
3.3. Description of interpolation/extrapolation scheme .....	19
3.4. Volumetric Scan .....	19
3.5. Power Drift .....	19
4. System Verification Procedure .....	20
4.1. Tissue Verification .....	20
4.1.1. Tissue Dielectric Parameter Check Results .....	21
4.2. System Verification Procedure .....	22
4.2.1. System Verification Results.....	23
5. SAR Measurement variability and uncertainty .....	24
5.1. SAR measurement variability.....	24
5.2. SAR measurement uncertainty .....	24
6. RF Exposure Positions.....	25
6.1. Tablet PC host platform exposure conditions.....	25
7. RF Output Power .....	26
7.1. WLAN & Bluetooth Output Power .....	26
7.1.1. Output Power Results Of WLAN .....	26
7.1.2. Output Power Results Of Bluetooth.....	29
8. Stand-alone SAR test exclusion.....	29
9. SAR Results .....	30
9.1. SAR measurement results .....	30
9.1.1. SAR measurement Result of WLAN 2.4G .....	31

9.1.2.	SAR measurement Result of WLAN 5.2G .....	31
9.1.3.	SAR measurement Result of WLAN 5.3G .....	32
9.1.4.	SAR measurement Result of WLAN 5.8G .....	33
9.2.	Simultaneous Transmission Analysis.....	34
10.	Appendix A. Photo documentation .....	34
11.	Appendix B. System Check Plots .....	35
12.	Appendix C. SAR Measurement Plots .....	46
13.	Appendix D. Calibration Certificate .....	57

## 1. General Information

### 1.1. RF exposure limits

(A).Limits for Occupational/Controlled Exposure (W/kg)

Whole-Body	Partial-Body	Hands, Wrists, Feet and Ankles
0.4	8.0	20.0

(B).Limits for General Population/Uncontrolled Exposure (W/kg)

Whole-Body	Partial-Body	Hands, Wrists, Feet and Ankles
0.08	1.6	4.0

NOTE: **Whole-Body SAR** is averaged over the entire body, **partial-body SAR** is averaged over any 1 gram of tissue defined as a tissue volume in the shape of a cube. **SAR for hands, wrists, feet and ankles** is averaged over any 10 grams of tissue defined as a tissue volume in the shape of a cube.

#### **Occupational/Controlled Environments:**

Are defined as locations where there is exposure that may be incurred by people who are aware of the potential for exposure, (i.e. as a result of employment or occupation).

#### **General Population/Uncontrolled Environments:**

Are defined as locations where there is the exposure of individuals who have no knowledge or control of their exposure.

NOTE: This product is used for inlaying inside the cabinet and operating by hand

## 1.2. Statement of Compliance

The maximum results of Specific Absorption Rate (SAR) found during testing for BL-WN650BT are as follows.

Band	Max Reported SAR Value(W/kg)	
	1-g Body(Separation distance of 5mm)	1-g Hotspot (Separation distance of 5mm)
WLAN 2.4G	0.286	0.286
WLAN 5.2G	0.891	0.891
WLAN 5.3G	1.078	1.477
WLAN 5.6G	1.556	1.556
WLAN 5.8G	0.860	0.860

## 1.3. EUT Description

Device Information			
Product Name	Bluetooth 4.2+AC650M Nano Wireless USB Adapter		
Trade Name	N/A		
Model Name	BL-WN650BT		
Family Model	N/A		
Model Difference	N/A		
FCC ID	2AL6KBL-WN650BT		
Device Phase	Identical Prototype		
Exposure Category	General population / Uncontrolled environment		
Antenna Type	PIFA Antenna		
Battery Information	N/A		
Hardware version	N/A		
Software version	N/A		
Device Operating Configurations			
Supporting Mode(s)	WLAN 2.4G/5G, Bluetooth		
Test Modulation	WLAN(DSSS/OFDM), Bluetooth(GFSK, $\pi/4$ -DQPSK, 8DPSK)		
Device Class	B		
Operating Frequency Range(s)	Band	Tx (MHz)	Rx (MHz)
	WLAN 2.4G	2412-2462	
	WLAN 5.2G	5180-5240	
	WLAN 5.3G	5260-5320	
	WLAN 5.6G	5500-5700	
	WLAN 5.8G	5745-5825	
	Bluetooth	2402-2480	

**1.4. Test specification(s)**

FCC 47 CFR Part 2(2.1093)
IEEE Std 1528-2013
KDB 865664 D01 SAR measurement 100 MHz to 6 GHz v01r04
KDB 865664 D02 RF Exposure Reporting v01r02
KDB 447498 D01 General RF Exposure Guidance v06
KDB 447498 D02 SAR Procedures for Dongle Xmtr v02r01
KDB 248227 D01 802.11 Wi-Fi SAR v02r02;

**1.5. Ambient Condition**

Ambient temperature	20°C – 24°C
Relative Humidity	30% – 70%



## 2. SAR Measurement System

### 2.1. SATIMO SAR Measurement Set-up Diagram

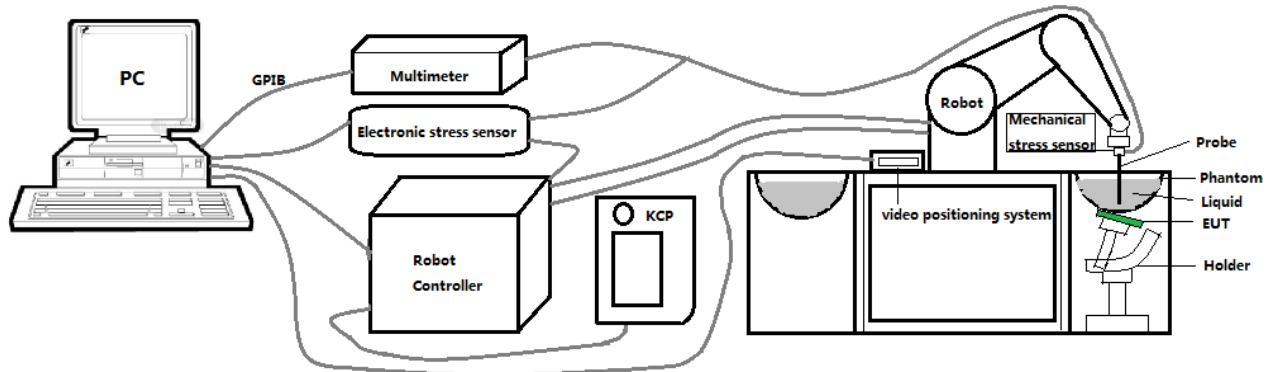

These measurements were performed with the automated near-field scanning system OPENSAR from SATIMO. The system is based on a high precision robot (working range: 901 mm), which positions the probes with a positional repeatability of better than  $\pm 0.03$  mm. The SAR measurements were conducted with dosimetric probe (manufactured by SATIMO), designed in the classical triangular configuration and optimized for dosimetric evaluation.

The first step of the field measurement is the evaluation of the voltages induced on the probe by the device under test. Probe diode detectors are nonlinear. Below the diode compression point, the output voltage is proportional to the square of the applied E-field; above the diode compression point, it is linear to the applied E-field. The compression point depends on the diode, and a calibration procedure is necessary for each sensor of the probe.

The Keithley multimeter reads the voltage of each sensor and send these three values to the PC. The corresponding E field value is calculated using the probe calibration factors, which are stored in the working directory. This evaluation includes linearization of the diode characteristics. The field calculation is done separately for each sensor. Each component of the E field is displayed on the "Dipole Area Scan Interface" and the total E field is displayed on the "3D Interface"

## 2.2. Robot

The SATIMO SAR system uses the high precision robots from KUKA. For the 6-axis controller system, the robot controller version (KUKA) from KUKA is used. The KUKA robot series have many features that are important for our application:



- High precision (repeatability  $\pm 0.03$  mm)
- High reliability (industrial design)
- Jerk-free straight movements
- Low ELF interference (the closed metallic construction shields against motor control fields)

### 2.3. E-Field Probe

This E-field detection probe is composed of three orthogonal dipoles linked to special Schottky diodes with low detection thresholds. The probe allows the measurement of electric fields in liquids such as the one defined in the IEEE and CENELEC standards.

For the measurements the Specific Dosimetric E-Field Probe 3423-EPGO-426 with following specifications is used



- Dynamic range: 0.01-100 W/kg
- Tip Diameter : 2.5 mm
- Distance between probe tip and sensor center: 1 mm
- Distance between sensor center and the inner phantom surface: 2 mm (repeatability better than  $\pm 1$  mm).
- Probe linearity:  $\pm 0.06$  dB
- Axial isotropy:  $\pm 0.01$  dB
- Hemispherical Isotropy:  $\pm 0.01$  dB
- Calibration range: 650MHz to 5900MHz for head & body simulating liquid.
- Lower detection limit: 8mW/kg

Angle between probe axis (evaluation axis) and surface normal line: less than  $30^\circ$ .

#### 2.3.1. E-Field Probe Calibration

Each probe needs to be calibrated according to a dosimetric assessment procedure with accuracy better than  $\pm 10\%$ . The spherical isotropy shall be evaluated and within  $\pm 0.25$ dB. The sensitivity parameters (Norm X, Norm Y, and Norm Z), the diode compression parameter (DCP) and the conversion factor (Conv F) of the probe are tested. The calibration data can be referred to appendix D of this report.

## 2.4. SAM phantoms

Photo of SAM phantom SN 16/15 SAM119



The SAM phantom is used to measure the SAR relative to people exposed to electro-magnetic field radiated by mobile phones.

**2.4.1. Technical Data**

Serial Number	Shell thickness	Filling volume	Dimensions	Positionner Material	Permittivity	Loss Tangent
<b>SN 16/15 SAM119</b>	2 mm ±0.2 mm	27 liters	Length:1000 mm Width:500 mm Height:200 mm	Gelcoat with fiberglass	3.4	0.02

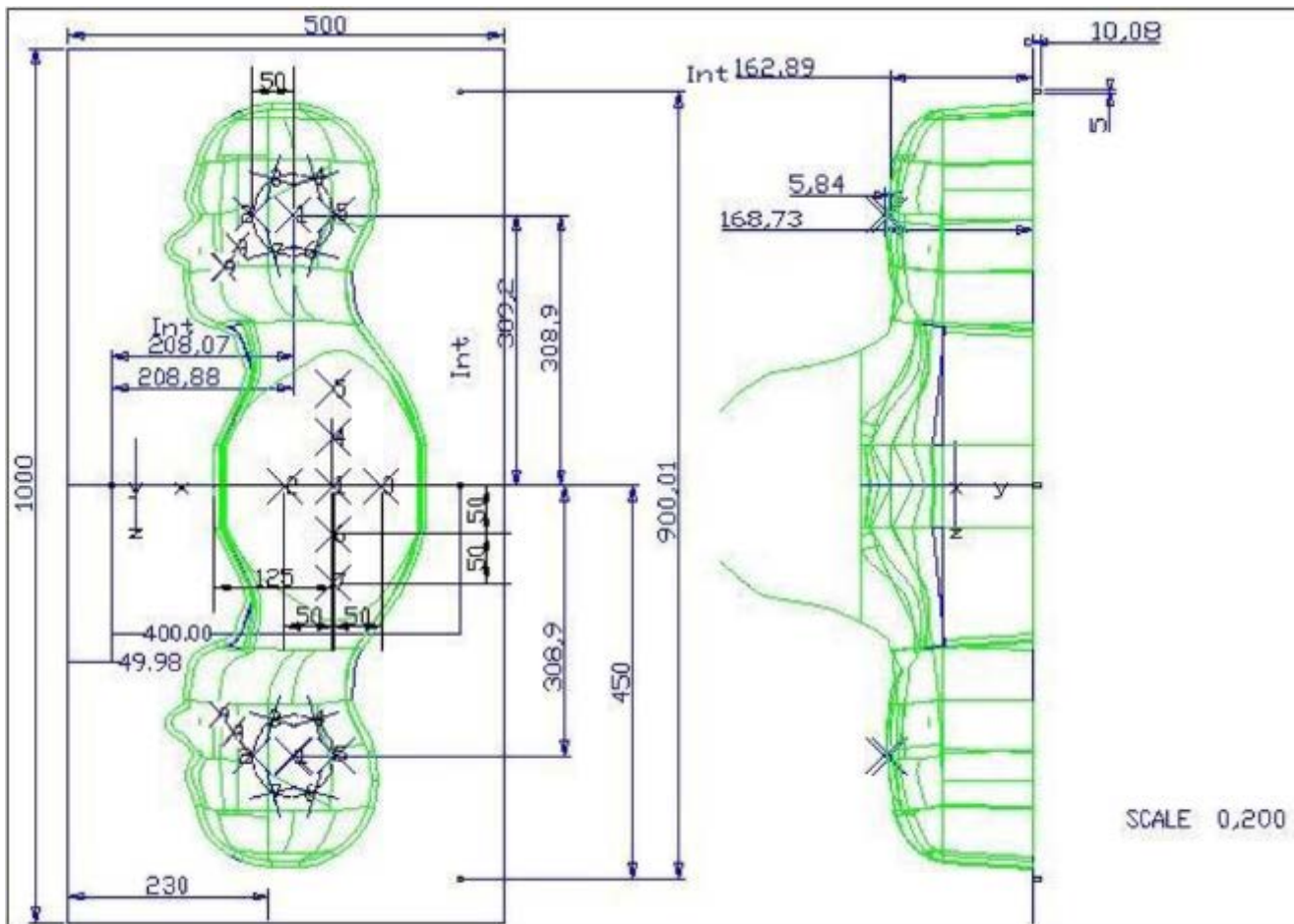

Serial Number	Left Head(mm)		Right Head(mm)		Flat Part(mm)	
	1	2	1	2	1	2
<b>SN 16/15 SAM119</b>	2	2.02	2	2.08	1	2.09
	3	2.05	3	2.06	2	2.06
	4	2.07	4	2.07	3	2.08
	5	2.08	5	2.08	4	2.10
	6	2.05	6	2.07	5	2.10
	7	2.05	7	2.05	6	2.07
	8	2.07	8	2.06	7	2.07
	9	2.08	9	2.06	-	-

The test, based on ultrasonic system, allows measuring the thickness with an accuracy of 10 µm.

## 2.5. Device Holder

The positioning system allows obtaining cheek and tilting position with a very good accuracy. In compliance with CENELEC, the tilt angle uncertainty is lower than 1 degree.

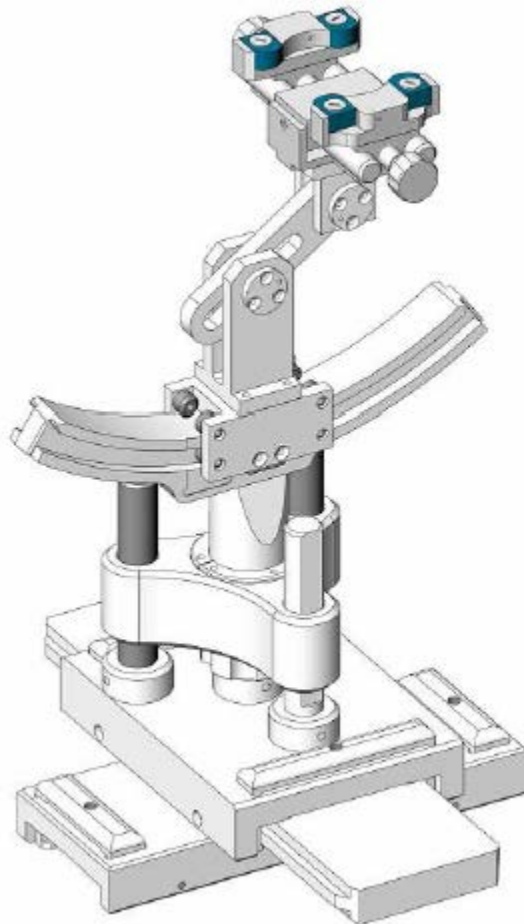

Serial Number	Holder Material	Permittivity	Loss Tangent
SN 16/15 MSH100	Delrin	3.7	0.005

## 2.6. Test Equipment List

This table gives a complete overview of the SAR measurement equipment.

Devices used during the test described are marked

	Manufacturer	Name of Equipment	Type/Model	Serial Number	Calibration	
					Last Cal.	Due Date
<input checked="" type="checkbox"/>	MVG	E FIELD PROBE	SSE2	4024-EPGO-442	Oct.4.2024	Oct.3.2025
<input type="checkbox"/>	MVG	750 MHz Dipole	SID750	SN 03/15 DIP 0G750-355	Feb. 21, 2024	Feb. 20, 2027
<input type="checkbox"/>	MVG	835 MHz Dipole	SID835	SN 03/15 DIP 0G835-347	Feb. 21, 2024	Feb. 20, 2027
<input type="checkbox"/>	MVG	900 MHz Dipole	SID900	SN 03/15 DIP 0G900-348	Feb. 21, 2024	Feb. 20, 2027
<input type="checkbox"/>	MVG	1800 MHz Dipole	SID1800	SN 03/15 DIP 1G800-349	Feb. 21, 2024	Feb. 20, 2027
<input type="checkbox"/>	MVG	1900 MHz Dipole	SID1900	SN 03/15 DIP 1G900-350	Feb. 21, 2024	Feb. 20, 2027
<input type="checkbox"/>	MVG	2000 MHz Dipole	SID2000	SN 03/15 DIP 2G000-351	Feb. 21, 2024	Feb. 20, 2027
<input type="checkbox"/>	MVG	2300 MHz Dipole	SID2300	SN 03/16 DIP 2G300-358	Feb. 21, 2024	Feb. 20, 2027
<input checked="" type="checkbox"/>	MVG	2450 MHz Dipole	SID2450	SN 03/15 DIP 2G450-352	Feb. 21, 2024	Feb. 20, 2027
<input type="checkbox"/>	MVG	2600 MHz Dipole	SID2600	SN 03/15 DIP 2G600-356	Feb. 21, 2024	Feb. 20, 2027
<input checked="" type="checkbox"/>	MVG	5000 MHz Dipole	SWG5500	SN 13/14 WGA 33	Feb. 21, 2024	Feb. 20, 2027
<input checked="" type="checkbox"/>	MVG	Liquid measurement Kit	SCLMP	SN 21/15 OCPG 72	NCR	NCR
<input checked="" type="checkbox"/>	MVG	Power Amplifier	N.A	AMPLISAR_28/14_003	NCR	NCR
<input checked="" type="checkbox"/>	KEITHLEY	Millivoltmeter	2000	4072790	NCR	NCR
<input type="checkbox"/>	R&S	Universal radio communication tester	CMU200	117858	Apr. 26, 2024	Apr. 25, 2025
<input type="checkbox"/>	R&S	Wideband radio communication	CMW500	103917	Apr. 26, 2024	Apr. 25, 2025

		tester				
<input checked="" type="checkbox"/>	HP	Network Analyzer	8753D	3410J01136	Apr. 26, 2024	Apr. 25, 2025
<input checked="" type="checkbox"/>	Agilent	MXG Vector Signal Generator	N5182A	MY47070317	Apr. 25, 2024	Apr. 24, 2025
<input checked="" type="checkbox"/>	Agilent	Power meter	E4419B	MY45102538	Apr. 25, 2024	Apr. 24, 2025
<input checked="" type="checkbox"/>	Agilent	Power sensor	E9301A	MY41495644	Apr. 25, 2024	Apr. 24, 2025
<input checked="" type="checkbox"/>	Agilent	Power sensor	E9301A	US39212148	Apr. 25, 2024	Apr. 24, 2025
<input checked="" type="checkbox"/>	MCLI/USA	Directional Coupler	CB11-20	0D2L51502	Jul. 04, 2023	Jul. 03, 2024
<input checked="" type="checkbox"/>	N/A	Thermometer	N/A	LES-085	Mar. 27, 2023	Mar. 26, 2026
<input checked="" type="checkbox"/>	MVG	SAM Phantom	SSM2	SN 16/15 SAM119	NCR	NCR
<input checked="" type="checkbox"/>	MVG	Device Holder	SMPPD	SN 16/15 MSH100	NCR	NCR

Measurement Software

Manufacturer	Software Name	Software Version
SATIMO	OpenSAR	V4_02_31



### 3. SAR Measurement Procedures

The measurement procedures are as follows:

<Conducted power measurement>

- (a) For WWAN power measurement, use base station simulator to configure EUT WWAN transmission in conducted connection with RF cable, at maximum power in each supported wireless interface and frequency band.
- (b) Read the WWAN RF power level from the base station simulator.
- (c) For WLAN/Bluetooth power measurement, use engineering software to configure EUT WLAN/Bluetooth continuously transmission, at maximum RF power in each supported wireless interface and frequency band.
- (d) Connect EUT RF port through RF cable to the power meter, and measure WLAN/Bluetooth output power.

<SAR measurement>

- (a) Use base station simulator to configure EUT WWAN transmission in radiated connection, and engineering software to configure EUT WLAN/Bluetooth continuously transmission, at maximum RF power, in the highest power channel.
- (b) Place the EUT in the positions as Appendix A demonstrates.
- (c) Set scan area, grid size and other setting on the OPENSAR software.
- (d) Measure SAR results for the highest power channel on each testing position.
- (e) Find out the largest SAR result on these testing positions of each band.
- (f) Measure SAR results for other channels in worst SAR testing position if the reported SAR of highest power channel is larger than 0.8 W/kg.

According to the test standard, the recommended procedure for assessing the peak spatial-average SAR value consists of the following steps:

- (a) Power reference measurement
- (b) Area scan
- (c) Zoom scan
- (d) Power drift measurement

#### 3.1. Power Reference

The Power Reference Measurement and Power Drift Measurements are for monitoring the power drift of the device under test in the batch process. The minimum distance of probe sensors to surface determines the closest measurement point to phantom surface. This distance cannot be smaller than the distance of sensor calibration points to probe tip as defined in the probe properties.

#### 3.2. Area scan & Zoom scan

The area scan is a 2D scan to find the hot spot location on the DUT. The zoom scan is a 3D scan above the hot spot to calculate the 1g and 10g SAR value.

Measurement of the SAR distribution with a grid of 8 to 16 mm \* 8 to 16 mm and a constant distance to the inner surface of the phantom. Since the sensors cannot directly measure at the inner phantom surface, the values between the sensors and the inner phantom surface are extrapolated. With these values the area of the maximum SAR is calculated by an interpolation scheme. Around this point, a cube of 30 \* 30 \* 30 mm or 32 \* 32 \* 32 mm is assessed by measuring 5 or 8 \* 5 or 8 \* 4 or 5 mm. With these data, the peak spatial-average SAR value can be calculated.

From the scanned SAR distribution, identify the position of the maximum SAR value, in addition identify the positions of any local maxima with SAR values within 2 dB of the maximum value that will not be within the zoom scan of other peaks; additional peaks shall be measured only when the primary peak is within 2 dB of the SAR compliance limit (e.g., 1 W/kg for 1,6 W/kg 1 g limit, or 1,26 W/kg for 2 W/kg, 10 g limit).

Area scan & Zoom scan scan parameters extracted from FCC KDB 865664 D01 SAR measurement 100 MHz to 6 GHz.

		≤ 3 GHz	> 3 GHz	
Maximum distance from closest measurement point (geometric center of probe sensors) to phantom surface		5 ± 1 mm	½·δ·ln(2) ± 0.5 mm	
Maximum probe angle from probe axis to phantom surface normal at the measurement location		30° ± 1°	20° ± 1°	
Maximum area scan spatial resolution: Δx <sub>Area</sub> , Δy <sub>Area</sub>		≤ 2 GHz: ≤ 15 mm 2 – 3 GHz: ≤ 12 mm	3 – 4 GHz: ≤ 12 mm 4 – 6 GHz: ≤ 10 mm	
		When the x or y dimension of the test device, in the measurement plane orientation, is smaller than the above, the measurement resolution must be ≤ the corresponding x or y dimension of the test device with at least one measurement point on the test device.		
Maximum zoom scan spatial resolution: Δx <sub>Zoom</sub> , Δy <sub>Zoom</sub>		≤ 2 GHz: ≤ 8 mm 2 – 3 GHz: ≤ 5 mm*	3 – 4 GHz: ≤ 5 mm* 4 – 6 GHz: ≤ 4 mm*	
Maximum zoom scan spatial resolution, normal to phantom surface	uniform grid: Δz <sub>Zoom</sub> (n)	≤ 5 mm	3 – 4 GHz: ≤ 4 mm 4 – 5 GHz: ≤ 3 mm 5 – 6 GHz: ≤ 2 mm	
	graded grid	Δz <sub>Zoom</sub> (1): between 1 <sup>st</sup> two points closest to phantom surface	≤ 4 mm	3 – 4 GHz: ≤ 3 mm 4 – 5 GHz: ≤ 2.5 mm 5 – 6 GHz: ≤ 2 mm
		Δz <sub>Zoom</sub> (n>1): between subsequent points	≤ 1.5·Δz <sub>Zoom</sub> (n-1)	
Minimum zoom scan volume	x, y, z	≥ 30 mm	3 – 4 GHz: ≥ 28 mm 4 – 5 GHz: ≥ 25 mm 5 – 6 GHz: ≥ 22 mm	

Note: δ is the penetration depth of a plane-wave at normal incidence to the tissue medium; see draft standard IEEE P1528-2011 for details.

\* When zoom scan is required and the *reported* SAR from the *area scan based 1-g SAR estimation* procedures of KDB 447498 is ≤ 1.4 W/kg, ≤ 8 mm, ≤ 7 mm and ≤ 5 mm zoom scan resolution may be applied, respectively, for 2 GHz to 3 GHz, 3 GHz to 4 GHz and 4 GHz to 6 GHz.

### **3.3. Description of interpolation/extrapolation scheme**

The local SAR inside the phantom is measured using small dipole sensing elements inside a probe body. The probe tip must not be in contact with the phantom surface in order to minimise measurements errors, but the highest local SAR will occur at the surface of the phantom.

An extrapolation is using to determinate this highest local SAR values. The extrapolation is based on a fourth-order least-square polynomial fit of measured data. The local SAR value is then extrapolated from the liquid surface with a 1 mm step.

The measurements have to be performed over a limited time (due to the duration of the battery) so the step of measurement is high. It could vary between 5 and 8 mm. To obtain an accurate assessment of the maximum SAR averaged over 10 grams and 1 gram requires a very fine resolution in the three dimensional scanned data array.

### **3.4. Volumetric Scan**

The volumetric scan consists to a full 3D scan over a specific area. This 3D scan is useful form multi Tx SAR measurement. Indeed, it is possible with OpenSAR to add, point by point, several volumetric scan to calculate the SAR value of the combined measurement as it is define in the standard IEEE1528 and IEC62209.

### **3.5. Power Drift**

All SAR testing is under the EUT install full charged battery and transmit maximum output power. In OpenSAR measurement software, the power reference measurement and power drift measurement procedures are used for monitoring the power drift of EUT during SAR test. Both these procedures measure the field at a specified reference position before and after the SAR testing. The software will calculate the field difference in V/m. If the power drifts more than  $\pm 5\%$ , the SAR will be retested.

## 4. System Verification Procedure

### 4.1. Tissue Verification

The following tissue formulations are provided for reference only as some of the parameters have not been thoroughly verified. The composition of ingredients may be modified accordingly to achieve the desired target tissue parameters required for routine SAR evaluation.

Ingredients (% of weight)	Head Tissue									
	750	835	900	1800	1900	2000	2450	2600	5200	5800
Frequency Band (MHz)										
Water	34.40	34.40	34.40	55.36	55.36	57.87	57.87	57.87	65.53	65.53
NaCl	0.79	0.79	0.79	0.35	0.35	0.16	0.16	0.16	0.00	0.00
1,2-Propanediol	64.81	64.81	64.81	0.00	0.00	0.00	0.00	0.00	0.00	0.00
Triton X-100	0.00	0.00	0.00	30.45	30.45	19.97	19.97	19.97	24.24	24.24
DGBE	0.00	0.00	0.00	13.84	13.84	22.00	22.00	22.00	10.23	10.23
Ingredients (% of weight)	Body Tissue									
	750	835	900	1800	1900	2000	2450	2600	5200	5800
Frequency Band (MHz)										
Water	50.30	50.30	50.30	69.91	69.91	71.88	71.88	71.88	79.54	79.54
NaCl	0.60	0.60	0.60	0.13	0.13	0.16	0.16	0.16	0.00	0.00
1,2-Propanediol	49.10	49.10	49.10	0.00	0.00	0.00	0.00	0.00	0.00	0.00
Triton X-100	0.00	0.00	0.00	9.99	9.99	19.97	19.97	19.97	11.24	11.24
DGBE	0.00	0.00	0.00	19.97	19.97	7.99	7.99	7.99	9.22	9.22

For SAR measurement of the field distribution inside the phantom, the phantom must be filled with homogeneous tissue simulating liquid to a depth of at least 15 cm. For head SAR testing, the liquid depth from the ear reference point (ERP) of the phantom to the liquid top surface is larger than 15 cm.

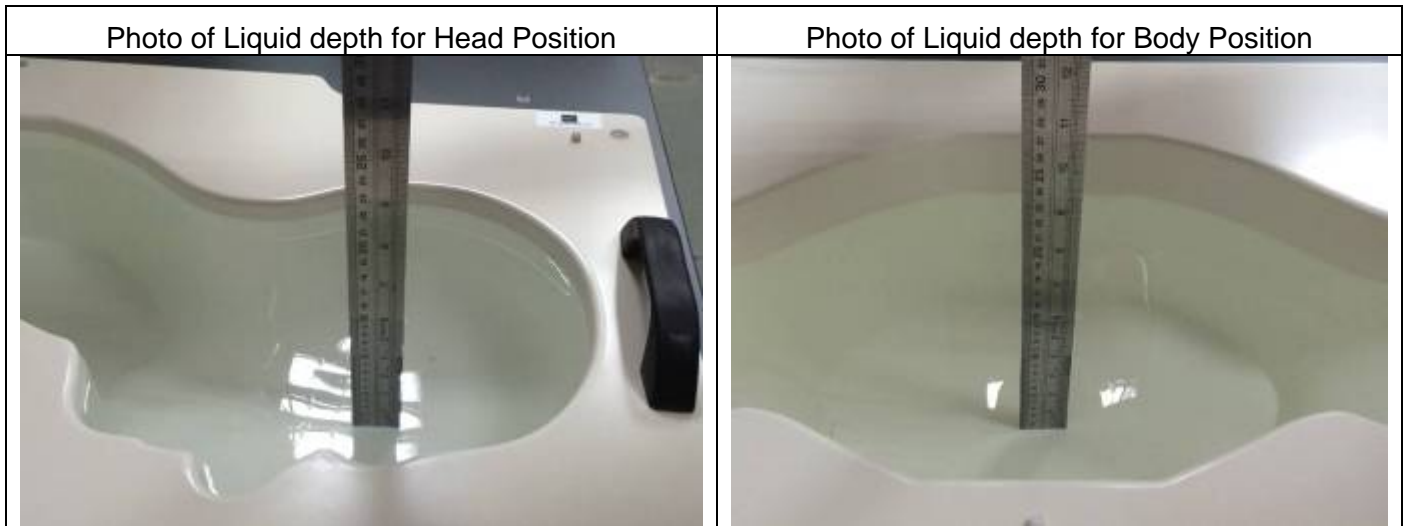

**4.1.1. Tissue Dielectric Parameter Check Results**

The simulating liquids should be checked at the beginning of a series of SAR measurements to determine if the dielectric parameters are within the tolerances of the specified target values. The measured conductivity and relative permittivity should be within  $\pm 5\%$  of the target values.

Tissue Type	Measured Frequency (MHz)	Target Tissue		Measured Tissue		Liquid Temp.	Test Date
		$\epsilon_r (\pm 5\%)$	$\sigma$ (S/m) ( $\pm 5\%$ )	$\epsilon_r$	$\sigma$ (S/m)		
Head 2450	2450	39.20 (37.24~41.16)	1.80 (1.71~1.89)	37.84	1.78	21.5 °C	Nov. 03, 2024
Head 5200	5200	36.00 (34.20~37.80)	4.66 (4.43~4.89)	34.73	4.56	21.9 °C	Nov. 05, 2024
Head 5400	5400	35.80 (34.01~37.59)	4.86 (4.62~5.10)	35.59	4.72	21.8 °C	Oct. 25, 2024
Head 5600	5600	35.50 (33.73~37.28)	5.07 (4.82~5.32)	34.64	5.01	21.6 °C	Nov. 04, 2024
Head 5800	5800	35.30 (33.54~37.07)	5.27 (5.01~5.53)	35.47	5.14	21.9 °C	Oct. 26, 2024

NOTE: The dielectric parameters of the tissue-equivalent liquid should be measured under similar ambient conditions and within 2 °C of the conditions expected during the SAR evaluation to satisfy protocol requirements.

## 4.2. System Verification Procedure

The system verification is performed for verifying the accuracy of the complete measurement system and performance of the software. The dipole is connected to the signal source consisting of signal generator and amplifier via a directional coupler, N-connector cable and adaption to SMA. To adjust this power a power meter is used. The power sensor is connected to the cable before the system verification to measure the power at this point and do adjustments at the signal generator. At the outputs of the directional coupler both return loss as well as forward power are controlled during the system verification to make sure that emitted power at the dipole is kept constant. This can also be checked by the power drift measurement after the test (result on plot).

The system verification is shown as below picture:

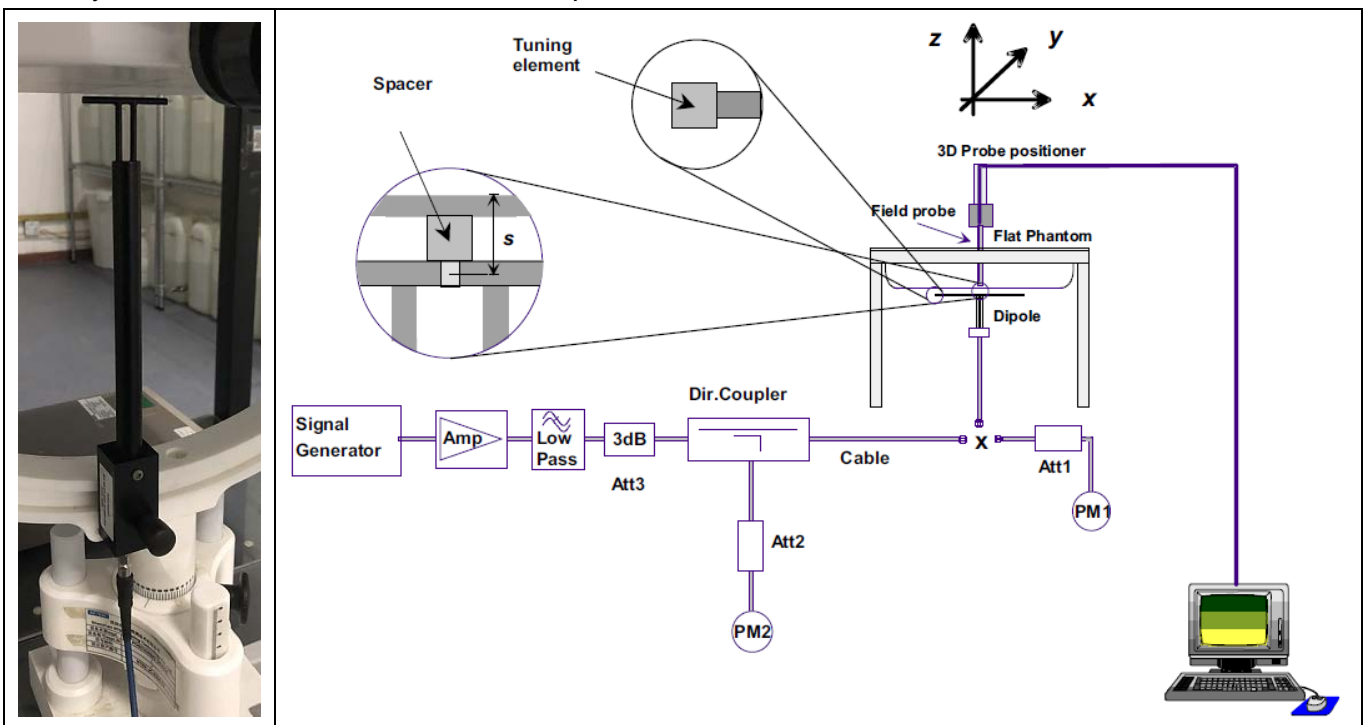

### 4.2.1. System Verification Results

Comparing to the original SAR value provided by SATIMO, the verification data should be within its specification of  $\pm 10\%$ . Below table shows the target SAR and measured SAR after normalized to 1W input power. The table below indicates the system performance verification can meet the variation criterion and the plots can be referred to Appendix B of this report.

System Verification	Target SAR (1W) ( $\pm 10\%$ )		Measured SAR			Measured SAR (Normalized to 1W)		Liquid Temp.	Test Date
	1-g (W/Kg)	10-g (W/Kg)	Input Power	1-g (W/Kg)	10-g (W/Kg)	1-g (W/Kg)	10-g (W/Kg)		
2450MHz	50.05 (45.05~55.06)	23.80 (21.42~26.18)	18dBm	2.989	1.426	47.37	22.60	21.5 °C	Nov. 03, 2024
5200MHz	162.59 (146.33~178.85)	56.21 (50.59~61.83)	18dBm	10.746	3.643	170.29	57.73	21.9 °C	Nov. 05, 2024
5400MHz	159.81 (143.83~175.79)	55.00 (49.50~60.50)	20dBm	17.137	5.988	171.37	59.88	21.8 °C	Oct. 25, 2024
5600MHz	179.15 (161.24~197.07)	61.01 (54.91~67.11)	20dBm	16.149	5.604	161.49	56.04	21.6 °C	Nov. 04, 2024
5800MHz	182.20 (163.98~200.42)	61.32 (55.19~67.45)	20dBm	17.515	5.570	175.15	55.70	21.9 °C	Oct. 26, 2024



## **5. SAR Measurement variability and uncertainty**

### **5.1. SAR measurement variability**

Per KDB865664 D01 SAR measurement 100 MHz to 6 GHz, SAR measurement variability must be assessed for each frequency band, which is determined by the SAR probe calibration point and tissue-equivalent medium used for the device measurements. The additional measurements are repeated after the completion of all measurements requiring the same head or body tissue-equivalent medium in a frequency band. The test device should be returned to ambient conditions (normal room temperature) with the battery fully charged before it is re-mounted on the device holder for the repeated measurement(s) to minimize any unexpected variations in the repeated results.

- 1) Repeated measurement is not required when the original highest measured SAR is  $< 0.80$  W/kg; steps 2) through 4) do not apply.
- 2) When the original highest measured SAR is  $\geq 0.80$  W/kg, repeat that measurement once.
- 3) Perform a second repeated measurement only if the ratio of largest to smallest SAR for the original and first repeated measurements is  $> 1.20$  or when the original or repeated measurement is  $\geq 1.45$  W/kg (~ 10% from the 1-g SAR limit).
- 4) Perform a third repeated measurement only if the original, first or second repeated measurement is  $\geq 1.5$  W/kg and the ratio of largest to smallest SAR for the original, first and second repeated measurements is  $> 1.20$ .

### **5.2. SAR measurement uncertainty**

Per KDB865664 D01 SAR Measurement 100 MHz to 6 GHz, when the highest measured 1-g SAR within a frequency band is  $< 1.5$  W/kg, the extensive SAR measurement uncertainty analysis described in IEEE Std 1528-2013 is not required in SAR reports submitted for equipment approval. The equivalent ratio (1.5/1.6) is applied to extremity and occupational exposure conditions.



## 6. RF Exposure Positions

### 6.1. Tablet PC host platform exposure conditions

Refer to KDB616217 D04, when the modular approach is used, transmitters and modules must be initially tested for standalone operations in generic host conditions according to the following minimum test separation distance and antenna installation requirements for incorporation in the tablet platform. The separation distance required for incorporation in qualified hosts is described in KDB 447498; item 5) of section 4.1 and item 1) of section 5.2.2 etc.

- $\leq 5$  mm between the antenna and user for both back surface and edge exposure conditions
- the antennas used by the host must have been tested for equipment approval or qualify for SAR test exclusion
- the antenna polarization, physical orientation, rotation and installation configurations used by the host must have been tested for compliance or qualify for test exclusion
- when the *SAR Test Exclusion Threshold* in KDB 447498 applies, a *test separation distance* of 5 mm is required to determine test exclusion for the tablet platform

The antennas embedded in tablets are typically  $\leq 5$ mm from the outer housing. The required antenna to user test separation distance is a “not to exceed test” distance required to apply the modular approach. Instead of the typical zero gap tablet edge test requirement between the edge of a tablet and the user, when an antenna has been tested at  $\leq 5$  mm according to the modular approach it can be incorporated into tablets with at least twice the tested distance from the outer housing of the tablet edge; otherwise, the tablet edge zero gap test requirement applies. When the dedicated host approach is applied, the back surface and edges of the tablet should be tested for SAR compliance with the tablet touching the phantom.

## 7. RF Output Power

### 7.1. WLAN & Bluetooth Output Power

#### 7.1.1. Output Power Results Of WLAN

Mode	Channel	Frequency (MHz)	Tune-up (dBm)	Output Power (dBm)
802.11b	1	2412	18.00	17.53
	6	2437	18.00	17.87
	11	2462	18.00	17.50
802.11g	1	2412	12.50	11.28
	6	2437	12.50	12.09
	11	2462	12.50	11.92
802.11n HT20	1	2412	11.50	10.95
	6	2437	11.50	11.20
	11	2462	11.50	11.11
802.11n HT40	3	2422	10.00	9.66
	6	2437	10.00	9.69
	9	2452	10.00	9.59

NOTE: Power measurement results of WLAN 2.4G.

Mode	Channel	Frequency (MHz)	Tune-up (dBm)	Output Power (dBm)
802.11a	36	5180	15.50	15.12
	40	5200	15.50	15.22
	48	5240	15.50	15.43
802.11n HT20	36	5180	15.50	15.19
	40	5200	15.50	15.16
	48	5240	15.50	15.33
802.11n HT40	38	5190	15.50	15.30
	46	5230	15.50	15.32
802.11ac VHT20	36	5180	15.50	15.17
	40	5200	15.50	15.41
	48	5240	15.50	15.25
802.11ac VHT40	38	5190	15.50	15.13
	46	5230	15.50	15.32
802.11ac VHT80	42	5210	15.50	15.06

NOTE: Power measurement results of WLAN 5.2G.

Mode	Channel	Frequency (MHz)	Tune-up (dBm)	Output Power (dBm)
802.11a	52	5260	15.50	15.23
	56	5280	15.50	15.37
	64	5320	15.50	15.09
802.11n HT20	52	5260	15.50	15.20
	56	5280	15.50	15.34
	64	5320	15.50	15.28
802.11n HT40	54	5270	15.50	15.08
	62	5310	15.50	13.74
802.11ac VHT20	52	5260	15.50	15.05
	56	5280	15.50	15.18
	64	5320	15.50	15.07
802.11ac VHT40	54	5270	15.50	15.14
	62	5310	15.50	13.71
802.11ac VHT80	58	5290	13.50	13.17

NOTE: Power measurement results of WLAN 5.3G.

Mode	Channel	Frequency (MHz)	Tune-up (dBm)	Output Power (dBm)
802.11a	100	5500	13.50	13.18
	120	5600	13.50	13.34
	140	5700	13.50	12.03
802.11n	100	5500	13.50	13.23
	120	5600	13.50	12.52
	140	5700	13.50	11.88
802.11n	102	5510	13.00	11.31
	118	5590	13.00	11.50
	134	5670	13.00	12.54
802.11ac (VHT20)	100	5500	13.00	12.80
	120	5600	13.00	12.36
	140	5700	13.00	11.85
802.11ac (VHT40)	102	5510	13.00	11.43
	118	5590	13.00	11.38
	134	5670	13.00	12.98
802.11ac (VHT80)	106	5530	10.50	10.26
	122	5610	10.50	10.47

NOTE: Power measurement results of WLAN 5.6G.

Mode	Channel	Frequency (MHz)	Tune-up (dBm)	Output Power (dBm)
802.11a	149	5745	15.50	15.37
	157	5785	15.50	15.17
	165	5825	15.50	15.25
802.11n HT20	149	5745	15.50	15.02
	157	5785	15.50	15.18
	165	5825	15.50	15.09
802.11n HT40	151	5755	16.00	15.30
	159	5795	16.00	15.51
802.11ac VHT20	149	5745	16.00	15.04
	157	5785	16.00	15.60
	165	5825	16.00	15.45
802.11ac VHT40	151	5755	15.50	15.15
	159	5795	15.50	15.47
802.11ac VHT80	155	5775	15.50	15.21

NOTE: Power measurement results of WLAN 5.8G.

### 7.1.2. Output Power Results Of Bluetooth

BR+EDR	Output Power (dBm)				
	Data Rates	Tune-up	Channel		
			0CH	39CH	78CH
1M	8	7.23	7.66	7.96	
2M	9	7.61	8.36	8.50	
3M	9	7.86	8.47	8.60	

BLE	Channel	Tune-up	Output Power (dBm)
	0CH	7	6.51
	19CH	8	7.46
	39CH	8	7.61

NOTE: Power measurement results of Bluetooth.

## 8. Stand-alone SAR test exclusion

Refer to FCC KDB 447498D01, the 1-g SAR and 10-g SAR test exclusion thresholds for 100 MHz to 6 GHz at test separation distances  $\leq 50$  mm are determined by:

$[(\text{max. power of channel, including tune-up tolerance, mW})/(\text{min. test separation distance, mm})] \cdot [\sqrt{f_{(\text{GHz})}}] \leq 3.0$  for 1-g SAR and  $\leq 7.5$  for 10-g extremity SAR, where:

- $f_{(\text{GHz})}$  is the RF channel transmit frequency in GHz
- Power and distance are rounded to the nearest mW and mm before calculation
- The result is rounded to one decimal place for comparison

When the minimum test separation distance is  $< 5$  mm, a distance of 5 mm is applied to determine SAR test exclusion.

Mode	$P_{\text{max}}$ (dBm)	$P_{\text{max}}$ (mW)	Distance (mm)	f (GHz)	Calculation Result	SAR Exclusion threshold	SAR test exclusion
Bluetooth	8	6.31	5	2.480	1.987	3	Yes

NOTE: Standalone SAR test exclusion for Bluetooth

## 9. SAR Results

### 9.1. SAR measurement results

General Notes:

- 1) Per KDB447498 D01, all measurement SAR results are scaled to the maximum tune-up tolerance limit to demonstrate compliant.
- 2) Per KDB447498 D01, testing of other required channels within the operating mode of a frequency band is not required when the reported 1-g or 10-g SAR for the mid-band or highest output power channel is:  $\leq 0.8$  W/kg or 2.0 W/kg, for 1-g or 10-g respectively, when the transmission band is  $\leq 100$  MHz. When the maximum output power variation across the required test channels is  $> \frac{1}{2}$  dB, instead of the middle channel, the highest output power channel must be used.
- 3) Per KDB865664 D01, for each frequency band, repeated SAR measurement is required only when the measured SAR is  $\geq 0.8$  W/Kg; if the deviation among the repeated measurement is  $\leq 20\%$ , and the measured SAR  $< 1.45$  W/Kg, only one repeated measurement is required.
- 4) Per KDB865664 D02, SAR plot is only required for the highest measured SAR in each exposure configuration, wireless mode and frequency band combination; Plots are also required when the measured SAR is  $> 1.5$  W/kg, or  $> 7.0$  W/kg for occupational exposure. The published RF exposure KDB procedures may require additional plots; for example, to support SAR to peak location separation ratio test exclusion and/or volume scan post-processing(Refer to appendix C for details).

**9.1.1. SAR measurement Result of WLAN 2.4G**

Test Position of Body-Worn with 5mm	Test channel /Freq.	Mode	SAR Value (W/kg)		Power Drift(%)	Conducted Power (dBm)	Tune-up Power (dBm)	Scaled SAR 1-g (W/Kg)	Date	Plot
			1-g	10-g						
Horizontal-Up	6/2437	802.11b	0.278	0.123	-3.18	17.87	18.00	0.286	2024/11/03	#5
Horizontal-Down	6/2437	802.11b	0.160	0.076	0.00	17.87	18.00	0.165	2024/11/03	

NOTE: Body-Worn SAR test results of WLAN 2.4G

Test Position of Hotspot with 5mm	Test channel /Freq.	Mode	SAR Value (W/kg)		Power Drift(%)	Conducted Power (dBm)	Tune-up Power (dBm)	Scaled SAR 1-g (W/Kg)	Date	Plot
			1-g	10-g						
Horizontal-Up	6/2437	802.11b	0.278	0.123	-3.18	17.87	18.00	0.286	2024/11/03	#5
Horizontal-Down	6/2437	802.11b	0.160	0.076	0.00	17.87	18.00	0.165	2024/11/03	
Vertical-Front	6/2437	802.11b	0.199	0.100	-2.68	17.87	18.00	0.205	2024/11/03	
Vertical-Back	6/2437	802.11b	0.158	0.077	3.30	17.87	18.00	0.163	2024/11/03	
Tip Side	6/2437	802.11b	0.076	0.038	-1.09	17.87	18.00	0.078	2024/11/03	

NOTE: Hotspot SAR test results of WLAN 2.4G

**9.1.2. SAR measurement Result of WLAN 5.2G**

Test Position of Body-Worn with 5mm	Test channel /Freq.	Mode	SAR Value (W/kg)		Power Drift(%)	Conducted Power (dBm)	Tune-up Power (dBm)	Scaled SAR 1-g (W/Kg)	Date	Plot
			1-g	10-g						
Horizontal-Up	42/5210	802.11ac VHT80	0.805	0.267	-0.92	15.06	15.50	0.891	2024/11/05	#4
Horizontal-Down	42/5210	802.11ac VHT80	0.288	0.101	-2.00	15.06	15.50	0.319	2024/11/05	

NOTE: Body-Worn SAR test results of WLAN 5.2G

Test Position of Hotspot with 5mm	Test channel /Freq.	Mode	SAR Value (W/kg)		Power Drift(%)	Conducted Power (dBm)	Tune-up Power (dBm)	Scaled SAR 1-g (W/Kg)	Date	Plot
			1-g	10-g						
Horizontal-Up	42/5210	802.11ac VHT80	0.805	0.267	-0.92	15.06	15.50	0.891	2024/11/05	#4
Horizontal-Down	42/5210	802.11ac VHT80	0.288	0.101	-2.00	15.06	15.50	0.319	2024/11/05	
Vertical-Front	42/5210	802.11ac	0.462	0.152	-2.45	15.06	15.50	0.511	2024/11/05	

		VHT80								
Vertical-Back	42/5210	802.11ac VHT80	0.361	0.115	-2.87	15.06	15.50	0.399	2024/11/05	
Tip Side	42/5210	802.11ac VHT80	0.523	0.172	1.24	15.06	15.50	0.579	2024/11/05	
Horizontal-Up Repeated	42/5210	802.11ac VHT80	0.789	0.253	-0.43	15.06	15.50	0.873	2024/11/05	

NOTE: Hotspot SAR test results of WLAN 5.2G

### 9.1.3. SAR measurement Result of WLAN 5.3G

Test Position of Body-Worn with 5mm	Test channel /Freq.	Mode	SAR Value (W/kg)		Power Drift(%)	Conducted Power (dBm)	Tune-up Power (dBm)	Scaled SAR 1-g (W/Kg)	Date	Plot
			1-g	10-g						
Horizontal-Up	54/5270	802.11ac VHT40	0.992	0.325	-4.21	15.14	15.50	1.078	2024/10/25	1#
Horizontal-Down	54/5270	802.11ac VHT40	0.576	0.183	-2.97	15.14	15.50	0.626	2024/10/25	

NOTE: Body-Worn SAR test results of WLAN 5.3G

Test Position of Hotspot with 5mm	Test channel /Freq.	Mode	SAR Value (W/kg)		Power Drift(%)	Conducted Power (dBm)	Tune-up Power (dBm)	Scaled SAR 1-g (W/Kg)	Date	Plot
			1-g	10-g						
Horizontal-Up	54/5270	802.11ac VHT40	0.992	0.325	-4.21	15.14	15.50	1.078	2024/10/25	1#
Horizontal-Down	54/5270	802.11ac VHT40	0.576	0.183	-2.97	15.14	15.50	0.626	2024/10/25	
Vertical-Front	54/5270	802.11ac VHT40	0.430	0.138	-0.08	15.14	15.50	0.467	2024/10/25	
Vertical-Back	54/5270	802.11ac VHT40	0.630	0.200	1.13	15.14	15.50	0.684	2024/10/25	
Tip Side	54/5270	802.11ac VHT40	0.643	0.202	-1.66	15.14	15.50	0.699	2024/10/25	
Horizontal-Up	64/5320	802.11ac VHT40	0.863	0.267	-4.21	13.71	15.50	1.303	2024/10/25	
Horizontal-Up Repeated	64/5320	802.11ac VHT40	0.858	0.213	3.14	13.71	15.50	1.296	2024/10/25	

NOTE: Body SAR test results of WLAN 5.3G



#### 9.1.4. SAR measurement Result of WLAN 5.6G

Test Position of Body-Worn with 5mm	Test channel /Freq.	Mode	SAR Value (W/kg)		Power Drift(%)	Conducted Power (dBm)	Tune-up Power (dBm)	Scaled SAR 1-g (W/Kg)	Date	Plot
			1-g	10-g						
Horizontal-Up	120/5600	802.11n	1.242	0.411	-3.73	12.52	13.50	1.556	2024/11/04	#2
Horizontal-Down	120/5600	802.11n	0.658	0.241	-2.51	12.52	13.50	0.658	2024/11/04	

NOTE: Body-Worn SAR test results of WLAN 5.6G

Test Position of Hotspot with 5mm	Test channel /Freq.	Mode	SAR Value (W/kg)		Power Drift(%)	Conducted Power (dBm)	Tune-up Power (dBm)	Scaled SAR 1-g (W/Kg)	Date	Plot
			1-g	10-g						
Horizontal-Up	120/5600	802.11n	1.242	0.411	-3.73	12.52	13.50	1.556	2024/11/04	#2
Horizontal-Down	120/5600	802.11n	0.658	0.241	-2.51	12.52	13.50	0.658	2024/11/04	
Vertical-Front	120/5600	802.11n	0.735	0.233	-0.54	12.52	13.50	0.735	2024/11/04	
Vertical-Back	120/5600	802.11n	0.550	0.177	0.06	12.52	13.50	0.550	2024/11/04	
Tip Side	120/5600	802.11n	0.794	0.252	0.54	12.52	13.50	0.794	2024/11/04	
Horizontal-Up Low	100/5500	802.11n	1.158	0.387	-3.73	12.52	13.50	1.451	2024/11/04	
Horizontal-Up High	140/5700	802.11n	1.216	0.402	4.62	12.52	13.50	1.524	2024/11/04	
Horizontal-Up Repeated	120/5600	802.11n	1.226	0.409	1.63	12.52	13.50	1.536	2024/11/04	

NOTE: Hotspot SAR test results of WLAN 5.6G

#### 9.1.5. SAR measurement Result of WLAN 5.8G

Test Position of Body-Worn with 5mm	Test channel /Freq.	Mode	SAR Value (W/kg)		Power Drift(%)	Conducted Power (dBm)	Tune-up Power (dBm)	Scaled SAR 1-g (W/Kg)	Date	Plot
			1-g	10-g						
Horizontal-Up	155/5775	802.11a	0.804	0.285	-0.13	15.21	15.50	0.860	2024/10/26	#3
Horizontal-Down	155/5775	802.11a	0.621	0.212	-0.19	15.21	15.50	0.664	2024/10/26	

10. NOTE: Body-Worn SAR test results of WLAN 5.8G

Test Position of Hotspot with 5mm	Test channel /Freq.	Mode	SAR Value (W/kg)		Power Drift(%)	Conducted Power (dBm)	Tune-up Power (dBm)	Scaled SAR 1-g (W/Kg)	Date	Plot
			1-g	10-g						
Horizontal-Up	155/5775	802.11a	0.804	0.285	-0.13	15.21	15.50	0.860	2024/10/26	#3
Horizontal-Down	155/5775	802.11a	0.621	0.212	-0.19	15.21	15.50	0.664	2024/10/26	
Vertical-Front	155/5775	802.11a	0.473	0.161	2.95	15.21	15.50	0.506	2024/10/26	
Vertical-Back	155/5775	802.11a	0.361	0.128	2.14	15.21	15.50	0.386	2024/10/26	
Tip Side	155/5775	802.11a	0.529	0.188	2.28	15.21	15.50	0.566	2024/10/26	

NOTE: Hotspot SAR test results of WLAN 5.8G

### 10.1. Simultaneous Transmission Analysis

NO simultaneous transmissions are possible for this device of Bluetooth, 2.4G/5G Wi-Fi.

### 11. Appendix A. Photo documentation

Refer to appendix Test Setup photo---SAR

## 12. Appendix B. System Check Plots

Table of contents
MEASUREMENT 1 System Performance Check - 2450MHz
MEASUREMENT 2 System Performance Check - 5200MHz
MEASUREMENT 3 System Performance Check - 5400MHz
MEASUREMENT 3 System Performance Check - 5600MHz
MEASUREMENT 5 System Performance Check - 5800MHz

# MEASUREMENT 1

Date of measurement: 3/11/2024

## A. Experimental conditions.

<b>Area Scan</b>	<u>dx=12mm dy=12mm, h= 5.00 mm</u>
<b>ZoomScan</b>	<u>7x7x7, dx=5mm dy=5mm dz=5mm</u>
<b>Phantom</b>	<u>Validation plane</u>
<b>Device Position</b>	<u>Dipole</u>
<b>Band</b>	<u>CW2450</u>
<b>Channels</b>	<u>Middle</u>
<b>Signal</b>	<u>CW (Crest factor: 1.0)</u>
<b>ConvF</b>	<u>2.74</u>

## B. SAR Measurement Results

<b>Frequency (MHz)</b>	2450.000000
<b>Relative permittivity (real part)</b>	37.838986
<b>Relative permittivity (imaginary part)</b>	13.085579
<b>Conductivity (S/m)</b>	1.781093
<b>Variation (%)</b>	3.070000

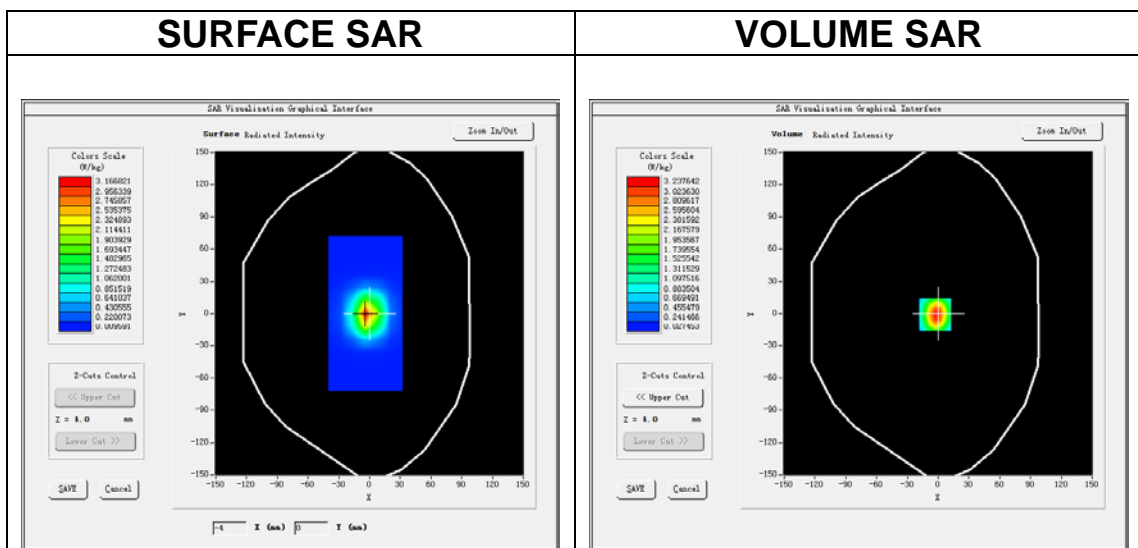

**Maximum location: X=-3.00, Y=-1.00**

**SAR Peak: 5.31 W/kg**

<b>SAR 10g (W/Kg)</b>	1.426298
<b>SAR 1g (W/Kg)</b>	2.989339

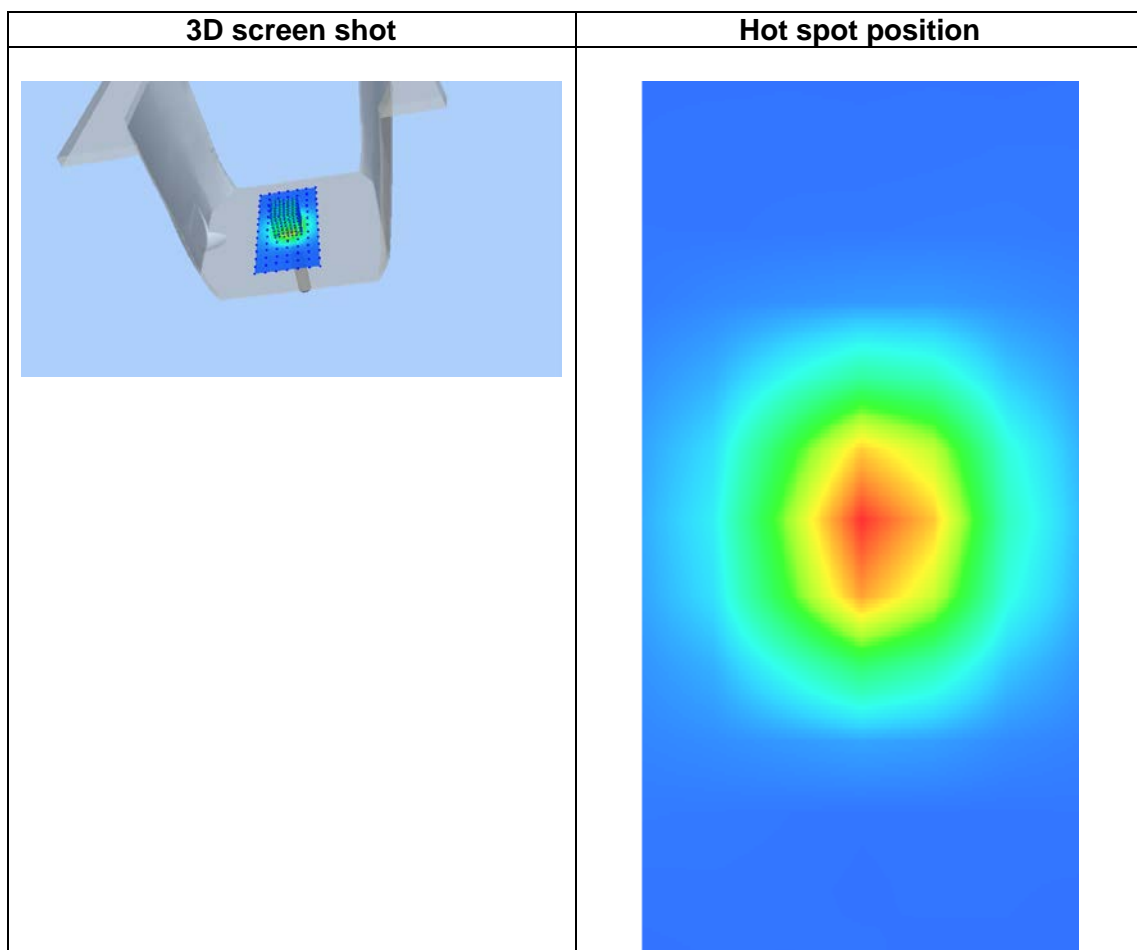
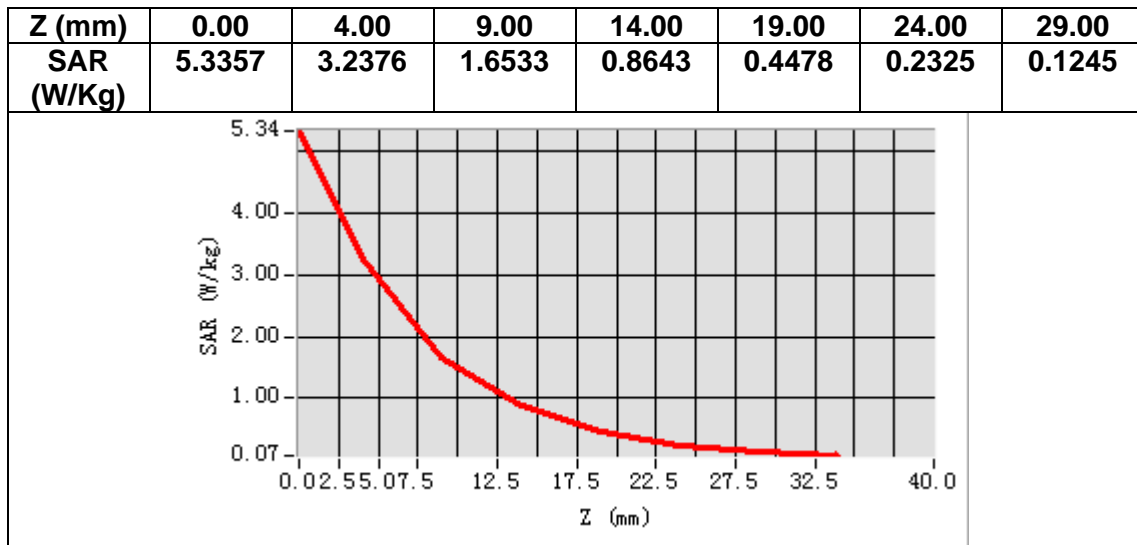

# MEASUREMENT 2

Date of measurement: 5/11/2024

## A. Experimental conditions.

<b>Area Scan</b>	<u>dx=10mm dy=10mm, h= 2.00 mm</u>
<b>ZoomScan</b>	<u>7x7x12,dx=4mm dy=4mm dz=2mm</u>
<b>Phantom</b>	<u>Validation plane</u>
<b>Device Position</b>	<u>Dipole</u>
<b>Band</b>	<u>CW5200</u>
<b>Channels</b>	<u>Middle</u>
<b>Signal</b>	<u>CW (Crest factor: 1.0)</u>
<b>ConvF</b>	<u>1.89</u>

## B. SAR Measurement Results

<b>Frequency (MHz)</b>	5200.000000
<b>Relative permittivity (real part)</b>	34.725906
<b>Relative permittivity (imaginary part)</b>	15.795970
<b>Conductivity (S/m)</b>	4.563280
<b>Variation (%)</b>	0.040000

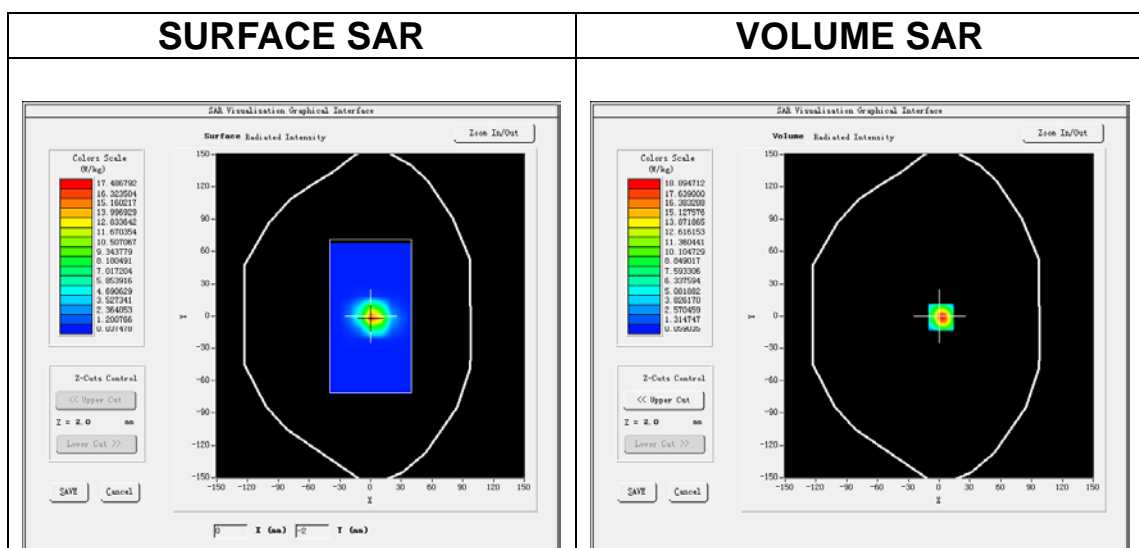

**Maximum location: X=2.00, Y=-1.00**

**SAR Peak: 32.59 W/kg**

<b>SAR 10g (W/Kg)</b>	3.643305
<b>SAR 1g (W/Kg)</b>	10.746393

Z (m)	0.00	2.00	4.00	6.00	8.00	10.00	12.00	14.00	16.00	18.00	20.00	22.00
SAR (W/Kg)	31.0112	18.8947	10.0820	5.5884	3.0325	1.6788	0.9281	0.5398	0.3265	0.2005	0.1550	0.1025

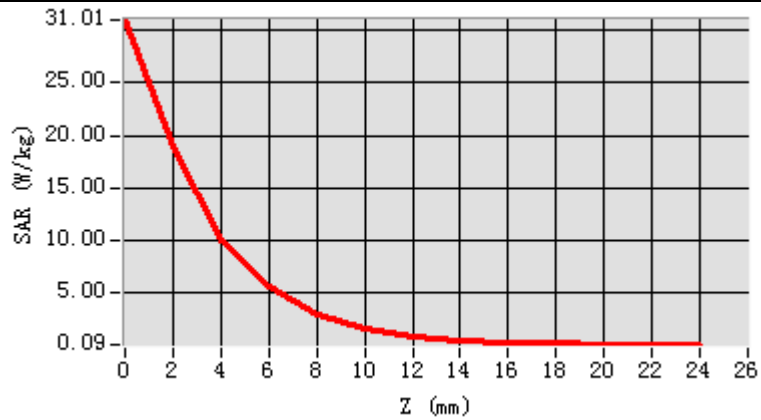

3D screen shot

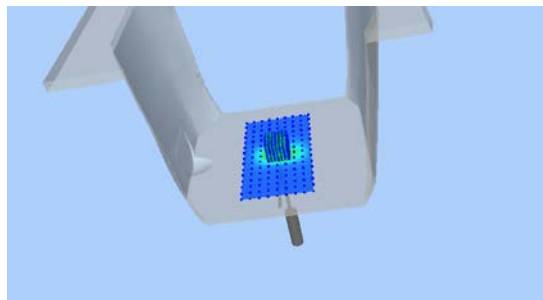

Hot spot position

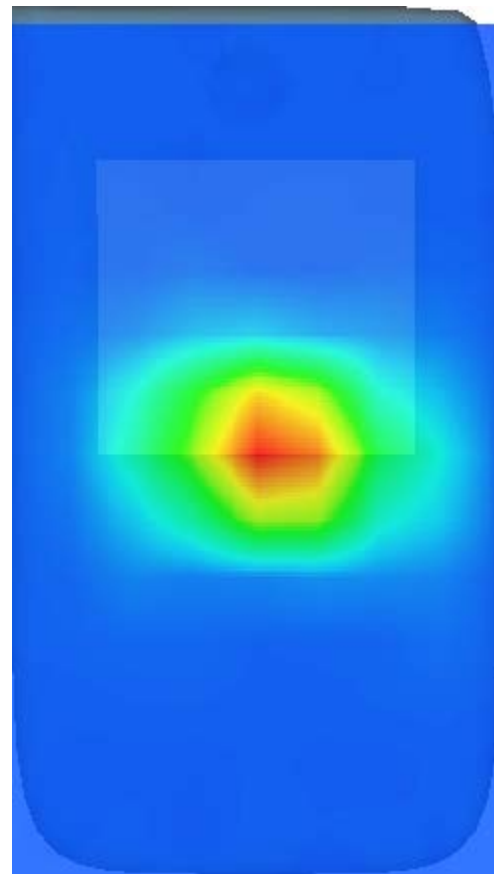

# MEASUREMENT 3

Date of measurement: 25/10/2024

## A. Experimental conditions.

<b>Area Scan</b>	<u>dx=10mm dy=10mm, h= 2.00 mm</u>
<b>ZoomScan</b>	<u>7x7x12,dx=4mm dy=4mm dz=2mm</u>
<b>Phantom</b>	<u>Validation plane</u>
<b>Device Position</b>	<u>Dipole</u>
<b>Band</b>	<u>CW5400</u>
<b>Channels</b>	<u>Middle</u>
<b>Signal</b>	<u>CW (Crest factor: 1.0)</u>
<b>ConvF</b>	<u>1.97</u>

## B. SAR Measurement Results

<b>Frequency (MHz)</b>	5400.000000
<b>Relative permittivity (real part)</b>	35.591825
<b>Relative permittivity (imaginary part)</b>	15.728485
<b>Conductivity (S/m)</b>	4.718546
<b>Variation (%)</b>	1.350000

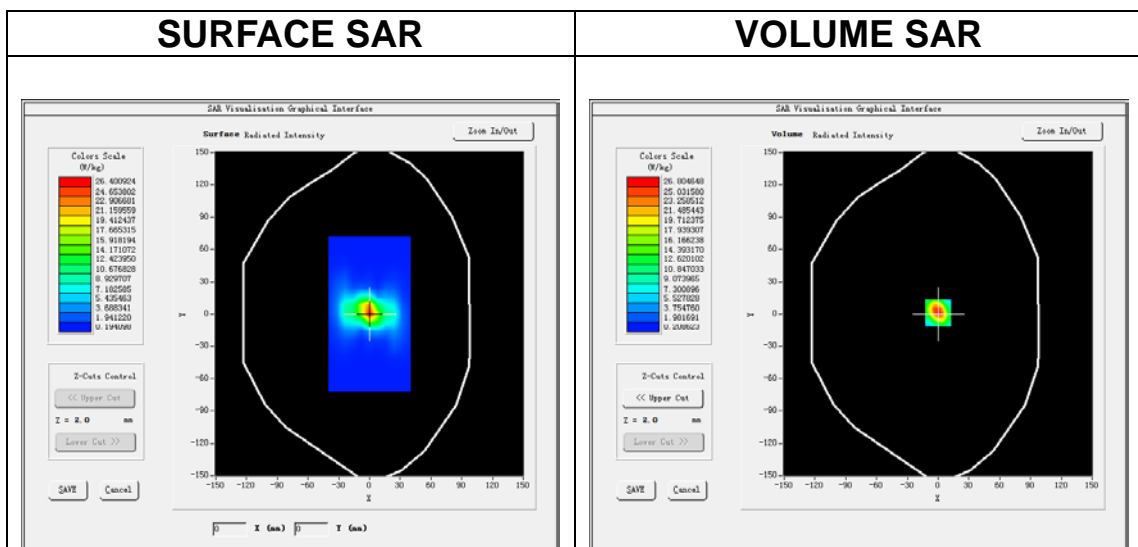

**Maximum location: X=0.00, Y=1.00**

**SAR Peak: 46.18 W/kg**

<b>SAR 10g (W/Kg)</b>	5.988428
<b>SAR 1g (W/Kg)</b>	17.137225



Z (m m)	0.00	2.00	4.00	6.00	8.00	10.00	12.00	14.00	16.00	18.00	20.00	22.00
SAR (W/Kg)	44.0730	26.8035	14.6104	7.8178	4.2299	2.3249	1.3238	0.7816	0.5067	0.3759	0.2858	0.2660

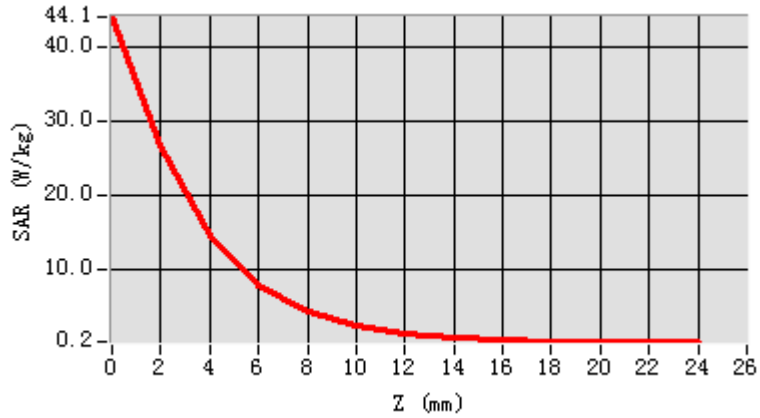

**3D screen shot**

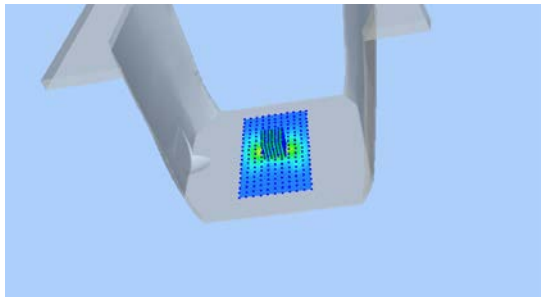

**Hot spot position**

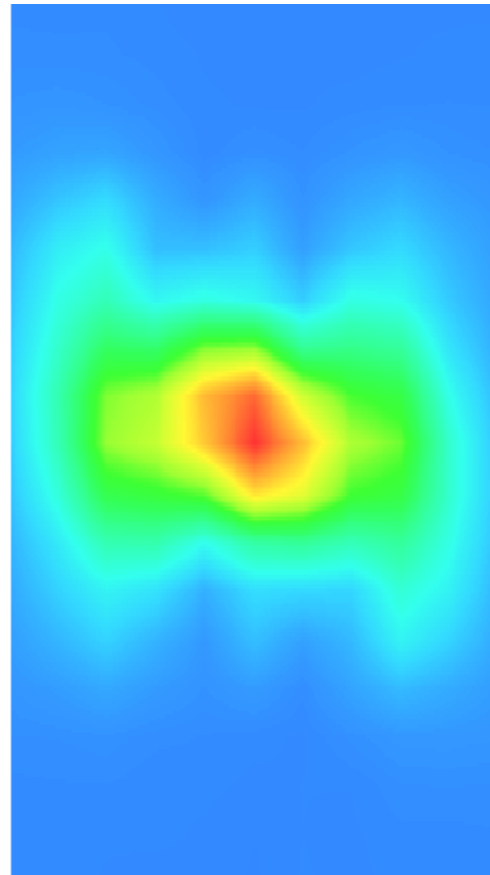

# MEASUREMENT 4

Date of measurement: 4/11/2024

## A. Experimental conditions.

<b>Area Scan</b>	<u>dx=10mm dy=10mm, h= 2.00 mm</u>
<b>ZoomScan</b>	<u>7x7x12,dx=4mm dy=4mm dz=2mm</u>
<b>Phantom</b>	<u>Validation plane</u>
<b>Device Position</b>	<u>Dipole</u>
<b>Band</b>	<u>CW5600</u>
<b>Channels</b>	<u>Middle</u>
<b>Signal</b>	<u>CW (Crest factor: 1.0)</u>
<b>ConvF</b>	<u>1.88</u>

## B. SAR Measurement Results

<b>Frequency (MHz)</b>	5600.000000
<b>Relative permittivity (real part)</b>	34.643255
<b>Relative permittivity (imaginary part)</b>	16.113609
<b>Conductivity (S/m)</b>	5.013123
<b>Variation (%)</b>	0.134270

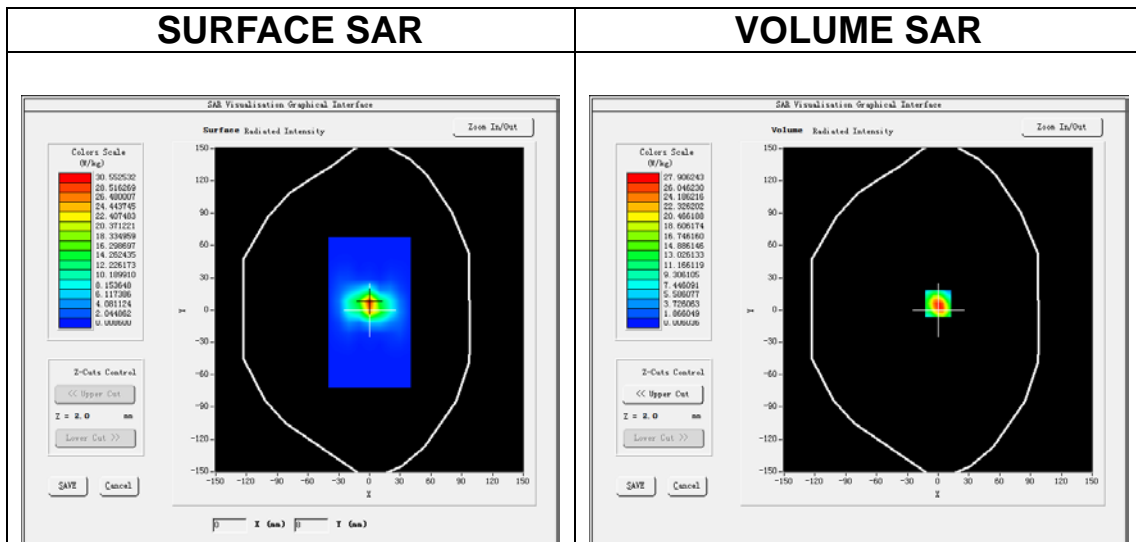

**Maximum location: X=0.00, Y=6.00**

**SAR Peak: 51.23 W/kg**

<b>SAR 10g (W/Kg)</b>	5.603995
<b>SAR 1g (W/Kg)</b>	16.149308

Z (m)	0.00	2.00	4.00	6.00	8.00	10.00	12.00	14.00	16.00	18.00	20.00	22.00
SA R (W/Kg)	54.1388	31.9062	16.3510	8.1783	4.0824	3.8166	1.0345	0.4687	0.2729	0.1326	0.0755	0.0502

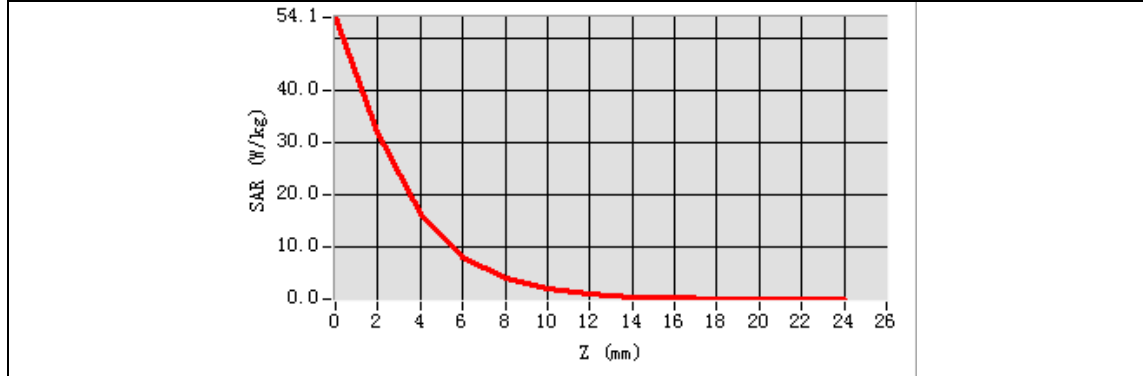

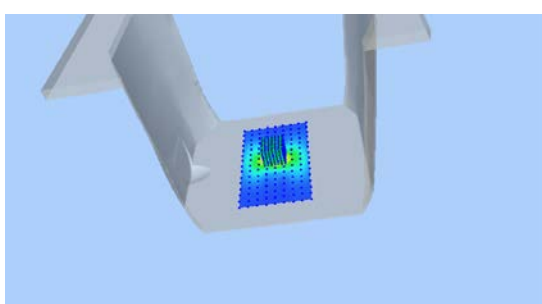
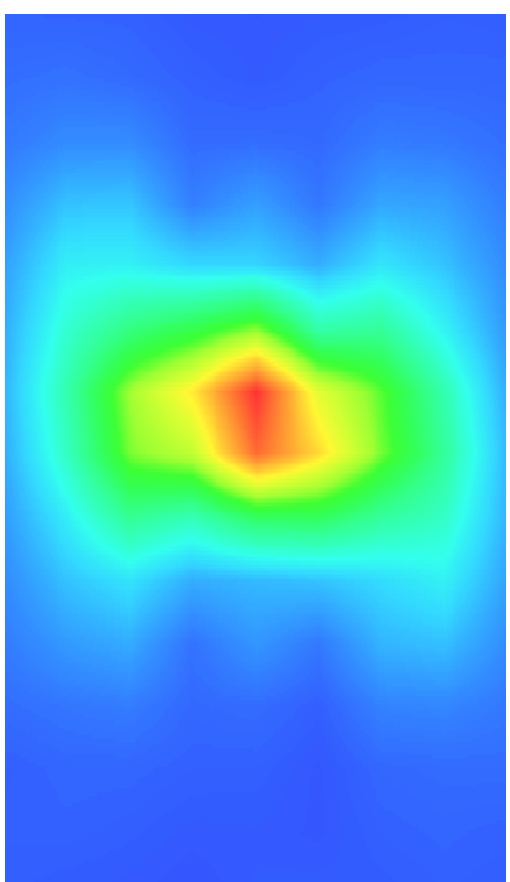
<b>3D screen shot</b>	<b>Hot spot position</b>
	

# MEASUREMENT 5

Date of measurement: 26/10/2024

## A. Experimental conditions.

<b>Area Scan</b>	<u>dx=10mm dy=10mm, h= 2.00 mm</u>
<b>ZoomScan</b>	<u>7x7x12,dx=4mm dy=4mm dz=2mm</u>
<b>Phantom</b>	<u>Validation plane</u>
<b>Device Position</b>	<u>Dipole</u>
<b>Band</b>	<u>CW5800</u>
<b>Channels</b>	<u>Middle</u>
<b>Signal</b>	<u>CW (Crest factor: 1.0)</u>
<b>ConvF</b>	<u>1.90</u>

## B. SAR Measurement Results

<b>Frequency (MHz)</b>	5800.000000
<b>Relative permittivity (real part)</b>	35.472098
<b>Relative permittivity (imaginary part)</b>	15.972741
<b>Conductivity (S/m)</b>	5.135105
<b>Variation (%)</b>	-1.540000

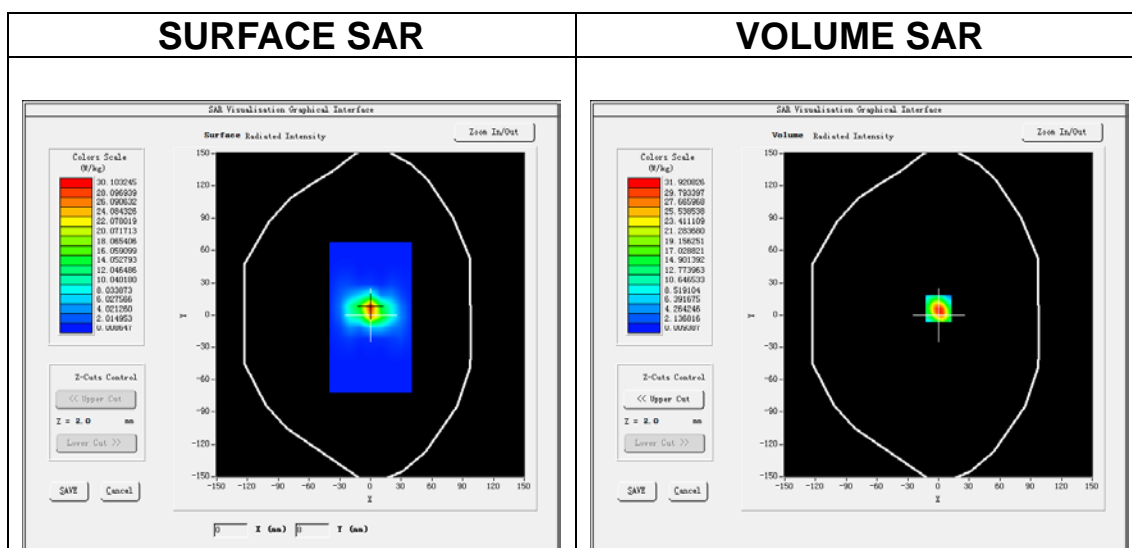

**Maximum location: X=0.00, Y=6.00**

**SAR Peak: 57.37 W/kg**

<b>SAR 10g (W/Kg)</b>	5.570177
<b>SAR 1g (W/Kg)</b>	17.515230

Z (m)	0.00	2.00	4.00	6.00	8.00	10.00	12.00	14.00	16.00	18.00	20.00	22.00
SAR (W/Kg)	54.086	31.968	16.133	8.1788	4.0888	2.0575	1.0336	0.5112	0.2770	0.1530	0.0774	0.0474

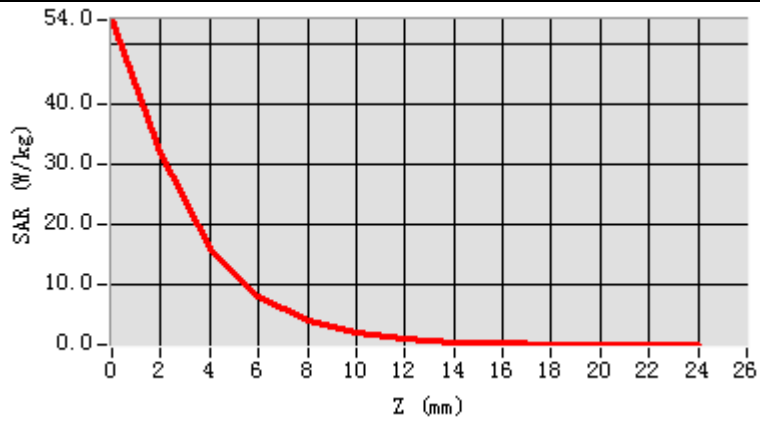

3D screen shot

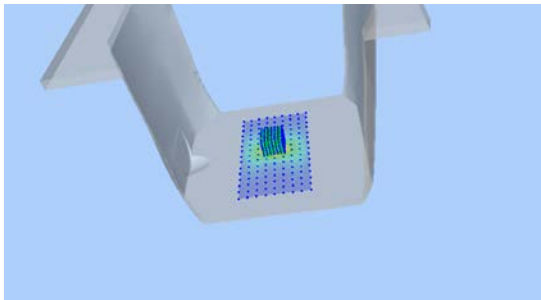

Hot spot position

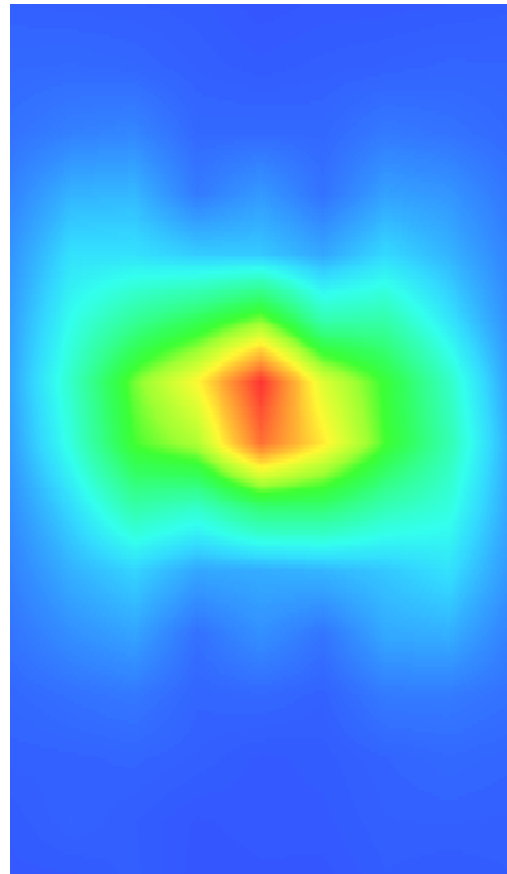

### 13. Appendix C. SAR Measurement Plots

Table of contents
MEASUREMENT 1 WLAN 5.3G Body
MEASUREMENT 2 WLAN 5.6G Body
MEASUREMENT 3 WLAN 5.8G Body
MEASUREMENT 4 WLAN 5.2G Body
MEASUREMENT 5 WLAN 2.4G Body

# MEASUREMENT 1

Date of measurement: 25/10/2024

## A. Experimental conditions.

<b>Area Scan</b>	<u>dx=10mm dy=10mm, h= 2.00 mm</u>
<b>ZoomScan</b>	<u>7x7x12,dx=4mm dy=4mm dz=2mm</u>
<b>Phantom</b>	<u>Validation plane</u>
<b>Device Position</b>	<u>Body</u>
<b>Band</b>	<u>IEEE 802.11a U-NII</u>
<b>Channels</b>	<u>Middle</u>
<b>Signal</b>	<u>IEEE802.11a (Crest factor: 1.0)</u>
<b>ConvF</b>	<u>1.97</u>

## B. SAR Measurement Results

<b>Frequency (MHz)</b>	5270.000000
<b>Relative permittivity (real part)</b>	35.945820
<b>Relative permittivity (imaginary part)</b>	15.480026
<b>Conductivity (S/m)</b>	4.540808
<b>Variation (%)</b>	-4.210000

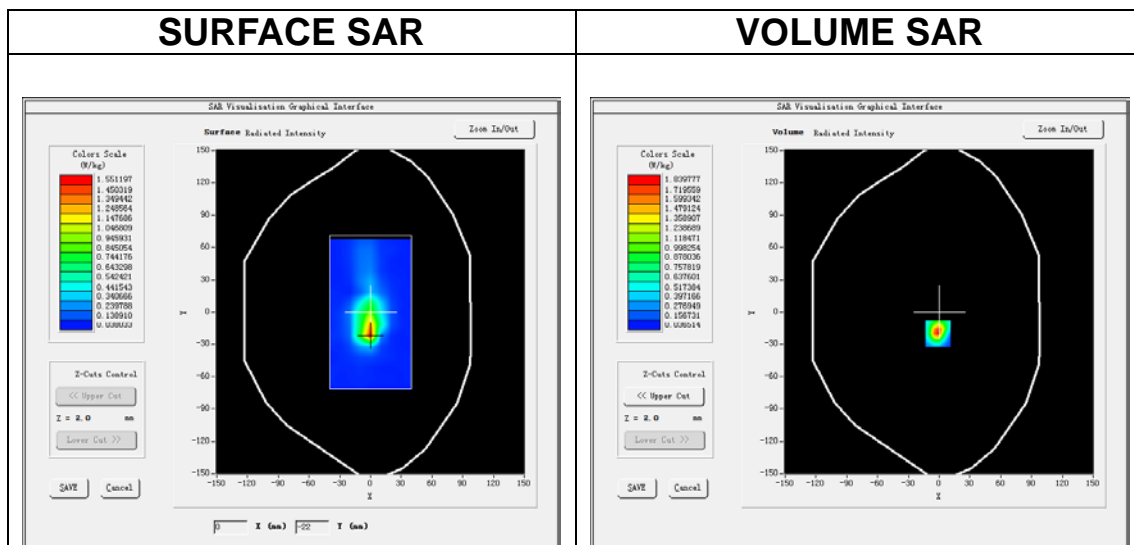

**Maximum location: X=-1.00, Y=-20.00**  
**SAR Peak: 3.34 W/kg**

<b>SAR 10g (W/Kg)</b>	0.324882
<b>SAR 1g (W/Kg)</b>	0.922073

Z (m)	0.00	2.00	4.00	6.00	8.00	10.00	12.00	14.00	16.00	18.00	20.00	22.00
SAR (W/Kg)	3.0776	1.8398	0.9638	0.5213	0.2864	0.1751	0.1256	0.0883	0.0656	0.0536	0.0467	0.0593

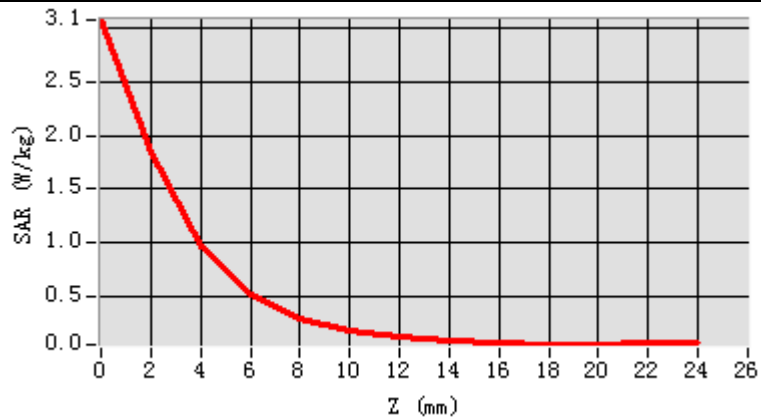

**3D screen shot**

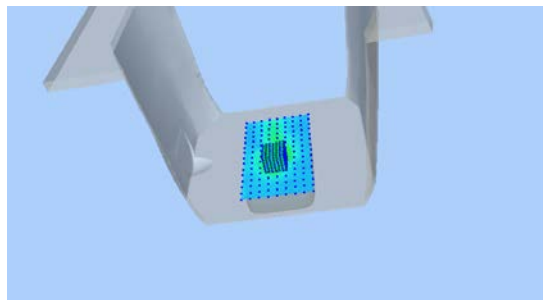

**Hot spot position**

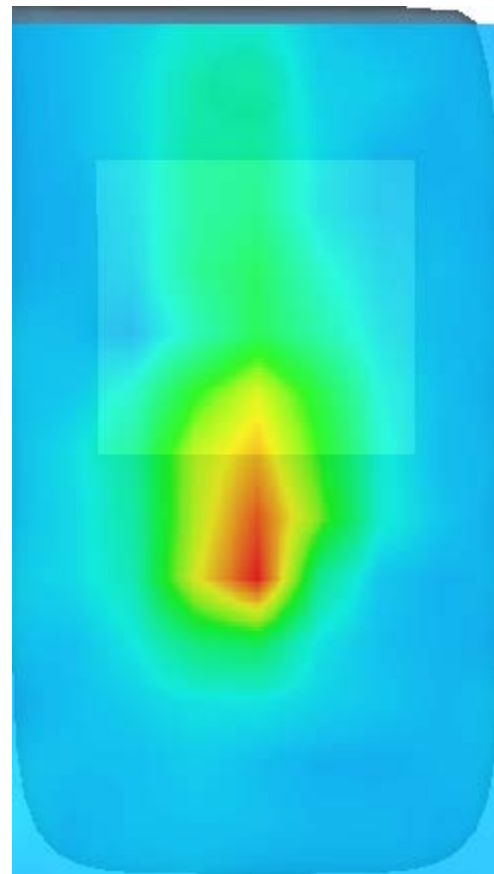



## MEASUREMENT 2

Date of measurement: 4/11/2024

### A. Experimental conditions.

<b>Area Scan</b>	<u>dx=10mm dy=10mm, h= 2.00 mm</u>
<b>ZoomScan</b>	<u>7x7x12,dx=4mm dy=4mm dz=2mm</u>
<b>Phantom</b>	<u>Validation plane</u>
<b>Device Position</b>	<u>Body</u>
<b>Band</b>	<u>IEEE 802.11a U-NII</u>
<b>Channels</b>	<u>Middle</u>
<b>Signal</b>	<u>IEEE802.11a (Crest factor: 1.0)</u>
<b>ConvF</b>	<u>1.88</u>

### B. SAR Measurement Results

<b>Frequency (MHz)</b>	5600.000000
<b>Relative permittivity (real part)</b>	34.643253
<b>Relative permittivity (imaginary part)</b>	16.113609
<b>Conductivity (S/m)</b>	5.013123
<b>Variation (%)</b>	-3.730000

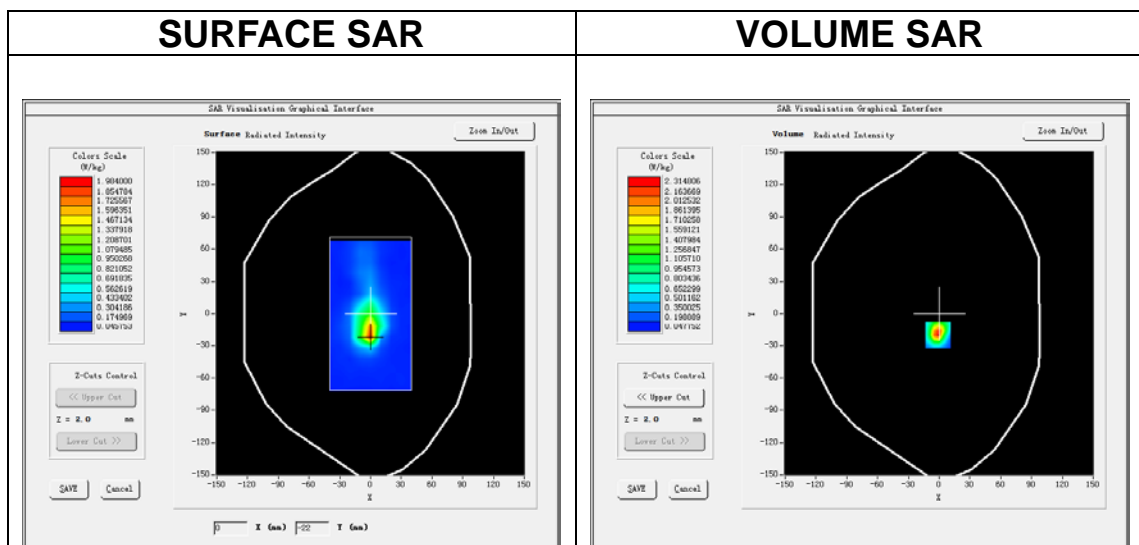

**Maximum location: X=-1.00, Y=-20.00**  
**SAR Peak: 4.29 W/kg**

<b>SAR 10g (W/Kg)</b>	0.411101
<b>SAR 1g (W/Kg)</b>	1.241831

<b>Z (m m)</b>	<b>0.00</b>	<b>2.00</b>	<b>4.00</b>	<b>6.00</b>	<b>8.00</b>	<b>10.0</b>	<b>12.0</b>	<b>14.0</b>	<b>16.0</b>	<b>18.0</b>	<b>20.0</b>	<b>22.0</b>
<b>SAR (W/ Kg)</b>	<b>3.96 01</b>	<b>2.31 48</b>	<b>1.13 81</b>	<b>0.57 50</b>	<b>0.31 59</b>	<b>0.19 05</b>	<b>0.13 66</b>	<b>0.08 87</b>	<b>0.07 45</b>	<b>0.07 28</b>	<b>0.06 79</b>	<b>0.06 30</b>

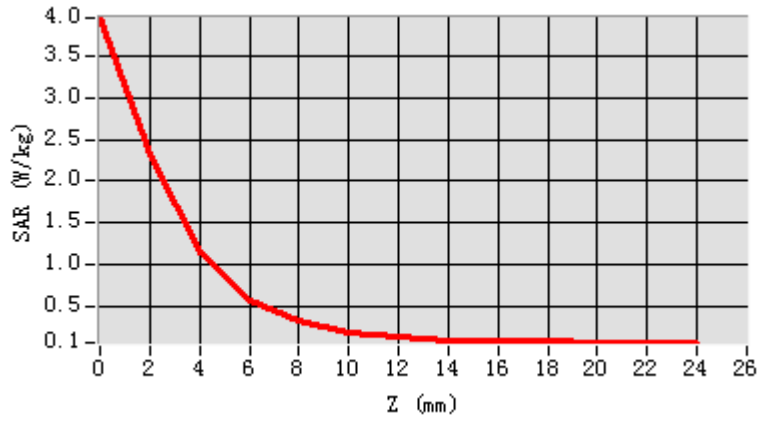

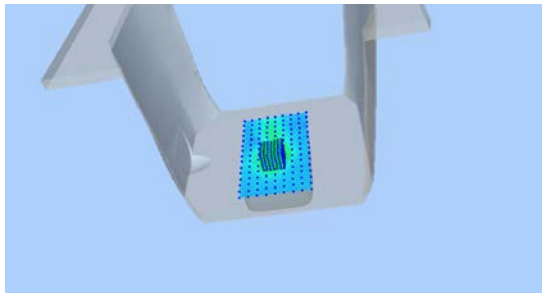
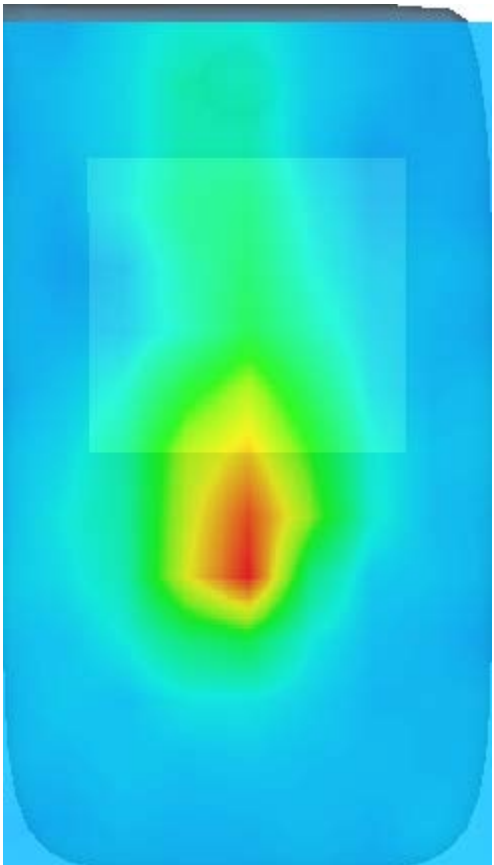
<b>3D screen shot</b>	<b>Hot spot position</b>
	

# MEASUREMENT 3

Date of measurement: 26/10/2024

## A. Experimental conditions.

<b>Area Scan</b>	<u>dx=10mm dy=10mm, h= 2.00 mm</u>
<b>ZoomScan</b>	<u>7x7x12,dx=4mm dy=4mm dz=2mm</u>
<b>Phantom</b>	<u>Validation plane</u>
<b>Device Position</b>	<u>Body</u>
<b>Band</b>	<u>IEEE 802.11a U-NII</u>
<b>Channels</b>	<u>Middle</u>
<b>Signal</b>	<u>IEEE802.11a (Crest factor: 1.0)</u>
<b>ConvF</b>	<u>1.90</u>

## B. SAR Measurement Results

<b>Frequency (MHz)</b>	5775.000000
<b>Relative permittivity (real part)</b>	35.542805
<b>Relative permittivity (imaginary part)</b>	15.840995
<b>Conductivity (S/m)</b>	5.091120
<b>Variation (%)</b>	-0.130000

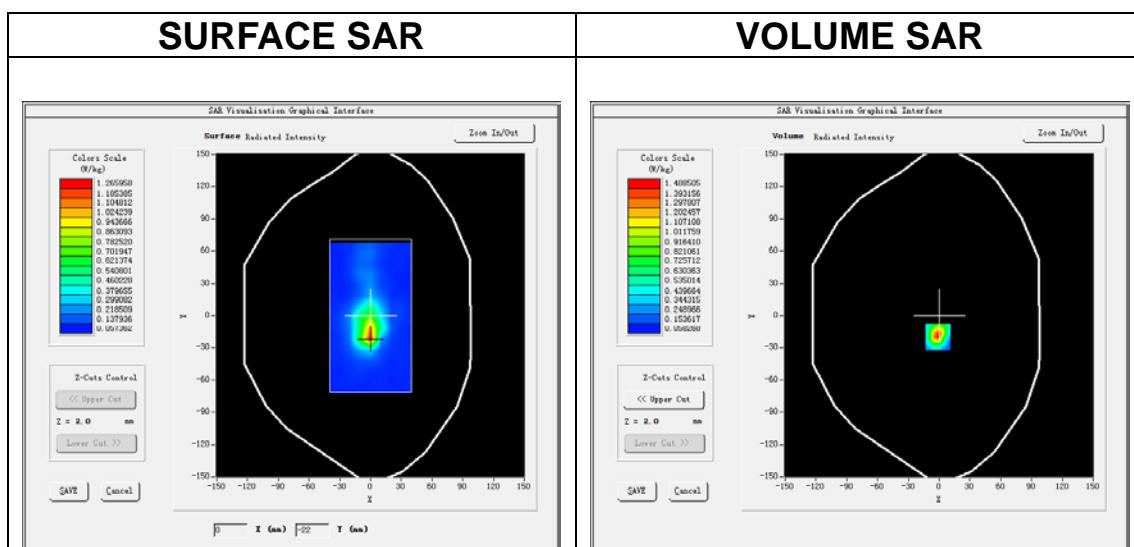

**Maximum location: X=-1.00, Y=-20.00**  
**SAR Peak: 2.76 W/kg**

<b>SAR 10g (W/Kg)</b>	0.284693
<b>SAR 1g (W/Kg)</b>	0.804450

Z (m)	0.00	2.00	4.00	6.00	8.00	10.00	12.00	14.00	16.00	18.00	20.00	22.00
SAR (W/Kg)	2.5422	1.4885	0.7436	0.3886	0.2205	0.1453	0.1046	0.1068	0.0626	0.0803	0.0720	0.0679

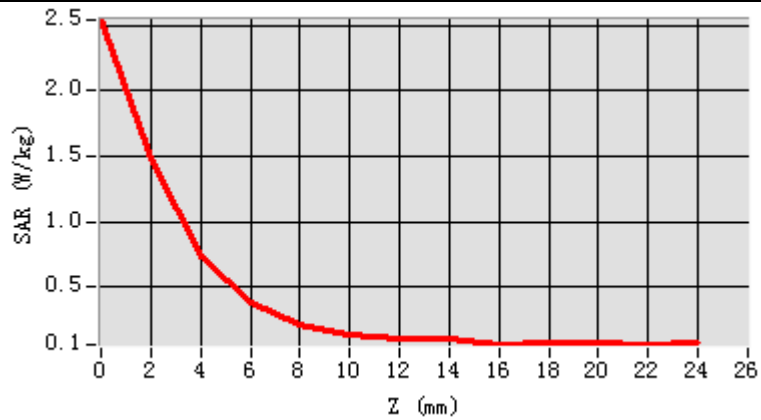

3D screen shot

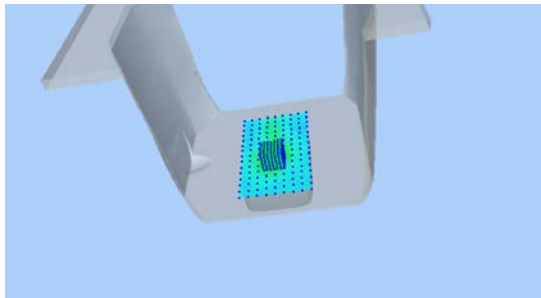

Hot spot position

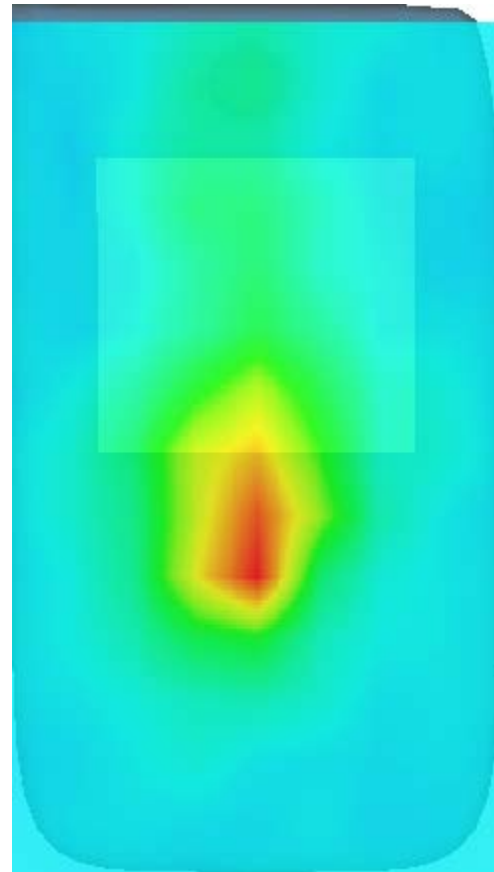

# MEASUREMENT 4

Date of measurement: 5/11/2024

## A. Experimental conditions.

<b>Area Scan</b>	<u>dx=10mm dy=10mm, h= 2.00 mm</u>
<b>ZoomScan</b>	<u>7x7x12,dx=4mm dy=4mm dz=2mm</u>
<b>Phantom</b>	<u>Validation plane</u>
<b>Device Position</b>	<u>Body</u>
<b>Band</b>	<u>IEEE 802.11a U-NII</u>
<b>Channels</b>	<u>High</u>
<b>Signal</b>	<u>IEEE802.11a (Crest factor: 1.0)</u>
<b>ConvF</b>	<u>1.89</u>

## B. SAR Measurement Results

<b>Frequency (MHz)</b>	5210.000000
<b>Relative permittivity (real part)</b>	34.571381
<b>Relative permittivity (imaginary part)</b>	15.807355
<b>Conductivity (S/m)</b>	4.601697
<b>Variation (%)</b>	-0.920000

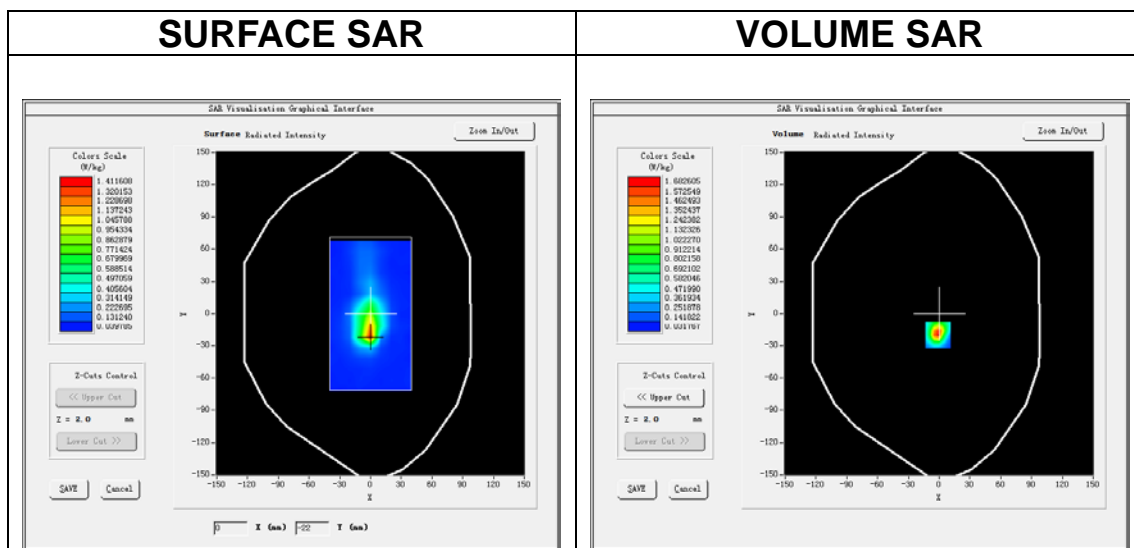

**Maximum location: X=-1.00, Y=-20.00**  
**SAR Peak: 3.03 W/kg**

<b>SAR 10g (W/Kg)</b>	0.266849
<b>SAR 1g (W/Kg)</b>	0.804522

<b>Z (m m)</b>	<b>0.00</b>	<b>2.00</b>	<b>4.00</b>	<b>6.00</b>	<b>8.00</b>	<b>10.0</b>	<b>12.0</b>	<b>14.0</b>	<b>16.0</b>	<b>18.0</b>	<b>20.0</b>	<b>22.0</b>
<b>SAR (W/ Kg)</b>	<b>2.79 02</b>	<b>1.68 26</b>	<b>0.88 66</b>	<b>0.50 15</b>	<b>0.26 87</b>	<b>0.16 87</b>	<b>0.10 93</b>	<b>0.08 78</b>	<b>0.06 86</b>	<b>0.06 17</b>	<b>0.04 66</b>	<b>0.04 49</b>

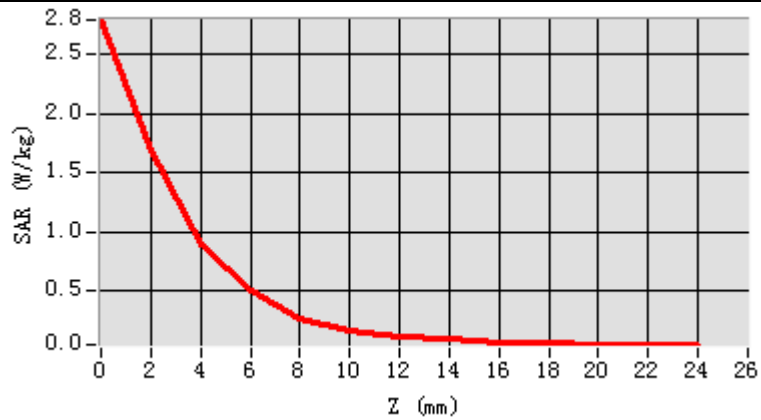

**3D screen shot**

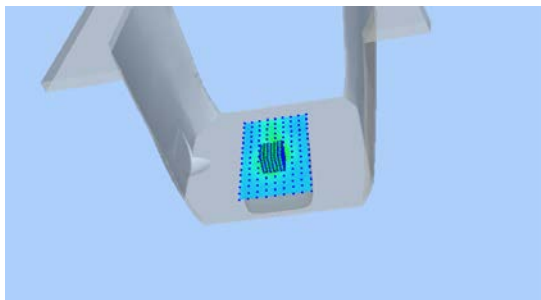

**Hot spot position**

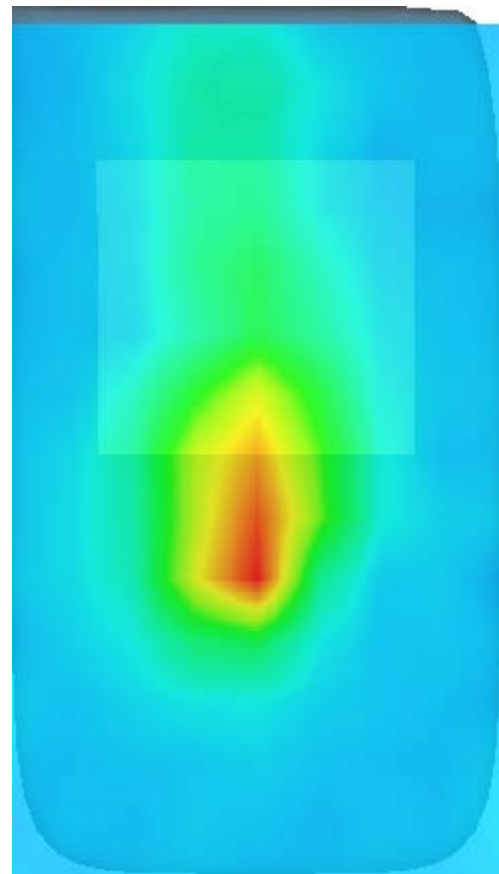

# MEASUREMENT 5

Date of measurement: 3/11/2024

## A. Experimental conditions.

<b>Area Scan</b>	<u>dx=12mm dy=12mm, h= 5.00 mm</u>
<b>ZoomScan</b>	<u>7x7x7,dx=5mm dy=5mm dz=5mm</u>
<b>Phantom</b>	<u>Validation plane</u>
<b>Device Position</b>	<u>Body</u>
<b>Band</b>	<u>IEEE 802.11b ISM</u>
<b>Channels</b>	<u>Middle</u>
<b>Signal</b>	<u>IEEE802.11b (Crest factor: 1.0)</u>
<b>ConvF</b>	<u>2.74</u>

## B. SAR Measurement Results

<b>Frequency (MHz)</b>	2437.000000
<b>Relative permittivity (real part)</b>	37.891087
<b>Relative permittivity (imaginary part)</b>	13.004079
<b>Conductivity (S/m)</b>	1.760608
<b>Variation (%)</b>	-3.810000

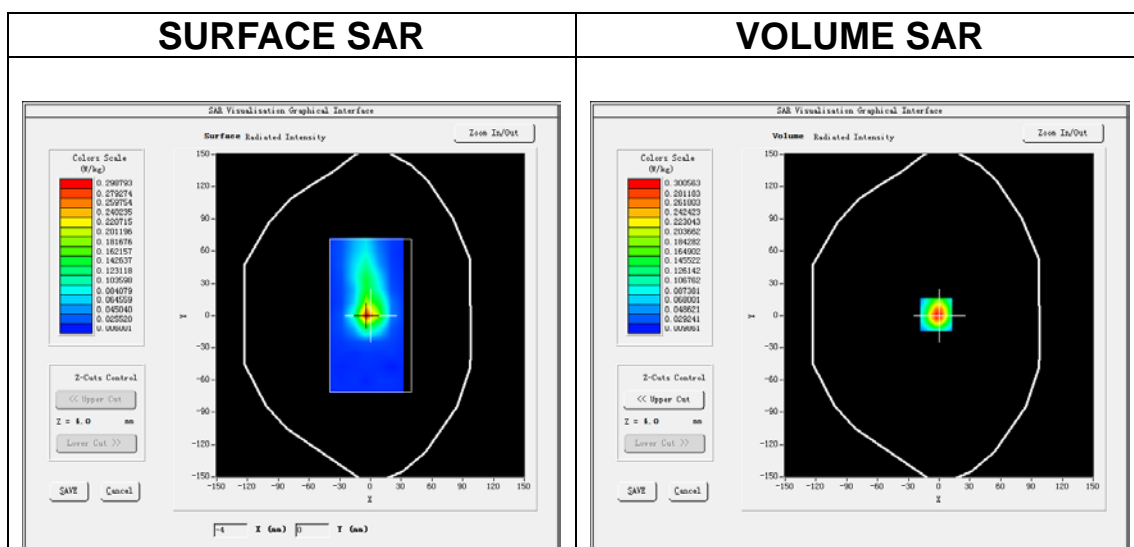

**Maximum location: X=-3.00, Y=1.00**  
**SAR Peak: 0.54 W/kg**

<b>SAR 10g (W/Kg)</b>	0.122612
<b>SAR 1g (W/Kg)</b>	0.278342

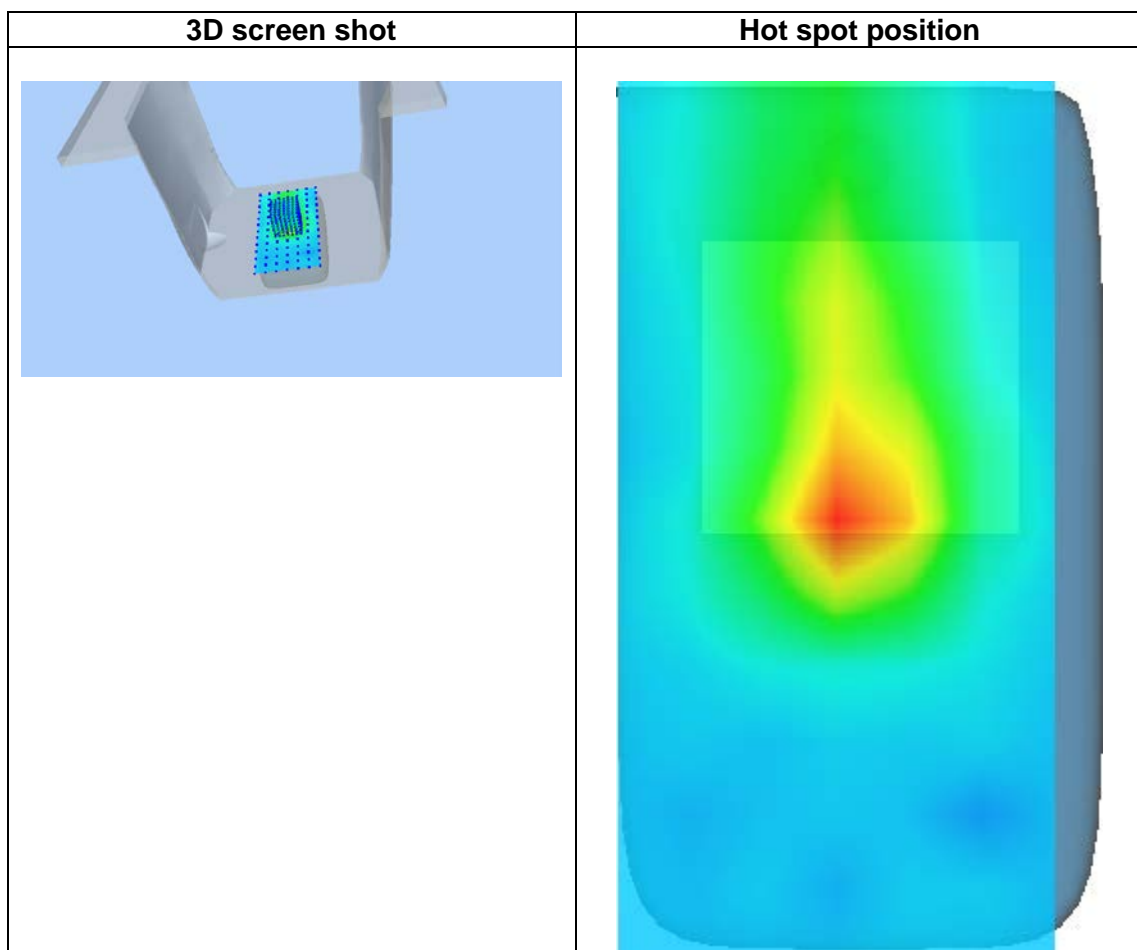
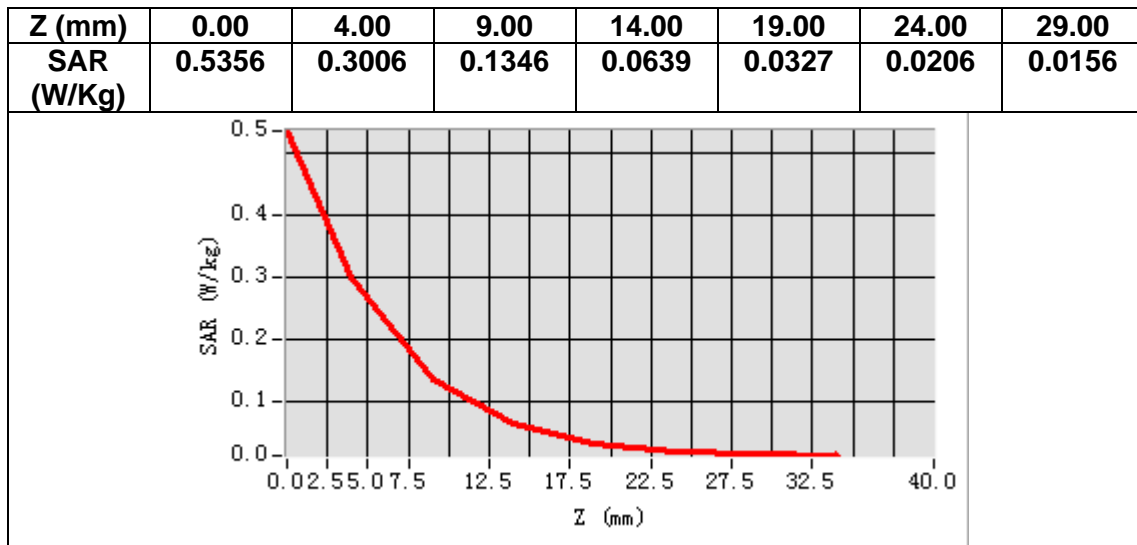



## 14. Appendix D. Calibration Certificate

<b>Table of contents</b>
E Field Probe - 4024-EPGO-442
2450 MHz Dipole - SN 03/15 DIP 2G450-352
5000-6000 MHz Dipole - SN 13/14 WGA 33

Docusign Envelope ID: 223C1A7C-4751-4B95-8502-1618DC0951E3



## COMOSAR E-Field Probe Calibration Report

Ref : ACR.278.12.24.BES.A

### SHENZHEN NTEK TESTING TECHNOLOGY CO., LTD.

BUILDING E, FENDA SCIENCE PARK, SANWEI  
COMMUNITY, XIXIANG STREET,  
BAO'AN DISTRICT, SHENZHEN GUANGDONG, CHINA  
MVG COMOSAR DOSIMETRIC E-FIELD PROBE  
SERIAL NO.: 4024-EPGO-442

Calibrated at MVG

Z.I. de la pointe du diable

Technopôle Brest Iroise – 295 avenue Alexis de Rochon

29280 PLOUZANE - FRANCE

Calibration date: 10/04/2024



Accreditations #2-6789  
Scope available on [www.cofrac.fr](http://www.cofrac.fr)

The use of the Cofrac brand and the accreditation references is prohibited from any reproduction.

#### Summary:



This document presents the method and results from an accredited COMOSAR Dosimetric E-Field Probe calibration performed at MVG, using the CALIPROBE test bench, for use with a MVG COMOSAR system only. The test results covered by accreditation are traceable to the International System of Units (SI).

Docusign Envelope ID: 223C1A7C-4751-4B95-8502-1618DC0951E3



COMOSAR E-FIELD PROBE CALIBRATION REPORT

Ref: ACR.278.12.24.BES.A

	<i>Name</i>	<i>Function</i>	<i>Date</i>	<i>Signature</i>
<i>Prepared by :</i>	Cyrille ONNEE	Measurement Responsible	10/4/2024	
<i>Checked &amp; approved by:</i>	Pedro Ruiz	Technical Manager	10/4/2024	
<i>Authorized by:</i>	Pedro Ruiz	Laboratory Director	10/4/2024	

Assinado por:  
**Pedro RUIZ**  
29093B31C46F42B...

	<i>Customer Name</i>
<i>Distribution :</i>	SHENZHEN NTEK TESTING TECHNOLOGY CO., LTD.

<i>Issue</i>	<i>Name</i>	<i>Date</i>	<i>Modifications</i>
A	Cyrille ONNEE	10/4/2024	Initial release

DocuSign Envelope ID: 223C1A7C-4751-4B95-8502-1618DC0951E3



COMOSAR E-FIELD PROBE CALIBRATION REPORT

Ref. ACR.278.12.24.BES.A

TABLE OF CONTENTS

1	Device Under Test .....	4
2	Product Description .....	4
2.1	General Information .....	4
3	Measurement Method .....	4
3.1	Sensitivity .....	4
3.2	Linearity .....	5
3.3	Isotropy .....	5
3.4	Boundary Effect .....	5
3.5	Probe Modulation Response .....	6
4	Measurement Uncertainty .....	6
5	Calibration Results .....	6
5.1	Calibration in air .....	6
5.2	Calibration in liquid .....	7
6	Verification Results .....	9
7	List of Equipment .....	9

DocuSign Envelope ID: 223C1A7C-4751-4B95-8502-1618DC0951E3



**COMOSAR E-FIELD PROBE CALIBRATION REPORT**

Ref: ACR.278.12.24.BES.A

**1 DEVICE UNDER TEST**

Device Under Test	
Device Type	COMOSAR DOSIMETRIC E FIELD PROBE
Manufacturer	MVG
Model	SSE2
Serial Number	4024-EPGO-442
Product Condition (new / used)	New
Frequency Range of Probe	0.15 GHz-7.5GHz
Resistance of Three Dipoles at Connector	Dipole 1: R1=0.206 MΩ Dipole 2: R2=0.223 MΩ Dipole 3: R3=0.235 MΩ

**2 PRODUCT DESCRIPTION**

**2.1 GENERAL INFORMATION**

MVG’s COMOSAR E field Probes are built in accordance to the IEC/IEEE 62209-1528 and FCC KDB865664 D01 standards.



**Figure 1 – MVG COMOSAR Dosimetric E field Probe**

Probe Length	330 mm
Length of Individual Dipoles	2 mm
Maximum external diameter	8 mm
Probe Tip External Diameter	2.5 mm
Distance between dipoles / probe extremity	1 mm

**3 MEASUREMENT METHOD**

The IEC/IEEE 62209-1528 and FCC KDB865664 D01 standards provide recommended practices for the probe calibrations, including the performance characteristics of interest and methods by which to assess their effect. All calibrations / measurements performed meet the fore-mentioned standards.

**3.1 SENSITIVITY**

The sensitivity factors of the three dipoles were determined using a two step calibration method (air and tissue simulating liquid) using waveguides as outlined in the standards for frequency range 600-7500MHz and using the calorimeter cell method (transfer method) as outlined in the standards for frequency 150-450 MHz.



DocuSign Envelope ID: 223C1A7C-4751-4B95-8502-1618DC0951E3



**COMOSAR E-FIELD PROBE CALIBRATION REPORT**

Ref: ACR.278.12.24.BES.A

**3.2 LINEARITY**

The evaluation of the linearity was done in free space using the waveguide, performing a power sweep to cover the SAR range 0.01W/kg to 100W/kg.

**3.3 ISOTROPY**

The axial isotropy was evaluated by exposing the probe to a reference wave from a standard dipole with the dipole mounted under the flat phantom in the test configuration suggested for system validations and checks. The probe was rotated along its main axis from 0 to 360 degrees in 15-degree steps. The hemispherical isotropy is determined by inserting the probe in a thin plastic box filled with tissue-equivalent liquid, with the plastic box illuminated with the fields from a half wave dipole. The dipole is rotated about its axis (0°–180°) in 15° increments. At each step the probe is rotated about its axis (0°–360°).

**3.4 BOUNDARY EFFECT**

The boundary effect is defined as the deviation between the SAR measured data and the expected exponential decay in the liquid when the probe is oriented normal to the interface. To evaluate this effect, the liquid filled flat phantom is exposed to fields from either a reference dipole or waveguide. With the probe normal to the phantom surface, the peak spatial average SAR is measured and compared to the analytical value at the surface.

The boundary effect uncertainty can be estimated according to the following uncertainty approximation formula based on linear and exponential extrapolations between the surface and  $d_{be} + d_{step}$  along lines that are approximately normal to the surface:

$$SAR_{uncertainty} [\%] = \Delta SAR_{be} \frac{(d_{be} + d_{step})^2}{2d_{step}} \frac{(e^{-d_{be}/\delta/2})^2}{\delta/2} \text{ for } (d_{be} + d_{step}) < 10 \text{ mm}$$

- where
- $SAR_{uncertainty}$  is the uncertainty in percent of the probe boundary effect
- $d_{be}$  is the distance between the surface and the closest *zoom-scan* measurement point, in millimetre
- $\Delta_{step}$  is the separation distance between the first and second measurement points that are closest to the phantom surface, in millimetre, assuming the boundary effect at the second location is negligible
- $\delta$  is the minimum penetration depth in millimetres of the head tissue-equivalent liquids defined in this standard, i.e.,  $\delta \approx 14 \text{ mm}$  at 3 GHz;
- $\Delta SAR_{be}$  in percent of SAR is the deviation between the measured SAR value, at the distance  $d_{be}$  from the boundary, and the analytical SAR value.

The measured worst case boundary effect SARuncertainty[%] for scanning distances larger than 4mm is 1.0% Limit ,2%).

DocuSign Envelope ID: 223C1A7C-4751-4B95-8502-1618DC0951E3



COMOSAR E-FIELD PROBE CALIBRATION REPORT

Ref: ACR.278.12.24.BES.A

3.5 PROBE MODULATION RESPONSE

MVG's probe were evaluated experimentally with various modulated signal and the deviation from CW response were found neglectable in the used power range of the probe. So the correction to taking into account the linearization parameters for different modulation is null, therefore the CW factor given in this report can be used whatever the measured modulation

4 MEASUREMENT UNCERTAINTY

The guidelines outlined in the IEC/IEEE 62209-1528 and FCC KDB865664 D01 standards were followed to generate the measurement uncertainty associated with a SAR probe calibration using the waveguide or calorimetric cell technique depending on the frequency.

The estimated expanded uncertainty (k=2) in calibration for SAR (W/kg) is +/-11% for the frequency range 150-450MHz.

The estimated expanded uncertainty (k=2) in calibration for SAR (W/kg) is +/-14% for the frequency range 600-7500MHz.

5 CALIBRATION RESULTS

Ambient condition	
Liquid Temperature	20 +/- 1 °C
Lab Temperature	20 +/- 1 °C
Lab Humidity	30-70 %

5.1 CALIBRATION IN AIR

The following curve represents the measurement in waveguide of the voltage picked up by the probe toward the E-field generated inside the waveguide.

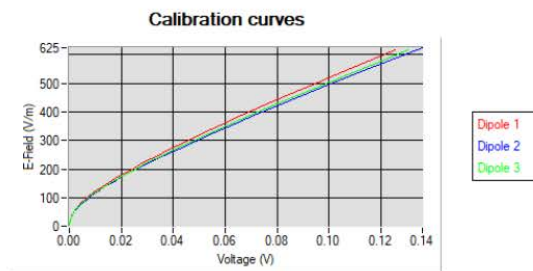

From this curve, the sensitivity in air is calculated using the below formula.

$$E^2 = \sum_{i=1}^3 \frac{V_i (1 + V_i / DCP_i)}{Norm_i}$$

Page: 6/10

Template ACR.DDD.N.YY.MVGB.ISSUE COMOSAR Probe vM

This document shall not be reproduced, except in full or in part, without the written approval of MVG. The information contained herein is to be used only for the purpose for which it is submitted and is not to be released in whole or part without written approval of MVG.

Docusign Envelope ID: 223C1A7C-4751-4B95-8502-1618DC0951E3



COMOSAR E-FIELD PROBE CALIBRATION REPORT

Ref: ACR.278.12.24.BES.A

where

Vi=voltage readings on the 3 channels of the probe

DCPi=diode compression point given below for the 3 channels of the probe

Normi=dipole sensitivity given below for the 3 channels of the probe

Normx dipole 1 ( $\mu\text{V}/(\text{V}/\text{m})^2$ )	Normy dipole 2 ( $\mu\text{V}/(\text{V}/\text{m})^2$ )	Normz dipole 3 ( $\mu\text{V}/(\text{V}/\text{m})^2$ )
0.73	0.79	0.78

DCP dipole 1 (mV)	DCP dipole 2 (mV)	DCP dipole 3 (mV)
105	109	103

5.2 CALIBRATION IN LIQUID

The calorimeter cell or the waveguide is used to determine the calibration in liquid using the formula below.

$$ConvF = \frac{E_{liquid}^2}{E_{air}^2}$$

The E-field in the liquid is determined from the SAR measurement according to the below formula.

$$E_{liquid}^2 = \frac{\rho SAR}{\sigma}$$

where

$\sigma$ =the conductivity of the liquid

$\rho$ =the volumetric density of the liquid

SAR=the SAR measured from the formula that depends on the setup used. The SAR formulas are given below

For the calorimeter cell (150-450 MHz), the formula is:

$$SAR = c \frac{dT}{dt}$$

where

c=the specific heat for the liquid

dT/dt=the temperature rises over the time

For the waveguide setup (600-75000 MHz), the formula is:

$$SAR = \frac{4PW}{ab\delta} e^{-\frac{2z}{\delta}}$$

Page: 7/10

Template\_ACR.DDD.N.YY.MVGB.ISSUE\_COMOSAR Probe vM

This document shall not be reproduced, except in full or in part, without the written approval of MVG. The information contained herein is to be used only for the purpose for which it is submitted and is not to be released in whole or part without written approval of MVG.



DocuSign Envelope ID: 223C1A7C-4751-4B95-8502-1618DC0951E3



**COMOSAR E-FIELD PROBE CALIBRATION REPORT**

Ref: ACR.278.12.24.BES.A

where

- a=the larger cross-sectional of the waveguide
- b=the smaller cross-sectional of the waveguide
- $\delta$ =the skin depth for the liquid in the waveguide
- Pw=the power delivered to the liquid

The below table summarize the ConvF for the calibrated liquid. The curves give examples for the measured SAR depending on the voltage in some liquid.

Liquid	Frequency (MHz*)	ConvF
HL750	750	2.42
HL850	835	2.34
HL900	900	2.24
HL1800	1800	2.51
HL1900	1900	2.57
HL2000	2000	2.64
HL2300	2300	2.73
HL2450	2450	2.74
HL2600	2600	2.51
HL3300	3300	2.11
HL3500	3500	2.15
HL3700	3700	2.08
HL3900	3900	2.27
HL4200	4200	2.39
HL4600	4600	2.30
HL4900	4900	2.13
HL5200	5200	1.89
HL5400	5400	1.97
HL5600	5600	1.88
HL5800	5800	1.90

(\*) Frequency validity is +/-50MHz below 600MHz, +/-100MHz from 600MHz to 6GHz and +/-700MHz above 6GHz

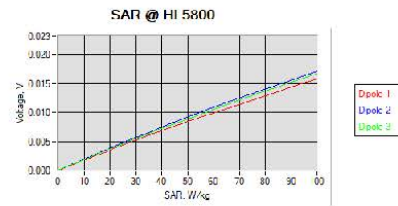
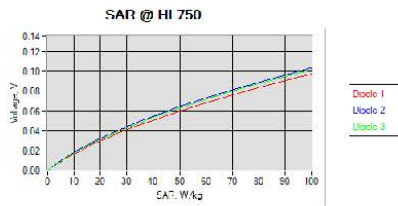

DocuSign Envelope ID: 223C1A7C-4751-4B95-8502-1618DC0951E3



COMOSAR E-FIELD PROBE CALIBRATION REPORT

Ref. ACR.278.12.24.BES.A

6 VERIFICATION RESULTS

The figures below represent the measured linearity and axial isotropy for this probe. The probe specification is +/-0.2 dB for linearity and +/-0.15 dB for axial isotropy.

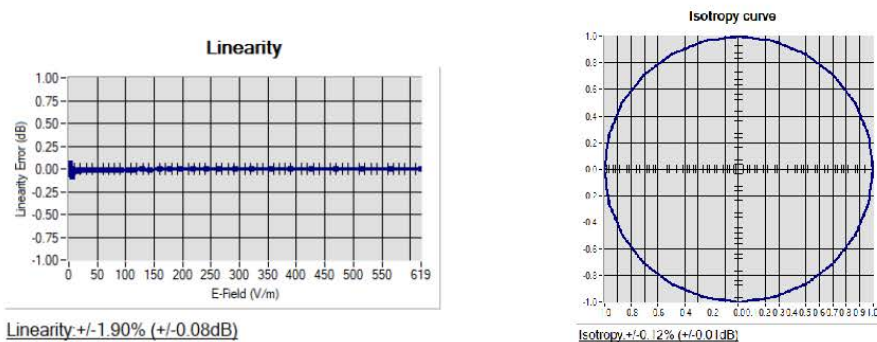

7 LIST OF EQUIPMENT

Equipment Summary Sheet				
Equipment Description	Manufacturer / Model	Identification No.	Current Calibration Date	Next Calibration Date
CALIPROBE Test Bench	Version 2	NA	Validated. No cal required.	Validated. No cal required.
Network Analyzer	Rohde & Schwarz ZVM	100203	08/2021	08/2026
Network Analyzer – Calibration kit	Rohde & Schwarz ZV-Z235	101223	07/2022	07/2025
Multimeter	Keithley 2000	4013982	02/2023	02/2026
Signal Generator	Rohde & Schwarz SMB	106589	03/2022	03/2025
Amplifier	MVG	MODU-023-C-0002	Characterized prior to test. No cal required.	Characterized prior to test. No cal required.
Power Meter	NI-USB 5680	170100013	06/2021	06/2026
USB Sensor	Keysight U2000A	SN: MY62340002	10/2022	10/2025
Directional Coupler	Krytar 158020	131467	Characterized prior to test. No cal required.	Characterized prior to test. No cal required.
Fluoroptic Thermometer	LumaSense Luxtron 812	94264	09/2022	09/2025
Coaxial cell	MVG	SN 32/16 COAXCELL_1	Validated. No cal required.	Validated. No cal required.

Page: 9/10

Template ACR.DDD.N.YY.MVGB.ISSUE COMOSAR Probe vM

This document shall not be reproduced, except in full or in part, without the written approval of MVG. The information contained herein is to be used only for the purpose for which it is submitted and is not to be released in whole or part without written approval of MVG.

DocuSign Envelope ID: 223C1A7C-4751-4B95-8502-1618DC0951E3



COMOSAR E-FIELD PROBE CALIBRATION REPORT

Ref: ACR.278.12.24.BES.A

Waveguide	MVG	SN 32/16 WG2_1	Validated. No cal required.	Validated. No cal required.
Liquid transition	MVG	SN 32/16 WGLIQ_0G600_1	Validated. No cal required.	Validated. No cal required.
Waveguide	MVG	SN 32/16 WG4_1	Validated. No cal required.	Validated. No cal required.
Liquid transition	MVG	SN 32/16 WGLIQ_0G900_1	Validated. No cal required.	Validated. No cal required.
Waveguide	MVG	SN 32/16 WG6_1	Validated. No cal required.	Validated. No cal required.
Liquid transition	MVG	SN 32/16 WGLIQ_1G500_1	Validated. No cal required.	Validated. No cal required.
Waveguide	MVG	SN 32/16 WG8_1	Validated. No cal required.	Validated. No cal required.
Liquid transition	MVG	SN 32/16 WGLIQ_1G800B_1	Validated. No cal required.	Validated. No cal required.
Liquid transition	MVG	SN 32/16 WGLIQ_1G800H_1	Validated. No cal required.	Validated. No cal required.
Waveguide	MVG	SN 32/16 WG10_1	Validated. No cal required.	Validated. No cal required.
Liquid transition	MVG	SN 32/16 WGLIQ_3G500_1	Validated. No cal required.	Validated. No cal required.
Waveguide	MVG	SN 32/16 WG12_1	Validated. No cal required.	Validated. No cal required.
Liquid transition	MVG	SN 32/16 WGLIQ_5G000_1	Validated. No cal required.	Validated. No cal required.
Waveguide	MVG	SN 32/16 WG14_1	Validated. No cal required.	Validated. No cal required.
Liquid transition	MVG	SN 32/16 WGLIQ_7G000_1	Validated. No cal required.	Validated. No cal required.
Temperature / Humidity Sensor	Testo 184 H1	44235403	02/2024	02/2027



## SAR Reference Dipole Calibration Report

Ref : ACR.53.29.24.BES.A

**SHENZHEN NTEK TESTING TECHNOLOGY  
CO., LTD.**

**BUILDING E, FENDA SCIENCE PARK, SANWEI  
COMMUNITY, XIXIANG STREET,  
BAO'AN DISTRICT, SHENZHEN GUANGDONG, CHINA  
MVG COMOSAR REFERENCE DIPOLE**

**FREQUENCY: 2450 MHZ**

**SERIAL NO.: SN 03/15DIP2G450-352**

**Calibrated at MVG**

**Z.I. de la pointe du diable**

**Technopôle Brest Iroise – 295 avenue Alexis de Rochon**

**29280 PLOUZANE - FRANCE**

**Calibration date: 02/21/2024**



Accreditations #2-6789 and #2-6814  
Scope available on [www.cofrac.fr](http://www.cofrac.fr)

**The use of the Cofrac brand and the accreditation references is prohibited from any reproduction.**



### *Summary:*

This document presents the method and results from an accredited SAR reference dipole calibration performed in MVG using the COMOSAR test bench. All calibration results are traceable to national metrology institutions.



SAR REFERENCE DIPOLE CALIBRATION REPORT

Ref : ACR.53.29.24.BES.A

	<i>Name</i>	<i>Function</i>	<i>Date</i>	<i>Signature</i>
<i>Prepared by :</i>	Pedro Ruiz	Measurement Responsible	2/22/2024	
<i>Checked &amp; approved by:</i>	Jérôme Luc	Technical Manager	2/22/2024	
<i>Authorized by:</i>	Yann Toutain	Laboratory Director	2/27/2024	

Yann  
Toutain ID  Signature numérique de Yann Toutain ID  
Date : 2024.02.27 08:57:39 +01'00'

	<i>Customer Name</i>
<i>Distribution :</i>	SHENZHEN NTEK TESTING TECHNOLOGY CO., LTD.

<i>Issue</i>	<i>Name</i>	<i>Date</i>	<i>Modifications</i>
A	Pedro Ruiz	2/22/2024	Initial release





SAR REFERENCE DIPOLE CALIBRATION REPORT

Ref : ACR.53.29.24.BES.A

TABLE OF CONTENTS

1	Introduction.....	4
2	Device Under Test .....	4
3	Product Description .....	4
3.1	General Information .....	4
4	Measurement Method .....	5
4.1	Mechanical Requirements .....	5
4.2	S11 parameter Requirements .....	5
4.3	SAR Requirements .....	5
5	Measurement Uncertainty .....	5
5.1	Mechanical dimensions .....	5
5.2	S11 Parameter .....	5
5.3	SAR .....	5
6	Calibration Results.....	6
6.1	Mechanical Dimensions .....	6
6.2	S11 parameter .....	6
6.3	SAR .....	6
7	List of Equipment .....	8



SAR REFERENCE DIPOLE CALIBRATION REPORT

Ref : ACR.53.29.24.BES.A

**1 INTRODUCTION**

This document contains a summary of the requirements set forth by the IEC/IEEE 62209-1528 and FCC KDB865664 D01 standards for reference dipoles used for SAR measurement system validations and the measurements that were performed to verify that the product complies with the fore mentioned standards.

**2 DEVICE UNDER TEST**

Device Under Test	
Device Type	COMOSAR 2450 MHz REFERENCE DIPOLE
Manufacturer	MVG
Model	SID2450
Serial Number	SN 03/15DIP2G450-352
Product Condition (new / used)	Used

**3 PRODUCT DESCRIPTION**

**3.1 GENERAL INFORMATION**

MVG’s COMOSAR Validation Dipoles are built in accordance to the IEC/IEEE 62209-1528 and FCC KDB865664 D01 standards. The product is designed for use with the COMOSAR test bench only.



**Figure 1 – MVG COMOSAR Validation Dipole**



## 4 MEASUREMENT METHOD

### 4.1 MECHANICAL REQUIREMENTS

The IEC/IEEE 62209-1528 and FCC KDB865664 D01 standards specify the mechanical components and dimensions of the validation dipoles, with the dimension's frequency and phantom shell thickness dependent. The COMOSAR test bench employs a 2 mm phantom shell thickness therefore the dipoles sold for use with the COMOSAR test bench comply with the requirements set forth for a 2 mm phantom shell thickness. A direct method is used with a ISO17025 calibrated caliper.

### 4.2 S11 PARAMETER REQUIREMENTS

The dipole used for SAR system validation measurements and checks must have a S11 of -20 dB or better. The S11 measurement shall be performed against a liquid filled flat phantom, with the phantom constructed as outlined in the fore mentioned standards. A direct method is used with a network analyser and its calibration kit, both with a valid ISO17025 calibration.

### 4.3 SAR REQUIREMENTS

The IEC/IEEE 62209-1528 and FCC KDB865664 D01 standards provide requirements for reference dipoles used for system validation measurements. The following measurements were performed to verify that the product complies with the fore-mentioned standards.

## 5 MEASUREMENT UNCERTAINTY

### 5.1 MECHANICAL DIMENSIONS

For the measurement in the range 0-300mm, the estimated expanded uncertainty (k=2) in calibration for the dimension measurement in mm is +/-0.20 mm with respect to measurement conditions.

For the measurement in the range 300-450mm, the estimated expanded uncertainty (k=2) in calibration for the dimension measurement in mm is +/-0.44 mm with respect to measurement conditions.

### 5.2 S11 PARAMETER

The estimated expanded uncertainty (k=2) in calibration for the S11 parameter in linear is +/-0.08 with respect to measurement conditions.

### 5.3 SAR

The guidelines outlined in the IEC/IEEE 62209-1528 and FCC KDB865664 D01 standards were followed to generate the measurement uncertainty for validation measurements.

The estimated expanded uncertainty (k=2) in calibration for the 1g and 10g SAR measurement in W/kg is +/-19% with respect to measurement conditions.





**SAR REFERENCE DIPOLE CALIBRATION REPORT**

Ref : ACR.53.29.24.BES.A

**6 CALIBRATION RESULTS**

**6.1 MECHANICAL DIMENSIONS**

L mm		h mm		d mm	
Measured	Required	Measured	Required	Measured	Required
-	51.50 +/- 2%	-	30.40 +/- 2%	-	3.60 +/- 2%

**6.2 S11 PARAMETER**

**6.2.1 S11 parameter in Head Liquid**

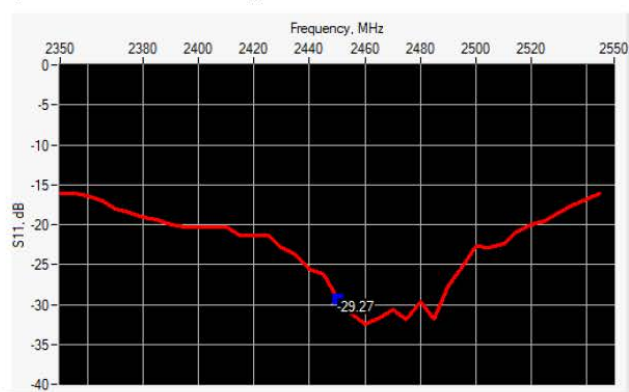

Frequency (MHz)	S11 parameter (dB)	Requirement (dB)	Impedance
2450	-29.27	-20	53.6Ω + 0.1jΩ

**6.3 SAR**

The IEC/IEEE 62209-1528 and FCC KDB865664 D01 standards state that the system validation measurements must be performed using a reference dipole meeting the fore mentioned return loss and mechanical dimension requirements. The validation measurement must be performed against a liquid filled flat phantom, with the phantom constructed as outlined in the fore mentioned standards. Per the standards, the dipole shall be positioned below the bottom of the phantom, with the dipole length centered and parallel to the longest dimension of the flat phantom, with the top surface of the dipole at the described distance from the bottom surface of the phantom.

**6.3.1 SAR with Head Liquid**

The IEC/IEEE 62209-1528 and FCC KDB865664 D01 standards state that the system validation measurements should produce the SAR values shown below (for phantom thickness of 2 mm), within the uncertainty for the system validation. All SAR values are normalized to 1 W forward power. In bracket, the measured SAR is given with the used input power.



SAR REFERENCE DIPOLE CALIBRATION REPORT

Ref : ACR.53.29.24.BES.A

Software	OPENSAR V5
Phantom	SN 13/09 SAM68
Probe	3523-EPGO-429
Liquid	Head Liquid Values: eps' : 42.1 sigma : 1.83
Distance between dipole center and liquid	10.0 mm
Area scan resolution	dx=8mm/dy=8mm
Zoon Scan Resolution	dx=5mm/dy=5mm/dz=5mm
Frequency	2450 MHz
Input power	20 dBm
Liquid Temperature	20 +/- 1 °C
Lab Temperature	20 +/- 1 °C
Lab Humidity	30-70 %

Frequency	1g SAR (W/kg)			10g SAR (W/kg)		
	Measured	Measured normalized to 1W	Target normalized to 1W	Measured	Measured normalized to 1W	Target normalized to 1W
2450 MHz	5.00	50.05	52.40	2.38	23.80	24.00

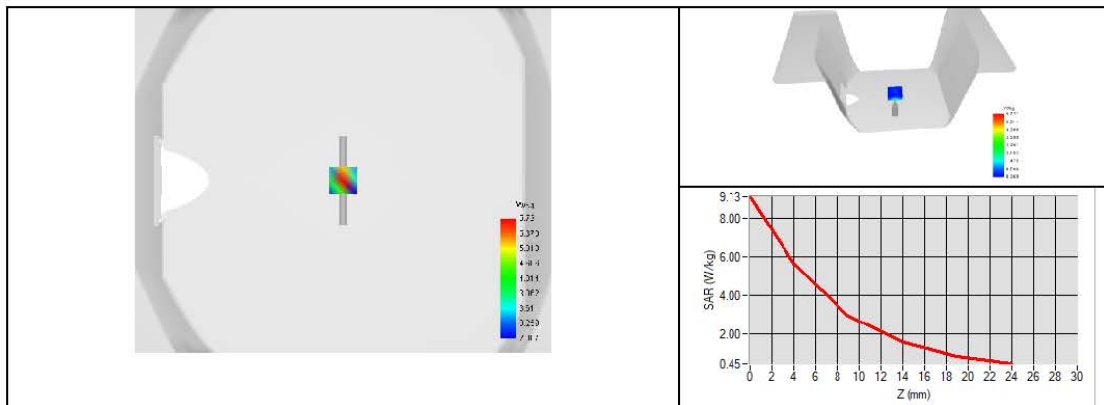



SAR REFERENCE DIPOLE CALIBRATION REPORT

Ref : ACR.53.29.24.BES.A

7 LIST OF EQUIPMENT

Equipment Summary Sheet				
Equipment Description	Manufacturer / Model	Identification No.	Current Calibration Date	Next Calibration Date
SAM Phantom	MVG	SN 13/09 SAM68	Validated. No cal required.	Validated. No cal required.
COMOSAR Test Bench	Version 3	NA	Validated. No cal required.	Validated. No cal required.
Network Analyzer	Rohde & Schwarz ZVM	100203	08/2021	08/2024
Network Analyzer – Calibration kit	Rohde & Schwarz ZV-Z235	101223	07/2022	07/2025
Calipers	Mitutoyo	SN 0009732	11/2022	11/2025
Reference Probe	MVG	3523-EPGO-429	11/2023	11/2024
Multimeter	Keithley 2000	4013982	02/2023	02/2026
Signal Generator	Rohde & Schwarz SMB	106589	03/2022	03/2025
Amplifier	MVG	MODU-023-C-0002	Characterized prior to test. No cal required.	Characterized prior to test. No cal required.
Power Meter	NI-USB 5680	170100013	06/2021	06/2024
Power Meter	Keysight U2000A	SN: MY62340002	10/2022	10/2025
Directional Coupler	Krytar 158020	131467	Characterized prior to test. No cal required.	Characterized prior to test. No cal required.
Temperature / Humidity Sensor	Testo 184 H1	44225320	06/2021	06/2024