

---

# SAR Test Report

---

Report No.: AGC02762220910FH01

**FCC ID** : 2AL26-K7

**APPLICATION PURPOSE** : Original Equipment

**PRODUCT DESIGNATION** : Body Worn Camera

**BRAND NAME** : Reveal Media

**MODEL NAME** : K7

**APPLICANT** : Reveal Media Limited

**DATE OF ISSUE** : Oct. 25,2022

**STANDARD(S)** : IEEE Std. 1528:2013  
FCC 47 CFR Part 2§2.1093  
IEEE Std C95.1™-2005  
IEC 62209-1: 2016

**REPORT VERSION** : V1.0

Attestation of Global Compliance (Shenzhen) Co., Ltd.



Any report having not been signed by authorized approver, or having been altered without authorization, or having not been stamped by the "Dedicated Testing/Inspection Stamp" is deemed to be invalid. Copying or excerpting portion of, or altering the content of the report is not permitted without the written authorization of AGC. The test results presented in the report apply only to the tested sample. Any objections to report issued by AGC should be submitted to AGC within 15days after the issuance of the test report. Further enquiry of validity or verification of the test report should be addressed to AGC by [agc01@agccert.com](mailto:agc01@agccert.com).

Attestation of Global Compliance(Shenzhen)Co., Ltd  
Attestation of Global Compliance(Shenzhen)Std & Tech Co., Ltd  
Tel: +86-755 2523 4088 E-mail: [agc@agccert.com](mailto:agc@agccert.com) Web: <http://www.agccert.com/>



### Report Revise Record

Report Version	Revise Time	Issued Date	Valid Version	Notes
V1.0	/	Oct. 25,2022	Valid	Initial Release

Any report having not been signed by authorized approver, or having been altered without authorization, or having not been stamped by the "Dedicated Testing/Inspection Stamp" is deemed to be invalid. Copying or excerpting portion of, or altering the content of the report is not permitted without the written authorization of AGC. The test results presented in the report apply only to the tested sample. Any objections to report issued by AGC should be submitted to AGC within 15days after the issuance of the test report. Further enquiry of validity or verification of the test report should be addressed to AGC by [agc01@agccert.com](mailto:agc01@agccert.com).

Test Report	
Applicant Name	Reveal Media Limited
Applicant Address	Riverview House, 20 Old Bridge Street, Hampton Wick, KT1 4BU, United Kingdom
Manufacturer Name	Reveal Media Hong Kong Ltd.
Manufacturer Address	6/F.,Luk Kwok Centre, 72 Gloucester Road, Wan Chai, HongKong
Factory Name	Reveal Media Hong Kong Ltd.
Factory Address	6/F.,Luk Kwok Centre, 72 Gloucester Road, Wan Chai, HongKong
Product Designation	Body Worn Camera
Brand Name	Reveal Media
Model Name	K7
EUT Voltage	DC3.8V by battery
Applicable Standard	IEEE Std. 1528:2013 FCC 47 CFR Part 2§2.1093 IEEE Std C95.1™-2005 IEC 62209-1: 2016
Date of receipt of test item	Sep. 20, 2022
Test Date	Oct. 16,2022 to Oct. 20,2022
Report Template	AGCRT-US-4G/SAR (2021-04-20)

Note: The results of testing in this report apply to the product/system which was tested only.

*Jack Gui*

Prepared By \_\_\_\_\_  
Jack Gui (Project Engineer) Oct. 20,2022

*Calvin Liu*

Reviewed By \_\_\_\_\_  
Calvin Liu (Reviewer) Oct. 25,2022

*Max Zhang*

Approved By \_\_\_\_\_  
Max Zhang (Authorized Officer) Oct. 25,2022

Any report having not been signed by authorized approver, or having been altered without authorization, or having not been stamped by the "Dedicated Testing/Inspection Stamp" is deemed to be invalid. Copying or excerpting portion of, or altering the content of the report is not permitted without the written authorization of AGC. The test results presented in the report apply only to the tested sample. Any objections to report issued by AGC should be submitted to AGC within 15days after the issuance of the test report. Further enquiry of validity or verification of the test report should be addressed to AGC by agc01@agccert.com.

## TABLE OF CONTENTS

<b>1. SUMMARY OF MAXIMUM SAR VALUE .....</b>	<b>5</b>
<b>2. GENERAL INFORMATION.....</b>	<b>6</b>
2.1. EUT DESCRIPTION.....	6
<b>3. SAR MEASUREMENT SYSTEM.....</b>	<b>8</b>
3.1. THE SATIMO SYSTEM USED FOR PERFORMING COMPLIANCE TESTS CONSISTS OF FOLLOWING ITEMS .....	8
3.2. COMOSAR E-FIELD PROBE .....	9
3.3. ROBOT.....	9
3.4. VIDEO POSITIONING SYSTEM .....	10
3.5. DEVICE HOLDER .....	10
3.6. SAM TWIN PHANTOM.....	11
<b>4. SAR MEASUREMENT PROCEDURE.....</b>	<b>12</b>
4.1. SPECIFIC ABSORPTION RATE (SAR).....	12
4.2. SAR MEASUREMENT PROCEDURE .....	13
4.3. RF EXPOSURE CONDITIONS .....	15
<b>5. TISSUE SIMULATING LIQUID.....</b>	<b>16</b>
5.1. THE COMPOSITION OF THE TISSUE SIMULATING LIQUID.....	16
5.2. TISSUE DIELECTRIC PARAMETERS FOR HEAD AND BODY PHANTOMS .....	17
5.3. TISSUE CALIBRATION RESULT .....	18
<b>6. SAR SYSTEM CHECK PROCEDURE .....</b>	<b>20</b>
6.1. SAR SYSTEM CHECK PROCEDURES .....	20
6.2. SAR SYSTEM CHECK.....	21
<b>7. EUT TEST POSITION.....</b>	<b>23</b>
7.1. BODY WORN POSITION .....	23
<b>8. SAR EXPOSURE LIMITS .....</b>	<b>24</b>
<b>9. TEST FACILITY .....</b>	<b>25</b>
<b>10. TEST EQUIPMENT LIST .....</b>	<b>26</b>
<b>11. MEASUREMENT UNCERTAINTY .....</b>	<b>27</b>
<b>12. CONDUCTED POWER MEASUREMENT.....</b>	<b>30</b>
<b>13. TEST RESULTS.....</b>	<b>46</b>
13.1. SAR TEST RESULTS SUMMARY.....	46
<b>APPENDIX A. SAR SYSTEM CHECK DATA .....</b>	<b>61</b>
<b>APPENDIX B. SAR MEASUREMENT DATA .....</b>	<b>73</b>
<b>APPENDIX C. TEST SETUP PHOTOGRAPHS.....</b>	<b>91</b>
<b>APPENDIX D. CALIBRATION DATA .....</b>	<b>95</b>

Any report having not been signed by authorized approver, or having been altered without authorization, or having not been stamped by the "Dedicated Testing/Inspection Stamp" is deemed to be invalid. Copying or excerpting portion of, or altering the content of the report is not permitted without the written authorization of AGC. The test results presented in the report apply only to the tested sample. Any objections to report issued by AGC should be submitted to AGC within 15days after the issuance of the test report. Further enquiry of validity or verification of the test report should be addressed to AGC by agc01@agccert.com.

## 1. SUMMARY OF MAXIMUM SAR VALUE

The maximum results of Specific Absorption Rate (SAR) found during testing for EUT are as follows:

Frequency Band	Highest Reported 1g-SAR(W/kg)		SAR Test Limit (W/kg)
	Body-worn(with 0mm separation)	Hotspot(with 0mm separation)	
UMTS Band V	0.570	0.570	1.6
LTE Band 5	0.796	0.796	
LTE Band 41	0.744	0.744	
WIFI 2.4G	0.637	0.637	
5.2GHz (U-NII-1)	0.855	0.855	
5.6GHz (U-NII-2C)	0.823	0.823	
5.8GHz (U-NII-3)	0.718	0.718	
Simultaneous Reported SAR	1.473		
SAR Test Result	PASS		

This device is compliance with Specific Absorption Rate (SAR) for general population/uncontrolled exposure limits (1.6W/kg) specified in IEEE Std. 1528:2013; FCC 47CFR § 2.1093; IEEE/ANSI C95.1:2005 and the following specific FCC Test Procedures:

- KDB 447498 D01 General RF Exposure Guidance v06
- KDB 648474 D04 Handset SAR v01r03
- KDB 865664 D01 SAR Measurement 100MHz to 6GHz v01r04
- KDB 941225 D01 3G SAR Procedures v03r01
- KDB 941225 D06 Hotspot Mode v02r01
- KDB 248227 D01 802 11 Wi-Fi SAR v02r02
- KDB 941225 D05 SAR for LTE Devices v02r05

Any report having not been signed by authorized approver, or having been altered without authorization, or having not been stamped by the "Dedicated Testing/Inspection Stamp" is deemed to be invalid. Copying or excerpting portion of, or altering the content of the report is not permitted without the written authorization of AGC. The test results presented in the report apply only to the tested sample. Any objections to report issued by AGC should be submitted to AGC within 15days after the issuance of the test report. Further enquiry of validity or verification of the test report should be addressed to AGC by agc01@agccert.com.

## 2. GENERAL INFORMATION

### 2.1. EUT Description

General Information	
Product Designation	Body Worn Camera
Test Model	K7
Sample ID	220920137
Hardware Version	EP-VRM04MB-02
Software Version	V1.0
Device Category	Portable
RF Exposure Environment	Uncontrolled
Antenna Type	Internal
WCDMA	
Support Band	<input type="checkbox"/> UMTS FDD Band II <input checked="" type="checkbox"/> UMTS FDD Band V <input type="checkbox"/> UMTS FDD Band IV(U.S. Bands) <input checked="" type="checkbox"/> UMTS FDD Band I <input type="checkbox"/> UMTS FDD Band III <input checked="" type="checkbox"/> UMTS FDD Band VIII (Non-U.S. Bands)
HS Type	HSPA(HSUPA/HSDPA)
TX Frequency Range	FDD Band V: 824-849MHz
RX Frequency Range	FDD Band V: 869-894MHz
Release Version	Rel-6
Type of modulation	HSDPA:QPSK/16QAM; HSUPA:BPSK; WCDMA:QPSK
Antenna Gain	Band V:0.63dBi
Max. Average Power	Band V: 23.48dBm
Bluetooth	
Bluetooth Version	<input checked="" type="checkbox"/> V4.2
Operation Frequency	2402~2480MHz
Type of modulation	<input checked="" type="checkbox"/> GFSK <input type="checkbox"/> π/4-DQPSK <input type="checkbox"/> 8-DPSK
Peak Power	-0.164dBm
Antenna Gain	-2.6dBi
2.4GHz WIFI	
WIFI Specification	<input type="checkbox"/> 802.11a <input checked="" type="checkbox"/> 802.11b <input checked="" type="checkbox"/> 802.11g <input checked="" type="checkbox"/> 802.11n(20) <input checked="" type="checkbox"/> 802.11n(40)
Operation Frequency	2412~2462MHz
Avg. Burst Power	11b: 17.47dBm,11g: 14.80dBm,11n(20): 13.75dBm,11n(40): 12.84dBm
Antenna Gain	1.15dBi

Any report having not been signed by authorized approver, or having been altered without authorization, or having not been stamped by the "Dedicated Testing/Inspection Stamp" is deemed to be invalid. Copying or excerpting portion of, or altering the content of the report is not permitted without the written authorization of AGC. The test results presented in the report apply only to the tested sample. Any objections to report issued by AGC should be submitted to AGC within 15days after the issuance of the test report. Further enquiry of validity or verification of the test report should be addressed to AGC by agc01@agccert.com.

**EUT Description( Continue)**

<b>LTE</b>	
Support Band	<input type="checkbox"/> FDD Band 2 <input type="checkbox"/> FDD Band 4 <input checked="" type="checkbox"/> FDD Band 5 <input type="checkbox"/> FDD Band 7 <input type="checkbox"/> FDD Band 12 <input type="checkbox"/> FDD Band 13 <input type="checkbox"/> FDD Band 17 <input type="checkbox"/> FDD Band 25 <input type="checkbox"/> FDD Band 26 <input type="checkbox"/> TDD Band 38 <input type="checkbox"/> TDD Band 40 <input checked="" type="checkbox"/> TDD Band 41 <input type="checkbox"/> FDD Band 66 <input type="checkbox"/> FDD Band 71   (U.S. Bands) <input checked="" type="checkbox"/> FDD Band 1 <input checked="" type="checkbox"/> FDD Band 3 <input checked="" type="checkbox"/> FDD Band 7 <input checked="" type="checkbox"/> FDD Band 8 <input checked="" type="checkbox"/> FDD Band 20 <input type="checkbox"/> FDD Band 28 <input checked="" type="checkbox"/> TDD Band 38 <input checked="" type="checkbox"/> TDD Band 40 <input type="checkbox"/> TDD Band 42 <input type="checkbox"/> TDD Band 43 (Non-U.S. Bands)
TX Frequency Range	Band 5:824-849MHz;Band 41:2496-2690MHz;
RX Frequency Range	Band 5:869-894MHz; Band 41:2496-2690MHz;
Release Version	Rel-8
Type of modulation	QPSK, 16QAM
Antenna Gain	Band 5: 0.63dBi; Band 41: 1.4dBi;
Max. Average Power	Band 5: 23.01dBm; Band 41: 22.39dBm;
<b>5 GHz WIFI</b>	
WIFI Specification	<input checked="" type="checkbox"/> 802.11a <input checked="" type="checkbox"/> 802.11n20 <input checked="" type="checkbox"/> 802.11n40 <input checked="" type="checkbox"/> 802.11ac20 <input checked="" type="checkbox"/> 802.11ac40 <input checked="" type="checkbox"/> 802.11ac80
Operation Frequency	U-NII-1: 5180MHz~5240MHz; U-NII-2A: 5260MHz~5320MHz; U-NII-2C: 5470MHz~5725MHz;U-NII-3: 5745MHz~5825MHz
Max. conducted Power	U-NII-1: 15.91dBm; U-NII-2A: 15.77dBm; U-NII-2C: 14.82dBm; U-NII-3: 13.00dBm
Antenna Gain	1.82dBi
<b>Accessories</b>	
Battery	Brand name: N/A Model No. : IBR036GA Voltage and Capacitance: 3.8 V & 4500mAh
Earphone	Brand name: N/A Model No. : N/A

Note:1.CMU200 can measure the average power and Peak power at the same time  
 2.The sample used for testing is end product.  
 3. The test sample has no any deviation to the test method of standard mentioned in page 1.

Product	Type
	<input checked="" type="checkbox"/> Production unit <input type="checkbox"/> Identical Prototype

Any report having not been signed by authorized approver, or having been altered without authorization, or having not been stamped by the "Dedicated Testing/Inspection Stamp" is deemed to be invalid. Copying or excerpting portion of, or altering the content of the report is not permitted without the written authorization of AGC. The test results presented in the report apply only to the tested sample. Any objections to report issued by AGC should be submitted to AGC within 15days after the issuance of the test report. Further enquiry of validity or verification of the test report should be addressed to AGC by agc01@agccert.com.

### 3. SAR MEASUREMENT SYSTEM

#### 3.1. The SATIMO system used for performing compliance tests consists of following items

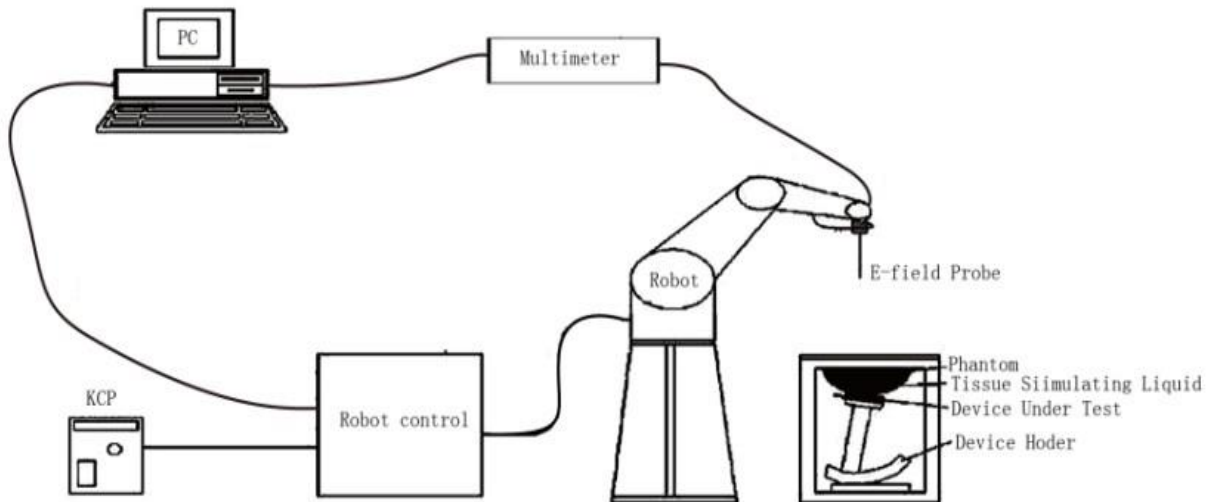

The COMOSAR system for performing compliance tests consists of the following items:

- The PC. It controls most of the bench devices and stores measurement data. A computer running WinXP and the Opensar software.
- The E-Field probe. The probe is a 3-axis system made of 3 distinct dipoles. Each dipole returns a voltage in function of the ambient electric field.
- The Keithley multimeter measures each probe dipole voltages.
- The SAM phantom simulates a human head. The measurement of the electric field is made inside the phantom.
- The liquids simulate the dielectric properties of the human head tissues.
- The network emulator controls the mobile phone under test.
- The validation dipoles are used to measure a reference SAR. They are used to periodically check the bench to make sure that there is no drift of the system characteristics over time.
- The phantom, the device holder and other accessories according to the targeted measurement.

Any report having not been signed by authorized approver, or having been altered without authorization, or having not been stamped by the "Dedicated Testing/Inspection Stamp" is deemed to be invalid. Copying or excerpting portion of, or altering the content of the report is not permitted without the written authorization of AGC. The test results presented in the report apply only to the tested sample. Any objections to report issued by AGC should be submitted to AGC within 15days after the issuance of the test report. Further enquiry of validity or verification of the test report should be addressed to AGC by [agc01@agccert.com](mailto:agc01@agccert.com).



### 3.2. COMOSAR E-Field Probe

The SAR measurement is conducted with the dosimetric probe manufactured by SATIMO. The probe is specially designed and calibrated for use in liquid with high permittivity. The dosimetric probe has special calibration in liquid at different frequency. SATIMO conducts the probe calibration in compliance with international and national standards (e.g. IEEE 1528 and relevant KDB files.) The calibration data are in Appendix D.

#### Isotropic E-Field Probe Specification

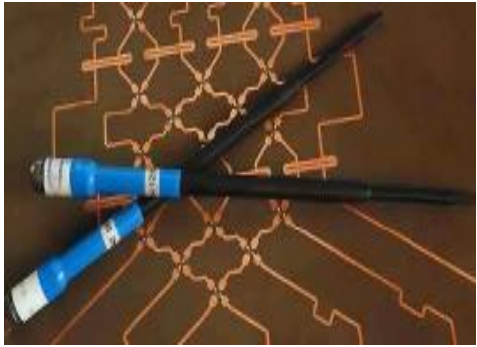
<b>Model</b>	SSE2	
<b>Manufacture</b>	MVG	
<b>Identification No.</b>	SN 13/22 EPGO368	
<b>Frequency</b>	0.15GHz-6GHz Linearity:±0.09dB(0.15GHz-6GHz)	
<b>Dynamic Range</b>	0.01W/kg-100W/kg Linearity:±0.09dB	
<b>Dimensions</b>	Overall length:330mm Length of individual dipoles:2mm Maximum external diameter:8mm Probe Tip external diameter:2.5mm Distance between dipoles/ probe extremity:1mm	
<b>Application</b>	High precision dosimetric measurements in any exposure scenario (e.g., very strong gradient fields). Only probe which enables compliance testing for frequencies up to 6 GHz with precision of better 30%.	

### 3.3. Robot

<p>The COMOSAR system uses the KUKA robot from SATIMO SA (France).For the 6-axis controller COMOSAR system, the KUKA robot controller version from SATIMO is used.</p> <p>The XL robot series have many features that are important for our application:</p> <ul style="list-style-type: none"> <li><input type="checkbox"/> High precision (repeatability 0.02 mm)</li> <li><input type="checkbox"/> High reliability (industrial design)</li> <li><input type="checkbox"/> Jerk-free straight movements</li> <li><input type="checkbox"/> Low ELF interference (the closed metallic construction shields against motor control fields)</li> <li><input type="checkbox"/> 6-axis controller</li> </ul>	
---	---

Any report having not been signed by authorized approver, or having been altered without authorization, or having not been stamped by the "Dedicated Testing/Inspection Stamp" is deemed to be invalid. Copying or excerpting portion of, or altering the content of the report is not permitted without the written authorization of AGC. The test results presented in the report apply only to the tested sample. Any objections to report issued by AGC should be submitted to AGC within 15days after the issuance of the test report. Further enquiry of validity or verification of the test report should be addressed to AGC by agc01@agccert.com.

### 3.4. Video Positioning System

The video positioning system is used in OpenSAR to check the probe. Which is composed of a camera, LED, mirror and mechanical parts. The camera is piloted by the main computer with firewire link. During the process, the actual position of the probe tip with respect to the robot arm is measured, as well as the probe length and the horizontal probe offset. The software then corrects all movements, such that the robot coordinates are valid for the probe tip. The repeatability of this process is better than 0.1 mm. If a position has been taught with an aligned probe, the same position will be reached with another aligned probe within 0.1 mm, even if the other probe has different dimensions. During probe rotations, the probe tip will keep its actual position.

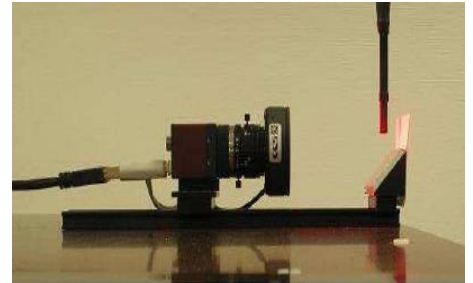

### 3.5. Device Holder

The COMOSAR device holder is designed to cope with different positions given in the standard. It has two scales for the device rotation (with respect to the body axis) and the device inclination (with respect to the line between the ear reference points). The rotation center for both scales is the ear reference point (EPR). Thus the device needs no repositioning when changing the angles. The COMOSAR device holder has been made out of low-loss POM material having the following dielectric parameters: relative permittivity  $\epsilon_r = 3$  and loss tangent  $\delta = 0.02$ . The amount of dielectric material has been reduced in the closest vicinity of the device, since measurements have suggested that the influence of the clamp on the test results could thus be lowered.

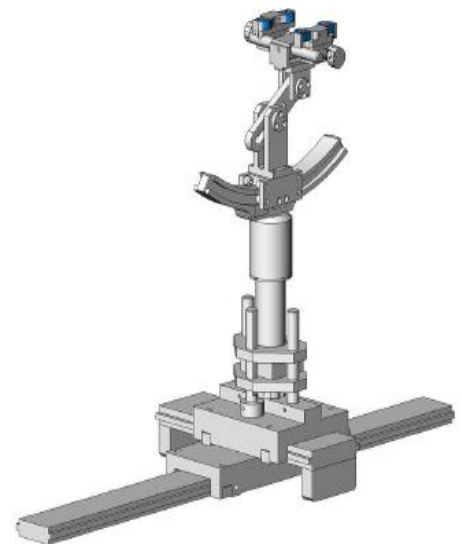

### 3.6. SAM Twin Phantom

The SAM twin phantom is a fiberglass shell phantom with 2mm shell thickness (except the ear region where shell thickness increases to 6mm). It has three measurement areas:

- Left head
- Right head
- Flat phantom



The bottom plate contains three pair of bolts for locking the device holder. The device holder positions are adjusted to the standard measurement positions in the three sections. A white cover is provided to tap the phantom during off-periods to prevent water evaporation and changes in the liquid parameters. On the phantom top, three reference markers are provided to identify the phantom position with respect to the robot.

## 4. SAR MEASUREMENT PROCEDURE

### 4.1. Specific Absorption Rate (SAR)

SAR is related to the rate at which energy is absorbed per unit mass in object exposed to a radio field. The SAR distribution in a biological body is complicated and is usually carried out by experimental techniques or numerical modeling. The standard recommends limits for two tiers of groups, occupational/controlled and occupational/uncontrolled, based on a person's awareness and ability to exercise control over his or her exposure. In general, occupational/controlled exposure limits are higher than the limits for general population/uncontrolled.

The SAR definition is the time derivative (rate) of the incremental energy (dW) absorbed by (dissipated in) an incremental mass (dm) contained in a volume element(dv) of given mass density (ρ). The equation description is as below:

$$SAR = \frac{d}{dt} \left( \frac{dW}{dm} \right) = \frac{d}{dt} \left( \frac{dW}{\rho dV} \right)$$

SAR is expressed in units of Watts per kilogram (W/kg)

SAR can be obtained using either of the following equations:

$$SAR = \frac{\sigma E^2}{\rho}$$

$$SAR = c_h \left. \frac{dT}{dt} \right|_{t=0}$$

Where

SAR	is the specific absorption rate in watts per kilogram;
E	is the r.m.s. value of the electric field strength in the tissue in volts per meter;
σ	is the conductivity of the tissue in siemens per metre;
ρ	is the density of the tissue in kilograms per cubic metre;
c <sub>h</sub>	is the heat capacity of the tissue in joules per kilogram and Kelvin;
$\left. \frac{dT}{dt} \right _{t=0}$	is the initial time derivative of temperature in the tissue in kelvins per second

## 4.2. SAR Measurement Procedure

### Step 1: Power Reference Measurement

The Power Reference Measurement and Power Drift Measurement are for monitoring the power drift of the device under test in the batch process. The minimum distance of probe sensors to surface is 2.7mm This distance cannot be smaller than the distance os sensor calibration points to probe tip as defined in the probe properties,

### Step 2: Area Scan

The Area Scan is used as a fast scan in two dimensions to find the area of high field values, before doing a fine measurement around the hot spot. The sophisticated interpolation routines implemented in SATIMO software can find the maximum locations even in relatively coarse grids. When an Area Scan has measured all reachable points, it computes the field maximal found in the scanned area, within a range of the global maximum. The range (in db) is specified in the standards for compliance testing. For example, a 2db range is required in IEEE Standard 1528 and IEC62209 standards, whereby 3db is a requirement when compliance is assessed in accordance with the ARIB standard (Japan) If one Zoom Scan follows the Area Scan, then only the absolute maximum will be taken as reference. For cases where multiple maximum are detected, the number of Zoom Scan has to be increased accordingly.

Area Scan Parameters extracted from KDB 865664 D01 SAR Measurement 100MHz to 6GHz

	≤ 3 GHz	> 3 GHz
Maximum distance from closest measurement point (geometric center of probe sensors) to phantom surface	5 ± 1 mm	$\frac{1}{2} \cdot \delta \cdot \ln(2) \pm 0.5$ mm
Maximum probe angle from probe axis to phantom surface normal at the measurement location	30° ± 1°	20° ± 1°
Maximum area scan spatial resolution: $\Delta x_{Area}$ , $\Delta y_{Area}$	≤ 2 GHz: ≤ 15 mm 2 – 3 GHz: ≤ 12 mm	3 – 4 GHz: ≤ 12 mm 4 – 6 GHz: ≤ 10 mm
	When the x or y dimension of the test device, in the measurement plane orientation, is smaller than the above, the measurement resolution must be ≤ the corresponding x or y dimension of the test device with at least one measurement point on the test device.	

### Step 3: Zoom Scan

Zoom Scan are used to assess the peak spatial SAR value within a cubic average volume containing 1g abd 10g of simulated tissue. The Zoom Scan measures points(refer to table below) within a cube whose base faces are centered on the maxima found in a preceding area scan job within the same procedure. When the measurement is done, the Zoom Scan evaluates the averaged SAR for 1g and 10g and displays these values next to the job's label.

Zoom Scan Parameters extracted from KDB865664 d01 SAR Measurement 100MHz to 6GHz

Maximum zoom scan spatial resolution: $\Delta x_{Zoom}$ , $\Delta y_{Zoom}$		$\leq 2$ GHz: $\leq 8$ mm 2 – 3 GHz: $\leq 5$ mm*	3 – 4 GHz: $\leq 5$ mm* 4 – 6 GHz: $\leq 4$ mm*
Maximum zoom scan spatial resolution, normal to phantom surface	uniform grid: $\Delta z_{Zoom}(n)$	$\leq 5$ mm	3 – 4 GHz: $\leq 4$ mm 4 – 5 GHz: $\leq 3$ mm 5 – 6 GHz: $\leq 2$ mm
	graded grid	$\Delta z_{Zoom}(1)$ : between 1 <sup>st</sup> two points closest to phantom surface	$\leq 4$ mm
		$\Delta z_{Zoom}(n>1)$ : between subsequent points	$\leq 1.5 \cdot \Delta z_{Zoom}(n-1)$
Minimum zoom scan volume	x, y, z	$\geq 30$ mm	3 – 4 GHz: $\geq 28$ mm 4 – 5 GHz: $\geq 25$ mm 5 – 6 GHz: $\geq 22$ mm
<p>Note: <math>\delta</math> is the penetration depth of a plane-wave at normal incidence to the tissue medium; see draft standard IEEE P1528-2011 for details.</p> <p>* When zoom scan is required and the <i>reported</i> SAR from the <i>area scan based 1-g SAR estimation</i> procedures of KDB 447498 is <math>\leq 1.4</math> W/kg, <math>\leq 8</math> mm, <math>\leq 7</math> mm and <math>\leq 5</math> mm zoom scan resolution may be applied, respectively, for 2 GHz to 3 GHz, 3 GHz to 4 GHz and 4 GHz to 6 GHz.</p>			

Step 4: Power Drift Measurement

The Power Drift Measurement measures the field at the same location as the most recent power reference measurement within the same procedure, and with the same settings. The Power Drift Measurement gives the field difference in dB from the reading conducted within the same settings. This allows a user to monitor the power drift of the device under test within a batch process. The measurement procedure is the same as Step 1.

Any report having not been signed by authorized approver, or having been altered without authorization, or having not been stamped by the “Dedicated Testing/Inspection Stamp” is deemed to be invalid. Copying or excerpting portion of, or altering the content of the report is not permitted without the written authorization of AGC. The test results presented in the report apply only to the tested sample. Any objections to report issued by AGC should be submitted to AGC within 15days after the issuance of the test report. Further enquiry of validity or verification of the test report should be addressed to AGC by agc01@agccert.com.

### 4.3. RF Exposure Conditions

Test Configuration and setting:

The EUT is a Body Worn Camera. It supports WCDMA/HSPA, LTE, BT, WIFI, and support hot spot mode.

For WWAN SAR testing, the device was controlled by using a base station emulator. Communication between the device and the emulator were established by air link. The distance between the EUT and the antenna is larger than 50cm, and the output power radiated from the emulator antenna is at least 30db smaller than the output power of EUT.

For WLAN testing, the EUT is configured with the WLAN continuous TX tool through engineering command.

For BT, According to KDB 447498 D01, annex A, SAR is not required for bluetooth because its maximum output power is less than 10 mW.

#### Antenna Location: (the back view)

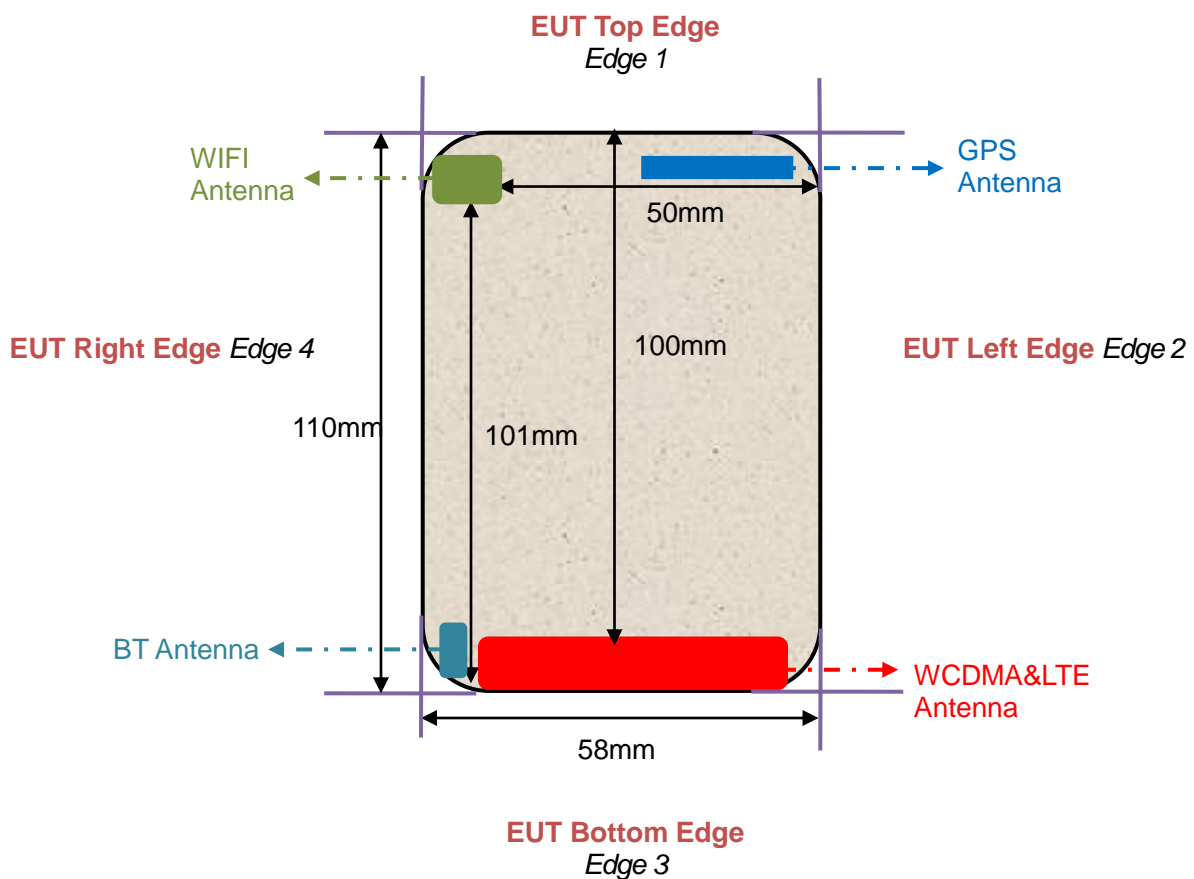

Any report having not been signed by authorized approver, or having been altered without authorization, or having not been stamped by the "Dedicated Testing/Inspection Stamp" is deemed to be invalid. Copying or excerpting portion of, or altering the content of the report is not permitted without the written authorization of AGC. The test results presented in the report apply only to the tested sample. Any objections to report issued by AGC should be submitted to AGC within 15days after the issuance of the test report. Further enquiry of validity or verification of the test report should be addressed to AGC by agc01@agccert.com.

## 5. TISSUE SIMULATING LIQUID

For SAR measurement of the field distribution inside the phantom, the phantom must be filled with homogeneous tissue simulating liquid to a depth of at least 15cm. For head SAR testing the liquid height from the ear reference point (ERP) of the phantom to the liquid top surface is larger than 15cm For body SAR testing, the liquid height from the center of the flat phantom to the liquid top surface is larger than 15cm. The nominal dielectric values of the tissue simulating liquids in the phantom and the tolerance of 10% are listed in 6.2

### 5.1. The composition of the tissue simulating liquid

Ingredient (% Weight) Frequency (MHz)	Water	NaCl	Polysorbate 20	DGBE	1,2- Propanediol	Triton X-100	Diethylen glycol monohex ylether
835 Head	50.36	1.25	48.39	0.0	0.0	0.0	0.0
2450 Head	71.88	0.16	0.0	7.99	0.0	19.97	0.0
2600 Head	55.242	0.306	0	44.452	0	0	0.0
5000 Head	65.52	0.0	0.0	0.0	0.0	17.24	17.24

Any report having not been signed by authorized approver, or having been altered without authorization, or having not been stamped by the "Dedicated Testing/Inspection Stamp" is deemed to be invalid. Copying or excerpting portion of, or altering the content of the report is not permitted without the written authorization of AGC. The test results presented in the report apply only to the tested sample. Any objections to report issued by AGC should be submitted to AGC within 15days after the issuance of the test report. Further enquiry of validity or verification of the test report should be addressed to AGC by agc01@agccert.com.



## 5.2. Tissue Dielectric Parameters for Head and Body Phantoms

The head tissue dielectric parameters recommended by the IEC 62209-1 have been incorporated in the following table. The body tissue dielectric parameters recommended by the IEC 62209-2 have been incorporated in the following table.

Target Frequency (MHz)	head		body	
	$\epsilon_r$	$\sigma$ (S/m)	$\epsilon_r$	$\sigma$ (S/m)
300	45.3	0.87	45.3	0.87
450	43.5	0.87	43.5	0.87
750	41.9	0.89	41.9	0.89
<b>835</b>	<b>41.5</b>	<b>0.90</b>	<b>41.5</b>	<b>0.90</b>
900	41.5	0.97	41.5	0.97
915	41.5	1.01	41.5	1.01
1450	40.5	1.20	40.5	1.20
1610	40.3	1.29	40.3	1.29
1750	40.1	1.37	40.1	1.37
1800 – 2000	40.0	1.40	40.0	1.40
2300	39.5	1.67	39.5	1.67
<b>2450</b>	<b>39.2</b>	<b>1.80</b>	<b>39.2</b>	<b>1.80</b>
<b>2600</b>	<b>39.0</b>	<b>1.96</b>	<b>39.0</b>	<b>1.96</b>
3000	38.5	2.40	38.5	2.40
<b>5200</b>	<b>36.0</b>	<b>4.66</b>	<b>36.0</b>	<b>4.66</b>
<b>5300</b>	<b>35.9</b>	<b>4.76</b>	<b>35.9</b>	<b>4.76</b>
<b>5600</b>	<b>35.5</b>	<b>5.07</b>	<b>35.5</b>	<b>5.07</b>
<b>5800</b>	<b>35.3</b>	<b>5.27</b>	<b>35.3</b>	<b>5.27</b>

( $\epsilon_r$  = relative permittivity,  $\sigma$  = conductivity and  $\rho = 1000 \text{ kg/m}^3$ )

Any report having not been signed by authorized approver, or having been altered without authorization, or having not been stamped by the “Dedicated Testing/Inspection Stamp” is deemed to be invalid. Copying or excerpting portion of, or altering the content of the report is not permitted without the written authorization of AGC. The test results presented in the report apply only to the tested sample. Any objections to report issued by AGC should be submitted to AGC within 15days after the issuance of the test report. Further enquiry of validity or verification of the test report should be addressed to AGC by [agc01@agccert.com](mailto:agc01@agccert.com).

### 5.3. Tissue Calibration Result

The dielectric parameters of the liquids were verified prior to the SAR evaluation using SATIMO Dielectric Probe Kit and R&S Network Analyzer ZVL6.

Tissue Stimulant Measurement for 835MHz					
Head	Fr. (MHz)	Dielectric Parameters ( $\pm 10\%$ )		Tissue Temp [°C]	Test time
		$\epsilon_r$ 41.5 (37.35-45.65)	$\delta$ [s/m] 0.90(0.81-0.99)		
	835	41.28	0.93	21.6	Oct. 20,2022
	836.4	40.69	0.95		
	836.5	40.69	0.97		

Tissue Stimulant Measurement for 2450MHz					
Head	Fr. (MHz)	Dielectric Parameters ( $\pm 10\%$ )		Tissue Temp [°C]	Test time
		$\epsilon_r$ 39.2(35.28-43.12)	$\delta$ [s/m]1.80(1.62-1.98)		
	2437	39.12	1.73	21.2	Oct. 18,2022
	2450	38.61	1.77		

Tissue Stimulant Measurement for 2600MHz					
Head	Fr. (MHz)	Dielectric Parameters ( $\pm 10\%$ )		Tissue Temp [°C]	Test time
		$\epsilon_r$ 39(35.1-42.9)	$\delta$ [s/m]1.96(1.764-2.156)		
	2593	39.67	1.89	21.5	Oct. 19,2022
	2600	38.98	1.91		

Any report having not been signed by authorized approver, or having been altered without authorization, or having not been stamped by the "Dedicated Testing/Inspection Stamp" is deemed to be invalid. Copying or excerpting portion of, or altering the content of the report is not permitted without the written authorization of AGC. The test results presented in the report apply only to the tested sample. Any objections to report issued by AGC should be submitted to AGC within 15days after the issuance of the test report. Further enquiry of validity or verification of the test report should be addressed to AGC by agc01@agccert.com.

Tissue Stimulant Measurement for 5200MHz					
Head	Fr. (MHz)	Dielectric Parameters ( $\pm 10\%$ )		Tissue Temp [°C]	Test time
		$\epsilon_r$	$\delta$ [s/m]		
		36.0(32.4-39.6)	4.66(4.194 -5.126)		
	5180	36.79	4.43	22.1	Oct. 16,2022
	5200	35.24	4.52		
	5220	34.20	4.90		
	5240	33.27	4.93		

Tissue Stimulant Measurement for 5600MHz					
Head	Fr. (MHz)	Dielectric Parameters ( $\pm 10\%$ )		Tissue Temp [°C]	Test time
		$\epsilon_r$	$\delta$ [s/m]		
		35.5(31.95-39.05)	5.07(4.563-5.577)		
	5500	36.91	5.16	22.0	Oct. 17,2022
	5600	34.99	5.24		
	5700	33.21	5.36		

Tissue Stimulant Measurement for 5800MHz					
Head	Fr. (MHz)	Dielectric Parameters ( $\pm 10\%$ )		Tissue Temp [°C]	Test time
		$\epsilon_r$	$\delta$ [s/m]		
		35.3 (31.77-38.83)	5.27 (4.743-5.797)		
	5785	36.92	5.18	21.7	Oct. 17,2022
	5800	35.17	5.22		

Any report having not been signed by authorized approver, or having been altered without authorization, or having not been stamped by the "Dedicated Testing/Inspection Stamp" is deemed to be invalid. Copying or excerpting portion of, or altering the content of the report is not permitted without the written authorization of AGC. The test results presented in the report apply only to the tested sample. Any objections to report issued by AGC should be submitted to AGC within 15days after the issuance of the test report. Further enquiry of validity or verification of the test report should be addressed to AGC by agc01@agccert.com.

## 6. SAR SYSTEM CHECK PROCEDURE

### 6.1. SAR System Check Procedures

SAR system check is required to confirm measurement accuracy, according to the tissue dielectric media, probe calibration points and other system operating parameters required for measuring the SAR of a test device. The system verification must be performed for each frequency band and within the valid range of each probe calibration point required for testing the device. The same SAR probe(s) and tissue-equivalent media combinations used with each specific SAR system for system verification must be used for device testing. When multiple probe calibration points are required to cover substantially large transmission bands, independent system verifications are required for each probe calibration point. A system verification must be performed before each series of SAR measurements using the same probe calibration point and tissue-equivalent medium. Additional system verification should be considered according to the conditions of the tissue-equivalent medium and measured tissue dielectric parameters, typically every three to four days when the liquid parameters are remeasured or sooner when marginal liquid parameters are used at the beginning of a series of measurements.

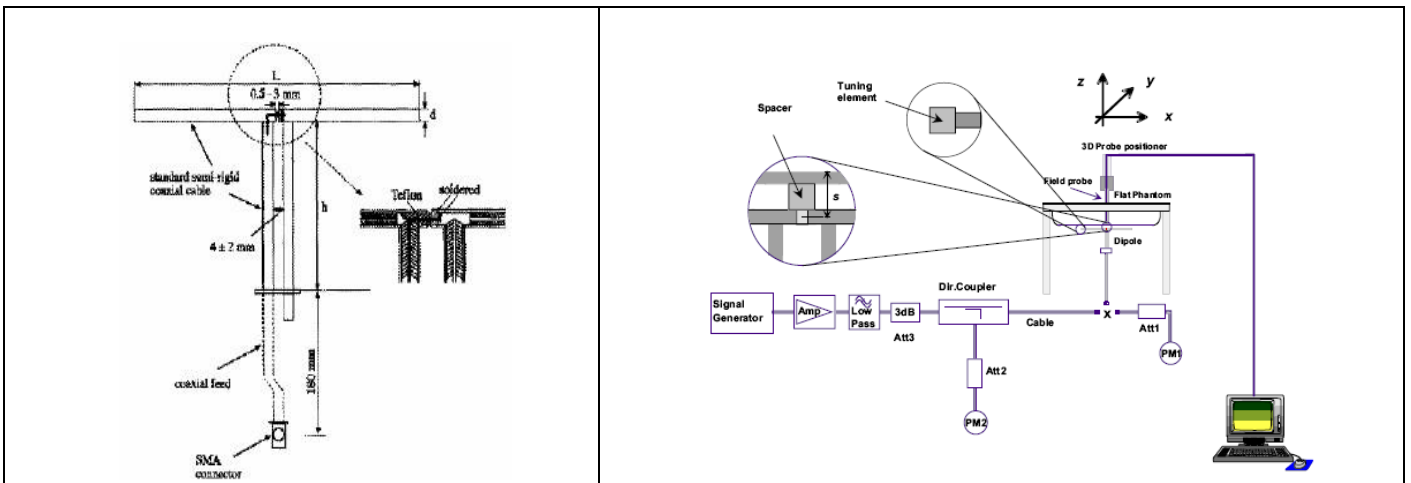

Each SATIMO system is equipped with one or more system check kits. These units, together with the predefined measurement procedures within the SATIMO software, enable the user to conduct the system check and system validation. System kit includes a dipole, and dipole device holder.

The system check verifies that the system operates within its specifications. It's performed daily or before every SAR measurement. The system check uses normal SAR measurement in the flat section of the phantom with a matched dipole at a specified distance. The system check setup is shown as below.

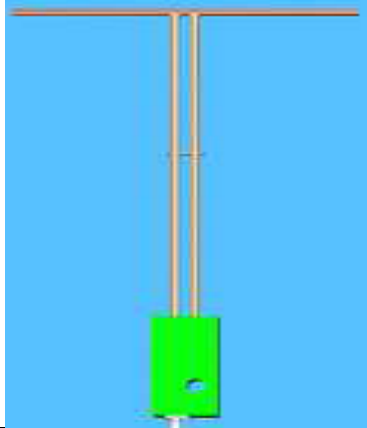

Any report having not been signed by authorized approver, or having been altered without authorization, or having not been stamped by the "Dedicated Testing/Inspection Stamp" is deemed to be invalid. Copying or excerpting portion of, or altering the content of the report is not permitted without the written authorization of AGC. The test results presented in the report apply only to the tested sample. Any objections to report issued by AGC should be submitted to AGC within 15 days after the issuance of the test report. Further enquiry of validity or verification of the test report should be addressed to AGC by [agc01@agccert.com](mailto:agc01@agccert.com).

**6.2. SAR System Check**  
**6.2.1. Dipoles**

	<p>The dipoles are based on the IEEE-1528 standard, and are complied with mechanical and electrical specifications in line with the requirements of IEEE. the table below provides details for the mechanical and electrical Specifications for the dipoles.</p>
	<p>The dipole is based on the IEEE-1528 standard, and is complied with mechanical and electrical specifications in line with the requirements of IEEE. The table below provides details for the mechanical and electrical specifications for the wave guide.</p>

Frequency	L (mm)	h (mm)	d (mm)
835MHz	161.0	89.8	3.6
2450MHz	51.5	30.4	3.6
2600MHz	48.5	28.8	3.6
5000MHz	20.6	40.3	3.6

Any report having not been signed by authorized approver, or having been altered without authorization, or having not been stamped by the “Dedicated Testing/Inspection Stamp” is deemed to be invalid. Copying or excerpting portion of, or altering the content of the report is not permitted without the written authorization of AGC. The test results presented in the report apply only to the tested sample. Any objections to report issued by AGC should be submitted to AGC within 15days after the issuance of the test report. Further enquiry of validity or verification of the test report should be addressed to AGC by [agc01@agccert.com](mailto:agc01@agccert.com).

### 6.2.2. System Check Result

System Performance Check at 835MHz & 2450MHz & 2600MHz & 5200-5800MHz for Head								
Validation Kit: SN 15/16 DIP 0G835-399 & SN 29/15 DIP 2G450-393 & SN 22/16 DIP 2G600-407 & SN 17/22 DIP 5G000-671								
Frequency [MHz]	Target Value(W/kg)		Reference Result ( $\pm 10\%$ )		Tested Value(W/kg)		Tissue Temp. [°C]	Test time
	1g	10g	1g	10g	1g	10g		
835	9.67	6.14	8.703-10.637	5.526-6.754	10.05	6.41	21.6	Oct. 20,2022
2450	54.32	24.25	48.888-59.752	21.825-26.675	54.28	24.37	21.2	Oct. 18,2022
2600	54.94	23.77	49.446-60.434	21.393-26.147	54.19	24.34	21.5	Oct. 19,2022
5200	73.43	21.83	66.087-80.773	19.647-24.013	73.43	21.06	22.1	Oct. 16,2022
5600	78.20	24.12	70.380-86.02	21.708-26.532	82.55	23.48	22.0	Oct. 17,2022
5800	75.69	22.44	68.121-83.259	20.196-24.684	80.46	23.06	21.7	Oct. 17,2022

Note:

(1) We use a CW signal of 18dBm & 10dBm for system check, and then all SAR value are normalized to 1W forward power. The result must be within  $\pm 10\%$  of target value.

## 7. EUT TEST POSITION

This EUT was tested in **Body back, Body front and 4 edges.**

### 7.1. Body Worn Position

- (1) To position the EUT parallel to the phantom surface.
- (2) To adjust the EUT parallel to the flat phantom.
- (3) To adjust the distance between the EUT surface and the flat phantom to **0mm**.

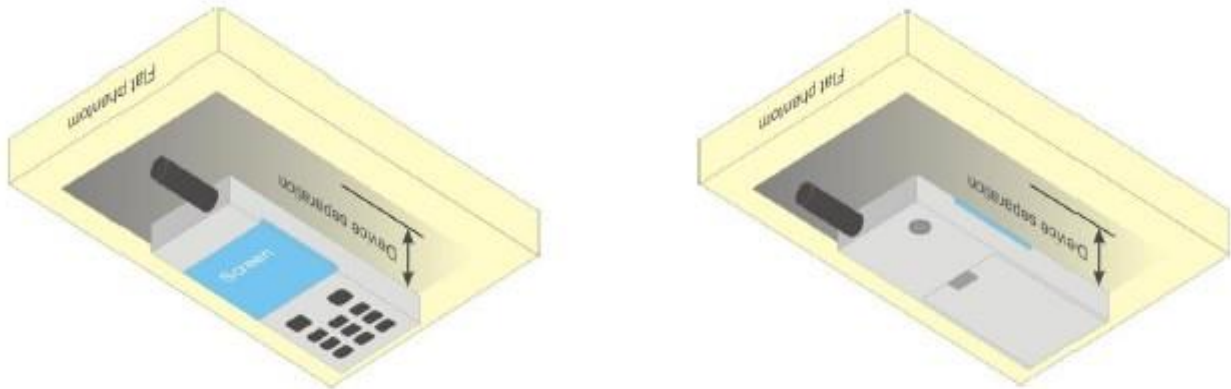

Any report having not been signed by authorized approver, or having been altered without authorization, or having not been stamped by the "Dedicated Testing/Inspection Stamp" is deemed to be invalid. Copying or excerpting portion of, or altering the content of the report is not permitted without the written authorization of AGC. The test results presented in the report apply only to the tested sample. Any objections to report issued by AGC should be submitted to AGC within 15days after the issuance of the test report. Further enquiry of validity or verification of the test report should be addressed to AGC by [agc01@agccert.com](mailto:agc01@agccert.com).

## 8. SAR EXPOSURE LIMITS

### Limits for General Population/Uncontrolled Exposure (W/kg)

Type Exposure	Uncontrolled Environment Limit (W/kg)
Spatial Peak SAR (1g cube tissue for brain or body)	1.60
Spatial Average SAR (Whole body)	0.08
Spatial Peak SAR (Limbs)	4.0

Any report having not been signed by authorized approver, or having been altered without authorization, or having not been stamped by the "Dedicated Testing/Inspection Stamp" is deemed to be invalid. Copying or excerpting portion of, or altering the content of the report is not permitted without the written authorization of AGC. The test results presented in the report apply only to the tested sample. Any objections to report issued by AGC should be submitted to AGC within 15days after the issuance of the test report. Further enquiry of validity or verification of the test report should be addressed to AGC by [agc01@agccert.com](mailto:agc01@agccert.com).

Attestation of Global Compliance(Shenzhen)Co., Ltd

Attestation of Global Compliance(Shenzhen)Std & Tech Co., Ltd

Tel: +86-755 2523 4088 E-mail: [agc@agccert.com](mailto:agc@agccert.com) Web: <http://www.agccert.com/>



## 9. TEST FACILITY

<b>Test Site</b>	Attestation of Global Compliance (Shenzhen) Co., Ltd
<b>Location</b>	1-2/F, Building 19, Junfeng Industrial Park, Chongqing Road, Heping Community, Fuhai Street, Bao'an District, Shenzhen, Guangdong, China
<b>Designation Number</b>	CN1259
<b>FCC Test Firm Registration Number</b>	975832
<b>A2LA Cert. No.</b>	5054.02
<b>Description</b>	Attestation of Global Compliance(Shenzhen) Co., Ltd is accredited by A2LA

Any report having not been signed by authorized approver, or having been altered without authorization, or having not been stamped by the "Dedicated Testing/Inspection Stamp" is deemed to be invalid. Copying or excerpting portion of, or altering the content of the report is not permitted without the written authorization of AGC. The test results presented in the report apply only to the tested sample. Any objections to report issued by AGC should be submitted to AGC within 15days after the issuance of the test report. Further enquiry of validity or verification of the test report should be addressed to AGC by [agc01@agccert.com](mailto:agc01@agccert.com).

## 10. TEST EQUIPMENT LIST

Equipment description	Manufacturer/ Model	Identification No.	Software version	Current calibration date	Next calibration date
SAR Probe	MVG	SN 13/22 EPGO368	N/A	Apr. 13,2022	Apr. 12,2023
Phantom	SATIMO	SN_4511_SAM90	N/A	Validated. No cal required.	Validated. No cal required.
Liquid	SATIMO	N/A	N/A	Validated. No cal required.	Validated. No cal required.
Comm Tester	Agilent-8960	GB46310822	A.13.07	Aug. 03,2022	Aug. 02,2023
Comm Tester	R&S- CMW500	121209	V3.7.40	Aug. 04,2022	Aug. 03,2023
Multimeter	Keithley 2000	1350784	N/A	Aug. 06,2022	Aug. 05,2023
SAR Software	SATIMO-OpenSAR	N/A	OpenSAR V4_02_32	N/A	N/A
Dipole	SATIMO SID835	SN 15/16 DIP 0G835-399	N/A	Apr. 28,2022	Apr. 27,2025
Dipole	SATIMO SID2450	SN 29/15 DIP 2G450-393	N/A	Apr. 28,2022	Apr. 27,2025
Dipole	SATIMO SID2600	SN 22/16 DIP 2G600-407	N/A	Apr. 28,2022	Apr. 27, 2025
Dipole	SID5000	SN 17/22 DIP 5G000-671	N/A	Apr. 28,2022	Apr. 27, 2025
Signal Generator	Agilent-E4438C	US41461365	V5.03	Aug. 03,2022	Aug. 02,2023
Vector Analyzer	Agilent / E4440A	MY44303916	N/A	Mar. 28,2022	Mar. 27,2023
Network Analyzer	Rhode & Schwarz ZVL6	SN101443	3.2	Oct. 28,2021	Oct. 27,2022
Attenuator	Warison /WATT-6SR1211	S/N:WRJ34AYM2F1	N/A	June 08,2022	June 07,2023
Attenuator	Mini-circuits / VAT-10+	31405	N/A	June 08,2022	June 07,2023
Amplifier	AS0104-55_55	1004793	N/A	June 09,2022	June 08,2023
Directional Couple	Werlatone/ C5571-10	SN99463	N/A	Mar. 10,2022	Mar. 09,2024
Directional Couple	Werlatone/ C6026-10	SN99482	N/A	Mar. 10,2022	Mar. 09,2024
Power Sensor	NRP-Z21	1137.6000.02	N/A	Sep. 06,2022	Sep. 05,2023
Power Sensor	NRP-Z23	100323	N/A	Feb. 16,2022	Feb. 15,2023
Power Viewer	R&S	V2.3.1.0	N/A	N/A	N/A
Calibration standard parts for network sub - port	R&S/ ZV-Z132	N/A	V2.3.1.0	Dec. 07,2021	Dec. 06,2022

Note: Per KDB 865664 Dipole SAR Validation, AGC Lab has adopted 3 years calibration intervals. On annual basis, every measurement dipole has been evaluated and is in compliance with the following criteria:

1. There is no physical damage on the dipole;
2. System validation with specific dipole is within 10% of calibrated value;
3. Return-loss is within 20% of calibrated measurement;
4. Impedance is within 5Ω of calibrated measurement.

## 11. MEASUREMENT UNCERTAINTY

SATIMO Uncertainty- SN 13/22 EPGO368 Measurement uncertainty for DUT averaged over 1 gram / 10 gram.									
Uncertainty Component	Sec.	Tol (+-%)	Prob. Dist.	Div.	Ci (1g)	Ci (10g)	1g Ui (+-%)	10g Ui (+-%)	vi
<b>Measurement System</b>									
Probe calibration	E.2.1	7.000	N	1	1	1	7.000	7.000	∞
Axial Isotropy	E.2.2	0.175	R	$\sqrt{3}$	$\sqrt{0.5}$	$\sqrt{0.5}$	0.071	0.071	∞
Hemispherical Isotropy	E.2.2	0.175	R	$\sqrt{3}$	$\sqrt{0.5}$	$\sqrt{0.5}$	0.071	0.071	∞
Boundary effect	E.2.3	1.000	R	$\sqrt{3}$	1	1	0.577	0.577	∞
Linearity	E.2.4	0.990	R	$\sqrt{3}$	1	1	0.572	0.572	∞
System detection limits	E.2.4	1.000	R	$\sqrt{3}$	1	1	0.577	0.577	∞
Modulation response	E.2.5	3.000	R	$\sqrt{3}$	1	1	1.732	1.732	∞
Readout Electronics	E.2.6	0.021	N	1	1	1	0.021	0.021	∞
Response Time	E.2.7	0.000	R	$\sqrt{3}$	1	1	0.000	0.000	∞
Integration Time	E.2.8	1.400	R	$\sqrt{3}$	1	1	0.808	0.808	∞
RF ambient conditions-Noise	E.6.1	3.000	R	$\sqrt{3}$	1	1	1.732	1.732	∞
RF ambient conditions-reflections	E.6.1	3.000	R	$\sqrt{3}$	1	1	1.732	1.732	∞
Probe positioner mechanical tolerance	E.6.2	1.400	R	$\sqrt{3}$	1	1	0.808	0.808	∞
Probe positioning with respect to phantom shell	E.6.3	1.400	R	$\sqrt{3}$	1	1	0.808	0.808	∞
Extrapolation, interpolation, and integrations algorithms for max. SAR evaluation	E.5	2.300	R	$\sqrt{3}$	1	1	1.328	1.328	∞
<b>Test sample Related</b>									
Test sample positioning	E.4.2	2.6	N	1	1	1	2.600	2.600	∞
Device holder uncertainty	E.4.1	3	N	1	1	1	3.000	3.000	∞
Output power variation—SAR drift measurement	E.2.9	5	R	$\sqrt{3}$	1	1	2.887	2.887	∞
SAR scaling	E.6.5	5	R	$\sqrt{3}$	1	1	2.887	2.887	∞
<b>Phantom and tissue parameters</b>									
Phantom shell uncertainty—shape, thickness, and permittivity	E.3.1	4	R	$\sqrt{3}$	1	1	2.309	2.309	∞
Uncertainty in SAR correction for deviations in permittivity and conductivity	E.3.2	1.9	N	1	1	0.84	1.900	1.596	∞
Liquid conductivity measurement	E.3.3	4	R	$\sqrt{3}$	0.78	0.71	3.120	2.840	∞
Liquid permittivity measurement	E.3.3	5	N	1	0.78	0.71	1.150	1.300	M
Liquid conductivity—temperature uncertainty	E.3.4	2.5	R	$\sqrt{3}$	0.23	0.26	1.126	1.025	∞
Liquid permittivity—temperature uncertainty	E.3.4	2.5	N	1	0.23	0.26	0.332	0.375	M
Combined Standard Uncertainty			RSS				10.529	10.344	
Expanded Uncertainty (95% Confidence interval)			K=2				21.058	20.688	

Any report having not been signed by authorized approver, or having been altered without authorization, or having not been stamped by the "Dedicated Testing/Inspection Stamp" is deemed to be invalid. Copying or excerpting portion of, or altering the content of the report is not permitted without the written authorization of AGC. The test results presented in the report apply only to the tested sample. Any objections to report issued by AGC should be submitted to AGC within 15days after the issuance of the test report. Further enquiry of validity or verification of the test report should be addressed to AGC by agc01@agccert.com.

SATIMO Uncertainty- SN 13/22 EPGO368									
System Validation uncertainty for DUT averaged over 1 gram / 10 gram.									
Uncertainty Component	Sec.	Tol (+-%)	Prob. Dist.	Div.	Ci (1g)	Ci (10g)	1g Ui (+-%)	10g Ui (+-%)	vi
<b>Measurement System</b>									
Probe calibration	E.2.1	7.000	N	1	1	1	7.000	7.000	∞
Axial Isotropy	E.2.2	0.175	R	$\sqrt{3}$	1	1	0.101	0.101	∞
Hemispherical Isotropy	E.2.2	0.175	R	$\sqrt{3}$	0	0	0.000	0.000	∞
Boundary effect	E.2.3	1.000	R	$\sqrt{3}$	1	1	0.577	0.577	∞
Linearity	E.2.4	0.990	R	$\sqrt{3}$	1	1	0.572	0.572	∞
System detection limits	E.2.4	1.0	R	$\sqrt{3}$	1	1	0.58	0.58	∞
Modulation response	E.2.5	3.0	R	$\sqrt{3}$	0	0	0.00	0.00	∞
Readout Electronics	E.2.6	0.021	N	1	1	1	0.021	0.021	∞
Response Time	E.2.7	0.0	R	$\sqrt{3}$	0	0	0.00	0.00	∞
Integration Time	E.2.8	1.4	R	$\sqrt{3}$	0	0	0.00	0.00	∞
RF ambient conditions-Noise	E.6.1	3.0	R	$\sqrt{3}$	1	1	1.73	1.73	∞
RF ambient conditions-reflections	E.6.1	3.0	R	$\sqrt{3}$	1	1	1.73	1.73	∞
Probe positioner mechanical tolerance	E.6.2	1.4	R	$\sqrt{3}$	1	1	0.81	0.81	∞
Probe positioning with respect to phantom shell	E.6.3	1.4	R	$\sqrt{3}$	1	1	0.81	0.81	∞
Extrapolation, interpolation, and integrations algorithms for max. SAR evaluation	E.5	2.3	R	$\sqrt{3}$	1	1	1.33	1.33	∞
<b>System validation source</b>									
Deviation of experimental dipole from numerical dipole	E.6.4	5.0	N	1	1	1	5.00	5.00	∞
Input power and SAR drift measurement	8,6.6.4	5.0	R	$\sqrt{3}$	1	1	2.89	2.89	∞
Dipole axis to liquid distance	8,E.6.6	2.0	R	$\sqrt{3}$	1	1	1.15	1.15	∞
<b>Phantom and set-up</b>									
Phantom shell uncertainty—shape, thickness, and permittivity	E.3.1	4.0	R	$\sqrt{3}$	1	1	2.31	2.31	∞
Uncertainty in SAR correction for deviations in permittivity and conductivity	E.3.2	1.9	N	1	1	0.84	1.90	1.60	∞
Liquid conductivity (temperature uncertainty)	E.3.3	2.5	R	$\sqrt{3}$	0.78	0.71	1.13	1.02	∞
Liquid conductivity (measured)	E.3.3	4	N	1	0.78	0.71	3.12	2.84	M
Liquid permittivity (temperature uncertainty)	E.3.4	2.5	R	$\sqrt{3}$	0.23	0.26	0.33	0.38	∞
Liquid permittivity (measured)	E.3.4	5	N	1	0.23	0.26	1.15	1.30	M
Combined Standard Uncertainty			RSS				10.462	10.276	
Expanded Uncertainty (95% Confidence interval)			K=2				20.924	20.551	

Any report having not been signed by authorized approver, or having been altered without authorization, or having not been stamped by the "Dedicated Testing/Inspection Stamp" is deemed to be invalid. Copying or excerpting portion of, or altering the content of the report is not permitted without the written authorization of AGC. The test results presented in the report apply only to the tested sample. Any objections to report issued by AGC should be submitted to AGC within 15days after the issuance of the test report. Further enquiry of validity or verification of the test report should be addressed to AGC by agc01@agccert.com.

SATIMO Uncertainty- SN 13/22 EPGO368									
System Check uncertainty for DUT averaged over 1 gram / 10 gram.									
Uncertainty Component	Sec.	Tol (+- %)	Prob. Dist.	Div.	Ci (1g)	Ci (10g)	1g Ui (+-%)	10g Ui (+-%)	vi
<b>Measurement System</b>									
Probe calibration drift	E.2.1.3	0.500	N	1	1	1	0.50	0.50	∞
Axial Isotropy	E.2.2	0.175	R	$\sqrt{3}$	0	0	0.00	0.00	∞
Hemispherical Isotropy	E.2.2	0.175	R	$\sqrt{3}$	0	0	0.00	0.00	∞
Boundary effect	E.2.3	1.000	R	$\sqrt{3}$	0	0	0.00	0.00	∞
Linearity	E.2.4	0.990	R	$\sqrt{3}$	0	0	0.00	0.00	∞
System detection limits	E.2.4	1.0	R	$\sqrt{3}$	0	0	0.00	0.00	∞
Modulation response	E.2.5	3.0	R	$\sqrt{3}$	0	0	0.00	0.00	∞
Readout Electronics	E.2.6	0.021	N	1	0	0	0.00	0.00	∞
Response Time	E.2.7	0	R	$\sqrt{3}$	0	0	0.00	0.00	∞
Integration Time	E.2.8	1.4	R	$\sqrt{3}$	0	0	0.00	0.00	∞
RF ambient conditions-Noise	E.6.1	3.0	R	$\sqrt{3}$	0	0	0.00	0.00	∞
RF ambient conditions-reflections	E.6.1	3.0	R	$\sqrt{3}$	0	0	0.00	0.00	∞
Probe positioner mechanical tolerance	E.6.2	1.4	R	$\sqrt{3}$	1	1	0.81	0.81	∞
Probe positioning with respect to phantom shell	E.6.3	1.4	R	$\sqrt{3}$	1	1	0.81	0.81	∞
Extrapolation, interpolation, and integrations algorithms for max. SAR evaluation	E.5	2.3	R	$\sqrt{3}$	0	0	0.00	0.00	∞
<b>System check source (dipole)</b>									
Deviation of experimental dipoles	E.6.4	2.0	N	1	1	1	2.00	2.00	∞
Input power and SAR drift measurement	8,6.6.4	5.0	R	$\sqrt{3}$	1	1	2.89	2.89	∞
Dipole axis to liquid distance	8,E.6.6	2.0	R	$\sqrt{3}$	1	1	1.15	1.15	∞
<b>Phantom and tissue parameters</b>									
Phantom shell uncertainty—shape, thickness, and permittivity	E.3.1	4	R	$\sqrt{3}$	1	1	2.31	2.31	∞
Uncertainty in SAR correction for deviations in permittivity and conductivity	E.3.2	1.9	N	1	1	0.84	1.90	1.60	∞
Liquid conductivity measurement	E.3.3	4	R	$\sqrt{3}$	0.78	0.71	3.12	2.84	∞
Liquid permittivity measurement	E.3.3	5	N	1	0.78	0.71	1.15	1.30	M
Liquid conductivity—temperature uncertainty	E.3.4	2.5	R	$\sqrt{3}$	0.23	0.26	1.13	1.02	∞
Liquid permittivity—temperature uncertainty	E.3.4	2.5	N	1	0.23	0.26	0.33	0.38	M
Combined Standard Uncertainty			RSS				5.562	5.243	
Expanded Uncertainty (95% Confidence interval)			K=2				11.124	10.406	

Any report having not been signed by authorized approver, or having been altered without authorization, or having not been stamped by the “Dedicated Testing/Inspection Stamp” is deemed to be invalid. Copying or excerpting portion of, or altering the content of the report is not permitted without the written authorization of AGC. The test results presented in the report apply only to the tested sample. Any objections to report issued by AGC should be submitted to AGC within 15days after the issuance of the test report. Further enquiry of validity or verification of the test report should be addressed to AGC by agc01@agccert.com.

## 12. CONDUCTED POWER MEASUREMENT

### UMTS BAND

#### HSDPA Setup Configuration:

- The EUT was connected to Base Station Agilent-8960 referred to the Setup Configuration.
- The RF path losses were compensated into the measurements.
- A call was established between EUT and Based Station with following setting:
  - (1) Set Gain Factors( $\beta_c$  and  $\beta_d$ ) parameters set according to each
  - (2) Set RMC 12.2Kbps+HSDPA mode.
  - (3) Set Cell Power=-86dBm
  - (4) Set HS-DSCH Configuration Type to FRC (H-set 1, QPSK)
  - (5) Select HSDPA Uplink Parameters
  - (6) Set Delta ACK, Delta NACK and Delta CQI=8
  - (7) Set Ack - Nack Repetition Factor to 3
  - (8) Set CQI Feedback Cycle (k) to 4ms
  - (9) Set CQI Repetition Factor to 2
  - (10) Power Ctrl Mode=All Up bits
- The transmitted maximum output power was recorded.

Table C.10.2.4:  $\beta$  values for transmitter characteristics tests with HS-DPCCH

Sub-test	$\beta_c$ (Note5)	$\beta_d$	$\beta_d$ (SF)	$\beta_c/\beta_d$	$\beta_{HS}$ (Note1, Note 2)	CM (dB) (Note 3)	MPR (dB) (Note 3)
1	2/15	15/15	64	2/15	4/15	0.0	0.0
2	12/15(Note 4)	15/15(Note 4)	64	12/15(Note 4)	24/15	1.0	0.0
3	15/15	8/15	64	15/8	30/15	1.5	0.5
4	15/15	4/15	64	15/4	30/15	1.5	0.5

Note 1:  $\Delta ACK, \Delta NACK$  and  $\Delta CQI = 30/15$  with  $\beta_{hs} = 30/15 * \beta_c$ .

Note 2: For the HS-DPCCH power mask requirement test in clause 5.2C, 5.7A, and the Error Vector Magnitude (EVM) with HS-DPCCH test in clause 5.13.1A, and HSDPA EVM with phase discontinuity in clause

5.13.1AA,  $\Delta ACK$  and  $\Delta NACK = 30/15$  with  $\beta_{hs} = 30/15 * \beta_c$ , and  $\Delta CQI = 24/15$  with  $\beta_{hs} = 24/15 * \beta_c$ .

Note 3: CM = 1 for  $\beta_c/\beta_d = 12/15$ ,  $hs/c = 24/15$ . For all other combinations of DPDCH, DPCCH and HS-DPCCH the MPR is based on the relative CM difference. This is applicable for only UEs that support HSDPA in release 6 and later releases.

Note 4: For subtest 2 the  $c/d$  ratio of 12/15 for the TFC during the measurement period (TF1, TF0) is achieved by setting the signalled gain factors for the reference TFC (TF1, TF1) to  $c = 11/15$  and  $d = 15/15$ .

**HSUPA Setup Configuration:**

- The EUT was connected to Base Station Agilent-8960 referred to the Setup Configuration.
- The RF path losses were compensated into the measurements.
- A call was established between EUT and Base Station with following setting \* :
  - (1) Call Configs = 5.2B, 5.9B, 5.10B, and 5.13.2B with QPSK
  - (2) Set the Gain Factors ( $\beta_c$  and  $\beta_d$ ) and parameters (AG Index) were set according to each specific sub-test in the following table, C11.1.3, quoted from the TS 34.121
  - (3) Set Cell Power = -86 dBm
  - (4) Set Channel Type = 12.2k + HSPA
  - (5) Set UE Target Power
  - (6) Power Ctrl Mode= Alternating bits
  - (7) Set and observe the E-TFCI
  - (8) Confirm that E-TFCI is equal to the target E-TFCI of 75 for sub-test 1, and other subtest's E-TFCI
- The transmitted maximum output power was recorded.

Table C.11.1.3:  $\beta$  values for transmitter characteristics tests with HS-DPCCH and E-DCH

Sub-test	$\beta_c$	$\beta_d$	$\beta_d$ (SF)	$\beta_c/\beta_d$	$\beta_{HS}$ (Note 1)	$\beta_{ec}$	$\beta_{ed}$ (Note 4) (Note 5)	$\beta_{ed}$ (SF)	$\beta_{ed}$ (Codes)	CM (dB) (Note 2)	MPR (dB) (Note 2) (Note 6)	AG Index (Note 5)	E-TF CI
1	11/15 (Note 3)	15/15 (Note 3)	64	11/15 (Note 3)	22/15	209/225	1309/225	4	1	1.0	0.0	20	75
2	6/15	15/15	64	6/15	12/15	12/15	94/75	4	1	3.0	2.0	12	67
3	15/15	9/15	64	15/9	30/15	30/15	$\beta_{ed1}$ : 47/15 $\beta_{ed2}$ : 47/15	4 4	2	2.0	1.0	15	92
4	2/15	15/15	64	2/15	4/15	2/15	56/75	4	1	3.0	2.0	17	71
5	15/15	0	-	-	5/15	5/15	47/15	4	1	1.0	0.0	12	67

Note 1: For sub-test 1 to 4,  $\Delta ACK$ ,  $\Delta NACK$  and  $\Delta CQI = 30/15$  with  $\beta_{hs} = 30/15 * \beta_c$ . For sub-test 5,  $\Delta ACK$ ,  $\Delta NACK$  and  $\Delta CQI = 5/15$  with  $\beta_{hs} = 5/15 * \beta_c$ .

Note 2: CM = 1 for  $\beta_c/\beta_d = 12/15$ ,  $hs/c = 24/15$ . For all other combinations of DPDCH, DPCCH, HS-DPCCH, E-DPDCH and E-DPCCH the MPR is based on the relative CM difference.

Note 3: For subtest 1 the  $c/d$  ratio of 11/15 for the TFC during the measurement period (TF1, TF0) is achieved by setting the signalled gain factors for the reference TFC (TF1, TF1) to  $c = 10/15$  and  $d = 15/15$ .

Note 4: In case of testing by UE using E-DPDCH Physical Layer category 1, Sub-test 3 is omitted according to TS25.306 Table 5.1g.

Note 5:  $\beta_{ed}$  cannot be set directly; it is set by Absolute Grant Value.

Note 6: For subtests 2, 3 and 4, UE may perform E-DPDCH power scaling at max power which could results in slightly smaller MPR values.

**UMTS BAND V**

Mode	Frequency (MHz)	Avg. Burst Power (dBm)
WCDMA 1700 RMC	1712.4	23.46
	1732.4	23.46
	1752.6	<b>23.48</b>
HSDPA Subtest 1	1712.4	22.42
	1732.4	22.40
	1752.6	22.42
HSDPA Subtest 2	1712.4	18.40
	1732.4	18.30
	1752.6	18.27
HSDPA Subtest 3	1712.4	16.53
	1732.4	16.52
	1752.6	16.48
HSDPA Subtest 4	1712.4	15.38
	1732.4	15.34
	1752.6	15.26
HSUPA Subtest 1	1712.4	12.87
	1732.4	20.24
	1752.6	20.24
HSUPA Subtest 2	1712.4	15.51
	1732.4	20.33
	1752.6	20.22
HSUPA Subtest 3	1712.4	10.18
	1732.4	21.24
	1752.6	21.09
HSUPA Subtest 4	1712.4	16.26
	1732.4	19.80
	1752.6	19.67
HSUPA Subtest 5	1712.4	16.96
	1732.4	19.27
	1752.6	19.52

Any report having not been signed by authorized approver, or having been altered without authorization, or having not been stamped by the "Dedicated Testing/Inspection Stamp" is deemed to be invalid. Copying or excerpting portion of, or altering the content of the report is not permitted without the written authorization of AGC. The test results presented in the report apply only to the tested sample. Any objections to report issued by AGC should be submitted to AGC within 15days after the issuance of the test report. Further enquiry of validity or verification of the test report should be addressed to AGC by agc01@agccert.com.



According to 3GPP 25.101 sub-clause 6.2.2 , the maximum output power is allowed to be reduced by following the table.

Table 6.1aA: UE maximum output power with HS-DPCCH and E-DCH

UE Transmit Channel Configuration	CM(db)	MPR(db)
For all combinations of ,DPDCH,DPCCH HS-DPDCH,E-DPDCH and E-DPCCH	$0 \leq CM \leq 3.5$	$MAX(CM-1,0)$
Note: CM=1 for $\beta_d/\beta_{d'}=12/15$ , $\beta_{hs}/\beta_c=24/15$ .For all other combinations of DPDCH, DPCCH, HS-DPCCH, E-DPDCH and E-DPCCH the MPR is based on the relative CM difference.		

The device supports MPR to solve linearity issues (ACLR or SEM) due to the higher peak-to average ratios (PAR) of the HSUPA signal. This prevents saturating the full range of the TX DAC inside of device and provides a reduced power output to the RF transceiver chip according to the Cubic Metric (a function of the combinations of DPDCH, DPCCH, HS-DPCCH, E-DPDCH and E-DPCCH).

When E-DPDCH channels are present the beta gains on those channels are reduced firsts to try to get the power under the allowed limit. If the beta gains are lowered as far as possible, then a hard limiting is applied at the maximum allowed level.

The SW currently recalculates the cubic metric every time the beta gains on the E-DPDCH are reduced. The cubic metric will likely get lower each time this is done .However, there is no reported reduction of maximum output power in the HSUPA mode since the device also provides a compensation for the power back-off by increasing the gain of TX\_AGC in the transceiver (PA) device.

The end effect is that the DUT output power is identical to the case where there is no MPR in the device.

**LTE Band**

**LTE (TDD) Considerations**

For Time-Division Duplex (TDD) systems, SAR must be tested using a fixed periodic duty factor according to the highest transmission duty factor implemented for the device and supported by the defined 3GPP LTE TDD configurations.

SAR was tested with the highest transmission duty factor (63.33%) using Uplink-downlink configuration 0 and Special subframe configuration 7.

LTE TDD Band 41 supports 3GPP TS 36.211 section 4.2 for Type 2 Frame Structure and Table 4.2-2 for uplink-downlink configurations and Table 4.2-1 for Special subframe configurations.

**Table 4.2-1: Configuration of special subframe (lengths of DwPTS/GP/UpPTS)**

Special subframe configuration	Normal cyclic prefix in downlink			Extended cyclic prefix in downlink		
	DwPTS	UpPTS		DwPTS	UpPTS	
		Normal cyclic prefix in uplink	Extended cyclic prefix in uplink		Normal cyclic prefix in uplink	Extended cyclic prefix in uplink
0	$6592 \cdot T_s$	$2192 \cdot T_s$	$2560 \cdot T_s$	$7680 \cdot T_s$	$2192 \cdot T_s$	$2560 \cdot T_s$
1	$19760 \cdot T_s$			$20480 \cdot T_s$		
2	$21952 \cdot T_s$			$23040 \cdot T_s$		
3	$24144 \cdot T_s$			$25600 \cdot T_s$		
4	$26336 \cdot T_s$			$7680 \cdot T_s$		
5	$6592 \cdot T_s$	$4384 \cdot T_s$	$5120 \cdot T_s$	$20480 \cdot T_s$	$4384 \cdot T_s$	$5120 \cdot T_s$
6	$19760 \cdot T_s$			$23040 \cdot T_s$		
7	$21952 \cdot T_s$			$12800 \cdot T_s$		
8	$24144 \cdot T_s$			-		
9	$13168 \cdot T_s$			-		

**Table 4.2-2: Uplink-downlink configurations**

Uplink-downlink configuration	Downlink-to-Uplink Switch-point periodicity	Subframe number									
		0	1	2	3	4	5	6	7	8	9
0	5 ms	D	S	U	U	U	D	S	U	U	U
1	5 ms	D	S	U	U	D	D	S	U	U	D
2	5 ms	D	S	U	D	D	D	S	U	D	D
3	10 ms	D	S	U	U	U	D	D	D	D	D
4	10 ms	D	S	U	U	D	D	D	D	D	D
5	10 ms	D	S	U	D	D	D	D	D	D	D
6	5 ms	D	S	U	U	U	D	S	U	U	D

Any report having not been signed by authorized approver, or having been altered without authorization, or having not been stamped by the “Dedicated Testing/Inspection Stamp” is deemed to be invalid. Copying or excerpting portion of, or altering the content of the report is not permitted without the written authorization of AGC. The test results presented in the report apply only to the tested sample. Any objections to report issued by AGC should be submitted to AGC within 15days after the issuance of the test report. Further enquiry of validity or verification of the test report should be addressed to AGC by agc01@agccert.com.

### Calculated Duty Cycle

Uplink-Downlink Configuration	Downlink-to-Uplink Switch-point Periodicity	Subframe Number										Calculated Duty Cycle(%)
		0	1	2	3	4	5	6	7	8	9	
0	5ms	D	S	U	U	U	D	S	U	U	U	63.33
1	5ms	D	S	U	U	D	D	S	U	U	D	43.33
2	5ms	D	S	U	D	D	D	S	U	D	D	23.33
3	10ms	D	S	U	U	U	D	D	D	D	D	31.67
4	10ms	D	S	U	U	D	D	D	D	D	D	21.67
5	10ms	D	S	U	D	D	D	D	D	D	D	11.67
6	5ms	D	S	U	U	U	D	S	U	U	D	53.33

**Note:** Calculated Duty Cycle = Extended cyclic prefix in uplink x (Ts) x # of S + # of U

Example for Calculated Duty Cycle for Uplink-Downlink Configuration 0:

Calculated Duty Cycle =  $5120 \times [1/(15000 \times 2048)] \times 2 + 6 \text{ ms} = 63.33\%$

where

$T_s = 1/(15000 \times 2048)$  seconds

**LTE Band**

Conducted Power of LTE Band 5(dBm)							
Bandwidth	Modulation	RB size	RB offset	Target MPR	Channel	Channel	Channel
					20407	20525	20643
1.4MHz	QPSK	1	0	0	22.42	22.26	22.88
			3	0	22.51	22.50	<b>23.01</b>
			5	0	22.38	22.36	22.86
		3	0	0	22.43	22.38	22.91
			2	0	22.39	22.40	22.92
			3	0	22.37	22.43	22.97
	6	0	1	21.45	21.45	21.88	
	16QAM	1	0	1	21.22	21.22	21.67
			3	1	21.35	21.45	21.79
			5	1	21.21	21.26	21.62
		3	0	1	21.23	21.17	21.71
			2	1	21.23	21.17	21.72
			3	1	21.21	21.21	21.69
	6	0	2	20.28	20.44	20.75	
	Bandwidth	Modulation	RB size	RB offset	Target MPR	Channel	Channel
20415						20525	20635
3MHz	QPSK	1	0	0	22.34	22.12	22.87
			7	0	22.27	22.39	22.92
			14	0	22.22	22.47	22.91
		8	0	1	21.36	21.23	21.86
			4	1	21.37	21.26	21.86
			7	1	21.32	21.40	21.81
	15	0	1	21.32	21.29	21.82	
	16QAM	1	0	1	21.39	21.17	21.74
			7	1	21.32	21.35	21.67
			14	1	21.16	21.47	21.65
		8	0	2	20.35	20.32	20.86
			4	2	20.33	20.34	20.91
			7	2	20.27	20.45	20.83
	15	0	2	20.22	20.33	20.78	

Any report having not been signed by authorized approver, or having been altered without authorization, or having not been stamped by the "Dedicated Testing/Inspection Stamp" is deemed to be invalid. Copying or excerpting portion of, or altering the content of the report is not permitted without the written authorization of AGC. The test results presented in the report apply only to the tested sample. Any objections to report issued by AGC should be submitted to AGC within 15days after the issuance of the test report. Further enquiry of validity or verification of the test report should be addressed to AGC by agc01@agccert.com.

Conducted Power of LTE Band 5(dBm)								
Bandwidth	Modulation	RB size	RB offset	Target MPR	Channel	Channel	Channel	
					20425	20525	20625	
5MHz	QPSK	1	0	0	22.32	22.08	22.76	
			13	0	22.31	22.43	22.89	
			24	0	22.04	22.56	22.78	
		12	0	1	21.28	21.21	21.87	
			6	1	21.30	21.20	21.83	
			13	1	21.14	21.46	21.79	
		25	0	1	21.23	21.32	21.84	
		16QAM	1	0	1	21.32	21.01	21.82
				13	1	21.20	21.33	21.93
	24			1	20.95	21.45	21.79	
	12		0	2	20.17	20.18	20.92	
			6	2	20.20	20.20	20.94	
			13	2	20.14	20.46	20.85	
	25	0	2	20.22	20.37	20.87		
	Bandwidth	Modulation	RB size	RB offset	Target MPR	Channel	Channel	Channel
20450						20525	20600	
10MHz	QPSK	1	0	0	22.34	22.05	22.68	
			25	0	22.11	22.52	22.85	
			49	0	22.00	22.84	22.89	
		25	0	1	21.23	21.18	21.80	
			13	1	21.27	21.20	21.82	
			25	1	20.99	21.62	21.86	
		50	0	1	21.06	21.38	21.83	
		16QAM	1	0	1	21.35	20.81	21.46
				25	1	21.12	21.31	21.76
	49			1	20.98	21.62	21.65	
	25		0	2	20.22	20.30	20.87	
			13	2	20.22	20.25	20.85	
			25	2	19.98	20.69	20.93	
	50		0	2	20.11	20.43	20.86	

Any report having not been signed by authorized approver, or having been altered without authorization, or having not been stamped by the "Dedicated Testing/Inspection Stamp" is deemed to be invalid. Copying or excerpting portion of, or altering the content of the report is not permitted without the written authorization of AGC. The test results presented in the report apply only to the tested sample. Any objections to report issued by AGC should be submitted to AGC within 15days after the issuance of the test report. Further enquiry of validity or verification of the test report should be addressed to AGC by agc01@agccert.com.

Conducted Power of LTE Band 41(dBm)							
Bandwidth	Modulation	RB size	RB offset	Target MPR	Channel	Channel	Channel
					39675	40620	41565
5MHz	QPSK	1	0	0	19.30	20.29	19.90
			12	0	20.71	20.42	18.96
			24	0	20.36	20.39	18.29
		12	0	1	19.98	20.39	19.33
			6	1	20.01	21.15	19.32
			13	1	21.34	21.15	18.60
	25	1	20.75	21.19	19.95		
	16QAM	1	0	1	19.80	20.61	19.32
			12	1	20.23	20.76	18.55
			24	1	21.36	20.72	19.90
		12	0	2	19.31	20.17	19.71
			6	2	19.32	20.15	19.69
			13	2	20.64	20.18	19.98
	25	2	20.01	20.21	19.32		
Bandwidth	Modulation	RB size	RB offset	Target MPR	Channel	Channel	Channel
					39700	40620	41540
10MHz	QPSK	1	0	0	20.43	20.32	20.26
			24	0	20.84	20.48	20.63
			49	0	20.10	20.42	20.27
		25	0	1	21.83	20.28	20.37
			12	1	21.81	20.27	20.37
			25	1	20.20	20.38	20.99
	50	1	20.09	20.31	20.77		
	16QAM	1	0	1	19.67	20.34	20.83
			24	1	22.10	20.48	20.24
			49	1	20.46	20.44	20.88
		25	0	2	21.09	20.35	20.90
			12	2	21.06	20.37	20.89
			25	2	20.47	20.45	20.42
	50	2	<b>22.39</b>	20.36	20.15		

Any report having not been signed by authorized approver, or having been altered without authorization, or having not been stamped by the "Dedicated Testing/Inspection Stamp" is deemed to be invalid. Copying or excerpting portion of, or altering the content of the report is not permitted without the written authorization of AGC. The test results presented in the report apply only to the tested sample. Any objections to report issued by AGC should be submitted to AGC within 15days after the issuance of the test report. Further enquiry of validity or verification of the test report should be addressed to AGC by agc01@agccert.com.

Conducted Power of LTE Band 41(dBm)							
Bandwidth	Modulation	RB size	RB offset	Target MPR	Channel	Channel	Channel
					39725	40620	41515
15MHz	QPSK	1	0	0	20.63	21.34	20.63
			37	0	20.39	20.33	20.50
			74	0	20.04	20.44	20.41
		37	0	1	20.63	21.40	20.56
			19	1	21.61	20.36	20.53
			38	1	21.62	20.38	20.50
	75	0	1	20.61	20.41	20.48	
	16QAM	1	0	1	19.84	20.35	20.37
			37	1	21.55	20.39	20.10
			74	1	20.10	20.42	20.03
		37	0	2	20.61	21.42	20.54
			19	2	20.61	21.39	20.51
			38	2	20.62	20.40	20.49
	75	0	2	20.99	20.35	20.03	
Bandwidth	Modulation	RB size	RB offset	Target MPR	Channel	Channel	Channel
					39750	40620	41490
20MHz	QPSK	1	0	0	21.03	20.36	20.67
			49	0	21.07	20.14	20.89
			99	0	21.70	20.27	20.74
		50	0	1	20.31	19.86	20.15
			25	1	20.44	19.87	20.16
			50	1	20.76	19.96	20.07
	100	0	1	20.52	19.96	20.11	
	16QAM	1	0	1	21.06	20.60	21.14
			49	1	21.29	20.54	21.17
			99	1	21.73	20.51	20.91
		50	0	2	19.71	19.33	19.44
			25	2	19.72	19.34	19.45
			50	2	19.93	19.19	19.34
	100	0	2	19.69	19.17	19.36	

Any report having not been signed by authorized approver, or having been altered without authorization, or having not been stamped by the "Dedicated Testing/Inspection Stamp" is deemed to be invalid. Copying or excerpting portion of, or altering the content of the report is not permitted without the written authorization of AGC. The test results presented in the report apply only to the tested sample. Any objections to report issued by AGC should be submitted to AGC within 15days after the issuance of the test report. Further enquiry of validity or verification of the test report should be addressed to AGC by agc01@agccert.com.

The following tests were conducted according to the test requirements outlined in section 6.2 of the 3GPP TS36.101 specification.

UE Power Class: 3 (23 +/- 2dBm). The allowed Maximum Power Reduction (MPR) for the maximum output power due to higher order modulation and transmit bandwidth configuration (resource blocks) is specified in Table 6.2.3.3-1 of the 3GPP TS36.101.

**Table 6.2.3.3-1 Maximum Power Reduction (MPR) for Power class3**

Modulation	Maximum Power Reduction (MPR) for Power[RB]						MPR(dB)
	1.4MHz	3MHz	5MHz	10MHz	15MHz	20MHz	
QPSK	>5	>4	>8	>12	>16	>18	≤1
16QAM	≤5	≤4	≤8	≤12	≤16	≤18	≤1
16QAM	>5	>4	>8	>12	>16	>18	≤2

The allowed A-MPR values specified below in Table 6.2.4.3-1 of 3GPP TS36.101 are in addition to the allowed MPR requirements. All the measurements below were performed with A-MPR disabled, by using Network Signaling Value of "NS\_01".3



**Table 6.2.4.3-1: Additional Maximum Power Reduction (A-MPR) / Spectrum Emission requirements**

Network Signaling value	Requirements (sub-clause)	E-UTRA Band	Channel bandwidth (MHz)	Resources Blocks ( $N_{RB}$ )	A-MPR (dB)
NS_01	6.6.2.1.1	Table 5.2-1	1.4,3,5,10,15,20	Table 5.4.2-1	N/A
NS_03	6.6.2.2.3.1	2,4,10, 23, 25,35,36	3	>5	$\leq 1$
			5	>6	$\leq 1$
			10	>6	$\leq 1$
			15	>8	$\leq 1$
			20	>10	$\leq 1$
NS_04	6.6.2.2.3.2	41	5	>6	$\leq 1$
			10, 15, 20	Table 6.2.4.3-4	
NS_05	6.6.3.3.3.1	1	10,15,20	$\geq 50$	$\leq 1$
NS_06	6.6.2.2.3.3	12, 13, 14, 17	1.4, 3, 5, 10	Table 5.4.2-1	N/A
NS_07	6.6.2.2.3.3 6.6.3.3.3.2	13	10	Table 6.2.4.3-2	Table 6.2.4.3-2
NS_08	6.6.3.3.3.3	19	10, 15	> 44	$\leq 3$
NS_09	6.6.3.3.3.4	21	10, 15	> 40	$\leq 1$
				> 55	$\leq 2$
				Table 6.2.4.3-3	
NS_10		20	15, 20	Table 6.2.4.3-3	Table 6.2.4.3-3
NS_11	6.6.2.2.1 6.6.3.3.13	231	1.4, 3, 5, 10,15,20	Table 6.2.4.3-5	Table 6.2.4.3-5
NS_12	6.6.3.3.5	26	1.4, 3, 5	Table 6.2.4.3-6	Table 6.2.4.3-6
NS_13	6.6.3.3.6	26	5	Table 6.2.4.3-7	Table 6.2.4.3-7
NS_14	6.6.3.3.7	26	10, 15	Table 6.2.4.3-8	Table 6.2.4.3-8
NS_15	6.6.3.3.8	26	1.4, 3, 5, 10, 15	Table 6.2.4.3-9 Table 6.2.4.3-10	Table 6.2.4.3-9, Table 6.2.4.3-10
NS_16	6.6.3.3.9	27	3, 5, 10	Table 6.2.4.3-11, Table 6.2.4.3-12, Table 6.2.4.3-13	
NS_17	6.6.3.3.10 6.6.3.3.11	28 28	5, 10	Table 5.4.2-1	N/A
			5	$\geq 2$	$\leq 1$
NS_18			10, 15, 20	$\geq 1$	$\leq 4$
NS_19			10, 15, 20	Table 6.2.4.3-15	Table 6.2.4.3-15
NS_20			5, 10, 15, 20	Table 6.2.4.3-14	Table 6.2.4.3-14
...					
NS_20	-	-	-	-	-

Any report having not been signed by authorized approver, or having been altered without authorization, or having not been stamped by the "Dedicated Testing/Inspection Stamp" is deemed to be invalid. Copying or excerpting portion of, or altering the content of the report is not permitted without the written authorization of AGC. The test results presented in the report apply only to the tested sample. Any objections to report issued by AGC should be submitted to AGC within 15days after the issuance of the test report. Further enquiry of validity or verification of the test report should be addressed to AGC by agc01@agccert.com.

**WIFI**

Mode	Data Rate (Mbps)	Channel	Frequency(MHz)	Avg. Burst Power(dBm)
802.11b	1	01	2412	17.20
		06	2437	<b>17.47</b>
		11	2462	17.04
802.11g	6	01	2412	14.54
		06	2437	14.80
		11	2462	14.73
802.11n(20)	6.5	01	2412	13.27
		06	2437	13.75
		11	2462	13.43
802.11n(40)	13.5	03	2422	12.84
		06	2437	12.67
		09	2452	12.67

**Bluetooth\_V4.0(BLE)**

Modulation	Channel	Frequency(MHz)	Peak Power (dBm)
GFSK	0	2402	-0.776
	19	2440	<b>-0.164</b>
	39	2480	-1.317

Any report having not been signed by authorized approver, or having been altered without authorization, or having not been stamped by the "Dedicated Testing/Inspection Stamp" is deemed to be invalid. Copying or excerpting portion of, or altering the content of the report is not permitted without the written authorization of AGC. The test results presented in the report apply only to the tested sample. Any objections to report issued by AGC should be submitted to AGC within 15days after the issuance of the test report. Further enquiry of validity or verification of the test report should be addressed to AGC by agc01@agccert.com.

5GHz WIFI

Mode	channel	Frequency	Power(dBm)							
			Data Rate(bps)							
			6M	9M	12M	18M	24M	36M	48M	54M
802.11a	36	5180	14.30	14.16	13.97	13.91	13.73	13.69	13.65	13.59
	40	5200	15.22	15.12	14.93	14.80	14.61	14.52	14.39	14.30
	44	5220	15.16	14.98	14.93	14.83	14.72	14.59	14.59	14.56
	48	5240	14.30	14.25	14.12	13.94	13.80	13.64	13.64	13.57
	52	5260	14.18	14.06	13.92	13.84	13.68	13.65	13.65	13.59
	56	5280	14.06	14.04	13.89	13.71	13.64	13.45	13.42	13.24
	60	5300	14.31	14.12	13.94	13.91	13.77	13.59	13.45	13.29
	64	5320	<b>15.77</b>	15.72	15.64	15.55	15.51	15.46	15.26	15.25
	100	5500	<b>14.82</b>	14.79	14.72	14.60	14.53	14.36	14.32	14.15
	104	5520	14.76	14.65	14.62	14.54	14.44	14.42	14.34	14.34
	108	5540	14.62	14.44	14.43	14.26	14.23	14.23	14.10	13.97
	112	5560	13.86	13.83	13.80	13.67	13.65	13.56	13.43	13.33
	116	5580	13.22	13.03	12.92	12.90	12.78	12.60	12.57	12.39
	120	5600	12.42	12.37	12.27	12.24	12.08	12.02	11.87	11.73
	124	5620	12.65	12.60	12.58	12.56	12.45	12.35	12.24	12.16
	128	5640	12.79	12.72	12.56	12.54	12.40	12.26	12.16	11.99
	132	5660	13.02	12.83	12.83	12.77	12.75	12.66	12.50	12.46
	136	5680	13.11	13.10	13.08	12.94	12.74	12.61	12.56	12.51
140	5700	13.20	13.01	12.95	12.79	12.78	12.69	12.64	12.45	
149	5745	<b>13.00</b>	12.91	12.74	12.73	12.67	12.55	12.54	12.40	
157	5785	10.73	10.59	10.47	10.33	10.28	10.24	10.11	10.04	
165	5825	11.08	11.01	10.99	10.80	10.68	10.54	10.47	10.29	

Any report having not been signed by authorized approver, or having been altered without authorization, or having not been stamped by the "Dedicated Testing/Inspection Stamp" is deemed to be invalid. Copying or excerpting portion of, or altering the content of the report is not permitted without the written authorization of AGC. The test results presented in the report apply only to the tested sample. Any objections to report issued by AGC should be submitted to AGC within 15days after the issuance of the test report. Further enquiry of validity or verification of the test report should be addressed to AGC by agc01@agccert.com.

Mode	channel	Frequency	Power(dBm)							
			Data Rate(bps)							
			MCS0	MCS1	MCS2	MCS3	MCS4	MCS5	MCS6	MCS7
802.11n (20)	36	5180	15.35	15.34	15.17	15.08	15.07	14.94	14.80	14.62
	40	5200	<b>15.91</b>	15.82	15.80	15.73	15.68	15.68	15.49	15.38
	44	5220	15.82	15.74	15.72	15.52	15.41	15.37	15.29	15.10
	48	5240	13.69	13.51	13.42	13.27	13.07	12.92	12.83	12.81
	52	5260	14.19	14.14	13.95	13.86	13.86	13.68	13.63	13.44
	56	5280	14.06	13.86	13.78	13.73	13.56	13.49	13.30	13.19
	60	5300	14.62	14.57	14.42	14.26	14.18	14.02	13.91	13.76
	64	5320	14.95	14.92	14.83	14.82	14.62	14.61	14.43	14.32
	100	5500	14.75	14.63	14.61	14.55	14.42	14.29	14.15	14.12
	104	5520	14.22	14.19	14.05	13.99	13.90	13.86	13.80	13.75
	108	5540	13.68	13.65	13.63	13.55	13.47	13.45	13.29	13.10
	112	5560	13.27	13.24	13.12	12.95	12.83	12.83	12.63	12.49
	116	5580	12.63	12.57	12.45	12.32	12.22	12.05	11.96	11.78
	120	5600	12.97	12.78	12.72	12.65	12.57	12.56	12.50	12.44
	124	5620	13.06	12.98	12.89	12.85	12.75	12.60	12.54	12.47
	128	5640	13.11	13.01	12.86	12.84	12.68	12.61	12.53	12.47
	132	5660	13.16	13.10	12.97	12.88	12.83	12.72	12.53	12.44
136	5680	13.20	13.06	12.94	12.81	12.70	12.51	12.51	12.38	
140	5700	13.36	13.30	13.12	13.09	13.07	12.97	12.88	12.72	
149	5745	11.59	11.56	11.49	11.32	11.23	11.07	10.91	10.82	
157	5785	11.65	11.49	11.46	11.45	11.26	11.16	11.03	10.93	
165	5825	11.72	11.54	11.38	11.23	11.20	11.15	11.04	10.94	
			MCS0	MCS1	MCS2	MCS3	MCS4	MCS5	MCS6	MCS7
802.11n (40)	38	5190	14.52	14.49	14.38	14.34	14.26	14.14	14.09	14.01
	46	5230	14.29	14.21	14.07	13.99	13.80	13.75	13.64	13.57
	54	5270	14.27	14.16	14.15	13.98	13.85	13.68	13.56	13.45
	62	5310	14.71	14.64	14.55	14.44	14.29	14.29	14.12	13.96
	102	5510	14.17	14.10	13.97	13.86	13.85	13.66	13.61	13.53
	110	5550	14.06	13.88	13.77	13.59	13.55	13.36	13.27	13.25
	118	5590	12.73	12.57	12.39	12.21	12.07	12.06	12.01	12.00
	126	5630	12.68	12.61	12.48	12.28	12.14	12.12	11.96	11.83
	134	5670	13.40	13.32	13.31	13.17	13.09	12.97	12.79	12.74
	151	5755	12.67	12.53	12.39	12.39	12.36	12.22	12.18	12.09
159	5795	12.82	12.73	12.58	12.46	12.44	12.42	12.36	12.28	

Any report having not been signed by authorized approver, or having been altered without authorization, or having not been stamped by the "Dedicated Testing/Inspection Stamp" is deemed to be invalid. Copying or excerpting portion of, or altering the content of the report is not permitted without the written authorization of AGC. The test results presented in the report apply only to the tested sample. Any objections to report issued by AGC should be submitted to AGC within 15days after the issuance of the test report. Further enquiry of validity or verification of the test report should be addressed to AGC by agc01@agccert.com.

Mode	channel	Frequency	Power(dBm)							
			Data Rate(bps)							
			MCS0	MCS1	MCS2	MCS3	MCS4	MCS5	MCS6	MCS7
802.11ac (20)	36	5180	15.81	15.63	15.50	15.35	15.32	15.17	15.16	15.09
	40	5200	14.13	13.94	13.81	13.80	13.66	13.48	13.40	13.39
	44	5220	14.03	13.93	13.75	13.72	13.65	13.61	13.54	13.39
	48	5240	13.07	12.96	12.83	12.75	12.72	12.69	12.66	12.54
	52	5260	14.02	13.97	13.81	13.74	13.72	13.68	13.58	13.42
	56	5280	14.00	13.84	13.69	13.64	13.51	13.38	13.26	13.12
	60	5300	14.17	14.16	14.10	13.98	13.86	13.80	13.75	13.70
	64	5320	15.71	15.71	15.54	15.42	15.34	15.17	15.05	15.03
	100	5500	13.71	13.61	13.52	13.39	13.29	13.10	13.07	12.89
	104	5520	12.89	12.83	12.76	12.65	12.56	12.52	12.40	12.27
	108	5540	12.65	12.48	12.45	12.43	12.32	12.23	12.15	12.14
	112	5560	11.72	11.71	11.67	11.57	11.54	11.54	11.42	11.22
	116	5580	11.13	10.97	10.92	10.85	10.80	10.63	10.44	10.35
	120	5600	10.78	10.62	10.59	10.51	10.46	10.45	10.32	10.30
	124	5620	11.26	11.24	11.22	11.09	10.94	10.89	10.80	10.75
	128	5640	12.09	11.97	11.81	11.74	11.72	11.67	11.47	11.29
	132	5660	13.01	12.88	12.81	12.69	12.66	12.55	12.43	12.27
	136	5680	13.22	13.19	13.01	12.86	12.79	12.65	12.50	12.36
140	5700	13.56	13.38	13.37	13.37	13.33	13.21	13.08	13.05	
149	5745	10.03	9.84	9.80	9.77	9.67	9.61	9.45	9.28	
157	5785	10.35	10.25	10.16	10.00	9.82	9.69	9.60	9.44	
165	5825	10.11	10.09	10.03	9.98	9.90	9.79	9.71	9.61	
			MCS0	MCS1	MCS2	MCS3	MCS4	MCS5	MCS6	MCS7
802.11ac (40)	38	5190	15.46	15.27	15.11	14.94	14.91	14.90	14.86	14.72
	46	5230	13.68	13.66	13.60	13.58	13.46	13.34	13.15	12.99
	54	5270	14.33	14.29	14.25	14.12	14.02	13.84	13.64	13.61
	62	5310	14.95	14.95	14.76	14.57	14.49	14.38	14.26	14.24
	102	5510	14.62	14.62	14.42	14.27	14.18	14.14	14.05	13.94
	110	5550	14.34	14.15	14.14	14.05	13.96	13.90	13.88	13.71
	118	5590	11.07	11.05	11.04	10.85	10.78	10.66	10.61	10.50
	126	5630	11.01	11.01	10.84	10.72	10.71	10.60	10.40	10.34
	134	5670	12.39	12.24	12.18	12.12	12.12	12.00	11.80	11.61
	151	5755	10.44	10.25	10.19	10.16	9.99	9.91	9.85	9.70
159	5795	12.40	12.33	12.32	12.22	12.10	11.90	11.72	11.65	
			MCS0	MCS1	MCS2	MCS3	MCS4	MCS5	MCS6	MCS7
802.11ac (80)	42	5210	14.63	14.46	14.35	14.34	14.17	14.16	14.04	13.93
	58	5290	13.00	12.96	12.94	12.79	12.73	12.67	12.55	12.39
	106	5530	11.51	11.49	11.32	11.30	11.16	10.96	10.82	10.67
	122	5610	11.07	10.92	10.81	10.77	10.75	10.62	10.56	10.55
	138	5690	11.00	10.90	10.71	10.62	10.46	10.32	10.12	9.97
155	5775	10.73	10.70	10.65	10.63	10.55	10.48	10.35	10.15	

Any report having not been signed by authorized approver, or having been altered without authorization, or having not been stamped by the "Dedicated Testing/Inspection Stamp" is deemed to be invalid. Copying or excerpting portion of, or altering the content of the report is not permitted without the written authorization of AGC. The test results presented in the report apply only to the tested sample. Any objections to report issued by AGC should be submitted to AGC within 15days after the issuance of the test report. Further enquiry of validity or verification of the test report should be addressed to AGC by agc01@agccert.com.

## 13. TEST RESULTS

### 13.1. SAR Test Results Summary

#### 13.1.1. Test position and configuration

Body-worn and 4 Edges SAR was performed with the device 0mm from the phantom.

#### 13.1.2. Operation Mode

1. Per KDB 447498 D01 v06 ,for each exposure position, if the highest 1-g SAR is  $\leq 0.8$  W/kg, testing for low and high channel is optional.
2. Per KDB 865664 D01 v01r04,for each frequency band, if the measured SAR is  $\geq 0.8$ W/kg, testing for repeated SAR measurement is required , that the highest measured SAR is only to be tested. When the SAR results are near the limit, the following procedures are required for each device to verify these types of SAR measurement related variation concerns by repeating the highest measured SAR configuration in each frequency band.
  - (1) When the original highest measured SAR is  $\geq 0.8$ W/kg, repeat that measurement once.
  - (2) Perform a second repeated measurement only if the ratio of largest to smallest SAR for the original and first repeated measurements is  $>1.20$  or when the original or repeated measurement is  $\geq 1.45$  W/kg.
  - (3) Perform a third repeated measurement only if the original, first and second repeated measurement is  $\geq 1.5$  W/kg and ratio of largest to smallest SAR for the original, first and second measurement is  $\geq 1.20$ .
3. Body-worn exposure conditions are intended to voice call operations, therefore GSM voice call mode is selected to be test.
4. Per KDB 648474 D04 v01r03,when the reported SAR for a body-worn accessory measured without a headset connected to the handset is  $\leq 1.2$ W/kg, SAR testing with a headset connected is not required.
5. Per KDB 248227 D01v02r02,for 2.4GHz 802.11g/n SAR testing is not required when the highest reported SAR for DSSS is adjusted by the ratio of OFDM to DSSS specified maximum output power and the adjusted SAR is  $\leq 1.2$ W/kg.
6. Per KDB 248227 D01 v02r02 Chapter 5.3.4, SAR measurement requirements for the remaining 802.11 transmission mode configurations that have not been tested in the initial test configuration are determined separately for each standalone and aggregated frequency band, in each exposure condition, according to the maximum output power specified for production units. The initial test position procedure is applied to next to the ear, UMPC mini-tablet and hotspot mode configurations. When the same maximum output power is specified for multiple transmission modes, the procedures in 5.3.2 are applied to determine the test configuration. Additional power measurements may be required to determine if SAR measurements are required for subsequent highest output power channels in a subsequent test configuration. The subsequent test configuration and SAR measurement procedures are described in the following.
  - (1) When SAR test exclusion provisions of KDB Publication 447498 D01 are applicable and SAR measurement is not required for the initial test configuration, SAR is also not required for the next highest maximum output power transmission mode subsequent test configuration(s) in that frequency band or aggregated band and exposure configuration.
  - (2) When the highest reported SAR for the initial test configuration (when applicable, include subsequent highest output channels), according to the initial test position or fixed exposure position requirements, is adjusted by the ratio of the subsequent test configuration to initial test configuration specified maximum output power and the adjusted SAR is  $\leq 1.2$  W/kg, SAR is not required for that subsequent test configuration.

Any report having not been signed by authorized approver, or having been altered without authorization, or having not been stamped by the "Dedicated Testing/Inspection Stamp" is deemed to be invalid. Copying or excerpting portion of, or altering the content of the report is not permitted without the written authorization of AGC. The test results presented in the report apply only to the tested sample. Any objections to report issued by AGC should be submitted to AGC within 15days after the issuance of the test report. Further enquiry of validity or verification of the test report should be addressed to AGC by [agc01@agccert.com](mailto:agc01@agccert.com).

Attestation of Global Compliance(Shenzhen)Co., Ltd

Attestation of Global Compliance(Shenzhen)Std & Tech Co., Ltd

Tel: +86-755 2523 4088 E-mail: [agc@agccert.com](mailto:agc@agccert.com) Web: <http://www.agccert.com/>

7. Per KDB 941225 D06 V02r01, When the same wireless mode transmission configurations for voice and data are required for SAR measurements, the more conservative configuration with a smaller separation distance should be tested for the overlapping SAR configurations.
8. Maximum Scaling SAR in order to calculate the Maximum SAR values to test under the standard Peak Power, Calculation method is as follows:  
Maximum Scaling SAR = tested SAR (Max.) × [maximum turn-up power (mw)/ maximum measurement output power(mw) ]
9. Proximity sensor, just for avoiding the wrong operation in the phone screen when call, and has no influence on output power or SAR result
10. Per KDB 941225 D05v02r05, start with the largest channel bandwidth and measure SAR for QPSK with 1RB allocation using the RB offset and required test channel combination with highest maximum output power for RB offsets at the upper edge, middle and lower edge of each required test channel.
11. Per KDB 941125 D05v02r05, 50% RB allocation for QPSK SAR testing follows 1RB QPSK allocation procedure.
12. Per KDB 941125 D05v02r05. For QPSK with 100% RB allocation. SAR is not required when the highest maximum output power for 100% RB allocation is less than the highest maximum output power in 50% and 1RB allocation and the highest reported SAR is >1.45 W/kg, the remaining required test channels must also be tested.
13. Per KDB 941125 D05v02r05. 16QAM output power for each RB allocation configuration is not 1/2 dB higher than the same configuration in QPSK and the reported SAR for the QPSK configuration is ≤1.45W/kg, Per KDB 941225 D05v02r05, 16QAM SAR testing is not required.
14. Per KDB 941125 D05v02r05. Smaller bandwidth output power for each RB allocation configuration is >not 1/2 dB higher than the same configuration in the largest supported bandwidth, and the reported SAR for the largest supported bandwidth is ≤1.45W/kg. Per KDB 941125 D05v02r05, smaller bandwidth SAR testing is not required.

Any report having not been signed by authorized approver, or having been altered without authorization, or having not been stamped by the "Dedicated Testing/Inspection Stamp" is deemed to be invalid. Copying or excerpting portion of, or altering the content of the report is not permitted without the written authorization of AGC. The test results presented in the report apply only to the tested sample. Any objections to report issued by AGC should be submitted to AGC within 15days after the issuance of the test report. Further enquiry of validity or verification of the test report should be addressed to AGC by [agc01@agccert.com](mailto:agc01@agccert.com).

### 13.1.3. Test Result

SAR MEASUREMENT									
Depth of Liquid (cm):>15					Relative Humidity (%): 58.3				
Product: Body Worn Camera									
Test Mode: WCDMA Band V with QPSK modulation									
Position	Mode	Ch.	Fr. (MHz)	Power Drift (<math>\pm 5\%</math>)	SAR (1g) (W/kg)	Max. Tune-up Power (dBm)	Meas. output Power (dBm)	Scaled SAR (W/kg)	Limit (W/kg)
Body back	RMC 12.2kbps	4183	836.4	-0.36	<b>0.565</b>	23.50	23.46	<b>0.570</b>	1.6
Body front	RMC 12.2kbps	4183	836.4	0.52	0.485	23.50	23.46	0.489	1.6
Edge 1 (Top)	RMC 12.2kbps	4183	836.4	-0.43	0.046	23.50	23.46	0.046	1.6
Edge 2(Right)	RMC 12.2kbps	4183	836.4	0.21	0.047	23.50	23.46	0.047	1.6
Edge 3(Bottom)	RMC 12.2kbps	4183	836.4	-0.08	0.398	23.50	23.46	0.402	1.6
Edge 4(Left)	RMC 12.2kbps	4183	836.4	-0.30	0.270	23.50	23.46	0.272	1.6

Note:

- When the 1-g Reported SAR is  $\leq 0.8$  W/kg, testing for low and high channel is optional. Refer to KDB 447498.
- The test separation for body back, body front and 4 Edges is 0mm of all above table.

Any report having not been signed by authorized approver, or having been altered without authorization, or having not been stamped by the "Dedicated Testing/Inspection Stamp" is deemed to be invalid. Copying or excerpting portion of, or altering the content of the report is not permitted without the written authorization of AGC. The test results presented in the report apply only to the tested sample. Any objections to report issued by AGC should be submitted to AGC within 15days after the issuance of the test report. Further enquiry of validity or verification of the test report should be addressed to AGC by [agc01@agccert.com](mailto:agc01@agccert.com).



SAR MEASUREMENT												
Depth of Liquid (cm):>15						Relative Humidity (%): 58.3						
Product: Body Worn Camera												
Test Mode: LTE Band 5												
BM MHz	MOD	Position	Test Mode		Ch.	Freq. (MHz)	Power Drift (<±5%)	SAR (1g) (W/kg)	Max. Tuneup Power (dBm)	Meas. output Power (dBm)	Scaled SAR (W/kg)	Limit (W/kg)
			UL RB Allocation	UL RB START								
10	QPSK	Body back	1	0	20525	836.5	-0.35	0.626	22.50	22.05	0.694	1.6
		Body front	1	0	20525	836.5	-0.31	0.474	22.50	22.05	0.526	1.6
		Edge 1 (Top)	1	0	20525	836.5	0.27	0.144	22.50	22.05	0.160	1.6
		Edge 2(Right)	1	0	20525	836.5	-0.33	0.404	22.50	22.05	0.448	1.6
		Edge 3(Bottom)	1	0	20525	836.5	-0.17	0.564	22.50	22.05	0.626	1.6
		Edge 4(Left)	1	0	20525	836.5	-0.04	<b>0.718</b>	22.50	22.05	<b>0.796</b>	1.6

Note:

- When the 1-g Reported SAR is ≤ 0.8 W/kg, testing for low and high channel is optional. Refer to KDB 447498.
- The test separation for body back, body front and 4 Edges is 0mm of all above table.

Any report having not been signed by authorized approver, or having been altered without authorization, or having not been stamped by the “Dedicated Testing/Inspection Stamp” is deemed to be invalid. Copying or excerpting portion of, or altering the content of the report is not permitted without the written authorization of AGC. The test results presented in the report apply only to the tested sample. Any objections to report issued by AGC should be submitted to AGC within 15days after the issuance of the test report. Further enquiry of validity or verification of the test report should be addressed to AGC by agc01@agccert.com.

SAR MEASUREMENT												
Depth of Liquid (cm):>15						Relative Humidity (%): 51.8						
Product: Body Worn Camera												
Test Mode: LTE Band 41												
BW MHz	MOD	Position	Test Mode		Ch.	Freq. (MHz)	Power Drift (<math>\pm 5\%</math>)	SAR (1g) (W/kg)	Max. Tuneup Power (dBm)	Meas. output Power (dBm)	Scaled SAR (W/kg)	Limit (W/kg)
			UL RB Allocation	UL RB START								
20	QPSK	Body back	1	0	40620	2593	-0.12	0.708	20.50	20.36	0.731	1.6
		Body front	1	0	40620	2593	-0.18	0.626	20.50	20.36	0.647	1.6
		Edge 1 (Top)	1	0	40620	2593	-0.35	0.075	20.50	20.36	0.077	1.6
		Edge 2(Right)	1	0	40620	2593	0.79	0.063	20.50	20.36	0.065	1.6
		Edge 3(Bottom)	1	0	40620	2593	-0.93	0.611	20.50	20.36	0.631	1.6
		Edge 4(Left)	1	0	40620	2593	0.19	<b>0.720</b>	20.50	20.36	<b>0.744</b>	1.6

- When the 1-g Reported SAR is  $\leq 0.8$  W/kg, testing for low and high channel is optional. Refer to KDB 447498.
- The test separation for body back, body front and 4 Edges is 0mm of all above table

Any report having not been signed by authorized approver, or having been altered without authorization, or having not been stamped by the "Dedicated Testing/Inspection Stamp" is deemed to be invalid. Copying or excerpting portion of, or altering the content of the report is not permitted without the written authorization of AGC. The test results presented in the report apply only to the tested sample. Any objections to report issued by AGC should be submitted to AGC within 15days after the issuance of the test report. Further enquiry of validity or verification of the test report should be addressed to AGC by agc01@agccert.com.

SAR MEASUREMENT									
Depth of Liquid (cm):>15					Relative Humidity (%): 54.7				
Product: Body Worn Camera									
Test Mode:802.11b									
Position	Mode	Ch.	Fr. (MHz)	Power Drift (<±5%)	SAR (1g) (W/kg)	Max. Tune-up Power (dBm)	Meas. output Power (dBm)	Scaled SAR (W/kg)	Limit (W/kg)
Body back	DTS	6	2437	-0.36	<b>0.633</b>	17.50	17.47	<b>0.637</b>	1.6
Body front	DTS	6	2437	0.05	0.564	17.50	17.47	0.568	1.6
Edge 1 (Top)	DTS	6	2437	0.32	0.194	17.50	17.47	0.195	1.6
Edge 2(Right)	DTS	6	2437	-0.28	0.029	17.50	17.47	0.029	1.6
Edge 3(Bottom)	DTS	6	2437	0.47	0.044	17.50	17.47	0.044	1.6
Edge 4(Left)	DTS	6	2437	-0.55	0.475	17.50	17.47	0.478	1.6

Note:

- According to KDB248227, SAR is not required for 802.11n HT20/HT40 channels when the maximum average output power is less than 1/4 dB higher than that measured on the corresponding 802.11a/b channels.
- All of above “DTS” means data transmitters.
- The test separation for body back, body front and 4 Edges is 0mm of all above table.

Any report having not been signed by authorized approver, or having been altered without authorization, or having not been stamped by the “Dedicated Testing/Inspection Stamp” is deemed to be invalid. Copying or excerpting portion of, or altering the content of the report is not permitted without the written authorization of AGC. The test results presented in the report apply only to the tested sample. Any objections to report issued by AGC should be submitted to AGC within 15days after the issuance of the test report. Further enquiry of validity or verification of the test report should be addressed to AGC by agc01@agccert.com.

SAR MEASUREMENT								
Depth of Liquid (cm):>15				Relative Humidity (%): 60.1				
Product: Body Worn Camera								
Test Mode: 5.2GHz WIFI-802.11n(20)								
Position	Ch.	Fr. (MHz)	Power Drift (<±5%)	SAR (1g) (W/kg)	Max. Tune-up Power (dBm)	Meas. output Power (dBm)	Scaled SAR (W/kg)	Limit (W/kg)
Body back	40	5200	-0.26	0.323	16.00	15.91	0.330	1.6
Body front	40	5200	-0.58	0.405	16.00	15.91	0.413	1.6
Edge 1 (Top)	40	5200	0.41	0.140	16.00	15.91	0.143	1.6
Edge 2(Right)	36	5180	-0.58	0.789	15.50	15.35	0.817	1.6
Edge 2(Right)	40	5200	-0.36	0.786	16.00	15.91	0.802	1.6
Edge 2(Right)	48	5240	-0.03	<b>0.796</b>	14.00	13.69	<b>0.855</b>	1.6
Edge 3(Bottom)	40	5200	0.09	0.230	16.00	15.91	0.235	1.6
Edge 4(Left)	40	5200	0.55	0.157	16.00	15.91	0.160	1.6

Note:

1. When the 1-g Reported SAR is  $\leq 0.8$  W/kg, testing for low and high channel is optional. Refer to KDB447498.
2. The test separation of all above table is 5mm .

Any report having not been signed by authorized approver, or having been altered without authorization, or having not been stamped by the "Dedicated Testing/Inspection Stamp" is deemed to be invalid. Copying or excerpting portion of, or altering the content of the report is not permitted without the written authorization of AGC. The test results presented in the report apply only to the tested sample. Any objections to report issued by AGC should be submitted to AGC within 15days after the issuance of the test report. Further enquiry of validity or verification of the test report should be addressed to AGC by agc01@agccert.com.

According to KDB 248227 D01 802 11 Wi-Fi SAR v02r02 Section 5.3.1

b) When different maximum output power is specified for the bands, begin SAR measurement in the band with higher specified maximum output power. The highest reported SAR for the tested configuration is adjusted by the ratio of lower to higher specified maximum output power for the two bands. When the adjusted SAR is  $\leq 1.2$  W/kg, SAR is not required for the band with lower maximum output power in that test configuration; otherwise, each band is tested independently for SAR.

U-NII-1 Band(dBm)	U-NII-1 Band(mW)	NII-2A Band(dBm)	NII-2A Band( mW )	The highest reported SAR for U-NII-1 Band (W/kg)	The adjusted SAR(W/kg)	Limit(W/kg)
15.91	38.99	15.77	37.76	0.855	0.828	1.2

**Conclusion:** SAR is not required for U-NII-2A Band.

SAR MEASUREMENT								
Depth of Liquid (cm):>15					Relative Humidity (%): 48.1			
Product: Body Worn Camera								
Test Mode: 5.6GHz WIFI -802.11a								
Position	Ch.	Fr. (MHz)	Power Drift (<math>\pm 5\%</math>)	SAR (1g) (W/kg)	Max. Tune-up Power (dBm)	Meas. output Power (dBm)	Scaled SAR (W/kg)	Limit (W/kg)
Body back	120	5600	0.72	0.407	12.50	12.42	0.415	1.6
Body front	120	5600	0.40	0.493	12.50	12.42	0.502	1.6
Edge 1 (Top)	120	5600	-0.29	0.160	12.50	12.42	0.163	1.6
Edge 2 (Right)	100	5500	-0.85	0.757	15.00	14.82	0.789	1.6
Edge 2 (Right)	120	5600	0.66	0.759	12.50	12.42	0.773	1.6
Edge 2 (Right)	140	5700	-0.53	<b>0.768</b>	13.50	13.20	<b>0.823</b>	1.6
Edge 3 (Bottom)	120	5600	0.98	0.453	12.50	12.42	0.461	1.6
Edge 4 (Left)	120	5600	0.50	0.340	12.50	12.42	0.346	1.6

Note:

- When the 1-g SAR is  $\leq 0.8W/kg$ , testing for low and high channel is optional.
- The test separation of all above table(body part) is 0mm.
- Plots are only shown for the bold marked worst case SAR results

Any report having not been signed by authorized approver, or having been altered without authorization, or having not been stamped by the "Dedicated Testing/Inspection Stamp" is deemed to be invalid. Copying or excerpting portion of, or altering the content of the report is not permitted without the written authorization of AGC. The test results presented in the report apply only to the tested sample. Any objections to report issued by AGC should be submitted to AGC within 15days after the issuance of the test report. Further enquiry of validity or verification of the test report should be addressed to AGC by agc01@agccert.com.

SAR MEASUREMENT								
Depth of Liquid (cm):>15					Relative Humidity (%): 54.6			
Product: Body Worn Camera								
Test Mode: 5.8GHz WIFI-802.11a								
Position	Ch.	Fr. (MHz)	Power Drift (<±5%)	SAR (1g) (W/kg)	Max. Tune-up Power (dBm)	Meas. output Power (dBm)	Scaled SAR (W/kg)	Limit (W/kg)
Body back	157	5785	0.30	0.500	11.00	10.73	0.532	1.6
Body front	157	5785	-0.02	0.353	11.00	10.73	0.376	1.6
Edge 1 (Top)	157	5785	-0.06	0.074	11.00	10.73	0.079	1.6
Edge 2 (Right)	157	5785	-0.26	<b>0.675</b>	11.00	10.73	<b>0.718</b>	1.6
Edge 3 (Bottom)	157	5785	-0.20	0.464	11.00	10.73	0.494	1.6
Edge 4 (Left)	157	5785	0.38	0.254	11.00	10.73	0.270	1.6

1. When the 1-g Reported SAR is  $\leq 0.8$  W/kg, testing for low and high channel is optional. Refer to KDB447498.
2. The test separation of all above table is 5mm .

Any report having not been signed by authorized approver, or having been altered without authorization, or having not been stamped by the “Dedicated Testing/Inspection Stamp” is deemed to be invalid. Copying or excerpting portion of, or altering the content of the report is not permitted without the written authorization of AGC. The test results presented in the report apply only to the tested sample. Any objections to report issued by AGC should be submitted to AGC within 15days after the issuance of the test report. Further enquiry of validity or verification of the test report should be addressed to AGC by agc01@agccert.com.

Repeated SAR									
Product: Body Worn Camera									
Test Mode: 5.2GHz WIFI-802.11n(20)& 5.6GHz WIFI -802.11a									
Position	Ch.	Fr. (MHz)	Power Drift (<±5%)	Once SAR (1g) (W/kg)	Power Drift (<±5%)	Twice SAR (1g) (W/kg)	Power Drift (<±5%)	Third SAR (1g) (W/kg)	Limit W/kg
Edge 2(Right)	48	5240	-0.26	0.783	--	--	--	--	1.6
Edge 2 (Right)	140	5700	-0.41	0.752	--	--	--	--	1.6

The second repeated SAR judge reference							
Product: Body Worn Camera							
Band	Position	Ch.	Fr. (MHz)	Original SAR (1g) (W/kg)	First SAR (1g) (W/kg)	Ratio	Limit
5.2GHz WIFI-802.11n(20)	Edge 2 (Right)	140	5700	0.796	0.783	1.017	<1.2
5.6GHz WIFI -802.11a	Edge 2 (Right)	140	5700	0.768	0.752	1.021	<1.2

Any report having not been signed by authorized approver, or having been altered without authorization, or having not been stamped by the "Dedicated Testing/Inspection Stamp" is deemed to be invalid. Copying or excerpting portion of, or altering the content of the report is not permitted without the written authorization of AGC. The test results presented in the report apply only to the tested sample. Any objections to report issued by AGC should be submitted to AGC within 15days after the issuance of the test report. Further enquiry of validity or verification of the test report should be addressed to AGC by agc01@agccert.com.



**Simultaneous Multi-band Transmission Evaluation:**  
**Application Simultaneous Transmission information:**

NO	Simultaneous state	Portable Handset	
		Body-worn	Hotspot
1	WCDMA+Bluetooth(data) +WLAN 2.4GHz/5GHz (data)	Yes	Yes
2	LTE+Bluetooth(data) +WLAN 2.4GHz/5GHz (data)	Yes	Yes

**NOTE:**

- WLAN and BT with different antenna.
- For simultaneous transmission at head and body exposure position, 3 transmitters simultaneous transmission was the worst state.
- Based upon KDB 447498 D01, BT SAR is excluded as below table.
- Based upon KDB 447498 D01, for handsets the test separation distance is determined by the smallest distance between the outer surface of the device and the user; which is 0mm for body-worn SAR.
- According to KDB 447498 D01 4.3.1, Standalone SAR test exclusion is as follow:  
For 100 MHz to 6 GHz and test separation distances  $\leq 50$  mm, the 1-g and 10-g SAR test exclusion thresholds are determined by the following:  

$$[(\text{max. power of channel, including tune-up tolerance, mW}) / (\text{min. test separation distance, mm})] \cdot [\sqrt{f(\text{GHz})}] \leq 3.0$$
 for 1-g SAR, and  $\leq 7.5$  for 10-g extremity SAR<sup>30</sup>, where
  - f(GHz) is the RF channel transmit frequency in GHz
  - Power and distance are rounded to the nearest mW and mm before calculation<sup>31</sup>
  - The result is rounded to one decimal place for comparison
  - The values 3.0 and 7.5 are referred to as numeric thresholds in step b) below
 The test exclusions are applicable only when the minimum test separation distance is  $\leq 50$  mm, and for transmission frequencies between 100 MHz and 6 GHz. When the minimum test separation distance is  $< 5$  mm, a distance of 5 mm according to 4.1 f) is applied to determine SAR test exclusion.
- If the test separation distance is  $< 5$ mm, 5mm is used for excluded SAR calculation.
- According to KDB 447498 D01 4.3.2, simultaneous transmission SAR test exclusion is as follow:
  - Simultaneous transmission SAR test exclusion is determined for each operating configuration and exposure condition according to the reported standalone SAR of each applicable simultaneous transmitting antenna.
  - Any transmitters and antennas should be considered when calculating simultaneous mode.
  - For mobile phone and PC, it's the sum of all transmitters and antennas at the same mode with same position in each applicable exposure condition
  - When the standalone SAR test exclusion of section 4.3.2 is applied to an antenna that transmits simultaneously with other antennas, the standalone SAR must be estimated according to the following to det  

$$(\text{max. power of channel, including tune-up tolerance, mW}) / (\text{min. test separation distance, mm}) \cdot [\sqrt{f(\text{GHz})} / x] \text{ W/kg}$$
 for test separation distances  $\leq 50$  mm;  
 where  $x = 7.5$  for 1-g SAR, and  $x = 18.75$  for 10-g SAR.
- When the sum of SAR is larger than the limit, SAR test exclusion is determined by the SAR to peak location separation ratio. The simultaneous transmitting antennas in each operating mode and exposure condition combination must be considered one pair at a time to determine the SAR to peak location separation ratio to qualify for test exclusion. The ratio is determined by  $(\text{SAR}_1 + \text{SAR}_2) \cdot 1.5 / R_i$ , rounded to two decimal digits, and must be  $\leq 0.04$  for all antenna pairs in the configuration to qualify for 1-g SAR test exclusion.

Estimated SAR		Max Power including Tune-up Tolerance		Separation Distance (mm)	Estimated SAR (W/kg)
		dBm	mW		
BT	Body	1	1.259	0	0.052

Any report having not been signed by authorized approver, or having been altered without authorization, or having not been stamped by the "Dedicated Testing/Inspection Stamp" is deemed to be invalid. Copying or excerpting portion of, or altering the content of the report is not permitted without the written authorization of AGC. The test results presented in the report apply only to the tested sample. Any objections to report issued by AGC should be submitted to AGC within 15 days after the issuance of the test report. Further enquiry of validity or verification of the test report should be addressed to AGC by [agc01@agccert.com](mailto:agc01@agccert.com).

**Sum of the SAR for WCDMA Band V, Wi-Fi and BT:**

RF Exposure Conditions	Test Position	Simultaneous Transmission Scenario			Σ1-g SAR (W/kg)	SPLSR (Yes/No)
		WCDMA Band V	2.4GHz Wi-Fi DTS Band	Bluetooth		
Body-worn	Rear	0.570	0.637	0.052	1.259	No
	Front	0.489	0.568	0.052	1.109	No
	Edge 1	0.046	0.195	0.052	0.293	No
	Edge 2	0.047	0.029	0.052	0.128	No
	Edge 3	0.402	0.044	0.052	0.498	No
	Edge 4	0.272	0.478	0.052	0.802	No
RF Exposure Conditions	Test Position	Simultaneous Transmission Scenario			Σ1-g SAR (W/kg)	SPLSR (Yes/No)
		WCDMA Band V	5.2GHz Wi-Fi DTS Band	Bluetooth		
Body-worn	Rear	0.570	0.330	0.052	0.952	No
	Front	0.489	0.413	0.052	0.954	No
	Edge 1	0.046	0.143	0.052	0.241	No
	Edge 2	0.047	0.855	0.052	0.954	No
	Edge 3	0.402	0.235	0.052	0.689	No
	Edge 4	0.272	0.160	0.052	0.484	No
RF Exposure Conditions	Test Position	Simultaneous Transmission Scenario			Σ1-g SAR (W/kg)	SPLSR (Yes/No)
		WCDMA Band V	5.6GHz Wi-Fi DTS Band	Bluetooth		
Body-worn	Rear	0.570	0.415	0.052	1.037	No
	Front	0.489	0.502	0.052	1.043	No
	Edge 1	0.046	0.163	0.052	0.261	No
	Edge 2	0.047	0.823	0.052	0.922	No
	Edge 3	0.402	0.461	0.052	0.915	No
	Edge 4	0.272	0.346	0.052	0.670	No
RF Exposure Conditions	Test Position	Simultaneous Transmission Scenario			Σ1-g SAR (W/kg)	SPLSR (Yes/No)
		WCDMA Band V	5.8GHz Wi-Fi DTS Band	Bluetooth		
Body-worn	Rear	0.570	0.532	0.052	1.154	No
	Front	0.489	0.376	0.052	0.917	No
	Edge 1	0.046	0.079	0.052	0.177	No
	Edge 2	0.047	0.718	0.052	0.817	No
	Edge 3	0.402	0.494	0.052	0.948	No
	Edge 4	0.272	0.270	0.052	0.594	No

**Note:**

- According to KDB 447498 D01 General RF Exposure Guidance, when the simultaneous transmission SAR is less than 1.6 W/kg, SPLSR assessment is not required.
- SPLSR mean is “The SAR to Peak Location Separation Ratio “

**Sum of the SAR for LTE Band 5 , Wi-Fi and BT :**

Any report having not been signed by authorized approver, or having been altered without authorization, or having not been stamped by the “Dedicated Testing/Inspection Stamp” is deemed to be invalid. Copying or excerpting portion of, or altering the content of the report is not permitted without the written authorization of AGC. The test results presented in the report apply only to the tested sample. Any objections to report issued by AGC should be submitted to AGC within 15days after the issuance of the test report. Further enquiry of validity or verification of the test report should be addressed to AGC by agc01@agccert.com.

RF Exposure Conditions	Test Position	Simultaneous Transmission Scenario			Σ1-g SAR (W/kg)	SPLSR (Yes/No)
		LTE Band 5	2.4GHz Wi-Fi DTS Band	Bluetooth		
Body-worn	Rear	0.694	0.637	0.052	1.383	No
	Front	0.526	0.568	0.052	1.146	No
	Edge 1	0.160	0.195	0.052	0.407	No
	Edge 2	0.448	0.029	0.052	0.529	No
	Edge 3	0.626	0.044	0.052	0.722	No
	Edge 4	0.796	0.478	0.052	1.326	No
RF Exposure Conditions	Test Position	Simultaneous Transmission Scenario			Σ1-g SAR (W/kg)	SPLSR (Yes/No)
		LTE Band 5	5.2GHz Wi-Fi DTS Band	Bluetooth		
Body-worn	Rear	0.694	0.330	0.052	1.076	No
	Front	0.526	0.413	0.052	0.991	No
	Edge 1	0.160	0.143	0.052	0.355	No
	Edge 2	0.448	0.855	0.052	1.355	No
	Edge 3	0.626	0.235	0.052	0.913	No
	Edge 4	0.796	0.160	0.052	1.008	No
RF Exposure Conditions	Test Position	Simultaneous Transmission Scenario			Σ1-g SAR (W/kg)	SPLSR (Yes/No)
		LTE Band 5	5.6GHz Wi-Fi DTS Band	Bluetooth		
Body-worn	Rear	0.694	0.415	0.052	1.161	No
	Front	0.526	0.502	0.052	1.080	No
	Edge 1	0.160	0.163	0.052	0.375	No
	Edge 2	0.448	0.823	0.052	1.323	No
	Edge 3	0.626	0.461	0.052	1.139	No
	Edge 4	0.796	0.346	0.052	1.194	No
RF Exposure Conditions	Test Position	Simultaneous Transmission Scenario			Σ1-g SAR (W/kg)	SPLSR (Yes/No)
		LTE Band 5	5.8GHz Wi-Fi DTS Band	Bluetooth		
Body-worn	Rear	0.694	0.532	0.052	1.278	No
	Front	0.526	0.376	0.052	0.954	No
	Edge 1	0.160	0.079	0.052	0.291	No
	Edge 2	0.448	0.718	0.052	1.218	No
	Edge 3	0.626	0.494	0.052	1.172	No
	Edge 4	0.796	0.270	0.052	1.118	No

**Note:**

- According to KDB 447498 D01 General RF Exposure Guidance, when the simultaneous transmission SAR is less than 1.6 W/kg, SPLSR assessment is not required.
- SPLSR mean is “The SAR to Peak Location Separation Ratio “

Any report having not been signed by authorized approver, or having been altered without authorization, or having not been stamped by the “Dedicated Testing/Inspection Stamp” is deemed to be invalid. Copying or excerpting portion of, or altering the content of the report is not permitted without the written authorization of AGC. The test results presented in the report apply only to the tested sample. Any objections to report issued by AGC should be submitted to AGC within 15days after the issuance of the test report. Further enquiry of validity or verification of the test report should be addressed to AGC by agc01@agccert.com.

**Sum of the SAR for LTE Band 41, Wi-Fi and BT:**

RF Exposure Conditions	Test Position	Simultaneous Transmission Scenario			Σ1-g SAR (W/kg)	SPLSR (Yes/No)
		LTE Band 41	2.4GHz Wi-Fi DTS Band	Bluetooth		
Body-worn	Rear	0.731	0.637	0.052	1.420	No
	Front	0.647	0.568	0.052	1.267	No
	Edge 1	0.077	0.195	0.052	0.324	No
	Edge 2	0.065	0.029	0.052	0.146	No
	Edge 3	0.631	0.044	0.052	0.727	No
	Edge 4	0.744	0.478	0.052	1.274	No
RF Exposure Conditions	Test Position	Simultaneous Transmission Scenario			Σ1-g SAR (W/kg)	SPLSR (Yes/No)
		LTE Band 41	5.2GHz Wi-Fi DTS Band	Bluetooth		
Body-worn	Rear	0.731	0.330	0.052	1.113	No
	Front	0.647	0.413	0.052	1.112	No
	Edge 1	0.077	0.143	0.052	0.272	No
	Edge 2	0.065	0.855	0.052	0.972	No
	Edge 3	0.631	0.235	0.052	0.918	No
	Edge 4	0.744	0.160	0.052	0.956	No
RF Exposure Conditions	Test Position	Simultaneous Transmission Scenario			Σ1-g SAR (W/kg)	SPLSR (Yes/No)
		LTE Band 41	5.6GHz Wi-Fi DTS Band	Bluetooth		
Body-worn	Rear	0.731	0.415	0.052	1.198	No
	Front	0.647	0.502	0.052	1.201	No
	Edge 1	0.077	0.163	0.052	0.292	No
	Edge 2	0.065	0.823	0.052	0.940	No
	Edge 3	0.631	0.461	0.052	1.144	No
	Edge 4	0.744	0.346	0.052	1.142	No
RF Exposure Conditions	Test Position	Simultaneous Transmission Scenario			Σ1-g SAR (W/kg)	SPLSR (Yes/No)
		LTE Band 41	5.8GHz Wi-Fi DTS Band	Bluetooth		
Body-worn	Rear	0.731	0.532	0.052	1.315	No
	Front	0.647	0.376	0.052	1.075	No
	Edge 1	0.077	0.079	0.052	0.208	No
	Edge 2	0.065	0.718	0.052	0.835	No
	Edge 3	0.631	0.494	0.052	1.177	No
	Edge 4	0.744	0.270	0.052	1.066	No

**Note:**

- According to KDB 447498 D01 General RF Exposure Guidance, when the simultaneous transmission SAR is less than 1.6 W/kg, SPLSR assessment is not required.
- SPLSR mean is “The SAR to Peak Location Separation Ratio “

Any report having not been signed by authorized approver, or having been altered without authorization, or having not been stamped by the “Dedicated Testing/Inspection Stamp” is deemed to be invalid. Copying or excerpting portion of, or altering the content of the report is not permitted without the written authorization of AGC. The test results presented in the report apply only to the tested sample. Any objections to report issued by AGC should be submitted to AGC within 15days after the issuance of the test report. Further enquiry of validity or verification of the test report should be addressed to AGC by agc01@agccert.com.

## APPENDIX A. SAR SYSTEM CHECK DATA

Test Laboratory: AGC Lab

Date: Oct. 20,2022

System Check Head 835 MHz

DUT: Dipole 835 MHz Type: SID 835

Communication System CW; Communication System Band: D835 (835.0 MHz); Duty Cycle: 1:1; Conv.F=1.42

Frequency: 835 MHz; Medium parameters used:  $f = 835$  MHz;  $\sigma=0.93$  mho/m;  $\epsilon_r = 41.28$ ;  $\rho = 1000$  kg/m<sup>3</sup> ;

Phantom section: Flat Section; Input Power=18dBm

Ambient temperature (°C):21.9, Liquid temperature (°C): 21.6

SATIMO Configuration:

- Probe: SSE2; Calibrated: Apr. 13, 2022; Serial No.: SN 13/22 EPGO368
- Sensor-Surface: 4mm (Mechanical Surface Detection)
- Phantom: SAM twin phantom
- Measurement SW: OpenSAR V4\_02\_32

Configuration/System Check 835MHz Head/Area Scan: Measurement grid: dx=8mm, dy=8mm

Configuration/System Check 835MHz Head/Zoom Scan: Measurement grid: dx=8mm,dy=8mm, dz=5mm

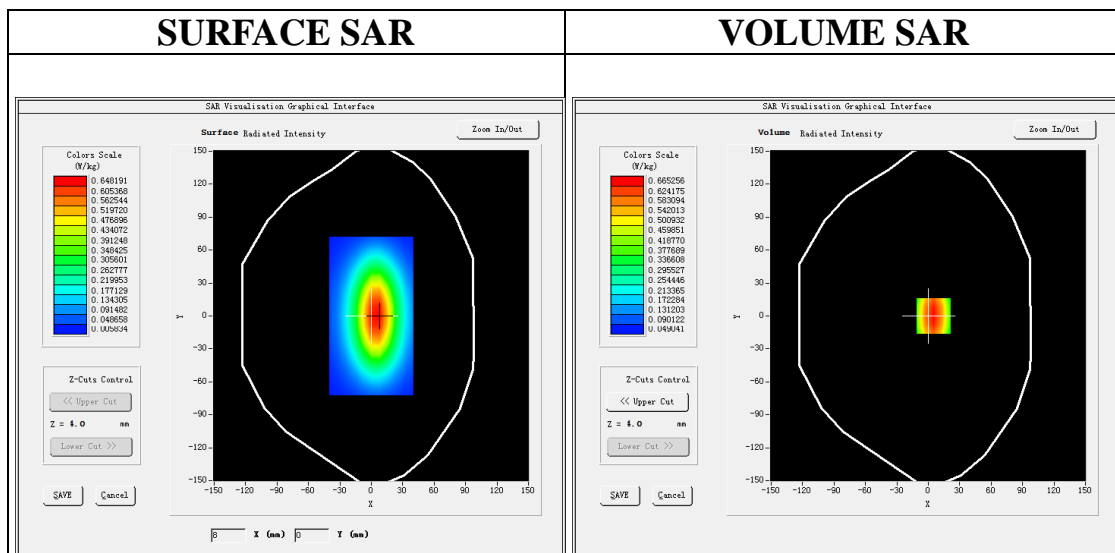

**Maximum location: X=5.00, Y=0.00**

**SAR Peak: 0.93 W/kg**

<b>SAR 10g (W/Kg)</b>	0.404315
<b>SAR 1g (W/Kg)</b>	0.633972

Any report having not been signed by authorized approver, or having been altered without authorization, or having not been stamped by the "Dedicated Testing/Inspection Stamp" is deemed to be invalid. Copying or excerpting portion of, or altering the content of the report is not permitted without the written authorization of AGC. The test results presented in the report apply only to the tested sample. Any objections to report issued by AGC should be submitted to AGC within 15days after the issuance of the test report. Further enquiry of validity or verification of the test report should be addressed to AGC by agc01@agccert.com.

Attestation of Global Compliance(Shenzhen)Co., Ltd

Attestation of Global Compliance(Shenzhen)Std & Tech Co., Ltd

Tel: +86-755 2523 4088 E-mail: agc@agccert.com Web: http://www.agccert.com/

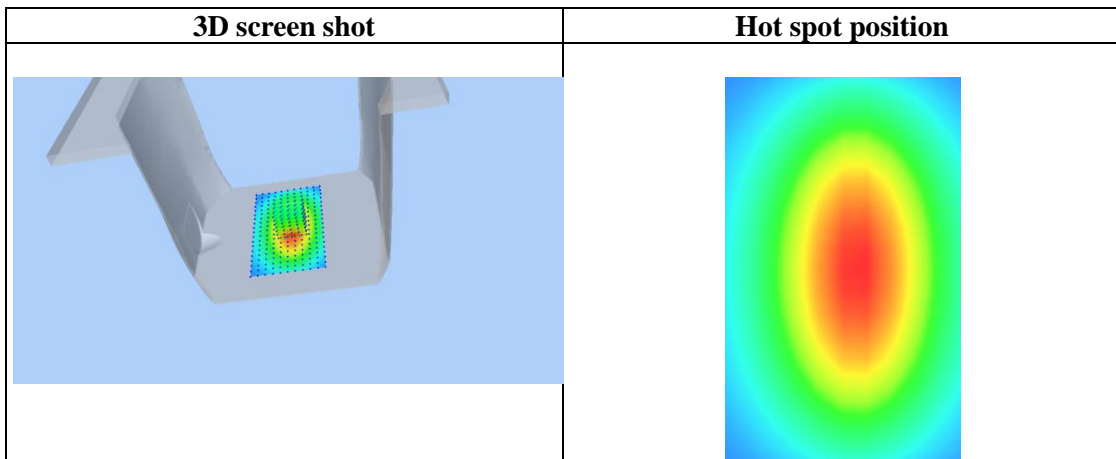
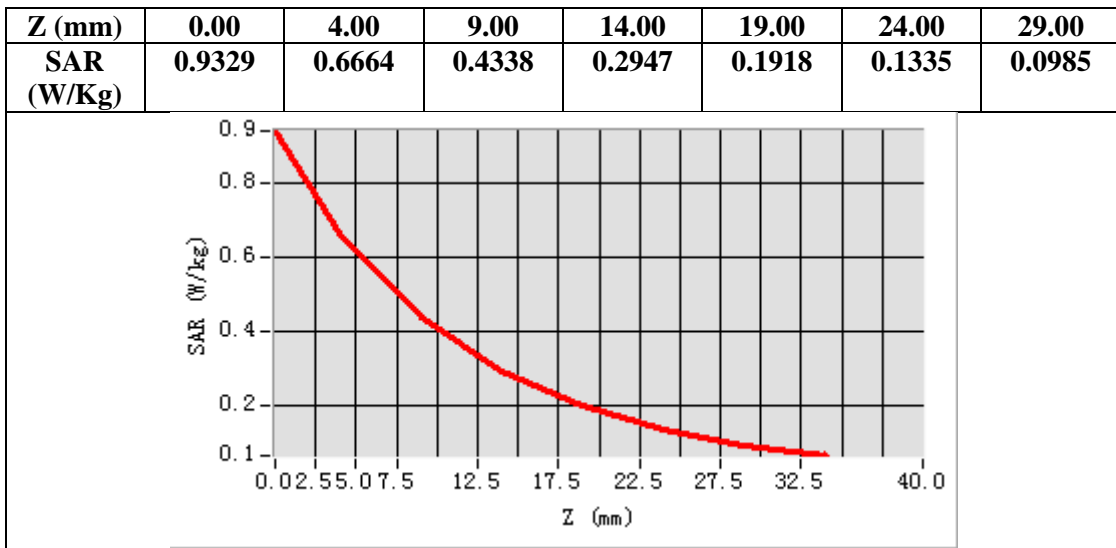

Any report having not been signed by authorized approver, or having been altered without authorization, or having not been stamped by the "Dedicated Testing/Inspection Stamp" is deemed to be invalid. Copying or excerpting portion of, or altering the content of the report is not permitted without the written authorization of AGC. The test results presented in the report apply only to the tested sample. Any objections to report issued by AGC should be submitted to AGC within 15days after the issuance of the test report. Further enquiry of validity or verification of the test report should be addressed to AGC by agc01@agccert.com.

**Test Laboratory: AGC Lab**  
**System Check Head 2450 MHz**

**Date: Oct. 18,2022**

**DUT: Dipole 2450 MHz Type: SID 2450**

Communication System CW; Communication System Band: D2450 (2450.0 MHz); Duty Cycle: 1:1; Conv.F=1.99  
Frequency: 2450 MHz; Medium parameters used:  $f = 2450$  MHz;  $\sigma=1.77$  mho/m;  $\epsilon_r=38.61$ ;  $\rho= 1000$  kg/m<sup>3</sup> ;  
Phantom section: Flat Section; Input Power=18dBm  
Ambient temperature (°C):21.4, Liquid temperature (°C): 21.2

**SATIMO Configuration**

- Probe: SSE2; Calibrated: Apr. 13, 2022; Serial No.: SN 13/22 EPGO368
- Sensor-Surface: 4mm (Mechanical Surface Detection)
- Phantom: SAM twin phantom
- Measurement SW: OpenSAR V4\_02\_32

**Configuration/System Check 2450MHz Head/Area Scan: Measurement grid: dx=8mm, dy=8mm**

**Configuration/System Check 2450MHz Head/Zoom Scan: Measurement grid: dx=5mm,dy=5mm, dz=5mm**

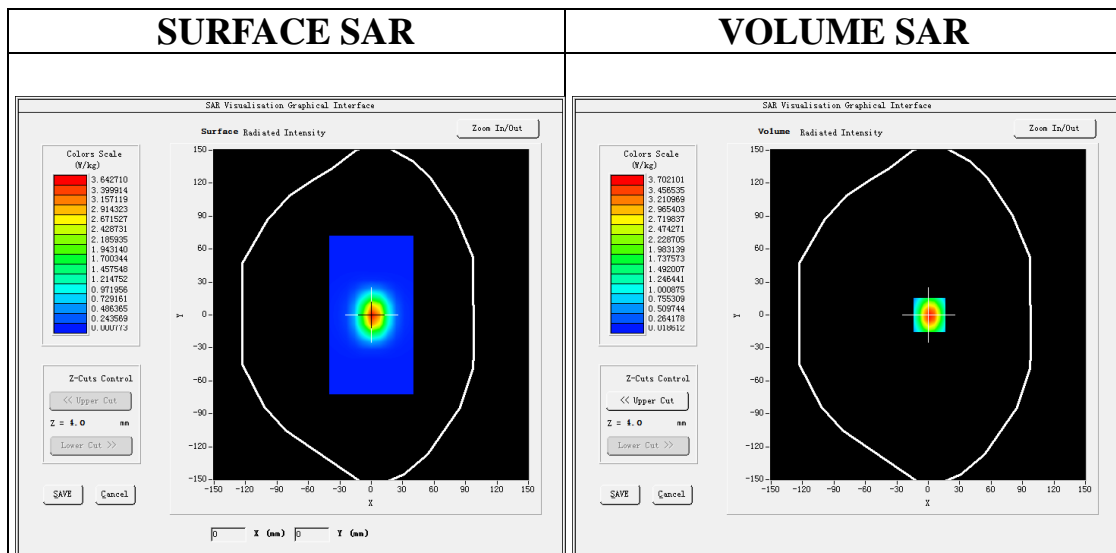

**Maximum location: X=1.00, Y=0.00**

**SAR Peak: 6.40 W/kg**

<b>SAR 10g (W/Kg)</b>	<b>1.537403</b>
<b>SAR 1g (W/Kg)</b>	<b>3.424861</b>

Any report having not been signed by authorized approver, or having been altered without authorization, or having not been stamped by the “Dedicated Testing/Inspection Stamp” is deemed to be invalid. Copying or excerpting portion of, or altering the content of the report is not permitted without the written authorization of AGC. The test results presented in the report apply only to the tested sample. Any objections to report issued by AGC should be submitted to AGC within 15days after the issuance of the test report. Further enquiry of validity or verification of the test report should be addressed to AGC by agc01@agccert.com.

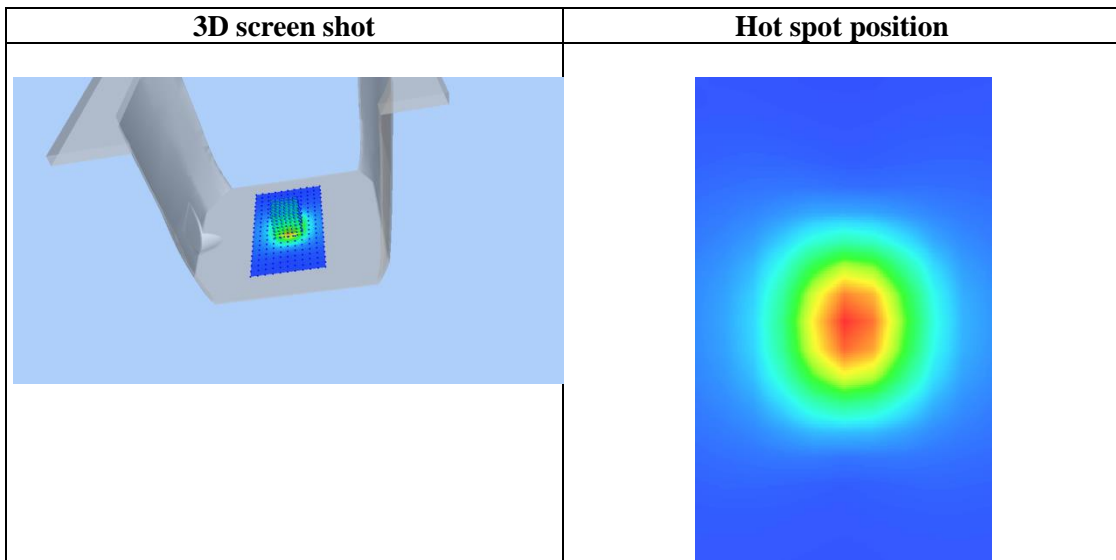
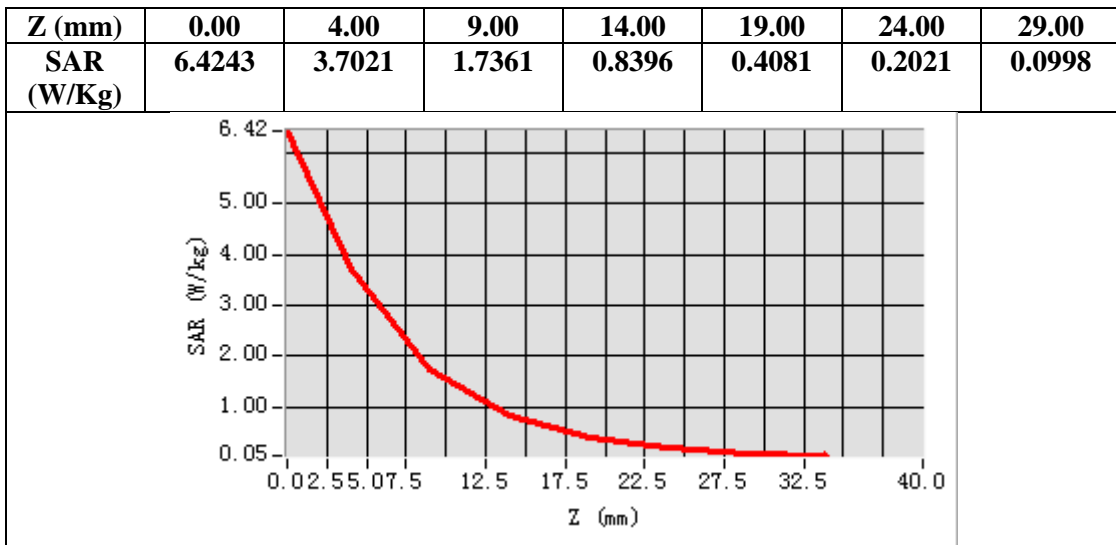

Any report having not been signed by authorized approver, or having been altered without authorization, or having not been stamped by the "Dedicated Testing/Inspection Stamp" is deemed to be invalid. Copying or excerpting portion of, or altering the content of the report is not permitted without the written authorization of AGC. The test results presented in the report apply only to the tested sample. Any objections to report issued by AGC should be submitted to AGC within 15days after the issuance of the test report. Further enquiry of validity or verification of the test report should be addressed to AGC by agc01@agccert.com.



**Test Laboratory: AGC Lab**  
**System Check Head 2600MHz**

**Date: Oct. 19,2022**

**DUT: Dipole 2600 MHz; Type: SID 2600**

Communication System: CW; Communication System Band: D2600 (2600.0 MHz); Duty Cycle: 1:1; Conv.F=1.82  
Frequency:2600 MHz; Medium parameters used:  $f = 2600$  MHz;  $\sigma = 1.91$  mho/m;  $\epsilon_r = 38.98$ ;  $\rho = 1000$  kg/m<sup>3</sup> ;  
Phantom section: Flat Section; Input Power=18dBm  
Ambient temperature (°C): 21.7, Liquid temperature (°C): 21.5

SATIMO Configuration:

- Probe: SSE2; Calibrated: Apr. 13, 2022; Serial No.: SN 13/22 EPGO368
- Sensor-Surface: 4mm (Mechanical Surface Detection)
- Phantom: SAM twin phantom
- Measurement SW: OpenSAR V4\_02\_32

**Configuration/System Check 2600 Head/Area Scan:** Measurement grid: dx=8mm,dy=8mm

**Configuration/System Check 2600 Head/Zoom Scan:** Measurement grid: dx=5mm,dy=5mm, dz=5mm

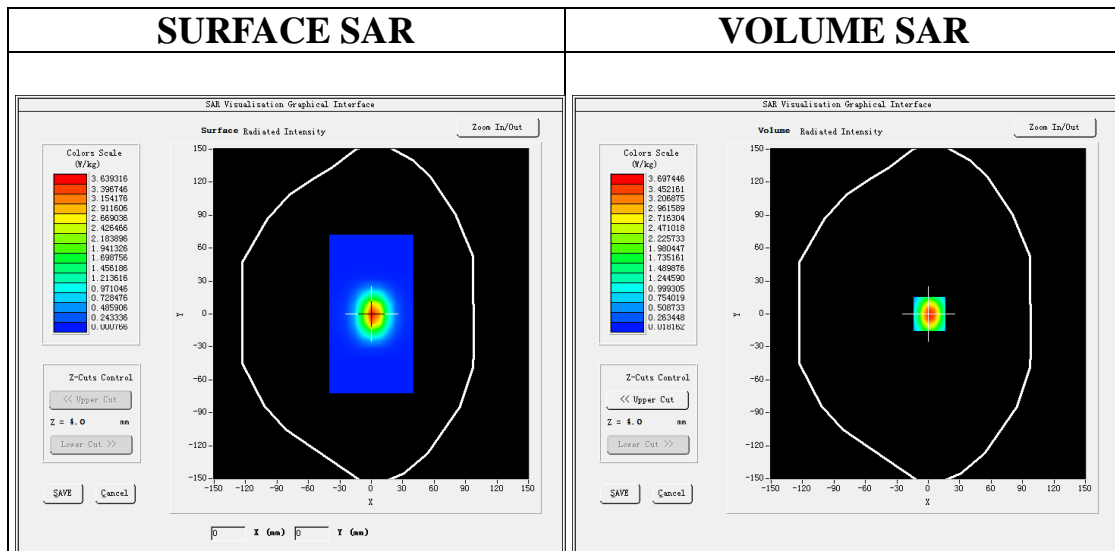

**Maximum location: X=1.00, Y=0.00**

**SAR Peak: 6.39 W/kg**

<b>SAR 10g (W/Kg)</b>	1.535914
<b>SAR 1g (W/Kg)</b>	3.419423

Any report having not been signed by authorized approver, or having been altered without authorization, or having not been stamped by the "Dedicated Testing/Inspection Stamp" is deemed to be invalid. Copying or excerpting portion of, or altering the content of the report is not permitted without the written authorization of AGC. The test results presented in the report apply only to the tested sample. Any objections to report issued by AGC should be submitted to AGC within 15days after the issuance of the test report. Further enquiry of validity or verification of the test report should be addressed to AGC by agc01@agccert.com.

Attestation of Global Compliance(Shenzhen)Co., Ltd

Attestation of Global Compliance(Shenzhen)Std & Tech Co., Ltd

Tel: +86-755 2523 4088 E-mail: agc@agccert.com Web: http://www.agccert.com/

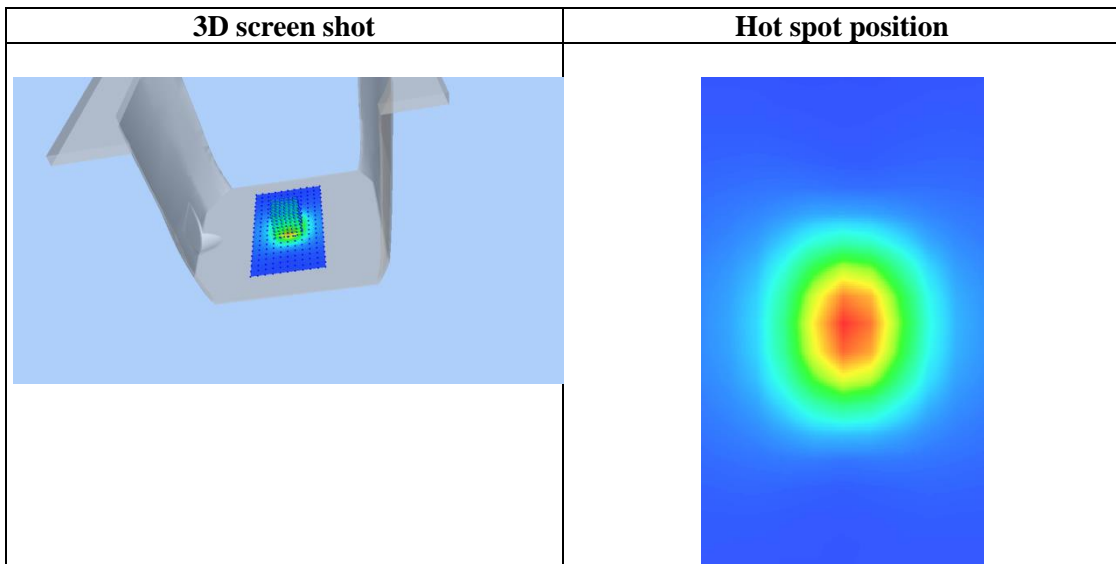
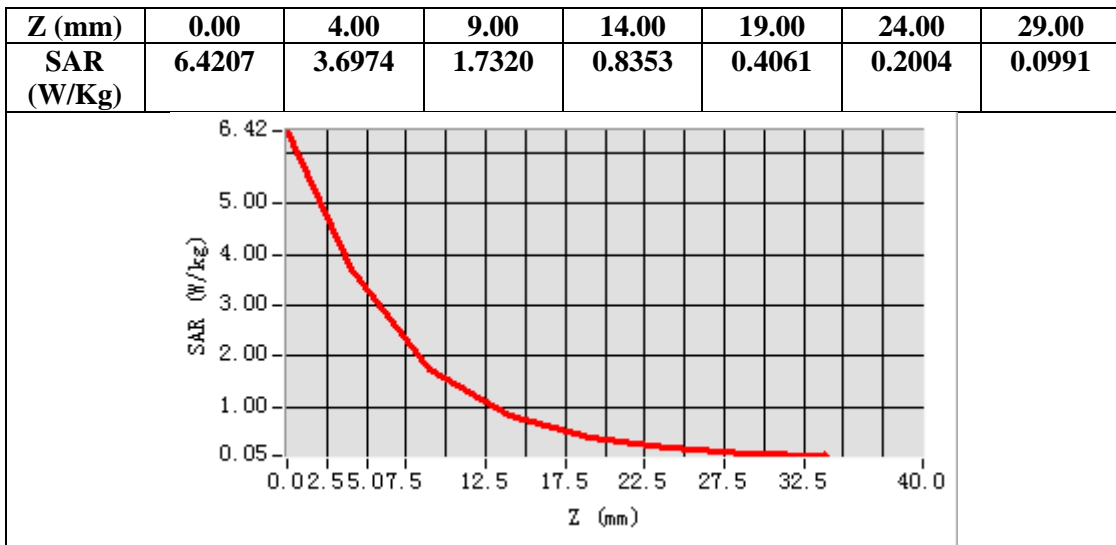

Any report having not been signed by authorized approver, or having been altered without authorization, or having not been stamped by the "Dedicated Testing/Inspection Stamp" is deemed to be invalid. Copying or excerpting portion of, or altering the content of the report is not permitted without the written authorization of AGC. The test results presented in the report apply only to the tested sample. Any objections to report issued by AGC should be submitted to AGC within 15days after the issuance of the test report. Further enquiry of validity or verification of the test report should be addressed to AGC by agc01@agccert.com.

**Test Laboratory: AGC Lab**  
**System Check 5200 MHz**

**Date: Oct. 16,2022**

**DUT: Dipole 5000MHz Type: SID5500**

Communication System: CW; Communication System Band: D5000 (5000.0 MHz); Duty Cycle: 1:1; Conv.F=1.28  
Frequency: 5200 MHz; Medium parameters used:  $f = 5200$  MHz;  $\sigma = 4.52$  mho/m;  $\epsilon_r = 35.24$ ;  $\rho = 1000$  kg/m<sup>3</sup> ;  
Phantom section: Flat Section; Input Power=10dBm  
Ambient temperature (°C): 22.3, Liquid temperature (°C): 22.1

SATIMO Configuration:

- Probe: SSE2; Calibrated: Apr. 13, 2022; Serial No.: SN 13/22 EPGO368
- Sensor-Surface: 4mm (Mechanical Surface Detection)
- Phantom: SAM twin phantom
- Measurement SW: OpenSAR V4\_02\_32

**Configuration/System Check 5200 MHz Body/Area Scan:** Measurement grid: dx=8mm, dy=8mm

**Configuration/System Check 5200 MHz Body/Zoom Scan:** Measurement grid: dx=4mm,dy=4mm, dz=2mm

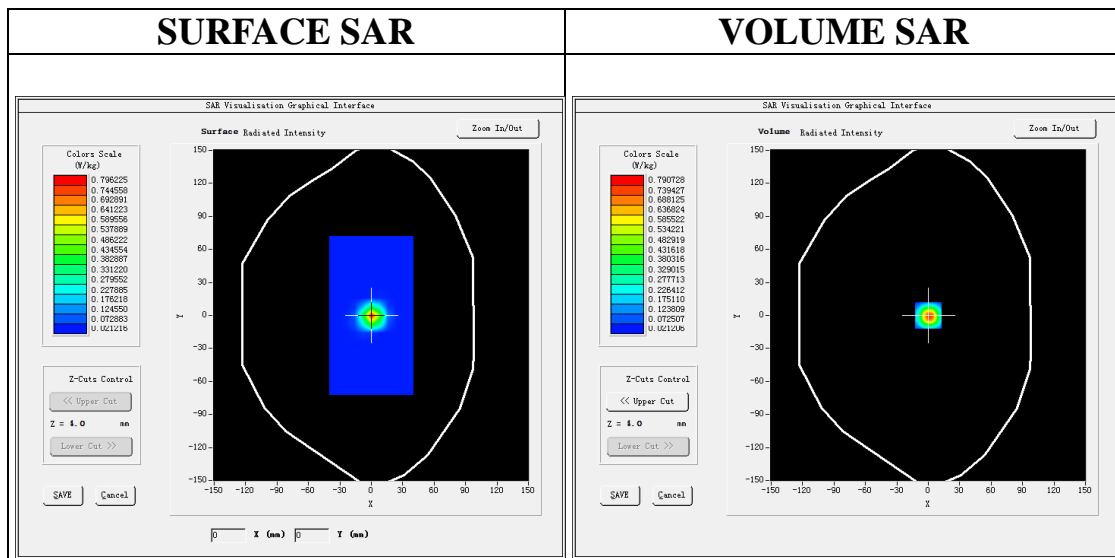

**Maximum location: X=0.00, Y=0.00**  
**SAR Peak: 2.21 W/kg**

<b>SAR 10g (W/Kg)</b>	0.210648
<b>SAR 1g (W/Kg)</b>	0.734259

Any report having not been signed by authorized approver, or having been altered without authorization, or having not been stamped by the "Dedicated Testing/Inspection Stamp" is deemed to be invalid. Copying or excerpting portion of, or altering the content of the report is not permitted without the written authorization of AGC. The test results presented in the report apply only to the tested sample. Any objections to report issued by AGC should be submitted to AGC within 15days after the issuance of the test report. Further enquiry of validity or verification of the test report should be addressed to AGC by agc01@agccert.com.

Attestation of Global Compliance(Shenzhen)Co., Ltd

Attestation of Global Compliance(Shenzhen)Std & Tech Co., Ltd

Tel: +86-755 2523 4088 E-mail: agc@agccert.com Web: http://www.agccert.com/

Z (mm)	0.00	4.00	6.00	8.00	10.00	12.00	14.00	16.00	18.00	20.00	22.00	24.00
SAR (W/Kg)	2.2199	0.7907	0.3969	0.1901	0.0808	0.0351	0.0272	0.0213	0.0234	0.0234	0.0234	0.0234

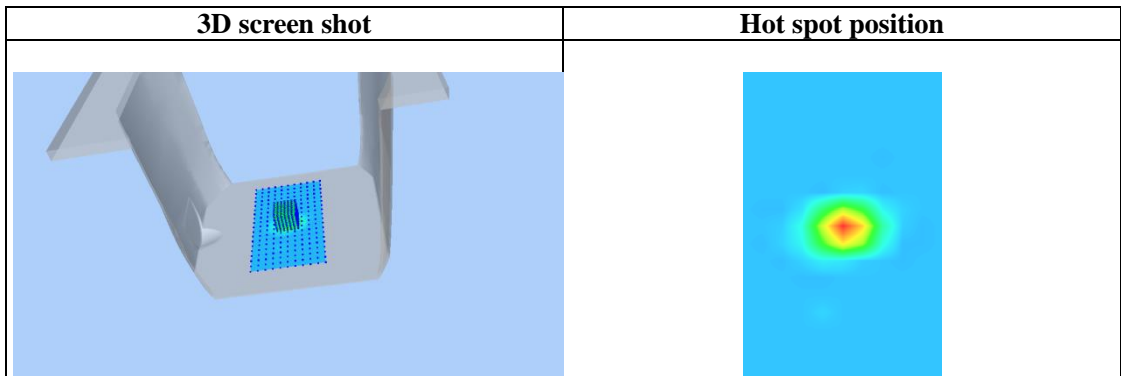
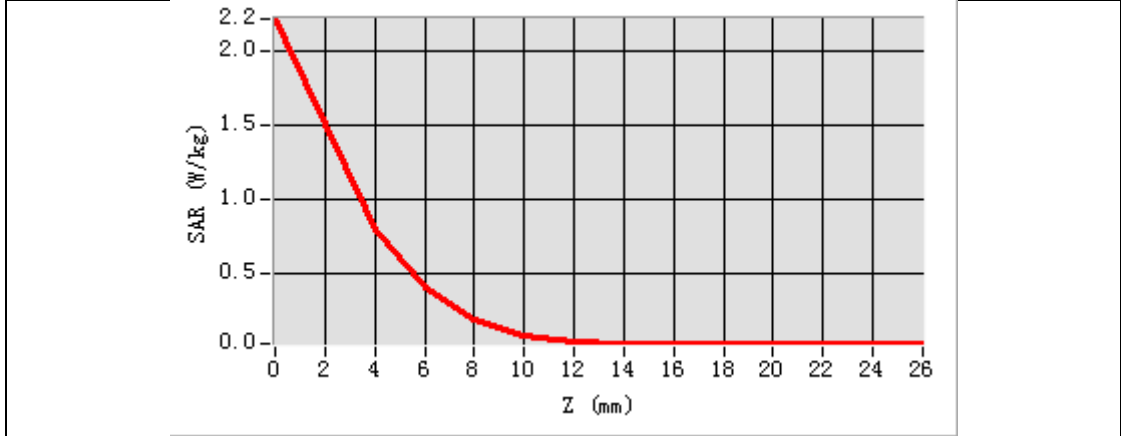

Any report having not been signed by authorized approver, or having been altered without authorization, or having not been stamped by the "Dedicated Testing/Inspection Stamp" is deemed to be invalid. Copying or excerpting portion of, or altering the content of the report is not permitted without the written authorization of AGC. The test results presented in the report apply only to the tested sample. Any objections to report issued by AGC should be submitted to AGC within 15days after the issuance of the test report. Further enquiry of validity or verification of the test report should be addressed to AGC by agc01@agccert.com.

**Test Laboratory: AGC Lab**  
**System Check Head 5600 MHz**  
**DUT: Dipole 5000MHz Type: SID5000**

**Date: Oct. 17,2022**

Communication System: CW; Communication System Band: D5000 (5000.0 MHz); Duty Cycle: 1:1; Conv.F=1.52  
Frequency: 5600 MHz; Medium parameters used:  $f = 5600$  MHz;  $\sigma = 5.24$  mho/m;  $\epsilon_r = 34.99$ ;  $\rho = 1000$  kg/m<sup>3</sup> ;  
Phantom section: Flat Section; Input Power=10dBm  
Ambient temperature (°C): 22.2, Liquid temperature (°C): 22.0

SATIMO Configuration:

- Probe: SSE2; Calibrated: Apr. 13, 2022; Serial No.: SN 13/22 EPGO368
- Sensor-Surface: 4mm (Mechanical Surface Detection)
- Phantom: SAM twin phantom
- Measurement SW: OpenSAR V4\_02\_32

**Configuration/System Check 5600 MHz Head/Area Scan:** Measurement grid: dx=8mm, dy=8mm

**Configuration/System Check 5600 MHz Head/Zoom Scan:** Measurement grid: dx=4mm,dy=4mm, dz=2mm

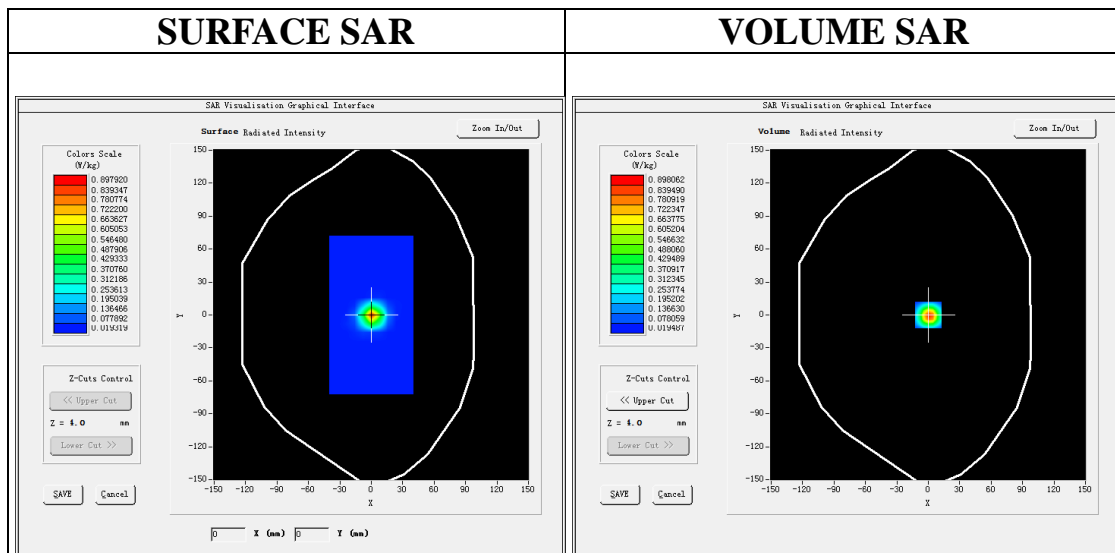

**Maximum location: X=0.00, Y=0.00**

**SAR Peak: 2.50 W/kg**

<b>SAR 10g (W/Kg)</b>	0.234755
<b>SAR 1g (W/Kg)</b>	0.825455

Any report having not been signed by authorized approver, or having been altered without authorization, or having not been stamped by the "Dedicated Testing/Inspection Stamp" is deemed to be invalid. Copying or excerpting portion of, or altering the content of the report is not permitted without the written authorization of AGC. The test results presented in the report apply only to the tested sample. Any objections to report issued by AGC should be submitted to AGC within 15days after the issuance of the test report. Further enquiry of validity or verification of the test report should be addressed to AGC by agc01@agccert.com.

Z (mm)	0.00	4.00	6.00	8.00	10.00	12.00	14.00	16.00	18.00	20.00	22.00	24.00
SAR (W/Kg)	2.5142	0.8981	0.4512	0.2124	0.0948	0.0367	0.0254	0.0196	0.0215	0.0215	0.0215	0.0215

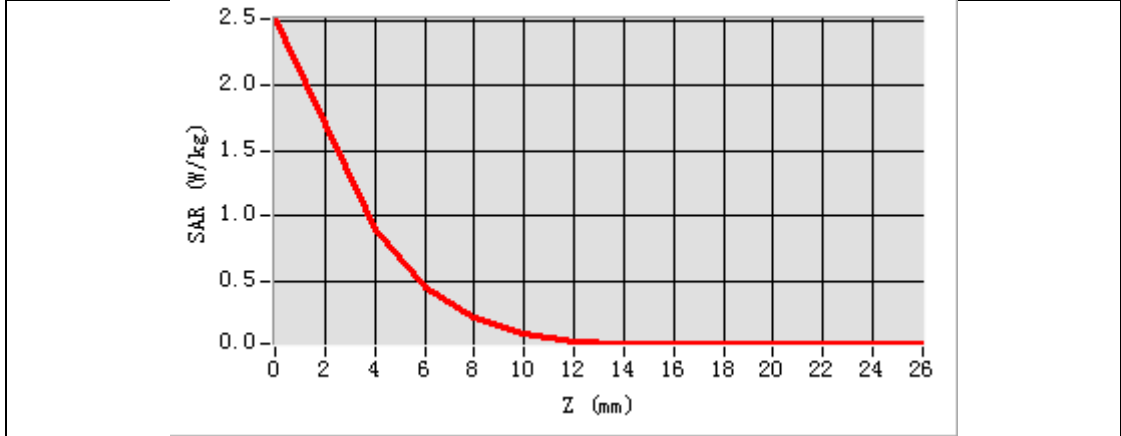

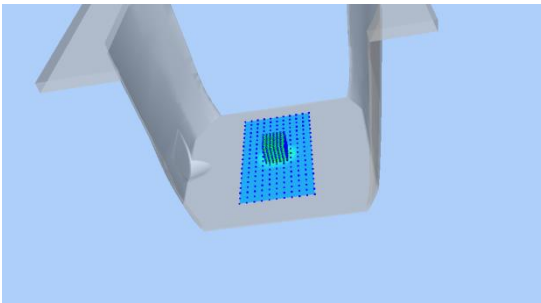
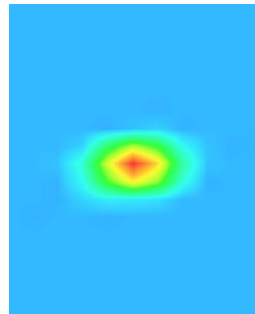
3D screen shot	Hot spot position
	

Any report having not been signed by authorized approver, or having been altered without authorization, or having not been stamped by the "Dedicated Testing/Inspection Stamp" is deemed to be invalid. Copying or excerpting portion of, or altering the content of the report is not permitted without the written authorization of AGC. The test results presented in the report apply only to the tested sample. Any objections to report issued by AGC should be submitted to AGC within 15days after the issuance of the test report. Further enquiry of validity or verification of the test report should be addressed to AGC by agc01@agccert.com.

**Test Laboratory: AGC Lab**  
**System Check Head 5800 MHz**  
**DUT: Dipole 5000MHz Type: SID5500**

**Date: Oct. 17,2022**

Communication System: CW; Communication System Band: D5000 (5000.0 MHz); Duty Cycle: 1:1; Conv.F=1.42  
Frequency: 5800 MHz; Medium parameters used:  $f = 5800$  MHz;  $\sigma = 5.22$  mho/m;  $\epsilon_r = 35.17$ ;  $\rho = 1000$  kg/m<sup>3</sup> ;  
Phantom section: Flat Section; Input Power=10dBm  
Ambient temperature (°C): 21.9, Liquid temperature (°C): 21.7

**SATIMO Configuration:**

- Probe: SSE2; Calibrated: Apr. 13, 2022; Serial No.: SN 13/22 EPGO368
- Sensor-Surface: 4mm (Mechanical Surface Detection)
- Phantom: SAM twin phantom
- Measurement SW: OpenSAR V4\_02\_32

**Configuration/System Check 5800 MHz Head/Area Scan:** Measurement grid: dx=8mm, dy=8mm

**Configuration/System Check 5800 MHz Head/Zoom Scan:** Measurement grid: dx=4mm,dy=4mm, dz=2mm

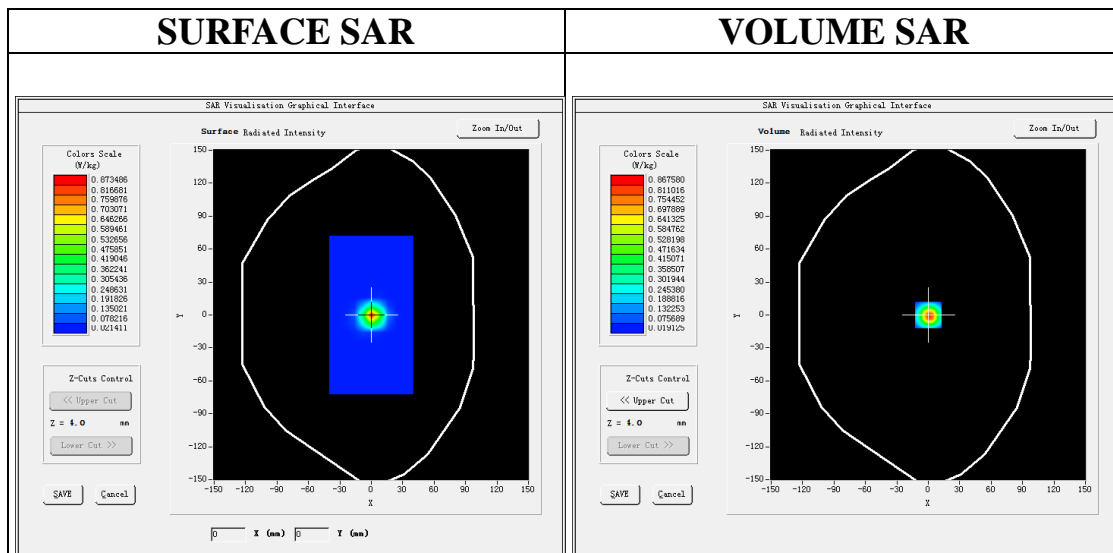

**Maximum location: X=0.00, Y=0.00**

**SAR Peak: 2.44 W/kg**

<b>SAR 10g (W/Kg)</b>	0.230603
<b>SAR 1g (W/Kg)</b>	0.804613

Any report having not been signed by authorized approver, or having been altered without authorization, or having not been stamped by the "Dedicated Testing/Inspection Stamp" is deemed to be invalid. Copying or excerpting portion of, or altering the content of the report is not permitted without the written authorization of AGC. The test results presented in the report apply only to the tested sample. Any objections to report issued by AGC should be submitted to AGC within 15days after the issuance of the test report. Further enquiry of validity or verification of the test report should be addressed to AGC by agc01@agccert.com.

Z (mm)	0.00	4.00	6.00	8.00	10.00	12.00	14.00	16.00	18.00	20.00	22.00	24.00
SAR (W/Kg)	2.4582	0.8676	0.4318	0.1971	0.0917	0.0361	0.0279	0.0217	0.0239	0.0239	0.0239	0.0239

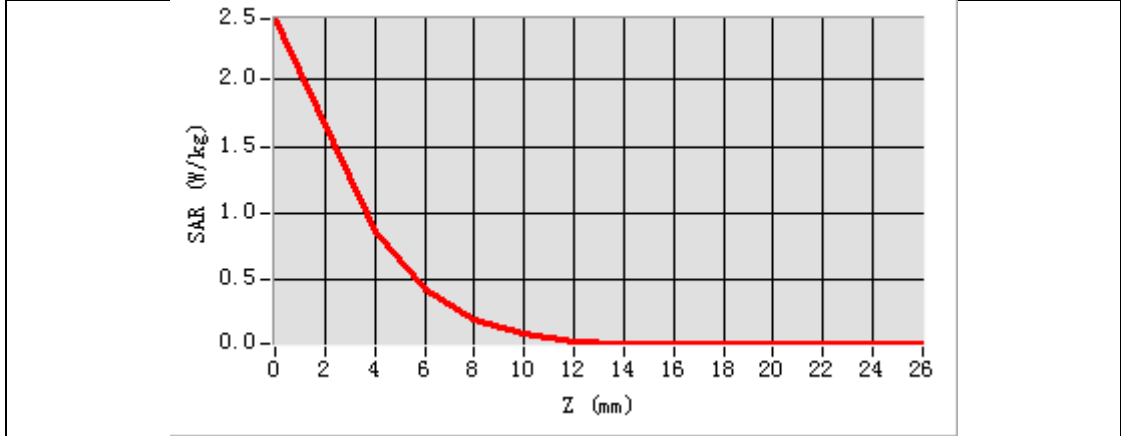

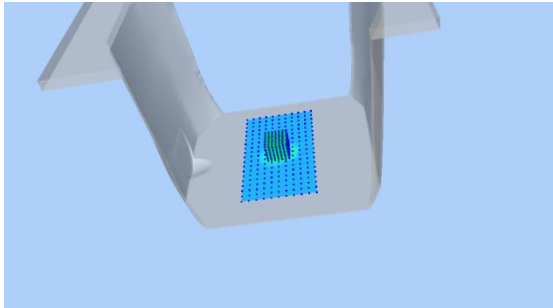
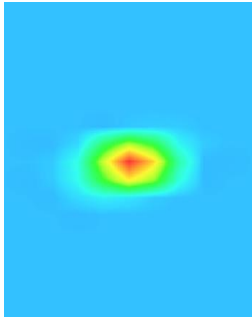
3D screen shot	Hot spot position
	

Any report having not been signed by authorized approver, or having been altered without authorization, or having not been stamped by the “Dedicated Testing/Inspection Stamp” is deemed to be invalid. Copying or excerpting portion of, or altering the content of the report is not permitted without the written authorization of AGC. The test results presented in the report apply only to the tested sample. Any objections to report issued by AGC should be submitted to AGC within 15days after the issuance of the test report. Further enquiry of validity or verification of the test report should be addressed to AGC by agc01@agccert.com.



## APPENDIX B. SAR MEASUREMENT DATA

Test Laboratory: AGC Lab

Date: Oct. 20,2022

WCDMA Band V Mid-Body-Towards Grounds (RMC)

DUT: Body Worn Camera ; Type: K7

Communication System: UMTS; Communication System Band: BAND V UTRA/FDD; Duty Cycle:1: 1; Conv.F=1.42; Frequency: 836.4 MHz; Medium parameters used:  $f = 835\text{MHz}$ ;  $\sigma = 0.95 \text{ mho/m}$ ;  $\epsilon_r = 40.69$ ;  $\rho = 1000 \text{ kg/m}^3$  ; Phantom section: Flat Section  
Ambient temperature ( $^{\circ}\text{C}$ ): 21.9, Liquid temperature ( $^{\circ}\text{C}$ ): 21.6

SATIMO Configuration:

- Probe: SSE2; Calibrated: Apr. 13, 2022; Serial No.: SN 13/22 EPGO368
- Sensor-Surface: 4mm (Mechanical Surface Detection)
- Phantom: SAM twin phantom
- Measurement SW: OpenSAR V4\_02\_32

Configuration/ WCDMA Band V Mid-Body-Back/Area Scan: Measurement grid:  $dx=8\text{mm}$ ,  $dy=8\text{mm}$

Configuration/ WCDMA Band V Mid-Body-Back/Zoom Scan: Measurement grid:  $dx=8\text{mm}$ ,  $dy=8\text{mm}$ ,  $dz=5\text{mm}$ ;

Area Scan	surf_sam_plan.txt, h= 5.00 mm
ZoomScan	5x5x7,dx=8mm dy=8mm dz=5mm,Complete
Phantom	Validation plane
Device Position	Body Back
Band	WCDMA Band V
Channels	Middle
Signal	CDMA (Crest factor: 1.0)

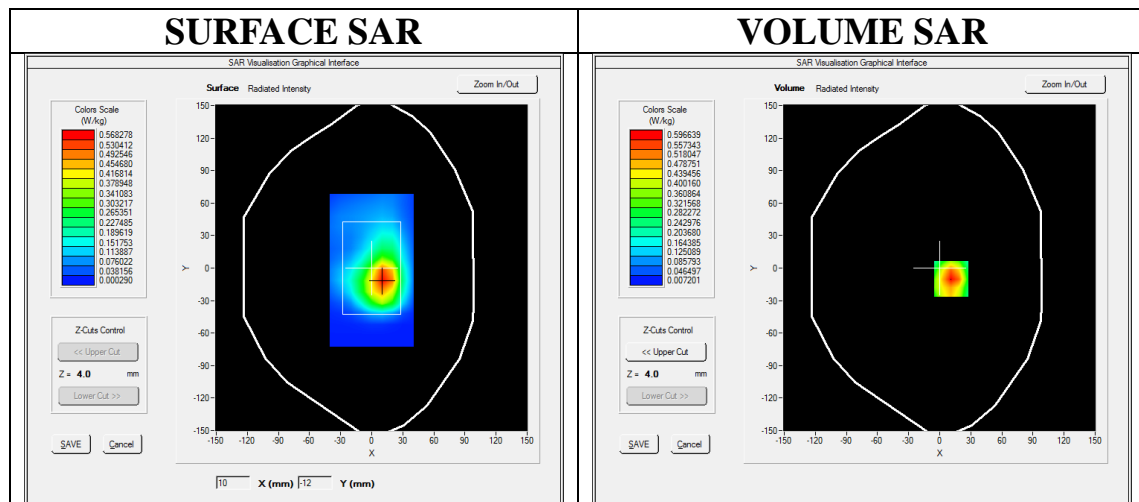

Maximum location: X=11.00, Y=-10.00

SAR Peak: 0.94 W/kg

SAR 10g (W/Kg)	0.303703
SAR 1g (W/Kg)	0.565448

Any report having not been signed by authorized approver, or having been altered without authorization, or having not been stamped by the "Dedicated Testing/Inspection Stamp" is deemed to be invalid. Copying or excerpting portion of, or altering the content of the report is not permitted without the written authorization of AGC. The test results presented in the report apply only to the tested sample. Any objections to report issued by AGC should be submitted to AGC within 15days after the issuance of the test report. Further enquiry of validity or verification of the test report should be addressed to AGC by agc01@agccert.com.

Attestation of Global Compliance(Shenzhen)Co., Ltd

Attestation of Global Compliance(Shenzhen)Std & Tech Co., Ltd

Tel: +86-755 2523 4088 E-mail: agc@agccert.com Web: http://www.agccert.com/

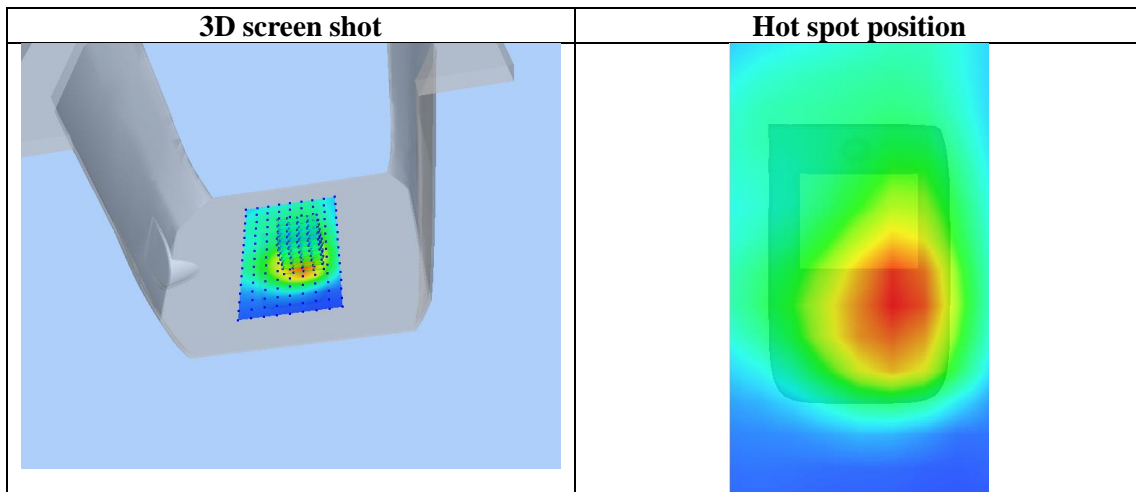
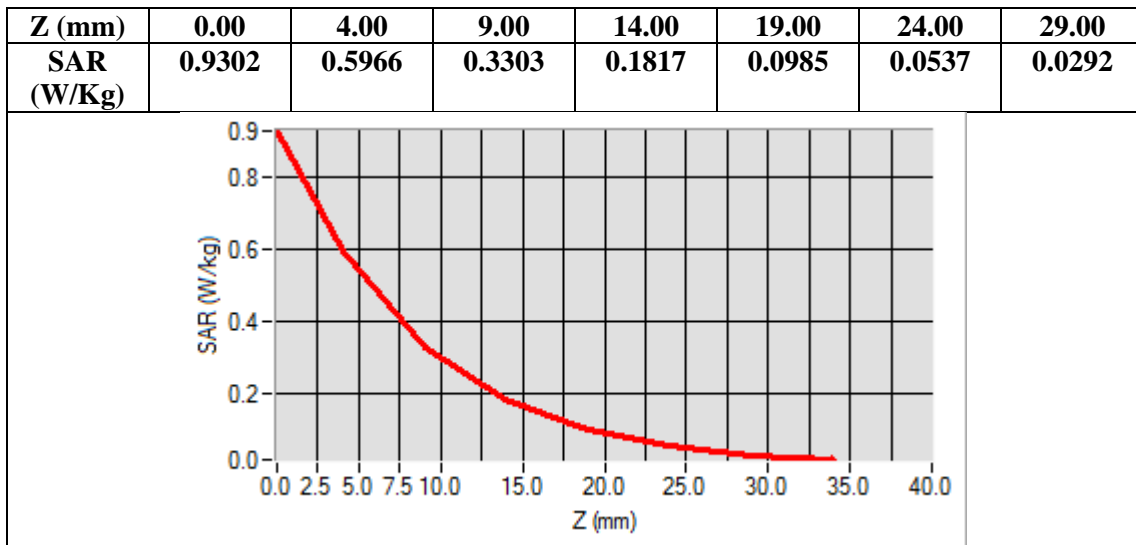

Any report having not been signed by authorized approver, or having been altered without authorization, or having not been stamped by the "Dedicated Testing/Inspection Stamp" is deemed to be invalid. Copying or excerpting portion of, or altering the content of the report is not permitted without the written authorization of AGC. The test results presented in the report apply only to the tested sample. Any objections to report issued by AGC should be submitted to AGC within 15days after the issuance of the test report. Further enquiry of validity or verification of the test report should be addressed to AGC by agc01@agccert.com.

**Test Laboratory: AGC Lab**  
**LTE Band 5 Mid- Edge 4(Left) (1 RB#0)**  
**DUT: Body Worn Camera ; Type: K7**

**Date: Oct. 20,2022**

Communication System: LTE; Communication System Band: LTE Band 5; Duty Cycle:1:1; Conv.F=1.42  
Frequency:836.5 MHz; Medium parameters used:  $f = 835$  MHz;  $\sigma=0.97$ mho/m;  $\epsilon_r=40.69$ ;  $\rho= 1000$  kg/m<sup>3</sup> ;  
Phantom section: Flat Section  
Ambient temperature (°C): 21.9, Liquid temperature (°C): 21.6

**SATIMO Configuration:**

- Probe: SSE2; Calibrated: Apr. 13, 2022; Serial No.: SN 13/22 EPGO368
- Sensor-Surface: 4mm (Mechanical Surface Detection)
- Phantom: SAM twin phantom
- Measurement SW: OpenSAR V4\_02\_32

**Configuration/ LTE Band 5 Mid- Edge 4(Left)/Area Scan:** Measurement grid: dx=8mm, dy=8mm  
**Configuration/ LTE Band 5 Mid- Edge 4(Left)/Zoom Scan:** Measurement grid: dx=8mm,dy=8mm, dz=5mm;

<b>Area Scan</b>	surf_sam_plan.txt, h= 5.00 mm
<b>Zoom Scan</b>	5x5x7,dx=8mm dy=8mm dz=5mm
<b>Phantom</b>	Validation plane
<b>Device Position</b>	Edge 4(Left)
<b>Band</b>	LTE Band 5
<b>Channels</b>	Middle
<b>Signal</b>	OFDM (Crest factor: 1.0)

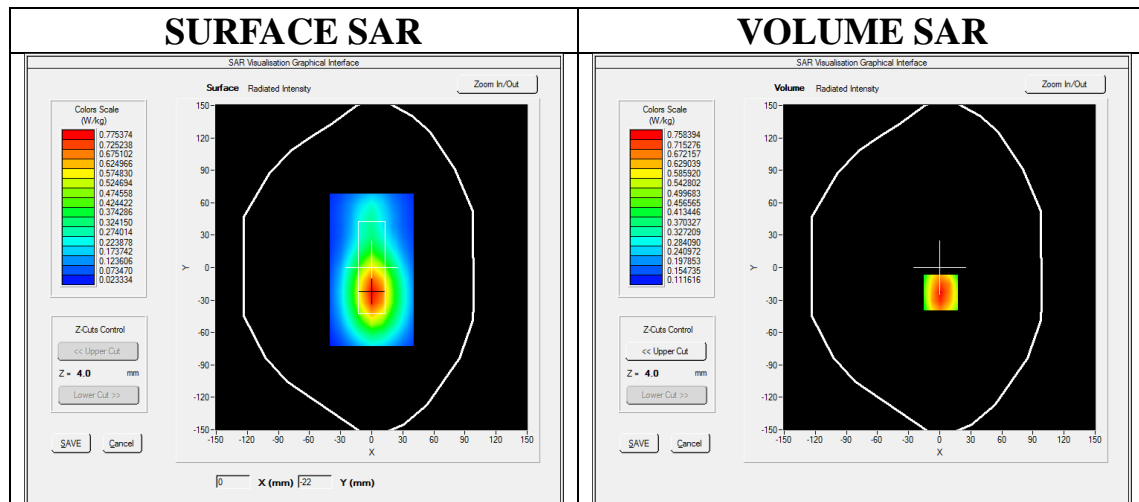

**Maximum location: X=1.00, Y=-23.00**

**SAR Peak: 0.99 W/kg**

<b>SAR 10g (W/Kg)</b>	0.502815
<b>SAR 1g (W/Kg)</b>	0.718098

Any report having not been signed by authorized approver, or having been altered without authorization, or having not been stamped by the “Dedicated Testing/Inspection Stamp” is deemed to be invalid. Copying or excerpting portion of, or altering the content of the report is not permitted without the written authorization of AGC. The test results presented in the report apply only to the tested sample. Any objections to report issued by AGC should be submitted to AGC within 15days after the issuance of the test report. Further enquiry of validity or verification of the test report should be addressed to AGC by agc01@agccert.com.

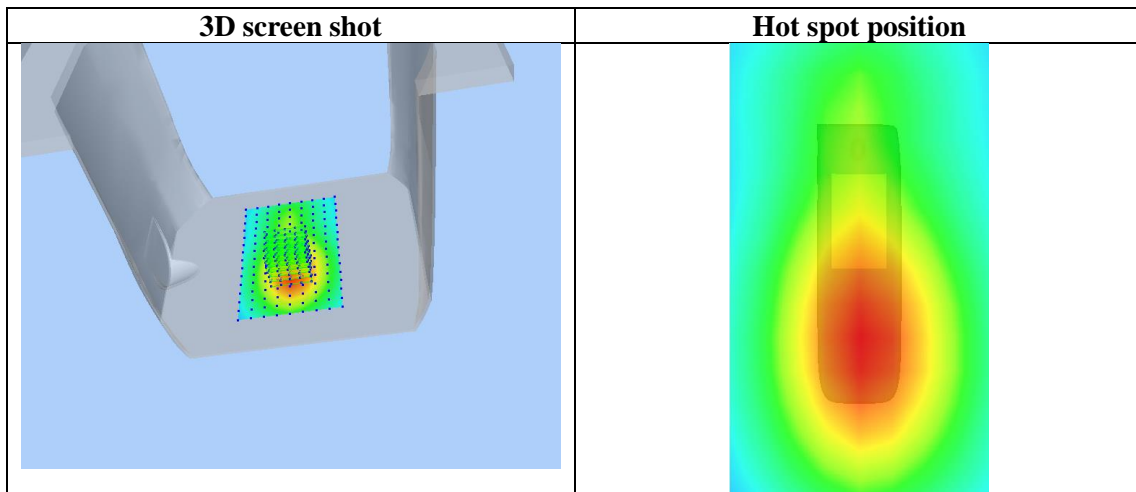
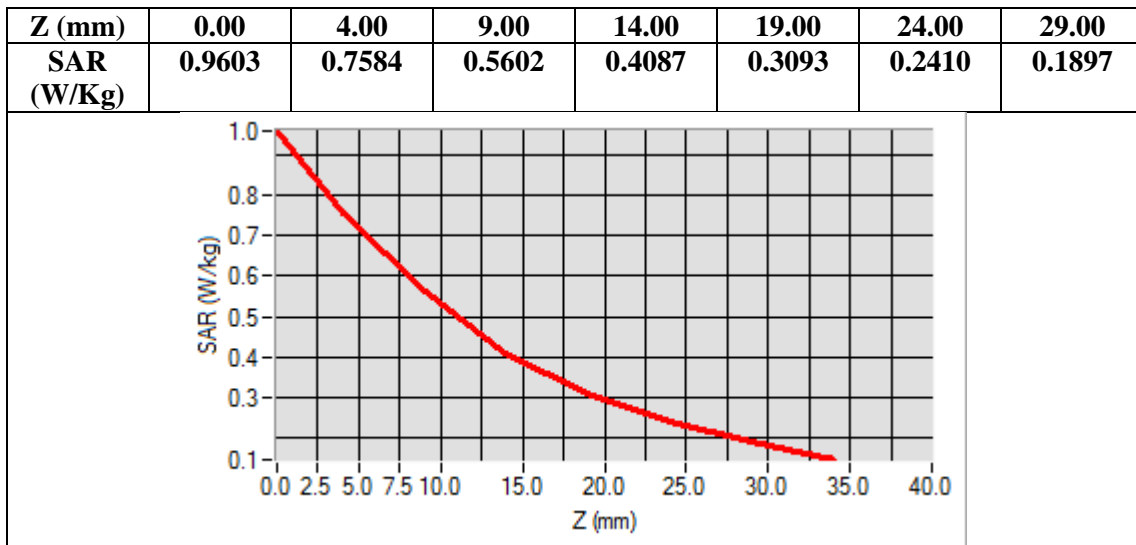

Any report having not been signed by authorized approver, or having been altered without authorization, or having not been stamped by the "Dedicated Testing/Inspection Stamp" is deemed to be invalid. Copying or excerpting portion of, or altering the content of the report is not permitted without the written authorization of AGC. The test results presented in the report apply only to the tested sample. Any objections to report issued by AGC should be submitted to AGC within 15days after the issuance of the test report. Further enquiry of validity or verification of the test report should be addressed to AGC by agc01@agccert.com.

**Test Laboratory: AGC Lab**  
**LTE Band 41 Mid- Edge 4(Left) (1RB#0)**  
**DUT: Body Worn Camera ; Type: K7**

**Date: Oct. 19,2022**

Communication System: LTE; Communication System Band: LTE Band 41; Duty Cycle:1:1.58; Conv.F=1.82  
Frequency: 2593MHz; Medium parameters used:  $f = 2600$  MHz;  $\sigma = 1.89$  mho/m;  $\epsilon_r = 39.67$ ;  $\rho = 1000$  kg/m<sup>3</sup> ;  
Phantom section: Flat Section  
Ambient temperature (°C): 21.7, Liquid temperature (°C): 21.5

**SATIMO Configuration:**

- Probe: SSE2; Calibrated: Apr. 13, 2022; Serial No.: SN 13/22 EPGO368
- Sensor-Surface: 4mm (Mechanical Surface Detection)
- Phantom: SAM twin phantom
- Measurement SW: OpenSAR V4\_02\_32

**Configuration/ LTE BAND 41 Mid- Edge 4(Left)/Area Scan:** Measurement grid: dx=10mm, y=10mm  
**Configuration/ LTE BAND 41 Mid- Edge 4(Left) /Zoom Scan:** Measurement grid: dx=5mm, dy=5mm, dz=5mm

<b>Area Scan</b>	surf_sam_plan.txt, h= 5.00 mm
<b>ZoomScan</b>	7x7x7,dx=5mm dy=5mm dz=5mm
<b>Phantom</b>	Validation plane
<b>Device Position</b>	Edge 4(Left)
<b>Band</b>	LTE BAND 41
<b>Channels</b>	Middle
<b>Signal</b>	OFDM (Crest factor: 1.58)

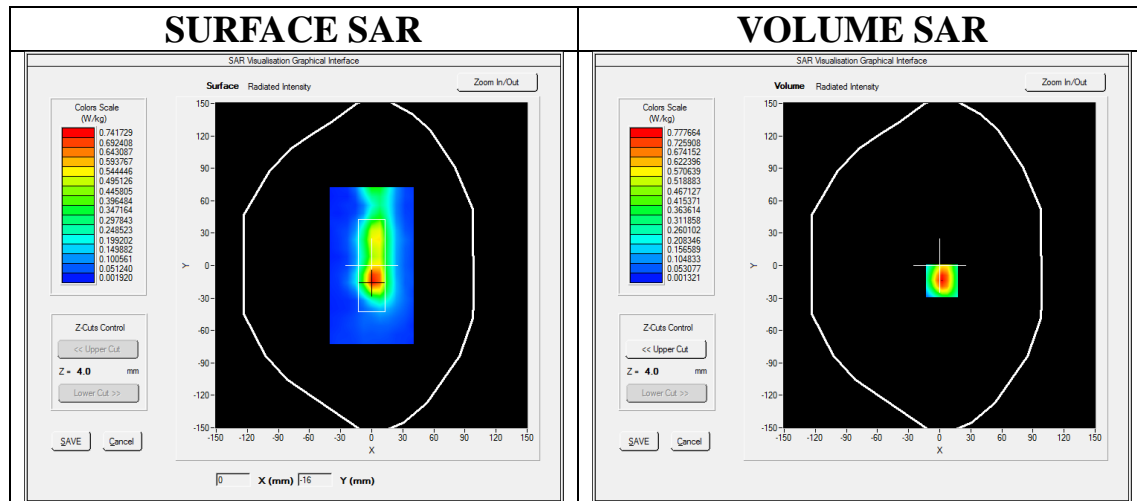

**Maximum location: X=2.00, Y=-14.00**  
**SAR Peak: 1.33 W/kg**

<b>SAR 10g (W/Kg)</b>	0.331630
<b>SAR 1g (W/Kg)</b>	0.720433

Any report having not been signed by authorized approver, or having been altered without authorization, or having not been stamped by the “Dedicated Testing/Inspection Stamp” is deemed to be invalid. Copying or excerpting portion of, or altering the content of the report is not permitted without the written authorization of AGC. The test results presented in the report apply only to the tested sample. Any objections to report issued by AGC should be submitted to AGC within 15days after the issuance of the test report. Further enquiry of validity or verification of the test report should be addressed to AGC by agc01@agccert.com.

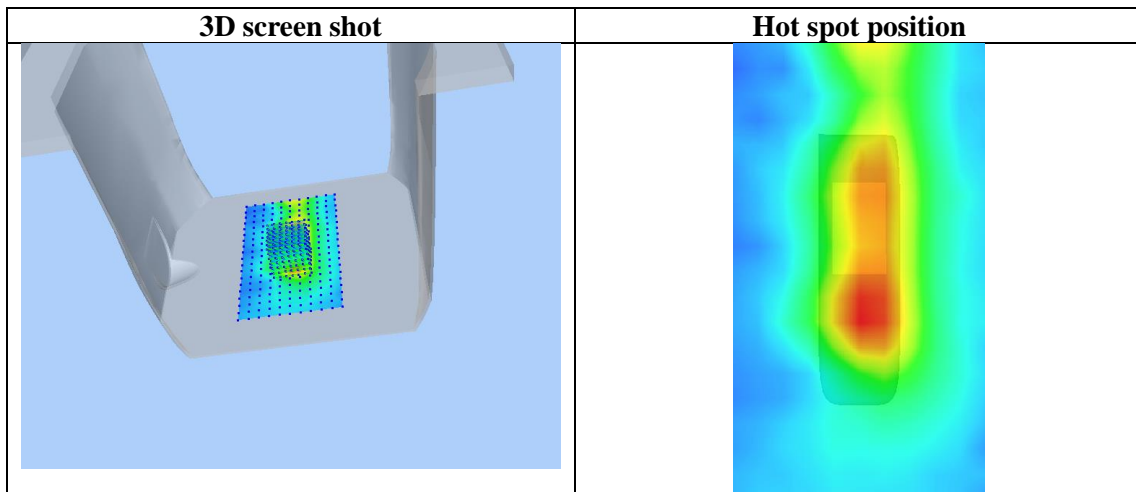
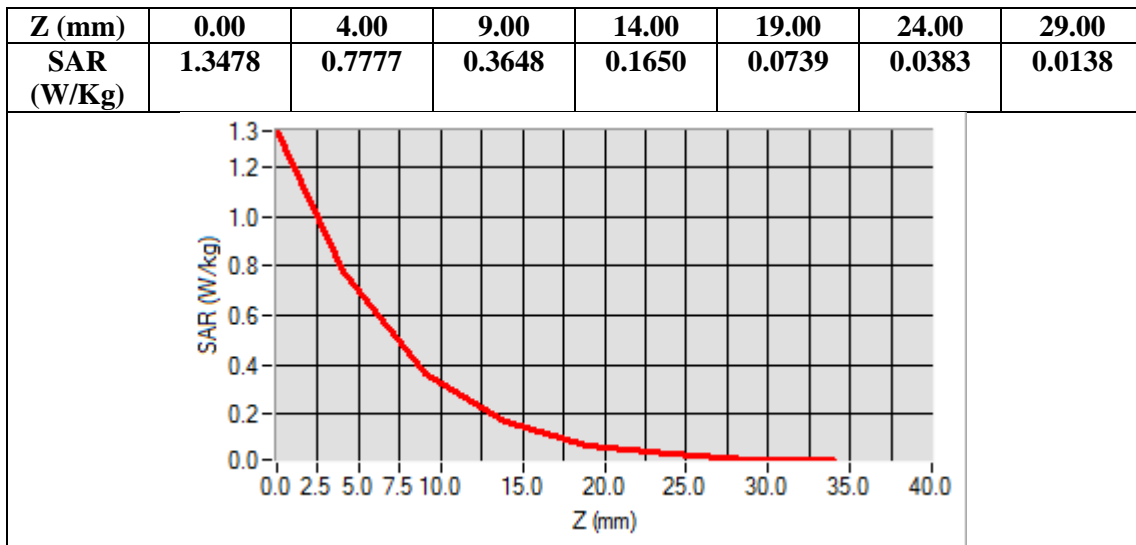

Any report having not been signed by authorized approver, or having been altered without authorization, or having not been stamped by the "Dedicated Testing/Inspection Stamp" is deemed to be invalid. Copying or excerpting portion of, or altering the content of the report is not permitted without the written authorization of AGC. The test results presented in the report apply only to the tested sample. Any objections to report issued by AGC should be submitted to AGC within 15days after the issuance of the test report. Further enquiry of validity or verification of the test report should be addressed to AGC by agc01@agccert.com.

**WIFI MODE**

Test Laboratory: AGC Lab  
802.11b Mid-Body-Worn- Back  
DUT: Body Worn Camera ; Type: K7

Date: Oct. 18,2022

Communication System: Wi-Fi; Communication System Band: 802.11b; Duty Cycle: 1:1; Conv.F=1.99;  
Frequency: 2437 MHz; Medium parameters used:  $f = 2450$  MHz;  $\sigma = 1.73$  mho/m;  $\epsilon_r = 39.12$ ;  $\rho = 1000$  kg/m<sup>3</sup> ;  
Phantom section: Flat Section  
Ambient temperature (°C):21.4, Liquid temperature (°C): 21.2

SATIMO Configuration:

- Probe: SSE2; Calibrated: Apr. 13, 2022; Serial No.: SN 13/22 EPGO368
- Sensor-Surface: 4mm (Mechanical Surface Detection)
- Phantom: SAM twin phantom
- Measurement SW: OpenSAR V4\_02\_32

Configuration/802.11b Mid- Body- Back /Area Scan: Measurement grid: dx=8mm, dy=8mm  
Configuration/802.11b Mid- Body- Back /Zoom Scan: Measurement grid: dx=5mm,dy=5mm, dz=5mm;

Area Scan	surf_sam_plan.txt, h= 5.00 mm
ZoomScan	7x7x7,dx=5mm dy=5mm dz=5mm
Phantom	Validation plane
Device Position	Body Back
Band	2450MHz
Channels	Middle
Signal	Crest factor: 1.0

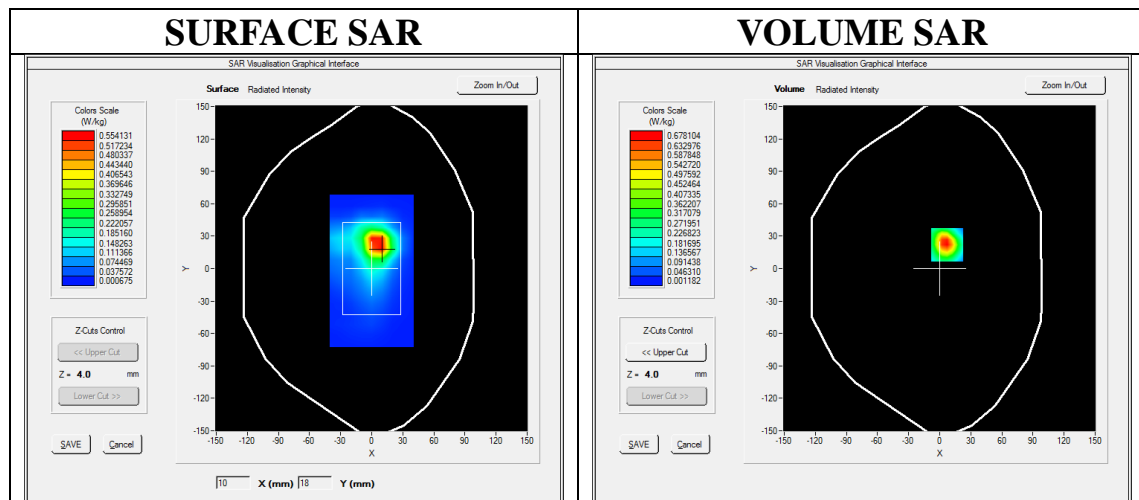

**Maximum location: X=7.00, Y=22.00**  
**SAR Peak: 1.25 W/kg**

<b>SAR 10g (W/Kg)</b>	0.266154
<b>SAR 1g (W/Kg)</b>	0.633474

Any report having not been signed by authorized approver, or having been altered without authorization, or having not been stamped by the “Dedicated Testing/Inspection Stamp” is deemed to be invalid. Copying or excerpting portion of, or altering the content of the report is not permitted without the written authorization of AGC. The test results presented in the report apply only to the tested sample. Any objections to report issued by AGC should be submitted to AGC within 15days after the issuance of the test report. Further enquiry of validity or verification of the test report should be addressed to AGC by agc01@agccert.com.

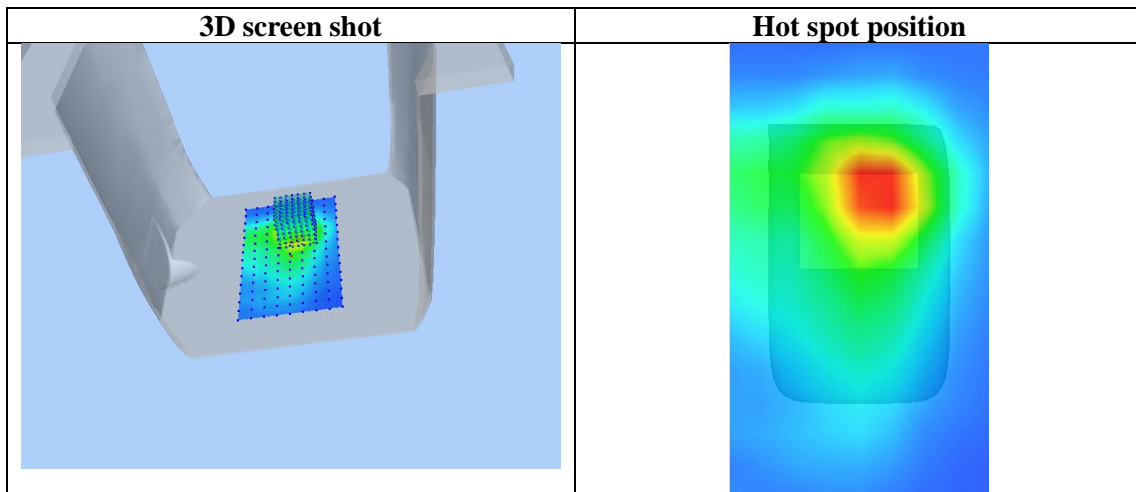
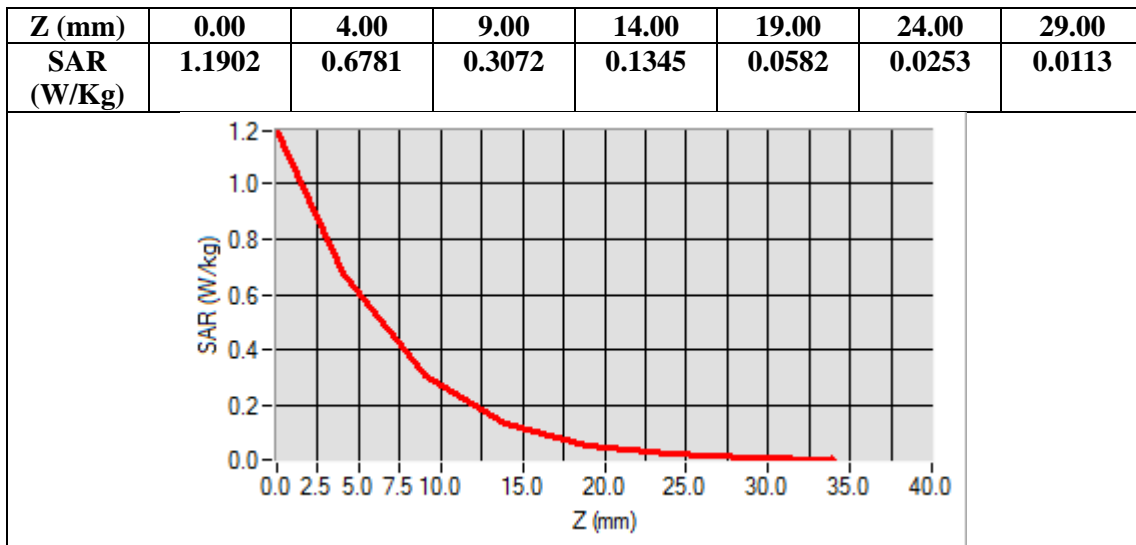

Any report having not been signed by authorized approver, or having been altered without authorization, or having not been stamped by the "Dedicated Testing/Inspection Stamp" is deemed to be invalid. Copying or excerpting portion of, or altering the content of the report is not permitted without the written authorization of AGC. The test results presented in the report apply only to the tested sample. Any objections to report issued by AGC should be submitted to AGC within 15days after the issuance of the test report. Further enquiry of validity or verification of the test report should be addressed to AGC by agc01@agccert.com.



**5.2GHz 802.11n HT20**  
**Test Laboratory: AGC Lab**  
**802.11n(20) CH48- Edge 2(Right)**  
**DUT: Body Worn Camera ; Type: K7**

**Date: Oct. 16,2022**

Communication System: Wi-Fi; Communication System Band: 802.11n(20); Duty Cycle: 1:1; Conv.F=2.35;  
 Frequency: 5240MHz; Medium parameters used:  $f = 5200$  MHz;  $\sigma = 4.93$  mho/m;  $\epsilon_r = 33.27$ ;  $\rho = 1000$  kg/m<sup>3</sup> ;  
 Phantom section: Flat Section  
 Ambient temperature (°C): 22.3, Liquid temperature (°C): 22.1

**SATIMO Configuration:**

- Probe: SSE2; Calibrated: Apr. 13, 2022; Serial No.: SN 13/22 EPGO368
- Sensor-Surface: 4mm (Mechanical Surface Detection)
- Phantom: SAM twin phantom
- Measurement SW: OpenSAR V4\_02\_32

**Configuration/802.11n(20) CH48- Edge 2(Right) /Area Scan:** Measurement grid: dx=8mm, dy=8mm  
**Configuration/802.11n(20) CH48- Edge 2(Right) /Zoom Scan:** Measurement grid: dx=4mm,dy=4mm, dz=2mm

<b>Area Scan</b>	sam_direct_droit2_surf8mm.txt
<b>ZoomScan</b>	7x7x12 dx=4mm dy=4mm dz=2mm
<b>Phantom</b>	Validation plane
<b>Device Position</b>	Edge 2(Right)
<b>Band</b>	5200MHz
<b>Channels</b>	CH48
<b>Signal</b>	Crest factor: 1.0

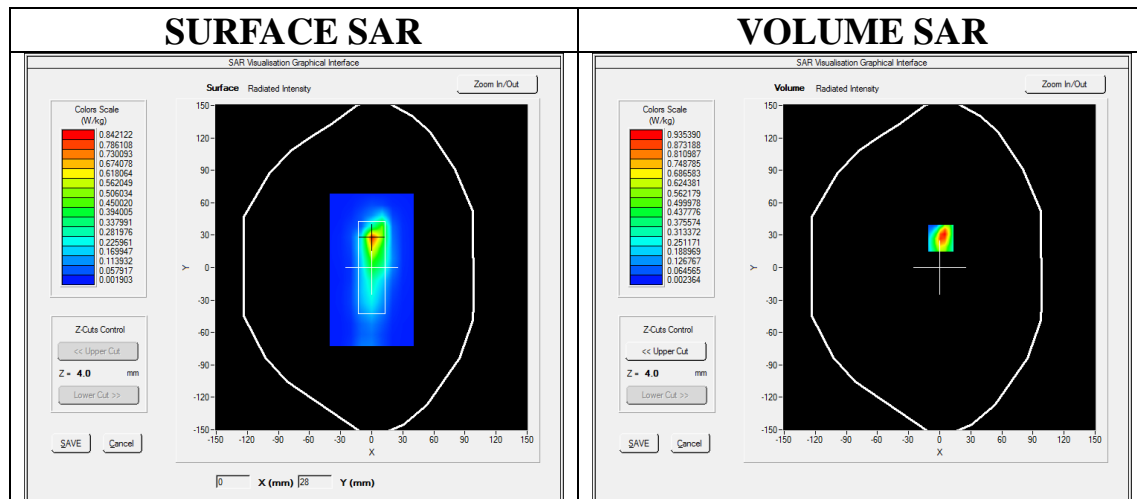

**Maximum location: X=1.00, Y=27.00**  
**SAR Peak: 1.95 W/kg**

<b>SAR 10g (W/Kg)</b>	0.306823
<b>SAR 1g (W/Kg)</b>	0.796488

Any report having not been signed by authorized approver, or having been altered without authorization, or having not been stamped by the "Dedicated Testing/Inspection Stamp" is deemed to be invalid. Copying or excerpting portion of, or altering the content of the report is not permitted without the written authorization of AGC. The test results presented in the report apply only to the tested sample. Any objections to report issued by AGC should be submitted to AGC within 15days after the issuance of the test report. Further enquiry of validity or verification of the test report should be addressed to AGC by agc01@agccert.com.

<b>Z (m m)</b>	<b>0.00</b>	<b>4.00</b>	<b>6.00</b>	<b>8.00</b>	<b>10.0 0</b>	<b>12.0 0</b>	<b>14.0 0</b>	<b>16.0 0</b>	<b>18.0 0</b>	<b>20.0 0</b>	<b>22.0 0</b>	<b>24.0 0</b>
<b>SAR (W/ Kg)</b>	<b>2.13 60</b>	<b>0.93 54</b>	<b>0.46 07</b>	<b>0.42 93</b>	<b>0.25 16</b>	<b>0.20 61</b>	<b>0.13 16</b>	<b>0.09 81</b>	<b>0.06 85</b>	<b>0.04 85</b>	<b>0.03 58</b>	<b>0.02 41</b>

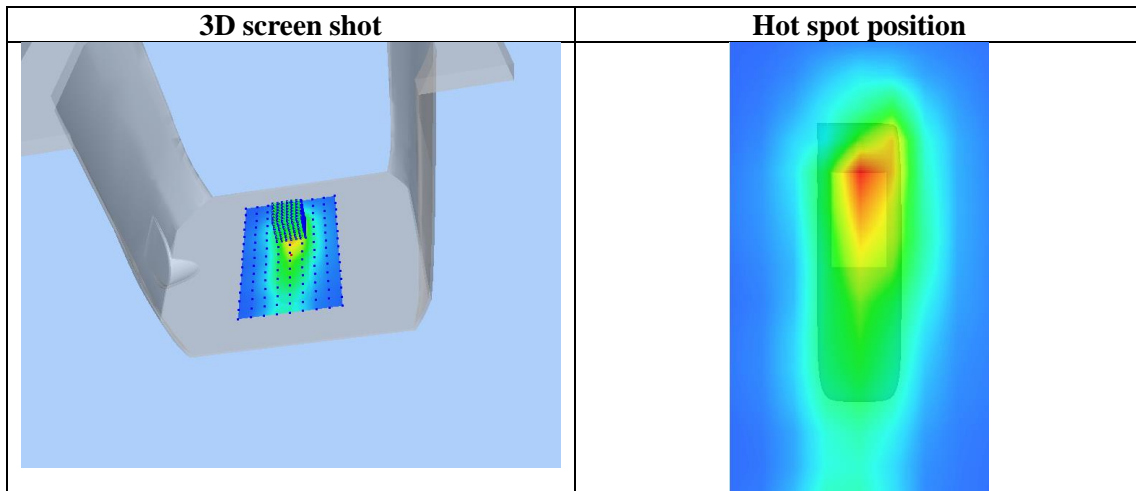
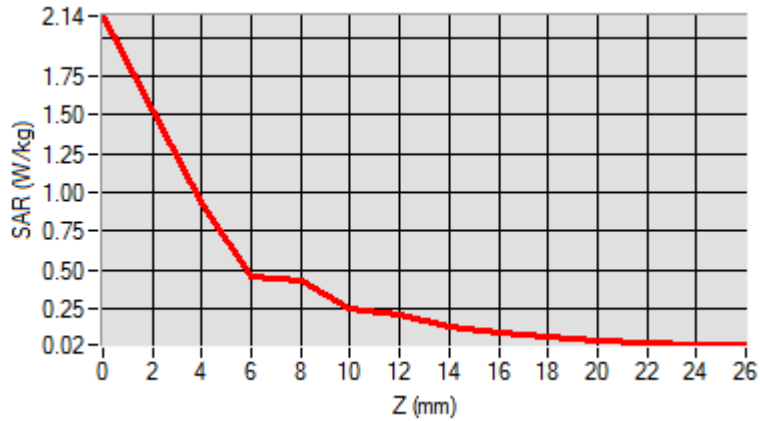

Any report having not been signed by authorized approver, or having been altered without authorization, or having not been stamped by the "Dedicated Testing/Inspection Stamp" is deemed to be invalid. Copying or excerpting portion of, or altering the content of the report is not permitted without the written authorization of AGC. The test results presented in the report apply only to the tested sample. Any objections to report issued by AGC should be submitted to AGC within 15days after the issuance of the test report. Further enquiry of validity or verification of the test report should be addressed to AGC by agc01@agccert.com.

**5.6GHz 802.11a**

**Test Laboratory: AGC Lab**  
**802.11a CH140-Edge 2 (Right)**  
**DUT: Body Worn Camera ; Type: K7**

**Date: Oct. 17,2022**

Communication System: Wi-Fi; Communication System Band: 802.11a; Duty Cycle: 1:1; Conv.F=2.51;  
Frequency: 5700MHz; Medium parameters used:  $f = 5600$  MHz;  $\sigma = 5.36$  mho/m;  $\epsilon_r = 33.21$ ;  $\rho = 1000$  kg/m<sup>3</sup> ;  
Phantom section: Flat Section  
Ambient temperature (°C): 22.2, Liquid temperature (°C): 22.0

**SATIMO Configuration:**

- Probe: SSE2; Calibrated: Apr. 13, 2022; Serial No.: SN 13/22 EPGO368
- Sensor-Surface: 4mm (Mechanical Surface Detection)
- Phantom: SAM twin phantom
- Measurement SW: OpenSAR V4\_02\_32

**Configuration/802.11a CH140-Edge 2 (Right) /Area Scan:** Measurement grid: dx=8mm, dy=8mm  
**Configuration/802.11a CH140-Edge 2 (Right)/Zoom Scan:** Measurement grid: dx=4mm,dy=4mm, dz=2mm

<b>Area Scan</b>	sam_direct_droit2_surf8mm.txt
<b>ZoomScan</b>	7x7x12 dx=4mm dy=4mm dz=2mm
<b>Phantom</b>	Validation plane
<b>Device Position</b>	Edge 2 (Right)
<b>Band</b>	5600MHz
<b>Channels</b>	CH140
<b>Signal</b>	Crest factor: 1.0

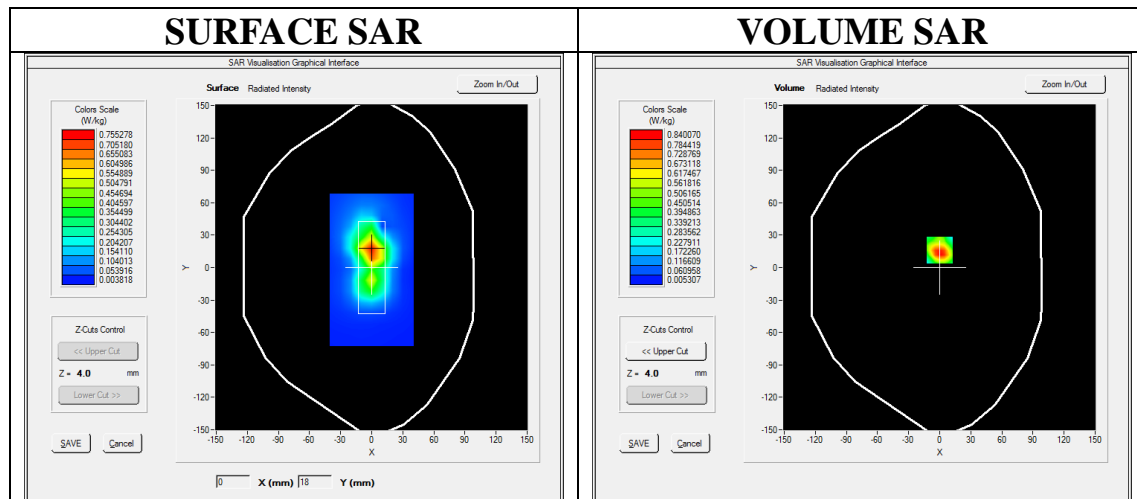

**Maximum location: X=0.00, Y=16.00**  
**SAR Peak: 1.57 W/kg**

<b>SAR 10g (W/Kg)</b>	0.332941
<b>SAR 1g (W/Kg)</b>	0.768449

Any report having not been signed by authorized approver, or having been altered without authorization, or having not been stamped by the “Dedicated Testing/Inspection Stamp” is deemed to be invalid. Copying or excerpting portion of, or altering the content of the report is not permitted without the written authorization of AGC. The test results presented in the report apply only to the tested sample. Any objections to report issued by AGC should be submitted to AGC within 15days after the issuance of the test report. Further enquiry of validity or verification of the test report should be addressed to AGC by agc01@agccert.com.

<b>Z (m m)</b>	<b>0.00</b>	<b>4.00</b>	<b>6.00</b>	<b>8.00</b>	<b>10.00</b>	<b>12.00</b>	<b>14.00</b>	<b>16.00</b>	<b>18.00</b>	<b>20.00</b>	<b>22.00</b>	<b>24.00</b>
<b>SAR (W/Kg)</b>	<b>1.7069</b>	<b>0.8401</b>	<b>0.4957</b>	<b>0.4332</b>	<b>0.2701</b>	<b>0.2296</b>	<b>0.1410</b>	<b>0.1187</b>	<b>0.0736</b>	<b>0.0627</b>	<b>0.0389</b>	<b>0.0332</b>

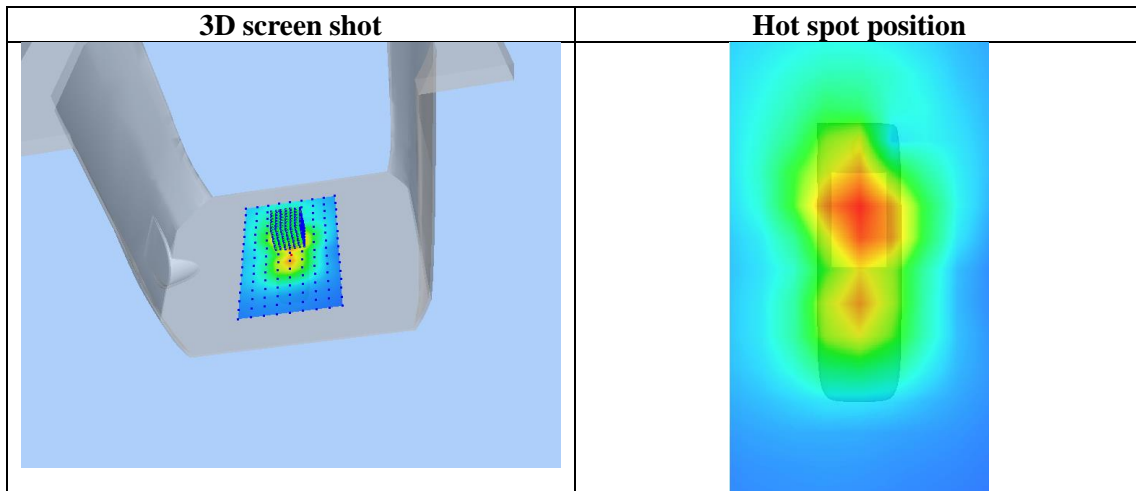
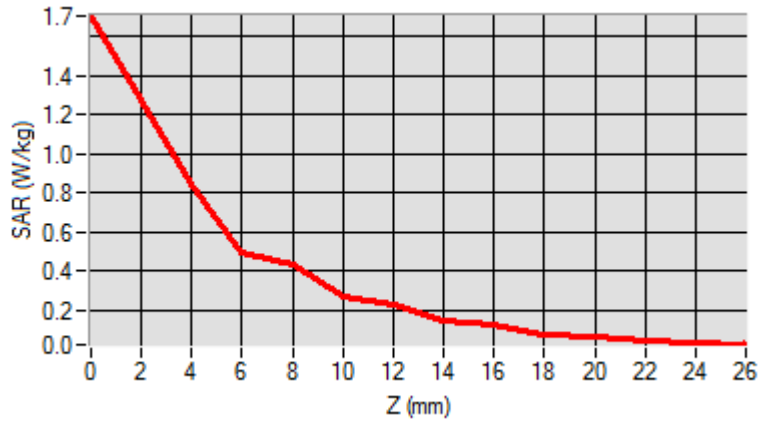

Any report having not been signed by authorized approver, or having been altered without authorization, or having not been stamped by the "Dedicated Testing/Inspection Stamp" is deemed to be invalid. Copying or excerpting portion of, or altering the content of the report is not permitted without the written authorization of AGC. The test results presented in the report apply only to the tested sample. Any objections to report issued by AGC should be submitted to AGC within 15days after the issuance of the test report. Further enquiry of validity or verification of the test report should be addressed to AGC by agc01@agccert.com.

**5.8GHz 802.11a**

**Test Laboratory: AGC Lab**  
**802.11a CH157- Edge 2 (Right)**

**Date: Oct. 17,2022**

**DUT: Body Worn Camera ; Type: K7**

Communication System: Wi-Fi; Communication System Band: 802.11n HT20; Duty Cycle: 1:1; Conv.F=1.42;  
Frequency: 5785MHz; Medium parameters used:  $f = 5800$  MHz;  $\sigma = 5.18$  mho/m;  $\epsilon_r = 36.92$ ;  $\rho = 1000$  kg/m<sup>3</sup> ;  
Phantom section: Flat Section  
Ambient temperature (°C): 21.9, Liquid temperature (°C): 21.7

**SATIMO Configuration:**

- Probe: SSE2; Calibrated: Apr. 13, 2022; Serial No.: SN 13/22 EPGO368
- Sensor-Surface: 4mm (Mechanical Surface Detection)
- Phantom: SAM twin phantom
- Measurement SW: OpenSAR V4\_02\_32

**Configuration/ 802.11a CH157- Edge 2 (Right)/Area Scan:** Measurement grid: dx=8mm, dy=8mm

**Configuration/ 802.11a CH157- Edge 2 (Right)/Zoom Scan:** Measurement grid: dx=4mm,dy=4mm, dz=2mm

<b>Area Scan</b>	sam_direct_droit2_surf8mm.txt
<b>ZoomScan</b>	7x7x12 dx=4mm dy=4mm dz=2mm
<b>Phantom</b>	Validation plane
<b>Device Position</b>	Edge 2 (Right)
<b>Band</b>	5800MHz
<b>Channels</b>	CH157
<b>Signal</b>	Crest factor: 1.0

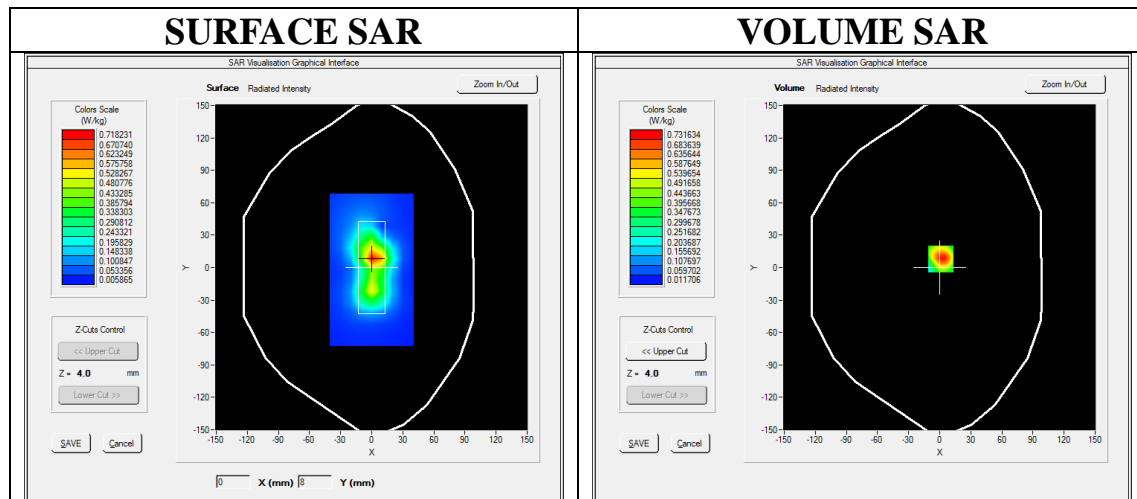

**Maximum location: X=1.00, Y=8.00**

**SAR Peak: 1.34 W/kg**

<b>SAR 10g (W/Kg)</b>	0.303500
<b>SAR 1g (W/Kg)</b>	0.674846

Any report having not been signed by authorized approver, or having been altered without authorization, or having not been stamped by the “Dedicated Testing/Inspection Stamp” is deemed to be invalid. Copying or excerpting portion of, or altering the content of the report is not permitted without the written authorization of AGC. The test results presented in the report apply only to the tested sample. Any objections to report issued by AGC should be submitted to AGC within 15days after the issuance of the test report. Further enquiry of validity or verification of the test report should be addressed to AGC by agc01@agccert.com.

Attestation of Global Compliance(Shenzhen)Co., Ltd

Attestation of Global Compliance(Shenzhen)Std & Tech Co., Ltd

Tel: +86-755 2523 4088 E-mail: agc@agccert.com Web: http://www.agccert.com/

<b>Z (m m)</b>	<b>0.00</b>	<b>4.00</b>	<b>6.00</b>	<b>8.00</b>	<b>10.0 0</b>	<b>12.0 0</b>	<b>14.0 0</b>	<b>16.0 0</b>	<b>18.0 0</b>	<b>20.0 0</b>	<b>22.0 0</b>	<b>24.0 0</b>
<b>SAR R (W/ Kg)</b>	<b>1.34 19</b>	<b>0.73 16</b>	<b>0.52 34</b>	<b>0.38 57</b>	<b>0.28 44</b>	<b>0.20 71</b>	<b>0.15 37</b>	<b>0.11 04</b>	<b>0.08 17</b>	<b>0.05 97</b>	<b>0.04 47</b>	<b>0.03 28</b>

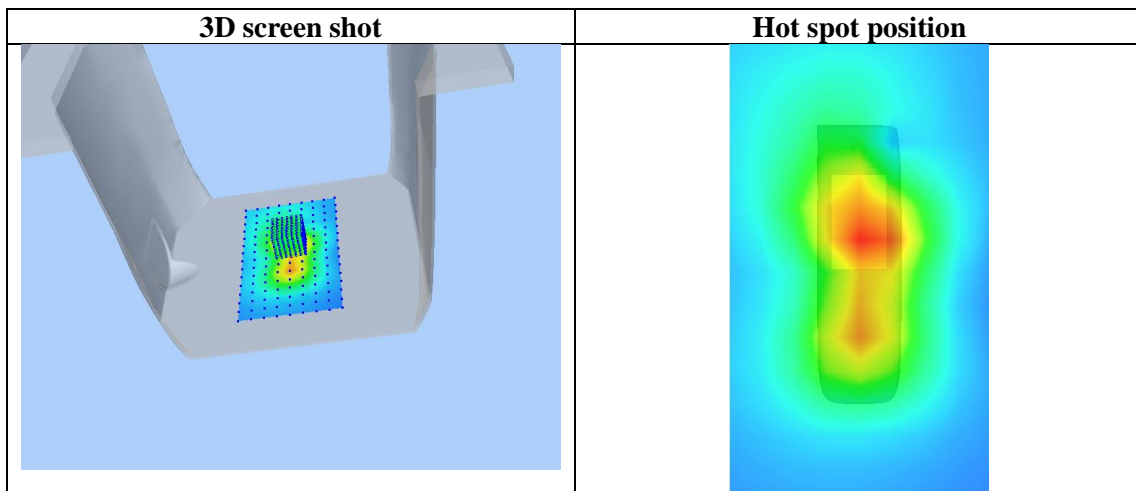
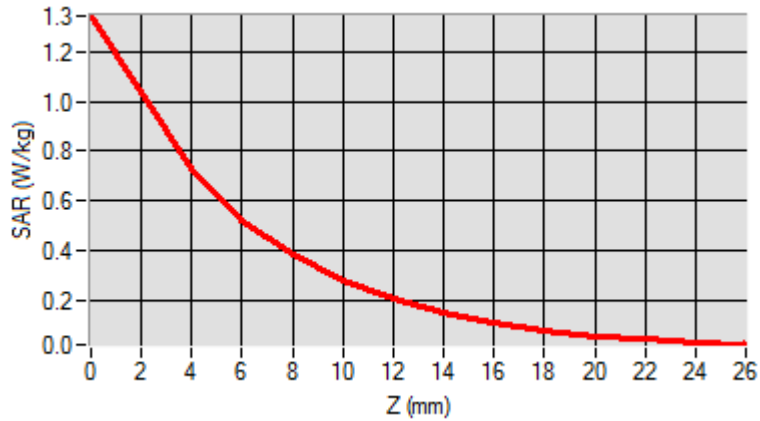

Any report having not been signed by authorized approver, or having been altered without authorization, or having not been stamped by the "Dedicated Testing/Inspection Stamp" is deemed to be invalid. Copying or excerpting portion of, or altering the content of the report is not permitted without the written authorization of AGC. The test results presented in the report apply only to the tested sample. Any objections to report issued by AGC should be submitted to AGC within 15days after the issuance of the test report. Further enquiry of validity or verification of the test report should be addressed to AGC by agc01@agccert.com.

Repeated SAR  
**5.2GHz 802.11n HT20**  
 Test Laboratory: AGC Lab  
**802.11n(20) CH48- Edge 2(Right)**  
 DUT: Body Worn Camera ; Type: K7

Date: Oct. 16,2022

Communication System: Wi-Fi; Communication System Band: 802.11n(20); Duty Cycle: 1:1; Conv.F=2.35;  
 Frequency: 5240MHz; Medium parameters used:  $f = 5200$  MHz;  $\sigma = 4.93$  mho/m;  $\epsilon_r = 33.27$ ;  $\rho = 1000$  kg/m<sup>3</sup> ;  
 Phantom section: Flat Section  
 Ambient temperature (°C): 22.3, Liquid temperature (°C): 22.1

SATIMO Configuration:

- Probe: SSE2; Calibrated: Apr. 13, 2022; Serial No.: SN 13/22 EPGO368
- Sensor-Surface: 4mm (Mechanical Surface Detection)
- Phantom: SAM twin phantom
- Measurement SW: OpenSAR V4\_02\_32

Configuration/802.11n(20) CH48- Edge 2(Right) /Area Scan: Measurement grid: dx=8mm, dy=8mm  
 Configuration/802.11n(20) CH48- Edge 2(Right) /Zoom Scan: Measurement grid: dx=4mm,dy=4mm, dz=2mm

Area Scan	sam_direct_droit2_surf8mm.txt
ZoomScan	7x7x12 dx=4mm dy=4mm dz=2mm
Phantom	Validation plane
Device Position	Edge 2(Right)
Band	5200MHz
Channels	CH48
Signal	Crest factor: 1.0

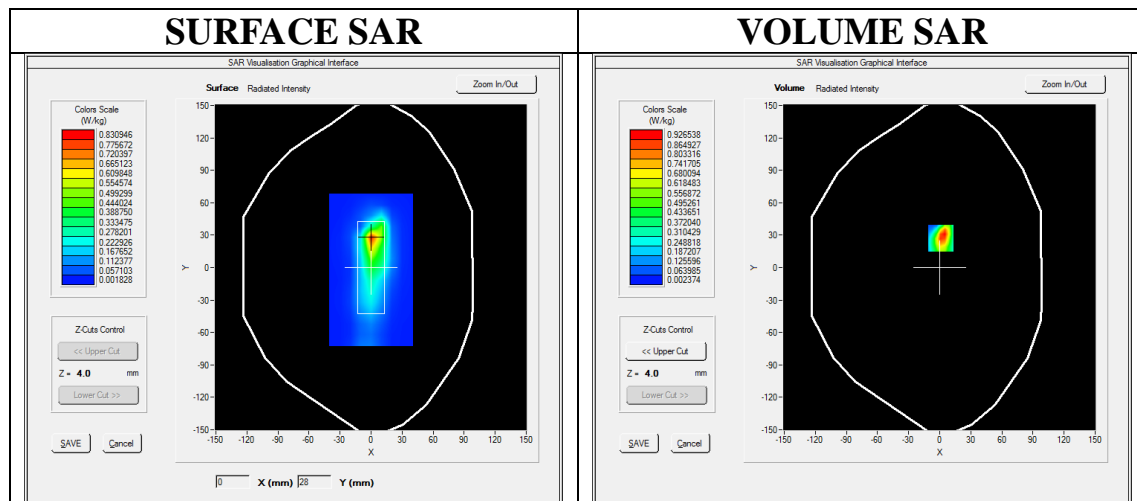

**Maximum location: X=1.00, Y=27.00**  
**SAR Peak: 1.92 W/kg**

<b>SAR 10g (W/Kg)</b>	0.298736
<b>SAR 1g (W/Kg)</b>	0.782628

Any report having not been signed by authorized approver, or having been altered without authorization, or having not been stamped by the "Dedicated Testing/Inspection Stamp" is deemed to be invalid. Copying or excerpting portion of, or altering the content of the report is not permitted without the written authorization of AGC. The test results presented in the report apply only to the tested sample. Any objections to report issued by AGC should be submitted to AGC within 15days after the issuance of the test report. Further enquiry of validity or verification of the test report should be addressed to AGC by agc01@agccert.com.

Z (m m)	0.00	4.00	6.00	8.00	10.00	12.00	14.00	16.00	18.00	20.00	22.00	24.00
SAR (W/Kg)	2.1108	0.9216	0.4524	0.4237	0.2446	0.2017	0.1281	0.0951	0.0654	0.0449	0.0338	0.0224

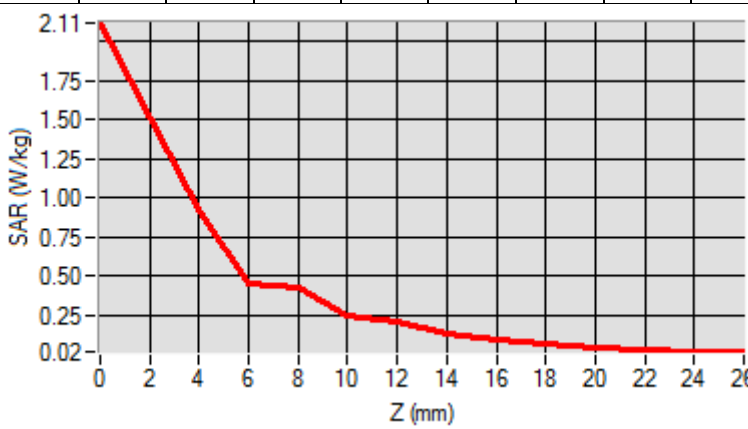
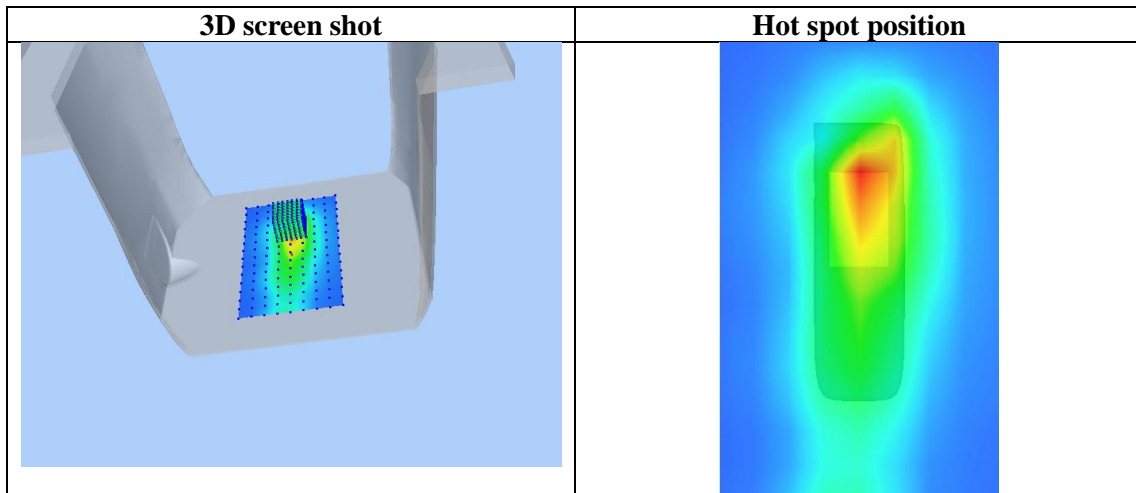
Any report having not been signed by authorized approver, or having been altered without authorization, or having not been stamped by the “Dedicated Testing/Inspection Stamp” is deemed to be invalid. Copying or excerpting portion of, or altering the content of the report is not permitted without the written authorization of AGC. The test results presented in the report apply only to the tested sample. Any objections to report issued by AGC should be submitted to AGC within 15days after the issuance of the test report. Further enquiry of validity or verification of the test report should be addressed to AGC by agc01@agccert.com.



**Test Laboratory: AGC Lab**  
**802.11a CH140-Edge 2 (Right)**  
**DUT: Body Worn Camera ; Type: K7**

**Date: Oct. 17,2022**

Communication System: Wi-Fi; Communication System Band: 802.11a; Duty Cycle: 1:1; Conv.F=2.51;  
Frequency: 5700MHz; Medium parameters used:  $f = 5600$  MHz;  $\sigma = 5.36$  mho/m;  $\epsilon_r = 33.21$ ;  $\rho = 1000$  kg/m<sup>3</sup> ;  
Phantom section: Flat Section  
Ambient temperature (°C): 22.2, Liquid temperature (°C): 22.0

**SATIMO Configuration:**

- Probe: SSE2; Calibrated: Apr. 13, 2022; Serial No.: SN 13/22 EPGO368
- Sensor-Surface: 4mm (Mechanical Surface Detection)
- Phantom: SAM twin phantom
- Measurement SW: OpenSAR V4\_02\_32

**Configuration/802.11a CH140-Edge 2 (Right) /Area Scan:** Measurement grid: dx=8mm, dy=8mm  
**Configuration/802.11a CH140-Edge 2 (Right)/Zoom Scan:** Measurement grid: dx=4mm,dy=4mm, dz=2mm

<b>Area Scan</b>	sam_direct_droit2_surf8mm.txt
<b>ZoomScan</b>	7x7x12 dx=4mm dy=4mm dz=2mm
<b>Phantom</b>	Validation plane
<b>Device Position</b>	Edge 2 (Right)
<b>Band</b>	5600MHz
<b>Channels</b>	CH140
<b>Signal</b>	Crest factor: 1.0

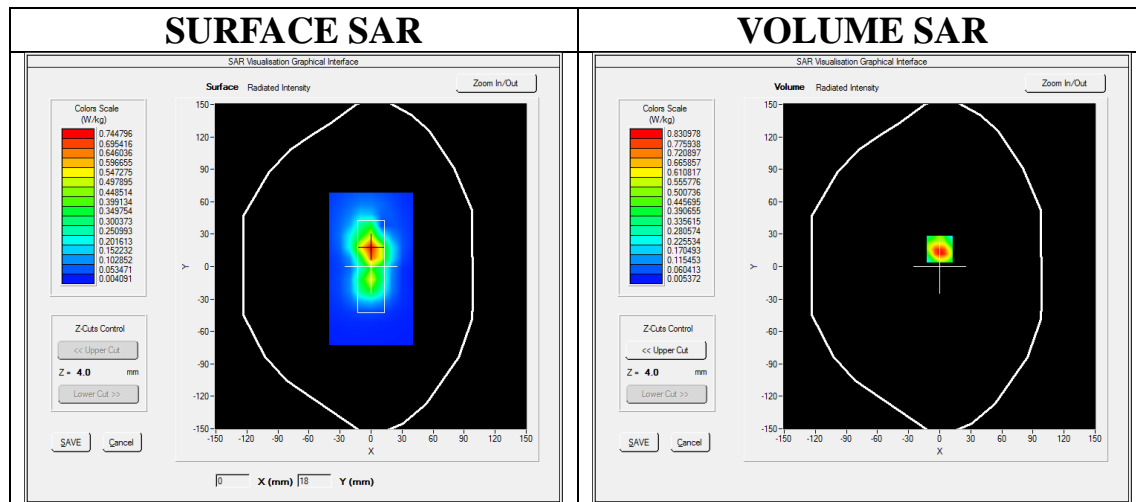

**Maximum location: X=0.00, Y=16.00**

**SAR Peak: 1.54 W/kg**

<b>SAR 10g (W/Kg)</b>	0.324094
<b>SAR 1g (W/Kg)</b>	0.752185

Any report having not been signed by authorized approver, or having been altered without authorization, or having not been stamped by the "Dedicated Testing/Inspection Stamp" is deemed to be invalid. Copying or excerpting portion of, or altering the content of the report is not permitted without the written authorization of AGC. The test results presented in the report apply only to the tested sample. Any objections to report issued by AGC should be submitted to AGC within 15days after the issuance of the test report. Further enquiry of validity or verification of the test report should be addressed to AGC by agc01@agccert.com.

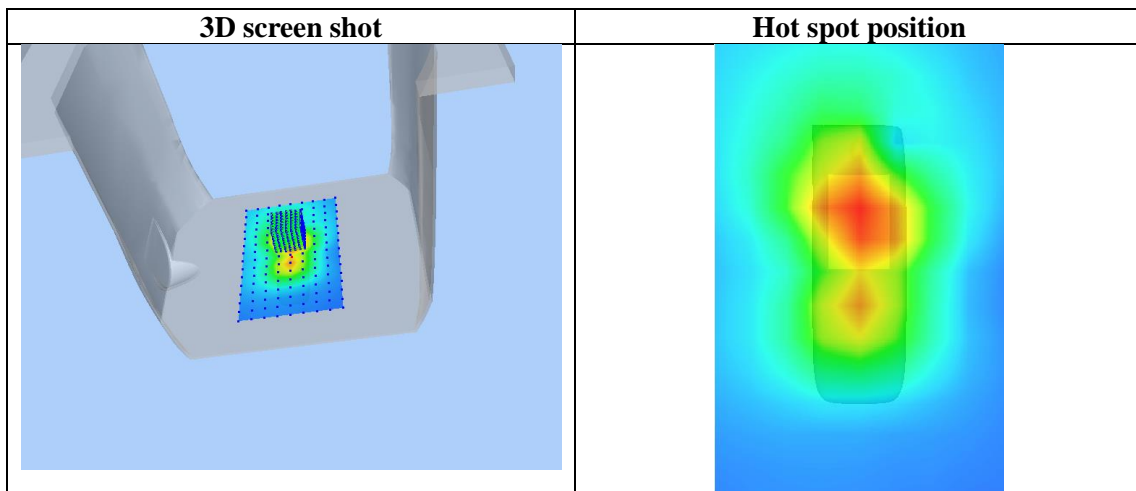
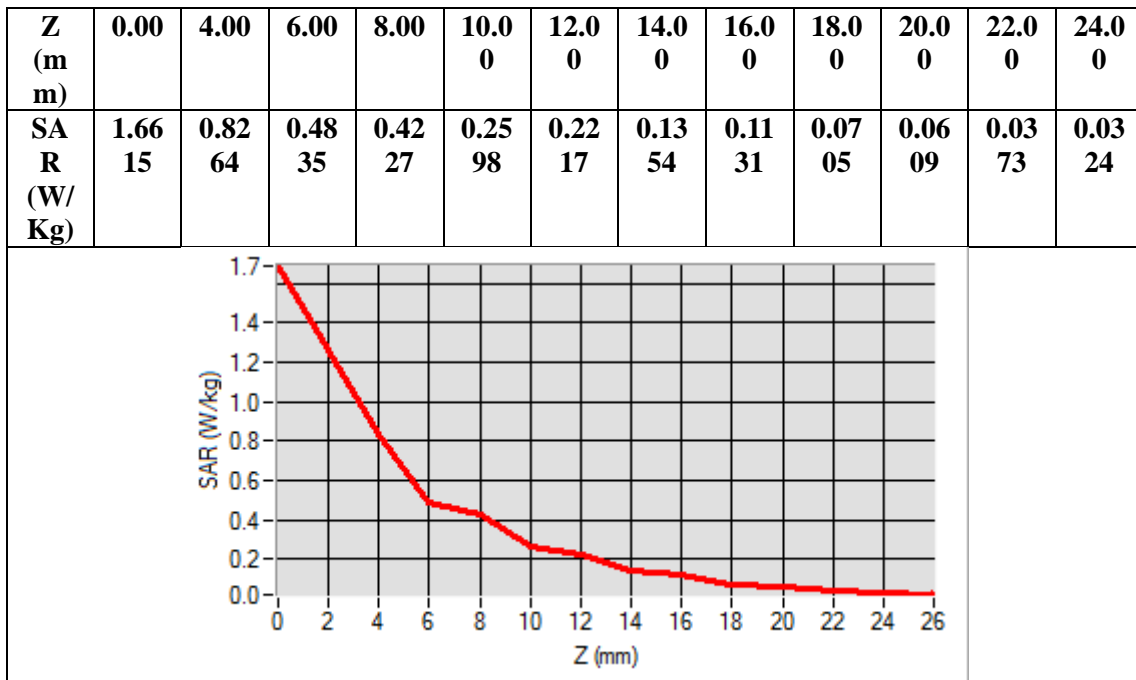

Any report having not been signed by authorized approver, or having been altered without authorization, or having not been stamped by the “Dedicated Testing/Inspection Stamp” is deemed to be invalid. Copying or excerpting portion of, or altering the content of the report is not permitted without the written authorization of AGC. The test results presented in the report apply only to the tested sample. Any objections to report issued by AGC should be submitted to AGC within 15days after the issuance of the test report. Further enquiry of validity or verification of the test report should be addressed to AGC by agc01@agccert.com.

**APPENDIX C. TEST SETUP PHOTOGRAPHS**

Body Back 0mm

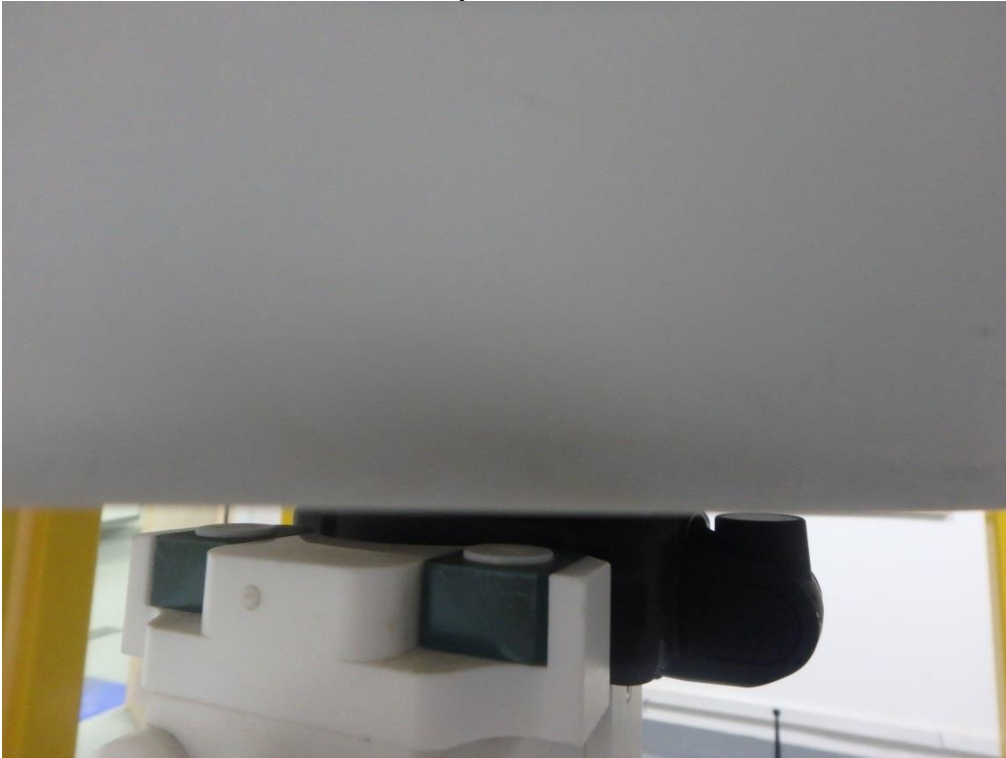

Body Front 0mm

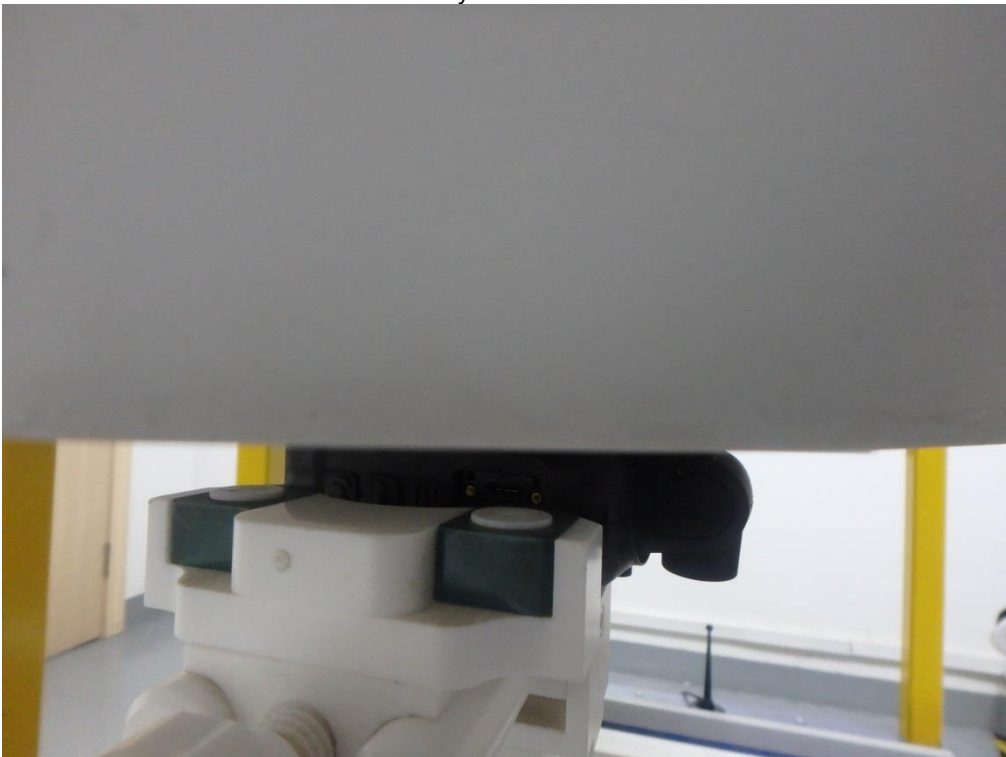

Any report having not been signed by authorized approver, or having been altered without authorization, or having not been stamped by the "Dedicated Testing/Inspection Stamp" is deemed to be invalid. Copying or excerpting portion of, or altering the content of the report is not permitted without the written authorization of AGC. The test results presented in the report apply only to the tested sample. Any objections to report issued by AGC should be submitted to AGC within 15days after the issuance of the test report. Further enquiry of validity or verification of the test report should be addressed to AGC by [agc01@agccert.com](mailto:agc01@agccert.com).

Attestation of Global Compliance(Shenzhen)Co., Ltd

Attestation of Global Compliance(Shenzhen)Std & Tech Co., Ltd

Tel: +86-755 2523 4088 E-mail: [agc@agccert.com](mailto:agc@agccert.com) Web: <http://www.agccert.com/>

Edge 1(Top) 0mm-Hotspot Mode



Edge 2(Right) 0mm-Hotspot Mode



Any report having not been signed by authorized approver, or having been altered without authorization, or having not been stamped by the “Dedicated Testing/Inspection Stamp” is deemed to be invalid. Copying or excerpting portion of, or altering the content of the report is not permitted without the written authorization of AGC. The test results presented in the report apply only to the tested sample. Any objections to report issued by AGC should be submitted to AGC within 15days after the issuance of the test report. Further enquiry of validity or verification of the test report should be addressed to AGC by [agc01@agccert.com](mailto:agc01@agccert.com).

Attestation of Global Compliance(Shenzhen)Co., Ltd

Attestation of Global Compliance(Shenzhen)Std & Tech Co., Ltd

Tel: +86-755 2523 4088 E-mail: [agc@agccert.com](mailto:agc@agccert.com) Web: <http://www.agccert.com/>

Edge 3(Bottom) 0mm-Hotspot Mode



Edge 4(Left) 0mm-Hotspot Mode



Any report having not been signed by authorized approver, or having been altered without authorization, or having not been stamped by the “Dedicated Testing/Inspection Stamp” is deemed to be invalid. Copying or excerpting portion of, or altering the content of the report is not permitted without the written authorization of AGC. The test results presented in the report apply only to the tested sample. Any objections to report issued by AGC should be submitted to AGC within 15days after the issuance of the test report. Further enquiry of validity or verification of the test report should be addressed to AGC by [agc01@agccert.com](mailto:agc01@agccert.com).

### DEPTH OF THE LIQUID IN THE PHANTOM—ZOOM IN

Note : The position used in the measurement were according to IEEE 1528-2013

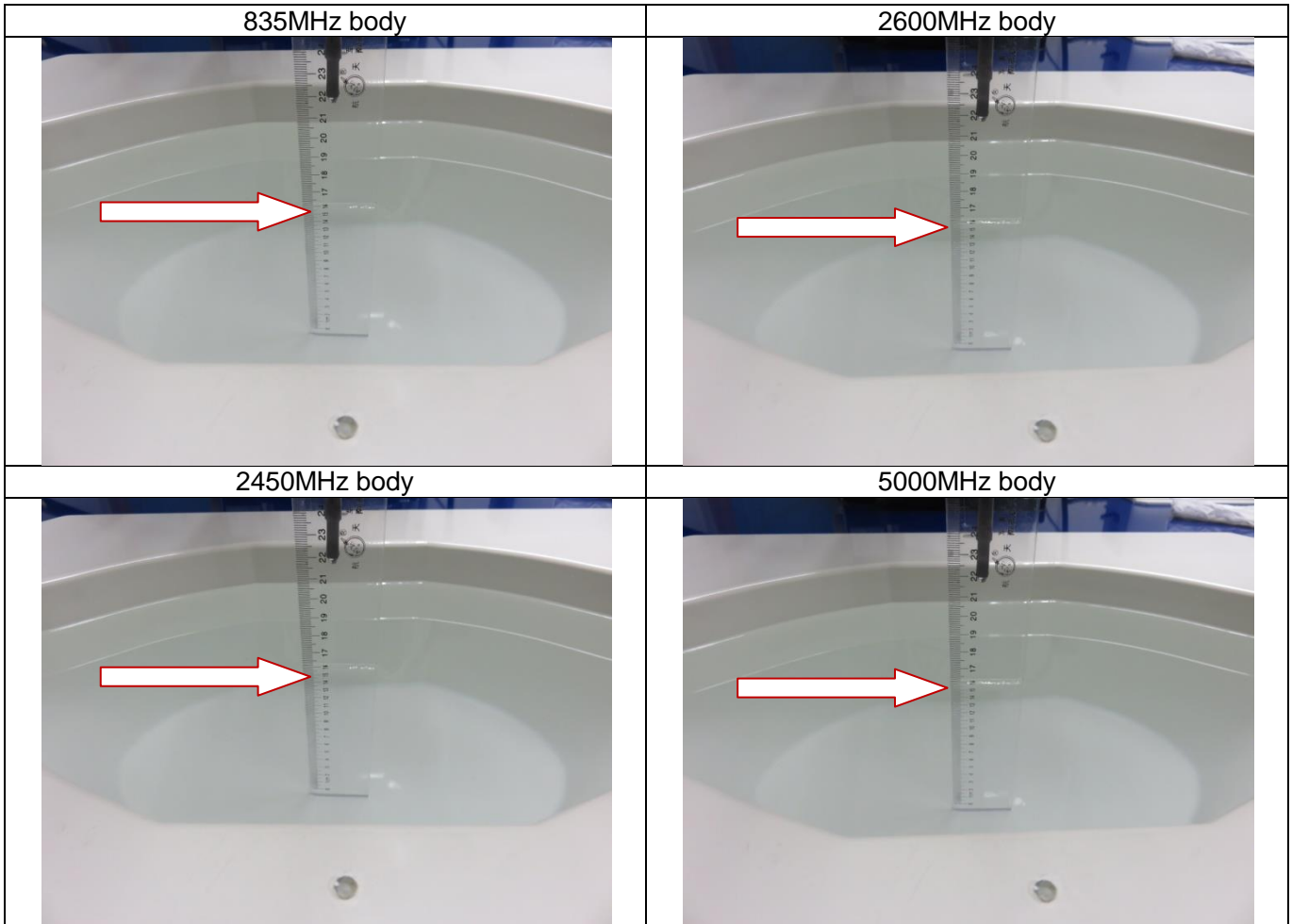

Any report having not been signed by authorized approver, or having been altered without authorization, or having not been stamped by the “Dedicated Testing/Inspection Stamp” is deemed to be invalid. Copying or excerpting portion of, or altering the content of the report is not permitted without the written authorization of AGC. The test results presented in the report apply only to the tested sample. Any objections to report issued by AGC should be submitted to AGC within 15days after the issuance of the test report. Further enquiry of validity or verification of the test report should be addressed to AGC by [agc01@agccert.com](mailto:agc01@agccert.com).

## APPENDIX D. CALIBRATION DATA

Refer to Attached files.

----END OF REPORT----

Any report having not been signed by authorized approver, or having been altered without authorization, or having not been stamped by the “Dedicated Testing/Inspection Stamp” is deemed to be invalid. Copying or excerpting portion of, or altering the content of the report is not permitted without the written authorization of AGC. The test results presented in the report apply only to the tested sample. Any objections to report issued by AGC should be submitted to AGC within 15days after the issuance of the test report. Further enquiry of validity or verification of the test report should be addressed to AGC by [agc01@agccert.com](mailto:agc01@agccert.com).

Attestation of Global Compliance(Shenzhen)Co., Ltd  
Attestation of Global Compliance(Shenzhen)Std & Tech Co., Ltd  
Tel: +86-755 2523 4088 E-mail: [agc@agccert.com](mailto:agc@agccert.com) Web: <http://www.agccert.com/>



## Conditions of Issuance of Test Reports

1. All samples and goods are accepted by the Attestation of Global Compliance (Shenzhen) Co., Ltd. (the “Company”) solely for testing and reporting in accordance with the following terms and conditions. The company provides its services on the basis that such terms and conditions constitute express agreement between the company and any person, firm or company requesting its services (the “Clients”).
2. Any report issued by Company as a result of this application for testing services (the “Report”) shall be issued in confidence to the Clients and the Report will be strictly treated as such by the Company. It may not be reproduced either in its entirety or in part and it may not be used for advertising or other unauthorized purposes without the written consent of the Company. The Clients to whom the Report is issued may, however, show or send it, or a certified copy thereof prepared by the Company to its customer, supplier or other persons directly concerned. The Company will not, without the consent of the Clients, enter into any discussion or correspondence with any third party concerning the contents of the Report, unless required by the relevant governmental authorities, laws or court orders.
3. The Company shall not be called or be liable to be called to give evidence or testimony on the Report in a court of law without its prior written consent, unless required by the relevant governmental authorities, laws or court orders.
4. In the event of the improper use of the report as determined by the Company, the Company reserves the right to withdraw it, and to adopt any other additional remedies which may be appropriate.
5. Samples submitted for testing are accepted on the understanding that the Report issued cannot form the basis of, or be the instrument for, any legal action against the Company.
6. The Company will not be liable for or accept responsibility for any loss or damage however arising from the use of information contained in any of its Reports or in any communication whatsoever about its said tests or investigations.
7. Clients wishing to use the Report in court proceedings or arbitration shall inform the Company to that effect prior to submitting the sample for testing.
8. The Company is not responsible for recalling the electronic version of the original report when any revision is made to them. The Client assumes the responsibility to providing the revised version to any interested party who uses them.
9. Subject to the variable length of retention time for test data and report stored hereinto as otherwise specifically required by individual accreditation authorities, the Company will only keep the supporting test data and information of the test report for a period of six years. The data and information will be disposed of after the aforementioned retention period has elapsed. Under no circumstances shall we provide any data and information which has been disposed of after retention period. Under no circumstances shall we be liable for damage of any kind, including (but not limited to) compensatory damages, lost profits, lost data, or any form of special, incidental, indirect, consequential or punitive damages of any kind, whether based on breach of contract of warranty, tort (including negligence), product liability or otherwise, even if we are informed in advance of the possibility of such damages.

Any report having not been signed by authorized approver, or having been altered without authorization, or having not been stamped by the “Dedicated Testing/Inspection Stamp” is deemed to be invalid. Copying or excerpting portion of, or altering the content of the report is not permitted without the written authorization of AGC. The test results presented in the report apply only to the tested sample. Any objections to report issued by AGC should be submitted to AGC within 15days after the issuance of the test report. Further enquiry of validity or verification of the test report should be addressed to AGC by [agc01@agccert.com](mailto:agc01@agccert.com).