

# W10E10

USER MANUAL

March 2022

**NOTE**

The information in this manual is subject to change without notice.

# Table of Contents

<b>Chapter 1</b>	<b>Getting Started</b>	<b>1</b>
	Getting the Tablet Running	2
	Unpacking	2
	Connecting to AC Power	3
	Turning On and Off the Tablet	4
	Taking a Look at the Tablet	6
	Front Components	6
	Rear Components	8
	Right-Side Components	9
	Left-Side Components	9
	Top Components	10
	Bottom Components	11
	Install TF Card	12
<b>Chapter 2</b>	<b>Operating Your Tablet</b>	<b>14</b>
	Using the Touchscreen	15
	Using Multi-touch Gestures	16
	Using Wireless Connections	18
	Using the WLAN	18
	Using the Bluetooth Feature	19
<b>Chapter 3</b>	<b>Managing Power</b>	<b>20</b>
	AC Adapter	21
	Battery Pack	22
	Charging the Battery Pack	22
	Checking the Battery Level	23
	Low Battery	23

	Replacing the Battery Pack .....	24
	Power-Saving Tips .....	26
<b>Chapter 4</b>	<b>Expanding Your Tablet .....</b>	<b>27</b>
	Connecting Peripheral Devices .....	28
	Connecting a USB Device .....	28
	Connecting a USB Type-C Device .....	28
	Connecting a Monitor .....	28
	Connecting an Audio Device .....	28
<b>Chapter 5</b>	<b>Using BIOS Setup .....</b>	<b>29</b>
	When and How to Use .....	30
	Menu Descriptions .....	31
	Main Menu .....	31
	Security Menu .....	33
	Boot Menu .....	34
	Save & Exit Menu .....	35
<b>Chapter 6</b>	<b>Care and Maintenance .....</b>	<b>36</b>
	Protecting the Tablet .....	37
	Using an Anti-Virus Strategy .....	37
	Taking Care of the Tablet .....	38
	Location Guidelines .....	38
	General Guidelines .....	39
	Cleaning Guidelines .....	39
	Battery Pack Guidelines .....	40
	Touchscreen Guidelines .....	41
	When Traveling .....	42
<b>Chapter 7</b>	<b>Troubleshooting .....</b>	<b>43</b>
	Preliminary Checklist .....	44
	Solving Common Problems .....	45

Battery Problems .....	45
Bluetooth Problems .....	46
Display Problems .....	46
Hardware Device Problems .....	47
Power Management Problems .....	47
Software Problems .....	48
Sound Problems .....	48
Startup Problems .....	48
WLAN Problems .....	49
Restart the Tablet .....	50

# Chapter 1

# Getting Started

This chapter first tells you step by step how to get the tablet up and running. Then, you will find a section briefly introducing the external components of the tablet.

# Getting the Tablet Running

## Unpacking

After unpacking the shipping carton, you should find these standard items:

- I10J Rugged Tablet

- AC power cord



- Battery (Built-in)



- AC adapter



- Carry handle



- Hand-strap



# Connecting to AC Power

**CAUTION :** Use only the AC adapter included with your Tablet. Using other AC adapters may damage the Tablet.

**NOTE :**

- The battery pack is shipped to you in power saving mode that protects it from charging/discharging. It will get out of the mode to be ready for use when you install the battery pack and connect AC power to the Tablet for the very first time.
- When the AC adapter is connected, it also charges the battery pack. For information on using battery power, see Chapter 3.

You must use AC power when starting up the Tablet for the very first time.

1. Open the DC port waterproof plug (Place the tablet flat on the desktop, left position)



2. Plug the DC cord of the AC adapter to the power connector of the Tablet.
3. Plug the female end of the AC power cord to the AC adapter and the male end to an electrical outlet.
4. Power is being supplied from the electrical outlet to the AC adapter and onto your Tablet. Now, you are ready to turn on the Tablet.



# Turning On and Off the Tablet





## Turning On

2. Press the power button (  ). The Windows operating system should start.



## Turning Off

When you finish a working session, you can stop the system by turning off the power or leaving it in Sleep or Hibernation mode:

To...	Do this...
Power off (Shutdown)	Click  → [  Power ] → [Shutdown].
Sleep	Use one of these methods: <ul style="list-style-type: none"><li>• Press the power button.</li><li>• Click  → [  Power ] → [Sleep].</li></ul>
Hibernate	By default, this option is not shown in the Start menu. If you want to use the feature, set up accordingly in Windows settings.

\*“Sleep” is the default result of the action. You can change what the action does through Windows settings.

# Taking a Look at the Tablet

**NOTE :** Depending on the specific model you purchased, the color and look of your model may not exactly match the graphics shown in this document.

**CAUTION :** You need to open the protective covers to access the connectors. When not using a connector, make sure to close the cover completely for water-, and dust-proof integrity. (Engage the locking mechanism if existing.)

## Front Components



Ref	Component	Description
①	<b>Microphone</b>	Receives sound and voice for the Tablet.
②	<b>Stereo Speaker</b>	Sends out sound and voice from the Tablet.
③	<b>Indicators</b>	Up : The power on is always on blue, and the power off light is off . When switching the built-in small battery power supply, it flashes blue.
		Down : (red and green) charging red, full of green. The low battery red light flashes, and the discharge is not on.
④	<b>F Key</b>	2D scan key (can be defined).
⑤	<b>Windows HOME</b>	Used to open windows shortcuts.
⑥	<b>Volume Button +</b>	Used to adjust and increase the volume.
⑦	<b>Volume Button -</b>	Used to adjust or reduce the volume.
⑧	<b>Power Button</b>	Used for sleep wake-up equipment and switching equipment.
⑨	<b>LCD Screen</b>	Displays the output of the Tablet. Include touchscreen feature.

# Rear Components

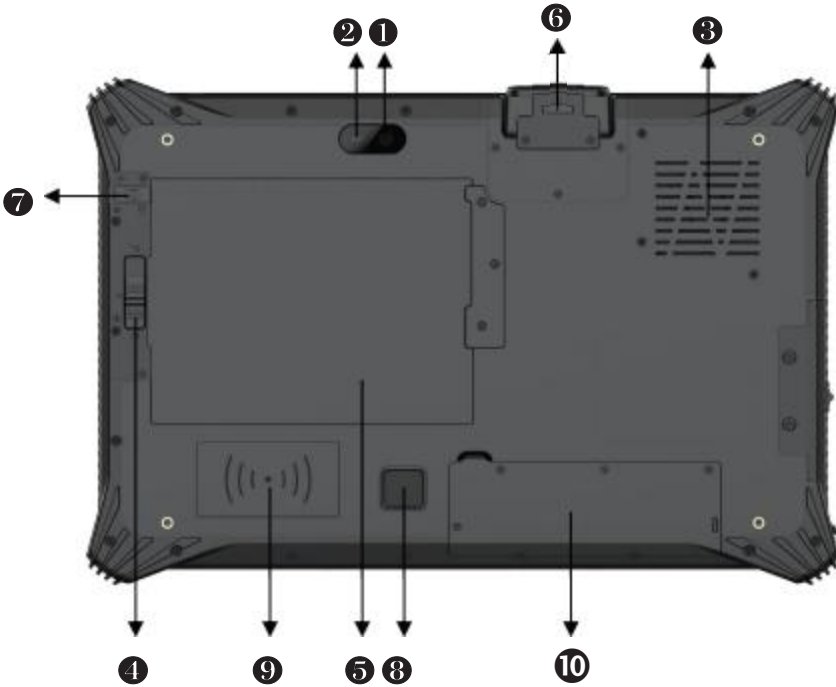

Ref	Component	Description
①	Camera	Used to realize the camera function.
②	Flash Lamp	Fill light and lighting.
③	Cooling Fan	Used for radiating the flat plate (air inlet).
④	Battery Lock	Lock the battery cover.
⑤	Battery	Location of large battery.
⑥	Plastic Top Shell	The scanning head needs to be replaced.

Ref	Component	Description
⑦	Battery Switch Latch	The normal power supply switch is closed, the large battery is changed to the unlocked state, and the latch is restored after replacement.
⑧	Fingerprint	Fingerprint unlock.
⑨	NFC	NFC swipe card.
⑩	SSD	SSD interface location.

## Right-Side Components



## Left-Side Components

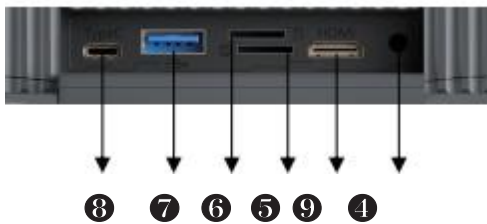

Ref	Component	Description
①	<b>Cooling Fan</b>	Used for radiating the flat plate (air outlet).
②	<b>Interface Protection Cover</b>	Play the role of protective interface, slide to the left to open the protective cover.
③	<b>DC Power Jack</b>	Connect the power adapter.
④	<b>3.5mm Earphone Jack</b>	Connect the audio device.
⑤	<b>TF Card</b>	Installing the TF card, max : 128G.
⑥	<b>USB3.0 Port</b>	Connects a USB device.
⑦	<b>Type-C Port</b>	Connects a USB-C device.
⑧	<b>HDMI Connector</b>	Connects a HDMI monitor or TV set.

## Top Components

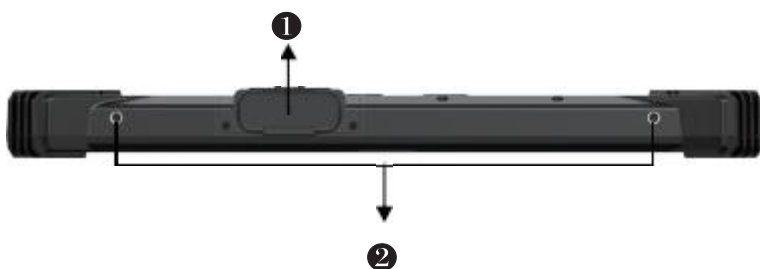

Ref	Component	Description
①	<b>Module Port</b>	Network port (default), serial port, USB, 1D code and 2D code, One out of five.
②	<b>Handle Screw Position</b>	Install M4 handle screw to facilitate the installation of handle.

# Schematic diagram of handle: (the picture is for reference only)



## Bottom Components

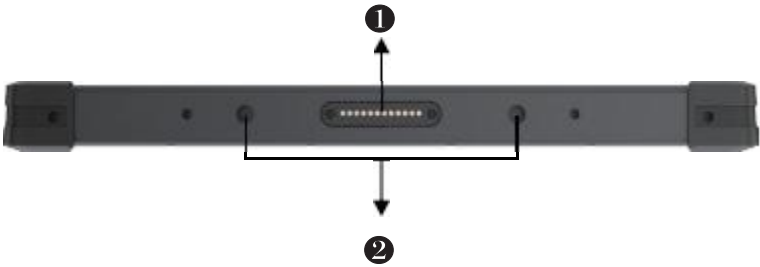

Ref	Component	Description
①	Pogo Pin	Matched with the positioning hole to connect the Vehicle Mount and Docking Charger for expanding USB, RJ45 and RS232 communication interfaces.
②	Locating Hole	It plays a fixed role when connecting the Vehicle Mount and Docking Charger.



# Install SIM card and TF Card

Install TF Card in the following location.



The installation method is shown in the following figure.



**Schematic diagram of Docking Charger: (the picture is for reference only)**



(Front + Docking Charger)



(Back + Docking Charger)

**Schematic diagram of Vehicle Mount: (the picture is for reference only)**



(Front + Vehicle Mount)



(Back + Vehicle Mount)

## Chapter 2

# Operating Your Tablet

This chapter provides information about the use of the Tablet.

If you are new to Tablets, reading this chapter will help you learn the operating basics. If you are already a Tablet user, you may choose to read only the parts containing information unique to your Tablet.

### **CAUTION :**

- Do not expose your skin to the Tablet when operating it in a very hot or cold environment.
- The Tablet can get uncomfortably warm when you use it in high temperatures. As a safety precaution in such a circumstance, do not place the Tablet on your lap or touch it with your bare hands for extended periods of time. Prolonged body contact can cause discomfort and potentially a burn.

# Using the Touchscreen

**CAUTION** : Do not use a sharp object such as a ballpoint pen or pencil on the touchscreen. Doing so may damage the touchscreen surface. Use your finger or the stylus.

Select models have a capacitive touchscreen. This type of touchscreen responds to objects that have conductive properties, such as fingertips and a capacitive-tipped stylus. You can navigate on the screen without using a keyboard, or mouse.



The following table shows how you use the touchscreen to obtain equivalent mouse functions.

Term / Action	Equivalent Mouse Function
<b>Tap</b> : Touch the screen once.	Click / Point
<b>Double-tap</b> : Touch the screen twice rapidly.	Double-click
<b>Tap and hold</b> : Tap and hold until a popup menu appears.	Right-click
<b>Drag</b> : Hold the finger on the screen and drag across the screen until reaching your destination.	Drag

# Using Multi-touch Gestures

You can interact with your Tablet by placing two fingers on the screen. The movement of the fingers across the screen creates “gestures,” which send commands to the Tablet.

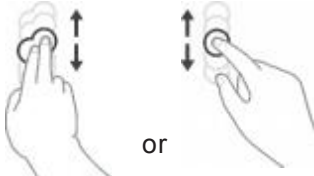
Here are the multi-touch gestures that you can use:

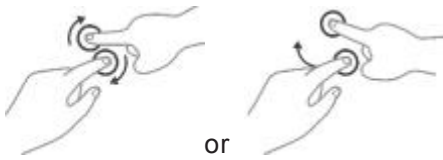
Gestures	Actions ( =finger down ; =finger up)	Descriptions
<b>Pan</b> (Scroll)	 <p>Drag 1 or 2 fingers up or down.</p>	Use panning to see another part of a page that has scroll bars.
<b>Zoom</b> (Pinch)	 <p>Move two fingers apart / toward each other.</p>	Use zooming to make an item (a photo for example) on the screen larger or smaller. The gesture works in applications that support mouse wheel zooming.
<b>Rotate</b>	 <p>Move two fingers in opposing directions. -or- Use one finger to pivot around another.</p>	Use rotating to move a picture or other item on the screen in a circular direction (clockwise or counter-clockwise). The gesture works in applications that support the specific gesture.

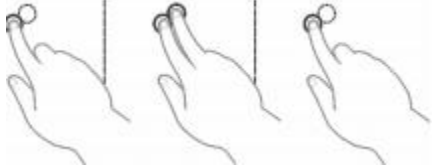
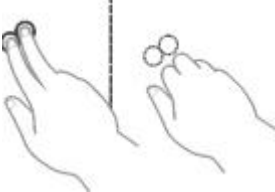
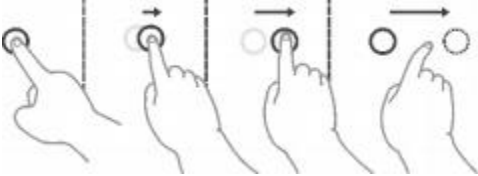
Gestures	Actions ( =finger down ; =finger up)	Descriptions
<p><b>Press and Tap</b></p>	 <p>Press on target and tap using a second finger.</p>	<p>Use press and tap to access the shortcut menu.</p>
<p><b>Two-finger Tap</b></p>	 <p>Tap two fingers at the same time (where the target is in the midpoint between the fingers).</p>	<p>The function is defined by applications that support the specific gesture.</p>
<p><b>Flicks</b></p>	 <p>Make quick drag gestures in the desired direction.</p>	<p>Flick left or right to navigate back and forward in a browser and other applications. The gesture works in most applications that support back and forward.</p>

# Using Wireless Connections

## Using the WLAN

The WLAN (Wireless Local Area Network) module supports WIFI 802.11(a/b/g/n/ac).

### Turning On / Off the WLAN Radio

#### To turn on the WLAN radio:

Click  → [Settings] → [Network & Internet] → [WLAN], Slide the WLAN switch to the [On] position.

#### To turn off the WLAN radio:

You can turn off the WLAN radio the same way you turn it on.

If you want to quickly turn off all wireless radio, simply switch on Airplane mode.

Click  → [Settings] → [Network & Internet] → [Airplane mode], Slide the Airplane Mode switch to the [On] position.

### Connecting to a WLAN Network

1. Make sure that the WLAN function is enabled (as described above).
2. Click the network icon  in the lower right of the task bar.
3. In the list of available wireless networks, click a network, and then click Connect.
4. Some networks require a network security key or passphrase. To connect to one of those networks, ask your network administrator or Internet service provider (ISP) for the security key or passphrase.

For more information on setting a wireless network connection, refer to Windows online help.

# Using the Bluetooth Feature

The Bluetooth technology allows short-range wireless communications between devices without requiring a cable connection. Data can be transmitted through walls, pockets and briefcases as long as two devices are within range.

## Turning On / Off the Bluetooth Radio

### To turn on the Bluetooth radio:

Click  → [Settings] → [Devices] → [Bluetooth], Slide the Bluetooth switch to the [On] position.

### To turn off the Bluetooth radio:

You can turn off the Bluetooth radio the same way you turn it on.

If you want to quickly turn off all wireless radio, simply switch on Airplane mode.

## Connecting to another Bluetooth Device

1. Make sure that the Bluetooth function is enabled (as described above).
2. Make sure that the target Bluetooth device is turned on, discoverable and within close range. (See the documentation that came with the Bluetooth device.)
3. Click  → [Settings] → [Devices] → [Bluetooth].
4. Select the device you want to connect from the search results.
5. Depending on the type of Bluetooth device that you want to connect to, you will need to enter the pertinent information.

For detailed information on using the Bluetooth feature, see Windows' online Help.



## Chapter 3

# Managing Power

Your Tablet operates either on external AC power or on internal battery power.

This chapter tells you how you can effectively manage power. To maintain optimal battery performance, it is important that you use the battery in the proper way.

# AC Adapter

## CAUTION :

- The AC adapter is designed for use with your Tablet only. Connecting the AC adapter to another device can damage the adapter.
- The AC power cord supplied with your Tablet is for use in the country where you purchased your Tablet. If you plan to go overseas with the Tablet, consult your dealer for the appropriate power cord.
- When you disconnect the AC adapter, disconnect from the electrical outlet first and then from the Tablet. A reverse procedure may damage the AC adapter or Tablet.
- When unplugging the connector, always hold the plug head. Never pull on the cord.

The AC adapter serves as a converter from AC (Alternating Current) to DC (Direct Current) power because your Tablet runs on DC power, but an electrical outlet usually provides AC power. It also charges the battery pack when connected to AC power.

The adapter operates on any voltage in the range of 100~240V AC.

# Battery Pack

The battery pack is the internal power source for the Tablet. It is rechargeable using the AC adapter.

**CAUTION** : The time to unplug the battery pack is limited to when the battery is not being charged.

**NOTE** : Care and maintenance information for the battery is provided in the “Battery Pack Guidelines” section in Chapter 7.

## Charging the Battery Pack

**NOTE** : The rechargeable temperature of the battery is between 0°C and 50°C.

To charge the battery pack, connect the AC adapter to the Tablet and an electrical outlet. The Battery Indicator (  ) on the Tablet glows red to indicate that charging is in progress. When the battery is fully charged, the Battery Indicator lights green.

**CAUTION** : After the Tablet has been fully recharged, do not immediately disconnect and reconnect the AC adapter to charge it again. Doing so may damage the battery.

# Checking the Battery Level

**NOTE** : Any battery level indication is an estimated result. The actual operating time can be different from the estimated time, depending on how you are using the Tablet.

When the battery is fully charged, its power supply time depends on how you use the Tablet. If the software you use requires frequent use of peripheral devices, the power may run out soon.

You can find the battery icon on the Windows taskbar (lower-right corner). The icon shows the approximate battery level.

## Battery Low Signals and Actions

When the battery is low, please connect the adapter immediately, put the Tablet into hibernation, or turn off the Tablet's power.

# Replacing the Battery Pack

## CAUTION :

- There is danger of explosion if the battery is incorrectly replaced. Replace the battery only with the Tablet manufacturer' soptional battery packs. Discard used batteries according to the dealer' sinstructions.
- Do not attempt to disassemble the battery pack.
- The battery pack will become hot under long-term operation. Do not touch the hot battery pack with bare hands. After removing the battery pack, place it in a ventilated place.

**NOTE :** This model has two large and small batteries, which can be hot swapped to replace the external large battery.

1. Carefully place the Tablet upside down.
2. Turn the small battery switch to the unlocking position (at this time, the small battery is powered, and the front blue light flashes).
3. Turn the large battery switch to the unlock button, and the battery can be taken out at this time.

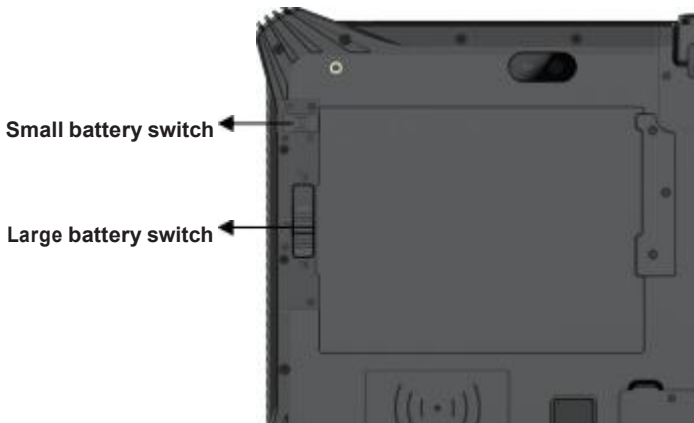

4. After installing the large battery, lock the battery lock switch and turn the small battery switch to the locked state.



# Power-Saving Tips

Aside from enabling your Tablet's power saving mode, you can do your part to maximize the battery's operating time by following these suggestions.

- Do not disable Power Management.
- Decrease the LCD brightness to the lowest comfortable level.
- Shorten the length of time before Windows turn off the display.
- When not using a connected device, disconnect it.
- Turn off the wireless radio if you are not using the wireless module (such as WLAN or Bluetooth).
- Turn off the Tablet when you are not using it.

## Chapter 4

# Expanding Your Tablet

You can expand the capabilities of your Tablet by connecting other peripheral devices.

When using a device, be sure to read the instructions accompanying the device together with the relevant section in this chapter.



# Connecting Peripheral Devices

## Connecting a USB Device

Your Tablet has one USB 3.0 ports for connecting USB devices, such as a digital camera, scanner, printer, modem, and mouse.

## Connecting a USB Type-C Device

Your Tablet has a USB Type-C port. This port supports:

- USB Type-C (or just USB-C) port
- DisplayPort
- USB Power Delivery (power transmission)

Be sure to use the correct specification USB-C power adapter with your Tablet model.

## Connecting a Monitor

Your Tablet supports HDMI and DisplayPort connectors. Please connect the monitor to the corresponding interface according to the specifications.

## Connecting an Audio Device

Your Tablet is equipped with a composite audio port, which is 3.5mm in size, which can be connected to a compatible headset microphone.

**SAFETY WARNING :** 

To prevent possible hearing damage, do not listen at high volume levels for long period.

## Chapter 5

# Using BIOS Setup

BIOS Setup Utility is a program for configuring the BIOS (Basic Input / Output System) settings of the Tablet. BIOS is a layer of software, called firmware, that translates instructions from other layers of software into instructions that the Tablet hardware can understand. The BIOS settings are needed by your Tablet to identify the types of installed devices and establish special features.

This chapter tells you how to use the BIOS Setup Utility.

# When and How to Use

You need to run BIOS Setup Utility when:

- You see an error message on the screen requesting you to run BIOS Setup Utility.
- You want to restore the factory default BIOS settings.
- You want to modify some specific settings according to the hardware.
- You want to modify some specific settings to optimize the system performance.

To run BIOS Setup Utility:

1. Click  → **[Settings]** → **[Update & security]** → **[Recovery]**. Under Advanced startup, click Restart now. In the boot options menu, click **[Troubleshoot]** → **[Advanced options]** → **[UEFI Firmware Settings]**. Click Restart.
2. In general, you can use the external keyboard, use the arrow keys to move around and + / – keys to change the setup values. Keyboard information can be found at the bottom of the screen.

## NOTE :

- The actual setting items on your model may differ from those described in this chapter.
- The availability of some setting items depends on the Windows version your Tablet is running.

# Menu Descriptions

## Main Menu

The Main menu contains the various system settings.

- **Build Date and Time** (BIOS version date) : Record the Tablet bios version.
- **Serial number** (SN) : Record Tablet factory code.

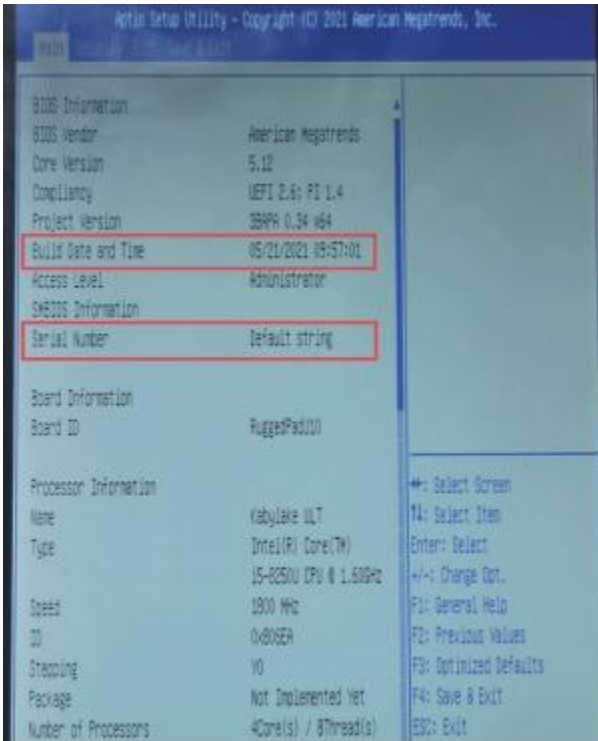

- **EC FM Version** : Record EC firmware information.
- **System Language** : Setsystem language.
- **System Date** : Sets the system date.
- **System Time** : Sets the system time.

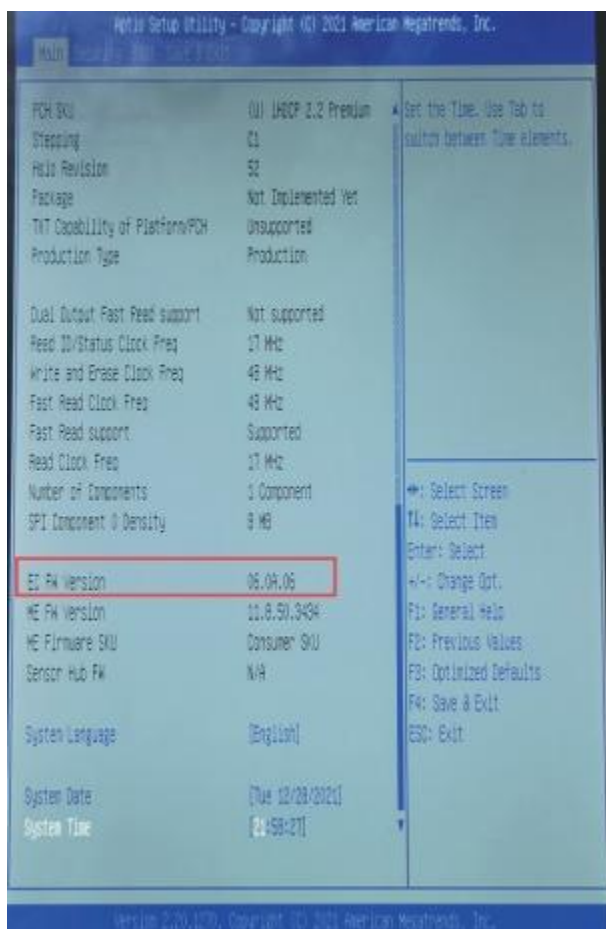

# Security Menu

The Security menu contains the security settings, which safeguard your system against unauthorized use.

## Note :

- You can set the user password only when the supervisor password has been set.
- If both the administrator and user passwords are set, you can enter any of them for starting up the system and/or entering BIOS Setup. However, the user password only allows you to view/change the settings of certain items.
- A password setting is applied right after it is confirmed. To cancel a password, leave the password empty by pressing the Enter key.
- **Set Administrator / User Password** : Sets the supervisor/user password. You can set the supervisor / user password to be required for starting up the system and / or entering BIOS Setup.
- **Secure Boot** : Set up the safe boot function. This item can only be used after the supervisor password is set. (Secure Boot secure boot function can prevent unauthorized firmware, operating system, or UEFI driver from running during boot.)

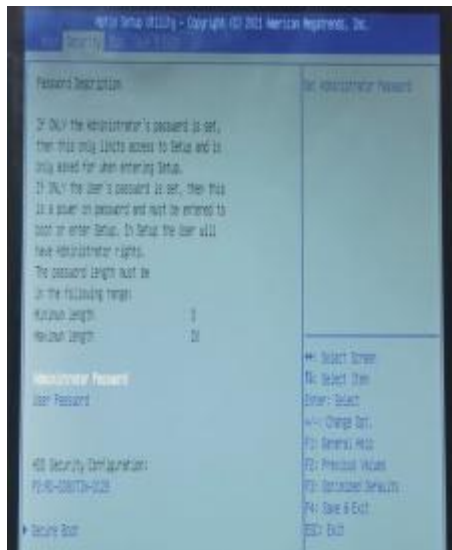

# Boot Menu

The Boot menu sets the sequence of the devices to be searched for the operating system.

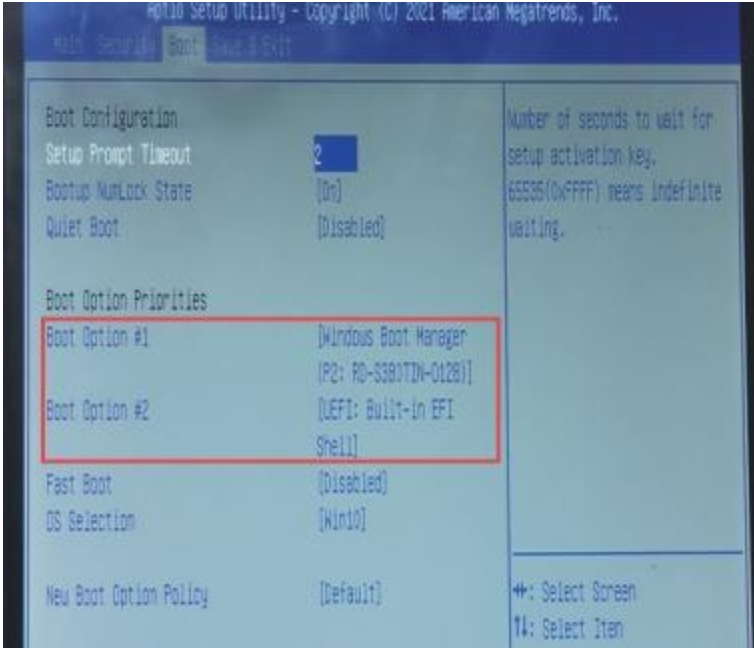

# Save & Exit Menu

The Save & Exit menu displays ways of exiting BIOS Setup Utility. After finishing with your settings, you must save and exit so that the changes can take effect.

- **Save Changes and Exit** : Saves the changes you have made and exits BIOS Setup Utility.
- **Discard Changes and Exit** : Exits BIOS Setup Utility without saving the changes you have made.
- **Save Changes and Reset** : Saves the changes you have made and restart the device.
- **Discard Changes and Reset** : Restart the Tablet without saving the changes you have made.
- **Restore Default** : Load the factory default values of all items.
- **Save as User Defaults** : Save user default settings.
- **Restore User Defaults** : Load factory default values for all items.
- **Saves Changes** : Save the changes you have made.
- **Discard Changes** : All items are restored to their original values.



## Chapter 6

# Care and Maintenance

Taking good care of your Tablet will ensure a trouble-free operation and reduce the risk of damage to your Tablet.

This chapter gives you guidelines covering areas such as protecting, storing, cleaning, and traveling.

# Protecting the Tablet

To safeguard the integrity of your Tablet data as well as the Tablet itself, you can protect the Tablet in several ways as described in this section.

## Using an Anti-Virus Strategy

You can install a virus-detecting program to monitor potential viruses that could damage your files.

# Taking Care of the Tablet

## Location Guidelines

- For optimal performance, use the Tablet where the recommended temperature is between 0 °C and 40 °C . (Actual operating temperature depends on product specifications.)
- Avoid placing the Tablet in a location subject to high humidity, extreme temperatures, mechanical vibration, direct sunlight, or heavy dust. Using the Tablet in extreme environments for long periods can result in product deterioration and a shortened product life.
- Operating in an environment with metallic dust is not allowed.
- Place the Tablet on a flat and steady surface. Do not stand the Tablet on its side or store it in an upside-down position. A strong impact by dropping or hitting may damage the Tablet.
- Do not cover or block any ventilation openings on the Tablet. For example, do not place the Tablet on a bed, sofa, rug, or other similar surface. Otherwise, overheating may occur that results in damage to the Tablet.
- As the Tablet can become very hot during operation, keep it away from objects that are vulnerable to heat.
- Keep the Tablet at least 13 cm (5 inches) away from electrical appliances that can generate a strong magnetic field such as a TV, refrigerator, motor, or a large audio speaker.
- Avoid moving the Tablet abruptly from a cold to a warm place. A temperature difference of more than 10 °C (18 °F) may cause condensation inside the unit, which may damage the storage media.

# General Guidelines

- Do not place heavy objects on top of the Tablet when it is closed as this may damage the display.
- To avoid damaging the screen, do not touch it with any sharp object.
- LCD image sticking occurs when a fixed pattern is displayed on the screen for a prolonged period of time. You can avoid the problem by limiting the amount of static content on the display. It is recommended that you use a screen saver or turn off the display when it is not in use.
- To maximize the life of the backlight in the display, allow the backlight to automatically turn off as a result of power management.

# Cleaning Guidelines

- Never clean the Tablet with its power on.
- Use a soft cloth moistened with water or a non-alkaline detergent to wipe the exterior of the Tablet.
- Gently wipe the display with a soft, lint-free cloth.
- If water or liquid is spilled onto the Tablet, wipe it dry and clean when possible. Though your Tablet is water-proof, do not leave the Tablet wet when you can dry it.
- If the Tablet gets wet where the temperature is 0°C (32°F) or below, freeze damage may occur. Make sure to dry the wet Tablet.

# Battery Pack Guidelines

• The battery pack is a consumable product and the following conditions will shorten its life:

– when frequently charging the battery pack.

– when using, charging, or storing in high temperature condition.

• To avoid hastening the deterioration of the battery pack thereby prolonging its useful life, minimize the number of times you charge it so as not to frequently increase its internal temperature.

• Charge the battery pack between 10 °C ~ 30 °C (50 °F ~ 86 °F) temperature range. A higher environment temperature will cause the battery pack' s temperature to rise. Avoid charging the battery pack inside a closed vehicle and in hot weather condition. Also, charging will not start if the battery pack is not within the allowed temperature range.

• It is recommended that you do not charge the battery pack more than once a day.

• It is recommended that you charge the battery pack with the Tablet' s power off .

• To maintain the battery pack' s operating efficiency, store it in a cool dark place removed from the Tablet and with 30 % ~ 40 % charge remaining.

• Important guidelines when using the battery pack. When installing or removing the battery pack take note of the following:

– avoid installing or removing the battery pack when the Tablet is in Sleep mode.

Abruptly removing the battery pack may cause loss of data or the Tablet may become unstable.

– avoid touching the battery pack terminals or damage may occur, thereby causing improper operation to it or the Tablet.

The Tablet's input voltage and surrounding temperature will directly affect the battery pack's charge and discharge time:

– charging time will be prolonged when the Tablet is turned on.

To shorten the charging time, it is recommended that you place the Tablet in sleep or hibernation mode.

– a low temperature will prolong the charging time as well as hasten the discharge time.

• When using battery power in an extremely low temperature environment, you may experience shortened operating time and incorrect battery level reading. This phenomenon comes from the chemical characteristics of batteries.

• Do not leave the battery pack in storage for more than six months without recharging it.

## Touchscreen Guidelines

• Use the finger or stylus on the display. Using a sharp or metallic object other than your finger or stylus may cause scratches and damage the display, thereby causing errors.

• Use a soft cloth to remove dirt on the display. The touchscreen surface has a special protective coating that prevents dirt from sticking to it. Not using a soft cloth may cause damage to the special protective coating on the touchscreen surface.

• Turn off the Tablet power when cleaning the display. Cleaning the display with the power on may cause improper operation.

• Do not use excessive force on the display. Avoid placing objects on top of the display as this may cause the glass to break thereby damaging the display.

• In low and high temperatures the touchscreen may have a slower response time or register the touch in the wrong location. It will go back to normal after returning to room temperature.

# When Traveling

- Make sure that the battery pack is fully charged.
- Make sure that the Tablet is turned off .
- Make sure that all the connector covers are closed completely to ensure the waterproof integrity.
- Disconnect the AC adapter from the Tablet and take it with you. Use the AC adapter as the power source and as a battery-charger.
- Hand-carry the Tablet. Do not check it in as luggage.
- If you need to leave the Tablet in the car, put it in the trunk of the car to avoid exposing the Tablet to excessive heat.
- When going through airport security, it is recommended that you send the Tablet and flash disks through the X-ray machine (the device you set your bags on). Avoid the magnetic detector (the device you walk through) or the magnetic wand (the handheld device used by security personnel).
- If you plan to travel abroad with your Tablet, consult your dealer for the appropriate AC power cord for use in your country of destination.

## Chapter 7

# Troubleshooting

Tablet problems can be caused by hardware, software, or both. When you encounter any problem, it might be a typical problem that can easily be solved.

This chapter tells you what actions to take when solving common Tablet problems.



# Preliminary Checklist

Here are helpful hints to follow before you take further actions when you encounter any problem:

- Try to isolate which part of the Tablet is causing the problem.
- Make sure that you turn on all peripheral devices before turning on the Tablet.
- If an external device has a problem, make sure that the cable connections are correct and secure.
- Make sure that the configuration information is properly set in the BIOS Setup program.
- Make sure that all the device drivers are correctly installed.
- Make notes of your observations. Are there any messages on the screen? Do any indicators light? Do you hear any beeps? Detailed descriptions are useful to the service personnel when you need to consult one for assistance.

If any problem persists after you follow the instructions in this chapter, contact an authorized dealer for help.

# Solving Common Problems

## Battery Problems

**The battery does not charge (The battery indicator is flashing red) .**

- Make sure that the AC adapter is properly connected.
- Make sure that the battery is not too hot or cold. Allow time for the battery pack to return to room temperature.
- If the battery doesn't charge after it has been stored in very low temperatures, try disconnecting and reconnecting the AC adapter to solve the problem.
- Make sure that the battery pack is installed correctly.
- Make sure that the battery terminals are clean.

**The operating time of a fully charged battery becomes shorter.**

- If you often partially recharge and discharge, the battery might not be charged to its full potential. Initialize the battery to solve the problem. (Fully charge in the shutdown state, discharge to 0%, and then fully charge the shutdown, cycle 2-3 times).

**The battery operating time indicated by the battery meter does not match the actual operating time.**

- The actual operating time can be different from the estimated time, depending on how you are using the Tablet. If the actual operating time is much less than the estimated time, initialize the battery.

# Bluetooth Problems

## **I cannot connect to another Bluetooth-enabled device.**

- Make sure that both devices have activated Bluetooth feature.
- Make sure that the distance between the two devices is within the limit and that there are no walls or other obstructions between the devices.
- Make sure that the other device is not in “Hidden ” mode.
- Make sure that both devices are compatible.

# Display Problems

## **Nothing appears on the screen.**

- automatically turn off as a result of power management. Press any key to see if the screen comes back.
- The brightness level might be too low. Increase brightness.
- The screen output may be switched to an external device. Please switch the display via Windows [**Control Panel**].

## **The characters on the screen are dim.**

- Adjust the brightness and / or contrast.

## **Bad dots appear on the display at all times.**

- A small number of missing, discolored, or bright dots on the screen are an intrinsic characteristic of TFT LCD technology. It is not regarded as a LCD defect.

# Hardware Device Problems

## **The Tablet does not recognize a newly installed device.**

- Make sure if any device driver needs to be installed. (Refer to the documentation that came with the device.)
- The device may not be correctly configured in the BIOS Setup program. Run the BIOS Setup program to identify the new type.
- Check the cables or power cords for correct connections.
- For an external device that has its own power switch, make sure that the power is turned on.

# Power Management Problems

## **The Tablet does not enter Sleep or Hibernation mode automatically.**

- If you have a connection to another Tablet, the Tablet does not enter Sleep or Hibernation mode if the connection is actively in use.
- Make sure that the Sleep or Hibernation time-out is enabled.

## **The Tablet does not enter Sleep or Hibernation mode immediately.**

- If the Tablet is performing an operation, it normally waits for the operation to finish.

## **The Tablet does not resume from Sleep or Hibernation mode.**

- The Tablet automatically enters Sleep or Hibernation mode when the battery pack is empty. Do any one of the following:
  - Connect the AC adapter to the Tablet.
  - Replace the empty battery pack with a fully charged one.

# Software Problems

**An application program does not work correctly.**

- Make sure that the software is correctly installed.
- If an error message appears on the screen, consult the software program's documentation for further information.
- If you are sure the operation has stop, reset the Tablet.

# Sound Problems

**No sound is produced.**

- Make sure that the volume control is not set too low.
- Make sure that the Tablet is not in mute mode.
- Make sure that the Tablet is not in Sleep mode.
- If using an external speaker, make sure that the speaker is properly connected.

**Distorted sound is produced.**

- Make sure that the volume control is not set too high or too low. In most cases, a high setting can cause the audio electronics to distort the sound.

# Startup Problems

**When you turn on the Tablet, it does not seem to respond.**

- If you are using an external AC power, make sure that the AC adapter is correctly and securely connected. If so, make sure that the electrical outlet works properly.
- If you are using the battery power, make sure that the battery is not discharged.

# WLAN Problems

## **I cannot use the WLAN feature.**

- Make sure that the WLAN feature is turned on.

## **Transmission quality is poor.**

- Your Tablet may be in an out-of-range situation. Move your Tablet closer to the Access Point or another WLAN device it is associated with.
- Check if there is high interference around the environment and solve the problem as described next.

## **Radio interference exists.**

- Move your Tablet away from the device causing the radio interference such as microwave oven and large metal objects.
- Plug your Tablet into an outlet on a different branch circuit from that used by the affecting device.
- Consult your dealer or an experienced radio technician for help.

## **I cannot connect to another WLAN device.**

- Make sure that the WLAN feature is turned on.
- Make sure that the SSID setting is the same for every WLAN device in the network.
- Your Tablet is not recognizing changes. Restart the Tablet.
- Make sure that the IP address or subnet mask setting is correct.

## **I cannot access the network.**

- Make sure that the network configuration is appropriate.
- Make sure that the user name or password is correct.
- You have moved out of range of the network.

# Restart the Tablet

When the Tablet crashes due to a problem, you may need to restart the Tablet.

If you are sure that the Tablet has crashed and you cannot use the reboot function provided by the operating system, please reboot in one of the following ways:

- Press **Ctrl + Alt + Del** on the keyboard to bring up the **Ctrl-Alt-Del** screen. This screen provides several operation options including "Restart".
- If the above method does not work, press and hold the power button for more than 5 seconds to force the Tablet to shut down. Then turn it on again.

## **Use warnings:**

### **Rugged Tablet**

**Model Number: W10E10**

**FCC ID: 2AKP7W10E10**

### **Made In China**

Adapter description:

INPUT: 100-240VAC,50/60HZ,1.5A MAX OUTPUT:19VDC,3.42A

This device complies with part 15 of the FCC Rules. Operation is subject to the following two conditions:

(1) this device may not cause harmful interference, and (2) this device must accept any interference

received, including interference that may cause undesired operation.

Any changes or modifications not expressly approved by the party responsible for compliance

could void the user's authority to operate the equipment.

NOTE: This equipment has been tested and found to comply with the limits for a Class B digital device,

pursuant to Part 15 of the FCC Rules. These limits are designed to provide reasonable protection against

harmful interference in a residential installation. This equipment generates, uses and can radiate radio

frequency energy and, if not installed and used in accordance with the instructions, may cause harmful

interference to radio communications. However, there is no guarantee that interference will not occur in a

particular installation.

If this equipment does cause harmful interference to radio or television reception,

which can be determined by turning the equipment off and on, the user is encouraged to try to correct the

interference by one or more of the following measures:

- Reorient or relocate the receiving antenna.
- Increase the separation between the equipment and receiver.
- Connect the equipment into an outlet on a circuit different



from that to which the receiver is connected.

-- Consult the dealer or an experienced radio/TV technician for help.  
The device has been evaluated to meet general RF exposure requirement. The device can be used in portable exposure condition without restriction.

Specific Absorption Rate (SAR) information:

- This radio is designed for and classified as “General population/uncontrolled Use” , the guidelines are based on standards that were developed by independent scientific organizations through periodic and thorough evaluation of scientific studies. The standards include a substantial safety margin designed to assure the safety of all persons regardless of age or health. The exposure standard for wireless radio employs a unit of measurement known as the Specific Absorption Rate, or SAR, the SAR limit set 1.6W/kg.
- Body-worn operation; this device was tested for typical body-worn operations with the back of the tablet kept 0mm for body worn. To maintain compliance with RF exposure requirements, use accessories that maintain a 0mm for body worn. The use of belt clips, holsters and similar accessories should not contain metallic components in its assembly. The use of accessories that do not satisfy these requirements may not comply with RF exposure requirements, and should be avoided.

The highest reported SAR value for worn on the body is 0.472 W/kg.