

# FCC RADIO TEST REPORT

## FCC ID: 2AKDT-MNP1095

**Product:** Magic Note Pad

**Trade Mark:** XPPen

**Model No.:** MNP1095

**Family Model:** MNP1091, MNP1092, MNP1093

**Report No.:** S24110802911004

**Issue Date:** Dec. 23, 2024

### Prepared for

XPPEN Technology CO.

15350 Fairfield Ranch Road, Chino Hills, CA, 91709, US

### Prepared by

Shenzhen NTEK Testing Technology Co., Ltd.

No. 24 Xinfu East Road, Xiangshan Community, Xinqiao Street,  
Baoan District, Shenzhen, Guangdong, People's Republic of China

Tel. 0755-2320 0050 Website: <http://www.ntek.org.cn>

TEST RESULT CERTIFICATION

Applicant's name : XPPEN Technology CO.
Address : 15350 Fairfield Ranch Road, Chino Hills, CA, 91709, US
Manufacturer's Name : Hanvon Ugee Technology Co., Ltd.
Address : 2/F, West of 3/F, 4/F, No.4 Building, Fulongte Industrial Park, Huaxing Road, Langkou Community, Dalang Street, Longhua District, Shenzhen, China

Product description

Product name : Magic Note Pad
Trade Mark : XPPen
Model and/or type reference : MNP1095
Family Model : MNP1091, MNP1092, MNP1093
Test Sample Number : S241108029012

Standards : FCC Part15.407
ANSI C63.10-2013
Test procedure : KDB 789033 D02 General UNII Test Procedures New Rules v02r01
KDB 905462 D03 Client Without DFS New Rules v01r02
KDB 905462 D02 UNII DFS Compliance Procedures New Rules v02

This device described above has been tested by NTEK, and the test results show that the equipment under test (EUT) is in compliance with the FCC requirements. And it is applicable only to the tested sample identified in the report.

This report shall not be reproduced except in full, without the written approval of NTEK, this document may be altered or revised by NTEK, personnel only, and shall be noted in the revision of the document.

Date of Test :
Date (s) of performance of tests : Nov. 10, 2024 ~ Dec. 23, 2024
Date of Issue : Dec. 23, 2024
Test Result : Pass

Prepared By : Kieron Luo (Project Engineer)

Reviewed By : Aaron Cheng (Supervisor)

Approved By : Alex Li (Manager)

**Table of Contents**

	<b>Page</b>
<b>1. SUMMARY OF TEST RESULTS</b>	<b>7</b>
1.1 FACILITIES AND ACCREDITATIONS	8
1.2 MEASUREMENT UNCERTAINTY	8
<b>1 . GENERAL INFORMATION</b>	<b>9</b>
1.1 GENERAL DESCRIPTION OF EUT	9
1.2 DESCRIPTION OF TEST MODES	11
1.3 BLOCK DIGRAM SHOWING THE CONFIGURATION OF SYSTEM TESTED	12
1.4 DESCRIPTION OF SUPPORT UNITS(CONDUCTED MODE)	13
1.5 EQUIPMENTS LIST FOR ALL TEST ITEMS	14
<b>2 . EMC EMISSION TEST</b>	<b>16</b>
2.1 CONDUCTED EMISSION MEASUREMENT	16
2.1.1 APPLICABLE STANDARD	16
2.1.2 CONFORMANCE LIMIT	16
2.1.3 TEST CONFIGURATION	16
2.1.4 TEST PROCEDURE	16
2.2 RADIATED EMISSION MEASUREMENT	19
2.2.1 APPLICABLE STANDARD	19
2.2.2 CONFORMANCE LIMIT	19
2.2.3 MEASURING INSTRUMENTS	19
2.2.4 TEST CONFIGURATION	20
2.2.5 TEST PROCEDURE	21
2.2.6 TEST RESULTS (9KHZ – 30 MHZ)	22
2.2.7 TEST RESULTS (30MHZ – 1GHZ)	23
2.2.8 TEST RESULTS (1GHZ-18GHZ)	25
2.2.10 TEST RESULTS (18GHZ-40GHZ)	29
<b>3 . POWER SPECTRAL DENSITY TEST</b>	<b>40</b>
3.1 APPLIED PROCEDURES / LIMIT	40
3.2 TEST PROCEDURE	41
3.3 DEVIATION FROM STANDARD	41
3.4 TEST SETUP	41
3.5 EUT OPERATION CONDITIONS	41
3.6 TEST RESULTS	42
<b>4 . 26DB &amp; 99% EMISSION BANDWIDTH</b>	<b>43</b>
4.1 APPLIED PROCEDURES / LIMIT	43
4.2 TEST PROCEDURE	43
4.3 EUT OPERATION CONDITIONS	44
4.4 TEST RESULTS	44

**Table of Contents**

	<b>Page</b>
<b>5 . MINIMUM 6 DB BANDWIDTH</b>	<b>45</b>
5.1 APPLIED PROCEDURES / LIMIT	45
5.2 TEST PROCEDURE	45
5.3 DEVIATION FROM STANDARD	45
5.4 TEST SETUP	45
5.5 EUT OPERATION CONDITIONS	45
5.6 TEST RESULTS	46
<b>6 . MAXIMUM CONDUCTED OUTPUT POWER</b>	<b>47</b>
6.1 PPLIED PROCEDURES / LIMIT	47
6.2 TEST RESULTS	49
<b>7 . OUT OF BAND EMISSIONS</b>	<b>50</b>
7.1 APPLICABLE STANDARD	50
7.2 TEST PROCEDURE	50
7.3 DEVIATION FROM STANDARD	51
7.4 TEST SETUP	51
7.5 EUT OPERATION CONDITIONS	51
7.6 TEST RESULTS	52
<b>8. FREQUENCY STABILITY MEASUREMENT</b>	<b>53</b>
8.1 LIMIT	53
8.2 TEST PROCEDURES	53
8.3 TEST SETUP LAYOUT	53
8.4 EUT OPERATION DURING TEST	53
8.5 TEST RESULTS	54
<b>9. DYNAMIC FREQUENCY SELECTION(DFS)</b>	<b>66</b>
9.1 APPLICABILITY OF DFS REQUIREMENTS	66
9.2 INTERFERENCE THRESHOLD VALUES, MASTER OR CLIENT INCORPORATING IN-SERVICE MONITORING	66
9.3 DFS RESPONSE REQUIREMENT VALUES	67
9.4 SHORT PULSE RADAR TEST WAVEFORMS	67
9.5 CALIBRATION SETUP AND DFS TEST RESULTS	68
9.6 CONDUCTED CALIBRATION SETUP	68
9.7 RADAR WAVEFORM CALIBRATION RESULT	68
9.8 IN-SERVICE MONITORING: CHANNEL MOVE TIME, CHANNEL CLOSING TRANSMISSION TIME AND NON-OCCUPANCY PERIOD	69
9.9 RESULT OF CHANNEL MOVE TIME, CHANNEL CLOSING TRANSMISSION TIME	

**Table of Contents**

	<b>Page</b>
<b>AND NON-OCCUPANCY PERIOD FOR CLIENT BEACON TEST</b>	<b>70</b>
<b>10. ANTENNA REQUIREMENT</b>	<b>71</b>
<b>10.1 STANDARD REQUIREMENT</b>	<b>71</b>
<b>10.2 EUT ANTENNA</b>	<b>71</b>



### 1. SUMMARY OF TEST RESULTS

Test procedures according to the technical standards:

<b>FCC Part15 (15.407) , Subpart E</b>			
Standard Section	Test Item	Judgment	Remark
15.207	AC Power Line Conducted Emissions	PASS	
15.209(a), 15.407 (b)(1) 15.407 (b)(2) 15.407 (b)(3) 15.407 (b)(4) 15.407(b)(8)(9)	Spurious Radiated Emissions	PASS	
15.407 (a)	26 dB and 99% Emission Bandwidth	PASS	
15.407(e)	Minimum 6 dB bandwidth	PASS	
15.407 (a)	Maximum Conducted Output Power	PASS	
15.407 (b)(1) 15.407 (b)(2) 15.407 (b)(3) 15.407 (b)(4)	Band Edge	PASS	
15.407 (a)	Power Spectral Density	PASS	
15.407(b)	Spurious Emissions at Antenna Terminals	PASS	
15.407(g)	Frequency Stability Measurement	PASS	
15.407(h)	Dynamic Frequency Selection(DFS)	PASS	
15.203	Antenna Requirement	PASS	
15.407(c)	Automatically discontinue transmission	PASS	(Note 3)

**NOTE:**

- (1) "N/A" denotes test is not applicable in this Test Report
- (2) This device operates with a duty cycle greater than 99%
- (3) The product is a client device, and the data transmission is limited by the AP. When the information to be sent is missing or the operation fails, the device will automatically stop sending and directly connect to the AP correctly again.

**1.1 FACILITIES AND ACCREDITATIONS**

**FACILITIES**

All measurement facilities used to collect the measurement data are located at No. 24 Xinfu East Road, Xiangshan Community, Xinqiao Street, Baoan District, Shenzhen, Guangdong, People's Republic of China.

The sites are constructed in conformance with the requirements of ANSI C63.7, ANSI C63.10 and CISPR Publication 22.

**LABORATORY ACCREDITATIONS AND LISTINGS**

Site Description

CNAS-Lab. : The Certificate Registration Number is L5516.

IC-Registration : The Certificate Registration Number is 9270A.  
CAB identifier:CN0074

FCC- Accredited : Test Firm Registration Number: 463705.  
Designation Number: CN1184

A2LA-Lab. : The Certificate Registration Number is 4298.01

Name of Firm : Shenzhen NTEK Testing Technology Co., Ltd.

Site Location : No. 24 Xinfu East Road, Xiangshan Community, Xinqiao Street, Baoan District, Shenzhen, Guangdong, People's Republic of China.

**1.2 MEASUREMENT UNCERTAINTY**

The reported uncertainty of measurement  $y \pm U$ , where expanded uncertainty  $U$  is based on a standard uncertainty multiplied by a coverage factor of  $k=2$ , providing a level of confidence of approximately 95 %.

No.	Item	Uncertainty
1	Conducted Emission Test	$\pm 2.80\text{dB}$
2	RF power, conducted, PSD	$\pm 0.16\text{dB}$
3	Spurious emissions, conducted	$\pm 0.21\text{dB}$
4	Occupied bandwidth	$\pm 4.7\%$
5	All emissions, radiated(9KHz~30MHz)	$\pm 6\text{dB}$
6	All emissions, radiated(30MHz~1GHz)	$\pm 2.64\text{dB}$
7	All emissions, radiated(1GHz~6GHz)	$\pm 2.40\text{dB}$
8	All emissions, radiated(> 6GHz)	$\pm 2.52\text{dB}$
9	Temperature	$\pm 0.5^\circ\text{C}$
10	Humidity	$\pm 2\%$
11	Radio Frequency	$\pm 0.2\text{ppm}$
12	Occupied bandwidth	$\pm 4.7\%$



**1. GENERAL INFORMATION**  
**1.1 GENERAL DESCRIPTION OF EUT**

Equipment	Magic Note Pad																		
Trade Mark	XPPen																		
Model Name	MNP1095																		
Family Model	MNP1091, MNP1092, MNP1093, MNP1095																		
Model Difference	All models are the same circuit and RF module, except for model names.																		
FCC ID	2AKDT-MNP1095																		
Product Description	<table border="1"> <tr> <td>Mode Supported</td> <td> <input checked="" type="checkbox"/>802.11a  <input checked="" type="checkbox"/>802.11n(HT20)  <input checked="" type="checkbox"/>802.11n(HT40)  <input checked="" type="checkbox"/>802.11ac(HT20)  <input checked="" type="checkbox"/>802.11ac(HT40)  <input checked="" type="checkbox"/>802.11ac(HT80)                 </td> </tr> <tr> <td>Data Rate</td> <td>                     802.11a: 6,9,12,18,24,36,48,54Mbps;                      802.11n(HT20/HT40):MCS0-MCS15;                      802.11ac(VHT20): NSS1, MCS0-MCS8                      802.11ac(VHT40/VHT80):NSS1, MCS0-MCS9                 </td> </tr> <tr> <td>Modulation</td> <td>OFDM with BPSK/QPSK/16QAM/64QAM</td> </tr> <tr> <td>Operating Frequency Range</td> <td> <input checked="" type="checkbox"/> U-NII-1: 5150 MHz ~5250MHz  <input checked="" type="checkbox"/> U-NII-2A: 5250MHz~5350MHz  <input checked="" type="checkbox"/> U-NII-2C: 5470MHz~5725MHz  <input checked="" type="checkbox"/> U-NII-3: 5725 MHz ~5850 MHz                 </td> </tr> <tr> <td>Function:</td> <td> <input type="checkbox"/>Outdoor AP <input type="checkbox"/>Indoor AP <input type="checkbox"/>Fixed P2P  <input checked="" type="checkbox"/>Client                 </td> </tr> <tr> <td>DFS type:</td> <td> <input type="checkbox"/>master devices  <input type="checkbox"/>Slave devices with radar detection  <input checked="" type="checkbox"/>Slave devices without radar detection                 </td> </tr> <tr> <td>Support TPC</td> <td> <input type="checkbox"/>YES  <input checked="" type="checkbox"/>NO                 </td> </tr> <tr> <td>Antenna Type</td> <td>FPC antenna</td> </tr> <tr> <td>Antenna Gain</td> <td>-0.5dBi</td> </tr> </table>	Mode Supported	<input checked="" type="checkbox"/> 802.11a <input checked="" type="checkbox"/> 802.11n(HT20) <input checked="" type="checkbox"/> 802.11n(HT40) <input checked="" type="checkbox"/> 802.11ac(HT20) <input checked="" type="checkbox"/> 802.11ac(HT40) <input checked="" type="checkbox"/> 802.11ac(HT80)	Data Rate	802.11a: 6,9,12,18,24,36,48,54Mbps; 802.11n(HT20/HT40):MCS0-MCS15; 802.11ac(VHT20): NSS1, MCS0-MCS8 802.11ac(VHT40/VHT80):NSS1, MCS0-MCS9	Modulation	OFDM with BPSK/QPSK/16QAM/64QAM	Operating Frequency Range	<input checked="" type="checkbox"/> U-NII-1: 5150 MHz ~5250MHz <input checked="" type="checkbox"/> U-NII-2A: 5250MHz~5350MHz <input checked="" type="checkbox"/> U-NII-2C: 5470MHz~5725MHz <input checked="" type="checkbox"/> U-NII-3: 5725 MHz ~5850 MHz	Function:	<input type="checkbox"/> Outdoor AP <input type="checkbox"/> Indoor AP <input type="checkbox"/> Fixed P2P <input checked="" type="checkbox"/> Client	DFS type:	<input type="checkbox"/> master devices <input type="checkbox"/> Slave devices with radar detection <input checked="" type="checkbox"/> Slave devices without radar detection	Support TPC	<input type="checkbox"/> YES <input checked="" type="checkbox"/> NO	Antenna Type	FPC antenna	Antenna Gain	-0.5dBi
	Mode Supported	<input checked="" type="checkbox"/> 802.11a <input checked="" type="checkbox"/> 802.11n(HT20) <input checked="" type="checkbox"/> 802.11n(HT40) <input checked="" type="checkbox"/> 802.11ac(HT20) <input checked="" type="checkbox"/> 802.11ac(HT40) <input checked="" type="checkbox"/> 802.11ac(HT80)																	
	Data Rate	802.11a: 6,9,12,18,24,36,48,54Mbps; 802.11n(HT20/HT40):MCS0-MCS15; 802.11ac(VHT20): NSS1, MCS0-MCS8 802.11ac(VHT40/VHT80):NSS1, MCS0-MCS9																	
	Modulation	OFDM with BPSK/QPSK/16QAM/64QAM																	
	Operating Frequency Range	<input checked="" type="checkbox"/> U-NII-1: 5150 MHz ~5250MHz <input checked="" type="checkbox"/> U-NII-2A: 5250MHz~5350MHz <input checked="" type="checkbox"/> U-NII-2C: 5470MHz~5725MHz <input checked="" type="checkbox"/> U-NII-3: 5725 MHz ~5850 MHz																	
	Function:	<input type="checkbox"/> Outdoor AP <input type="checkbox"/> Indoor AP <input type="checkbox"/> Fixed P2P <input checked="" type="checkbox"/> Client																	
	DFS type:	<input type="checkbox"/> master devices <input type="checkbox"/> Slave devices with radar detection <input checked="" type="checkbox"/> Slave devices without radar detection																	
	Support TPC	<input type="checkbox"/> YES <input checked="" type="checkbox"/> NO																	
	Antenna Type	FPC antenna																	
	Antenna Gain	-0.5dBi																	
Based on the application, features, or specification exhibited in User's Manual, More details of EUT technical specification, please refer to the User's Manual.																			
Adapter	Model: MX20PD-J Input: 100-240V~50/60Hz 0.5A Output: 5V $\overline{\text{---}}$ 3A / 9V $\overline{\text{---}}$ 2.22A / 12V $\overline{\text{---}}$ 1.67A (20W Max)																		
Battery	Typical Capacity: DC 3.85V, 8000mAh, 30.80Wh Rated Capacity: DC 3.85V, 7800mAh, 30.03Wh																		
Power supply	DC 3.85V from battery or DC 5V from Adapter.																		
Connecting I/O Port(s)	Please refer to the User's Manual																		
Hardware version	05																		
FW Version	01																		
Software version	v1P11-F																		

Note:

1. For a more detailed features description, please refer to the manufacturer's specifications or the User's Manual.
2. Frequency and Channel list:

Band	20MHz		40MHz		80MHz	
	Channel	Frequency	Channel	Frequency	Channel	Frequency
U-NII-1	36	5180 MHz	38	5190 MHz	42	5210 MHz
	40	5200 MHz	46	5230 MHz	-	-
	44	5220 MHz				
	48	5240 MHz				
U-NII-2A	52	5260 MHz	54	5270 MHz	58	5290 MHz
	56	5280 MHz	62	5310 MHz		
	60	5300 MHz				
	64	5320 MHz				
U-NII-2C	100	5500 MHz	102	5510 MHz	106	5530 MHz
	104	5520 MHz	110	5550 MHz	122	5610 MHz
	108	5540 MHz	118	5590 MHz		
	112	5560 MHz	126	5630 MHz		
	116	5580 MHz	134	5670 MHz		
	120	5600 MHz				
	124	5620 MHz				
	128	5640 MHz				
	132	5660 MHz				
	136	5680 MHz				
U-NII-3	149	5745 MHz	151	5755 MHz	155	5775 MHz
	153	5765 MHz	159	5795 MHz		
	157	5785 MHz				
	161	5805 MHz				
	165	5825 MHz				

**1.2 DESCRIPTION OF TEST MODES**

To investigate the maximum EMI emission characteristics generates from EUT, the test system was pre-scanning tested base on the consideration of following EUT operation mode or test configuration mode which possible have effect on EMI emission level. Each of these EUT operation mode(s) or test configuration mode(s) mentioned above was evaluated respectively.

<b>For Radiated Emission</b>	
Final Test Mode	Description
Mode 1	Normal Link Mode
Mode 2	802.11a / n/ ac 20 CH36/ CH40/ CH48/CH52/CH56/CH64/CH100/CH120/CH140/CH149/ CH157/CH165
Mode 3	802.11n40/ac40 CH38/CH46/CH54/CH62/CH102/CH118/CH134/CH151/ CH159
Mode 4	802.11ac80 CH42/CH58/CH106/CH122/CH155

<b>For Conducted Emission</b>	
Final Test Mode	Description
Mode 1	Normal Link Mode
Mode 2	802.11a / n/ ac 20 CH36/ CH40/ CH48/CH52/CH56/CH64/CH100/CH120/CH140/CH149/ CH157/CH165
Mode 3	802.11n40/ac40 CH38/CH46/CH54/CH62/CH102/CH118/CH134/CH151/ CH159
Mode 4	802.11ac80 CH42/CH58/CH106/CH122/CH155

Note:

- (1) The measurements are performed at the highest, middle, lowest available channels.
- (2) The measurements are performed at all Bit Rate of Transmitter, the worst data was reported

### 1.3 BLOCK DIGRAM SHOWING THE CONFIGURATION OF SYSTEM TESTED

For AC Conducted Emission Mode

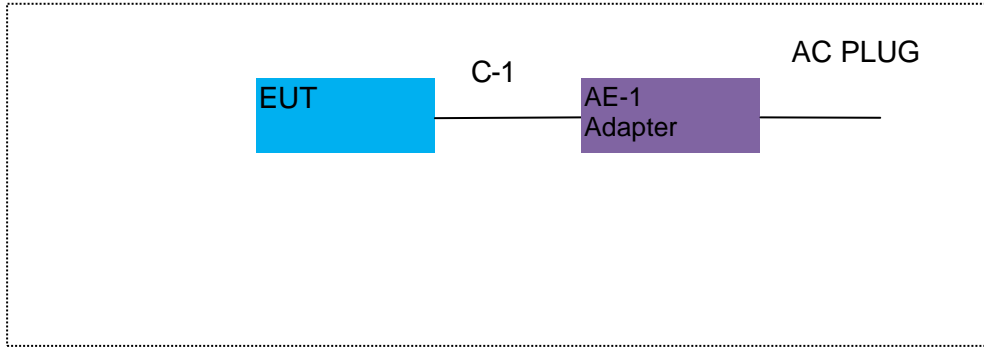

For Radiated Test Cases

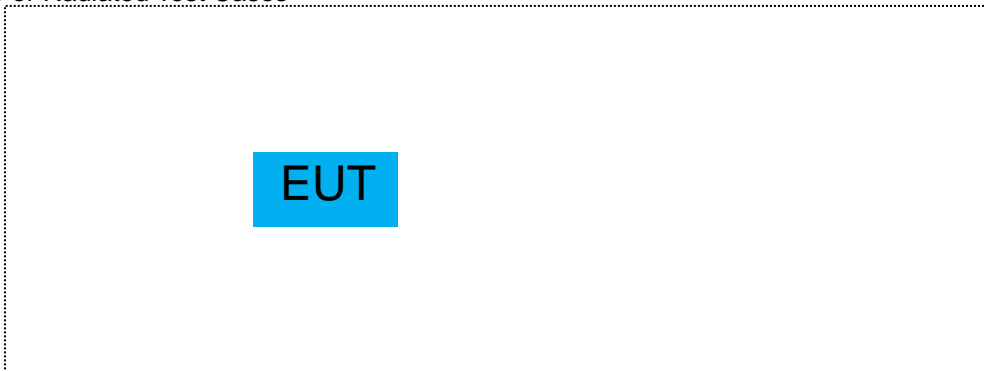

For Conducted Test Cases

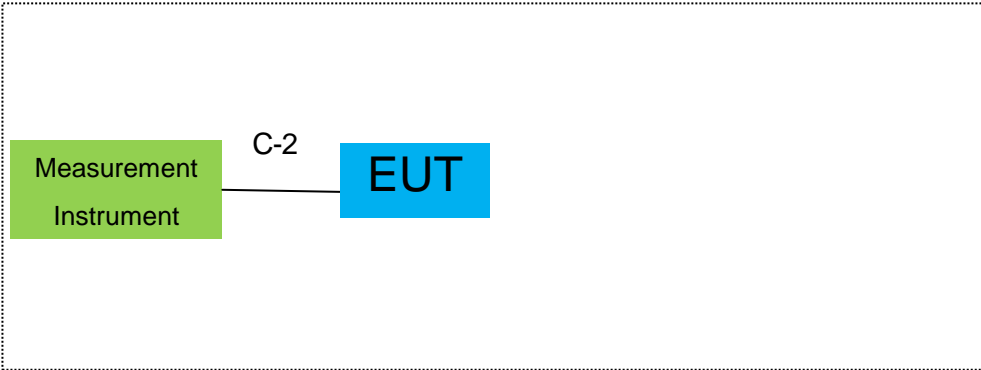

Note: 1. The temporary antenna connector is soldered on the PCB board in order to perform conducted tests and this temporary antenna connector is listed in the equipment list.

**1.4 DESCRIPTION OF SUPPORT UNITS(CONDUCTED MODE)**

The EUT has been tested as an independent unit together with other necessary accessories or support units. The following support units or accessories were used to form a representative test configuration during the tests.

Item	Equipment	Model/Type No.	Series No.	Note
AE-1	Adapter	MX20PD-J	N/A	Peripherals

Item	Cable Type	Shielded Type	Ferrite Core	Length
C-1	Type-C Cable	YES	NO	0.8m
C-2	RF Cable	YES	NO	0.1m

Note:

- (1) The support equipment was authorized by Declaration of Confirmation.
- (2) For detachable type I/O cable should be specified the length in cm in 『Length』 column.
- (3) During the battery power test, the battery is fully charged.

### 1.5 EQUIPMENTS LIST FOR ALL TEST ITEMS

Radiation& Conducted Test equipment

Item	Kind of Equipment	Manufacturer	Type No.	Serial No.	Last calibration	Calibrated until	Calibration period
1	Spectrum Analyzer	Agilent	E4440A	MY41000130	2024.04.26	2025.04.25	1 year
2	Spectrum Analyzer	Agilent	N9020A	MY49100060	2024.04.25	2025.04.24	1 year
3	Spectrum Analyzer	R&S	FSV40	101417	2024.04.25	2025.04.24	1 year
4	Test Receiver	R&S	ESPI7	101318	2024.04.26	2025.04.25	1 year
5	Bilog Antenna	TESEQ	CBL6111D	31216	2024.05.12	2025.03.11	1 year
6	50Ω Coaxial Switch	Anritsu	MP59B	6200983705	2024.04.26	2027.04.25	3 year
7	Horn Antenna	EM	EM-AH-10180	2011071402	2024.05.12	2027.05.11	3 year
8	Broadband Horn Antenna	SCHWARZBECK	BBHA 9170	803	2024.05.12	2027.05.11	3 year
9	Amplifier	EMC	EMC051835SE	980246	2024.04.25	2025.04.24	1 year
10	Active Loop Antenna	SCHWARZBECK	FMZB 1519B	055	2024.05.17	2027.05.16	3 year
11	Power Meter	DARE	RPR3006W	15100041SN084	2024.04.25	2025.04.24	1 year
12	Test Cable (9KHz-30MHz)	N/A	R-01	N/A	2023.05.06	2026.05.05	3 year
13	Test Cable (30MHz-1GHz)	N/A	R-02	N/A	2023.05.06	2026.05.05	3 year
14	High Test Cable(1G-40G Hz)	N/A	R-03	N/A	2022.06.17	2025.06.16	3 year
15	Filter	TRILTHIC	2400MHz	29	2024.04.26	2027.04.25	3 year
16	temporary antenna connector (Note)	NTS	R001	N/A	N/A	N/A	N/A

Note:

We will use the temporary antenna connector (soldered on the PCB board) When conducted test  
 And this temporary antenna connector is listed within the instrument list

AC Conduction Test equipment

Item	Kind of Equipment	Manufacturer	Type No.	Serial No.	Last calibration	Calibrated until	Calibration period
1	Test Receiver	R&S	ESCI	101160	2024.04.26	2025.04.25	1 year
2	LISN	R&S	ENV216	101313	2024.04.25	2025.04.24	1 year
3	LISN	SCHWARZBECK	NNLK 8129	8129245	2024.04.25	2025.04.24	1 year
4	50Ω Coaxial Switch	ANRITSU CORP	MP59B	6200983704	2024.04.26	2027.04.25	3 year
5	Test Cable (9KHz-30M Hz)	N/A	C01	N/A	2023.05.06	2026.05.05	3 year
6	Test Cable (9KHz-30M Hz)	N/A	C02	N/A	2023.05.06	2026.05.05	3 year
7	Test Cable (9KHz-30M Hz)	N/A	C03	N/A	2023.05.06	2026.05.05	3 year

Note: Each piece of equipment is scheduled for calibration once a year except the Test Cable& Aux Equipment which is scheduled for calibration every 3 years.

Measurement Software

Item	Manufacturer	Software Name	Software Version	Description
1	MWRftest	MTS 8310 2.4GHz/5GHz	2.0	RF Conducted Test
2	Farad	EZ-EMC_RE	AIT-03A	RadiatedTest
3	raditeq	RadiMation	2023.1.3	RadiatedTest
4	Farad	EZ-EMC_CE	AIT-03A	AC Conducted Test

## 2. EMC EMISSION TEST

### 2.1 CONDUCTED EMISSION MEASUREMENT

#### 2.1.1 APPLICABLE STANDARD

According to FCC Part 15.207(a)

#### 2.1.2 CONFORMANCE LIMIT

Frequency(MHz)	Conducted Emission Limit	
	Quasi-peak	Average
0.15-0.5	66-56*	56-46*
0.5-5.0	56	46
5.0-30.0	60	50

Note: 1. \*Decreases with the logarithm of the frequency  
 2. The lower limit shall apply at the transition frequencies  
 3. The limit decreases in line with the logarithm of the frequency in the range of 0.15 to 0.50MHz.

#### 2.1.3 TEST CONFIGURATION

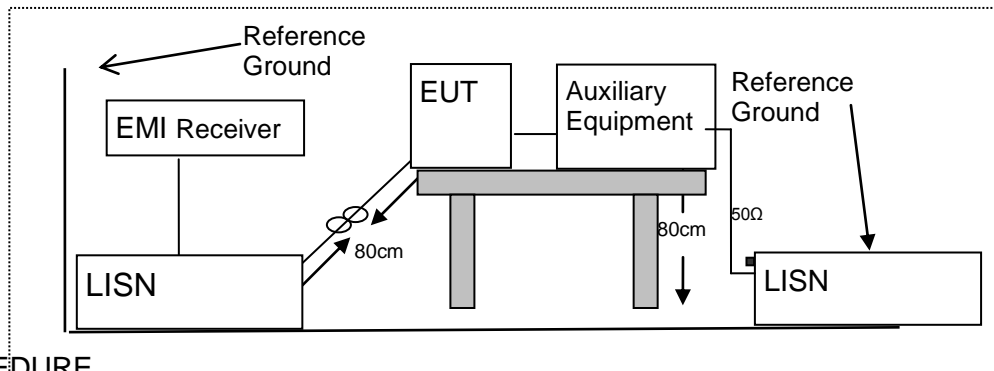

#### 2.1.4 TEST PROCEDURE

According to the requirements in Section 13.1.4.1 of ANSI C63.10-2013 Conducted emissions the EUT measured in the frequency range between 0.15 MHz and 30 MHz using CISPR Quasi-Peak and average detector mode.

1. The EUT was placed 0.4 meter from the conducting wall of the shielding room.
2. The EUT was placed on a table which is 0.8m above ground plane.
3. Connect EUT to the power mains through a line impedance stabilization network (LISN). All other support equipments powered from additional LISN(s). The LISN provide 50 Ohm/ 50uH of coupling impedance for the measuring instrument.
4. Interconnecting cables that hang closer than 40 cm to the ground plane shall be folded back and forth in the center forming a bundle 30 to 40cm long.
5. I/O cables that are not connected to a peripheral shall be bundled in the center. The end of the cable may be terminated, if required, using the correct terminating impedance. The overall length shall not exceed 1 m.
6. LISN at least 80 cm from nearest part of EUT chassis.
7. The frequency range from 150KHz to 30MHz was searched.
8. Set the test-receiver system to Peak Detect Function and specified bandwidth(IF bandwidth=9KHz) with Maximum Hold Mode
9. For the actual test configuration, please refer to the related Item –EUT Test Photos.



EUT :	Magic Note Pad	Model Name. :	MNP1095
Temperature :	23.4 °C	Relative Humidity :	58%
Pressure :	1010hPa	Phase :	L
Test Voltage :	DC 12V from Adapter AC 120V/60Hz	Test Mode :	Mode 1

Frequency (MHz)	Reading Level (dBμV)	Correct Factor (dB)	Measurement (dBμV)	Limits (dBμV)	Margin (dB)	Remark
0.2540	33.91	10.15	44.06	61.63	-17.57	QP
0.2540	20.14	10.15	30.29	51.63	-21.34	AVG
0.5020	33.92	10.68	44.60	56.00	-11.40	QP
0.5020	18.97	10.68	29.65	46.00	-16.35	AVG
1.3099	29.28	12.30	41.58	56.00	-14.42	peak
1.3099	14.14	12.30	26.44	46.00	-19.56	AVG
2.6060	32.21	9.69	41.90	56.00	-14.10	QP
2.6060	15.35	9.69	25.04	46.00	-20.96	AVG
4.4899	32.19	9.70	41.89	56.00	-14.11	QP
4.4899	15.69	9.70	25.39	46.00	-20.61	AVG
21.7939	28.33	9.95	38.28	60.00	-21.72	QP
21.7939	11.17	9.95	21.12	50.00	-28.88	AVG

Remark:

1. All readings are Quasi-Peak and Average values.
2. Factor = Insertion Loss + Cable Loss.

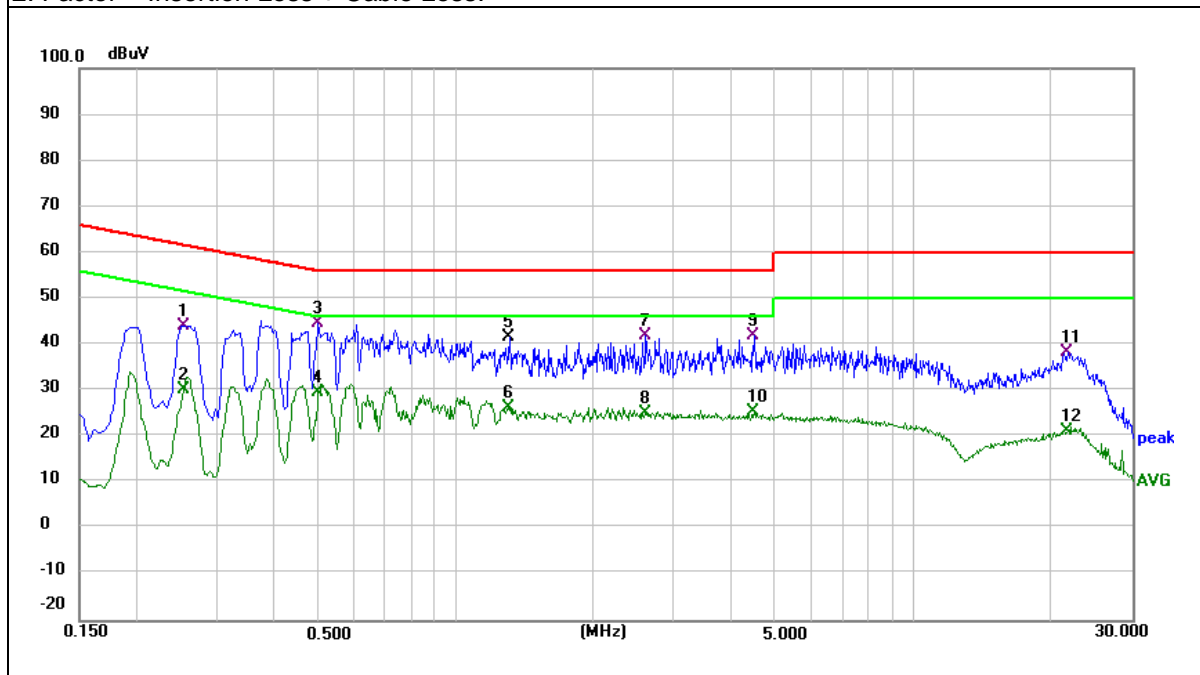

EUT :	Magic Note Pad	Model Name. :	MNP1095
Temperature :	26 °C	Relative Humidity :	45%
Pressure :	1010hPa	Phase :	N
Test Voltage :	DC 12V from Adapter AC 120V/60Hz	Test Mode :	Mode 1

Frequency (MHz)	Reading Level (dBμV)	Correct Factor (dB)	Measure-ment (dBμV)	Limits (dBμV)	Margin (dB)	Remark
0.2500	35.01	10.15	45.16	61.76	-16.60	QP
0.2500	19.09	10.15	29.24	51.76	-22.52	AVG
0.6060	33.86	10.90	44.76	56.00	-11.24	QP
0.6060	16.39	10.90	27.29	46.00	-18.71	AVG
2.2220	31.29	9.68	40.97	56.00	-15.03	QP
2.2220	14.78	9.68	24.46	46.00	-21.54	AVG
4.5658	31.16	9.71	40.87	56.00	-15.13	QP
4.5959	14.74	9.71	24.45	46.00	-21.55	AVG
12.3460	21.43	9.81	31.24	60.00	-28.76	peak
12.3460	8.40	9.81	18.21	50.00	-31.79	AVG
22.5260	29.78	9.96	39.74	60.00	-20.26	peak
22.5580	11.63	9.96	21.59	50.00	-28.41	AVG

Remark:

1. All readings are Quasi-Peak and Average values.
2. Factor = Insertion Loss + Cable Loss.

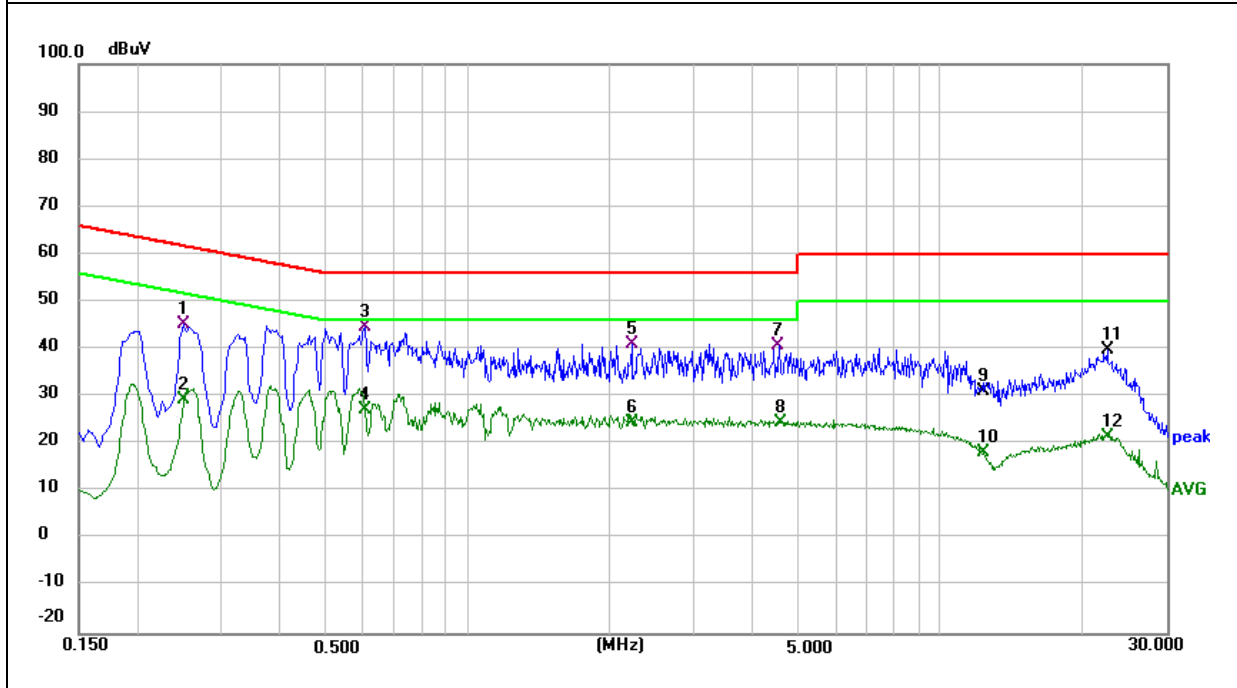

**2.2 RADIATED EMISSION MEASUREMENT**

**2.2.1 APPLICABLE STANDARD**

According to FCC Part 15.407(b) and 15.209

**2.2.2 CONFORMANCE LIMIT**

According to FCC Part 15.407 ( b ) ( 9 ) ( 10 ) : radiated emissions which fall in the restricted bands, as defined in §15.205(a), must also comply with the radiated emission limits specified in §15.209(a) (see §15.205(c)).  
According to FCC Part15.205, Restricted bands

MHz	MHz	MHz	GHz
0.090-0.110	16.42-16.423	399.9-410	4.5-5.15
0.495-0.505	16.69475-16.69525	608-614	5.35-5.46
2.1735-2.1905	16.80425-16.80475	960-1240	7.25-7.75
4.125-4.128	25.5-25.67	1300-1427	8.025-8.5
4.17725-4.17775	37.5-38.25	1435-1626.5	9.0-9.2
4.20725-4.20775	73-74.6	1645.5-1646.5	9.3-9.5
6.215-6.218	74.8-75.2	1660-1710	10.6-12.7
6.26775-6.26825	123-138	2200-2300	14.47-14.5
8.291-8.294	149.9-150.05	2310-2390	15.35-16.2
8.362-8.366	156.52475-156.52525	2483.5-2500	17.7-21.4
8.37625-8.38675	156.7-156.9	2690-2900	22.01-23.12
8.41425-8.41475	162.0125-167.17	3260-3267	23.6-24.0
12.29-12.293	167.72-173.2	3332-3339	31.2-31.8
12.51975-12.52025	240-285	3345.8-3358	36.43-36.5
12.57675-12.57725	322-335.4	3600-4400	(2)
13.36-13.41			

In case the emission fall within the restricted band specified on 15.205(a), then the 15.209(a) limit in the table below has to be followed.

Restricted Frequency(MHz)	Field Strength (µV/m)	Field Strength (dBµV/m)	Measurement Distance
0.009~0.490	2400/F(KHz)	20 log (uV/m)	300
0.490~1.705	24000/F(KHz)	20 log (uV/m)	30
1.705~30.0	30	29.5	30
30-88	100	40	3
88-216	150	43.5	3
216-960	200	46	3
Above 960	500	54	3

**Limits of Radiated Emission Measurement(Above 1000MHz)**

Frequency(MHz)	Class B (dBuV/m) (at 3M)	
	PEAK	AVERAGE
Above 1000	74	54

Remark : 1. Emission level in dBuV/m=20 log (uV/m)  
 2. Measurement was performed at an antenna to the closed point of EUT distance of meters.  
 3. For Frequency 9kHz~30MHz:  
 Distance extrapolation factor =40log(Specific distance/ test distance)(dB);  
 Limit line=Specific limits(dBuV) + distance extrapolation factor.  
 For Frequency above 30MHz:  
 Distance extrapolation factor =20log(Specific distance/ test distance)(dB);  
 Limit line=Specific limits(dBuV) + distance extrapolation factor.

**2.2.3 MEASURING INSTRUMENTS**

The Measuring equipment is listed in the section 6.3 of this test report.

2.2.4 TEST CONFIGURATION

(a) For radiated emissions below 30MHz

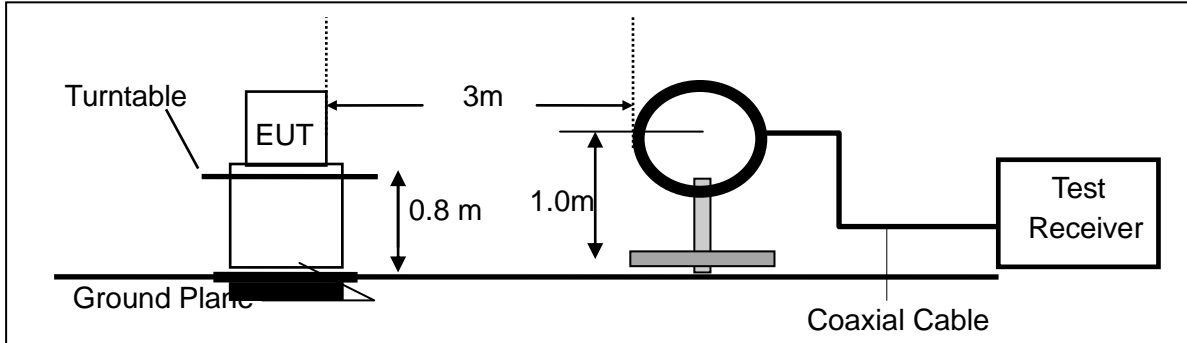

(b) For radiated emissions from 30MHz to 1000MHz

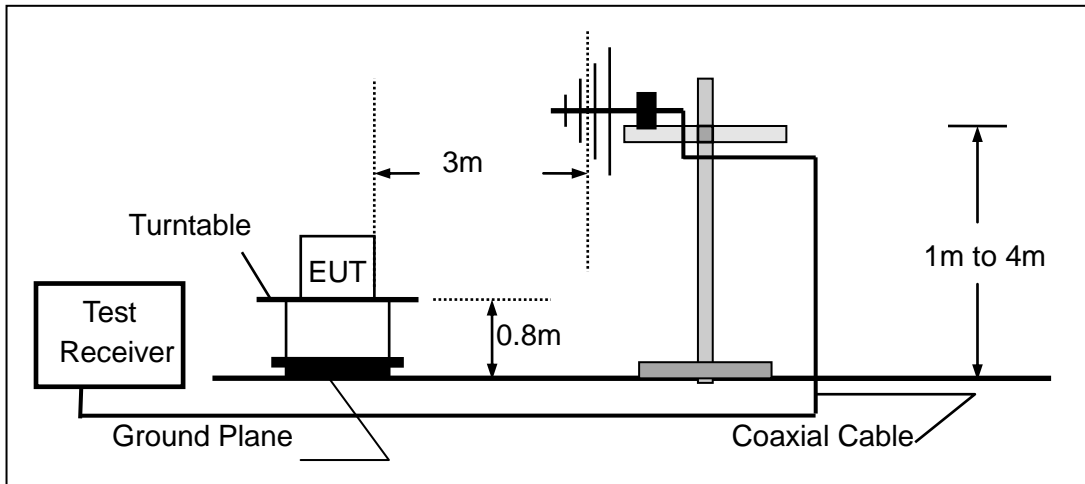

(c) For radiated emissions above 1000MHz

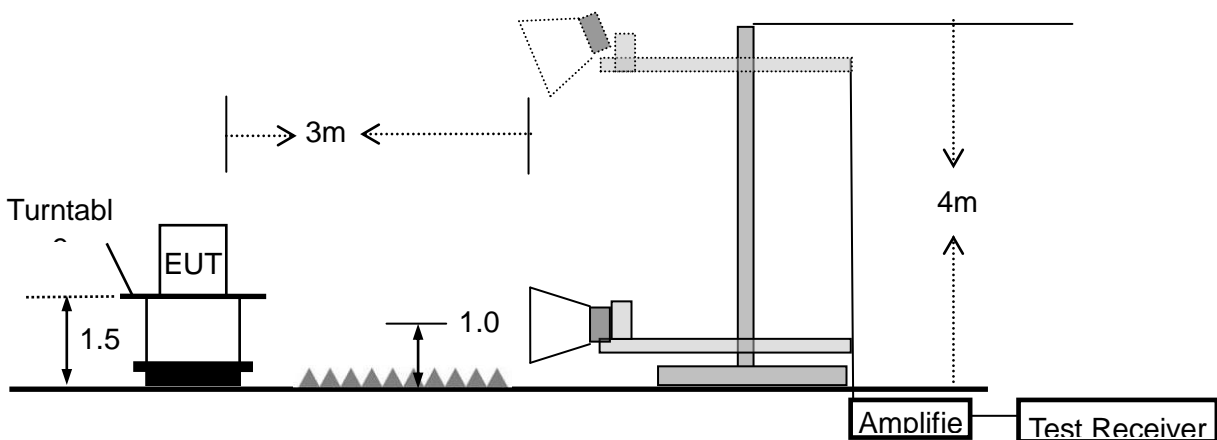

**2.2.5 TEST PROCEDURE**

The test site semi-anechoic chamber has met the requirement of NSA tolerance 4 dB according to the standards: ANSI C63.10-2013. The test distance is 3m. The setup is according to the requirements in Section 13.1.4.1 of ANSI C63.10-2013 and CAN/CSA-CEI/IEC CISPR 22.

This test is required for any spurious emission that falls in a Restricted Band, as defined in Section 15.205. It must be performed with the highest gain of each type of antenna proposed for use with the EUT.

Use the following spectrum analyzer settings:

Spectrum Parameter	Setting
Attenuation	Auto
Start Frequency	1000 MHz
Stop Frequency	10th carrier harmonic
RB / VB (emission in restricted band)	1 MHz / 1 MHz for Peak, 1 MHz / 10Hz for Average

Receiver Parameter	Setting
Attenuation	Auto
Start ~ Stop Frequency	9kHz~150kHz / RB 200Hz for QP
Start ~ Stop Frequency	150kHz~30MHz / RB 9kHz for QP
Start ~ Stop Frequency	30MHz~1000MHz / RB 120kHz for QP

- The measuring distance of at 3 m shall be used for measurements at frequency up to 1GHz. For frequencies above 1GHz, any suitable measuring distance may be used.
- The EUT was placed on the top of a rotating table 0.8 m for below 1GHz and 1.5m for above 1GHz the ground at a 3 meter. The table was rotated 360 degrees to determine the position of the highest radiation.
- The height of the equipment or of the substitution antenna shall be 0.8 m for below 1GHz and 1.5m for above 1GHz; the height of the test antenna shall vary between 1 m to 4 m. Both horizontal and vertical polarizations of the antenna are set to make the measurement.
- The initial step in collecting conducted emission data is a spectrum analyzer peak detector mode pre-scanning the measurement frequency range. Significant peaks are then marked and then Quasi Peak detector mode re-measured.
- If the Peak Mode measured value compliance with and lower than Quasi Peak Mode Limit, the EUT shall be deemed to meet QP Limits and then no additional QP Mode measurement performed.
- For the actual test configuration, please refer to the related Item –EUT Test Photos.

Note:

Both horizontal and vertical antenna polarities were tested and performed pretest to three orthogonal axis. The worst case emissions were reported

During the radiated emission test, the Spectrum Analyzer was set with the following configurations:

Frequency Band (MHz)	Function	Resolution bandwidth	Video Bandwidth
30 to 1000	QP	120 kHz	300 kHz
Above 1000	Peak	1 MHz	1 MHz
	Average	1 MHz	10 Hz

Note: for the frequency ranges below 30 MHz, a narrower RBW is used for these ranges but the measured value should add a RBW correction factor (RBWCF) where  $RBWCF [dB] = 10 \cdot \lg(100 [kHz] / \text{narrower RBW [kHz]})$ . , the narrower RBW is 1 kHz and RBWCF is 20 dB for the frequency 9 kHz to 150 kHz, and the narrower RBW is 10 kHz and RBWCF is 10 dB for the frequency 150 kHz to 30 MHz.

**2.2.6 TEST RESULTS (9KHZ – 30 MHZ)**

EUT :	Magic Note Pad	Model Name :	MNP1095
Temperature :	25 °C	Relative Humidity :	56%
Pressure:	1010 hPa	Test Voltage :	DC 3.85V
Test Mode :	TX	Polarization :	--

Freq.	Reading	Limit	Margin	State
(MHz)	(dBuV/m)	(dBuV/m)	(dB)	P/F
--	--	--	--	N/A
--	--	--	--	N/A

**NOTE:**

The amplitude of spurious emissions which are attenuated by more than 20dB below the permissible value has no need to be reported.

**2.2.7 TEST RESULTS (30MHZ – 1GHZ)**

EUT :	Magic Note Pad	Model Name :	MNP1095
Temperature :	25 °C	Relative Humidity :	56%
Pressure :	1010 hPa	Test Voltage :	DC 3.85V
Test Mode :	TX		

Polar (H/V)	Frequency	Meter Reading	Factor	Emission Level	Limits	Margin	Remark
	(MHz)	(dBuV)	(dB)	(dBuV/m)	(dBuV/m)	(dB)	
V	55.2210	4.73	19.76	24.49	40.00	-15.51	peak
V	107.1340	4.99	17.78	22.77	43.50	-20.73	peak
V	215.2680	5.70	18.69	24.39	43.50	-19.11	peak
V	373.3110	5.71	22.12	27.83	46.00	-18.17	peak
V	580.7030	5.32	26.71	32.03	46.00	-13.97	peak
V	919.2870	5.65	30.65	36.30	46.00	-9.70	peak

**Remark:**

Emission Level= ReadingLevel+ Factor, Margin= Emission Level - Limit

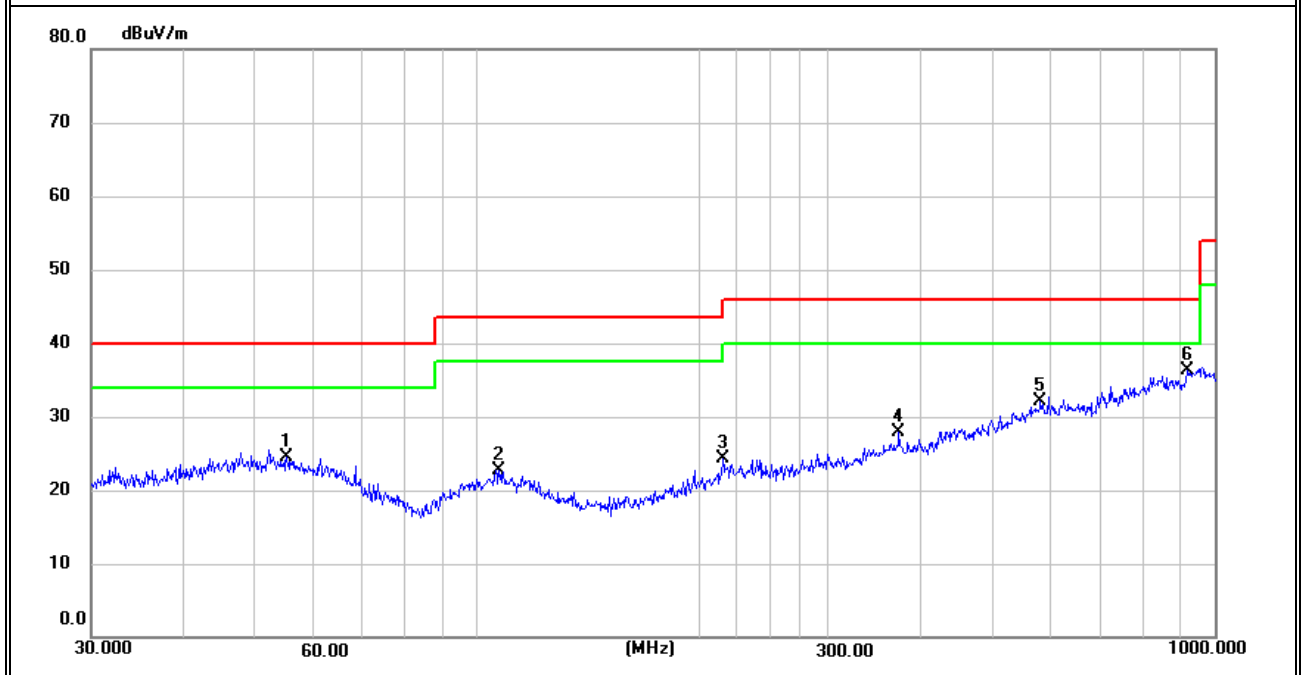

Polar (H/V)	Frequency	Meter Reading	Factor	Emission Level	Limits	Margin	Remark
	(MHz)	(dBuV)	(dB)	(dBuV/m)	(dBuV/m)	(dB)	
H	57.5940	4.91	19.36	24.27	40.00	-15.73	peak
H	113.7140	6.03	16.97	23.00	43.50	-20.50	peak
H	213.0150	4.91	18.36	23.27	43.50	-20.23	peak
H	355.4270	5.02	21.78	26.80	46.00	-19.20	peak
H	554.8250	6.41	25.61	32.02	46.00	-13.98	peak
H	827.4930	5.98	29.75	35.73	46.00	-10.27	peak

**Remark:**

Emission Level= ReadingLevel+ Factor, Margin= Emission Level - Limit

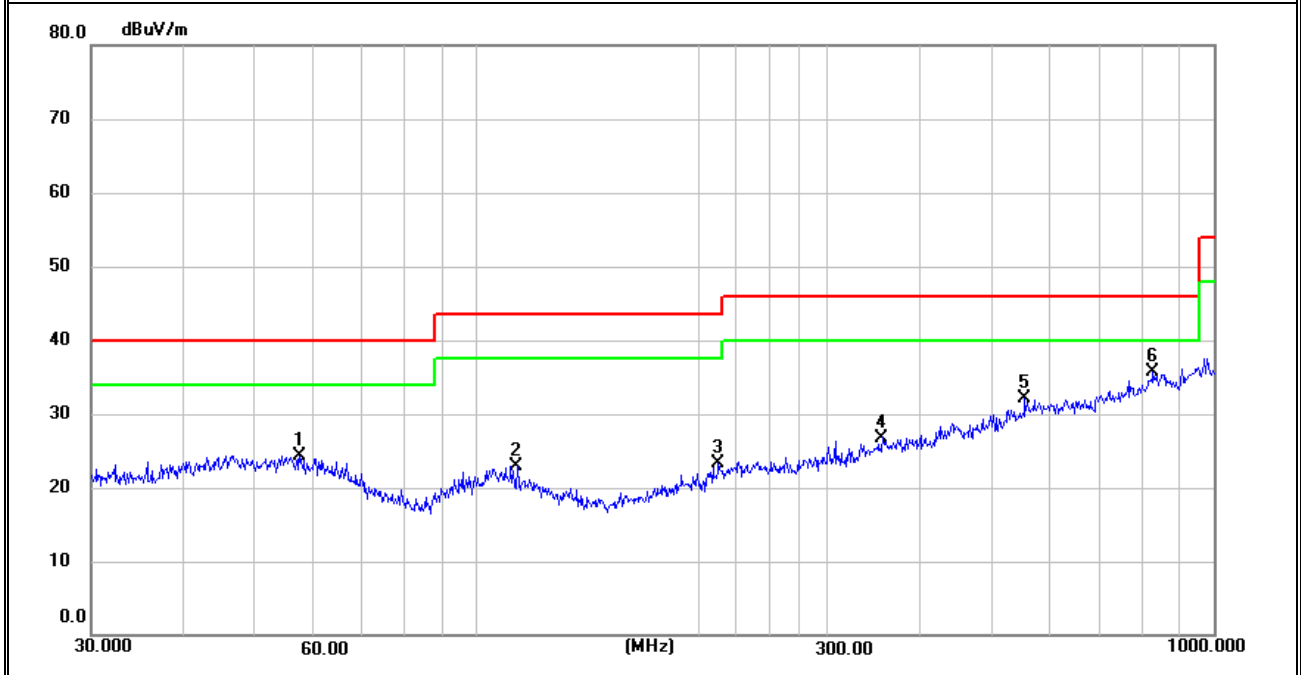

Note: All modes have been tested, just the worst mode has been recorded in the report.



**2.2.8 TEST RESULTS (1GHz-18GHz)**

EUT :	Magic Note Pad	Model Name. :	MNP1095
Temperature :	25 °C	Relative Humidity :	56%
Pressure :	1010 hPa	Test Voltage :	DC 3.85V
Test Mode :	TX(5.2G) - 802.11a		

Polar	Frequency	Meter Reading	Cable loss	Antenna Factor	Preamp Factor	Emission Level	Limits	Margin	Detector Type
(H/V)	(MHz)	(dBuV)	(dB)	dB/m	(dB)	(dBuV/m)	(dBuV/m)	(dB)	
Low Channel (5180 MHz)-Above 1G									
Vertical	3695.17	68.31	3.25	30.50	43.23	58.83	74.00	-15.17	Pk
Vertical	3695.17	48.62	3.25	30.50	43.23	39.14	54.00	-14.86	AV
Vertical	10360.66	60.98	5.62	38.96	43.41	62.14	68.20	-6.06	Pk
Vertical	15540.73	60.03	7.54	38.98	41.24	65.31	74.00	-8.69	Pk
Vertical	15540.73	39.83	7.54	38.98	41.24	45.11	54.00	-8.89	AV
Horizontal	3743.83	68.07	3.26	31.12	43.23	59.23	74.00	-14.77	Pk
Horizontal	3743.83	49.56	3.26	31.12	43.23	40.72	54.00	-13.28	AV
Horizontal	10361.26	60.82	5.62	38.96	43.41	61.98	68.20	-6.22	Pk
Horizontal	15540.74	56.78	7.54	38.98	41.24	62.06	74.00	-11.94	Pk
Horizontal	15540.74	40.20	7.54	38.98	41.24	45.48	54.00	-8.52	AV
middle Channel (5200 MHz)-Above 1G									
Vertical	3624.88	67.56	3.22	30.26	43.24	57.80	74.00	-16.20	Pk
Vertical	3624.88	49.84	3.22	30.26	43.24	40.08	54.00	-13.92	AV
Vertical	10401.92	59.63	5.64	38.81	43.40	60.67	68.20	-7.53	Pk
Vertical	15601.94	59.00	7.55	39.09	41.19	64.45	74.00	-9.55	Pk
Vertical	15601.94	40.65	7.55	39.09	41.19	46.10	54.00	-7.90	AV
Horizontal	4203.74	64.51	3.45	32.31	43.22	57.05	74.00	-16.95	Pk
Horizontal	4203.74	50.50	3.45	32.31	43.22	43.04	54.00	-10.96	AV
Horizontal	10401.33	62.38	5.64	38.81	43.40	63.42	68.20	-4.78	Pk
Horizontal	15601.59	59.27	7.55	39.09	41.19	64.72	74.00	-9.28	Pk
Horizontal	15601.59	39.56	7.55	39.09	41.19	45.01	54.00	-8.99	AV
High Channel (5240 MHz)-Above 1G									
Vertical	4600.12	71.16	3.67	32.30	43.26	63.87	74.00	-10.13	Pk
Vertical	4600.12	51.24	3.67	32.30	43.26	43.95	54.00	-10.05	AV
Vertical	10482.35	60.25	5.68	39.21	43.38	61.76	68.20	-6.44	Pk
Vertical	15722.55	59.88	7.56	38.22	41.09	64.57	74.00	-9.43	Pk
Vertical	15722.55	41.10	7.56	38.22	41.09	45.79	54.00	-8.21	AV
Horizontal	4592.02	68.91	3.67	32.37	43.26	61.69	74.00	-12.31	Pk
Horizontal	4592.02	48.61	3.67	32.37	43.26	41.39	54.00	-12.61	AV
Horizontal	10482.12	60.33	5.68	39.21	43.38	61.84	68.20	-6.36	Pk
Horizontal	15722.15	58.56	7.56	38.22	41.09	63.25	74.00	-10.75	Pk
Horizontal	15722.15	41.13	7.56	38.22	41.09	45.82	54.00	-8.18	AV

Note:"802.11a(5.2G)" mode is the worst mode. PK value is lower than the Average value limit, So average didn't record.  
 The amplitude of spurious emissions that are attenuated by more than 20dB below the permissible value has no need to be reported.  
 Emission level (dBuV/m) = 20 log Emission level (uV/m).  
 Corrected Reading: Antenna Factor + Cable Loss + Read Level - Preamp Factor = Level.

EUT :	Magic Note Pad	Model Name. :	MNP1095
Temperature :	25 °C	Relative Humidity :	56%
Pressure :	1010 hPa	Test Voltage :	DC 3.85V
Test Mode :	TX(5.3G) - 802.11n20		

Polar	Frequency	Meter Reading	Cable loss	Antenna Factor	Preamp Factor	Emission Level	Limits	Margin	Detector Type
(H/V)	(MHz)	(dBuV)	(dB)	dB/m	(dB)	(dBuV/m)	(dBuV/m)	(dB)	
Low Channel (5260 MHz)-Above 1G									
Vertical	4635.01	66.58	3.69	32.58	43.26	59.58	74.00	-14.42	Pk
Vertical	4635.01	46.68	3.69	32.58	43.26	39.68	54.00	-14.32	AV
Vertical	10521.62	60.32	5.70	39.49	43.37	62.14	68.20	-6.06	Pk
Vertical	15781.87	62.42	7.56	38.28	41.04	67.23	74.00	-6.77	Pk
Vertical	15781.87	40.72	7.56	38.28	41.04	45.53	54.00	-8.47	AV
Horizontal	4367.69	68.83	3.54	32.83	43.24	61.96	74.00	-12.04	Pk
Horizontal	4367.69	47.01	3.54	32.83	43.24	40.14	54.00	-13.86	AV
Horizontal	10521.53	59.16	5.70	39.49	43.37	60.98	68.20	-7.22	Pk
Horizontal	15781.94	57.80	7.56	38.28	41.04	62.61	74.00	-11.39	Pk
Horizontal	15781.94	37.73	7.56	38.28	41.04	42.54	54.00	-11.46	AV
middle Channel (5280 MHz)-Above 1G									
Vertical	4123.48	65.05	3.41	31.55	43.21	56.79	74.00	-17.21	Pk
Vertical	4123.48	49.07	3.41	31.55	43.21	40.81	54.00	-13.19	AV
Vertical	10562.12	59.39	5.72	39.85	43.36	61.60	68.20	-6.60	Pk
Vertical	15841.53	62.72	7.57	38.26	40.99	67.56	74.00	-6.44	Pk
Vertical	15841.53	40.47	7.57	38.26	40.99	45.31	54.00	-8.69	AV
Horizontal	3870.92	63.77	3.30	31.52	43.21	55.38	74.00	-18.62	Pk
Horizontal	3870.92	54.52	3.30	31.52	43.21	46.13	54.00	-7.87	AV
Horizontal	10561.51	54.96	5.72	39.85	43.36	57.17	68.20	-11.03	Pk
Horizontal	15842.20	60.70	7.57	38.26	40.98	65.54	74.00	-8.46	Pk
Horizontal	15842.20	39.62	7.57	38.26	40.98	44.46	54.00	-9.54	AV
High Channel (5320 MHz)-Above 1G									
Vertical	5367.89	67.32	3.94	33.77	43.23	61.81	74.00	-12.19	Pk
Vertical	5367.89	50.61	3.94	33.77	43.23	45.10	54.00	-8.90	AV
Vertical	10642.21	61.66	5.75	39.87	43.34	63.94	74.00	-10.06	Pk
Vertical	10642.21	40.21	5.75	39.87	43.34	42.49	54.00	-11.51	AV
Vertical	15961.21	58.64	7.58	38.56	40.88	63.90	74.00	-10.10	Pk
Vertical	15961.21	38.88	7.58	38.56	40.88	44.14	54.00	-9.86	AV
Horizontal	5437.28	66.66	3.95	34.27	43.21	61.67	74.00	-12.33	Pk
Horizontal	5437.28	48.24	3.95	34.27	43.21	43.25	54.00	-10.75	AV
Horizontal	10642.32	62.03	5.75	39.87	43.34	64.31	74.00	-9.69	Pk
Horizontal	10642.32	44.17	5.75	39.87	43.34	46.45	54.00	-7.55	AV
Horizontal	15961.75	58.12	7.58	38.57	40.88	63.38	74.00	-10.62	Pk
Horizontal	15961.75	40.69	7.58	38.57	40.88	45.95	54.00	-8.05	AV

Note: ANT 1 802.11n20(5.3G) mode is the worst mode. PK value is lower than the Average value limit, So average didn't record.

The amplitude of spurious emissions that are attenuated by more than 20dB below the permissible value has no need to be reported.

Emission level (dBuV/m) = 20 log Emission level (uV/m).

Corrected Reading: Antenna Factor + Cable Loss + Read Level - Preamp Factor = Level.

EUT :	Magic Note Pad	Model Name. :	MNP1095
Temperature :	25 °C	Relative Humidity :	56%
Pressure :	1010 hPa	Test Voltage :	DC 3.85V
Test Mode :	TX(5.6G) - 802.11ac20		

Polar	Frequency	Meter Reading	Cable loss	Antenna Factor	Preamp Factor	Emission Level	Limits	Margin	Detector Type
(H/V)	(MHz)	(dBuV)	(dB)	dB/m	(dB)	(dBuV/m)	(dBuV/m)	(dB)	
Low Channel (5500 MHz)-Above 1G									
Vertical	5433.98	66.44	3.95	34.23	43.21	61.41	74.00	-12.59	Pk
Vertical	5433.98	48.37	3.95	34.23	43.21	43.34	54.00	-10.66	AV
Vertical	11001.37	60.78	5.93	40.50	43.25	63.96	74.00	-10.04	Pk
Vertical	11001.37	42.48	5.93	40.50	43.25	45.66	54.00	-8.34	AV
Vertical	16501.29	48.14	7.79	39.60	40.42	55.11	68.20	-13.09	Pk
Horizontal	5126.87	61.47	3.91	34.18	43.27	56.29	74.00	-17.71	Pk
Horizontal	5126.87	45.44	3.91	34.18	43.27	40.26	54.00	-13.74	AV
Horizontal	11001.47	56.85	5.93	40.50	43.25	60.03	74.00	-13.97	Pk
Horizontal	11001.47	40.85	5.93	40.50	43.25	44.03	54.00	-9.97	AV
Horizontal	16501.26	54.10	7.79	39.60	40.42	61.07	68.20	-7.13	Pk
Middle Channel (5600 MHz)-Above 1G									
Vertical	4934.79	66.66	3.85	34.03	43.29	61.25	74.00	-12.75	Pk
Vertical	4934.79	47.37	3.85	34.03	43.29	41.96	54.00	-12.04	AV
Vertical	11201.45	60.33	6.04	39.21	43.20	62.38	74.00	-11.62	Pk
Vertical	11201.45	44.29	6.04	39.21	43.20	46.34	54.00	-7.66	AV
Vertical	16801.97	56.21	7.92	39.49	40.17	63.45	68.20	-4.75	Pk
Horizontal	4768.45	64.68	3.76	33.14	43.28	58.31	74.00	-15.69	Pk
Horizontal	4768.45	48.14	3.76	33.14	43.28	41.77	54.00	-12.23	AV
Horizontal	11201.44	60.42	6.04	39.21	43.20	62.47	74.00	-11.53	Pk
Horizontal	11201.44	43.43	6.04	39.21	43.20	45.48	54.00	-8.52	AV
High Channel (5700 MHz)-Above 1G									
Vertical	4934.79	65.76	3.98	34.79	43.17	61.36	68.20	-6.84	Pk
Vertical	4934.79	57.54	6.15	39.90	43.15	60.44	74.00	-13.56	Pk
Vertical	11201.45	41.65	6.15	39.90	43.15	44.55	54.00	-9.45	AV
Vertical	11201.45	53.74	8.03	39.40	40.08	61.08	68.20	-7.12	Pk
Horizontal	16801.97	66.21	3.95	34.24	43.21	61.19	74.00	-12.81	Pk
Horizontal	4768.45	47.16	3.95	34.24	43.21	42.14	54.00	-11.86	AV
Horizontal	4768.45	59.42	6.15	39.89	43.15	62.31	74.00	-11.69	Pk
Horizontal	11201.44	42.11	6.15	39.89	43.15	45.00	54.00	-9.00	AV
Horizontal	11201.44	51.94	8.03	39.40	40.08	59.29	68.20	-8.91	Pk

Note: "802.11ac20(5.6G)" mode is the worst mode. PK value is lower than the Average value limit, So average didn't record.

The amplitude of spurious emissions that are attenuated by more than 20dB below the permissible value has no need to be reported.

Emission level (dBuV/m) = 20 log Emission level (uV/m).

Corrected Reading: Antenna Factor + Cable Loss + Read Level - Preamp Factor = Level.

EUT :	Magic Note Pad	Model Name. :	MNP1095
Temperature :	25 °C	Relative Humidity :	56%
Pressure :	1010 hPa	Test Voltage :	DC 3.85V
Test Mode :	TX (5.8G) -- 802.11a		

Polar	Frequency	Meter Reading	Cable loss	Antenna Factor	Preamp Factor	Emission Level	Limits	Margin	Detector Type
(H/V)	(MHz)	(dBuV)	(dB)	dB/m	(dB)	(dBuV/m)	(dBuV/m)	(dB)	
Low Channel (5745 MHz)-Above 1G									
Vertical	5123.88	65.80	3.91	34.12	43.28	60.55	74.00	-13.45	Pk
Vertical	5123.88	46.42	3.91	34.12	43.28	41.17	54.00	-12.83	AV
Vertical	11491.85	60.12	6.20	39.44	43.13	62.64	74.00	-11.36	Pk
Vertical	11491.85	42.01	6.20	39.44	43.13	44.53	54.00	-9.47	AV
Vertical	17236.30	50.20	8.07	39.38	40.20	57.46	68.20	-10.74	Pk
Horizontal	5167.44	61.43	3.91	34.43	43.27	56.51	68.20	-11.69	Pk
Horizontal	11491.08	59.08	6.20	39.44	43.13	61.60	74.00	-12.40	Pk
Horizontal	11491.08	41.26	6.20	39.44	43.13	43.78	54.00	-10.22	AV
Horizontal	17236.83	47.10	8.07	39.38	40.20	54.36	68.20	-13.84	Pk
middle Channel (5785 MHz)-Above 1G									
Vertical	5433.79	65.05	3.95	34.24	43.21	60.02	74.00	-13.98	Pk
Vertical	5433.79	46.38	3.95	34.24	43.21	41.35	54.00	-12.65	AV
Vertical	11572.21	60.61	6.24	38.90	43.11	62.65	74.00	-11.35	Pk
Vertical	11572.21	42.96	6.24	38.90	43.11	45.00	54.00	-9.00	AV
Vertical	17357.35	53.09	8.11	39.93	40.30	60.83	68.20	-7.37	Pk
Horizontal	4867.81	63.99	3.82	33.39	43.29	57.91	74.00	-16.09	Pk
Horizontal	4867.81	46.94	3.82	33.39	43.29	40.86	54.00	-13.14	AV
Horizontal	11572.19	62.45	6.24	38.90	43.11	64.49	74.00	-9.51	Pk
Horizontal	11572.19	44.18	6.24	38.90	43.11	46.22	54.00	-7.78	AV
Horizontal	17356.70	53.53	8.11	39.92	40.30	61.27	68.20	-6.93	Pk
High Channel (5825 MHz)-Above 1G									
Vertical	5244.24	66.30	3.92	34.54	43.25	61.51	68.20	-6.69	Pk
Vertical	11652.38	61.52	6.29	38.80	43.09	63.53	74.00	-10.47	Pk
Vertical	11652.38	41.54	6.29	38.80	43.09	43.55	54.00	-10.45	AV
Vertical	17473.80	54.16	8.15	40.98	40.39	62.89	68.20	-5.31	Pk
Vertical	17473.80	56.57	8.15	40.98	40.39	65.30	68.20	-2.90	Pk
Horizontal	5284.99	65.18	3.93	33.91	43.24	59.77	68.20	-8.43	Pk
Horizontal	11652.88	60.75	6.29	38.80	43.09	62.76	74.00	-11.24	Pk
Horizontal	11652.88	39.50	6.29	38.80	43.09	41.51	54.00	-12.49	AV
Horizontal	17474.72	51.80	8.15	40.99	40.40	60.54	68.20	-7.66	Pk
Horizontal	17495.68	53.29	8.15	40.99	40.40	62.03	68.20	-6.17	Pk

Note: "802.11a (5.8G)" mode is the worst mode. PK value is lower than the Average value limit, So average didn't record. The amplitude of spurious emissions that are attenuated by more than 20dB below the permissible value has no need to be reported.

Emission level (dBuV/m) = 20 log Emission level (uV/m).

Corrected Reading: Antenna Factor + Cable Loss + Read Level - Preamp Factor = Level.

**2.2.10 TEST RESULTS (18GHz-40GHz)**

EUT :	Magic Note Pad	Model Name. :	MNP1095
Temperature :	25 °C	Relative Humidity :	56%
Pressure :	1010 hPa	Test Voltage :	DC 3.85V
Test Mode :	TX (5.2G)-802.11a ;TX (5.3G)-802.11n20 TX (5.6G)-802.11ac20;TX (5.8G)-802.11a		

All the modulation modes have been tested, and the worst result was report as below:  
Low Channel (5180 MHz)-Above 1G

Horizontal

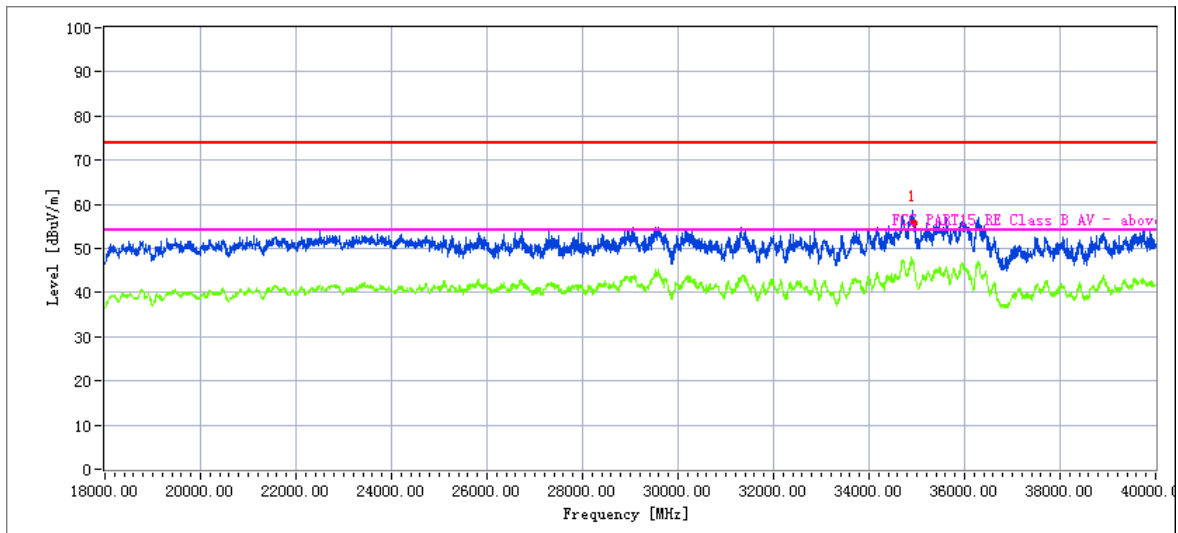

Frequency (MHz)	Meter Reading (dBuV)	Cable loss (dB)	Antenna Factor (dB/m)	Preamp Factor (dB)	Emission Level (dBuV/m)	Limits (dBuV/m)	Margin (dB)	Remark
39773.17	39.16	20.09	44.07	43.48	59.84	68.2	-8.36	Peak
39773.17	27.24	20.09	44.04	43.48	47.89	54	-6.11	AVG

Vertical

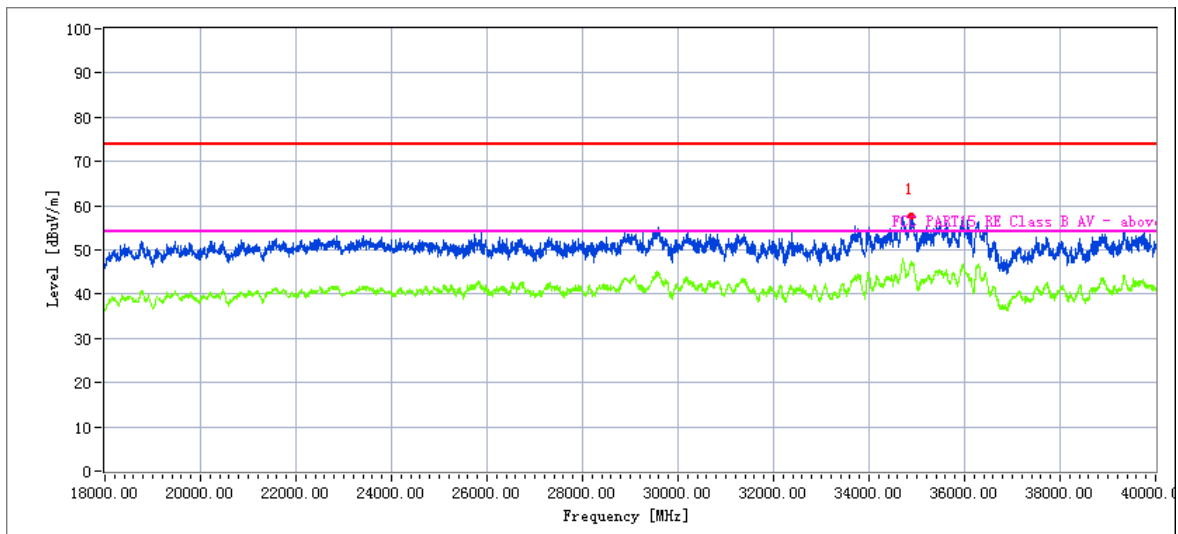

Frequency (MHz)	Meter Reading (dBuV)	Cable loss (dB)	Antenna Factor (dB/m)	Preamp Factor (dB)	Emission Level (dBuV/m)	Limits (dBuV/m)	Margin (dB)	Remark
39773.72	38.96	20.09	44.07	43.48	59.64	68.2	-8.56	Peak
39773.72	27.01	20.09	44.04	43.48	47.66	54	-6.34	AVG

### High Channel (5240 MHz)-Above 1G

Horizontal

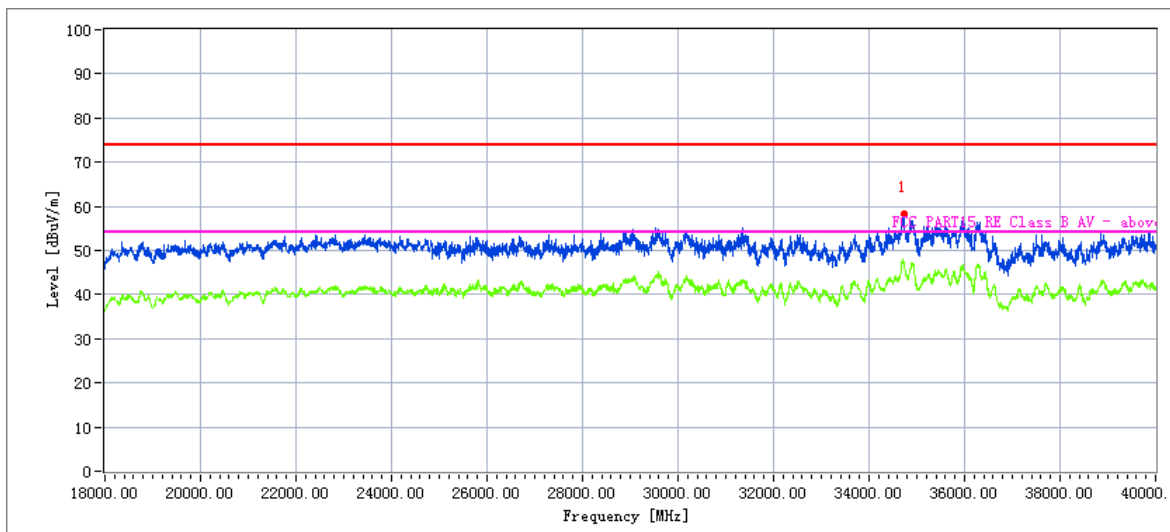

Frequency (MHz)	Meter Reading (dBuV)	Cable loss (dB)	Antenna Factor (dB/m)	Preamp Factor (dB)	Emission Level (dBuV/m)	Limits (dBuV/m)	Margin (dB)	Remark
35635.41	40.85	19.11	42.73	44.61	58.08	68.2	-10.12	Peak
35635.41	30.03	19.11	42.73	44.61	47.26	54	-6.74	AVG

Vertical

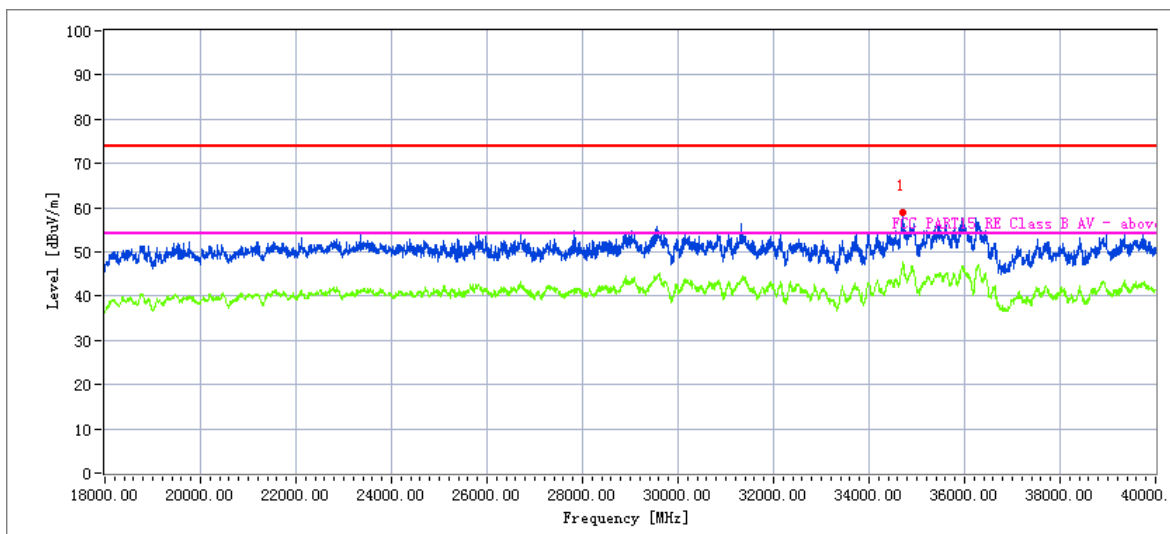

Frequency (MHz)	Meter Reading (dBuV)	Cable loss (dB)	Antenna Factor (dB/m)	Preamp Factor (dB)	Emission Level (dBuV/m)	Limits (dBuV/m)	Margin (dB)	Remark
35631.18	41.06	20.09	44.07	43.48	61.74	68.2	-6.46	Peak
35631.18	30.33	20.09	44.04	43.48	50.98	54	-3.02	AVG

Note:802.11a mode is the worst mode.

Low Channel (5260 MHz)-Above 1G

Horizontal

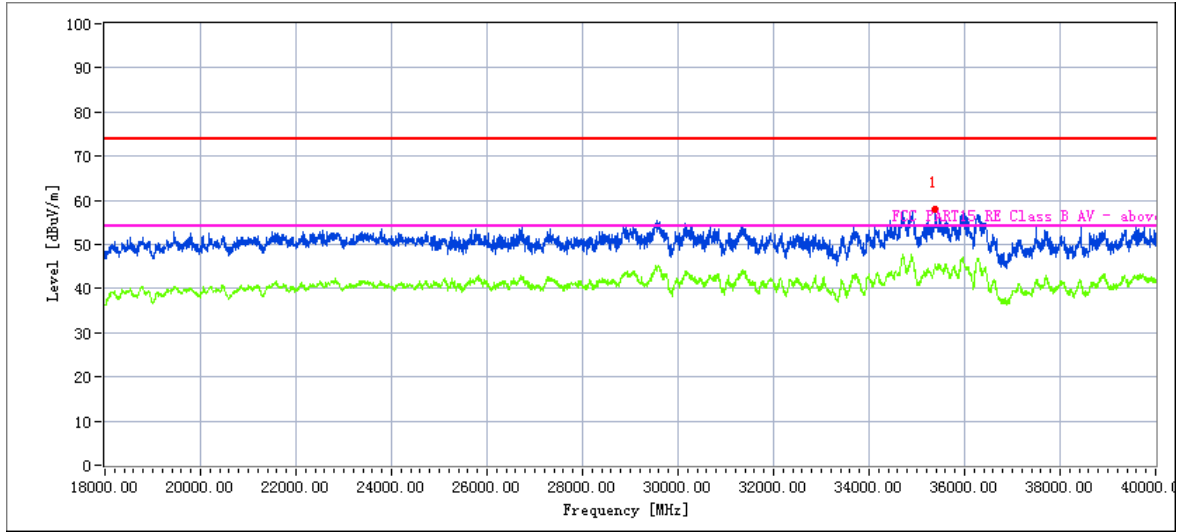

Frequency (MHz)	Meter Reading (dBuV)	Cable loss (dB)	Antenna Factor (dB/m)	Preamp Factor (dB)	Emission Level (dBuV/m)	Limits (dBuV/m)	Margin (dB)	Remark
39180.03	38.09	19.98	43.84	44.62	57.29	68.2	-10.91	Peak
39180.03	29.97	19.98	43.84	44.62	49.17	54	-4.83	AVG

Vertical

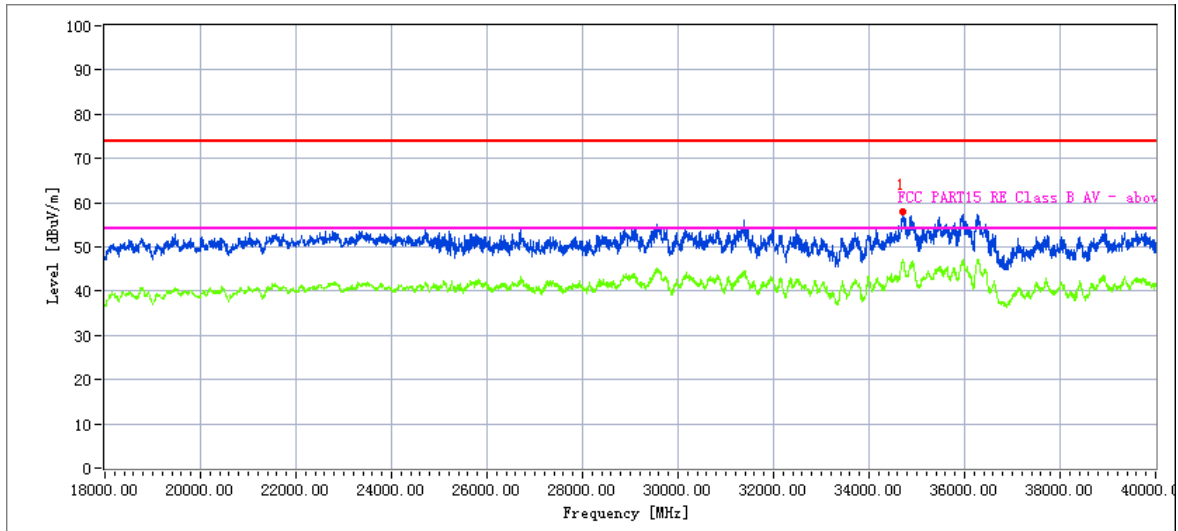

Frequency (MHz)	Meter Reading (dBuV)	Cable loss (dB)	Antenna Factor (dB/m)	Preamp Factor (dB)	Emission Level (dBuV/m)	Limits (dBuV/m)	Margin (dB)	Remark
39182.81	38.81	20.01	44.06	42.69	60.19	68.2	-8.01	Peak
39182.81	29.54	20.01	44.06	42.69	50.92	54	-3.08	AVG

### High Channel (5320 MHz)-Above 1G

Horizontal

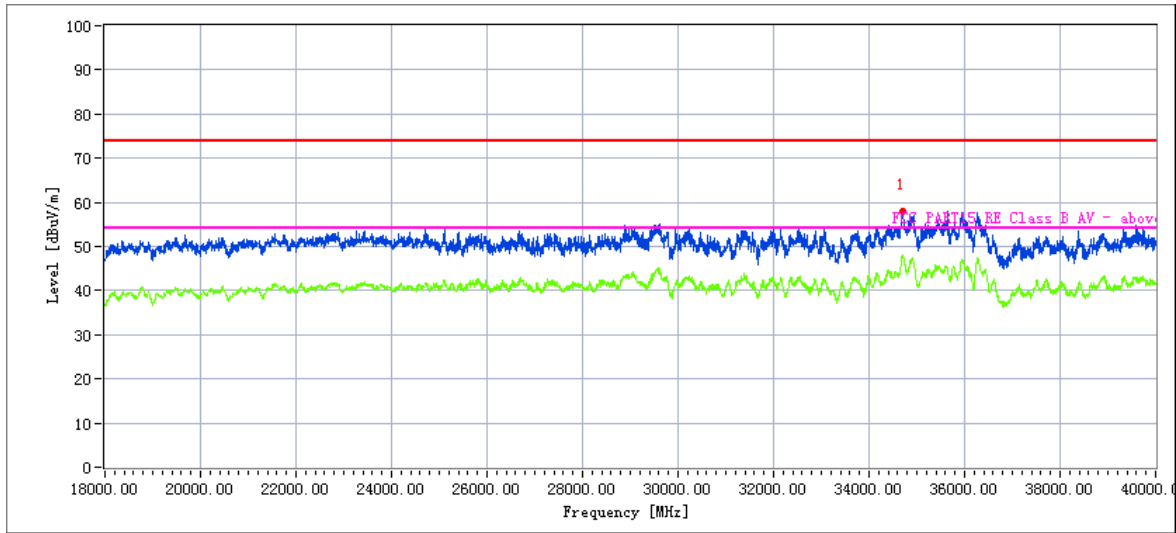

Frequency (MHz)	Meter Reading (dBuV)	Cable loss (dB)	Antenna Factor (dB/m)	Preamp Factor (dB)	Emission Level (dBuV/m)	Limits (dBuV/m)	Margin (dB)	Remark
39183.24	38.33	19.98	43.84	44.62	57.53	68.2	-10.67	Peak
39183.24	28.75	19.98	43.84	44.62	47.95	54	-6.05	AVG

Vertical

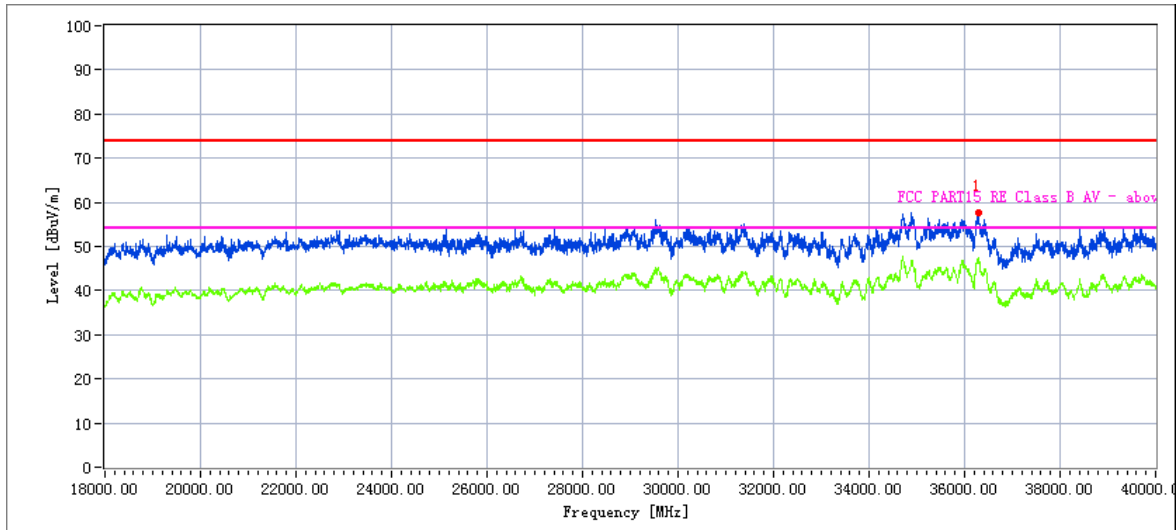

Frequency (MHz)	Meter Reading (dBuV)	Cable loss (dB)	Antenna Factor (dB/m)	Preamp Factor (dB)	Emission Level (dBuV/m)	Limits (dBuV/m)	Margin (dB)	Remark
39184.87	38.21	20.01	44.06	42.69	59.59	68.2	-8.61	Peak
39184.87	28.86	20.01	44.06	42.69	50.24	54	-3.76	AVG

Note:802.11n20 mode is the worst mode.



Low Channel (5500 MHz)-Above 1G

Horizontal

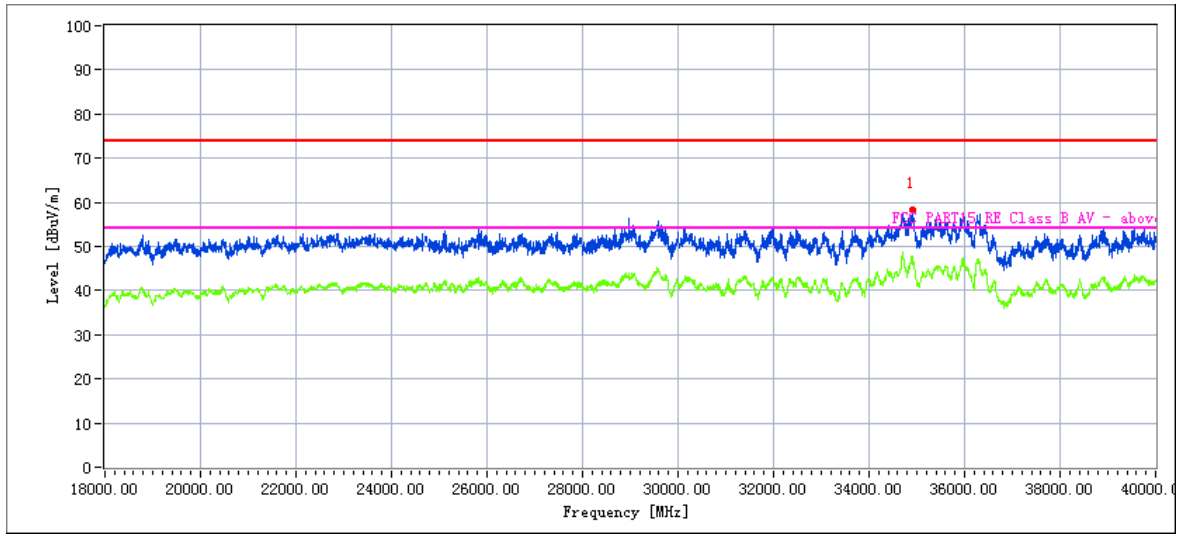

Frequency (MHz)	Meter Reading (dBuV)	Cable loss (dB)	Antenna Factor (dB/m)	Preamp Factor (dB)	Emission Level (dBuV/m)	Limits (dBuV/m)	Margin (dB)	Remark
39703.86	36.66	20.09	44.07	43.48	57.34	68.2	-10.86	Peak
39703.86	29.24	20.07	44.06	43.48	49.89	54	-4.11	AVG

Vertical

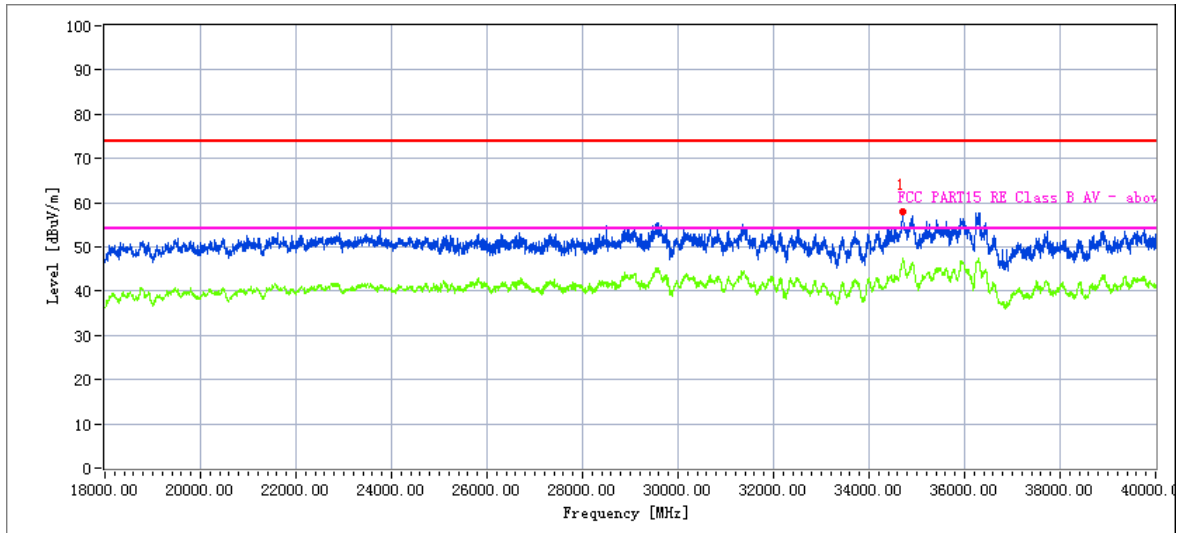

Frequency (MHz)	Meter Reading (dBuV)	Cable loss (dB)	Antenna Factor (dB/m)	Preamp Factor (dB)	Emission Level (dBuV/m)	Limits (dBuV/m)	Margin (dB)	Remark
39696.63	37.31	19.16	42.61	41.56	57.52	68.2	-10.68	Peak
39696.63	28.99	19.16	42.61	41.56	49.2	54	-4.8	AVG

### High Channel (5700 MHz)-Above 1G

Horizontal

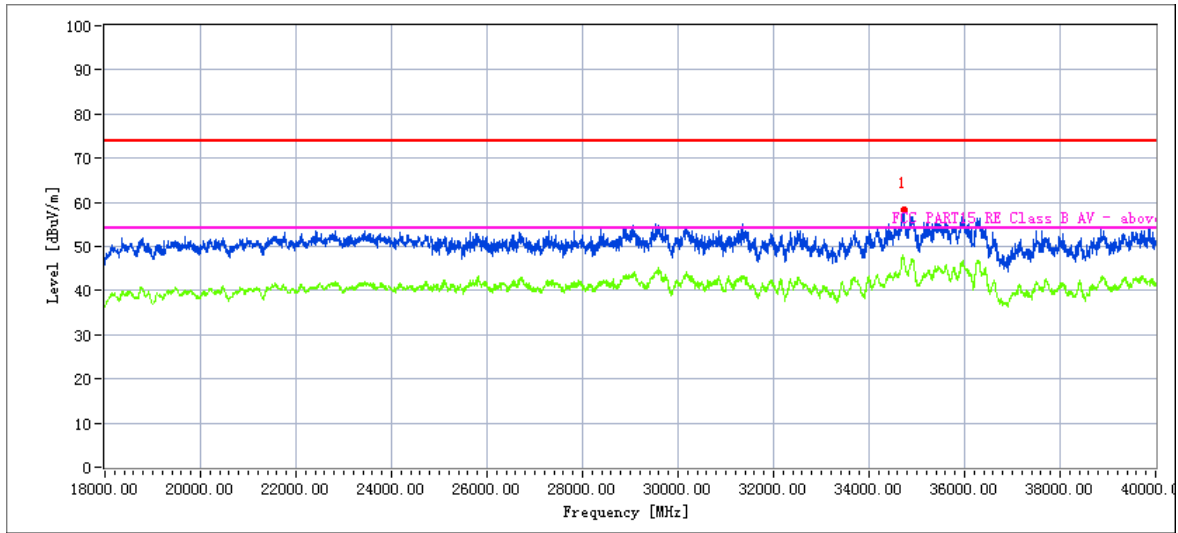

Frequency (MHz)	Meter Reading (dBuV)	Cable loss (dB)	Antenna Factor (dB/m)	Preamp Factor (dB)	Emission Level (dBuV/m)	Limits (dBuV/m)	Margin (dB)	Remark
35800.48	37.72	19.17	42.63	42.74	56.78	68.2	-11.42	Peak
35800.48	28.3	19.14	42.61	42.71	47.34	54	-6.66	AVG

Vertical

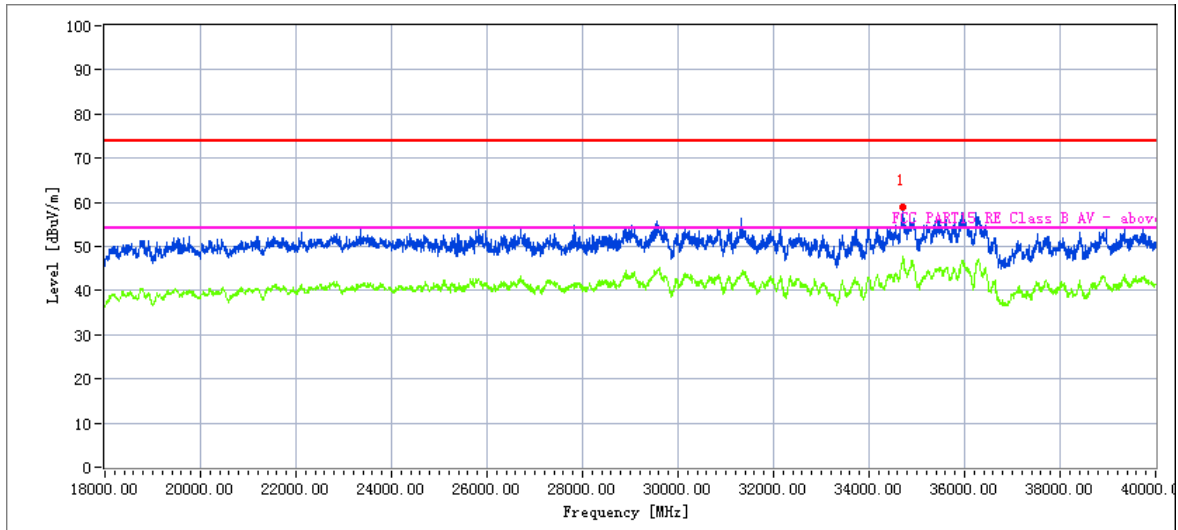

Frequency (MHz)	Meter Reading (dBuV)	Cable loss (dB)	Antenna Factor (dB/m)	Preamp Factor (dB)	Emission Level (dBuV/m)	Limits (dBuV/m)	Margin (dB)	Remark
35796.42	36.92	20.09	42.63	43.48	56.16	68.2	-12.04	Peak
35796.42	28.22	20.09	42.61	43.48	47.44	54	-6.56	AVG

Note:802.11ac20 mode is the worst mode.

Low Channel (5745 MHz)-Above 1G

Horizontal

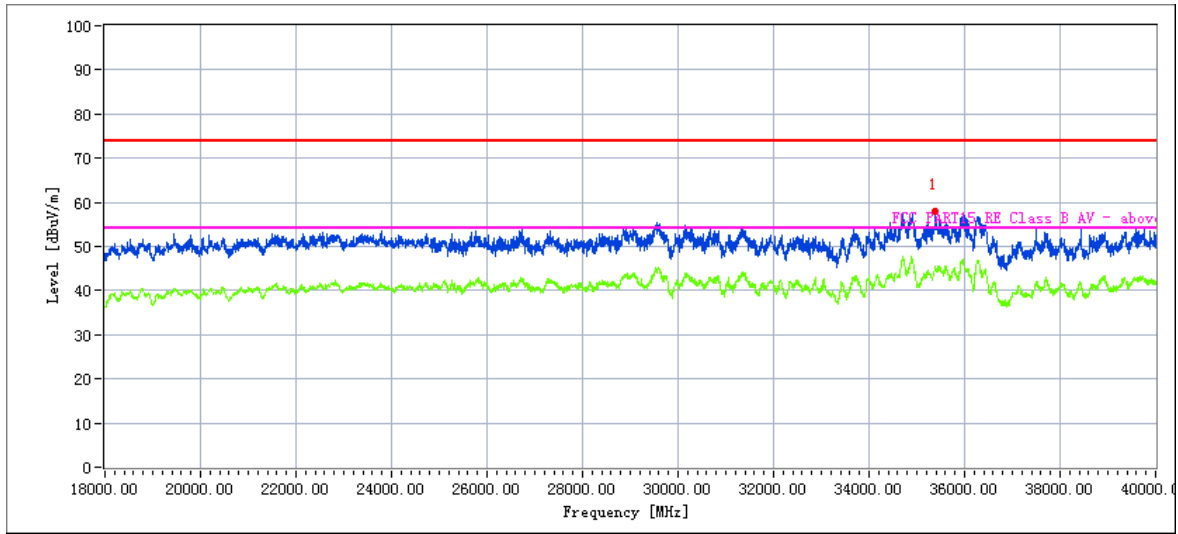

Frequency (MHz)	Meter Reading (dBuV)	Cable loss (dB)	Antenna Factor (dB/m)	Preamp Factor (dB)	Emission Level (dBuV/m)	Limits (dBuV/m)	Margin (dB)	Remark
39670.41	39.61	20.09	44.16	43.48	60.38	68.2	-7.82	Peak
39670.41	29.68	20.09	44.16	43.48	50.45	54	-3.55	AVG

Vertical

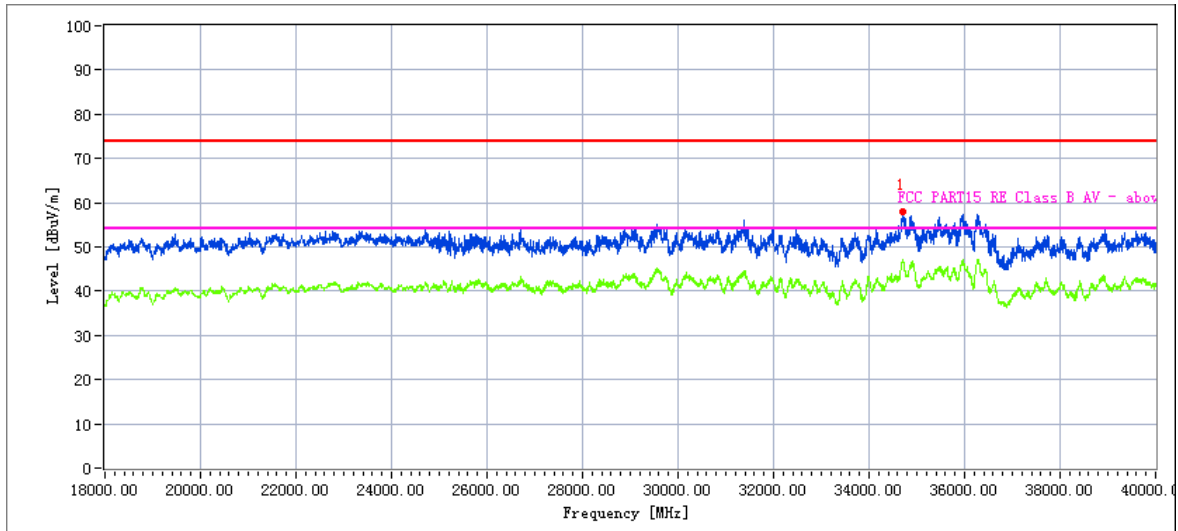

Frequency (MHz)	Meter Reading (dBuV)	Cable loss (dB)	Antenna Factor (dB/m)	Preamp Factor (dB)	Emission Level (dBuV/m)	Limits (dBuV/m)	Margin (dB)	Remark
39670.55	39.4	20.06	44.07	43.21	60.32	68.2	-7.88	Peak
39670.55	30.03	20.06	44.07	43.21	50.95	54	-3.05	AVG

### High Channel (5825 MHz)-Above 1G

Horizontal

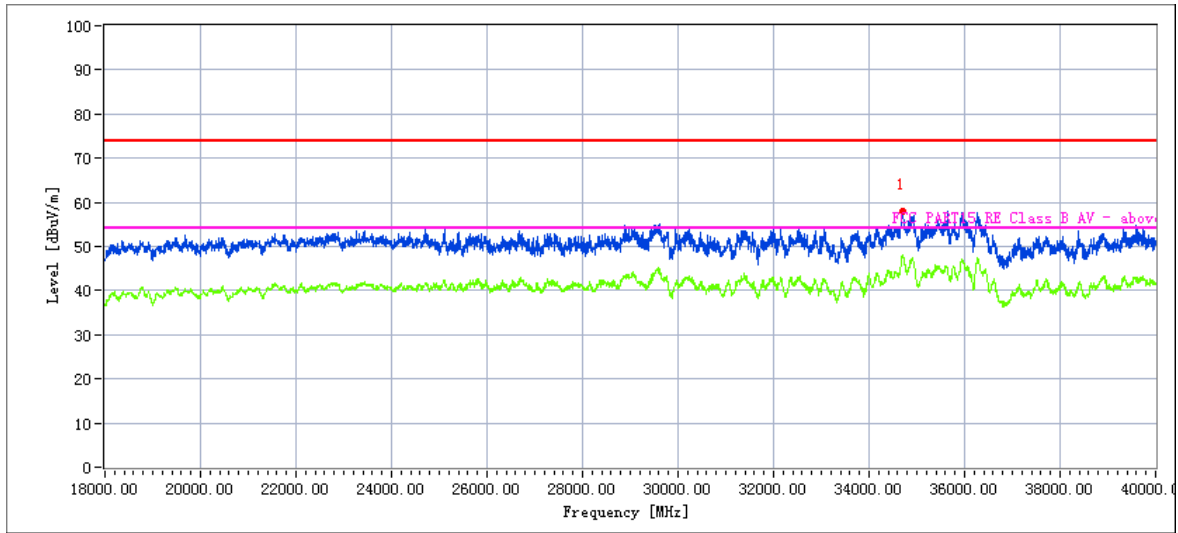

Frequency (MHz)	Meter Reading (dBuV)	Cable loss (dB)	Antenna Factor (dB/m)	Preamp Factor (dB)	Emission Level (dBuV/m)	Limits (dBuV/m)	Margin (dB)	Remark
35630.07	40.13	19.11	42.63	43.48	58.39	68.2	-9.81	Peak
35630.07	29.24	19.12	42.63	43.48	47.51	54	-6.49	AVG

Vertical

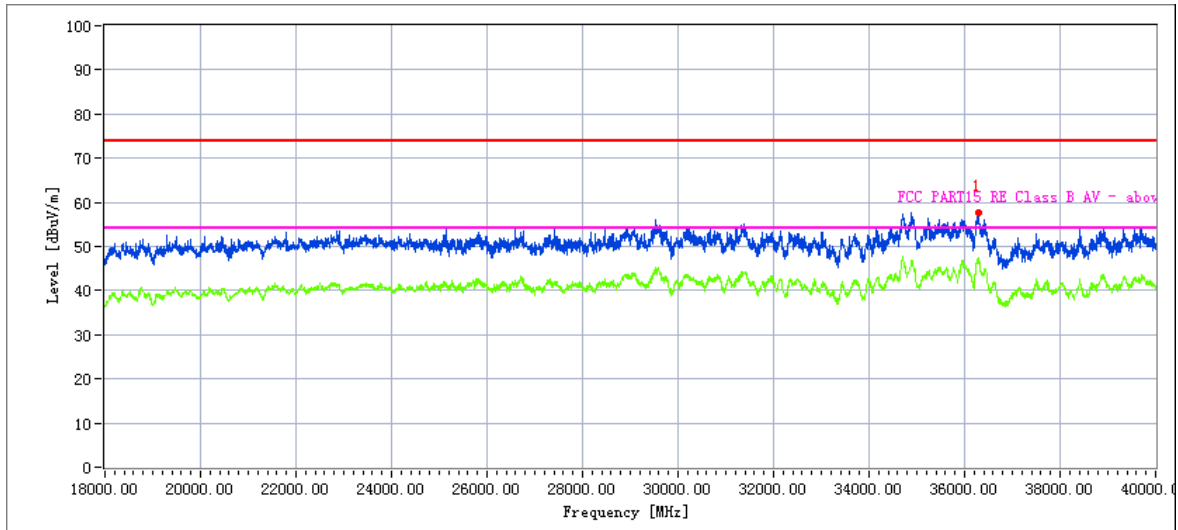

Frequency (MHz)	Meter Reading (dBuV)	Cable loss (dB)	Antenna Factor (dB/m)	Preamp Factor (dB)	Emission Level (dBuV/m)	Limits (dBuV/m)	Margin (dB)	Remark
35634.58	40.3	20.1	44.1	43.22	61.28	68.2	-6.92	Peak
35634.58	29.25	20.1	44.1	43.22	50.23	54	-3.77	AVG

Note:802.11a mode is the worst mode.

2.2.10 Spurious Emission in Restricted Band 4.5GHz~5.150 GHz& 5.350GHz~5460GHz

EUT :	Magic Note Pad	Model Name. :	MNP1095
Temperature :	25 °C	Relative Humidity :	56%
Pressure :	1010 hPa	Test Voltage :	DC 3.85V
Test Mode :	TX (5.2G)-802.11a		

All the modulation modes have been tested, The report just record the worst data mode.

Frequency	Meter Reading	Cable Loss	Antenna Factor	Preamp Factor	Emission Level	Limits	Margin	Detector	Comment
(MHz)	(dBμV)	(dB)	dB/m	(dB)	(dBμV/m)	(dBμV/m)	(dB)	Type	
Low Channel (5180 MHz)									
4500	65.44	3.615	32.6	43.25	58.41	74	-15.60	Pk	Horizontal
4500	50.26	3.615	32.6	43.25	43.23	54	-10.78	AV	Horizontal
4500	63.30	3.615	32.6	43.25	56.27	74	-17.74	Pk	Vertical
4500	48.99	3.615	32.6	43.25	41.96	54	-12.05	AV	Vertical
5150	70.65	3.911	34.6	43.27	65.89	74	-8.11	Pk	Horizontal
5150	56.11	3.911	34.6	43.27	51.35	54	-2.65	AV	Horizontal
5150	66.49	3.911	34.6	43.27	61.73	74	-12.27	Pk	Vertical
5150	51.49	3.911	34.6	43.27	46.73	54	-7.27	AV	Vertical
High Channel (5240 MHz)									
5350	72.51	3.939	33.7	43.23	66.92	74	-7.08	Pk	Vertical
5350	54.17	3.939	33.7	43.23	48.58	54	-5.42	AV	Vertical
5350	68.56	3.939	33.7	43.23	62.97	74	-11.03	Pk	Horizontal
5350	52.62	3.939	33.7	43.23	47.03	54	-6.97	AV	Horizontal

Note: (1) Emission Level= Antenna Factor + Cable Loss + Read Level - Preamp Factor

(2) "802.11a " mode is the worst mode. When PK value is lower than the Average value limit, average don't record.

EUT :	Magic Note Pad	Model Name. :	MNP1095
Temperature :	25 °C	Relative Humidity :	56%
Pressure :	1010 hPa	Test Voltage :	DC 3.85V
Test Mode :	TX (5.3G)-802.11n20		

All the modulation modes have been tested, The report just record the worst data mode.

Frequency	Meter Reading	Cable Loss	Antenna Factor	Preamp Factor	Emission Level	Limits	Margin	Detector	Comment
(MHz)	(dBμV)	(dB)	dB/m	(dB)	(dBμV/m)	(dBμV/m)	(dB)	Type	
High Channel (5320 MHz)-Above 1G									
5350.00	72.16	3.94	33.7	43.23	66.57	74.00	-7.43	Pk	Horizontal
5350.00	56.35	3.94	33.7	43.23	50.76	54.00	-3.24	AV	Horizontal
5350.00	70.05	3.94	33.7	43.23	64.46	74.00	-9.54	Pk	Vertical
5350.00	54.50	3.94	33.7	43.23	48.91	54.00	-5.09	AV	Vertical

Note: (1) Emission Level= Antenna Factor + Cable Loss + Read Level - Preamp Factor

(2) "802.11n20" mode is the worst mode. When PK value is lower than the Average value limit, average don't record.

EUT :	Magic Note Pad	Model Name. :	MNP1095
Temperature :	25 °C	Relative Humidity :	56%
Pressure :	1010 hPa	Test Voltage :	DC 3.85V
Test Mode :	TX (5.6G)-802.11ac20		

All the modulation modes have been tested, The report just record the worst data mode.

Frequency	Meter Reading	Cable Loss	Antenna Factor	Preamp Factor	Emission Level	Limits	Margin	Detector	Comment
(MHz)	(dBμV)	(dB)	dB/m	(dB)	(dBμV/m)	(dBμV/m)	(dB)	Type	
Low Channel (5500 MHz)-Above 1G									
5460.00	66.05	3.95	34.56	43.21	61.36	74.00	-12.64	Pk	Vertical
5460.00	50.55	3.95	34.56	43.21	45.86	54.00	-8.14	AV	Vertical
5460.00	70.99	3.95	34.56	43.21	66.30	74.00	-7.70	Pk	Horizontal
5460.00	55.61	3.95	34.56	43.21	50.92	54.00	-3.08	AV	Horizontal

Note: (1) Emission Level= Antenna Factor + Cable Loss + Read Level - Preamp Factor

(2) "802.11ac20" mode is the worst mode. When PK value is lower than the Average value limit, average don't record.

### 3. POWER SPECTRAL DENSITY TEST

#### 3.1 APPLIED PROCEDURES / LIMIT

##### According to FCC §15.407(a)

For the band 5.15-5.25 GHz,

(i) For an outdoor access point operating in the band 5.15-5.25 GHz, the maximum power spectral density shall not exceed 17 dBm in any 1 megahertz band. If transmitting antennas of directional gain greater than 6 dBi are used, both the maximum conducted output power and the maximum power spectral density shall be reduced by the amount in dB that the directional gain of the antenna exceeds 6 dBi. The maximum e.i.r.p. at any elevation angle above 30 degrees as measured from the horizon must not exceed 125 mW (21 dBm).

(ii) For an indoor access point operating in the band 5.15-5.25 GHz, the maximum power spectral density shall not exceed 17 dBm in any 1 megahertz band. If transmitting antennas of directional gain greater than 6 dBi are used, both the maximum conducted output power and the maximum power spectral density shall be reduced by the amount in dB that the directional gain of the antenna exceeds 6 dBi.

(iii) For fixed point-to-point access points operating in the band 5.15-5.25 GHz, the maximum power spectral density shall not exceed 17 dBm in any 1 megahertz band. Fixed point-to-point U-NII devices may employ antennas with directional gain up to 23 dBi without any corresponding reduction in the maximum conducted output power or maximum power spectral density. For fixed point-to-point transmitters that employ a directional antenna gain greater than 23 dBi, a 1 dB reduction in maximum conducted output power and maximum power spectral density is required for each 1 dB of antenna gain in excess of 23 dBi. Fixed, point-to-point operations exclude the use of point-to-multipoint systems, omnidirectional applications, and multiple collocated transmitters transmitting the same information. The operator of the U-NII device, or if the equipment is professionally installed, the installer, is responsible for ensuring that systems employing high gain directional antennas are used exclusively for fixed, point-to-point operations.

(iv) For client devices in the 5.15-5.25 GHz band, the maximum power spectral density shall not exceed 11 dBm in any 1 megahertz band. If transmitting antennas of directional gain greater than 6 dBi are used, both the maximum conducted output power and the maximum power spectral density shall be reduced by the amount in dB that the directional gain of the antenna exceeds 6 dBi.

For the 5.25-5.35 GHz and 5.47-5.725 GHz bands, the maximum conducted output power over the frequency bands of operation shall not exceed the lesser of 250 mW or  $11 \text{ dBm} + 10 \log B$ , where B is the 26 dB emission bandwidth in megahertz. In addition, the maximum power spectral density shall not exceed 11 dBm in any 1 megahertz band. If transmitting antennas of directional gain greater than 6 dBi are used, both the maximum conducted output power and the maximum power spectral density shall be reduced by the amount in dB that the directional gain of the antenna exceeds 6 dBi.

For the band 5.725-5.85 GHz

(3) For the band 5.725-5.85 GHz, the maximum power spectral density shall not exceed 30 dBm in any 500-kHz band. If transmitting antennas of directional gain greater than 6 dBi are used, both the maximum conducted output power and the maximum power spectral density shall be reduced by the amount in dB that the directional gain of the antenna exceeds 6 dBi.



### 3.2 TEST PROCEDURE

For devices operating in the bands 5.15-5.25 GHz, 5.25-5.35 GHz, and 5.47-5.725 GHz, the above procedures make use of 1 MHz RBW to satisfy directly the 1 MHz reference bandwidth specified in § 15.407(a)(5). For devices operating in the band 5.725-5.85 GHz, the rules specify a measurement bandwidth of 500 kHz. Many spectrum analyzers do not have 500 kHz RBW, thus a narrower RBW may need to be used. The rules permit the use of a RBWs less than 1 MHz, or 500 kHz, “provided that the measured power is integrated over the full reference bandwidth” to show the total power over the specified measurement bandwidth (i.e., 1 MHz, or 500 kHz). If measurements are performed using a reduced resolution bandwidth (< 1 MHz, or < 500 kHz) and integrated over 1 MHz, or 500 KHz bandwidth, the following adjustments to the procedures apply:

- a) Set  $RBW \geq 1/T$ , where T is defined in section II.B.I.a).
- b) Set  $VBW \geq 3 RBW$ .
- c) If measurement bandwidth of Maximum PSD is specified in 500 kHz, add  $10\log(500\text{kHz}/RBW)$  to the measured result, whereas  $RBW (< 500 \text{ KHz})$  is the reduced resolution bandwidth of the spectrum analyzer set during measurement.
- d) If measurement bandwidth of Maximum PSD is specified in 1 MHz, add  $10\log(1\text{MHz}/RBW)$  to the measured result, whereas  $RBW (< 1 \text{ MHz})$  is the reduced resolution bandwidth of spectrum analyzer set during measurement.
- e) Care must be taken to ensure that the measurements are performed during a period of continuous transmission or are corrected upward for duty cycle.

Note: As a practical matter, it is recommended to use reduced RBW of 100 KHz for the sections 5.c) and 5.d) above, since  $RBW=100 \text{ KHz}$  is available on nearly all spectrum analyzers.

### 3.3 DEVIATION FROM STANDARD

No deviation.

### 3.4 TEST SETUP



### 3.5 EUT OPERATION CONDITIONS

The EUT tested system was configured as the statements of 2.1 Unless otherwise a special operating condition is specified in the follows during the testing.

**3.6 TEST RESULTS**

EUT :	Magic Note Pad	Model Name :	MNP1095
Temperature :	25 °C	Relative Humidity :	56%
Pressure :	1015 hPa	Test Voltage :	DC 3.85V
Test Mode :	TX Frequency Band 1 (5150-5250MHz), Band 2A (5250-5350MHz), Band 2C (5470-5725MHz), Band 3 (5745-5825MHz)		

Test data reference attachment.

## 4. 26DB & 99% EMISSION BANDWIDTH

### 4.1 APPLIED PROCEDURES / LIMIT

The maximum power spectral density is measured as a conducted emission by direct connection of a calibrated test instrument to the equipment under test. If the device cannot be connected directly, alternative techniques acceptable to the Commission may be used. Measurements in the 5.725-5.85 GHz band are made over a reference bandwidth of 500 kHz or the 26 dB emission bandwidth of the device, whichever is less. Measurements in the 5.15-5.25 GHz, 5.25-5.35 GHz, and the 5.47-5.725 GHz bands are made over a bandwidth of 1 MHz or the 26 dB emission bandwidth of the device, whichever is less. A narrower resolution bandwidth can be used, provided that the measured power is integrated over the full reference bandwidth.

### 4.2 TEST PROCEDURE

- a) Set RBW = approximately 1% of the emission bandwidth.
- b) Set the VBW > RBW.
- c) Detector = Peak.
- d) Trace mode = max hold.
- e) Measure the maximum width of the emission that is 26 dB down from the maximum of the emission. Compare this with the RBW setting of the analyzer. Readjust RBW and repeat measurement as needed until the RBW/EBW ratio is approximately 1%.

The following procedure shall be used for measuring (99 %) power bandwidth:

1. Set center frequency to the nominal EUT channel center frequency.
2. Set span = 1.5 times to 5.0 times the OBW.
3. Set RBW = 1 % to 5 % of the OBW
4. Set VBW  $\geq 3 \cdot$  RBW
5. Video averaging is not permitted. Where practical, a sample detection and single sweep mode shall be used. Otherwise, peak detection and max hold mode (until the trace stabilizes) shall be used.
6. Use the 99 % power bandwidth function of the instrument (if available).
7. If the instrument does not have a 99 % power bandwidth function, the trace data points are recovered and directly summed in power units. The recovered amplitude data points, beginning at the lowest frequency, are placed in a running sum until 0.5 % of the total is reached; that frequency is recorded as the lower frequency. The process is repeated until 99.5 % of the total is reached; that frequency is recorded as the upper frequency. The 99% occupied bandwidth is the difference between these two frequencies.

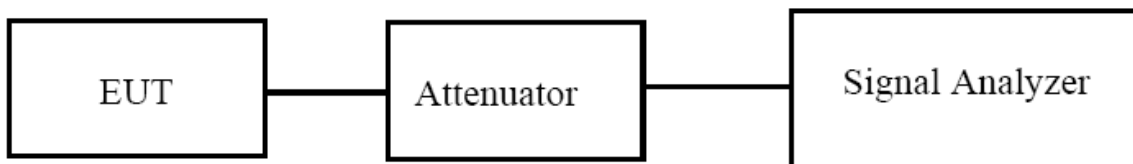

**4.3 EUT OPERATION CONDITIONS**

The EUT tested system was configured as the statements of 2.4 Unless otherwise a special operating condition is specified in the follows during the testing.

**4.4 TEST RESULTS**

EUT :	Magic Note Pad	Model Name :	MNP1095
Temperature :	25 °C	Relative Humidity :	56%
Pressure :	1012 hPa	Test Voltage :	DC 3.85V
Test Mode :	TX Frequency Band 1 (5150-5250MHz), Band 2A (5250-5350MHz), Band 2C(5470-5725MHz), Band 3(5725-5850MHz)		

Test data reference attachment.

**5. MINIMUM 6 DB BANDWIDTH**

**5.1 APPLIED PROCEDURES / LIMIT**

**According to FCC §15.407(e)**

(e) Within the 5.725-5.85 GHz band, the minimum 6 dB bandwidth of U-NII devices shall be at least 500 kHz.

**5.2 TEST PROCEDURE**

Section 15.407(e) specifies the minimum 6 dB emission bandwidth of at least 500 KHz for the band 5.715-5.85 GHz. The following procedure shall be used for measuring this bandwidth:

- a) Set RBW = 100 kHz.
- b) Set the video bandwidth (VBW)  $\geq 3 \times$  RBW.
- c) Detector = Peak.
- d) Trace mode = max hold.
- e) Sweep = auto couple.
- f) Allow the trace to stabilize.
- g) Measure the maximum width of the emission that is constrained by the frequencies associated with the two outermost amplitude points (upper and lower frequencies) that are attenuated by 6 dB relative to the maximum level measured in the fundamental emission.

**5.3 DEVIATION FROM STANDARD**

No deviation.

**5.4 TEST SETUP**

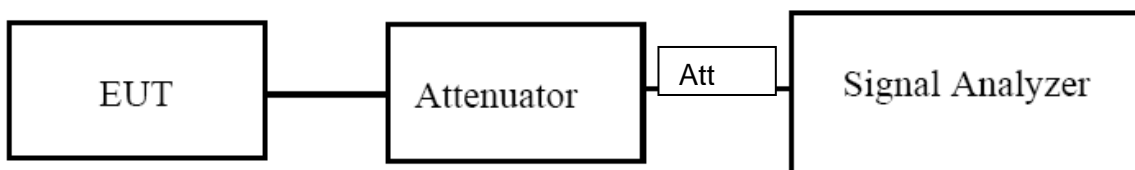

**5.5 EUT OPERATION CONDITIONS**

The EUT tested system was configured as the statements of 2.4 Unless otherwise a special operating condition is specified in the follows during the testing.

**5.6 TEST RESULTS**

EUT :	Magic Note Pad	Model Name :	MNP1095
Temperature :	25 °C	Relative Humidity :	56%
Pressure :	1012 hPa	Test Voltage :	DC 3.85V
Test Mode :	TX (5G) Mode Frequency Band 3 (5725-5850MHz)		

Test data reference attachment.

## 6. MAXIMUM CONDUCTED OUTPUT POWER

### 6.1 APPLIED PROCEDURES / LIMIT

#### According to FCC §15.407

The maximum conducted output power should not exceed:

Frequency Band(MHz)	Limit
5150~5250	250mW
5250~5350	250 mW or 11 dBm + 10 log B Note: The limit is the smaller of the two, "B" represents -26dB bandwidth.
5470~5725	250 mW or 11 dBm + 10 log B Note: The limit is the smaller of the two, "B" represents -26dB bandwidth.
5725~5850	1W

### 6.2 TEST PROCEDURE

- Method PM-G is measurement using a gated RF average power meter. Measurements may be performed using a wideband gated RF power meter provided that the gate parameters are adjusted such that the power is measured only when the EUT is transmitting at its maximum power control level. Because the measurement is made only during the ON time of the transmitter, no duty cycle correction factor is required.

### 6.3 DEVIATION FROM STANDARD

No deviation.

### 6.4 TEST SETUP

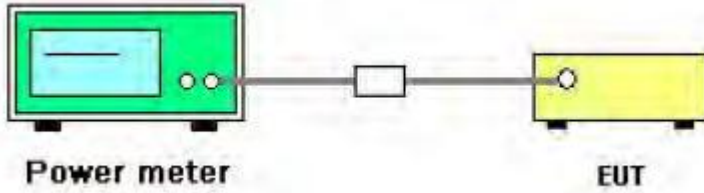

### 6.5 EUT OPERATION CONDITIONS

The EUT tested system was configured as the statements of 2.4 Unless otherwise a special operating condition is specified in the follows during the testing.



**6.2 TEST RESULTS**

EUT :	Magic Note Pad	Model Name :	MNP1095
Temperature :	25 °C	Relative Humidity :	56%
Pressure :	1012 hPa	Test Voltage :	DC 3.85V
Test Mode :	TX (5G) Mode Frequency Band 1 (5150-5250MHz), Band 2A (5250-5350MHz) Band 2C, (5470-5725MHz), Band 3 (5725-5850MHz)		

Test data reference attachment.

## 7. OUT OF BAND EMISSIONS

### 7.1 APPLICABLE STANDARD

#### According to FCC §15.407(b)

Undesirable emission limits. Except as shown in paragraph (b)(7) of this section, the maximum emissions outside of the frequency bands of operation shall be attenuated in accordance with the following limits:

- (1) For transmitters operating in the 5.15-5.25 GHz band: All emissions outside of the 5.15-5.35 GHz band shall not exceed an e.i.r.p. of  $-27$  dBm/MHz.
- (2) For transmitters operating in the 5.25-5.35 GHz band: All emissions outside of the 5.15-5.35 GHz band shall not exceed an e.i.r.p. of  $-27$  dBm/MHz.
- (3) For transmitters operating in the 5.47-5.725 GHz band: All emissions outside of the 5.47-5.725 GHz band shall not exceed an e.i.r.p. of  $-27$  dBm/MHz.
- (4) For transmitters operating in the 5.725-5.85 GHz band:
  - (i) All emissions shall be limited to a level of  $-27$  dBm/MHz at 75 MHz or more above or below the band edge increasing linearly to 10 dBm/MHz at 25 MHz above or below the band edge, and from 25 MHz above or below the band edge increasing linearly to a level of 15.6 dBm/MHz at 5 MHz above or below the band edge, and from 5 MHz above or below the band edge increasing linearly to a level of 27 dBm/MHz at the band edge.
  - (ii) Devices certified before March 2, 2017 with antenna gain greater than 10 dBi may demonstrate compliance with the emission limits in §15.247(d), but manufacturing, marketing and importing of devices certified under this alternative must cease by March 2, 2018. Devices certified before March 2, 2018 with antenna gain of 10 dBi or less may demonstrate compliance with the emission limits in §15.247(d), but manufacturing, marketing and importing of devices certified under this alternative must cease before March 2, 2020.

### 7.2 TEST PROCEDURE

1. Check the calibration of the measuring instrument using either an internal calibrator or a known signal from an external generator.
2. Position the EUT without connection to measurement instrument. Turn on the EUT and connect its antenna terminal to measurement instrument via a low loss cable. Then set it to any one measured frequency within its operating range, and make sure the instrument is operated in its linear range.

3. Set RBW of spectrum analyzer to 1 MHz with a convenient frequency span.
4. Measure the highest amplitude appearing on spectral display and set it as a reference level. Plot the graph with marking the highest point and edge frequency.
5. Repeat above procedures until all measured frequencies were complete.

### 7.3 DEVIATION FROM STANDARD

No deviation.

### 7.4 TEST SETUP

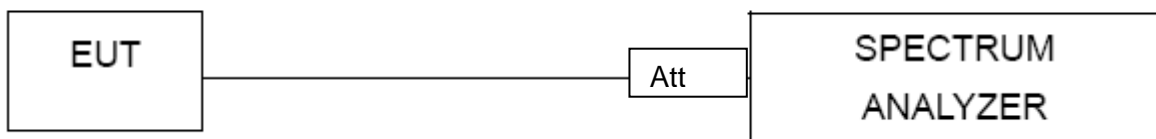

### 7.5 EUT OPERATION CONDITIONS

The EUT tested system was configured as the statements of 2.4 Unless otherwise a special operating condition is specified in the follows during the testing.

### 7.6 TEST RESULTS

EUT :	Magic Note Pad	Model Name :	MNP1095
Temperature :	25 °C	Relative Humidity :	56%
Pressure :	1012 hPa	Test Voltage :	DC 3.85V

Test data reference attachment.

## 8. Frequency Stability Measurement

### 8.1 LIMIT

Manufactures of U-NII devices are responsible for ensuring frequency stability such that an emission is maintained within the band of operation under all conditions of normal operation as specified in the user's manual.

### 8.2 TEST PROCEDURES

1. The transmitter output (antenna port) was connected to the spectrum analyzer.
2. EUT have transmitted absence of modulation signal and fixed channelize.
3. Set the spectrum analyzer span to view the entire absence of modulation emissions bandwidth.
4. Set RBW = 10 kHz, VBW = 10 kHz with peak detector and maxhold settings.
5.  $f_c$  is declaring of channel frequency. Then the frequency error formula is  $(f_c - f) / f_c \times 10^6$  ppm and the limit is less than  $\pm 20$  ppm (IEEE 802.11 specification).
6. The test extreme voltage is to change the primary supply voltage from 85 to 115 percent of the nominal value
7. Extreme temperature is  $-20^\circ\text{C} \sim 70^\circ\text{C}$ .

### 8.3 TEST SETUP LAYOUT

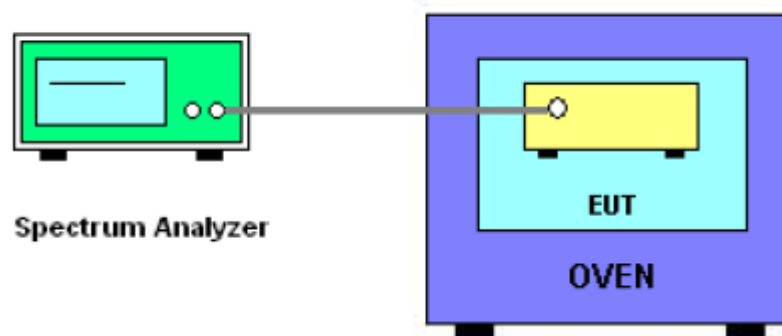

### 8.4 EUT OPERATION DURING TEST

1. The EUT was programmed to be in continuously un-modulation transmitting mode.
2. The module has two antennas, and the worst data is Antenna 1, only shown Antenna 1 Plot.

8.5 TEST RESULTS

EUT :	Magic Note Pad	Model Name. :	MNP1095
Temperature :	25 °C	Relative Humidity :	56%
Pressure :	1012 hPa	Test Voltage :	DC 3.85V
Test Mode :	TX Frequency Band I (5150-5250MHz)		

Voltage vs. Frequency Stability

TEST CONDITIONS				Reference Frequency: 5180MHz			
				f	fc	Max. Deviation (MHz)	Max. Deviation (ppm)
T nom (°C)	20	V nom (V)	3.85	5180.0228	5180	0.0228	4.4015
		V max (V)	4.43	5180.0073	5180	0.0073	1.4093
		V min (V)	3.27	5180.0278	5180	0.0278	5.3668
Limits				Within 5150-5250MHz			
Result				Complies			

Temperature vs. Frequency Stability

TEST CONDITIONS				Reference Frequency: 5180MHz			
				f	fc	Max. Deviation (MHz)	Max. Deviation (ppm)
V nom (V)	3.87	T (°C)	-20	5180.0080	5180	0.0080	1.5444
		T (°C)	-10	5180.0251	5180	0.0251	4.8456
		T (°C)	0	5180.0273	5180	0.0273	5.2703
		T (°C)	10	5180.0087	5180	0.0087	1.6795
		T (°C)	20	5180.0105	5180	0.0105	2.0270
		T (°C)	30	5180.0113	5180	0.0113	2.1815
		T (°C)	40	5180.0288	5180	0.0288	5.5598
		T (°C)	50	5180.0041	5180	0.0041	0.7915
		T (°C)	60	5180.0327	5180	0.0327	6.3127
		T (°C)	70	5180.0257	5180	0.0257	4.9614
Limits				Within 5150-5250MHz			
Result				Complies			

Voltage vs. Frequency Stability

TEST CONDITIONS				Reference Frequency: 5200MHz			
				f	fc	Max. Deviation (MHz)	Max. Deviation (ppm)
T nom (°C)	20	V nom (V)	3.85	5200.0120	5200	0.0120	2.3077
		V max (V)	4.43	5200.0015	5200	0.0015	0.2885
		V min (V)	3.27	5200.0041	5200	0.0041	0.7885
Limits				Within 5150-5250MHz			
Result				Complies			

Temperature vs. Frequency Stability

TEST CONDITIONS				Reference Frequency: 5200MHz			
				f	fc	Max. Deviation (MHz)	Max. Deviation (ppm)
V nom (V)	3.87	T (°C)	-20	5200.0019	5200	0.0019	0.3654
		T (°C)	-10	5200.0199	5200	0.0199	3.8269
		T (°C)	0	5200.0152	5200	0.0152	2.9231
		T (°C)	10	5200.0192	5200	0.0192	3.6923
		T (°C)	20	5200.0194	5200	0.0194	3.7308
		T (°C)	30	5200.0020	5200	0.0020	0.3846
		T (°C)	40	5200.0144	5200	0.0144	2.7692
		T (°C)	50	5200.0333	5200	0.0333	6.4038
		T (°C)	60	5200.0184	5200	0.0184	3.5385
		T (°C)	70	5200.0222	5200	0.0222	4.2692
Limits				Within 5150-5250MHz			
Result				Complies			

Voltage vs. Frequency Stability

TEST CONDITIONS				Reference Frequency: 5240MHz			
				f	fc	Max. Deviation (MHz)	Max. Deviation (ppm)
T nom (°C)	20	V nom (V)	3.85	5240.0155	5240	0.0155	2.9580
		V max (V)	4.43	5240.0081	5240	0.0081	1.5458
		V min (V)	3.27	5240.0097	5240	0.0097	1.8511
Limits				Within 5150-5250MHz			
Result				Complies			

Temperature vs. Frequency Stability

TEST CONDITIONS				Reference Frequency: 5240MHz			
				f	fc	Max. Deviation (MHz)	Max. Deviation (ppm)
V nom (V)	3.87	T (°C)	-20	5240.0184	5240	0.0184	3.5115
		T (°C)	-10	5240.0075	5240	0.0075	1.4313
		T (°C)	0	5240.0204	5240	0.0204	3.8931
		T (°C)	10	5240.0202	5240	0.0202	3.8550
		T (°C)	20	5240.0113	5240	0.0113	2.1565
		T (°C)	30	5240.0186	5240	0.0186	3.5496
		T (°C)	40	5240.0335	5240	0.0335	6.3931
		T (°C)	50	5240.0332	5240	0.0332	6.3359
		T (°C)	60	5240.0040	5240	0.0040	0.7634
		T (°C)	70	5240.0075	5240	0.0075	1.4313
Limits				Within 5150-5250MHz			
Result				Complies			



EUT :	Magic Note Pad	Model Name. :	MNP1095
Temperature :	25 °C	Relative Humidity :	56%
Pressure :	1012 hPa	Test Voltage :	DC 3.85V
Test Mode :	TX Frequency Band 2A (5250-5350MHz)		

Voltage vs. Frequency Stability

TEST CONDITIONS				Reference Frequency: 5260MHz			
				f	fc	Max. Deviation (MHz)	Max. Deviation (ppm)
T nom (°C)	20	V nom (V)	3.85	5260.0039	5260	0.00390	0.7414
		V max (V)	4.43	5260.0161	5260	0.01610	3.0608
		V min (V)	3.27	5260.0119	5260	0.01190	2.2624
Limits				Within 5250-5350MHz			
Result				Complies			

Temperature vs. Frequency Stability

TEST CONDITIONS				Reference Frequency: 5260MHz			
				f	fc	Max. Deviation (MHz)	Max. Deviation (ppm)
V nom (V)	3.85	T (°C)	-20	5260.0222	5260	0.02220	4.2205
		T (°C)	-10	5260.0113	5260	0.01130	2.1483
		T (°C)	0	5260.0286	5260	0.02860	5.4373
		T (°C)	10	5260.0112	5260	0.01120	2.1293
		T (°C)	20	5260.0292	5260	0.02920	5.5513
		T (°C)	30	5260.0080	5260	0.00800	1.5209
		T (°C)	40	5260.0137	5260	0.01370	2.6046
		T (°C)	50	5260.0321	5260	0.03210	6.1027
		T (°C)	60	5260.0355	5260	0.03550	6.7490
		T (°C)	70	5260.0203	5260	0.02030	3.8593
Limits				Within 5250-5350MHz			
Result				Complies			

Voltage vs. Frequency Stability

TEST CONDITIONS				Reference Frequency: 5280MHz			
				f	fc	Max. Deviation (MHz)	Max. Deviation (ppm)
T nom (°C)	20	V nom (V)	3.85	5280.0206	5280	0.02060	3.9015
		V max (V)	4.43	5280.0303	5280	0.03030	5.7386
		V min (V)	3.27	5280.0195	5280	0.01950	3.6932
Limits				Within 5250-5350MHz			
Result				Complies			

Temperature vs. Frequency Stability

TEST CONDITIONS				Reference Frequency: 5280MHz			
				f	fc	Max. Deviation (MHz)	Max. Deviation (ppm)
V nom (V)	3.85	T (°C)	-20	5280.0189	5280	0.01890	3.5795
		T (°C)	-10	5280.0125	5280	0.01250	2.3674
		T (°C)	0	5280.0170	5280	0.01700	3.2197
		T (°C)	10	5280.0317	5280	0.03170	6.0038
		T (°C)	20	5280.0228	5280	0.02280	4.3182
		T (°C)	30	5280.0327	5280	0.03270	6.1932
		T (°C)	40	5280.0149	5280	0.01490	2.8220
		T (°C)	50	5280.0274	5280	0.02740	5.1894
		T (°C)	60	5280.0224	5280	0.02240	4.2424
		T (°C)	70	5280.0264	5280	0.02640	5.0000
Limits				Within 5250-5350MHz			
Result				Complies			

Voltage vs. Frequency Stability

TEST CONDITIONS				Reference Frequency: 5320MHz			
				f	fc	Max. Deviation (MHz)	Max. Deviation (ppm)
T nom (°C)	20	V nom (V)	3.85	5320.0265	5320	0.02650	4.9812
		V max (V)	4.43	5320.0109	5320	0.01090	2.0489
		V min (V)	3.27	5320.0242	5320	0.02420	4.5489
Limits				Within 5250-5350MHz			
Result				Complies			

Temperature vs. Frequency Stability

TEST CONDITIONS				Reference Frequency: 5320MHz			
				f	fc	Max. Deviation (MHz)	Max. Deviation (ppm)
V nom (V)	3.85	T (°C)	-20	5320.0382	5320	0.03820	7.1805
		T (°C)	-10	5320.0201	5320	0.02010	3.7782
		T (°C)	0	5320.0263	5320	0.02630	4.9436
		T (°C)	10	5320.0361	5320	0.03610	6.7857
		T (°C)	20	5320.0196	5320	0.01960	3.6842
		T (°C)	30	5320.0244	5320	0.02440	4.5865
		T (°C)	40	5320.0106	5320	0.01060	1.9925
		T (°C)	50	5320.0095	5320	0.00950	1.7857
		T (°C)	60	5320.0173	5320	0.01730	3.2519
		T (°C)	70	5320.0076	5320	0.00760	1.4286
Limits				Within 5250-5350MHz			
Result				Complies			

EUT :	Magic Note Pad	Model Name. :	MNP1095
Temperature :	25 °C	Relative Humidity :	56%
Pressure :	1012 hPa	Test Voltage :	DC 3.85V
Test Mode :	TX Frequency Band 2C (5470-5725MHz)		

Voltage vs. Frequency Stability

TEST CONDITIONS				Reference Frequency: 5500MHz			
				f	fc	Max. Deviation (MHz)	Max. Deviation (ppm)
T nom (°C)	20	V nom (V)	3.85	5500.0149	5500	0.01490	2.7091
		V max (V)	4.43	5500.0015	5500	0.00150	0.2727
		V min (V)	3.27	5500.0213	5500	0.02130	3.8727
Limits				Within 5470-5725MHz			
Result				Complies			

Temperature vs. Frequency Stability

TEST CONDITIONS				Reference Frequency: 5500MHz			
				f	fc	Max. Deviation (MHz)	Max. Deviation (ppm)
V nom (V)	3.85	T (°C)	-20	5500.0127	5500	0.01270	2.3091
		T (°C)	-10	5500.0276	5500	0.02760	5.0182
		T (°C)	0	5500.0137	5500	0.01370	2.4909
		T (°C)	10	5500.0209	5500	0.02090	3.8000
		T (°C)	20	5500.0104	5500	0.01040	1.8909
		T (°C)	30	5500.0214	5500	0.02140	3.8909
		T (°C)	40	5500.0367	5500	0.03670	6.6727
		T (°C)	50	5500.0185	5500	0.01850	3.3636
		T (°C)	60	5500.0125	5500	0.01250	2.2727
		T (°C)	70	5500.0221	5500	0.02210	4.0182
Limits				Within 5470-5725MHz			
Result				Complies			

Voltage vs. Frequency Stability

TEST CONDITIONS				Reference Frequency: 5600MHz			
				f	fc	Max. Deviation (MHz)	Max. Deviation (ppm)
T nom (°C)	20	V nom (V)	3.85	5600.0190	5600	0.01900	3.3929
		V max (V)	4.43	5600.0445	5600	0.04450	7.9464
		V min (V)	3.27	5600.0087	5600	0.00870	1.5536
Limits				Within 5470-5725MHz			
Result				Complies			

Temperature vs. Frequency Stability

TEST CONDITIONS				Reference Frequency: 5600MHz			
				f	fc	Max. Deviation (MHz)	Max. Deviation (ppm)
V nom (V)	3.85	T (°C)	-20	5600.0271	5600	0.02710	4.8393
		T (°C)	-10	5600.0259	5600	0.02590	4.6250
		T (°C)	0	5600.0223	5600	0.02230	3.9821
		T (°C)	10	5600.0114	5600	0.01140	2.0357
		T (°C)	20	5600.0073	5600	0.00730	1.3036
		T (°C)	30	5600.0107	5600	0.01070	1.9107
		T (°C)	40	5600.0067	5600	0.00670	1.1964
		T (°C)	50	5600.0029	5600	0.00290	0.5179
		T (°C)	60	5600.0294	5600	0.02940	5.2500
		T (°C)	70	5600.0362	5600	0.03620	6.4643
Limits				Within 5470-5725MHz			
Result				Complies			

Voltage vs. Frequency Stability

TEST CONDITIONS				Reference Frequency: 5700MHz			
				f	fc	Max. Deviation (MHz)	Max. Deviation (ppm)
T nom (°C)	20	V nom (V)	3.85	5700.0075	5700	0.00750	1.3158
		V max (V)	4.43	5700.0434	5700	0.04340	7.6140
		V min (V)	3.27	5700.0251	5700	0.02510	4.4035
Limits				Within 5470-5725MHz			
Result				Complies			

Temperature vs. Frequency Stability

TEST CONDITIONS				Reference Frequency: 5700MHz			
				f	fc	Max. Deviation (MHz)	Max. Deviation (ppm)
V nom (V)	3.85	T (°C)	-20	5700.0323	5700	0.03230	5.6667
		T (°C)	-10	5700.0230	5700	0.02300	4.0351
		T (°C)	0	5700.0219	5700	0.02190	3.8421
		T (°C)	10	5700.0169	5700	0.01690	2.9649
		T (°C)	20	5700.0101	5700	0.01010	1.7719
		T (°C)	30	5700.0330	5700	0.03300	5.7895
		T (°C)	40	5700.0057	5700	0.00570	1.0000
		T (°C)	50	5700.0085	5700	0.00850	1.4912
		T (°C)	60	5700.0161	5700	0.01610	2.8246
		T (°C)	70	5700.0286	5700	0.02860	5.0175
Limits				Within 5470-5725MHz			
Result				Complies			

EUT :	Magic Note Pad	Model Name. :	MNP1095
Temperature :	25 °C	Relative Humidity :	56%
Pressure :	1012 hPa	Test Voltage :	DC 3.85V
Test Mode :	TX Frequency(5745-5850MHz)		

Voltage vs. Frequency Stability

TEST CONDITIONS				Reference Frequency: 5745MHz			
				f	fc	Max. Deviation (MHz)	Max. Deviation (ppm)
T nom (°C)	20	V nom (V)	3.85	5745.0124	5745	0.01240	2.1584
		V max (V)	4.43	5745.0356	5745	0.03560	6.1967
		V min (V)	3.27	5745.0173	5745	0.01730	3.0113
Limits				Within 5745-5850MHz			
Result				Complies			

Temperature vs. Frequency Stability

TEST CONDITIONS				Reference Frequency: 5745MHz			
				f	fc	Max. Deviation (MHz)	Max. Deviation (ppm)
V nom (V)	3.85	T (°C)	-20	5745.0271	5745	0.02710	4.7171
		T (°C)	-10	5745.0275	5745	0.02750	4.7868
		T (°C)	0	5745.0073	5745	0.00730	1.2707
		T (°C)	10	5745.0163	5745	0.01630	2.8372
		T (°C)	20	5745.0264	5745	0.02640	4.5953
		T (°C)	30	5745.0063	5745	0.00630	1.0966
		T (°C)	40	5745.0382	5745	0.03820	6.6493
		T (°C)	50	5745.0152	5745	0.01520	2.6458
		T (°C)	60	5745.0195	5745	0.01950	3.3943
		T (°C)	70	5745.0188	5745	0.01880	3.2724
Limits				Within 5745-5850MHz			
Result				Complies			

Voltage vs. Frequency Stability

TEST CONDITIONS				Reference Frequency: 5785MHz			
				f	fc	Max. Deviation (MHz)	Max. Deviation (ppm)
T nom (°C)	20	V nom (V)	3.85	5785.0127	5785	0.01270	2.1953
		V max (V)	4.43	5785.0202	5785	0.02020	3.4918
		V min (V)	3.27	5785.0056	5785	0.00560	0.9680
Limits				Within 5745-5850MHz			
Result				Complies			

Temperature vs. Frequency Stability

TEST CONDITIONS				Reference Frequency: 5785MHz			
				f	fc	Max. Deviation (MHz)	Max. Deviation (ppm)
V nom (V)	3.85	T (°C)	-20	5785.0303	5785	0.03030	5.2377
		T (°C)	-10	5785.0394	5785	0.03940	6.8107
		T (°C)	0	5785.0166	5785	0.01660	2.8695
		T (°C)	10	5785.0227	5785	0.02270	3.9239
		T (°C)	20	5785.0111	5785	0.01110	1.9188
		T (°C)	30	5785.0045	5785	0.00450	0.7779
		T (°C)	40	5785.0156	5785	0.01560	2.6966
		T (°C)	50	5785.0096	5785	0.00960	1.6595
		T (°C)	60	5785.0109	5785	0.01090	1.8842
		T (°C)	70	5785.0334	5785	0.03340	5.7736
Limits				Within 5745-5850MHz			
Result				Complies			



Voltage vs. Frequency Stability

TEST CONDITIONS				Reference Frequency: 5825MHz			
				f	fc	Max. Deviation (MHz)	Max. Deviation (ppm)
T nom (°C)	20	V nom (V)	3.85	5825.0276	5825	0.02760	4.7382
		V max (V)	4.43	5825.0525	5825	0.05250	9.0129
		V min (V)	3.27	5825.0394	5825	0.03940	6.7639
Limits				Within 5745-5850MHz			
Result				Complies			

Temperature vs. Frequency Stability

TEST CONDITIONS				Reference Frequency: 5825MHz			
				f	fc	Max. Deviation (MHz)	Max. Deviation (ppm)
V nom (V)	3.85	T (°C)	-20	5825.0008	5825	0.00080	0.1373
		T (°C)	-10	5825.0123	5825	0.01230	2.1116
		T (°C)	0	5825.0203	5825	0.02030	3.4850
		T (°C)	10	5825.0134	5825	0.01340	2.3004
		T (°C)	20	5825.0134	5825	0.01340	2.3004
		T (°C)	30	5825.0125	5825	0.01250	2.1459
		T (°C)	40	5825.0339	5825	0.03390	5.8197
		T (°C)	50	5825.0191	5825	0.01910	3.2790
		T (°C)	60	5825.0121	5825	0.01210	2.0773
		T (°C)	70	5825.0187	5825	0.01870	3.2103
Limits				Within 5745-5850MHz			
Result				Complies			

## 9. DYNAMIC FREQUENCY SELECTION(DFS)

### 9.1 APPLICABILITY OF DFS REQUIREMENTS

EUT is client and operates as client without radar detection function.

Table 1: Applicability of DFS Requirements Prior to Use of a Channel

Requirement	Operational Mode		
	Master	Client Without Radar Detection	Client With Radar Detection
Non-Occupancy Period	Yes	Not required	Yes
DFS Detection Threshold	Yes	Not required	Yes
Channel Availability Check Time	Yes	Not required	Not required
U-NII Detection Bandwidth	Yes	Not required	Yes

Table 2: Applicability of DFS requirements during normal operation

Requirement	Operational Mode		
	Master	Client Without Radar Detection	Client With Radar Detection
DFS Detection Threshold	Yes	Not required	Yes
Channel Closing Transmission Time	Yes	Yes	Yes
Channel Move Time	Yes	Yes	Yes
U-NII Detection Bandwidth	Yes	Not required	Yes
Client Beacon Test	N/A	Yes	Yes

Additional requirements for devices with multiple bandwidth modes	Operational Mode	
	Master or Client With Radar Detection	Client Without Radar Detection
U-NII Detection Bandwidth and Statistical Performance Check	All BW modes must be tested	Not required
Channel Move Time and Channel Closing Transmission Time	Test using widest BW mode available	Test using the widest BW mode available for the link
All other tests	Any single BW mode	Not required
<p><b>Note</b> Frequencies selected for statistical performance check (Section 7.8.4) should include several frequencies within the radar detection bandwidth and frequencies near the edge of the radar detection bandwidth. For 802.11 devices it is suggested to select frequencies in each of the bonded 20 MHz channels and the channel center frequency.</p>		

### 9.2 INTERFERENCE THRESHOLD VALUES, MASTER OR CLIENT INCORPORATING IN-SERVICE MONITORING

Maximum Transmit Power	Value (see notes 1, 2, and 3)
EIRP ≥ 200 milliwatt	-64 dBm
EIRP < 200 milliwatt and power spectral density < 10 dBm/MHz	-62 dBm
EIRP < 200 milliwatt that do not meet the power spectral density requirement	-64 dBm
<p><b>Note 1:</b> This is the level at the input of the receiver assuming a 0 dBi receive antenna.</p> <p><b>Note 2:</b> Throughout these test procedures an additional 1 dB has been added to the amplitude of the test transmission waveforms to account for variations in measurement equipment. This will ensure that the test signal is at or above the detection threshold level to trigger a DFS response.</p> <p><b>Note 3:</b> EIRP is based on the highest antenna gain.</p>	

### 9.3 DFS RESPONSE REQUIREMENT VALUES

Parameter	Value
Non-occupancy period	Minimum 30 minutes
Channel Availability Check Time	60 seconds
Channel Move Time	10 seconds See Note 1.
Channel Closing Transmission Time	200 milliseconds + an aggregate of 60 milliseconds over remaining 10 second period. See Notes 1 and 2.
U-NII Detection Bandwidth	Minimum 100% of the 99% power bandwidth See Note 3.

**Note 1:** The instant that the Channel Move Time and the Channel Closing Transmission Time begins is as follows:

- For the Short pulse radar Test Signals this instant is the end of the Burst.
- For the Frequency Hopping radar Test Signal, this instant is the end of the last radar Burst generated.
- For the Long Pulse radar Test Signal this instant is the end of the 12 second period defining the radar transmission.

**Note 2:** The Channel Closing Transmission Time is comprised of 200 milliseconds starting at the beginning of the Channel Move Time plus any additional intermittent control signals required to facilitate Channel changes (an aggregate of 60 milliseconds) during the remainder of the 10 second period. The aggregate duration of control signals will not count quiet periods in between transmissions.

**Note 3:** During the U-NII Detection Bandwidth detection test, radar type 0 is used and for each frequency step the minimum percentage of detection is 90%. Measurements are performed with no data traffic.

### 9.4 SHORT PULSE RADAR TEST WAVEFORMS

As the EUT is a Client Device with no Radar Detection, only one type radar pulse is required for the testing. Radar Pulse type 0 was used in the evaluation of the Client device for the purpose of measuring the Channel Move Time and the Channel Closing Transmission Time.

Radar Type	Pulse Width (µsec)	PRI (µsec)	Number of Pulses	Minimum Percentage of Successful Detection	Minimum Trials
0	1	1428	18	60%	30
1	1	Test A Test B	Roundup $\left( \frac{1}{360} \cdot \frac{19 \cdot 10^6}{PRI_{\mu sec}} \right)$	60%	30
2	1-5	150-230	23-29	60%	30
3	6-10	200-500	16-18	60%	30
4	11-20	200-500	12-16	60%	30
Aggregate (Radar Types 1-4)				80%	120

Test A: 15 unique PRI values randomly selected from the list of 23 PRI values in Table 5a

Test B: 15 unique PRI values randomly selected within the range of 518-3066 µsec, with a minimum increment of 1 µsec, excluding PRI values selected in Test A

A minimum of 30 unique waveforms are required for each of the short pulse radar types 2 through 4. For short pulse radar type 1, the same waveform is used a minimum of 30 times. If more than 30 waveforms are used for short pulse radar types 2 through 4, then each additional waveform must also be unique and not repeated from the previous waveforms.

If more than 30 waveforms are used for Short Pulse Radar Type 1, then each additional waveform is generated with Test B and must also be unique and not repeated from the previous waveforms in Tests A or B. The aggregate is the average of the percentage of successful detections of short pulse radar types 1-4.

**9.5 CALIBRATION SETUP AND DFS TEST RESULTS**

Radar Waveform Calibration Procedure

- 1) A 50 ohm load is connected in place of the spectrum analyzer, and the spectrum analyzer is connected to place of the master
- 2) The interference Radar Detection Threshold Level is  $-62\text{dBm} - 2\text{dBi} + 1\text{dB} = -63\text{dBm}$  that had been taken into account the output power range and antenna gain.
- 3) The following equipment setup was used to calibrate the conducted radar waveform. A vector signal generator was utilized to establish the test signal level for radar type 0. During this process there were no transmissions by either the master or client device. The spectrum analyzer was switched to the zero spans (time domain) at the frequency of the radar waveform generator. Peak detection was used. The spectrum analyzer resolution bandwidth (RBW) and video bandwidth (VBW) were set to 3 MHz. The spectrum analyzer had offset  $-1.0\text{dB}$  to compensate RF cable loss  $1.0\text{dB}$ .
- 4) The vector signal generator amplitude was set so that the power level measured at the spectrum analyzer was  $-62\text{dBm} - 2\text{dBi} + 1\text{dB} = -63\text{dBm}$ . Capture the spectrum analyzer plots on short pulse radar waveform.

**9.6 CONDUCTED CALIBRATION SETUP**

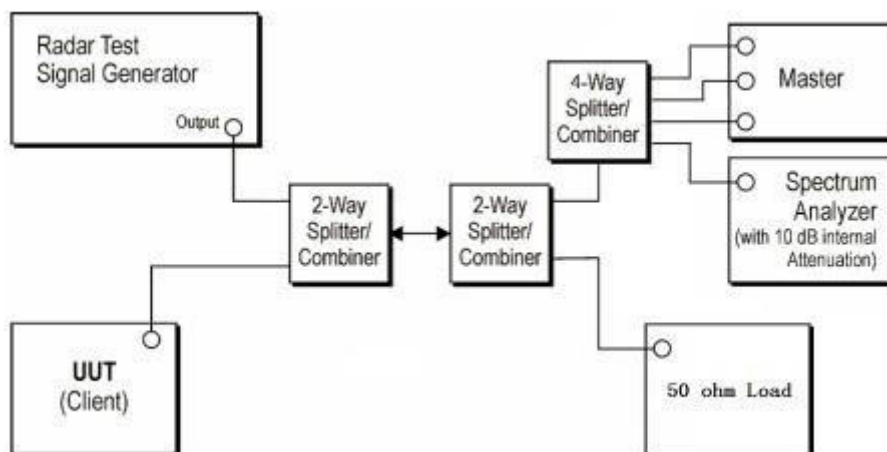

Wireless AP	Manufacturer	ASUSTek Computer Inc
	Model NO.	AX5400
	FCC ID	MSQ-RTAXJ300

- Note:1. The Slave device associated with the EUT during these tests does not have radar detection capability.
2. WLAN traffic is generated by using the iperf software to send packets from the Master IP address to the Slave IP address.
  3. The time required for the master and slave devices to fully start up is 120s.
  4. EUT does not support TPC.

**9.7 RADAR WAVEFORM CALIBRATION RESULT**

Test data reference attachment.

**9.8 IN-SERVICE MONITORING: CHANNEL MOVE TIME, CHANNEL CLOSING TRANSMISSION TIME AND NON-OCCUPANCY PERIOD**

**TEST CONFIGURATION:**

Setup for Client with injection at the Master

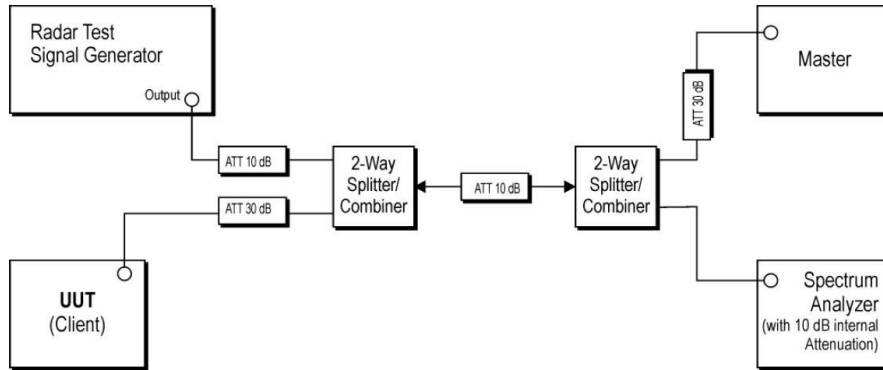

**TEST PROCEDURE:**

1. The radar pulse generator is setup to provide a pulse at frequency that the master and client are operating. A type 0 radar pulse with a 1us pulse width and a 1428us PRI is used for the testing.
2. The vector signal generator is adjusted to provide the radar burst (18 pulses) at the level of approximately -61dBm at the antenna port of the master device
3. A trigger is provided from the pulse generator to the DFS monitoring system in order to capture the traffic and the occurrence of the radar pulse.
4. EUT will associate with the master at channel. The file "iperf.exe" specified by the FCC is Streamed from the PC 2 through the master and the client device to the PC 1 and played in full motion video using Media Player Classic Ver. 6.4.8.6 in order to properly load the network for the entire period of the test.
5. When radar burst with a level equal to the DFS Detection Threshold +1dB is generated on the operating channel of the U-NII device. At time T0 the radar waveform generator sends a burst of pulse of the radar waveform at Detection Threshold +1dB.
6. Observe the transmissions of the EUT at the end of the radar Burst on the Operating Channel Measure and record the transmissions from the UUT during the observation time (Channel Move Time). One 15 seconds plot is reported for the Short Pulse Radar Type 0. The plot for the Short Pulse Radar Types start at the end of the radar burst. The Channel Move Time will be calculated based on the zoom In 600ms plot of the Short Pulse Radar Type
7. Measurement of the aggregate duration of the Channel Closed Transmission Time method. With the spectrum analyzer set to zero span tuned to the center frequency of the EUT operating channel at the radar simulated frequency, peak detection, and max hold, the dwell time per bin is given by:  $Dwell (0.3ms) = S (12000ms) / B (4000)$ ; where Dwell is the dwell time per spectrum analyzer sampling bin, S is sweep time and B is the number of spectrum analyzer sampling bins. An upper bound of the aggregate duration of the intermittent control signals of Channel Closing Transmission Time is calculated by:  $C (ms) = N \times Dwell (0.3ms)$ ; where C is the Closing Time, N is the number of spectrum analyzer sampling bins (intermittent control signals) showing a U-NII transmission and Dwell is the dwell time per bin.
8. Measurement the EUT for more than 30 minutes following the channel move time to verify that no transmission or beacons occur on this channel.

TEST MODE:

Mode	Frequency (MHz)
ac80	5290
ac80	5530
n40	5310
n40	5510
a	5320
a	5500

**9.9 RESULT OF CHANNEL MOVE TIME, CHANNEL CLOSING TRANSMISSION TIME AND NON-OCCUPANCY PERIOD FOR CLIENT BEACON TEST**

Test data reference attachment.

## 10. ANTENNA REQUIREMENT

### 10.1 STANDARD REQUIREMENT

15.203 requirement: For intentional device, according to 15.203: an intentional radiator shall be designed to ensure that no antenna other than that furnished by the responsible party shall be used with the device.

### 10.2 EUT ANTENNA

The EUT antenna is permanent attached FPC Antenna (Gain: -0.5 dBi). It comply with the standard requirement.

END OF REPORT