

**Table 14-20 LTE2600-FDD38 Body**

LTE2600-TDD38 Body								
Ambient Temperature: 22.5			Liquid Temperature: 23.3					
Mode	Device orientation	SAR measurement	Measured SAR [W/kg]			Reported SAR [W/kg]		
			38150	38000	37850	38150	38000	37850
			M	H	H	M	H	H
20MHz QPSK1RB	Tune-up		24.50	24.50	24.50	Scaling factor*		
	Measured Power [dBm]		23.74	23.50	23.52	1.19	1.26	1.25
	Front	1g SAR	0.146			0.17		
		10g SAR	0.083			0.10		
		Deviation	0.05			0.05		
	Rear	1g SAR	0.104			0.12		
		10g SAR	0.064			0.08		
		Deviation	0.08			0.08		
	Bottom edge	1g SAR	0.106			0.13		
		10g SAR	0.052			0.06		
		Deviation	0.03			0.03		
	Left edge	1g SAR	0.12			0.14		
		10g SAR	0.069			0.08		
		Deviation	-0.01			-0.01		
	Right edge	1g SAR	0.024			0.03		
10g SAR		0.012			0.01			
Deviation		-0.03			-0.03			
Mode	Device orientation	SAR measurement	Measured SAR [W/kg]			Reported SAR [W/kg]		
			38150	38000	37850	38150	38000	37850
			L	H	L			
20MHz QPSK50%RB	Tune-up		23.50	23.50	23.50	Scaling factor*		
	Measured Power [dBm]		22.51	22.49	22.53	1.26	1.26	1.25
	Front	1g SAR			0.087			0.11
		10g SAR			0.05			0.06
		Deviation			0.01			0.01
	Rear	1g SAR			0.084			0.11
		10g SAR			0.053			0.07
		Deviation			0.09			0.09
	Bottom edge	1g SAR			0.065			0.08
		10g SAR			0.034			0.04
		Deviation			0.01			0.01
	Left edge	1g SAR			0.091			0.11
		10g SAR			0.052			0.07
		Deviation			0.05			0.05
	Right edge	1g SAR			0.019			0.02
10g SAR				0.009			0.01	
Deviation				-0.08			-0.08	
Mode	Device orientation	SAR measurement	Measured SAR [W/kg]			Reported SAR [W/kg]		
			38150	38000	37850	38150	38000	37850
20MHz QPSK100%RB	Tune-up		23.50	23.50	23.50	Scaling factor*		
	Measured Power [dBm]		22.41	22.44	22.43	1.29	1.28	1.28
	Front	1g SAR						
		10g SAR						
Deviation								
20MHz QPSK1RB B1	Front	1g SAR	0.122			0.15		
		10g SAR	0.071			0.08		
		Deviation	0.12			0.12		
SIM 2	Front	1g SAR	0.124			0.15		
		10g SAR	0.072			0.09		
		Deviation	-0.09			-0.09		



### 14.3 Full SAR

Test Band	Channel	Frequency	Tune-Up	Measured Power	Test Position	Measured 10g SAR	Measured 1g SAR	Reported 10g SAR	Reported 1g SAR	Power Drift	Figure
GSM850	128	824.2 MHz	33.6	33.49	Right Cheek	0.138	0.178	0.14	0.18	-0.06	<a href="#">Fig A.1</a>
GSM850	128	824.2 MHz	29	28.80	Right edge	0.209	0.305	0.22	0.32	0.08	<a href="#">Fig A.2</a>
PCS1900	661	1880 MHz	31	30.92	Left Cheek	0.122	0.19	0.12	0.19	-0.02	<a href="#">Fig A.3</a>
PCS1900	512	1850.2 MHz	28	27.85	Left edge	0.338	0.558	0.35	0.58	-0.12	<a href="#">Fig A.4</a>
WCDMA1900-BII	9538	1907.6 MHz	24.5	24.24	Left Cheek	0.315	0.499	0.33	0.53	0.06	<a href="#">Fig A.5</a>
WCDMA1900-BII	9400	1880 MHz	24.5	23.99	Left edge	0.332	0.549	0.37	0.62	-0.16	<a href="#">Fig A.6</a>
WCDMA1700-BIV	1513	1752.6 MHz	24.5	24.03	Left Cheek	0.178	0.268	0.20	0.30	0.18	<a href="#">Fig A.7</a>
WCDMA1700-BIV	1513	1752.6 MHz	24.5	24.03	Bottom edge	0.2	0.375	0.22	0.42	-0.18	<a href="#">Fig A.8</a>
WCDMA850-BV	4715	835.4 MHz	24.5	24.39	Right Cheek	0.17	0.22	0.17	0.23	-0.05	<a href="#">Fig A.9</a>
WCDMA850-BV	4715	835.4 MHz	24.5	24.39	Right edge	0.256	0.374	0.26	0.38	-0.12	<a href="#">Fig A.10</a>
LTE1900-FDD2	19100	1900 MHz	24.9	24.49	Left Cheek	0.208	0.328	0.23	0.36	-0.06	<a href="#">Fig A.11</a>
LTE1900-FDD2	19100	1900 MHz	24.9	24.49	Front	0.233	0.426	0.26	0.47	-0.03	<a href="#">Fig A.12</a>
LTE1700-FDD4	20050	1720 MHz	24.8	24.72	Left Cheek	0.085	0.13	0.09	0.13	-0.12	<a href="#">Fig A.13</a>
LTE1700-FDD4	20050	1720 MHz	24.8	24.72	Left edge	0.109	0.179	0.11	0.18	0	<a href="#">Fig A.14</a>
LTE2500-FDD7	21350	2560 MHz	24.5	23.93	Left Cheek	0.206	0.368	0.23	0.42	0.06	<a href="#">Fig A.15</a>
LTE2500-FDD7	21350	2560 MHz	24.5	23.93	Left edge	0.247	0.461	0.28	0.53	0.05	<a href="#">Fig A.16</a>
LTE700-FDD12	23130	711 MHz	25	23.95	Right Cheek	0.098	0.124	0.12	0.16	0.02	<a href="#">Fig A.17</a>
LTE700-FDD12	23130	711 MHz	25	23.95	Right edge	0.129	0.182	0.16	0.23	-0.08	<a href="#">Fig A.18</a>
LTE2600-TDD38	38150	2610 MHz	24.5	23.74	Left Cheek	0.101	0.2	0.12	0.24	0.02	<a href="#">Fig A.19</a>
LTE2600-TDD38	38150	2610 MHz	24.5	23.74	Front	0.083	0.146	0.10	0.17	0.05	<a href="#">Fig A.20</a>

### 14.4 WLAN Evaluation For 2.4G

According to the KDB248227 D01, SAR is measured for 802.11b DSSS using the initial test position procedure.

Note1: When the reported SAR of the initial test position is > 0.4 W/kg, SAR is repeated for the 802.11 transmission mode configuration tested in the initial test position using subsequent highest estimated 1-g SAR conditions determined by area scans, on the highest maximum output power channel, until the reported SAR is ≤ 0.8 W/kg.

Note2: For all positions/configurations tested using the initial test position and subsequent test positions, when the reported SAR is > 0.8 W/kg, SAR is measured for these test positions/configurations on the subsequent next highest measured output power channel until the reported SAR is ≤ 1.2 W/kg or all required channels are tested.

Note3: According to the KDB248227 D01, The reported SAR must be scaled to 100% transmission duty factor to determine compliance at the maximum tune-up tolerance limit.

**Table 14.4-1 WLAN 2450 head**

WLAN 2450 Head Fast SAR								
Ambient Temperature: 22.5				Liquid Temperature: 23.3				
Rate	Device orientation	SAR measurement	Measured SAR [W/kg]			Reported SAR [W/kg]		
			11 2462 MHz	6 2437 MHz	1 2412 MHz	11	6	1
802.11b 1Mbps	Tune up		16	16	16	Scaling factor*		
	Slot Average Power [dBm]		15.76	15.79	15.94	1.06	1.05	1.01
	Left Cheek	1g Fast SAR			0.553			0.56
		10g SAR			0.286			0.29
		Deviation			0.08			0.08
	Left Tilt	1g Fast SAR			0.435			0.44
		10g SAR			0.202			0.20
		Deviation			0.19			0.19
	Right Cheek	1g Fast SAR			1.03			1.04
		10g SAR			0.478			0.48
		Deviation			0.04			0.04
	Right Tilt	1g Fast SAR			0.704			0.71
		10g SAR			0.317			0.32
		Deviation			-0.14			-0.14
	B1	Right Cheek	1g Fast SAR			0.976		0.99
10g SAR					0.452		0.46	
Deviation					-0.03		-0.03	
SIM 1	Right Cheek	1g Fast SAR			0.962		0.98	
		10g SAR			0.449		0.46	
		Deviation			-0.01		-0.01	

WLAN 2450 Head Full SAR								
Ambient Temperature: 22.5				Liquid Temperature: 23.3				
Rate	Device orientation	SAR measurement	Measured SAR [W/kg]			Reported SAR [W/kg]		
			11 2462 MHz	6 2437 MHz	1 2412 MHz	11	6	1
802.11b 1Mbps	Tune up		16	16	16	Scaling factor*		
	Slot Average Power [dBm]		15.76	15.79	15.94	1.06	1.05	1.01
	Right Cheek	1g Full SAR		1.13	1.16		1.19	1.18
		10g SAR		0.466	0.48		0.49	0.49
		Deviation		-0.09	0.04		-0.09	0.04
	Right Tilt	1g Full SAR			0.642			0.65
		10g SAR			0.278			0.28
		Deviation			-0.14			-0.14

According to the KDB248227 D01, The reported SAR must be scaled to 100% transmission duty factor to determine compliance at the maximum tune-up tolerance limit. The scaled reported SAR is presented as below:

Frequency		Side	Test Position	Actual duty factor	maximum duty factor	Reported SAR	Scaled reported SAR (1g) (W/kg)	Figure
MHz	Ch.					(1g) (W/kg)		
2437	6	Right	Touch	97.73%	100%	1.19	1.22	Fig.21

SAR is not required for OFDM because the 802.11b adjusted by the ratio of OFDM to DSSS specified maximum output power and the adjusted SAR is ≤ 1.2 W/kg.

**Table 14.4-2 WLAN 2450 body**

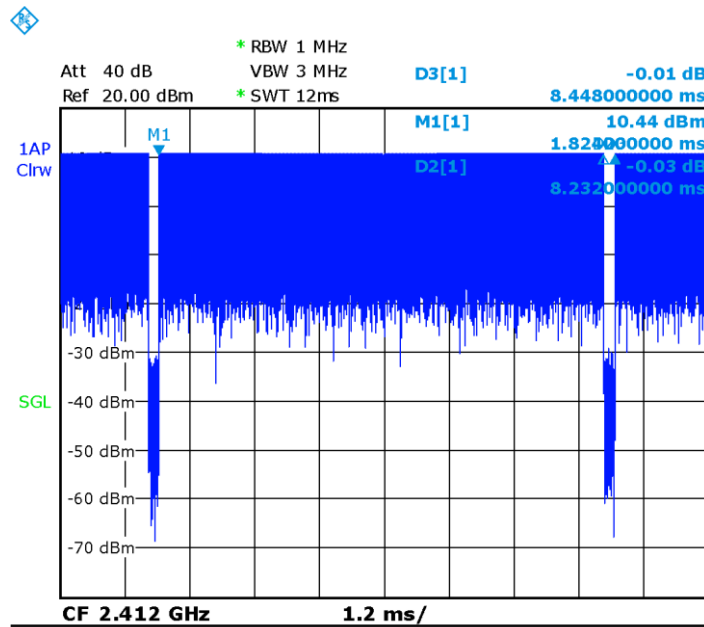
WLAN 2450 Body Fast SAR								
Ambient Temperature: 22.5			Liquid Temperature: 23.3					
Rate	Device orientation	SAR measurement	Measured SAR [W/kg]			Reported SAR [W/kg]		
			11 2462 MHz	6 2437 MHz	1 2412 MHz	11	6	1
802.11b 1Mbps	Tune up		16	16	16	Scaling factor*		
	Slot Average Power [dBm]		15.76	15.79	15.94	1.06	1.05	1.01
	Front	1g Fast SAR			0.084			0.09
		10g SAR			0.047			0.05
		Deviation			0.02			0.02
	Rear	1g Fast SAR			0.08			0.08
		10g SAR			0.043			0.04
		Deviation			0.04			0.04
	Top edge	1g Fast SAR			0.083			0.08
		10g SAR			0.035			0.04
		Deviation			-0.02			-0.02
	Left edge	1g Fast SAR			0.029			0.03
		10g SAR			0.014			0.01
		Deviation			0.1			0.10
	Right edge	1g Fast SAR			0.026			0.03
10g SAR				0.013			0.01	
Deviation				0.17			0.17	
B1	Front	1g Fast SAR			0.082			0.08
		10g SAR			0.044			0.04
		Deviation			0.15			0.15
SIM 2	Front	1g Fast SAR			0.081			0.08
		10g SAR			0.045			0.05
		Deviation			0.07			0.07

WLAN 2450 Body Full SAR								
Ambient Temperature: 22.5			Liquid Temperature: 23.3					
Rate	Device orientation	SAR measurement	Measured SAR [W/kg]			Reported SAR [W/kg]		
			11 2462 MHz	6 2437 MHz	1 2412 MHz	11	6	1
802.11b 1Mbps	Tune up		16	16	16	Scaling factor*		
	Slot Average Power [dBm]		15.76	15.79	15.94	1.06	1.05	1.01
	Front	1g Full SAR			0.086			0.09
		10g SAR			0.047			0.05
		Deviation			0.02			0.02

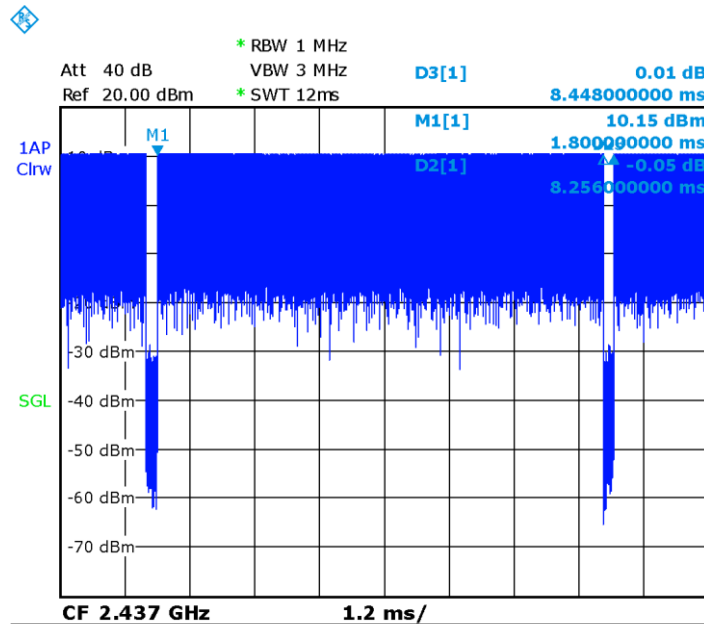
According to the KDB248227 D01, The reported SAR must be scaled to 100% transmission duty factor to determine compliance at the maximum tune-up tolerance limit. The scaled reported SAR is presented as below:

Frequency		Test position	Actual duty factor	maximum duty factor	Reported SAR	Scaled reported	Figure
MHz	Ch.				(1g) (W/kg)	SAR (1g) (W/kg)	
2412	1	Front	97.44%	100%	<b>0.09</b>	<b>0.09</b>	Fig.22
2412	1	Left	97.44%	100%	<b>0.03</b>	<b>0.03</b>	/

SAR is not required for OFDM because the 802.11b adjusted SAR  $\leq$  1.2 W/kg.



Picture 14.1 Duty factor plot for CH.1



Picture 14.2 Duty factor plot for CH.6

### 14.5 WLAN Evaluation For 5G

Table 14.5-1: OFDM mode specified maximum output power of WLAN antenna

802.11 mode	a	g	n		ac			
Ch. BW(MHz)	20	20	20	40	20	40	80	160
U-NII-1	X		X	X				
U-NII-2A	X		X	X				
U-NII-2C	X		X	X				
U-NII-3	X		X	X				
§ 15.247 (5.8 GHz)								

X: maximum(conducted) output power(mW), including tolerance, specified for production units

Table 14.5-2: Maximum output power specified of WLAN antenna

802.11 mode	a	g	n		ac			
Ch. BW(MHz)	20	20	20	40	20	40	80	160
U-NII-1	22							
U-NII-2A	18							
U-NII-2C	19							
U-NII-3	16							
§ 15.247 (5.8 GHz)								

- The maximum output power specified for production units is the same for all channels, modulations and data rates in each channel bandwidth configuration of the 802.11a/g/n/ac modes.
- The blue highlighted cells represent highest output configurations in each standalone or aggregated frequency band, with tune-up tolerance included.

Table 14.5-3: Maximum output power measured of WLAN antenna, for the applicable OFDM configurations according to the default power measurement procedures for selection initial test configurations

802.11 mode	a	n		ac		
BW(MHz)	20	20	40	20	40	80
U-NII-1	36/40/44/48 21/21/20/19	36/40/44/48 Lower power	38/46 Lower power	/	/	/
U-NII-2A	52/56/60/64 18/16/16/15	52/56/60/64 Lower power	54/62 Lower power	/	/	/
U-NII-2C	100/104/108/112 19/19/19/19 116/120/124/128 18/17/17/16 132/136/140 15/14/15	100/104/108/112 116/132/136/140 Lower power	102/110/134 Lower power	/	/	/
U-NII-3	149/153/157/161/165 14/14/15/15/15	149/153/157/161/165 Lower power	151/159 Lower power	/	/	/

- Channels with measured maximum power within 0.25dB are considered to have the same measured output.  
Channels selected for initial test configuration are highlighted in yellow.

**Table 14.5-4: Reported SAR of initial test configuration for Head**

802.11 mode	a	n		ac		
		20	40	20	40	80
U-NII-1	36/40/44/48 U-NII-2A exclusion applied	36/40/44/48	38/46	/	/	/
U-NII-2A	52/56/60/64 0.63	52/56/60/64	54/62	/	/	/
U-NII-2C	100/104/108/112 116/120/124/128 132/136/140 0.79	100/104/108/112 116/132/136/140	102/110/118/ 126/134	/	/	/
U-NII-3	149/153/157/161/165 1.08	149/153/157/161/ 165	151/159	/	/	/

U-NII-1 and U-NII-2A bands have the same specified maximum output and tolerance; SAR is measured for U-NII-2A band first. Adjusted SAR of U-NII-2A band is  $\leq 1.2W/kg$ , SAR is not required for U-NII-1 band.

**Table 14.5-5: Reported SAR of initial test configuration for Body**

802.11 mode	a	n		ac		
		20	40	20	40	80
U-NII-1	36/40/44/48 U-NII-2A exclusion applied	36/40/44/48	38/46	/	/	/
U-NII-2A	52/56/60/64 0.02	52/56/60/64	54/62	/	/	/
U-NII-2C	100/104/108/112 116/120/124/128 132/136/140 0.04	100/104/108/112 116/132/136/140	102/110/118/126/ 134	/	/	/
U-NII-3	149/153/157/161/165 0.05	149/153/157/161/ 165	151/159	/	/	/

U-NII-1 and U-NII-2A bands have the same specified maximum output and tolerance; SAR is measured for U-NII-2A band first. Adjusted SAR of U-NII-2A band is  $\leq 1.2W/kg$ , SAR is not required for U-NII-1 band.

**Table 14.5-6: SAR Values (WLAN - Head) – 802.11a 6Mbps**

Frequency		Side	Test Position	Figure No.	Conducted Power (dBm)	Max. tune-up Power (dBm)	Measured SAR(10g) (W/kg)	Reported SAR(10g) (W/kg)	Measured SAR(1g) (W/kg)	Reported SAR(1g) (W/kg)	Power Drift (dB)
MHz	Ch.										
5260	52	Left	Touch	/	12.56	12.6	0.0694	<b>0.07</b>	0.181	<b>0.18</b>	0.13
5260	52	Left	Tilt	/	12.56	12.6	0.0586	<b>0.06</b>	0.165	<b>0.17</b>	0.14
5260	52	Right	Touch	/	12.56	12.6	0.168	<b>0.17</b>	0.624	<b>0.63</b>	0.04
5260	52	Right	Tilt	/	12.56	12.6	0.133	<b>0.13</b>	0.389	<b>0.39</b>	0.02
5560	112	Left	Touch	/	12.82	12.9	0.106	<b>0.11</b>	0.266	<b>0.27</b>	0.12
5560	112	Left	Tilt	/	12.82	12.9	0.0855	<b>0.09</b>	0.25	<b>0.25</b>	0.01
5560	112	Right	Touch	/	12.82	12.9	0.22	<b>0.22</b>	0.779	<b>0.79</b>	-0.05
5560	112	Right	Tilt	/	12.82	12.9	0.202	<b>0.21</b>	0.651	<b>0.66</b>	0.05
5785	157	Left	Touch	/	11.74	11.8	0.132	<b>0.13</b>	0.328	<b>0.33</b>	-0.15
5785	157	Left	Tilt	/	11.74	11.8	0.148	<b>0.15</b>	0.409	<b>0.41</b>	0.11
5785	157	Right	Touch	Fig.23	11.74	11.8	0.299	<b>0.30</b>	1.07	<b>1.08</b>	0.1
5785	157	Right	Tilt	/	11.74	11.8	0.215	<b>0.22</b>	0.684	<b>0.69</b>	-0.04
5805	161	Right	Touch	/	11.71	11.8	0.217	<b>0.22</b>	0.654	<b>0.67</b>	0.09
5785	157	Right	Touch	B1	11.74	11.8	0.223	<b>0.23</b>	0.745	<b>0.76</b>	0.01
5785	157	Right	Touch	S2	11.74	11.8	0.235	<b>0.24</b>	0.772	<b>0.78</b>	0.07

**Table 14.5-7: SAR Values (WLAN - Body) – 802.11a 6Mbps**

Frequency		Test Position	D (mm)	Figure No.	Conducted Power (dBm)	Max. tune-up Power (dBm)	Measured SAR(10g) (W/kg)	Reported SAR(10g) (W/kg)	Measured SAR(1g) (W/kg)	Reported SAR(1g) (W/kg)	Power Drift (dB)
MHz	Ch.										
5260	52	Front	10	/	12.56	12.6	0.004	<b>&lt;0.01</b>	0.01	<b>0.01</b>	-0.03
5260	52	Rear	10	/	12.56	12.6	0.005	<b>0.01</b>	0.016	<b>0.02</b>	0.02
5260	52	Left	10	/	12.56	12.6	0.003	<b>&lt;0.01</b>	0.001	<b>&lt;0.01</b>	0.01
5260	52	Top	10	/	12.56	12.6	0.004	<b>&lt;0.01</b>	0.012	<b>0.01</b>	0.05
5560	112	Front	10	/	12.82	12.9	0.007	<b>0.01</b>	0.022	<b>0.02</b>	-0.02
5560	112	Rear	10	/	12.82	12.9	0.012	<b>0.01</b>	0.035	<b>0.04</b>	0.04
5560	112	Left	10	/	12.82	12.9	0.002	<b>&lt;0.01</b>	0.012	<b>0.01</b>	0.09
5560	112	Top	10	/	12.82	12.9	0.014	<b>0.01</b>	0.043	<b>0.04</b>	0.01
5785	157	Front	10	/	11.74	11.8	0.011	<b>0.01</b>	0.036	<b>0.04</b>	0.01
5785	157	Rear	10	/	11.74	11.8	0.014	<b>0.01</b>	0.038	<b>0.04</b>	0.04
5785	157	Left	10	/	11.74	11.8	0.005	<b>0.01</b>	0.016	<b>0.02</b>	0.07
5785	157	Top	10	Fig.24	11.74	11.8	0.018	<b>0.02</b>	0.051	<b>0.05</b>	0.04
5785	157	Top	10	B1	11.74	11.8	0.017	<b>0.02</b>	0.043	<b>0.04</b>	0.06
5785	157	Top	10	S2	11.74	11.8	0.016	<b>0.02</b>	0.044	<b>0.04</b>	-0.15



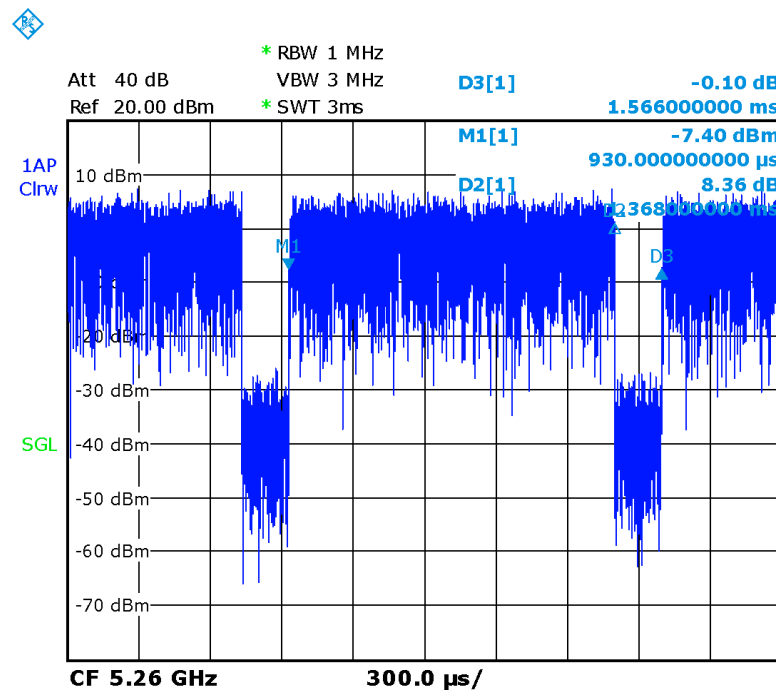
According to the KDB248227 D01, The reported SAR must be scaled to 100% transmission duty factor to determine compliance at the maximum tune-up tolerance limit. The scaled reported SAR is presented as below.

**Table 14.5-8: SAR Values (WLAN - Head) – 802.11a 6Mbps (Scaled Reported SAR)**

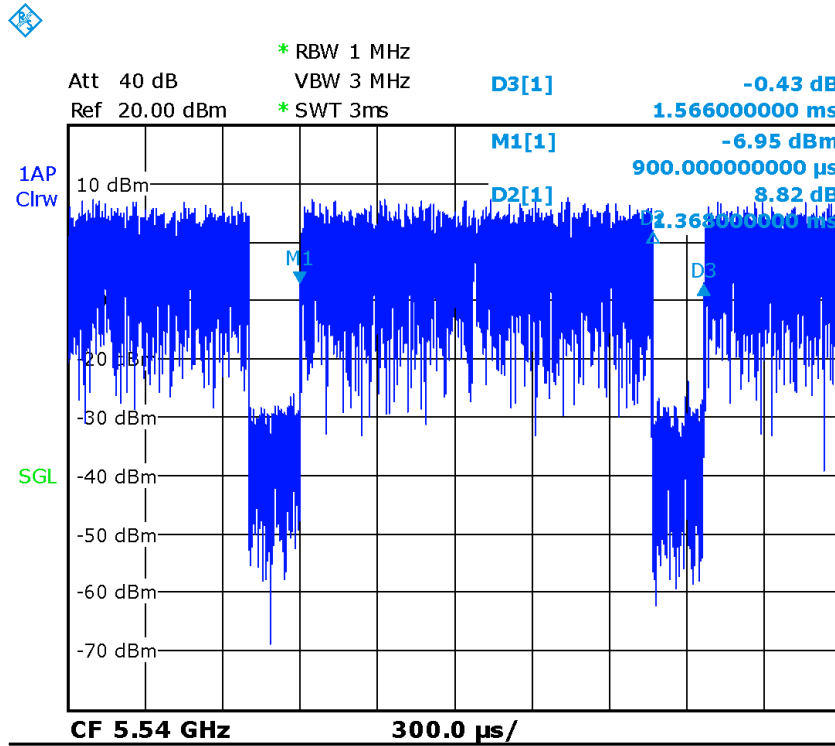
Frequency		Side	Test Position	Actual duty factor	maximum duty factor	Reported SAR (1g) (W/kg)	Scaled reported SAR (1g) (W/kg)
MHz	Ch.						
5785	157	Right	Touch	87.36%	100%	<b>1.08</b>	<b>1.24</b>

**Table 14.5-9: SAR Values (WLAN - Body) – 802.11a 6Mbps (Scaled Reported SAR)**

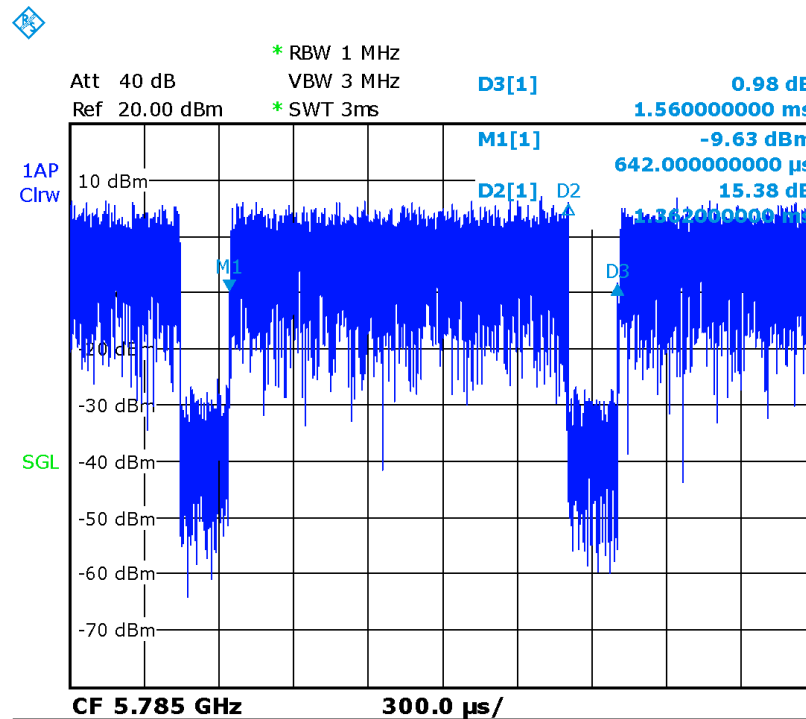
Frequency		Test Position	D (mm)	Actual duty factor	maximum duty factor	Reported SAR (1g) (W/kg)	Scaled reported SAR (1g) (W/kg)
MHz	Ch.						
5785	157	Top	10	87.36%	100%	<b>0.05</b>	<b>0.06</b>



Picture 14.3 The plot of duty factor for CH.52



Picture 14.4 The plot of duty factor for CH.112



Picture 14.5 The plot of duty factor for CH.157

## 15 SAR Measurement Variability

SAR measurement variability must be assessed for each frequency band, which is determined by the SAR probe calibration point and tissue-equivalent medium used for the device measurements. When both head and body tissue-equivalent media are required for SAR measurements in a frequency band, the variability measurement procedures should be applied to the tissue medium with the highest measured SAR, using the highest measured SAR configuration for that tissue-equivalent medium.

The following procedures are applied to determine if repeated measurements are required.

- 1) Repeated measurement is not required when the original highest measured SAR is  $< 0.80$  W/kg; steps 2) through 4) do not apply.
- 2) When the original highest measured SAR is  $\geq 0.80$  W/kg, repeat that measurement once.
- 3) Perform a second repeated measurement only if the ratio of largest to smallest SAR for the original and first repeated measurements is  $> 1.20$  or when the original or repeated measurement is  $\geq 1.45$  W/kg (~ 10% from the 1-g SAR limit).
- 4) Perform a third repeated measurement only if the original, first or second repeated measurement is  $\geq 1.5$  W/kg and the ratio of largest to smallest SAR for the original, first and second repeated measurements is  $> 1.20$ .

Mode	Channel	Frequency	Test Position	Original SAR (W/kg)	First Repeated SAR(W/kg)	The Ratio
WLAN 2450	6	2437 MHz	Right Cheek	1.13	1.12	1.01
WLAN 5G	157	5785 MHz	Right Cheek	1.07	1.06	1.01

## 16 Measurement Uncertainty

### 16.1 Measurement Uncertainty for Normal SAR Tests (300MHz~3GHz)

No.	Error Description	Type	Uncertainty value	Probably Distribution	Div.	(Ci) 1g	(Ci) 10g	Std. Unc. (1g)	Std. Unc. (10g)	Degree of freedom
<b>Measurement system</b>										
1	Probe calibration	B	6.0	N	1	1	1	6.0	6.0	∞
2	Isotropy	B	4.7	R	$\sqrt{3}$	0.7	0.7	1.9	1.9	∞
3	Boundary effect	B	1.0	R	$\sqrt{3}$	1	1	0.6	0.6	∞
4	Linearity	B	4.7	R	$\sqrt{3}$	1	1	2.7	2.7	∞
5	Detection limit	B	1.0	N	1	1	1	0.6	0.6	∞
6	Readout electronics	B	0.3	R	$\sqrt{3}$	1	1	0.3	0.3	∞
7	Response time	B	0.8	R	$\sqrt{3}$	1	1	0.5	0.5	∞
8	Integration time	B	2.6	R	$\sqrt{3}$	1	1	1.5	1.5	∞
9	RF ambient conditions-noise	B	0	R	$\sqrt{3}$	1	1	0	0	∞
10	RF ambient conditions-reflection	B	0	R	$\sqrt{3}$	1	1	0	0	∞
11	Probe positioned mech. restrictions	B	0.4	R	$\sqrt{3}$	1	1	0.2	0.2	∞
12	Probe positioning with respect to phantom shell	B	2.9	R	$\sqrt{3}$	1	1	1.7	1.7	∞
13	Post-processing	B	1.0	R	$\sqrt{3}$	1	1	0.6	0.6	∞
<b>Test sample related</b>										
14	Test sample positioning	A	3.3	N	1	1	1	3.3	3.3	71
15	Device holder uncertainty	A	3.4	N	1	1	1	3.4	3.4	5
16	Drift of output power	B	5.0	R	$\sqrt{3}$	1	1	2.9	2.9	∞
<b>Phantom and set-up</b>										
17	Phantom uncertainty	B	4.0	R	$\sqrt{3}$	1	1	2.3	2.3	∞
18	Liquid conductivity (target)	B	5.0	R	$\sqrt{3}$	0.64	0.43	1.8	1.2	∞
19	Liquid conductivity (meas.)	A	2.06	N	1	0.64	0.43	1.32	0.89	43
20	Liquid permittivity (target)	B	5.0	R	$\sqrt{3}$	0.6	0.49	1.7	1.4	∞
21	Liquid permittivity (meas.)	A	1.6	N	1	0.6	0.49	1.0	0.8	521

Combined standard uncertainty	$u_c = \sqrt{\sum_{i=1}^{21} c_i^2 u_i^2}$							9.55	9.43	257
Expanded uncertainty (confidence interval of 95 %)	$u_e = 2u_c$							19.1	18.9	

**16.2 Measurement Uncertainty for Normal SAR Tests (3~6GHz)**

No.	Error Description	Type	Uncertainty value	Probably Distribution	Div.	(Ci) 1g	(Ci) 10g	Std. Unc. (1g)	Std. Unc. (10g)	Degree of freedom
<b>Measurement system</b>										
1	Probe calibration	B	6.55	N	1	1	1	6.55	6.55	∞
2	Isotropy	B	4.7	R	$\sqrt{3}$	0.7	0.7	1.9	1.9	∞
3	Boundary effect	B	2.0	R	$\sqrt{3}$	1	1	1.2	1.2	∞
4	Linearity	B	4.7	R	$\sqrt{3}$	1	1	2.7	2.7	∞
5	Detection limit	B	1.0	R	$\sqrt{3}$	1	1	0.6	0.6	∞
6	Readout electronics	B	0.3	R	$\sqrt{3}$	1	1	0.3	0.3	∞
7	Response time	B	0.8	R	$\sqrt{3}$	1	1	0.5	0.5	∞
8	Integration time	B	2.6	R	$\sqrt{3}$	1	1	1.5	1.5	∞
9	RF ambient conditions-noise	B	0	R	$\sqrt{3}$	1	1	0	0	∞
10	RF ambient conditions-reflection	B	0	R	$\sqrt{3}$	1	1	0	0	∞
11	Probe positioned mech. restrictions	B	0.8	R	$\sqrt{3}$	1	1	0.5	0.5	∞
12	Probe positioning with respect to phantom shell	B	6.7	R	$\sqrt{3}$	1	1	3.9	3.9	∞
13	Post-processing	B	4.0	R	$\sqrt{3}$	1	1	2.3	2.3	∞
<b>Test sample related</b>										
14	Test sample positioning	A	3.3	N	1	1	1	3.3	3.3	71
15	Device holder uncertainty	A	3.4	N	1	1	1	3.4	3.4	5
16	Drift of output power	B	5.0	R	$\sqrt{3}$	1	1	2.9	2.9	∞
<b>Phantom and set-up</b>										
17	Phantom uncertainty	B	4.0	R	$\sqrt{3}$	1	1	2.3	2.3	∞
18	Liquid conductivity (target)	B	5.0	R	$\sqrt{3}$	0.64	0.43	1.8	1.2	∞
19	Liquid conductivity (meas.)	A	2.06	N	1	0.64	0.43	1.32	0.89	43

20	Liquid permittivity (target)	B	5.0	R	$\sqrt{3}$	0.6	0.49	1.7	1.4	$\infty$
21	Liquid permittivity (meas.)	A	1.6	N	1	0.6	0.49	1.0	0.8	521
Combined standard uncertainty		$u_c = \sqrt{\sum_{i=1}^{21} c_i^2 u_i^2}$						10.7	10.6	257
Expanded uncertainty (confidence interval of 95 %)		$u_e = 2u_c$						21.4	21.1	

### 16.3 Measurement Uncertainty for Fast SAR Tests (300MHz~3GHz)

No.	Error Description	Type	Uncertainty value	Probably Distribution	Div.	(Ci) 1g	(Ci) 10g	Std. Unc. (1g)	Std. Unc. (10g)	Degree of freedom
<b>Measurement system</b>										
1	Probe calibration	B	6.0	N	1	1	1	6.0	6.0	$\infty$
2	Isotropy	B	4.7	R	$\sqrt{3}$	0.7	0.7	1.9	1.9	$\infty$
3	Boundary effect	B	1.0	R	$\sqrt{3}$	1	1	0.6	0.6	$\infty$
4	Linearity	B	4.7	R	$\sqrt{3}$	1	1	2.7	2.7	$\infty$
5	Detection limit	B	1.0	R	$\sqrt{3}$	1	1	0.6	0.6	$\infty$
6	Readout electronics	B	0.3	R	$\sqrt{3}$	1	1	0.3	0.3	$\infty$
7	Response time	B	0.8	R	$\sqrt{3}$	1	1	0.5	0.5	$\infty$
8	Integration time	B	2.6	R	$\sqrt{3}$	1	1	1.5	1.5	$\infty$
9	RF ambient conditions-noise	B	0	R	$\sqrt{3}$	1	1	0	0	$\infty$
10	RF ambient conditions-reflection	B	0	R	$\sqrt{3}$	1	1	0	0	$\infty$
11	Probe positioned mech. Restrictions	B	0.4	R	$\sqrt{3}$	1	1	0.2	0.2	$\infty$
12	Probe positioning with respect to phantom shell	B	2.9	R	$\sqrt{3}$	1	1	1.7	1.7	$\infty$
13	Post-processing	B	1.0	R	$\sqrt{3}$	1	1	0.6	0.6	$\infty$

14	Fast SAR z-Approximation	B	7.0	R	$\sqrt{3}$	1	1	4.0	4.0	$\infty$
<b>Test sample related</b>										
15	Test sample positioning	A	3.3	N	1	1	1	3.3	3.3	71
16	Device holder uncertainty	A	3.4	N	1	1	1	3.4	3.4	5
17	Drift of output power	B	5.0	R	$\sqrt{3}$	1	1	2.9	2.9	$\infty$
<b>Phantom and set-up</b>										
18	Phantom uncertainty	B	4.0	R	$\sqrt{3}$	1	1	2.3	2.3	$\infty$
19	Liquid conductivity (target)	B	5.0	R	$\sqrt{3}$	0.64	0.43	1.8	1.2	$\infty$
20	Liquid conductivity (meas.)	A	2.06	N	1	0.64	0.43	1.32	0.89	43
21	Liquid permittivity (target)	B	5.0	R	$\sqrt{3}$	0.6	0.49	1.7	1.4	$\infty$
22	Liquid permittivity (meas.)	A	1.6	N	1	0.6	0.49	1.0	0.8	521
Combined standard uncertainty		$u_c = \sqrt{\sum_{i=1}^{22} c_i^2 u_i^2}$						10.4	10.3	257
Expanded uncertainty (confidence interval of 95 %)		$u_e = 2u_c$						20.8	20.6	

### 16.4 Measurement Uncertainty for Fast SAR Tests (3~6GHz)

No.	Error Description	Type	Uncertainty value	Probably Distribution	Div.	(Ci) 1g	(Ci) 10g	Std. Unc. (1g)	Std. Unc. (10g)	Degree of freedom
<b>Measurement system</b>										
1	Probe calibration	B	6.55	N	1	1	1	6.55	6.55	$\infty$
2	Isotropy	B	4.7	R	$\sqrt{3}$	0.7	0.7	1.9	1.9	$\infty$
3	Boundary effect	B	2.0	R	$\sqrt{3}$	1	1	1.2	1.2	$\infty$
4	Linearity	B	4.7	R	$\sqrt{3}$	1	1	2.7	2.7	$\infty$
5	Detection limit	B	1.0	R	$\sqrt{3}$	1	1	0.6	0.6	$\infty$
6	Readout electronics	B	0.3	R	$\sqrt{3}$	1	1	0.3	0.3	$\infty$

7	Response time	B	0.8	R	$\sqrt{3}$	1	1	0.5	0.5	$\infty$
8	Integration time	B	2.6	R	$\sqrt{3}$	1	1	1.5	1.5	$\infty$
9	RF ambient conditions-noise	B	0	R	$\sqrt{3}$	1	1	0	0	$\infty$
10	RF ambient conditions-reflection	B	0	R	$\sqrt{3}$	1	1	0	0	$\infty$
11	Probe positioned mech. Restrictions	B	0.8	R	$\sqrt{3}$	1	1	0.5	0.5	$\infty$
12	Probe positioning with respect to phantom shell	B	6.7	R	$\sqrt{3}$	1	1	3.9	3.9	$\infty$
13	Post-processing	B	1.0	R	$\sqrt{3}$	1	1	0.6	0.6	$\infty$
14	Fast SAR z-Approximation	B	14.0	R	$\sqrt{3}$	1	1	8.1	8.1	$\infty$
<b>Test sample related</b>										
15	Test sample positioning	A	3.3	N	1	1	1	3.3	3.3	71
16	Device holder uncertainty	A	3.4	N	1	1	1	3.4	3.4	5
17	Drift of output power	B	5.0	R	$\sqrt{3}$	1	1	2.9	2.9	$\infty$
<b>Phantom and set-up</b>										
18	Phantom uncertainty	B	4.0	R	$\sqrt{3}$	1	1	2.3	2.3	$\infty$
19	Liquid conductivity (target)	B	5.0	R	$\sqrt{3}$	0.64	0.43	1.8	1.2	$\infty$
20	Liquid conductivity (meas.)	A	2.06	N	1	0.64	0.43	1.32	0.89	43
21	Liquid permittivity (target)	B	5.0	R	$\sqrt{3}$	0.6	0.49	1.7	1.4	$\infty$
22	Liquid permittivity (meas.)	A	1.6	N	1	0.6	0.49	1.0	0.8	521
Combined standard uncertainty		$u_c = \sqrt{\sum_{i=1}^{22} c_i^2 u_i^2}$						13.5	13.4	257
Expanded uncertainty (confidence interval of 95 %)		$u_e = 2u_c$						27.0	26.8	



## 17 MAIN TEST INSTRUMENTS

**Table 17.1: List of Main Instruments**

No.	Name	Type	Serial Number	Calibration Date	Valid Period
01	Network analyzer	E5071C	MY46110673	January 13, 2017	One year
02	Power meter	NRVD	102083	September 22,2016	One year
03	Power sensor	NRV-Z5	100595		
04	Signal Generator	E4438C	MY49071430	January 13,2017	One Year
05	Amplifier	60S1G4	0331848	No Calibration Requested	
06	BTS	E5515C	MY50263375	January 16, 2017	One year
07	BTS	CMW500	149646	November 03, 2016	One year
08	E-field Probe	SPEAG EX3DV4	3846	January 13,2017	One year
09	DAE	SPEAG DAE4	1331	January19, 2017	One year
10	Dipole Validation Kit	SPEAG D750V3	1017	July 20, 2016	One year
11	Dipole Validation Kit	SPEAG D835V2	4d069	July 20, 2016	One year
12	Dipole Validation Kit	SPEAG D1750V2	1003	July 21, 2016	One year
13	Dipole Validation Kit	SPEAG D1900V2	5d101	July 28, 2016	One year
14	Dipole Validation Kit	SPEAG D2450V2	853	July 25, 2016	One year
15	Dipole Validation Kit	SPEAG D2600V2	1012	July 25, 2016	One year
16	Dipole Validation Kit	SPEAG D5GHzV2	1060	July 27,2016	One year

\*\*\*END OF REPORT BODY\*\*\*

## ANNEX A Graph Results

### GSM850\_CH128 Right Cheek

Date: 4/6/2017

Electronics: DAE4 Sn1331

Medium: Head 835 MHz

Medium parameters used:  $f = 824.2$  MHz;  $\sigma = 0.891$  mho/m;  $\epsilon_r = 41.61$ ;  $\rho = 1000$  kg/m<sup>3</sup>

Ambient Temperature: 22.5°C, Liquid Temperature: 23.3°C

Communication System: GSM850 824.2 MHz Duty Cycle: 1:8.3

Probe: EX3DV4 – SN3846 ConvF(9.33,9.33,9.33)

**Area Scan (71x121x1):** Interpolated grid: dx=1.000 mm, dy=1.000 mm

Maximum value of SAR (interpolated) = 0.193 W/kg

**Zoom Scan (7x7x7)/Cube 0:** Measurement grid: dx=5mm, dy=5mm, dz=5mm

Reference Value = 5.773 V/m; Power Drift = -0.06 dB

Peak SAR (extrapolated) = 0.223 W/kg

**SAR(1 g) = 0.178 W/kg; SAR(10 g) = 0.138 W/kg**

Maximum value of SAR (measured) = 0.195 W/kg

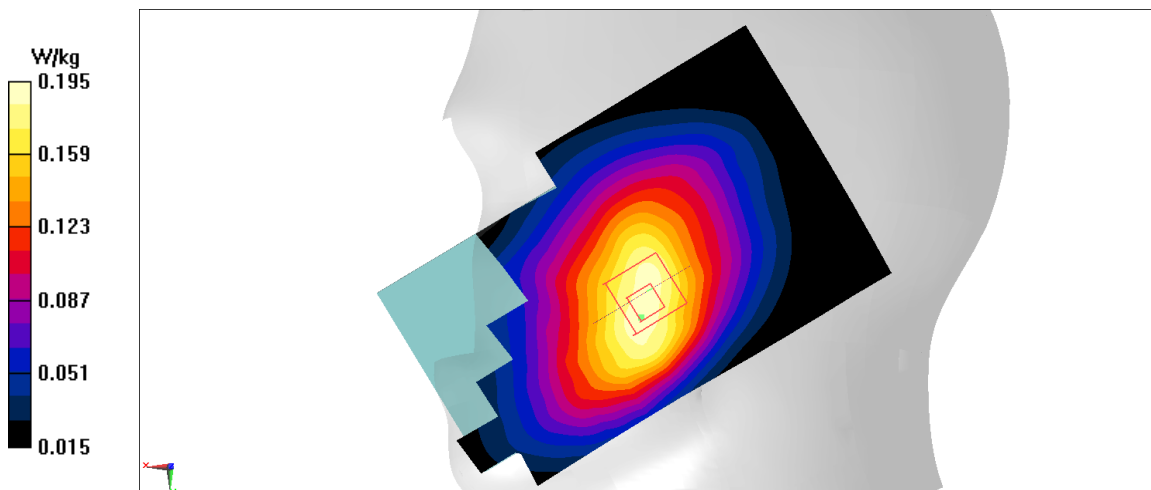


Figure A.1

**GSM850\_CH128 Right edge**

Date: 4/6/2017

Electronics: DAE4 Sn1331

Medium: Body 835 MHz

Medium parameters used:  $f = 824.2$  MHz;  $\sigma = 0.978$  mho/m;  $\epsilon_r = 56.11$ ;  $\rho = 1000$  kg/m<sup>3</sup>

Ambient Temperature: 22.5°C, Liquid Temperature: 23.3°C

Communication System: GSM850 824.2 MHz Duty Cycle: 1:2

Probe: EX3DV4 – SN3846 ConvF(9.52,9.52,9.52)

**Area Scan (71x121x1):** Interpolated grid: dx=1.000 mm, dy=1.000 mm

Maximum value of SAR (interpolated) = 0.35 W/kg

**Zoom Scan (7x7x7)/Cube 0:** Measurement grid: dx=5mm, dy=5mm, dz=5mm

Reference Value = 17.31 V/m; Power Drift = 0.08 dB

Peak SAR (extrapolated) = 0.433 W/kg

**SAR(1 g) = 0.305 W/kg; SAR(10 g) = 0.209 W/kg**

Maximum value of SAR (measured) = 0.347 W/kg

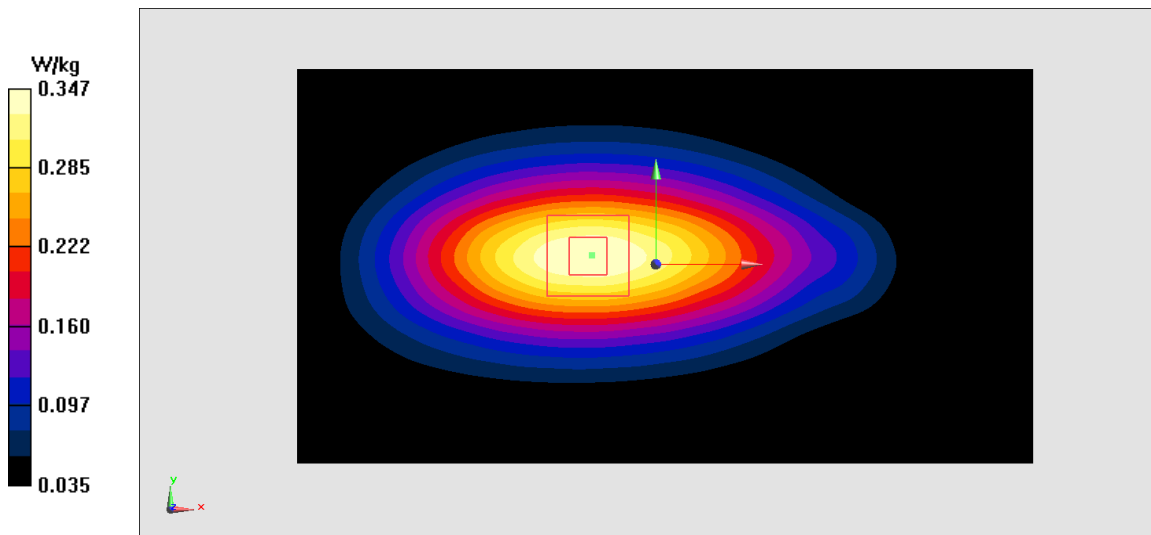


Figure A.2

**PCS1900\_CH661 Left Cheek**

Date: 4/8/2017

Electronics: DAE4 Sn1331

Medium: Head 1900 MHz

Medium parameters used:  $f = 1880$  MHz;  $\sigma = 1.371$  mho/m;  $\epsilon_r = 39.57$ ;  $\rho = 1000$  kg/m<sup>3</sup>

Ambient Temperature: 22.5°C, Liquid Temperature: 23.3°C

Communication System: PCS1900 1880 MHz Duty Cycle: 1:8.3

Probe: EX3DV4 – SN3846 ConvF(7.89,7.89,7.89)

**Area Scan (71x121x1):** Interpolated grid: dx=1.000 mm, dy=1.000 mm

Maximum value of SAR (interpolated) = 0.221 W/kg

**Zoom Scan (7x7x7)/Cube 0:** Measurement grid: dx=5mm, dy=5mm, dz=5mm

Reference Value = 3.794 V/m; Power Drift = -0.02 dB

Peak SAR (extrapolated) = 0.275 W/kg

**SAR(1 g) = 0.19 W/kg; SAR(10 g) = 0.122 W/kg**

Maximum value of SAR (measured) = 0.218 W/kg

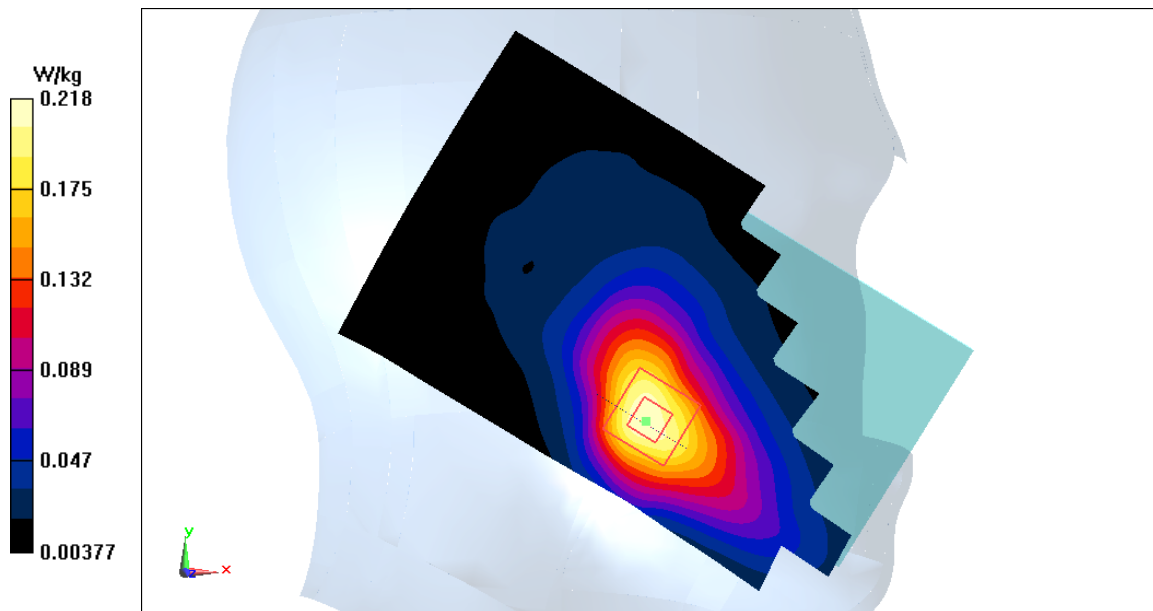


Figure A.3

**PCS1900\_CH512 Left edge**

Date: 4/8/2017

Electronics: DAE4 Sn1331

Medium: Body 1900 MHz

Medium parameters used:  $f = 1850.2$  MHz;  $\sigma = 1.488$  mho/m;  $\epsilon_r = 53.25$ ;  $\rho = 1000$  kg/m<sup>3</sup>

Ambient Temperature: 22.5°C, Liquid Temperature: 23.3°C

Communication System: PCS1900 1850.2 MHz Duty Cycle: 1:2

Probe: EX3DV4 – SN3846 ConvF(7.57,7.57,7.57)

**Area Scan (71x121x1):** Interpolated grid: dx=1.000 mm, dy=1.000 mm

Maximum value of SAR (interpolated) = 0.672 W/kg

**Zoom Scan (7x7x7)/Cube 0:** Measurement grid: dx=5mm, dy=5mm, dz=5mm

Reference Value = 9.807 V/m; Power Drift = -0.12 dB

Peak SAR (extrapolated) = 0.881 W/kg

**SAR(1 g) = 0.558 W/kg; SAR(10 g) = 0.338 W/kg**

Maximum value of SAR (measured) = 0.663 W/kg

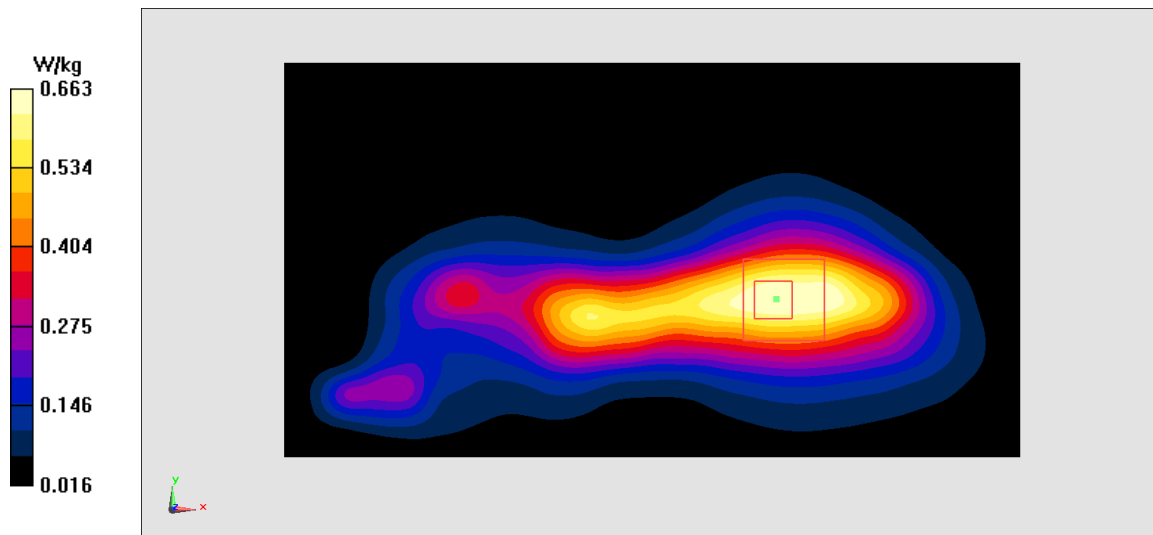


Figure A.4

### WCDMA1900-BII\_CH9538 Left Cheek

Date: 4/8/2017

Electronics: DAE4 Sn1331

Medium: Head 1900 MHz

Medium parameters used:  $f = 1907.6$  MHz;  $\sigma = 1.398$  mho/m;  $\epsilon_r = 39.54$ ;  $\rho = 1000$  kg/m<sup>3</sup>

Ambient Temperature: 22.5°C, Liquid Temperature: 23.3°C

Communication System: WCDMA1900-BII 1907.6 MHz Duty Cycle: 1:1

Probe: EX3DV4 – SN3846 ConvF(7.89,7.89,7.89)

**Area Scan (71x121x1):** Interpolated grid: dx=1.000 mm, dy=1.000 mm

Maximum value of SAR (interpolated) = 0.579 W/kg

**Zoom Scan (7x7x7)/Cube 0:** Measurement grid: dx=5mm, dy=5mm, dz=5mm

Reference Value = 5.884 V/m; Power Drift = 0.06 dB

Peak SAR (extrapolated) = 0.734 W/kg

**SAR(1 g) = 0.499 W/kg; SAR(10 g) = 0.315 W/kg**

Maximum value of SAR (measured) = 0.575 W/kg

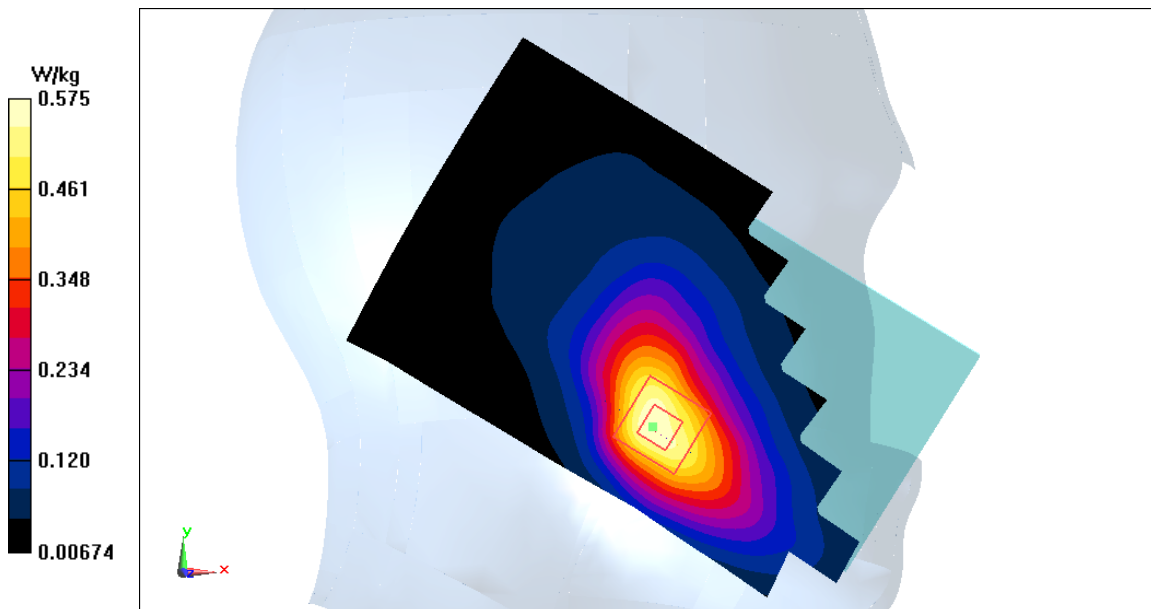


Figure A.5

**WCDMA1900-BII\_CH9400 Left edge**

Date: 4/8/2017

Electronics: DAE4 Sn1331

Medium: Body 1900 MHz

Medium parameters used:  $f = 1880$  MHz;  $\sigma = 1.517$  mho/m;  $\epsilon_r = 53.21$ ;  $\rho = 1000$  kg/m<sup>3</sup>

Ambient Temperature: 22.5°C, Liquid Temperature: 23.3°C

Communication System: WCDMA1900-BII 1880 MHz Duty Cycle: 1:1

Probe: EX3DV4 – SN3846 ConvF(7.57,7.57,7.57)

**Area Scan (71x121x1):** Interpolated grid: dx=1.000 mm, dy=1.000 mm

Maximum value of SAR (interpolated) = 0.665 W/kg

**Zoom Scan (7x7x7)/Cube 0:** Measurement grid: dx=5mm, dy=5mm, dz=5mm

Reference Value = 14.41 V/m; Power Drift = -0.16 dB

Peak SAR (extrapolated) = 0.875 W/kg

**SAR(1 g) = 0.549 W/kg; SAR(10 g) = 0.332 W/kg**

Maximum value of SAR (measured) = 0.656 W/kg

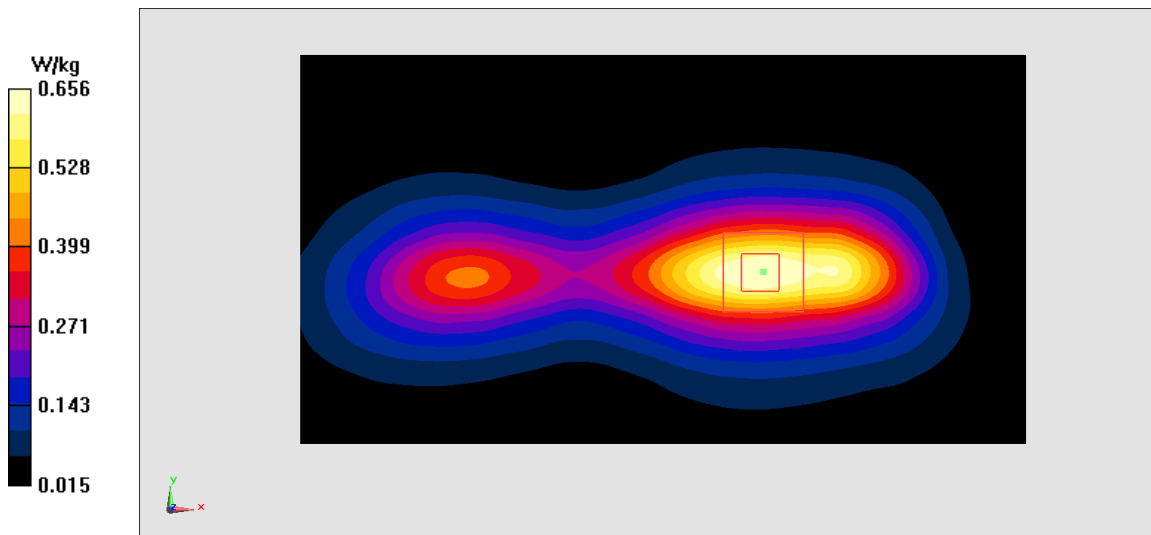


Figure A.6

**WCDMA1700-BIV\_CH1513 Left Cheek**

Date: 4/7/2017

Electronics: DAE4 Sn1331

Medium: Head 1750 MHz

Medium parameters used:  $f = 1752.6$  MHz;  $\sigma = 1.383$  mho/m;  $\epsilon_r = 40.67$ ;  $\rho = 1000$  kg/m<sup>3</sup>

Ambient Temperature: 22.5°C, Liquid Temperature: 23.3°C

Communication System: WCDMA1700-BIV 1752.6 MHz Duty Cycle: 1:1

Probe: EX3DV4 – SN3846 ConvF(8.16,8.16,8.16)

**Area Scan (71x121x1):** Interpolated grid: dx=1.000 mm, dy=1.000 mm

Maximum value of SAR (interpolated) = 0.304 W/kg

**Zoom Scan (7x7x7)/Cube 0:** Measurement grid: dx=5mm, dy=5mm, dz=5mm

Reference Value = 3.688 V/m; Power Drift = 0.18 dB

Peak SAR (extrapolated) = 0.374 W/kg

**SAR(1 g) = 0.268 W/kg; SAR(10 g) = 0.178 W/kg**

Maximum value of SAR (measured) = 0.3 W/kg

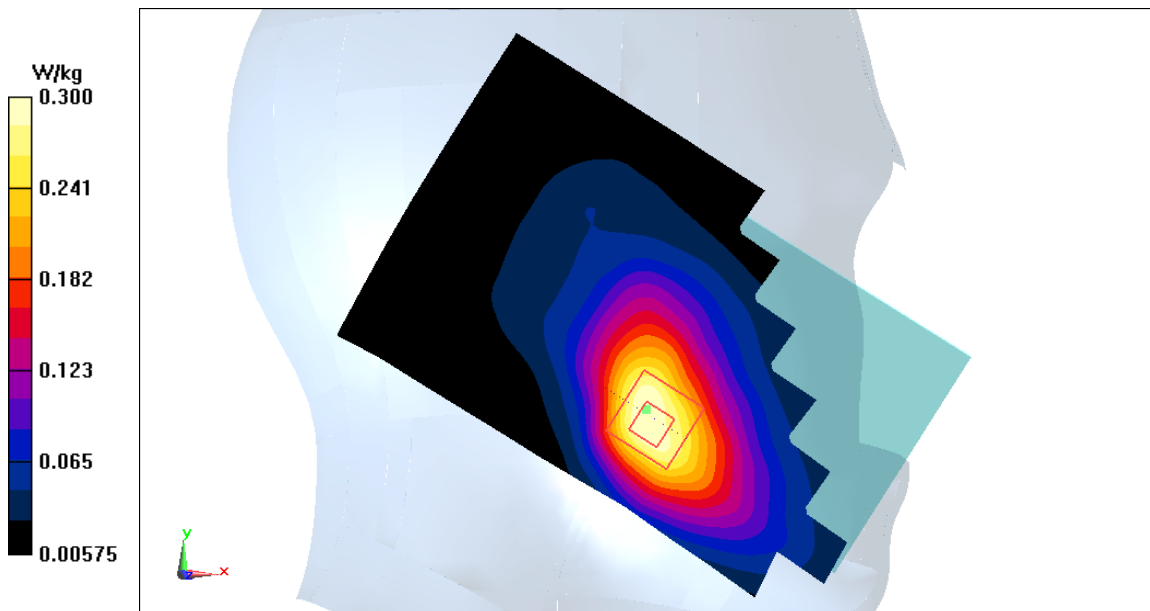


Figure A.7



**WCDMA1700-BIV\_CH1513 Bottom edge**

Date: 4/7/2017

Electronics: DAE4 Sn1331

Medium: Body 1750 MHz

Medium parameters used:  $f = 1752.6$  MHz;  $\sigma = 1.517$  mho/m;  $\epsilon_r = 53.21$ ;  $\rho = 1000$  kg/m<sup>3</sup>

Ambient Temperature: 22.5°C, Liquid Temperature: 23.3°C

Communication System: WCDMA1700-BIV 1752.6 MHz Duty Cycle: 1:1

Probe: EX3DV4 – SN3846 ConvF(7.90,7.90,7.90)

**Area Scan (71x121x1):** Interpolated grid: dx=1.000 mm, dy=1.000 mm

Maximum value of SAR (interpolated) = 0.498 W/kg

**Zoom Scan (7x7x7)/Cube 0:** Measurement grid: dx=5mm, dy=5mm, dz=5mm

Reference Value = 13.33 V/m; Power Drift = -0.18 dB

Peak SAR (extrapolated) = 0.673 W/kg

**SAR(1 g) = 0.375 W/kg; SAR(10 g) = 0.2 W/kg**

Maximum value of SAR (measured) = 0.457 W/kg

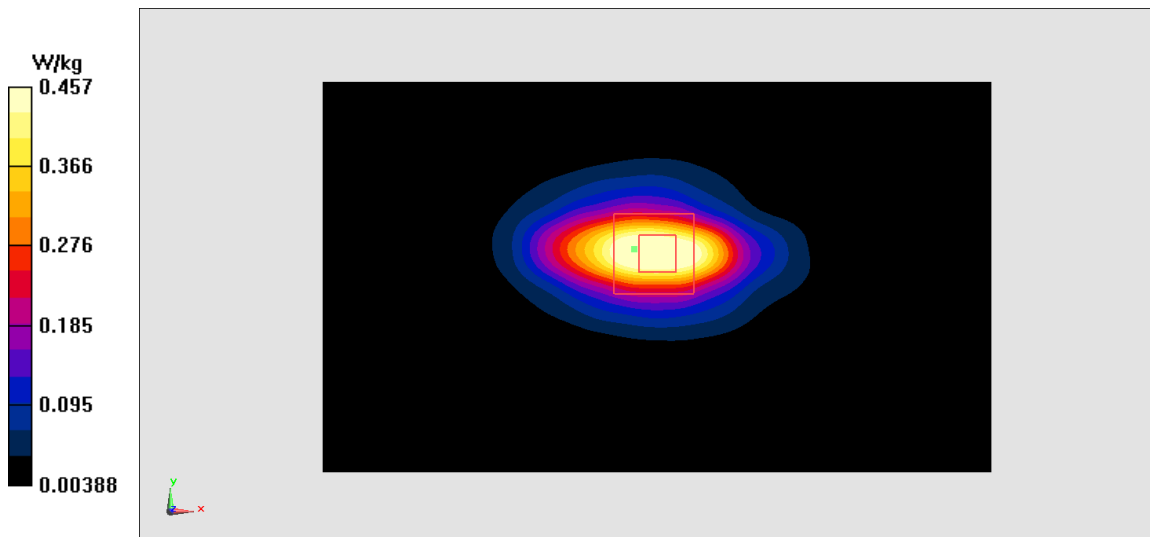


Figure A.8

**WCDMA850-BV\_CH4715 Right Cheek**

Date: 4/6/2017

Electronics: DAE4 Sn1331

Medium: Head 835 MHz

Medium parameters used:  $f = 835.4$  MHz;  $\sigma = 0.902$  mho/m;  $\epsilon_r = 41.59$ ;  $\rho = 1000$  kg/m<sup>3</sup>

Ambient Temperature: 22.5°C, Liquid Temperature: 23.3°C

Communication System: WCDMA850-BV 835.4 MHz Duty Cycle: 1:1

Probe: EX3DV4 – SN3846 ConvF(9.33,9.33,9.33)

**Area Scan (71x121x1):** Interpolated grid: dx=1.000 mm, dy=1.000 mm

Maximum value of SAR (interpolated) = 0.245 W/kg

**Zoom Scan (7x7x7)/Cube 0:** Measurement grid: dx=5mm, dy=5mm, dz=5mm

Reference Value = 7.234 V/m; Power Drift = -0.05 dB

Peak SAR (extrapolated) = 0.277 W/kg

**SAR(1 g) = 0.22 W/kg; SAR(10 g) = 0.17 W/kg**

Maximum value of SAR (measured) = 0.241 W/kg

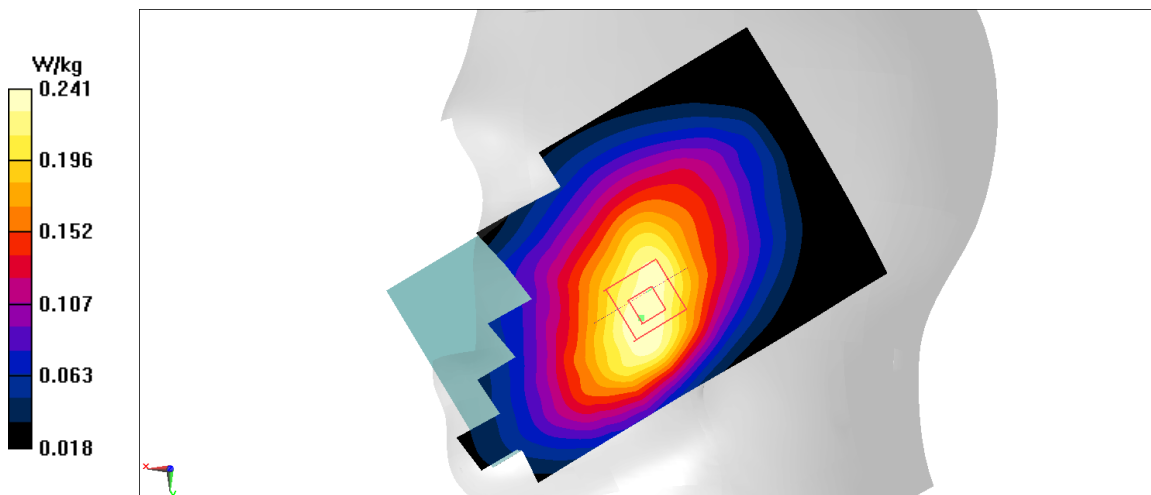


Figure A.9

**WCDMA850-BV\_CH4715 Right edge**

Date: 4/6/2017

Electronics: DAE4 Sn1331

Medium: Body 835 MHz

Medium parameters used:  $f = 835.4$  MHz;  $\sigma = 0.989$  mho/m;  $\epsilon_r = 56.09$ ;  $\rho = 1000$  kg/m<sup>3</sup>

Ambient Temperature: 22.5°C, Liquid Temperature: 23.3°C

Communication System: WCDMA850-BV 835.4 MHz Duty Cycle: 1:1

Probe: EX3DV4 – SN3846 ConvF(9.52,9.52,9.52)

**Area Scan (71x121x1):** Interpolated grid: dx=1.000 mm, dy=1.000 mm

Maximum value of SAR (interpolated) = 0.428 W/kg

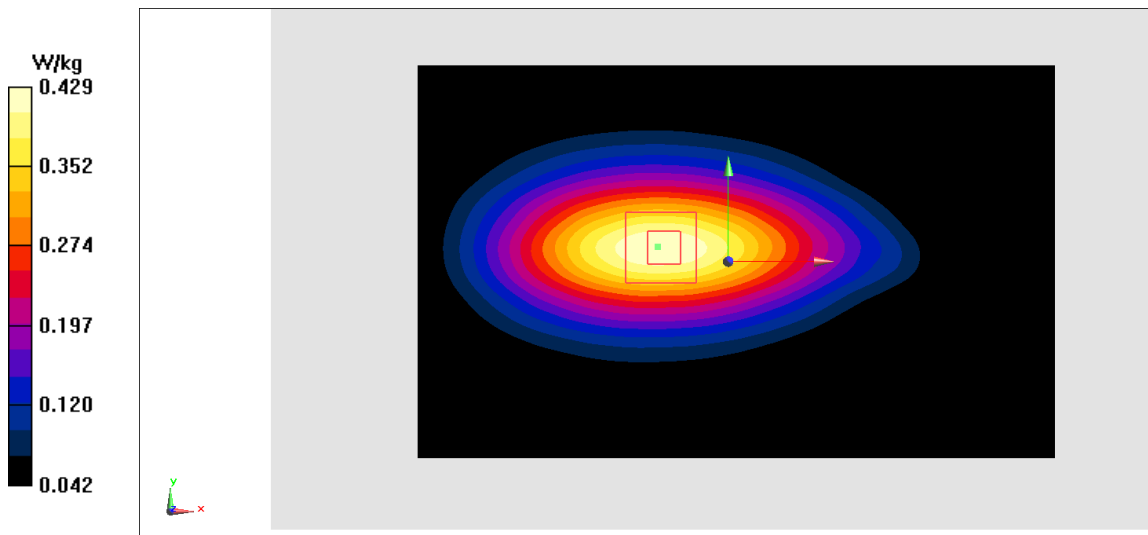
**Zoom Scan (7x7x7)/Cube 0:** Measurement grid: dx=5mm, dy=5mm, dz=5mm

Reference Value = 19.02 V/m; Power Drift = -0.12 dB

Peak SAR (extrapolated) = 0.538 W/kg

**SAR(1 g) = 0.374 W/kg; SAR(10 g) = 0.256 W/kg**

Maximum value of SAR (measured) = 0.429 W/kg



**Figure A.10**

**LTE1900-FDD2\_CH19100 Left Cheek**

Date: 4/8/2017

Electronics: DAE4 Sn1331

Medium: Head 1900 MHz

Medium parameters used:  $f = 1900$  MHz;  $\sigma = 1.39$  mho/m;  $\epsilon_r = 39.55$ ;  $\rho = 1000$  kg/m<sup>3</sup>

Ambient Temperature: 22.5°C, Liquid Temperature: 23.3°C

Communication System: LTE1900-FDD2 1900 MHz Duty Cycle: 1:1

Probe: EX3DV4 – SN3846 ConvF(7.89,7.89,7.89)

**Area Scan (71x121x1):** Interpolated grid: dx=1.000 mm, dy=1.000 mm

Maximum value of SAR (interpolated) = 0.38 W/kg

**Zoom Scan (7x7x7)/Cube 0:** Measurement grid: dx=5mm, dy=5mm, dz=5mm

Reference Value = 4.786 V/m; Power Drift = -0.06 dB

Peak SAR (extrapolated) = 0.477 W/kg

**SAR(1 g) = 0.328 W/kg; SAR(10 g) = 0.208 W/kg**

Maximum value of SAR (measured) = 0.38 W/kg

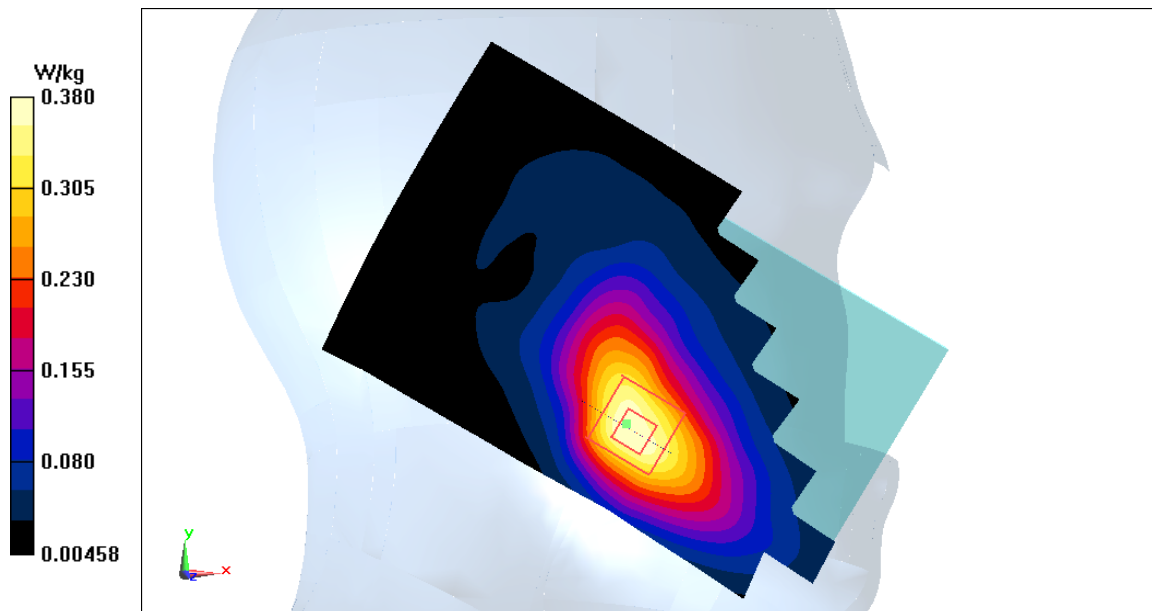


Figure A.11

**LTE1900-FDD2\_CH19100 Front**

Date: 4/8/2017

Electronics: DAE4 Sn1331

Medium: Body 1900 MHz

Medium parameters used:  $f = 1900$  MHz;  $\sigma = 1.536$  mho/m;  $\epsilon_r = 53.19$ ;  $\rho = 1000$  kg/m<sup>3</sup>

Ambient Temperature: 22.5°C, Liquid Temperature: 23.3°C

Communication System: LTE1900-FDD2 1900 MHz Duty Cycle: 1:1

Probe: EX3DV4 – SN3846 ConvF(7.57,7.57,7.57)

**Area Scan (71x121x1):** Interpolated grid: dx=1.000 mm, dy=1.000 mm

Maximum value of SAR (interpolated) = 0.535 W/kg

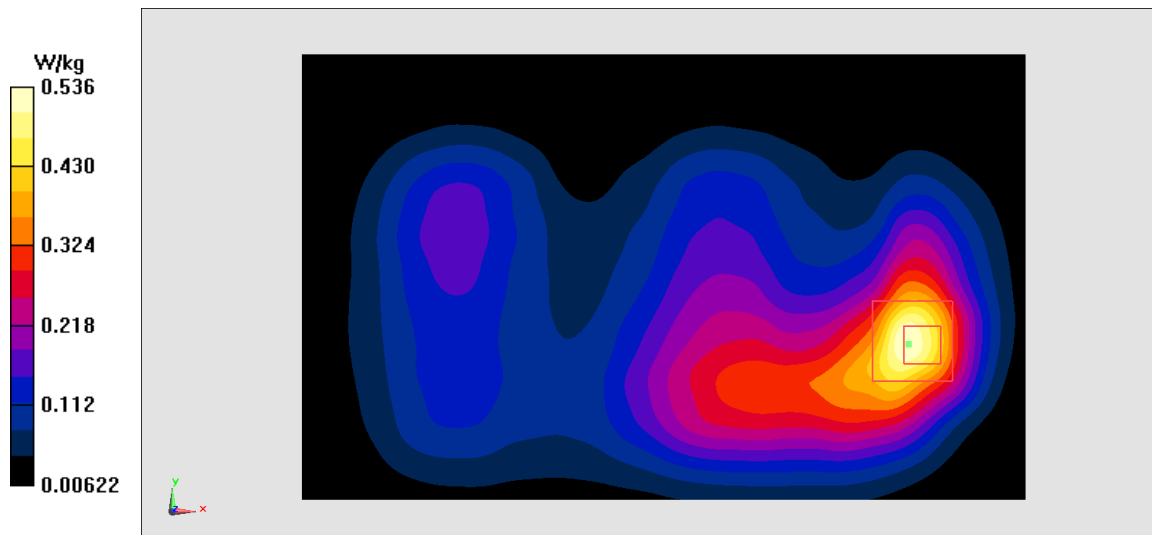
**Zoom Scan (7x7x7)/Cube 0:** Measurement grid: dx=5mm, dy=5mm, dz=5mm

Reference Value = 8.505 V/m; Power Drift = -0.03 dB

Peak SAR (extrapolated) = 0.766 W/kg

**SAR(1 g) = 0.426 W/kg; SAR(10 g) = 0.233 W/kg**

Maximum value of SAR (measured) = 0.536 W/kg



**Figure A.12**

**LTE1700-FDD4\_CH20050 Left Cheek**

Date: 4/7/2017

Electronics: DAE4 Sn1331

Medium: Head 1750 MHz

Medium parameters used:  $f = 1720$  MHz;  $\sigma = 1.352$  mho/m;  $\epsilon_r = 40.72$ ;  $\rho = 1000$  kg/m<sup>3</sup>

Ambient Temperature: 22.5°C, Liquid Temperature: 23.3°C

Communication System: LTE1700-FDD4 1720 MHz Duty Cycle: 1:1

Probe: EX3DV4 – SN3846 ConvF(8.16,8.16,8.16)

**Area Scan (71x121x1):** Interpolated grid: dx=1.000 mm, dy=1.000 mm

Maximum value of SAR (interpolated) = 0.154 W/kg

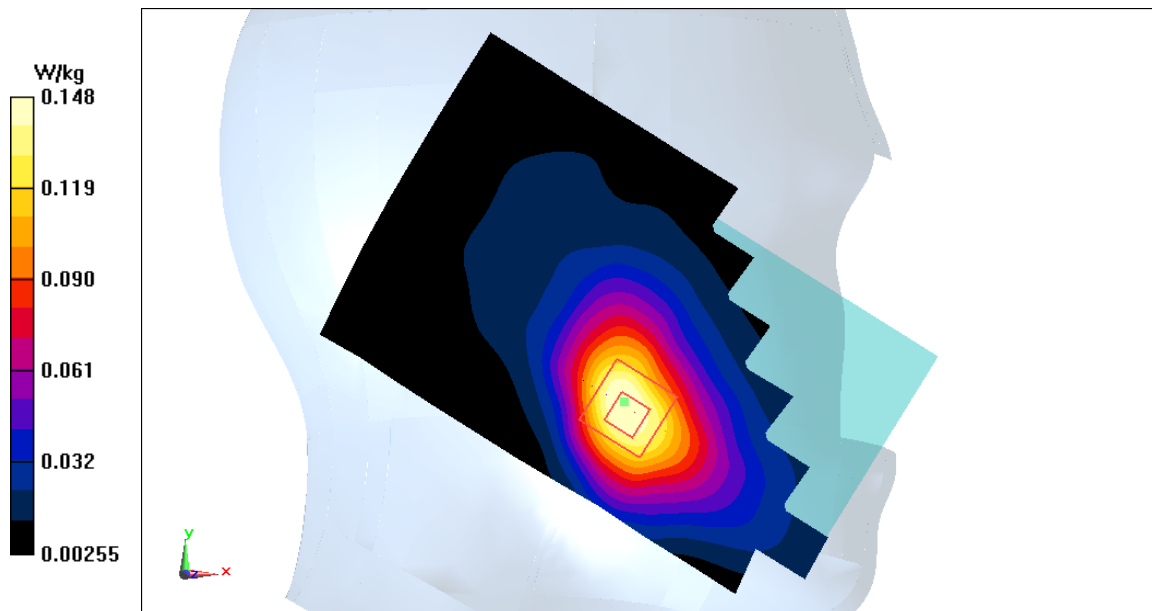
**Zoom Scan (7x7x7)/Cube 0:** Measurement grid: dx=5mm, dy=5mm, dz=5mm

Reference Value = 3.307 V/m; Power Drift = -0.12 dB

Peak SAR (extrapolated) = 0.186 W/kg

**SAR(1 g) = 0.13 W/kg; SAR(10 g) = 0.085 W/kg**

Maximum value of SAR (measured) = 0.148 W/kg



**Figure A.13**

**LTE1700-FDD4\_CH20050 Left edge**

Date: 4/7/2017

Electronics: DAE4 Sn1331

Medium: Body 1750 MHz

Medium parameters used:  $f = 1720$  MHz;  $\sigma = 1.486$  mho/m;  $\epsilon_r = 53.26$ ;  $\rho = 1000$  kg/m<sup>3</sup>

Ambient Temperature: 22.5°C, Liquid Temperature: 23.3°C

Communication System: LTE1700-FDD4 1720 MHz Duty Cycle: 1:1

Probe: EX3DV4 – SN3846 ConvF(7.90,7.90,7.90)

**Area Scan (71x121x1):** Interpolated grid: dx=1.000 mm, dy=1.000 mm

Maximum value of SAR (interpolated) = 0.217 W/kg

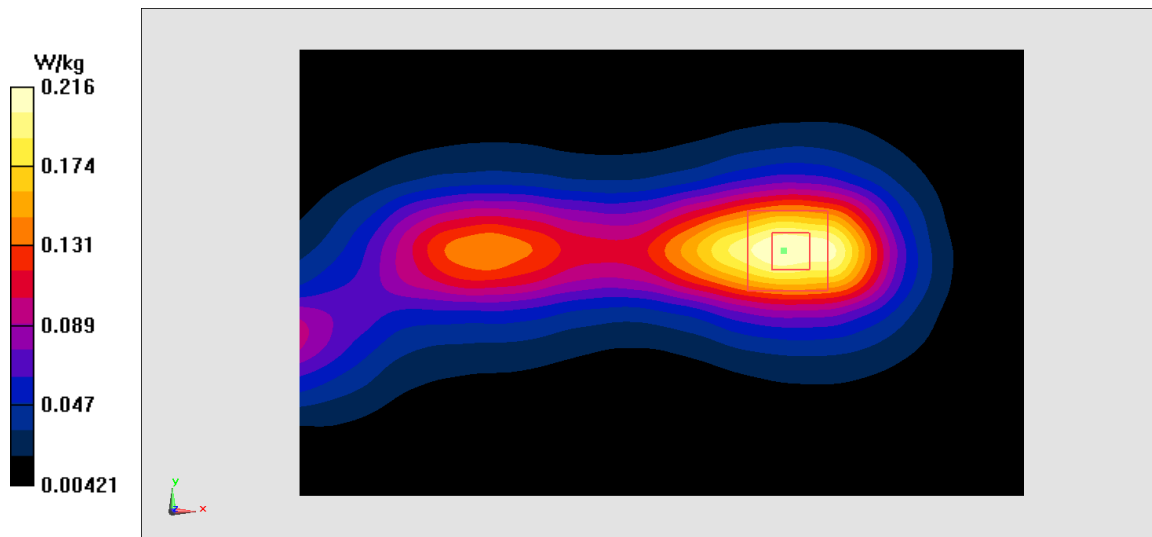
**Zoom Scan (7x7x7)/Cube 0:** Measurement grid: dx=5mm, dy=5mm, dz=5mm

Reference Value = 8.154 V/m; Power Drift = 0 dB

Peak SAR (extrapolated) = 0.289 W/kg

**SAR(1 g) = 0.179 W/kg; SAR(10 g) = 0.109 W/kg**

Maximum value of SAR (measured) = 0.216 W/kg



**Figure A.14**

**LTE2500-FDD7\_CH21350 Left Cheek**

Date: 4/10/2017

Electronics: DAE4 Sn1331

Medium: Head 2600 MHz

Medium parameters used:  $f = 2560$  MHz;  $\sigma = 1.928$  mho/m;  $\epsilon_r = 39.62$ ;  $\rho = 1000$  kg/m<sup>3</sup>

Ambient Temperature: 22.5°C, Liquid Temperature: 23.3°C

Communication System: LTE2500-FDD7 2560 MHz Duty Cycle: 1:1

Probe: EX3DV4 – SN3846 ConvF(7.12,7.12,7.12)

**Area Scan (71x121x1):** Interpolated grid: dx=1.000 mm, dy=1.000 mm

Maximum value of SAR (interpolated) = 0.418 W/kg

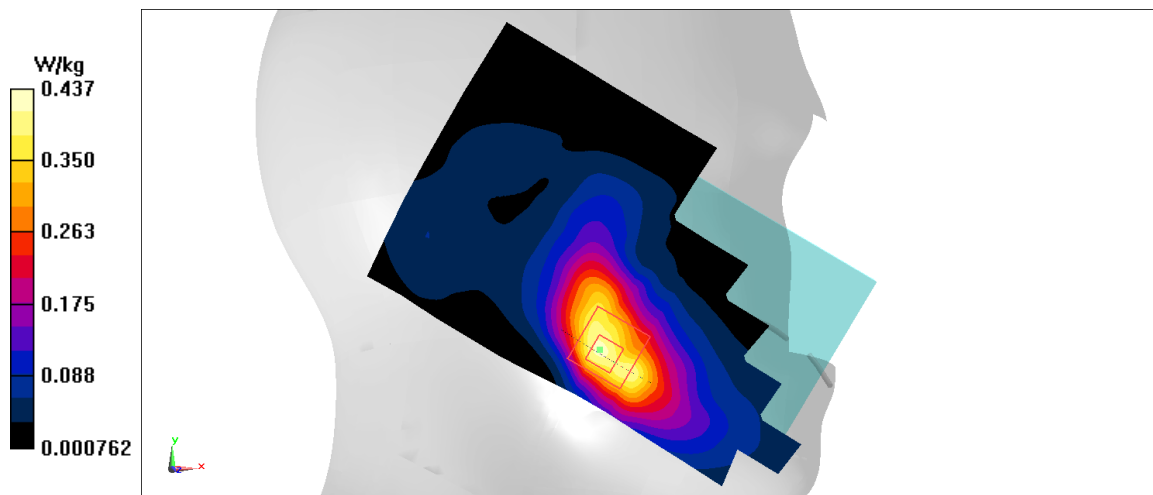
**Zoom Scan (7x7x7)/Cube 0:** Measurement grid: dx=5mm, dy=5mm, dz=5mm

Reference Value = 4.591 V/m; Power Drift = 0.06 dB

Peak SAR (extrapolated) = 0.626 W/kg

**SAR(1 g) = 0.368 W/kg; SAR(10 g) = 0.206 W/kg**

Maximum value of SAR (measured) = 0.437 W/kg



**Figure A.15**



**LTE2500-FDD7\_CH21350 Left edge**

Date: 4/10/2017

Electronics: DAE4 Sn1331

Medium: Body 2600 MHz

Medium parameters used:  $f = 2560$  MHz;  $\sigma = 2.1$  mho/m;  $\epsilon_r = 51.66$ ;  $\rho = 1000$  kg/m<sup>3</sup>

Ambient Temperature: 22.5°C, Liquid Temperature: 23.3°C

Communication System: LTE2500-FDD7 2560 MHz Duty Cycle: 1:1

Probe: EX3DV4 – SN3846 ConvF(7.25,7.25,7.25)

**Area Scan (71x121x1):** Interpolated grid: dx=1.000 mm, dy=1.000 mm

Maximum value of SAR (interpolated) = 0.58 W/kg

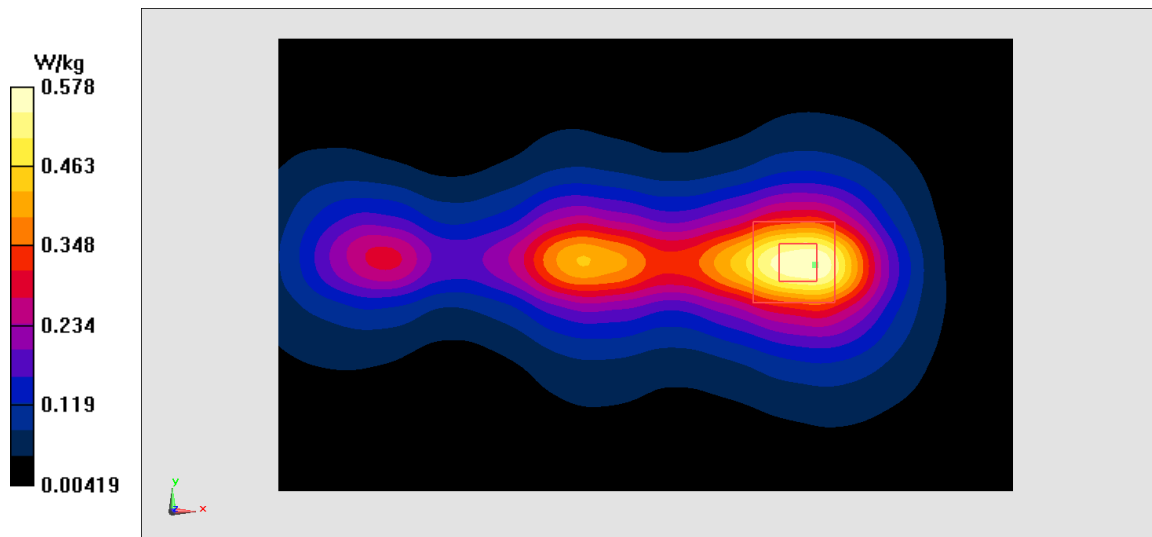
**Zoom Scan (7x7x7)/Cube 0:** Measurement grid: dx=5mm, dy=5mm, dz=5mm

Reference Value = 12.63 V/m; Power Drift = 0.05 dB

Peak SAR (extrapolated) = 0.842 W/kg

**SAR(1 g) = 0.461 W/kg; SAR(10 g) = 0.247 W/kg**

Maximum value of SAR (measured) = 0.578 W/kg



**Figure A.16**

**LTE700-FDD12\_CH23130 Right Cheek**

Date: 4/5/2017

Electronics: DAE4 Sn1331

Medium: Head 750 MHz

Medium parameters used:  $f = 711$  MHz;  $\sigma = 0.861$  mho/m;  $\epsilon_r = 41.75$ ;  $\rho = 1000$  kg/m<sup>3</sup>

Ambient Temperature: 22.5°C, Liquid Temperature: 23.3°C

Communication System: LTE700-FDD12 711 MHz Duty Cycle: 1:1

Probe: EX3DV4 – SN3846 ConvF(9.65,9.65,9.65)

**Area Scan (71x121x1):** Interpolated grid: dx=1.000 mm, dy=1.000 mm

Maximum value of SAR (interpolated) = 0.135 W/kg

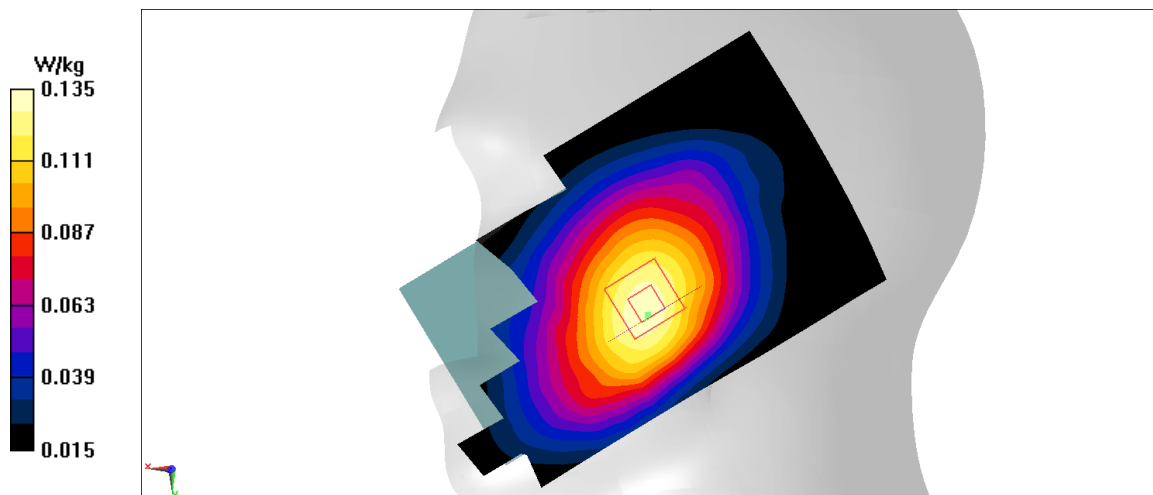
**Zoom Scan (7x7x7)/Cube 0:** Measurement grid: dx=5mm, dy=5mm, dz=5mm

Reference Value = 5.117 V/m; Power Drift = 0.02 dB

Peak SAR (extrapolated) = 0.157 W/kg

**SAR(1 g) = 0.124 W/kg; SAR(10 g) = 0.098 W/kg**

Maximum value of SAR (measured) = 0.135 W/kg



**Figure A.17**

**LTE700-FDD12\_CH23130 Right edge**

Date: 4/5/2017

Electronics: DAE4 Sn1331

Medium: Body 750 MHz

Medium parameters used:  $f = 711$  MHz;  $\sigma = 0.914$  mho/m;  $\epsilon_r = 55.4$ ;  $\rho = 1000$  kg/m<sup>3</sup>

Ambient Temperature: 22.5°C, Liquid Temperature: 23.3°C

Communication System: LTE700-FDD12 711 MHz Duty Cycle: 1:1

Probe: EX3DV4 – SN3846 ConvF(9.96,9.96,9.96)

**Area Scan (71x121x1):** Interpolated grid: dx=1.000 mm, dy=1.000 mm

Maximum value of SAR (interpolated) = 0.21 W/kg

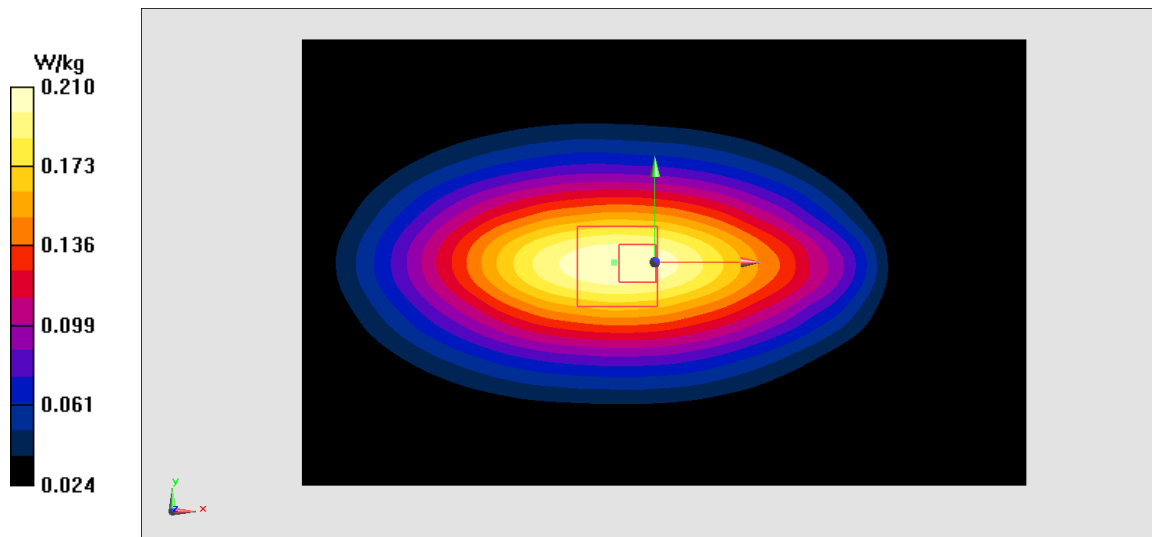
**Zoom Scan (7x7x7)/Cube 0:** Measurement grid: dx=5mm, dy=5mm, dz=5mm

Reference Value = 14.68 V/m; Power Drift = -0.08 dB

Peak SAR (extrapolated) = 0.261 W/kg

**SAR(1 g) = 0.182 W/kg; SAR(10 g) = 0.129 W/kg**

Maximum value of SAR (measured) = 0.21 W/kg



**Figure A.18**

**LTE2600-TDD38\_CH38150 Left Cheek**

Date: 4/10/2017

Electronics: DAE4 Sn1331

Medium: Head 2600 MHz

Medium parameters used:  $f = 2610$  MHz;  $\sigma = 1.976$  mho/m;  $\epsilon_r = 39.56$ ;  $\rho = 1000$  kg/m<sup>3</sup>

Ambient Temperature: 22.5°C, Liquid Temperature: 23.3°C

Communication System: LTE2600-TDD38 2610 MHz Duty Cycle: 1:1.58

Probe: EX3DV4 – SN3846 ConvF(7.12,7.12,7.12)

**Area Scan (71x121x1):** Interpolated grid: dx=1.000 mm, dy=1.000 mm

Maximum value of SAR (interpolated) = 0.175 W/kg

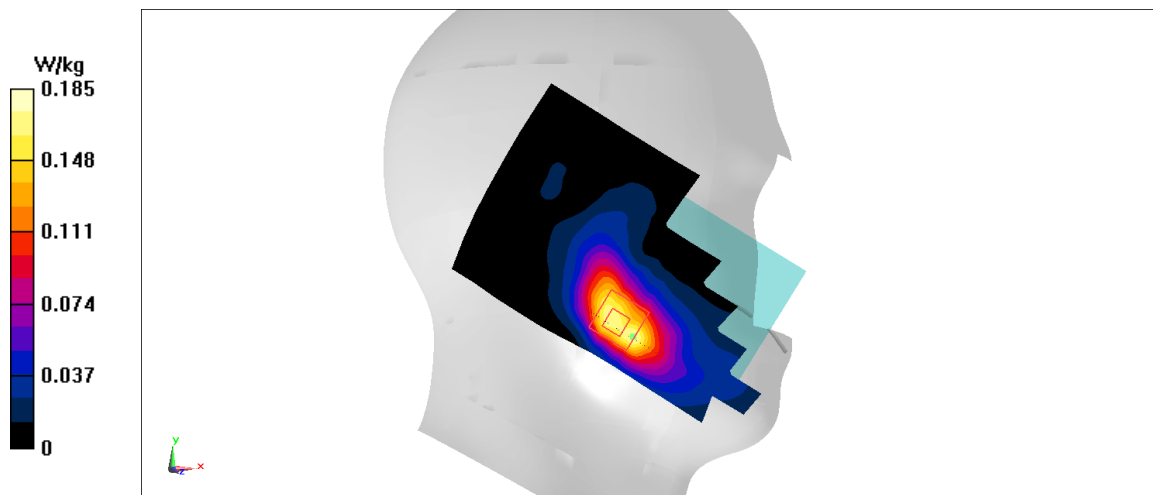
**Zoom Scan (7x7x7)/Cube 0:** Measurement grid: dx=5mm, dy=5mm, dz=5mm

Reference Value = 2.258 V/m; Power Drift = 0.02 dB

Peak SAR (extrapolated) = 0.272 W/kg

**SAR(1 g) = 0.2 W/kg; SAR(10 g) = 0.101 W/kg**

Maximum value of SAR (measured) = 0.185 W/kg



**Figure A.19**

**LTE2600-TDD38\_CH38150 Front**

Date: 4/10/2017

Electronics: DAE4 Sn1331

Medium: Body 2600 MHz

Medium parameters used:  $f = 2610$  MHz;  $\sigma = 2.148$  mho/m;  $\epsilon_r = 51.6$ ;  $\rho = 1000$  kg/m<sup>3</sup>

Ambient Temperature: 22.5°C, Liquid Temperature: 23.3°C

Communication System: LTE2600-TDD38 2610 MHz Duty Cycle: 1:1.58

Probe: EX3DV4 – SN3846 ConvF(7.25,7.25,7.25)

**Area Scan (71x121x1):** Interpolated grid: dx=1.000 mm, dy=1.000 mm

Maximum value of SAR (interpolated) = 0.176 W/kg

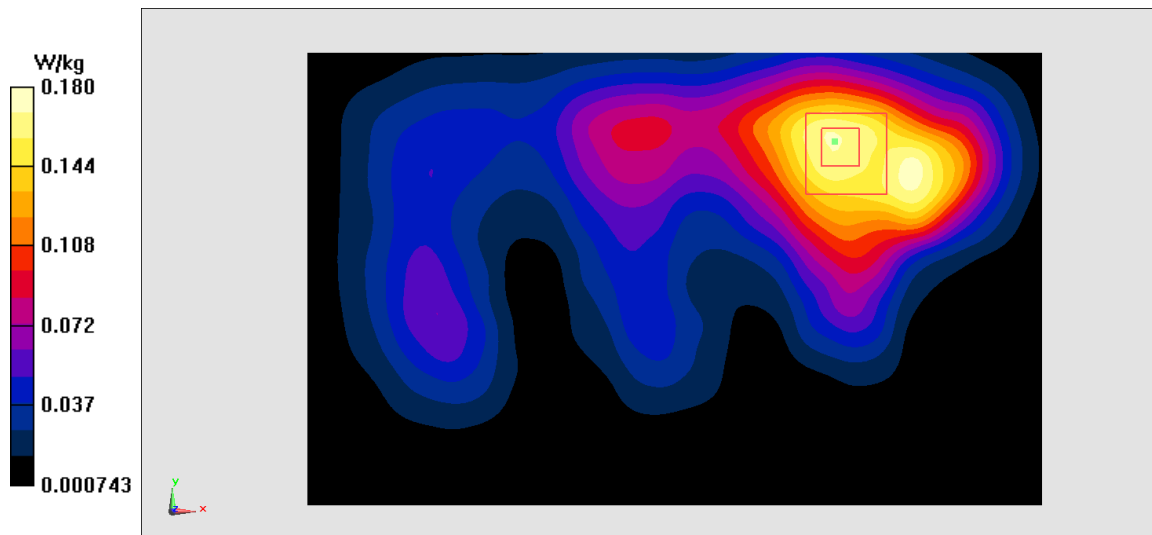
**Zoom Scan (7x7x7)/Cube 0:** Measurement grid: dx=5mm, dy=5mm, dz=5mm

Reference Value = 4.047 V/m; Power Drift = 0.05 dB

Peak SAR (extrapolated) = 0.265 W/kg

**SAR(1 g) = 0.146 W/kg; SAR(10 g) = 0.083 W/kg**

Maximum value of SAR (measured) = 0.18 W/kg



**Figure A.20**

**WLAN2450\_CH6 Right Cheek**

Date: 4/9/2017

Electronics: DAE4 Sn1331

Medium: Head 2450 MHz

Medium parameters used:  $f = 2437$  MHz;  $\sigma = 1.772$  mho/m;  $\epsilon_r = 39.07$ ;  $\rho = 1000$  kg/m<sup>3</sup>

Ambient Temperature: 22.5°C, Liquid Temperature: 23.3°C

Communication System: WLAN2450 2437 MHz Duty Cycle: 1:1

Probe: EX3DV4 – SN3846 ConvF(7.22,7.22,7.22)

**Area Scan (71x121x1):** Interpolated grid: dx=1.000 mm, dy=1.000 mm

Maximum value of SAR (interpolated) = 1.43 W/kg

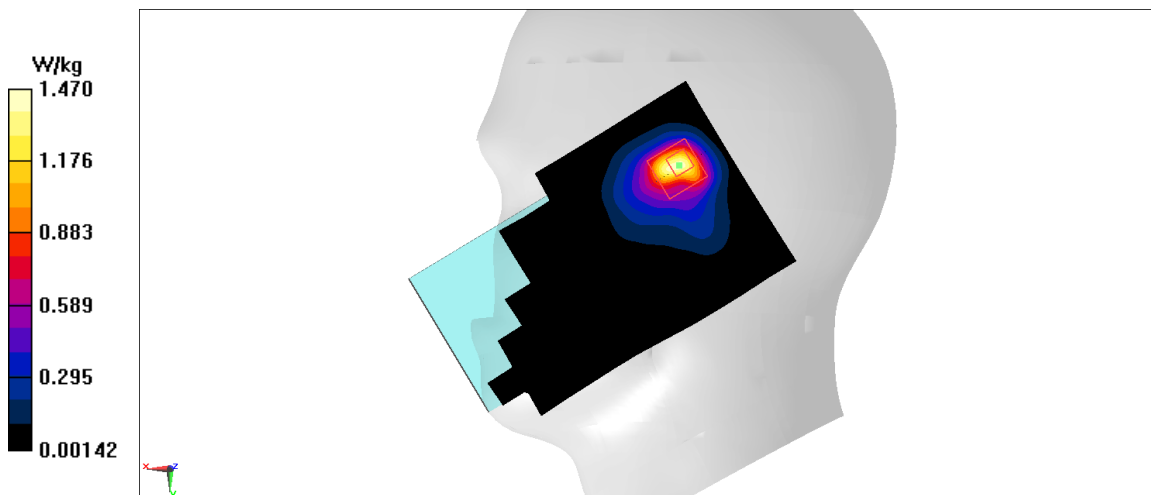
**Zoom Scan (7x7x7)/Cube 0:** Measurement grid: dx=5mm, dy=5mm, dz=5mm

Reference Value = 16.46 V/m; Power Drift = -0.09 dB

Peak SAR (extrapolated) = 3.25 W/kg

**SAR(1 g) = 1.13 W/kg; SAR(10 g) = 0.466 W/kg**

Maximum value of SAR (measured) = 1.47 W/kg



**Figure A.21**

**WLAN2450\_CH1 Front**

Date: 4/9/2017

Electronics: DAE4 Sn1331

Medium: Body 2450 MHz

Medium parameters used:  $f = 2412$  MHz;  $\sigma = 1.93$  mho/m;  $\epsilon_r = 53.41$ ;  $\rho = 1000$  kg/m<sup>3</sup>

Ambient Temperature: 22.5°C, Liquid Temperature: 23.3°C

Communication System: WLAN2450 2412 MHz Duty Cycle: 1:1

Probe: EX3DV4 – SN3846 ConvF(7.31,7.31,7.31)

**Area Scan (71x121x1):** Interpolated grid: dx=1.000 mm, dy=1.000 mm

Maximum value of SAR (interpolated) = 0.107 W/kg

**Zoom Scan (7x7x7)/Cube 0:** Measurement grid: dx=5mm, dy=5mm, dz=5mm

Reference Value = 2.469 V/m; Power Drift = 0.02 dB

Peak SAR (extrapolated) = 0.157 W/kg

**SAR(1 g) = 0.086 W/kg; SAR(10 g) = 0.047 W/kg**

Maximum value of SAR (measured) = 0.104 W/kg

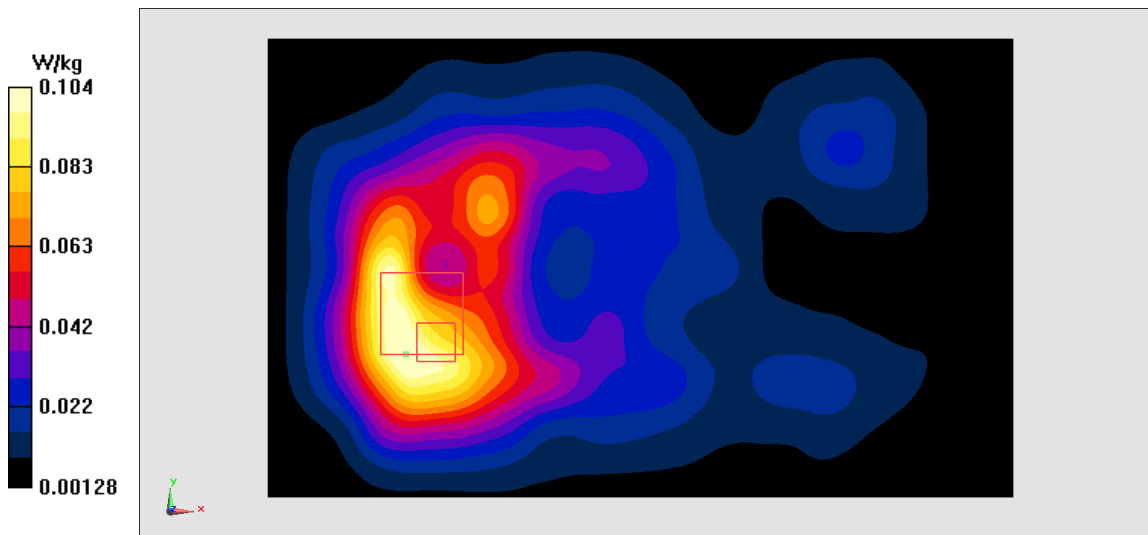


Figure A.22

### WLAN5G\_CH157 Right Cheek

Date: 4/11/2017

Electronics: DAE4 Sn1331

Medium: Head 5750 MHz

Medium parameters used:  $f = 5785$  MHz;  $\sigma = 5.447$  mho/m;  $\epsilon_r = 35.34$ ;  $\rho = 1000$  kg/m<sup>3</sup>

Ambient Temperature: 22.5°C, Liquid Temperature: 23.3°C

Communication System: WLAN5G 5785 MHz Duty Cycle: 1:1

Probe: EX3DV4 – SN3846 ConvF(4.95,4.95,4.95)

**Area Scan (71x121x1):** Interpolated grid: dx=1.000 mm, dy=1.000 mm

Maximum value of SAR (interpolated) = 3.21 W/kg

**Zoom Scan (7x7x7)/Cube 0:** Measurement grid: dx=5mm, dy=5mm, dz=5mm

Reference Value = 17.19 V/m; Power Drift = 0.1 dB

Peak SAR (extrapolated) = 6.25 W/kg

**SAR(1 g) = 1.07 W/kg; SAR(10 g) = 0.299 W/kg**

Maximum value of SAR (measured) = 3.25 W/kg

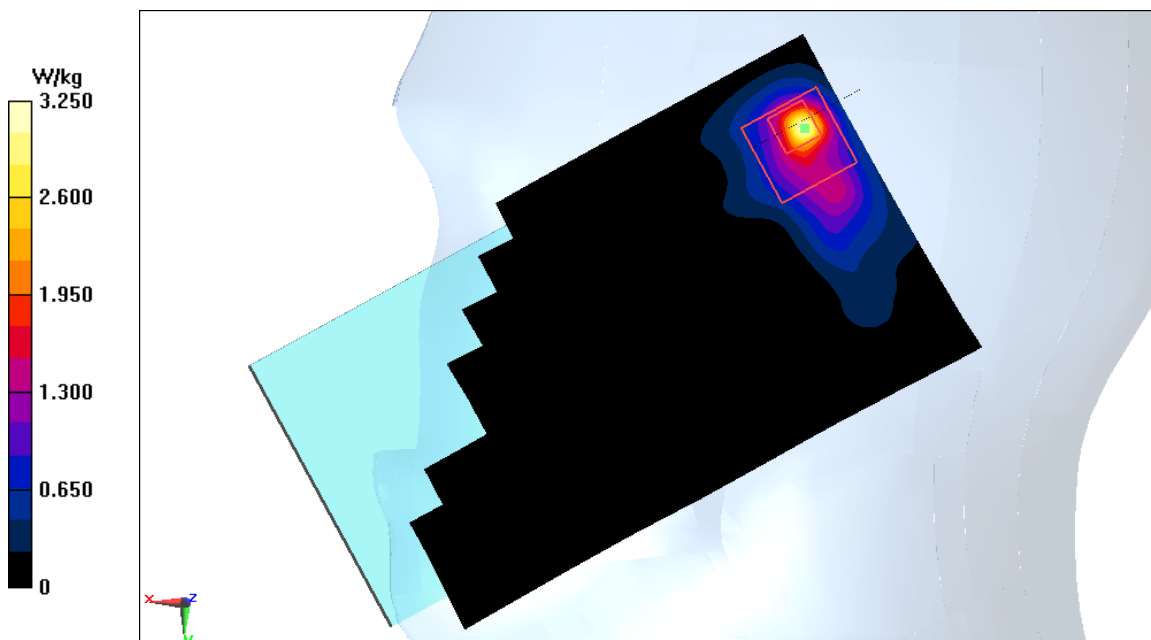


Figure A.23



### WLAN5G\_CH157 Top

Date: 4/11/2017

Electronics: DAE4 Sn1331

Medium: Body 5750 MHz

Medium parameters used:  $f = 5785$  MHz;  $\sigma = 6.025$  mho/m;  $\epsilon_r = 46.74$ ;  $\rho = 1000$  kg/m<sup>3</sup>

Ambient Temperature: 22.5°C, Liquid Temperature: 23.3°C

Communication System: WLAN5G 5785 MHz Duty Cycle: 1:1

Probe: EX3DV4 – SN3846 ConvF(4.53,4.53,4.53)

**Area Scan (71x121x1):** Interpolated grid: dx=1.000 mm, dy=1.000 mm

Maximum value of SAR (interpolated) = 0.175 W/kg

**Zoom Scan (7x7x7)/Cube 0:** Measurement grid: dx=5mm, dy=5mm, dz=5mm

Reference Value = 4.408 V/m; Power Drift = 0.04 dB

Peak SAR (extrapolated) = 0.221 W/kg

**SAR(1 g) = 0.051 W/kg; SAR(10 g) = 0.018 W/kg**

Maximum value of SAR (measured) = 0.137 W/kg

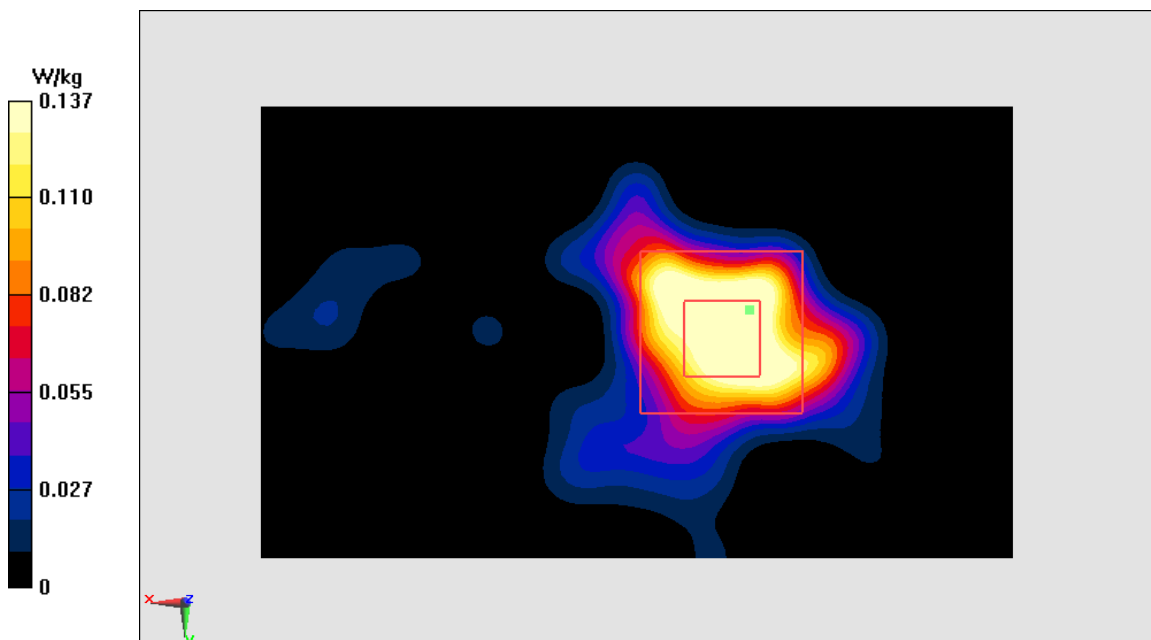
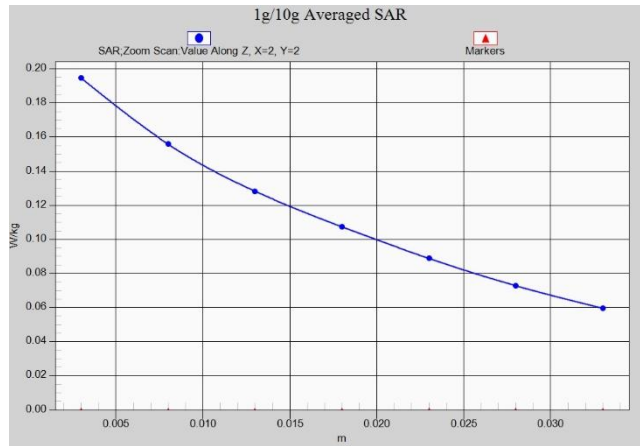
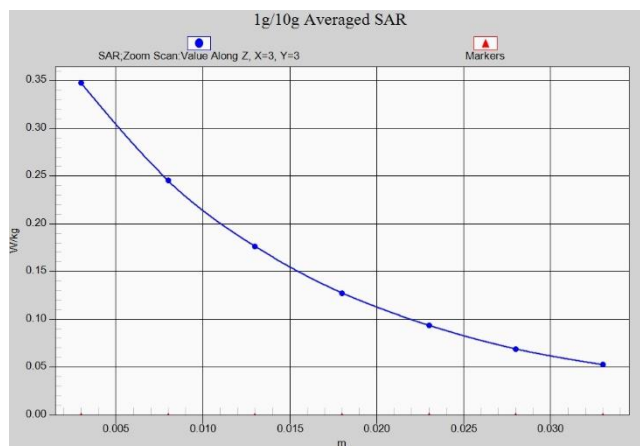


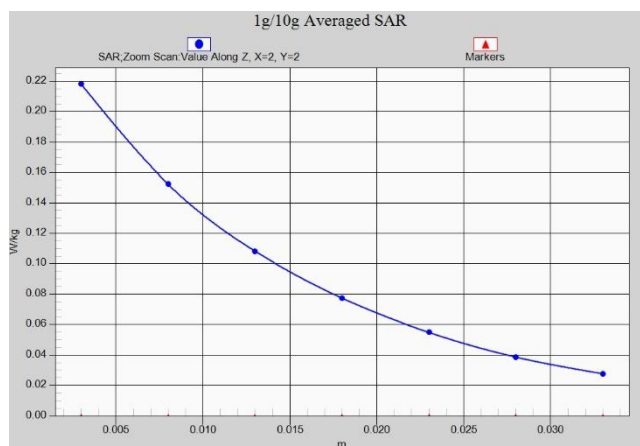
Figure A.24



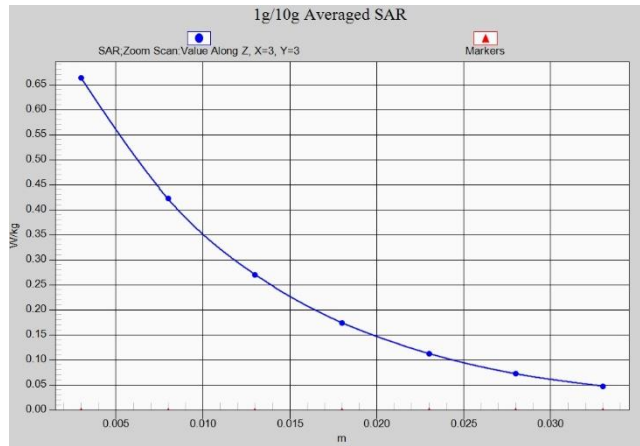
**Fig.1- 1 Z-Scan at power reference point (850 MHz)**



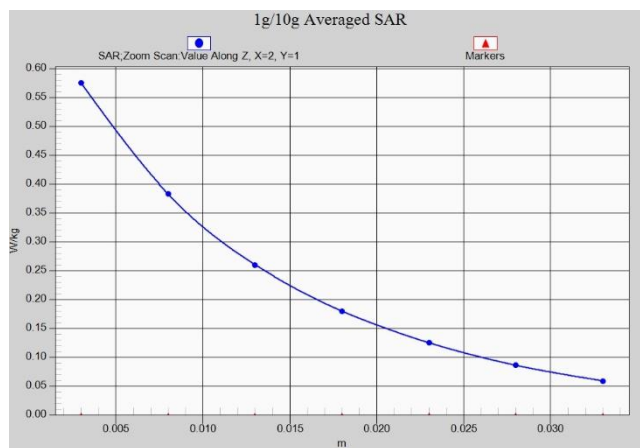
**Fig.1- 2 Z-Scan at power reference point (850 MHz)**



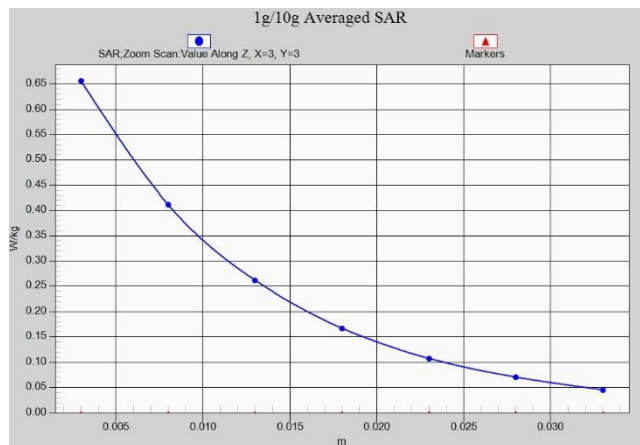
**Fig.1- 3 Z-Scan at power reference point (1900 MHz)**



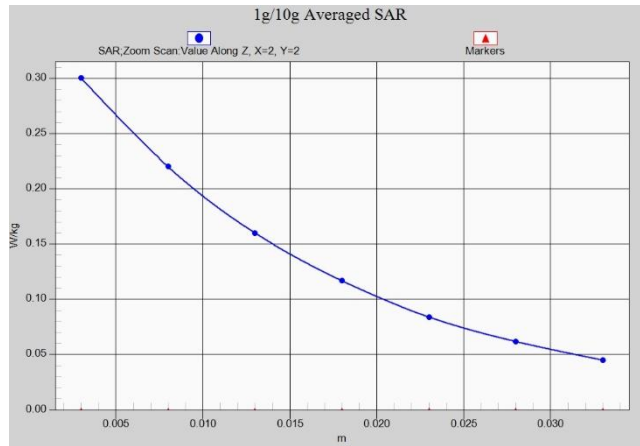
**Fig.1- 4 Z-Scan at power reference point (1900 MHz)**



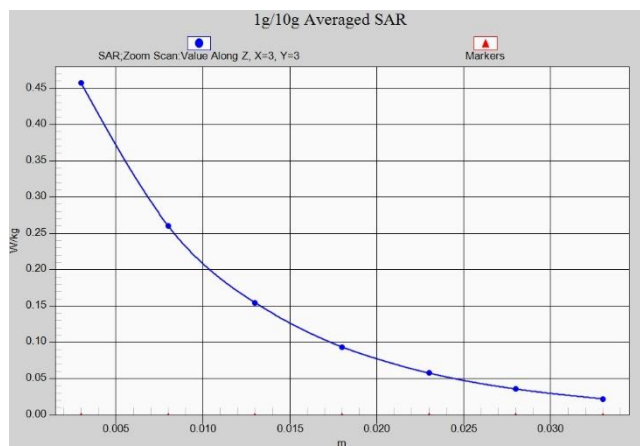
**Fig.1- 5 Z-Scan at power reference point (W1900)**



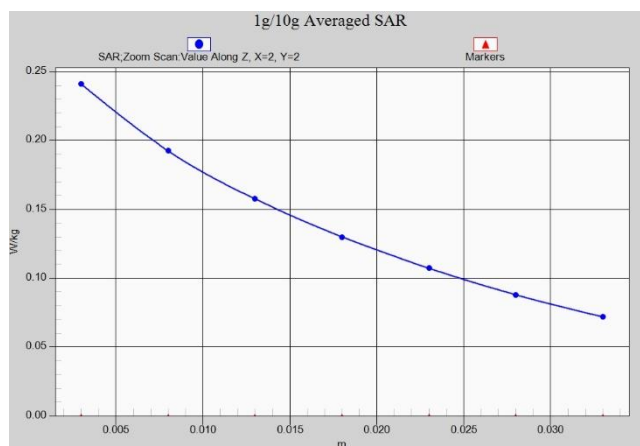
**Fig.1- 6 Z-Scan at power reference point (W1900)**



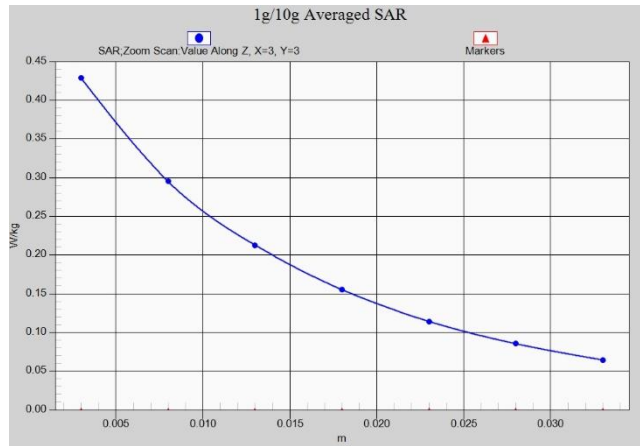
**Fig.1- 7 Z-Scan at power reference point (W1700)**



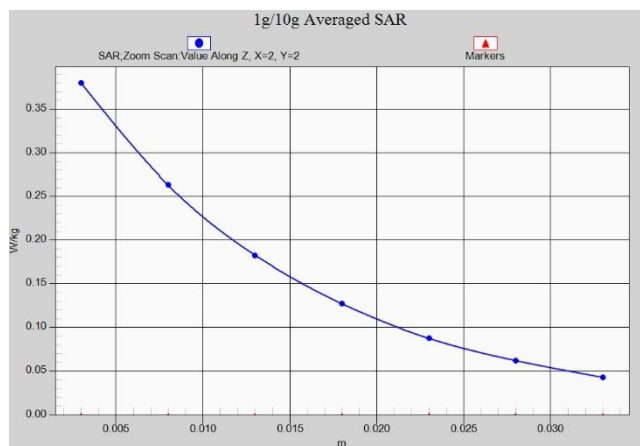
**Fig.1- 8 Z-Scan at power reference point (W1700)**



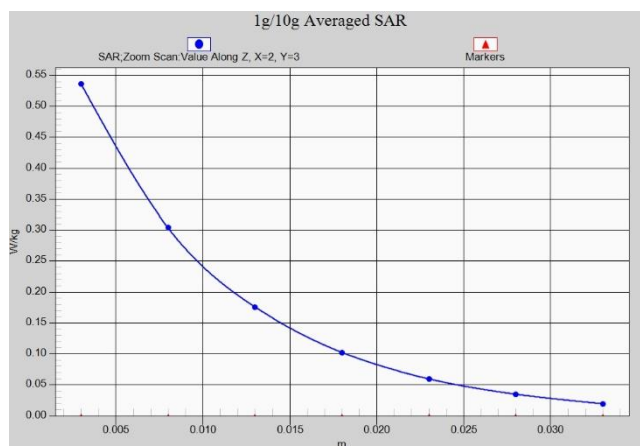
**Fig.1- 9 Z-Scan at power reference point (W850)**



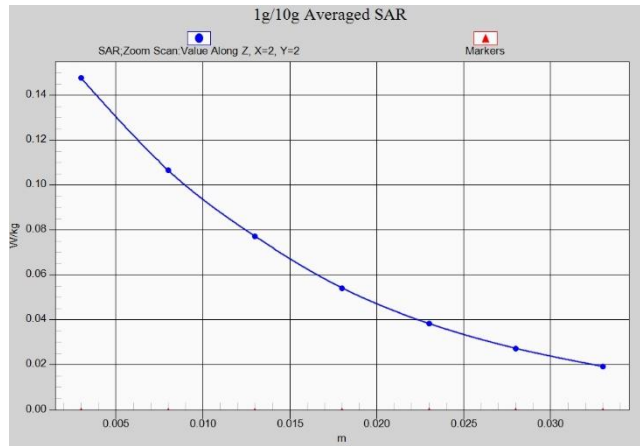
**Fig.1- 10 Z-Scan at power reference point (W850)**



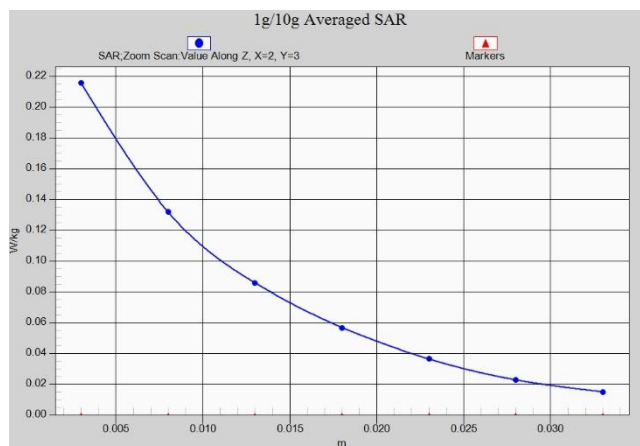
**Fig.1- 11 Z-Scan at power reference point (LTE band2)**



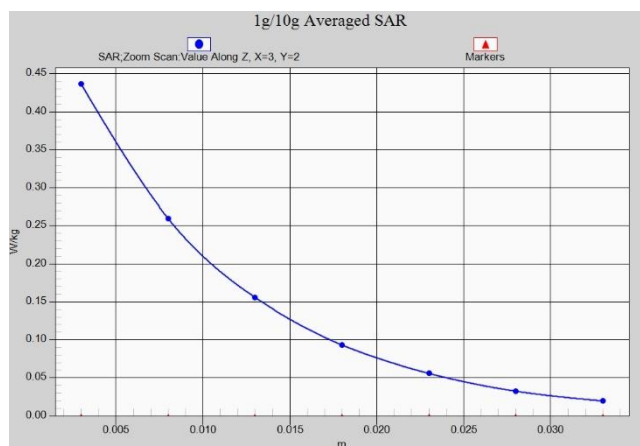
**Fig.1- 12 Z-Scan at power reference point (LTE band2)**



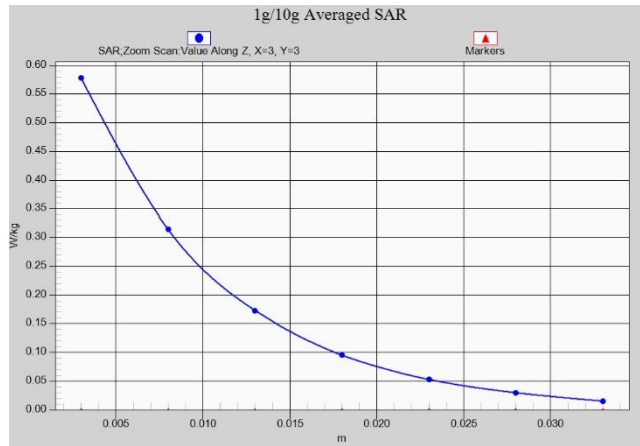
**Fig.1- 13 Z-Scan at power reference point (LTE band4)**



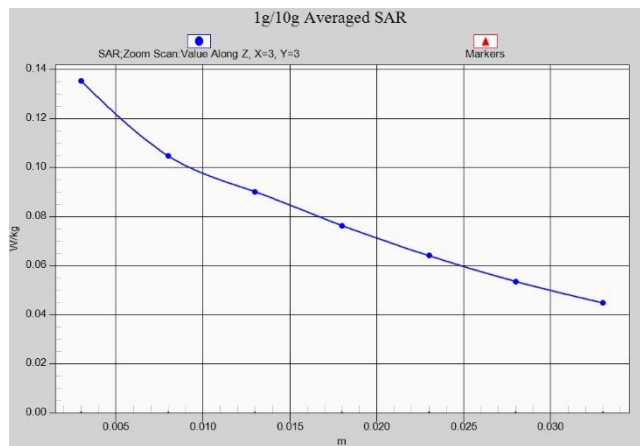
**Fig.1- 14 Z-Scan at power reference point (LTE band4)**



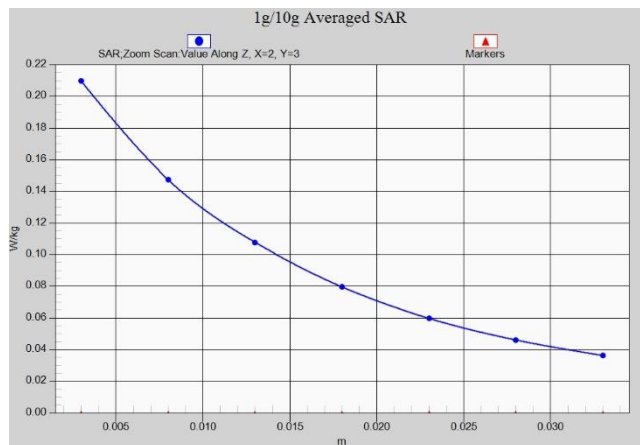
**Fig.1- 15 Z-Scan at power reference point (LTE band7)**



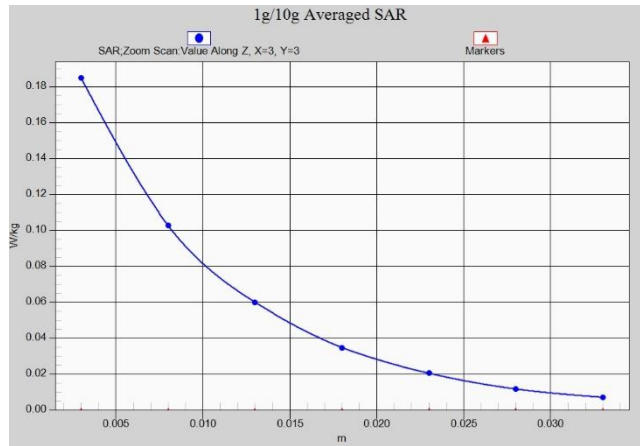
**Fig.1- 16 Z-Scan at power reference point (LTE band7)**



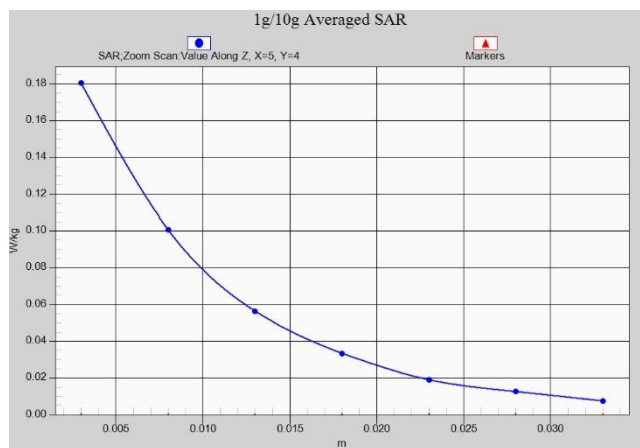
**Fig.1- 17 Z-Scan at power reference point (LTE band12)**



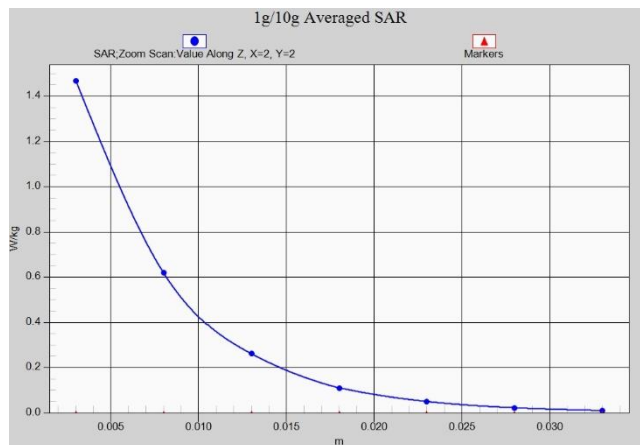
**Fig.1- 18 Z-Scan at power reference point (LTE band12)**



**Fig.1- 19 Z-Scan at power reference point (LTE band38)**

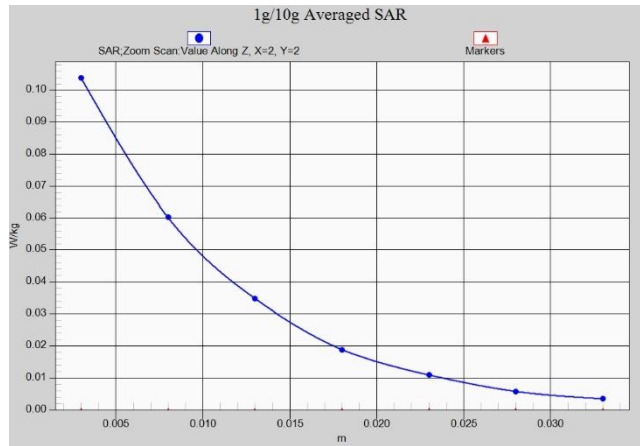


**Fig.1- 20 Z-Scan at power reference point (LTE band38)**

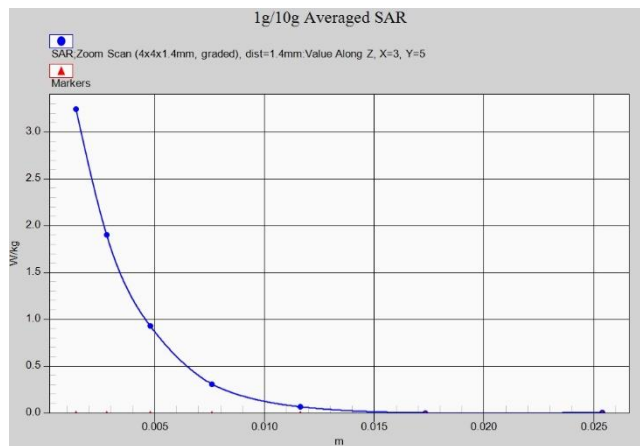


**Fig.1- 21 Z-Scan at power reference point (WLAN2450)**

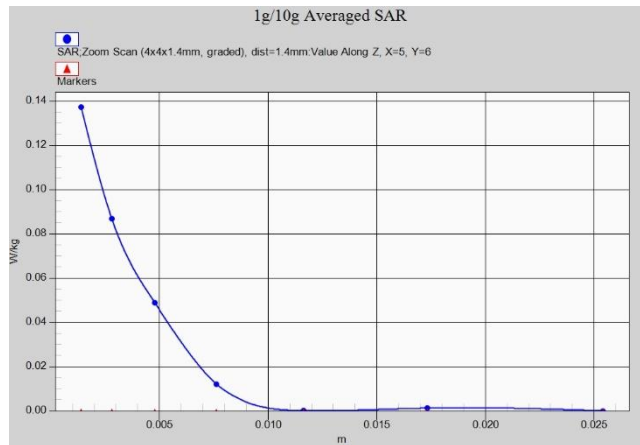




**Fig.1- 22 Z-Scan at power reference point (WLAN2450)**



**Fig.1- 23 Z-Scan at power reference point (WLAN5G)**



**Fig.1- 24 Z-Scan at power reference point (WLAN5G)**

## ANNEX B System Verification Results

### 750 MHz

Date: 4/5/2017

Electronics: DAE4 Sn1331

Medium: Head 750 MHz

Medium parameters used:  $f = 750$  MHz;  $\sigma = 0.898$  mho/m;  $\epsilon_r = 41.7$ ;  $\rho = 1000$  kg/m<sup>3</sup>

Ambient Temperature: 22.5°C Liquid Temperature: 23.3°C

Communication System: CW Frequency: 750 MHz Duty Cycle: 1:1

Probe: EX3DV4 – SN3846 ConvF(8.16,8.16,8.16)

**System Validation /Area Scan (81x191x1):** Interpolated grid: dx=1.000 mm, dy=1.000 mm

Reference Value = 59.58 V/m; Power Drift = 0.01

**Fast SAR: SAR(1 g) = 2.05 W/kg; SAR(10 g) = 1.39 W/kg**

Maximum value of SAR (interpolated) = 2.75 W/kg

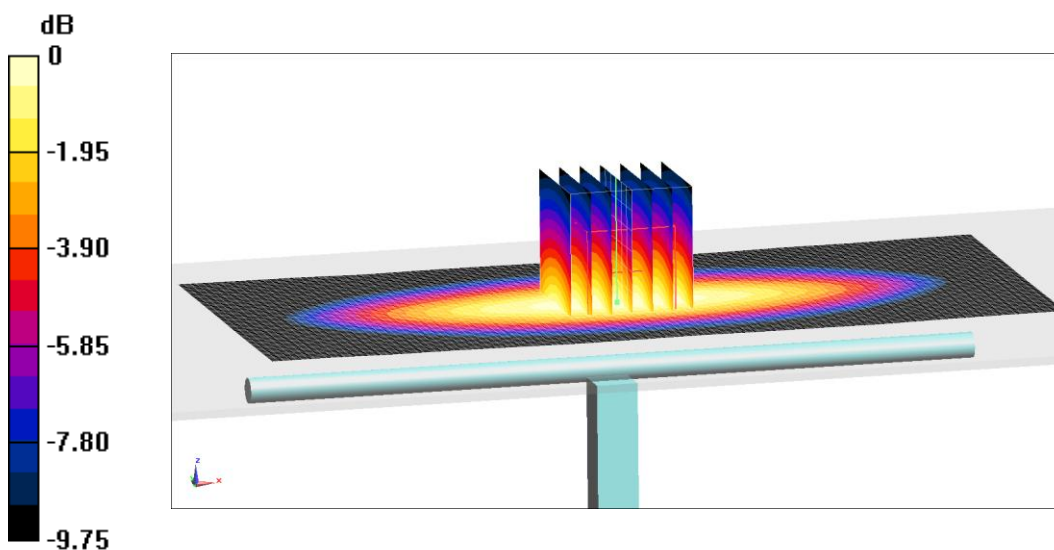
**System Validation /Zoom Scan (7x7x7)/Cube 0:** Measurement grid: dx=5mm, dy=5mm, dz=5mm

Reference Value = 59.58 V/m; Power Drift = 0.01 dB

Peak SAR (extrapolated) = 3.16 W/kg

**SAR(1 g) = 2.08 W/kg; SAR(10 g) = 1.35 W/kg**

Maximum value of SAR (measured) = 2.83 W/kg



0 dB = 2.83 W/kg = 4.52 dB W/kg

**Fig.B.1 validation 750 MHz 250mW**

## 750 MHz

Date: 4/5/2017

Electronics: DAE4 Sn1331

Medium: Body 750 MHz

Medium parameters used:  $f = 750 \text{ MHz}$ ;  $\sigma = 0.951 \text{ mho/m}$ ;  $\epsilon_r = 55.35$ ;  $\rho = 1000 \text{ kg/m}^3$

Ambient Temperature:  $22.5^\circ\text{C}$  Liquid Temperature:  $23.3^\circ\text{C}$

Communication System: CW Frequency: 750 MHz Duty Cycle: 1:1

Probe: EX3DV4 – SN3846 ConvF(7.9,7.9,7.9)

**System Validation /Area Scan (81x191x1):** Interpolated grid:  $dx=1.000 \text{ mm}$ ,  $dy=1.000 \text{ mm}$

Reference Value =  $56.94 \text{ V/m}$ ; Power Drift =  $-0.01$

**Fast SAR: SAR(1 g) =  $2.08 \text{ W/kg}$ ; SAR(10 g) =  $1.41 \text{ W/kg}$**

Maximum value of SAR (interpolated) =  $2.84 \text{ W/kg}$

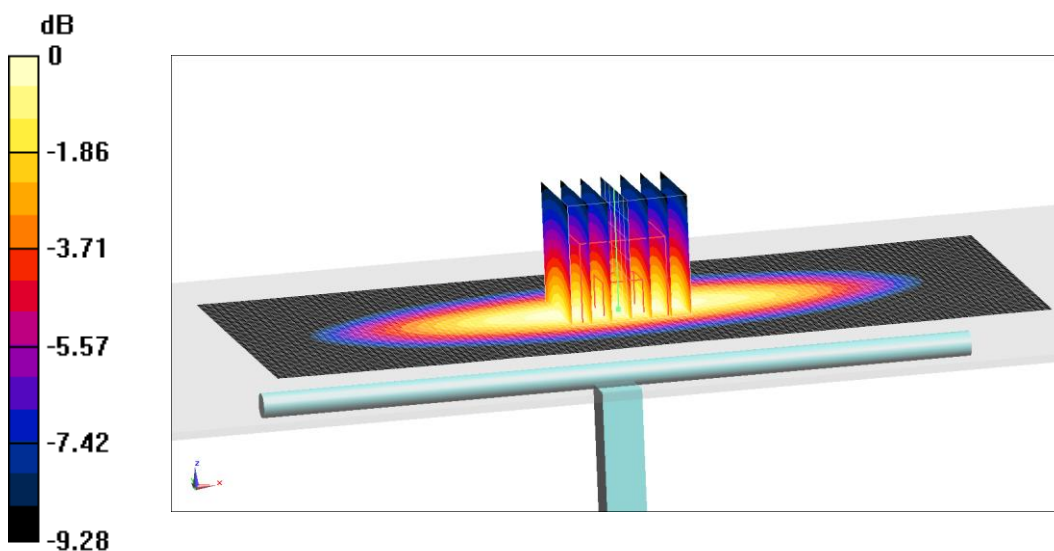
**System Validation /Zoom Scan (7x7x7)/Cube 0:** Measurement grid:  $dx=5\text{mm}$ ,  $dy=5\text{mm}$ ,  $dz=5\text{mm}$

Reference Value =  $56.94 \text{ V/m}$ ; Power Drift =  $-0.01 \text{ dB}$

Peak SAR (extrapolated) =  $3.33 \text{ W/kg}$

**SAR(1 g) =  $2.12 \text{ W/kg}$ ; SAR(10 g) =  $1.42 \text{ W/kg}$**

Maximum value of SAR (measured) =  $2.97 \text{ W/kg}$



$0 \text{ dB} = 2.97 \text{ W/kg} = 4.73 \text{ dB W/kg}$

**Fig.B.2 validation 750 MHz 250mW**

## 835 MHz

Date: 4/6/2017

Electronics: DAE4 Sn1331

Medium: Head 835 MHz

Medium parameters used:  $f = 835 \text{ MHz}$ ;  $\sigma = 0.901 \text{ mho/m}$ ;  $\epsilon_r = 41.6$ ;  $\rho = 1000 \text{ kg/m}^3$

Ambient Temperature:  $22.5^\circ\text{C}$  Liquid Temperature:  $23.3^\circ\text{C}$

Communication System: CW Frequency: 835 MHz Duty Cycle: 1:1

Probe: EX3DV4 – SN3846 ConvF(9.33,9.33,9.33)

**System Validation /Area Scan (81x191x1):** Interpolated grid:  $dx=1.000 \text{ mm}$ ,  $dy=1.000 \text{ mm}$

Reference Value =  $61.02 \text{ V/m}$ ; Power Drift = 0.01

**Fast SAR: SAR(1 g) = 2.36 W/kg; SAR(10 g) = 1.53 W/kg**

Maximum value of SAR (interpolated) =  $3.27 \text{ W/kg}$

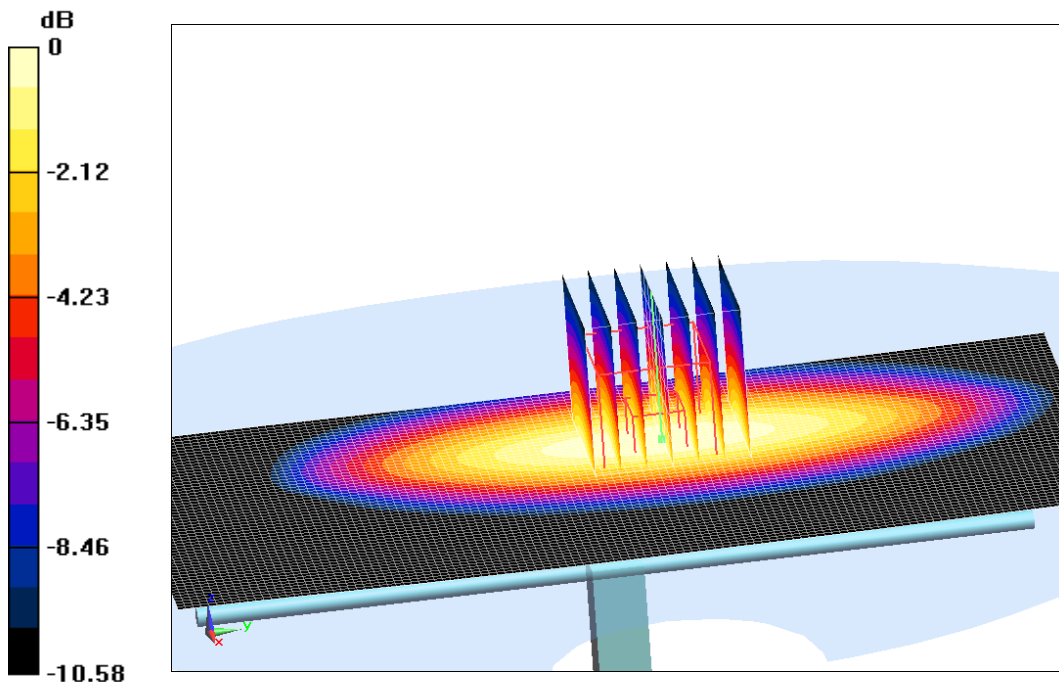
**System Validation /Zoom Scan (7x7x7)/Cube 0:** Measurement grid:  $dx=5\text{mm}$ ,  $dy=5\text{mm}$ ,  $dz=5\text{mm}$

Reference Value =  $61.02 \text{ V/m}$ ; Power Drift = 0.01 dB

Peak SAR (extrapolated) =  $3.72 \text{ W/kg}$

**SAR(1 g) = 2.39 W/kg; SAR(10 g) = 1.55 W/kg**

Maximum value of SAR (measured) =  $3.35 \text{ W/kg}$



0 dB =  $3.35 \text{ W/kg} = 5.25 \text{ dB W/kg}$

**Fig.B.3 validation 835 MHz 250mW**

## 835 MHz

Date: 4/6/2017

Electronics: DAE4 Sn1331

Medium: Body 835 MHz

Medium parameters used:  $f = 835 \text{ MHz}$ ;  $\sigma = 0.988 \text{ mho/m}$ ;  $\epsilon_r = 56.1$ ;  $\rho = 1000 \text{ kg/m}^3$

Ambient Temperature:  $22.5^\circ\text{C}$  Liquid Temperature:  $23.3^\circ\text{C}$

Communication System: CW Frequency: 835 MHz Duty Cycle: 1:1

Probe: EX3DV4 – SN3846 ConvF(9.52,9.52,9.52)

**System Validation /Area Scan (81x191x1):** Interpolated grid:  $dx=1.000 \text{ mm}$ ,  $dy=1.000 \text{ mm}$

Reference Value =  $60.5 \text{ V/m}$ ; Power Drift =  $-0.03$

**Fast SAR: SAR(1 g) =  $2.33 \text{ W/kg}$ ; SAR(10 g) =  $1.53 \text{ W/kg}$**

Maximum value of SAR (interpolated) =  $3.43 \text{ W/kg}$

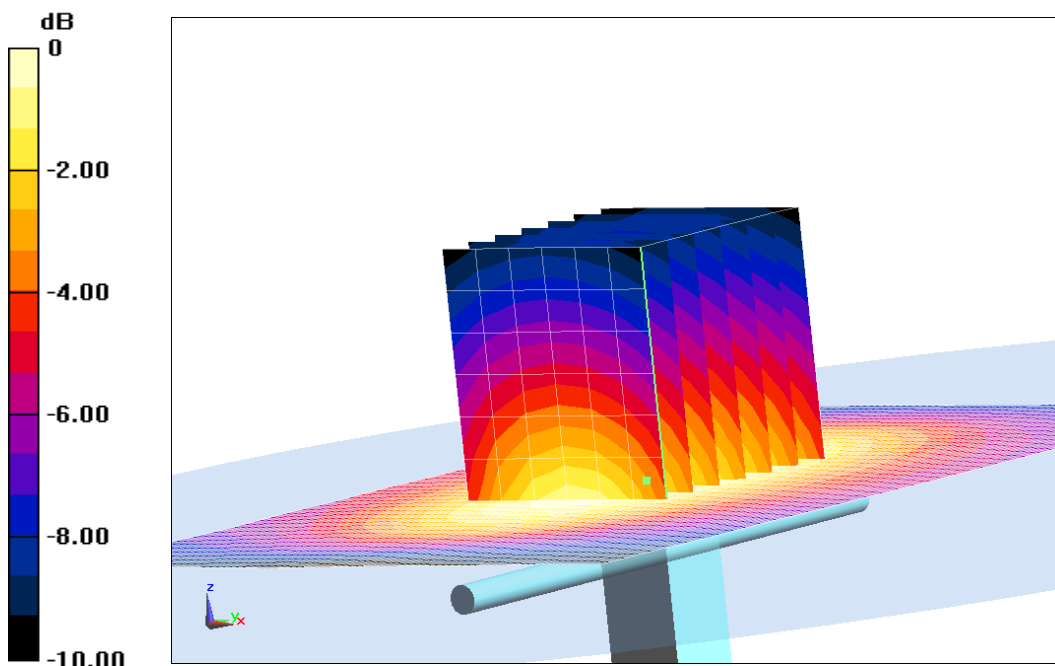
**System Validation /Zoom Scan (7x7x7)/Cube 0:** Measurement grid:  $dx=5\text{mm}$ ,  $dy=5\text{mm}$ ,  $dz=5\text{mm}$

Reference Value =  $60.5 \text{ V/m}$ ; Power Drift =  $-0.03 \text{ dB}$

Peak SAR (extrapolated) =  $3.71 \text{ W/kg}$

**SAR(1 g) =  $2.32 \text{ W/kg}$ ; SAR(10 g) =  $1.56 \text{ W/kg}$**

Maximum value of SAR (measured) =  $3.29 \text{ W/kg}$



$0 \text{ dB} = 3.29 \text{ W/kg} = 5.17 \text{ dB W/kg}$

**Fig.B.4 validation 835 MHz 250mW**

## 1750 MHz

Date: 4/7/2017

Electronics: DAE4 Sn1331

Medium: Head 1750 MHz

Medium parameters used:  $f = 1750$  MHz;  $\sigma = 1.38$  mho/m;  $\epsilon_r = 40.68$ ;  $\rho = 1000$  kg/m<sup>3</sup>

Ambient Temperature: 22.5°C Liquid Temperature: 23.3°C

Communication System: CW Frequency: 1750 MHz Duty Cycle: 1:1

Probe: EX3DV4 – SN3846 ConvF(8.16,8.16,8.16)

**System Validation /Area Scan (81x191x1):** Interpolated grid: dx=1.000 mm, dy=1.000 mm

Reference Value = 104.01 V/m; Power Drift = 0.02

**Fast SAR: SAR(1 g) = 9.08 W/kg; SAR(10 g) = 4.88 W/kg**

Maximum value of SAR (interpolated) = 14.6 W/kg

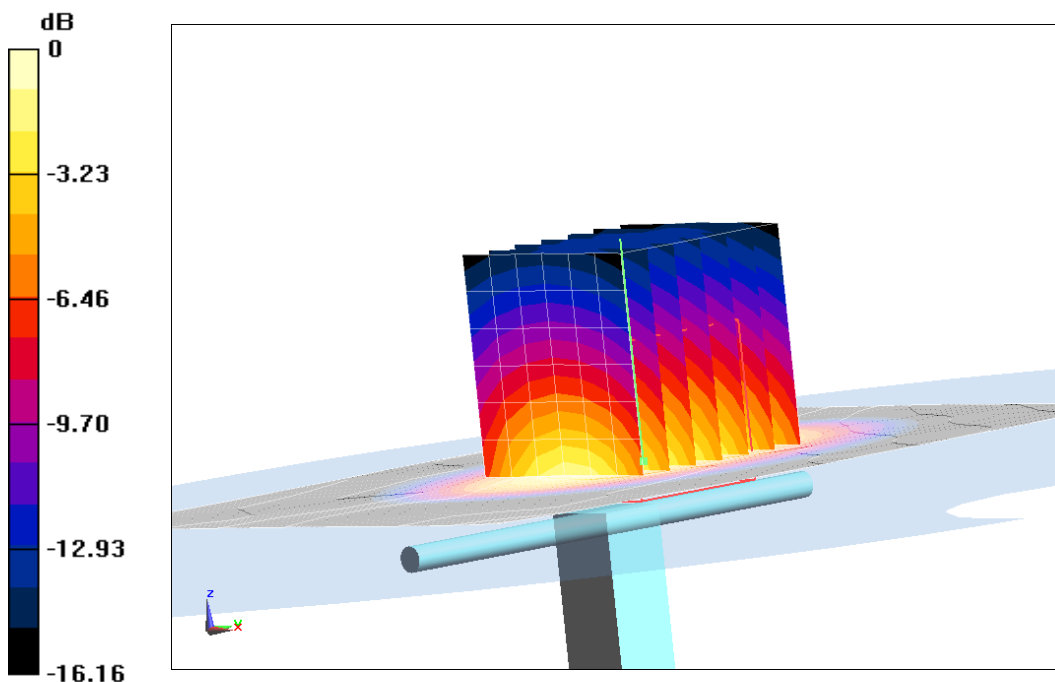
**System Validation /Zoom Scan (7x7x7)/Cube 0:** Measurement grid: dx=5mm, dy=5mm, dz=5mm

Reference Value = 104.01 V/m; Power Drift = 0.02 dB

Peak SAR (extrapolated) = 16.93 W/kg

**SAR(1 g) = 9.06 W/kg; SAR(10 g) = 4.9 W/kg**

Maximum value of SAR (measured) = 14.2 W/kg



0 dB = 14.2 W/kg = 11.52 dB W/kg

**Fig.B.5 validation 1750 MHz 250mW**

## 1750 MHz

Date: 4/7/2017

Electronics: DAE4 Sn1331

Medium: Body 1750 MHz

Medium parameters used:  $f = 1750$  MHz;  $\sigma = 1.514$  mho/m;  $\epsilon_r = 53.22$ ;  $\rho = 1000$  kg/m<sup>3</sup>

Ambient Temperature: 22.5°C Liquid Temperature: 23.3°C

Communication System: CW Frequency: 1750 MHz Duty Cycle: 1:1

Probe: EX3DV4 – SN3846 ConvF(7.9,7.9,7.9)

**System Validation /Area Scan (81x191x1):** Interpolated grid: dx=1.000 mm, dy=1.000 mm

Reference Value = 103.14 V/m; Power Drift = 0.01

**Fast SAR: SAR(1 g) = 9.08 W/kg; SAR(10 g) = 4.86 W/kg**

Maximum value of SAR (interpolated) = 13.63 W/kg

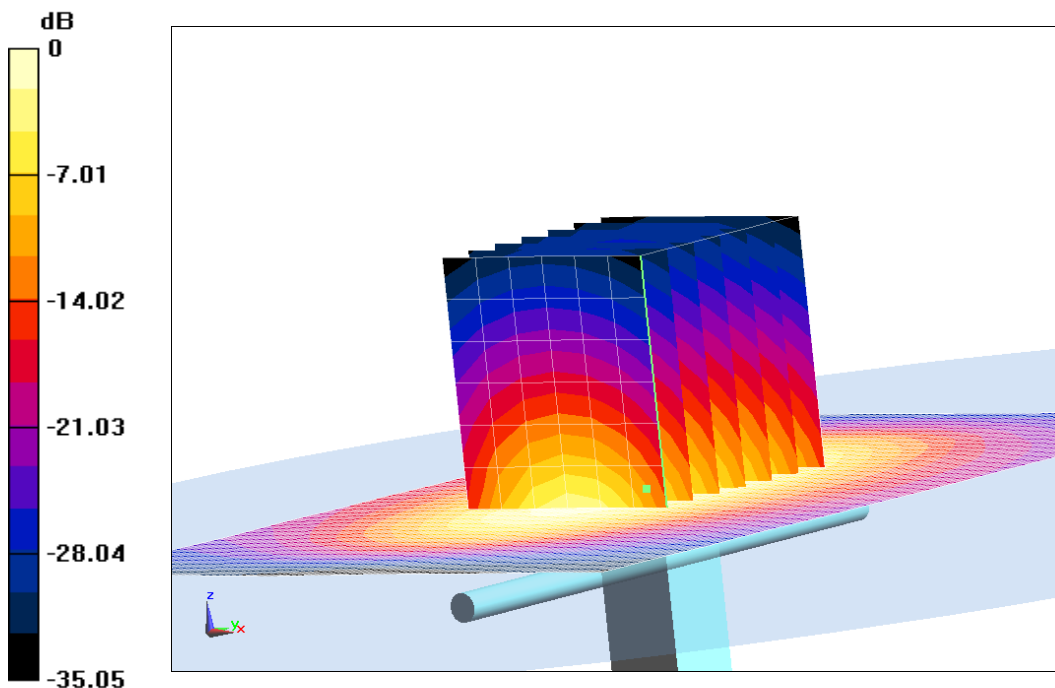
**System Validation /Zoom Scan (7x7x7)/Cube 0:** Measurement grid: dx=5mm, dy=5mm, dz=5mm

Reference Value = 103.14 V/m; Power Drift = 0.01 dB

Peak SAR (extrapolated) = 15.98 W/kg

**SAR(1 g) = 9.12 W/kg; SAR(10 g) = 4.94 W/kg**

Maximum value of SAR (measured) = 13.73 W/kg



0 dB = 13.73 W/kg = 11.38 dB W/kg

**Fig.B.6 validation 1750 MHz 250mW**

## 1900 MHz

Date: 4/8/2017

Electronics: DAE4 Sn1331

Medium: Head 1900 MHz

Medium parameters used:  $f = 1900$  MHz;  $\sigma = 1.39$  mho/m;  $\epsilon_r = 39.55$ ;  $\rho = 1000$  kg/m<sup>3</sup>

Ambient Temperature: 22.5°C Liquid Temperature: 23.3°C

Communication System: CW Frequency: 1900 MHz Duty Cycle: 1:1

Probe: EX3DV4 – SN3846 ConvF(7.89,7.89,7.89)

**System Validation /Area Scan (81x191x1):** Interpolated grid: dx=1.000 mm, dy=1.000 mm

Reference Value = 106.76 V/m; Power Drift = 0.01

**Fast SAR: SAR(1 g) = 10.21 W/kg; SAR(10 g) = 5.3 W/kg**

Maximum value of SAR (interpolated) = 15.47 W/kg

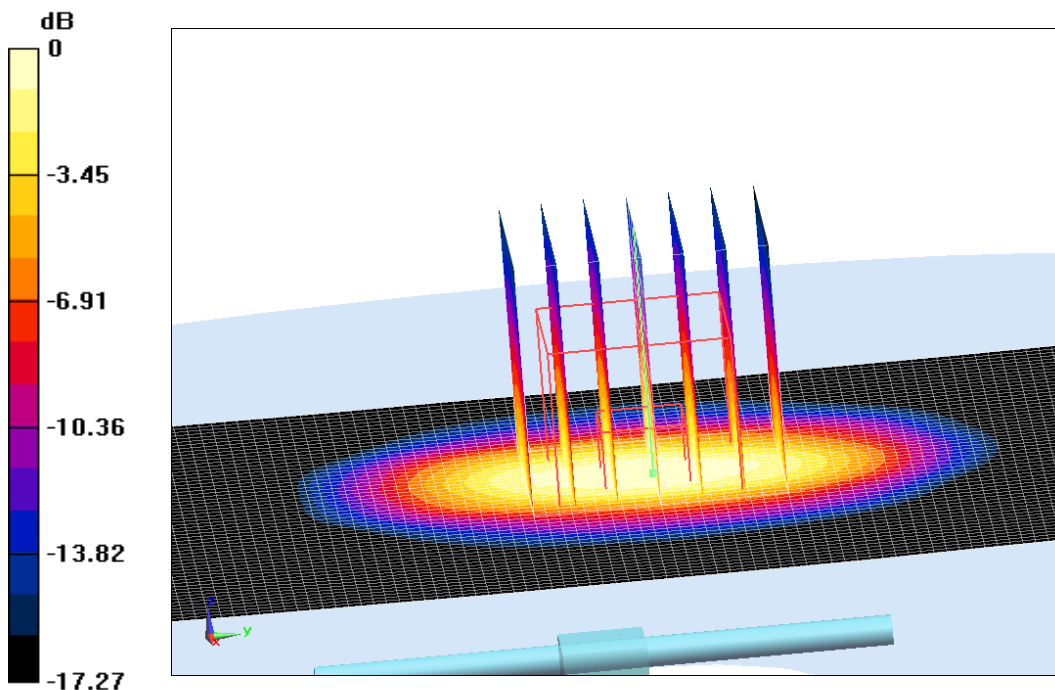
**System Validation /Zoom Scan (7x7x7)/Cube 0:** Measurement grid: dx=5mm, dy=5mm, dz=5mm

Reference Value = 106.76 V/m; Power Drift = 0.01 dB

Peak SAR (extrapolated) = 18.92 W/kg

**SAR(1 g) = 10.32 W/kg; SAR(10 g) = 5.25 W/kg**

Maximum value of SAR (measured) = 15.7 W/kg



0 dB = 15.7 W/kg = 11.96 dB W/kg

**Fig.B.7 validation 1900 MHz 250mW**



## 1900 MHz

Date: 4/8/2017

Electronics: DAE4 Sn1331

Medium: Body 1900 MHz

Medium parameters used:  $f = 1900$  MHz;  $\sigma = 1.536$  mho/m;  $\epsilon_r = 53.19$ ;  $\rho = 1000$  kg/m<sup>3</sup>

Ambient Temperature: 22.5°C Liquid Temperature: 23.3°C

Communication System: CW Frequency: 1900 MHz Duty Cycle: 1:1

Probe: EX3DV4 – SN3846 ConvF(7.57,7.57,7.57)

**System Validation /Area Scan (81x191x1):** Interpolated grid: dx=1.000 mm, dy=1.000 mm

Reference Value = 105.78 V/m; Power Drift = -0.01

**Fast SAR: SAR(1 g) = 10.35 W/kg; SAR(10 g) = 5.26 W/kg**

Maximum value of SAR (interpolated) = 14.84 W/kg

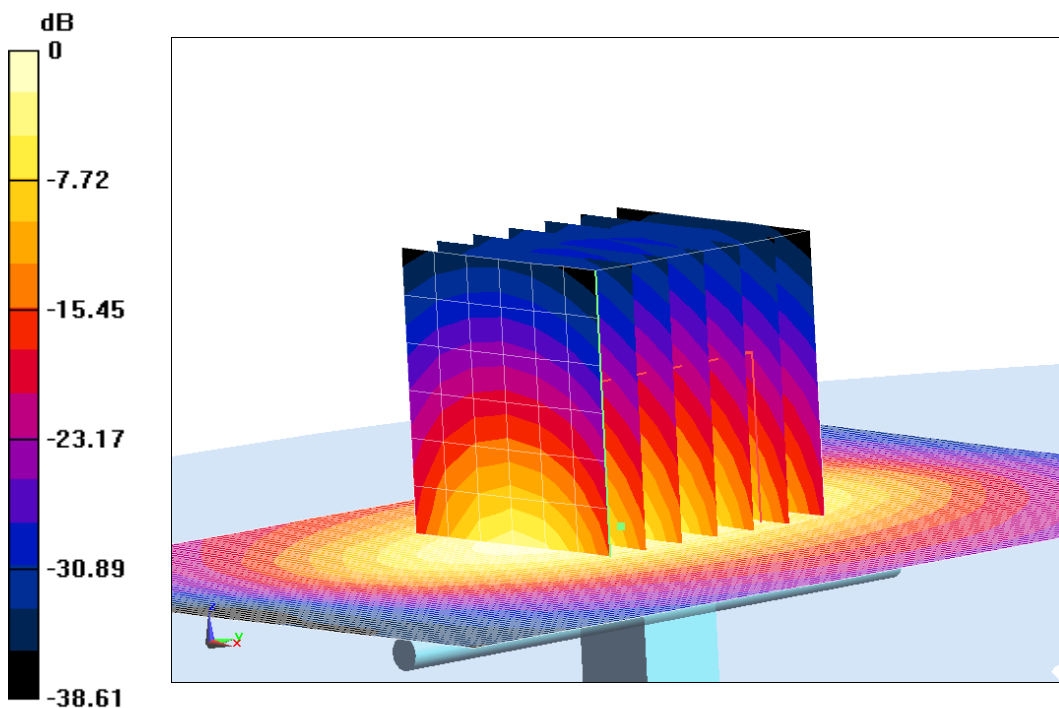
**System Validation /Zoom Scan (7x7x7)/Cube 0:** Measurement grid: dx=5mm, dy=5mm, dz=5mm

Reference Value = 105.78 V/m; Power Drift = -0.01 dB

Peak SAR (extrapolated) = 17.85 W/kg

**SAR(1 g) = 10.08 W/kg; SAR(10 g) = 5.23 W/kg**

Maximum value of SAR (measured) = 14.7 W/kg



0 dB = 14.7 W/kg = 11.67 dB W/kg

**Fig.B.8 validation 1900 MHz 250mW**

## 2450 MHz

Date: 4/9/2017

Electronics: DAE4 Sn1331

Medium: Head 2450 MHz

Medium parameters used:  $f = 2450$  MHz;  $\sigma = 1.784$  mho/m;  $\epsilon_r = 39.05$ ;  $\rho = 1000$  kg/m<sup>3</sup>

Ambient Temperature: 22.5°C Liquid Temperature: 23.3°C

Communication System: CW Frequency: 2450 MHz Duty Cycle: 1:1

Probe: EX3DV4 – SN3846 ConvF(7.22,7.22,7.22)

**System Validation /Area Scan (81x191x1):** Interpolated grid: dx=1.000 mm, dy=1.000 mm

Reference Value = 116.11 V/m; Power Drift = -0.03

**Fast SAR: SAR(1 g) = 13.1 W/kg; SAR(10 g) = 6.06 W/kg**

Maximum value of SAR (interpolated) = 22.66 W/kg

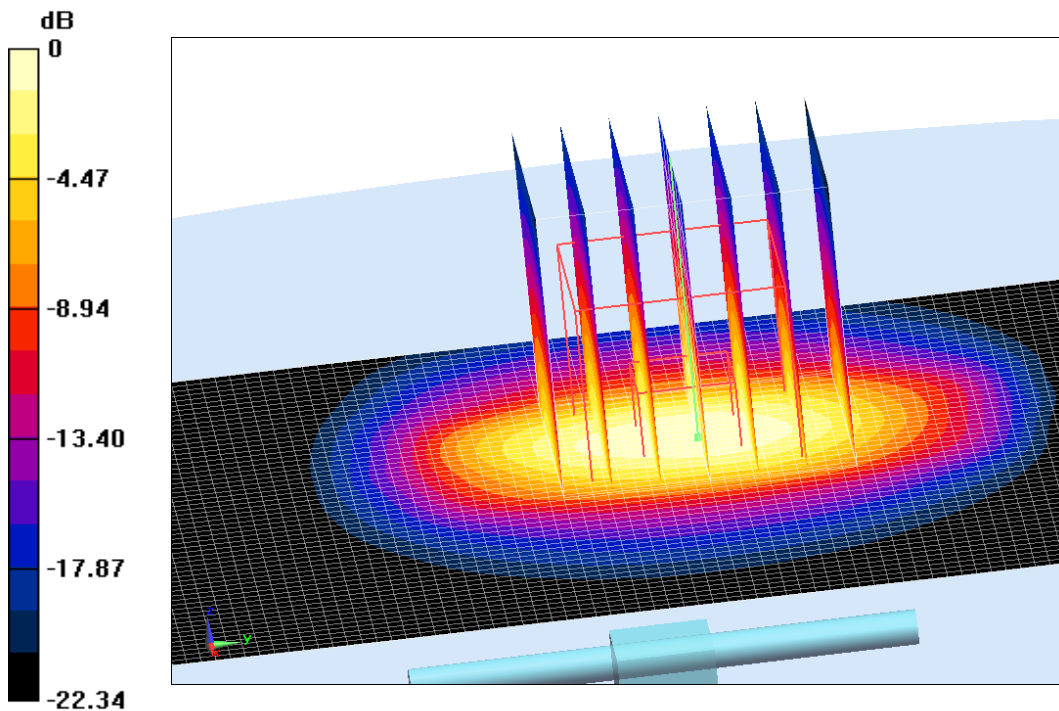
**System Validation /Zoom Scan (7x7x7)/Cube 0:** Measurement grid: dx=5mm, dy=5mm, dz=5mm

Reference Value = 116.11 V/m; Power Drift = -0.03 dB

Peak SAR (extrapolated) = 27.32 W/kg

**SAR(1 g) = 13.44 W/kg; SAR(10 g) = 6.26 W/kg**

Maximum value of SAR (measured) = 22.63 W/kg



0 dB = 22.63 W/kg = 13.55 dB W/kg

**Fig.B.9 validation 2450 MHz 250mW**

## 2450 MHz

Date: 4/9/2017

Electronics: DAE4 Sn1331

Medium: Body 2450 MHz

Medium parameters used:  $f = 2450$  MHz;  $\sigma = 1.966$  mho/m;  $\epsilon_r = 53.36$ ;  $\rho = 1000$  kg/m<sup>3</sup>

Ambient Temperature: 22.5°C Liquid Temperature: 23.3°C

Communication System: CW Frequency: 2450 MHz Duty Cycle: 1:1

Probe: EX3DV4 – SN3846 ConvF(7.31,7.31,7.31)

**System Validation /Area Scan (81x191x1):** Interpolated grid: dx=1.000 mm, dy=1.000 mm

Reference Value = 107.13 V/m; Power Drift = -0.01

**Fast SAR: SAR(1 g) = 13.36 W/kg; SAR(10 g) = 6.17 W/kg**

Maximum value of SAR (interpolated) = 22.05 W/kg

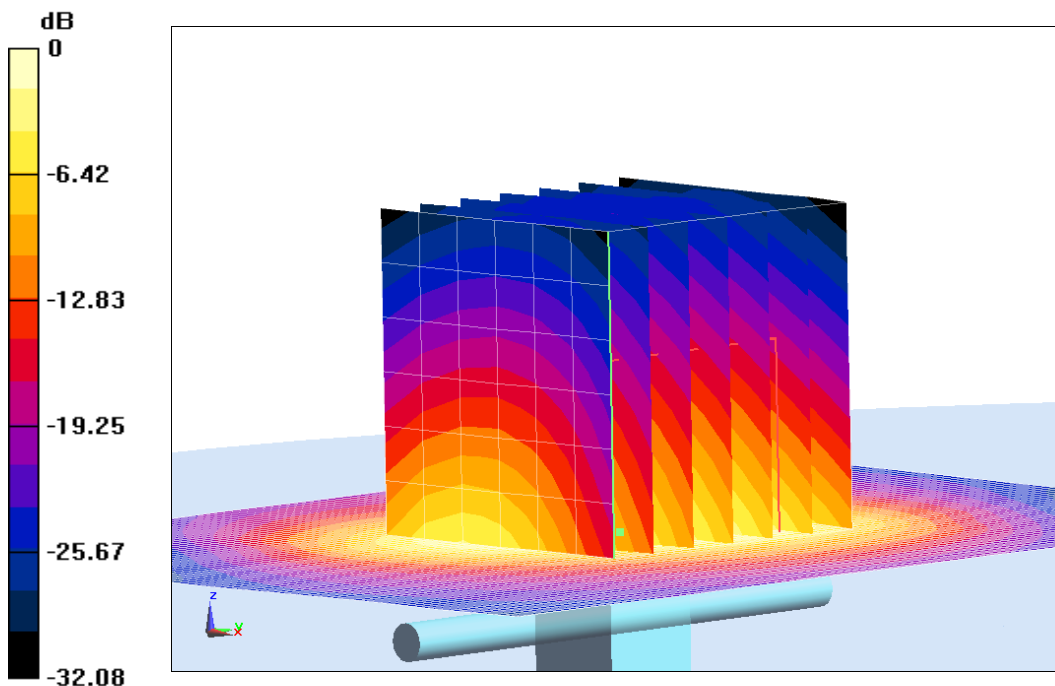
**System Validation /Zoom Scan (7x7x7)/Cube 0:** Measurement grid: dx=5mm, dy=5mm, dz=5mm

Reference Value = 107.13 V/m; Power Drift = -0.01 dB

Peak SAR (extrapolated) = 26.52 W/kg

**SAR(1 g) = 13.06 W/kg; SAR(10 g) = 6.06 W/kg**

Maximum value of SAR (measured) = 21.71 W/kg



0 dB = 21.71 W/kg = 13.37 dB W/kg

**Fig.B.10 validation 2450 MHz 250mW**

## 2600 MHz

Date: 4/10/2017

Electronics: DAE4 Sn1331

Medium: Head 2600 MHz

Medium parameters used:  $f = 2600$  MHz;  $\sigma = 1.966$  mho/m;  $\epsilon_r = 39.57$ ;  $\rho = 1000$  kg/m<sup>3</sup>

Ambient Temperature: 22.5°C Liquid Temperature: 23.3°C

Communication System: CW Frequency: 2600 MHz Duty Cycle: 1:1

Probe: EX3DV4 – SN3846 ConvF(7.12,7.12,7.12)

**System Validation /Area Scan (81x191x1):** Interpolated grid: dx=1.000 mm, dy=1.000 mm

Reference Value = 115.02 V/m; Power Drift = -0.02

**Fast SAR: SAR(1 g) = 14.04 W/kg; SAR(10 g) = 6.23 W/kg**

Maximum value of SAR (interpolated) = 24.71 W/kg

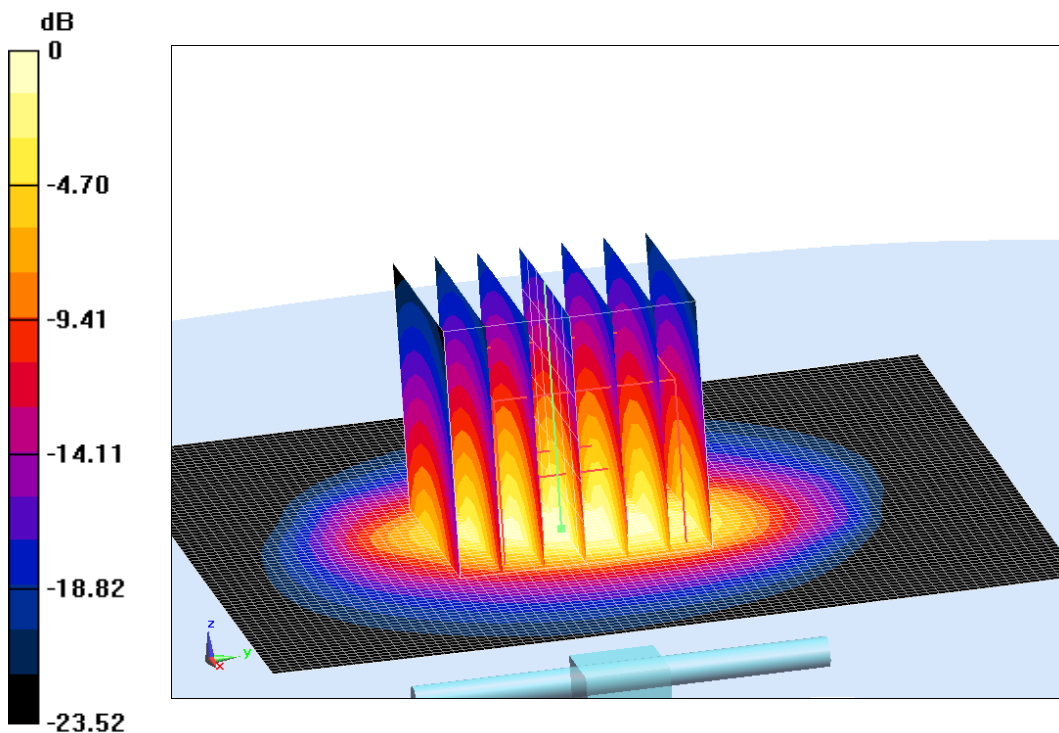
**System Validation /Zoom Scan (7x7x7)/Cube 0:** Measurement grid: dx=5mm, dy=5mm, dz=5mm

Reference Value = 115.02 V/m; Power Drift = -0.02 dB

Peak SAR (extrapolated) = 30.77 W/kg

**SAR(1 g) = 14.4 W/kg; SAR(10 g) = 6.34 W/kg**

Maximum value of SAR (measured) = 24.43 W/kg



0 dB = 24.43 W/kg = 13.88 dB W/kg

**Fig.B.11 validation 2600 MHz 250mW**