

TEST REPORT

Product Name : quadcopter
Model Number : D70, D70S, D70E, D70R, D70G, D60, D60S, D60E, D60G, HS120S, HS270D, HS270S, F7, D65, D75, D80, D85, D90, D11, D33, D100, D200, HT40, HT50, HT60, HT65, HT70, HT300, HS290, HS320, HS390, HS410, HS460, HS480, HS490, HS520, HS530, HS540, HS560, HS570, HS580, HS590, HS610, HS620, HS630, HS640, HS650, HS660, HS670, HS680, HS690, HS730, HS740, HS750, HS760, HS770, HS780, HS790, HS810, HS820, HS900, HS176, HS101, HS155, HS176, D89, DC10, DC11, DC12, HS210F, JY08, JY03, JY01, 1812, Z6pro
FCC ID : 2AJ55HOLYSTON7

Prepared for : Xiamen Huoshiquan Import & Export CO., LTD
Address : Unit 1, Room 501, Hongxiang Building, No.258 Hubin Nan Road, Siming District, Xiamen, China

Prepared by : EMTEK (SHENZHEN) CO., LTD.
Address : Building 69, Majialong Industry Zone, Nanshan District, Shenzhen, Guangdong, China

Tel: (0755) 26954280
Fax: (0755) 26954282

Report Number : ENS2212130001W00301R
Date(s) of Tests : December 13, 2022 to December 27, 2022
Date of issue : December 27, 2022

TABLE OF CONTENTS

1	TEST RESULT CERTIFICATION	3
2	EUT TECHNICAL DESCRIPTION	5
3	SUMMARY OF TEST RESULT	6
4	TEST METHODOLOGY	7
4.1	GENERAL DESCRIPTION OF APPLIED STANDARDS.....	7
4.2	MEASUREMENT EQUIPMENT USED.....	7
4.3	DESCRIPTION OF TEST MODES.....	8
5	FACILITIES AND ACCREDITATIONS	9
5.1	FACILITIES.....	9
5.2	EQUIPMENT.....	9
5.3	LABORATORY ACCREDITATIONS AND LISTINGS.....	9
6	TEST SYSTEM UNCERTAINTY	10
7	SETUP OF EQUIPMENT UNDER TEST	11
7.1	RADIO FREQUENCY TEST SETUP 1.....	11
7.2	RADIO FREQUENCY TEST SETUP 2.....	11
7.3	CONDUCTED EMISSION TEST SETUP.....	14
7.4	BLOCK DIAGRAM CONFIGURATION OF TEST SYSTEM.....	15
7.5	SUPPORT EQUIPMENT.....	15
8	TEST REQUIREMENTS	16
8.1	DTS 6DB BANDWIDTH.....	16
8.2	DTS 99% BANDWIDTH.....	21
8.3	MAXIMUM PEAK CONDUCTED OUTPUT POWER.....	26
8.4	MAXIMUM POWER SPECTRAL DENSITY.....	31
8.5	UNWANTED EMISSIONS IN NON-RESTRICTED FREQUENCY BANDS.....	36
8.6	RADIATED SPURIOUS EMISSION.....	43
8.7	CONDUCTED EMISSION TEST.....	56
8.8	ANTENNA APPLICATION.....	57

1 TEST RESULT CERTIFICATION

Applicant : Xiamen Huoshiquan Import & Export CO., LTD
 Address : Unit 1, Room 501, Hongxiang Building, No.258 Hubin Nan Road, Siming District, Xiamen, China
 Manufacturer : Xiamen Huoshiquan Import & Export CO., LTD
 Address : Unit 1, Room 501, Hongxiang Building, No.258 Hubin Nan Road, Siming District, Xiamen, China
 EUT : quadcopter
 Model Name : D70, D70S, D70E, D70R, D70G, D60, D60S, D60E, D60G, HS120S, HS270D, HS270S, F7, D65, D75, D80, D85, D90, D11, D33, D100, D200, HT40, HT50, HT60, HT65, HT70, HT300, HS290, HS320, HS390, HS410, HS460, HS480, HS490, HS520, HS530, HS540, HS560, HS570, HS580, HS590, HS610, HS620, HS630, HS640, HS650, HS660, HS670, HS680, HS690, HS730, HS740, HS750, HS760, HS770, HS780, HS790, HS810, HS820, HS900, HS176, HS101, HS155, HS176, D89, DC10, DC11, DC12, HS210F, JY08, JY03, JY01, 1812, Z6pro
 Trademark : Holy Stone

Measurement Procedure Used:

APPLICABLE STANDARDS	
STANDARD	TEST RESULT
FCC 47 CFR Part 2, Subpart J FCC 47 CFR Part 15, Subpart C	PASS
IC RSS-GEN, Issue 5(04-2018)+A1(03-2019)+A2(02-2021) IC RSS-247 Issue 2(02-2017)	PASS

The above equipment was tested by EMTEK(SHENZHEN) CO., LTD. The test data, data evaluation, test procedures, and equipment configurations shown in this report were made in accordance with the procedures given in ANSI C63.10 (2013) and the energy emitted by the sample EUT tested as described in this report is in compliance with the requirements of FCC Rules Part 2, Part 15.247, IC RSS-247 Issue 2 and IC RSS-GEN, Issue 5.

The test results of this report relate only to the tested sample identified in this report.

Date of Test : December 13, 2022 to December 27, 2022

Prepared by : *Luo Pei Ye*
 Luo peiye /Editor

Reviewer : *Joe Xia*
 Joe Xia /Supervisor

Approve & Authorized Signer : *[Signature]*
 Lisa Wang/Manager



Modified History

Version	Report No.	Revision Date	Summary
V1.0	ENS2212130001W00301R	/	Original Report



2 EUT TECHNICAL DESCRIPTION

Characteristics	Description
Product:	quadcopter
Model Number:	D70, D70S, D70E, D70R, D70G, D60, D60S, D60E, D60G, HS120S, HS270D, HS270S, F7, D65, D75, D80, D85, D90, D11, D33, D100, D200, HT40, HT50, HT60, HT65, HT70, HT300, HS290, HS320, HS390, HS410, HS460, HS480, HS490, HS520, HS530, HS540, HS560, HS570, HS580, HS590, HS610, HS620, HS630, HS640, HS650, HS660, HS670, HS680, HS690, HS730, HS740, HS750, HS760, HS770, HS780, HS790, HS810, HS820, HS900, HS176, HS101, HS155, HS176, D89, DC10, DC11, DC12, HS210F, JY08, JY03, JY01, 1812, Z6pro (These models are identical in circuitry and electrical, mechanical and physical construction; The differences among them are model name and the color of appearance. Only indicates for different market purposes; We chose D70 as the final test prototype)
Sample Number:	2#
IEEE 802.11 WLAN Mode Supported:	802.11b 802.11g 802.11n(20MHz channel bandwidth)
Modulation:	DSSS with DBPSK/DQPSK/CCK for 802.11b; OFDM with BPSK/QPSK/16QAM/64QAM for 802.11g/n;
Operating Frequency Range:	2412-2462MHz for 802.11b/g/n(HT20);
Number of Channels:	11 channels for 802.11b/g/n(HT20);
Transmit Power Max:	17.27 dBm
Antenna Type:	FPC Antenna
Antenna Gain:	2.44 dBi
Power Supply:	DC 3.7V from Li-Po battery DC 5V from adapter
Temperature Range	0°C ~ +40°C

Note: for more details, please refer to the User's manual of the EUT.

3 SUMMARY OF TEST RESULT

FCC PartClause	IC Part Clause	Test Parameter	Verdict	Remark
15.247(a)(2)	RSS-247, 5.2(a) RSS-Gen6.7	Emission Bandwidth	PASS	
15.247(b)(3)	RSS-247, 5.4(d) RSS-Gen6.12	Maximum Peak Conducted Output Power	PASS	
15.247(e)	RSS-247, 5.2(b) RSS-Gen6.12	Maximum Power Spectral Density Level	PASS	
15.247(d)	RSS-247, 5.5	Unwanted Emission Into Non-Restricted Frequency Bands	PASS	
15.247(d)	RSS-247, 5.5	Unwanted Emission Into Restricted Frequency Bands (conducted)	PASS	
15.247(d) 15.209 15.205	RSS-Gen 8.9 RSS-Gen 8.10 RSS-Gen 6.13 RSS-247, 3.3 RSS-247, 5.5	Radiated Spurious Emission	PASS	
15.207	RSS-Gen 8.8	Conducted EmissionTest	PASS	
15.203 15.247(b)	RSS-Gen 6.8 RSS-247, 5.4	Antenna Application	PASS	
NOTE1:N/A (Not Applicable)				
NOTE2:According to FCC OET KDB 558074, the report use radiated measurements in the restricted frequency bands. In addition, the radiated test is also performed to ensure the emissions emanating from the device cabinet also comply with the applicable limits.				

RELATED SUBMITTAL(S) / GRANT(S):

This submittal(s) (test report) is intended for **FCC ID:2AJ55HOLYSTONEW7** filing to comply with Section 15.247 of the FCC Part 15, Subpart C Rules.

4 TEST METHODOLOGY

4.1 GENERAL DESCRIPTION OF APPLIED STANDARDS

According to its specifications, the EUT must comply with the requirements of the following standards:

FCC 47 CFR Part 2, Subpart J

FCC 47 CFR Part 15, Subpart C

IC RSS-GEN, Issue 5(04-2018)+A1(03-2019)+A2(02-2021)

IC RSS-247 Issue 2(02-2017)

FCC KDB 558074 D01 15.247 Meas Guidance v05r02

FCC KDB 662911 D01 Multiple Transmitter Output v02r01

4.2 MEASUREMENT EQUIPMENT USED

Conducted Emission Test Equipment

Equipment	Manufacturer	Model No.	Serial No.	Last Cal.	Cal. Interval
EMI Test Receiver	Rohde & Schwarz	ESCI	101384	2022/5/14	1Year
AMN	Rohde & Schwarz	ENV216	101161	2022/5/14	1Year
AMN	Kyoritsu	KNW-407	8-1492-9	2022/5/15	1Year

For Spurious Emissions Test

Equipment	Manufacturer	Model No.	Serial No.	Last Cal.	Cal. Interval
Pre-Amplifier	HP	8447F	2944A07999	2022/5/14	1Year
EMI Test Receiver	Rohde & Schwarz	ESCI	101414	2022/5/14	1Year
Bilog Antenna	Schwarzbeck	VULB9163	712	2022/7/5	2 Year
Horn antenna	Schwarzbeck	BBHA9120D	9120D-1178	2022/7/4	2 Year
Pre-Amplifie	Lunar EM	LNA1G18-48	J101113101000 1	2022/5/15	1Year
Spectrum Analyzer	Rohde & Schwarz	FSV40	100967	2022/5/14	1Year
Horn antenna	Schwarzbeck	BBHA9170	9170-399	2022/6/12	2 Year
Cable	H+B	NmSm-05-C15052	N/A	2022/5/15	1 Year
Cable	H+B	NmSm-2-C15201	N/A	2022/5/15	1 Year
Cable	H+B	NmNm-7-C15702	N/A	2022/5/15	1 Year
Cable	H+B	SAC-40G-1	414	2022/5/15	1 Year
Cable	H+B	SUCOFLEX104	MY14871/4	2022/5/15	1 Year
Cable	H+B	BLU18A-NmSm-650 0	D8501	2022/5/15	1 Year
Band reject Filter(50dB)	WI/DE	WRCGV-2400(2400- 2485MHz)	2	2022/5/15	1 Year

For other test items:

Equipment	Manufacturer	Model No.	Serial No.	Last Cal.	Cal. Interval
Signal Analyzer	Agilent	N9010A	MY53470879	2022/5/14	1Year
Vector Signal Generater	Agilent	N5182B	MY53050878	2022/5/14	1Year
Analog Signal Generator	Agilent	N5171B	MY53050553	2022/5/14	1Year
Power Meter	Agilent	PS-X10-100	\	2022/5/15	1Year

Blocking Box	THEDA	AD211	TW5451140	2022/5/14	1Year
Switchgroup	THEDA	ETF-025(VASC6)	TW5451008	N/A	N/A
MIMO Matrix Switch	THEDA	4P5TM18	TW5451009	N/A	N/A
Temperature&Humidity Chamber	ESPEC	EL-02KA	12107166	2022/7/3	1 Year

4.3 DESCRIPTION OF TEST MODES

The EUT has been tested under its typical operating condition.

The EUT configuration for testing is installed on RF field strength measurement to meet the Commissions requirement and operating in a manner which intends to maximize its emission characteristics in a continuous normal application.

The Transmitter was operated in the normal operating mode. The TX frequency was fixed which was for the purpose of the measurements.

Test of channel included the lowest and middle and highest frequency to perform the test, then record on this report.

Those data rates (802.11b: 1 Mbps; 802.11g: 6 Mbps; 802.11n (HT20): MCS0; 802.11n (HT40): MCS0;) were used for all test.

Pre-defined engineering program for regulatory testing used to control the EUT for staying in continuous transmitting and receiving mode is programmed.

Frequency and Channel list for 802.11 b/g/n(HT20):

Channel	Frequency (MHz)	Channel	Frequency (MHz)	Channel	Frequency (MHz)
1	2412	5	2432	9	2452
2	2417	6	2437	10	2457
3	2422	7	2442	11	2462
4	2427	8	2447		

Test Frequency and Channel for 802.11 b/g/n(HT20):

Lowest Frequency		Middle Frequency		Highest Frequency	
Channel	Frequency (MHz)	Channel	Frequency (MHz)	Channel	Frequency (MHz)
1	2412	6	2437	11	2462

5 FACILITIES AND ACCREDITATIONS

5.1 FACILITIES

All measurement facilities used to collect the measurement data are located at:

EMTEK (Shenzhen) Co., Ltd.

Building 69, Majialong Industry Zone District, Nanshan District, Shenzhen, China

The sites are constructed in conformance with the requirements of ANSI C63.7, ANSI C63.4 and CISPR Publication 22.

5.2 EQUIPMENT

Radiated emissions are measured with one or more of the following types of linearly polarized antennas: tuned dipole, biconical, log periodic, bi-log, and/or ridged waveguide, horn. Spectrum analyzers with preselectors and quasi-peak detectors are used to perform radiated measurements.

Conducted emissions are measured with Line Impedance Stabilization Networks and EMI Test Receivers.

Calibrated wideband preamplifiers, coaxial cables, and coaxial attenuators are also used for making measurements.

All receiving equipment conforms to CISPR Publication 16-1, "Radio Interference Measuring Apparatus and Measurement Methods."

5.3 LABORATORY ACCREDITATIONS AND LISTINGS

Site Description	
EMC Lab.	<p>Accredited by CNAS The Certificate Registration Number is L2291. The Laboratory has been assessed and proved to be in compliance with CNAS-CL01 (identical to ISO/IEC 17025:2017)</p> <p>Accredited by FCC Designation Number: CN1204 Test Firm Registration Number: 882943</p> <p>Accredited by A2LA The Certificate Number is 4321.01.</p> <p>Accredited by Industry Canada The Conformity Assessment Body Identifier is CN0008</p>
Name of Firm	: EMTEK (SHENZHEN) CO., LTD.
Site Location	: Building 69, Majialong Industry Zone, Nanshan District, Shenzhen, Guangdong, China

6 TEST SYSTEM UNCERTAINTY

The following measurement uncertainty levels have been estimated for tests performed on the apparatus:

Test Parameter	Measurement Uncertainty
Radio Frequency	$\pm 1 \times 10^{-5}$
Maximum Peak Output Power Test	$\pm 1.0\text{dB}$
Conducted Emissions Test	$\pm 2.0\text{dB}$
Radiated Emission Test	$\pm 2.0\text{dB}$
Power Density	$\pm 2.0\text{dB}$
Occupied Bandwidth Test	$\pm 1.0\text{dB}$
Band Edge Test	$\pm 3\text{dB}$
All emission, radiated	$\pm 3\text{dB}$
Antenna Port Emission	$\pm 3\text{dB}$
Temperature	$\pm 0.5^\circ\text{C}$
Humidity	$\pm 3\%$

Measurement Uncertainty for a level of Confidence of 95%

7 SETUP OF EQUIPMENT UNDER TEST

7.1 RADIO FREQUENCY TEST SETUP 1

The WLAN component's antenna ports(s) of the EUT are connected to the measurement instrument per an appropriate attenuator. The EUT is controlled by PC/software to emit the specified signals for the purpose of measurements.

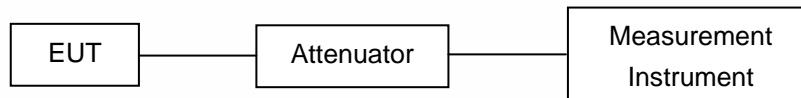

7.2 RADIO FREQUENCY TEST SETUP 2

The test site semi-anechoic chamber has met the requirement of NSA tolerance 4 dB according to the standards: ANSI C63.10. The test distance is 3m. The setup is according to the requirements in Section 13.1.4.1 of ANSI C63.10-2013 and CAN/CSA-CEI/IEC CISPR 22.

The maximal emission value is acquired by adjusting the antenna height, polarisation and turntable azimuth. Normally, the height range of antenna is 1 m to 4 m, the azimuth range of turntable is 0° to 360°, and the receive antenna has two polarizations Vertical (V) and Horizontal (H).

Below 30MHz:

The EUT is placed on a turntable 0.8 meters above the ground in the chamber, 3 meter away from the antenna (loop antenna). The Antenna should be positioned with its plane vertical at the specified distance from the EUT and rotated about its vertical axis for maximum response at each azimuth about the EUT. The center of the loop shall be 1 m above the ground. For certain applications, the loop antenna plane may also need to be positioned horizontally at the specified distance from the EUT.

Above 30MHz:

The EUT is placed on a turntable 0.8 meters above the ground in the chamber, 3 meter away from the antenna. The maximal emission value is acquired by adjusting the antenna height, polarisation and turntable azimuth. Normally, the height range of antenna is 1 m to 4 m, the azimuth range of turntable is 0° to 360°, and the receive antenna has two polarizations Vertical (V) and Horizontal (H).

Above 1GHz:

The EUT is placed on a turntable 1.5 meters above the ground in the chamber, 3 meter away from the antenna. The maximal emission value is acquired by adjusting the antenna height, polarisation and turntable azimuth. Normally, the height range of antenna is 1 m to 4 m, the azimuth range of turntable is 0° to 360°, and the receive antenna has two polarizations Vertical (V) and Horizontal (H).

Measurements shall be taken, using the following steps, at a test site that has been validated using the procedures of ANSI C63.4 or the latest CISPR 16-1-4 for measurements above 1 GHz, so as to simulate a near free-space environment (see RSS-Gen for applicable versions of ANSI and CISPR standards).

(1) Line the ground plane with absorbers between the transmitter and the receive antenna to minimize reflections. The absorbers used should have a minimum-rated attenuation of 20 dB through the measurement frequency range of interest. The absorbers shall be positioned to replicate the layout used when compliance with the applicable acceptability criterion was achieved, as set forth in the aforementioned standards on site validation.

(2) Set the height of the receive antenna to 1.5 m. The receive antenna must be one that was designed and fabricated to operate over the entire frequency range of interest, for example, an appropriate standard gain horn.

(3) The distance between the receive antenna and the radiating source shall be sufficient in order to ensure far-field conditions.

(4) Mount the transmitter at a height of 1.5 m.

(5) Configure the device under test (DUT) to produce the maximum power spectral density as measured while assessing compliance with Section 6.2.2 (i.e. channel frequency, modulation type and data rate). If the DUT is equipped with a detachable antenna and the antenna is intended for remote installation (i.e.

tower-mounted), the DUT may be substituted with a suitable signal generator. The level and frequency settings on the generator shall be set so as to reproduce the maximum power spectral density, measured within a 1 MHz bandwidth, obtained while assessing compliance to Section 6.2.2.

(6) Position the transmitter or the radiating antenna so that elevation pattern measurements can be taken.

(7) Find the 0° reference point in the horizontal plane.

(8) Care should be taken when positioning the receive antenna to avoid cross-polarization. Antennas of known mounting polarization should be assessed with the receive antenna oriented in the same polarity. If the polarization of the transmit antenna is unknown or the transmit antenna can be mounted in either polarization, e.i.r.p. measurements should be performed to find which mounting polarity provides the highest e.i.r.p. value. Testing shall be carried out with the receive antenna and the DUT mounted in each polarity.

(9) The emission shall be centred on the display of the spectrum analyzer with the following settings:

i. If the power spectral density of the DUT was assessed with a peak detector and the antenna cannot be detached from the DUT, the spectrum analyzer shall be set to a peak detector with a resolution bandwidth and video bandwidth of 1 MHz.

ii. If the power spectral density of the DUT was assessed using a sample detector with power averaging and the antenna cannot be detached from the DUT, the spectrum analyzer shall be set to a sample detector, configured to produce 100 power averages and set with a resolution bandwidth, as well as a video bandwidth of 1 MHz.

iii. If the antenna can be detached from the DUT, a continuous wave (CW) signal equal to that of the power spectral density measurement may be used, the spectrum analyzer shall be set to peak detector with a resolution bandwidth and video bandwidth of 1 MHz.

(10) Rotate the turntable 360° recording the field strength at each step. Throughout the main beam of the antenna, the step size shall be kept to a maximum of 1°.

Once outside the main beam of the antenna, the maximum step size shall be as follows, when compared to the requirements of Section 6.2.2:

i. Between 0° and 8°, maximum step size of 2°;

ii. Between 8° and 40°, maximum step size of 4°;

iii. Between 40° and 45°, maximum step size of 1°;

iv. Between 45° and 90°, maximum step size of 5°.

Once the mask reaches 90°, the mask will be inverted and the step size will follow in the same manner as above.

For the purpose of this procedure, the main beam of the antenna is defined as the 3 dB beamwidth.

(11) Convert the measured field strength values in terms of e.i.r.p. density (dBW/1 MHz) using the following equation:

$$E \text{ e.i.r.p. density (dBW/MHz)} = 10 \log((E \cdot r)^2 / 30)$$

E = field strength in V/m

r = measurement distance in metres

(12) Plot the results against the emission mask with reference to the horizontal plane.

(13) Using the plot, the 0° can be rotated to determine the worst-case installation tilt angle.

(14) Testing shall be performed using the highest gain antenna for every antenna type, if applicable.

(15) Antenna type(s), antenna model number(s), and worst-case tilt angle(s) necessary to remain compliant with the elevation mask requirement set forth in Section 6.2.2(3) of RSS-247 shall be clearly indicated in the user manual.

The following figure is an example of a polar elevation mask measured using the Method 1 reference to dBμV/m at 3 m.

(a) Radiated Emission Test Set-Up, Frequency Below 30MHz

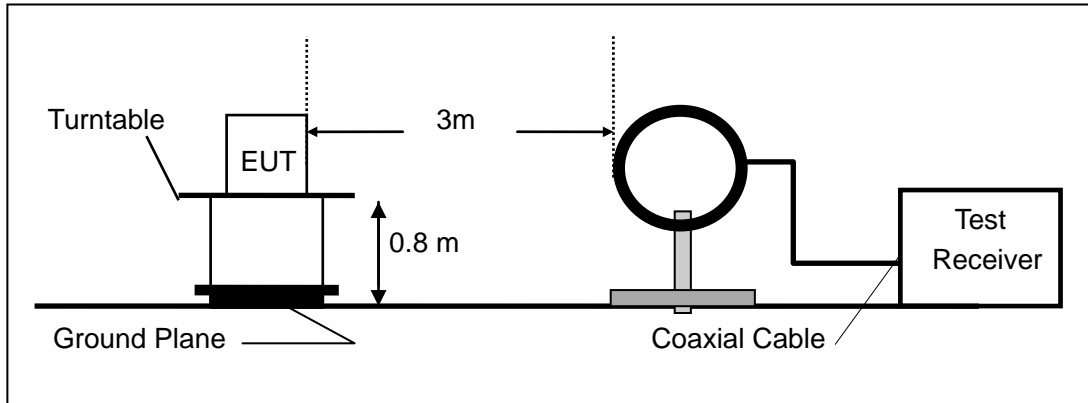

(b) Radiated Emission Test Set-Up, Frequency Below 1000MHz

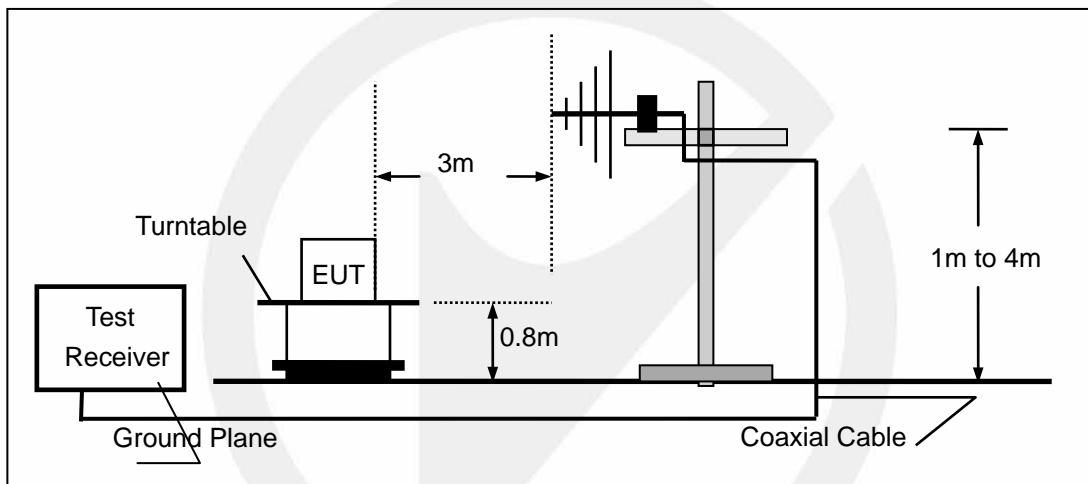

(c) Radiated Emission Test Set-Up, Frequency above 1000MHz

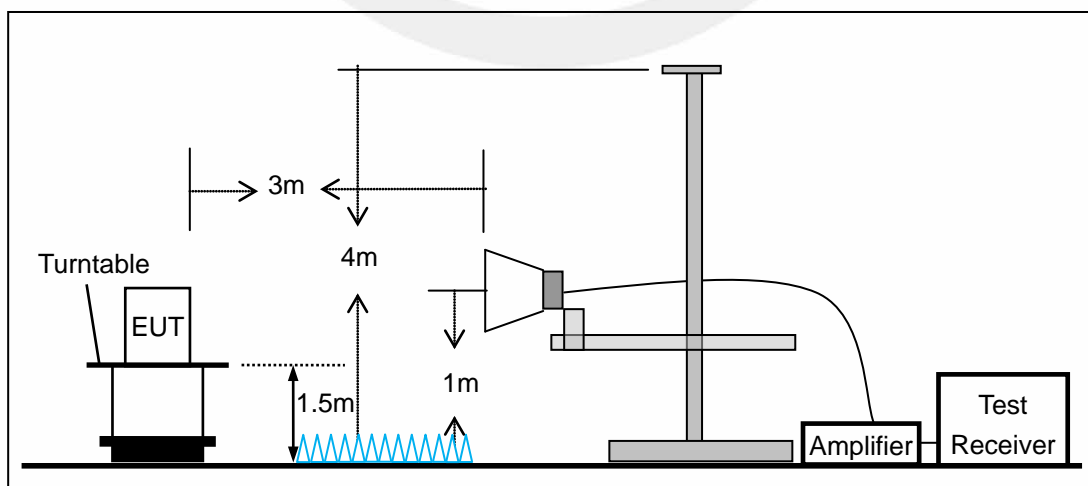

7.3 CONDUCTED EMISSION TEST SETUP

The mains cable of the EUT (maybe per AC/DC Adapter) must be connected to LISN. The LISN shall be placed 0.8 m from the boundary of EUT and bonded to a ground reference plane for LISN mounted on top of the ground reference plane. This distance is between the closest points of the LISN and the EUT. All other units of the EUT and associated equipment shall be at least 0.8m from the LISN.

Ground connections, where required for safety purposes, shall be connected to the reference ground point of the LISN and, where not otherwise provided or specified by the manufacturer, shall be of same length as the mains cable and run parallel to the mains connection at a separation distance of not more than 0.8 m.

According to the requirements in Section 13.1.4.1 of ANSI C63.10-2013 Conducted emissions from the EUT measured in the frequency range between 0.15 MHz and 30 MHz using CISPR Quasi-Peak and average detector mode.

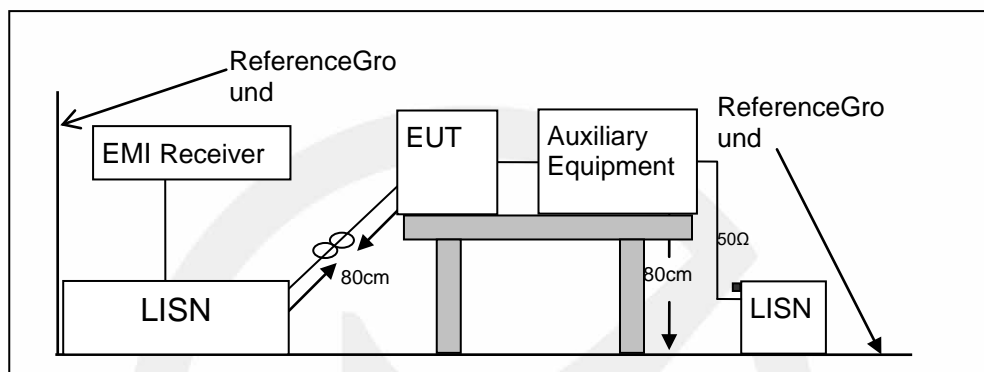

7.4 BLOCK DIAGRAM CONFIGURATION OF TEST SYSTEM

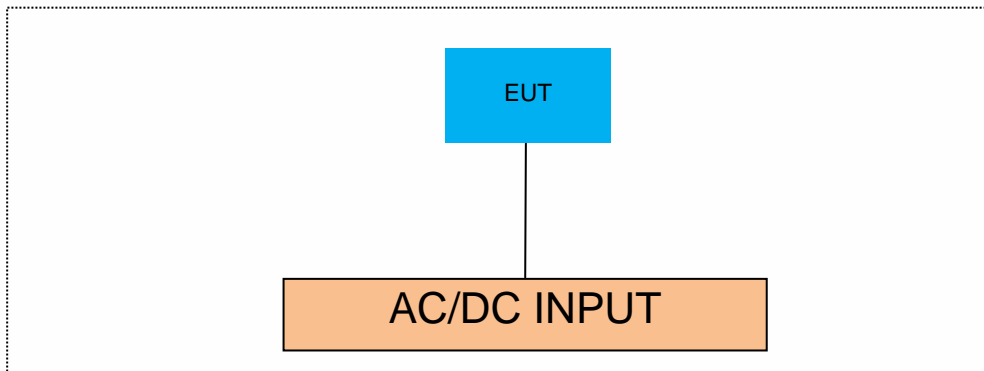

7.5 SUPPORT EQUIPMENT

EUT Cable List and Details			
Cable Description	Length (m)	Shielded/Unshielded	With / Without Ferrite
/	/	/	/

Auxiliary Cable List and Details			
Cable Description	Length (m)	Shielded/Unshielded	With / Without Ferrite
/	/	/	/

Auxiliary Equipment List and Details			
Description	Manufacturer	Model	Serial Number
/	/	/	/

Notes:

1. All the equipment/cables were placed in the worst-case configuration to maximize the emission during the test.
2. Grounding was established in accordance with the manufacturer's requirements and conditions for the intended use.

8 TEST REQUIREMENTS

8.1 DTS 6DB BANDWIDTH

8.1.1 Applicable Standard

According to FCC Part15.247 (a)(2) and KDB 558074 D01 15.247 Meas Guidance v05r02
According to RSS-247, 5.2(a)

8.1.2 Conformance Limit

The minimum -6 dB bandwidth shall be at least 500 kHz.

8.1.3 Test Configuration

Test according to clause 6.1 radio frequency test setup

8.1.4 Test Procedure

The EUT was operating in WIFI mode and controlled its channel. Printed out the test result from the spectrum by hard copy function.

The RF output of EUT was connected to the spectrum analyzer by RF cable and attenuator. The path loss was compensated to the results for each measurement.

Set to the maximum power setting and enable the EUT transmit continuously

Set RBW = 100 kHz.

Set the video bandwidth (VBW) =300kHz.

Set Span=2 times OBW

Set Detector = Peak.

Set Trace mode = max hold.

Set Sweep = auto couple.

Allow the trace to stabilize.

Measure the maximum width of the emission that is constrained by the frequencies associated with the two outermost amplitude points (upper and lower frequencies) that are attenuated by 6 dB relative to the maximum level measured in the fundamental emission.

Measure and record the results in the test report.

8.1.5 Test Results

Temperature:	25°C
Relative Humidity:	45%
ATM Pressure:	1011 mbar

Note: N/A

TestMode	Antenna	Frequency[MHz]	DTS BW [MHz]	FL[MHz]	FH[MHz]	Limit[MHz]	Verdict
11B	Ant1	2412	9.08	2407.44	2416.52	0.5	PASS
		2437	9.08	2432.44	2441.52	0.5	PASS
		2462	9.04	2457.48	2466.52	0.5	PASS
11G	Ant1	2412	16.60	2403.68	2420.28	0.5	PASS
		2437	16.48	2428.72	2445.20	0.5	PASS
		2462	16.32	2453.84	2470.16	0.5	PASS
11N20SISO	Ant1	2412	17.68	2403.16	2420.84	0.5	PASS
		2437	17.68	2428.16	2445.84	0.5	PASS
		2462	17.68	2453.16	2470.84	0.5	PASS



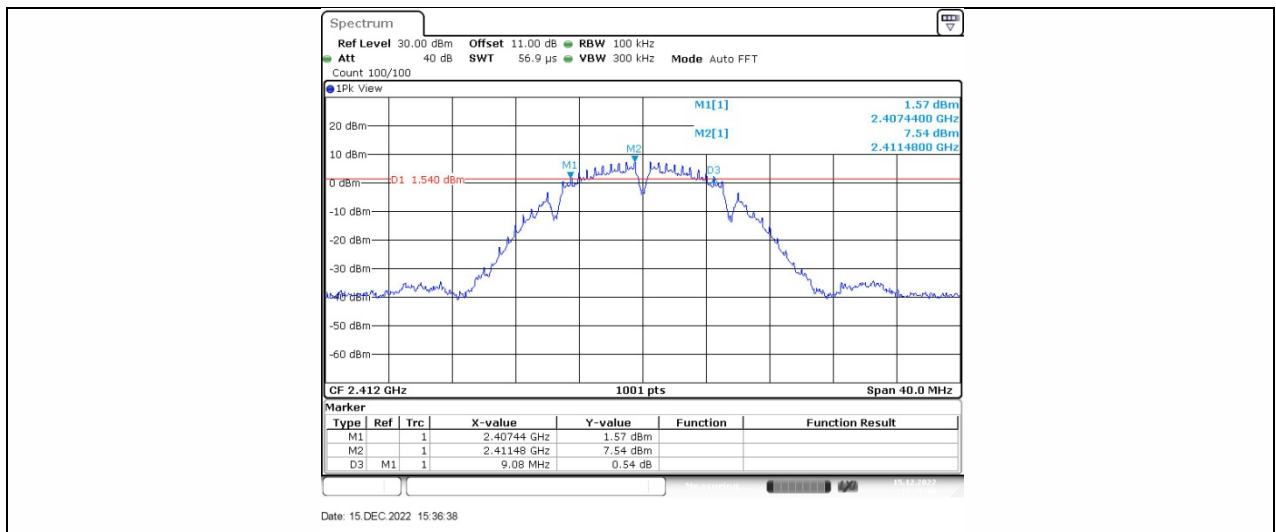

11B_Ant1_2412

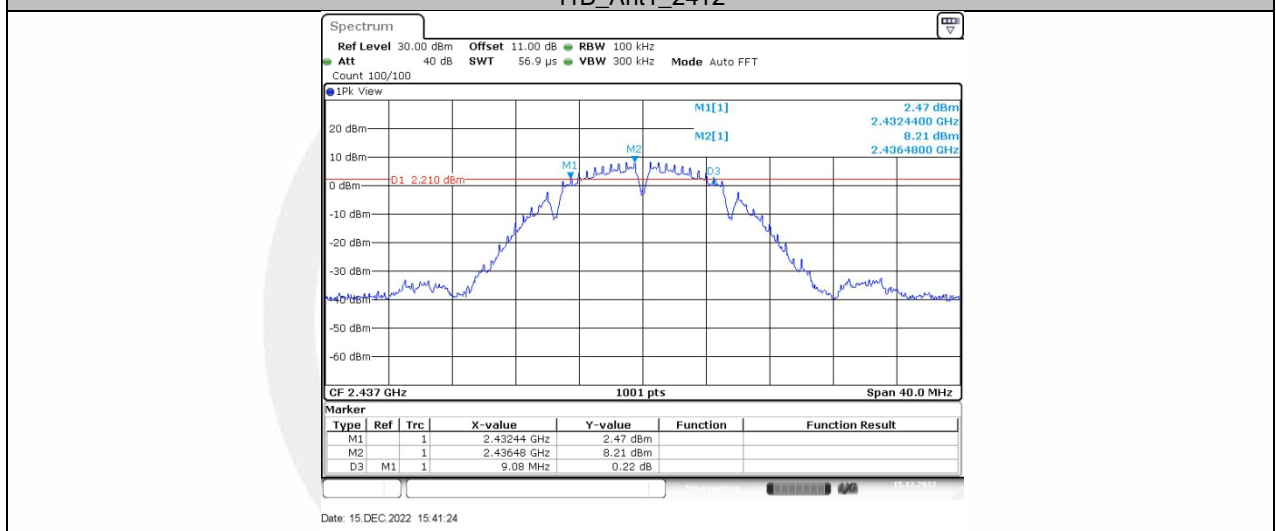

11B_Ant1_2437

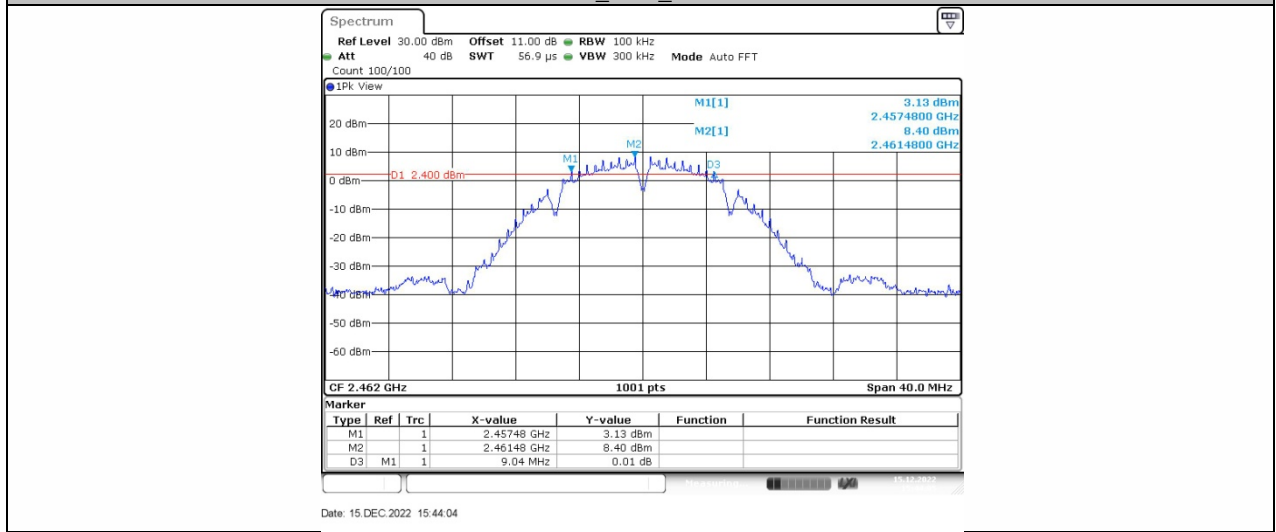

11B_Ant1_2462

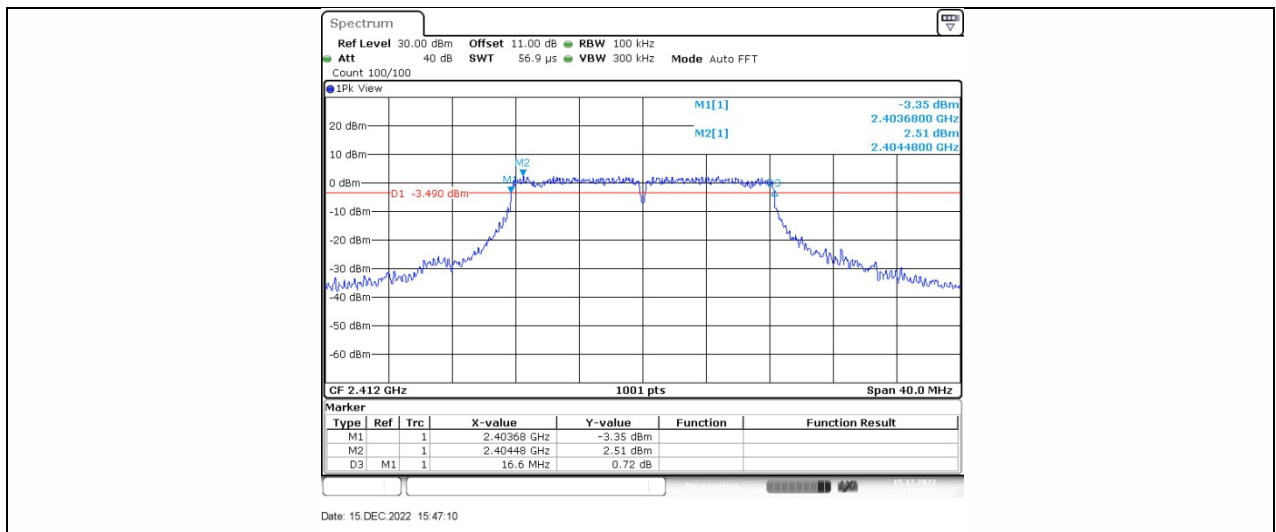

11G_Ant1_2412

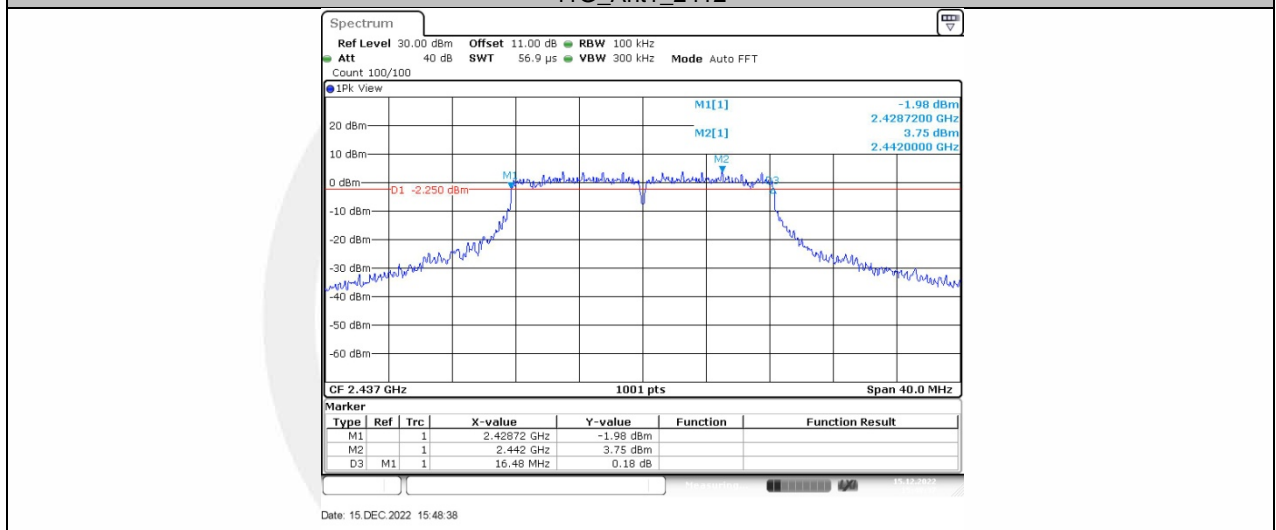

11G_Ant1_2437

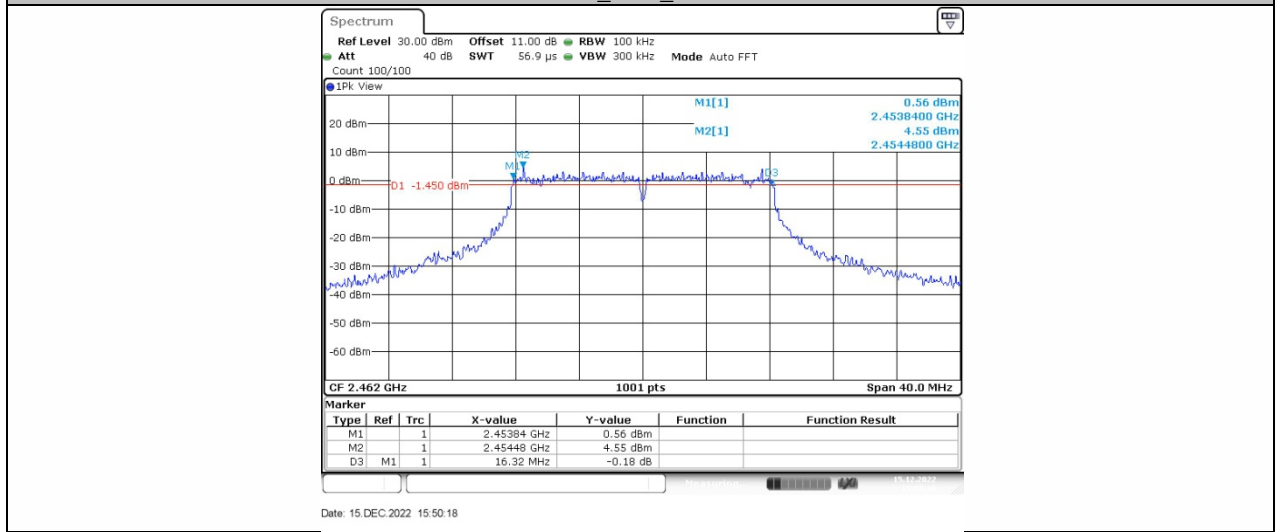

11G_Ant1_2462

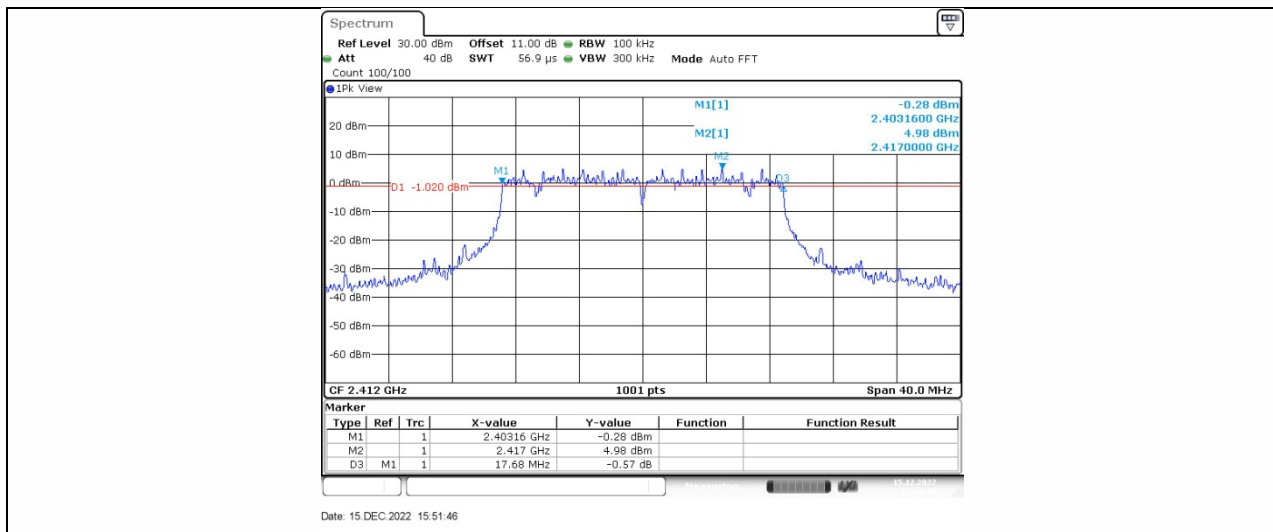

11N20SISO_Ant1_2412

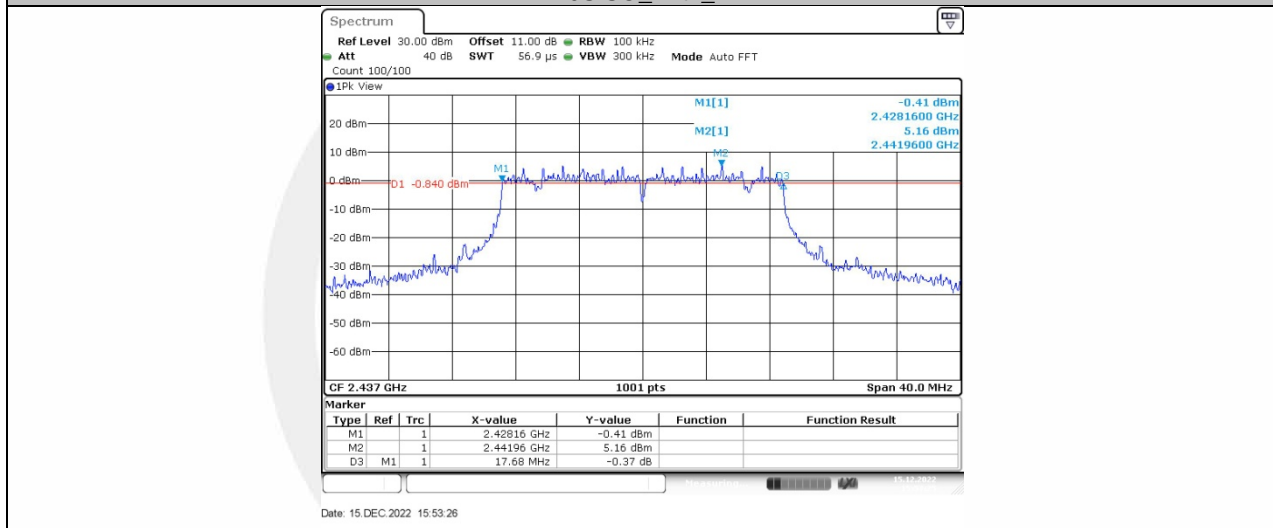

11N20SISO_Ant1_2437

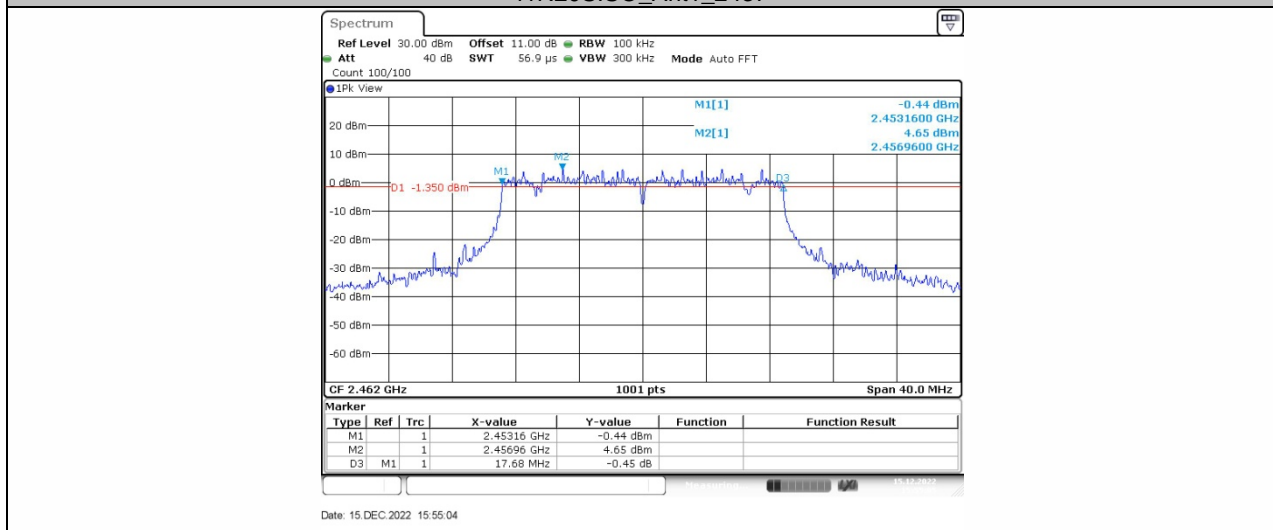

11N20SISO_Ant1_2462

8.2 DTS 99%BANDWIDTH

8.2.1 Applicable Standard

According to RSS-Gen6.7 and KDB 558074 D01 DTS Meas Guidance v05r02

8.2.2 Test Configuration

Test according to clause 7.1 radio frequency test setup 1

8.2.3 Test Procedure

The EUT was operating in Bluetooth mode and controlled its channel. Printed out the test result from the spectrum by hard copy function.

The RF output of EUT was connected to the spectrum analyzer by RF cable and attenuator. The path loss was compensated to the results for each measurement.

Set to the maximum power setting and enable the EUT transmit continuously

Set RBW = 1%-5% OBW.

Set the video bandwidth (VBW) $\geq 3 \times \text{RBW}$.

Set Span=approximately 2 to 3 times the 20 dB bandwidth.

Set Detector = Peak.

Set Trace mode = max hold.

Set Sweep = auto couple.

Allow the trace to stabilize.

Use the 99 % power bandwidth function of the instrument

Measure the maximum width of the emission.

If this value varies with different modes of operation (e.g., data rate, modulation format, etc.), repeat this test for each variation.

Measure and record the results in the test report.

8.2.4 Test Results

Temperature:	25°C
Relative Humidity:	45%
ATM Pressure:	1011 mbar

Note: N/A

TestMode	Antenna	Channel Frequency[MHz]	OCB [MHz]	FL[MHz]	FH[MHz]	Limit[MHz]	Verdict
11B	Ant1	2412	13.107	2405.447	2418.553	---	---
		2437	13.147	2430.407	2443.553	---	---
		2462	13.227	2455.367	2468.593	---	---
11G	Ant1	2412	17.103	2403.489	2420.591	---	---
		2437	17.463	2428.209	2445.671	---	---
		2462	17.303	2453.369	2470.671	---	---
11N20SISO	Ant1	2412	17.982	2402.969	2420.951	---	---
		2437	18.022	2427.969	2445.991	---	---
		2462	18.062	2452.929	2470.991	---	---



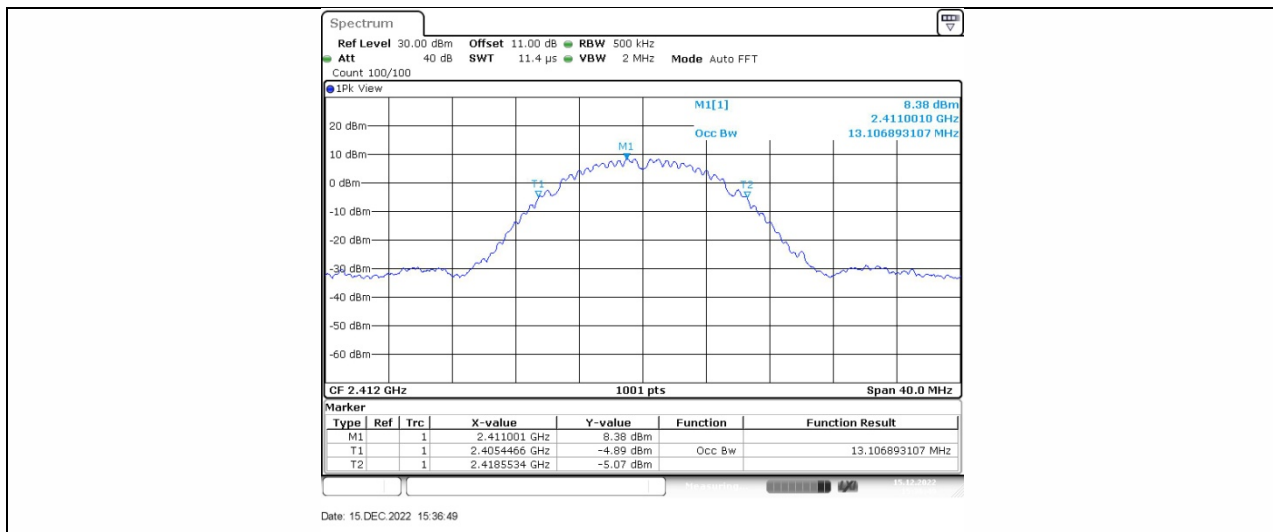

11B_Ant1_2412

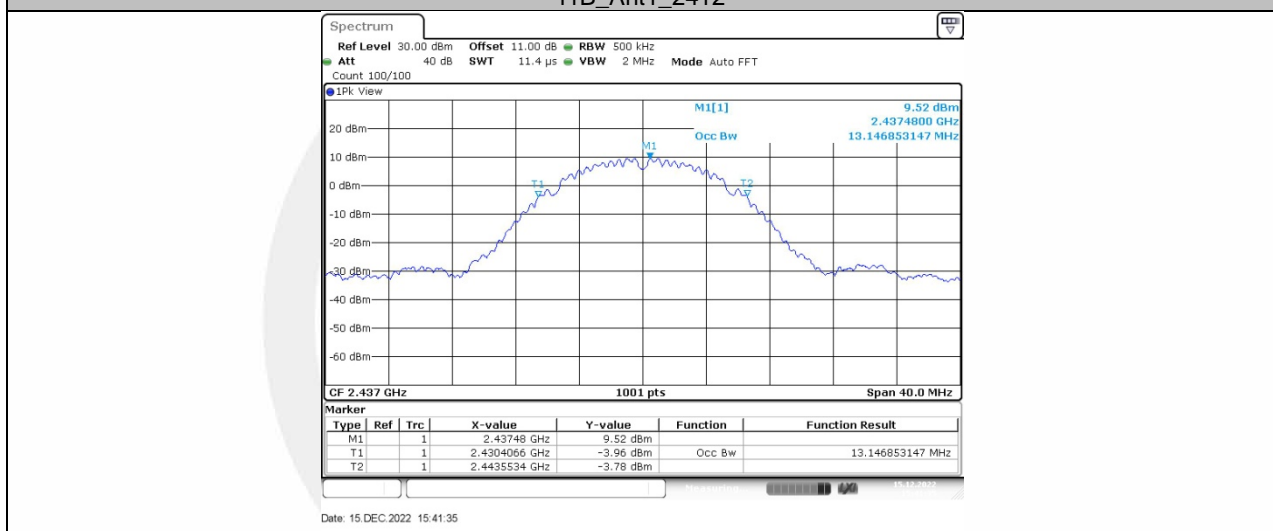

11B_Ant1_2437

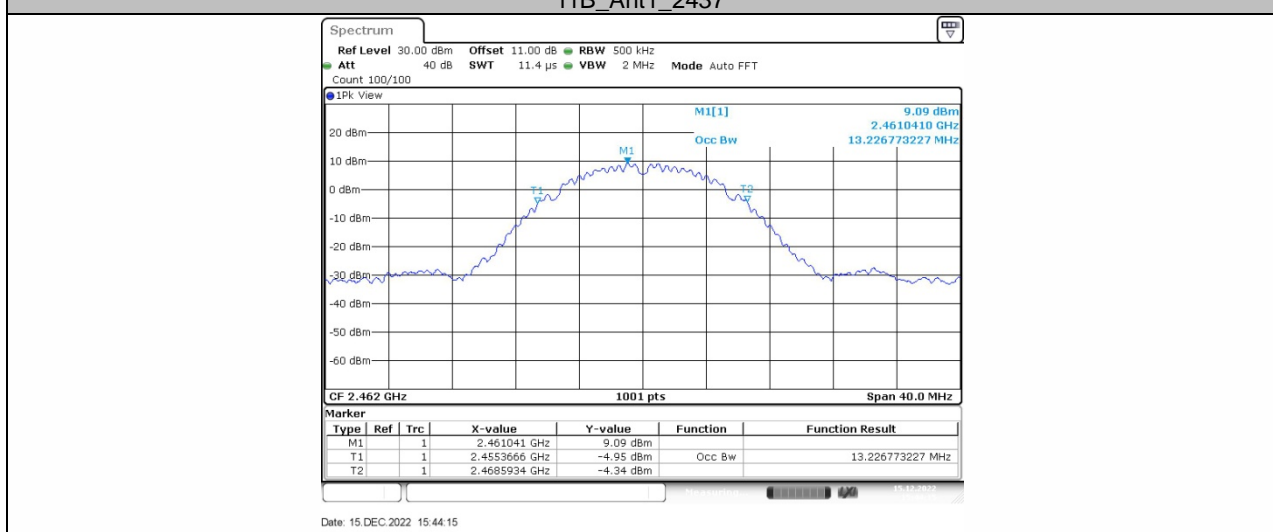

11B_Ant1_2462

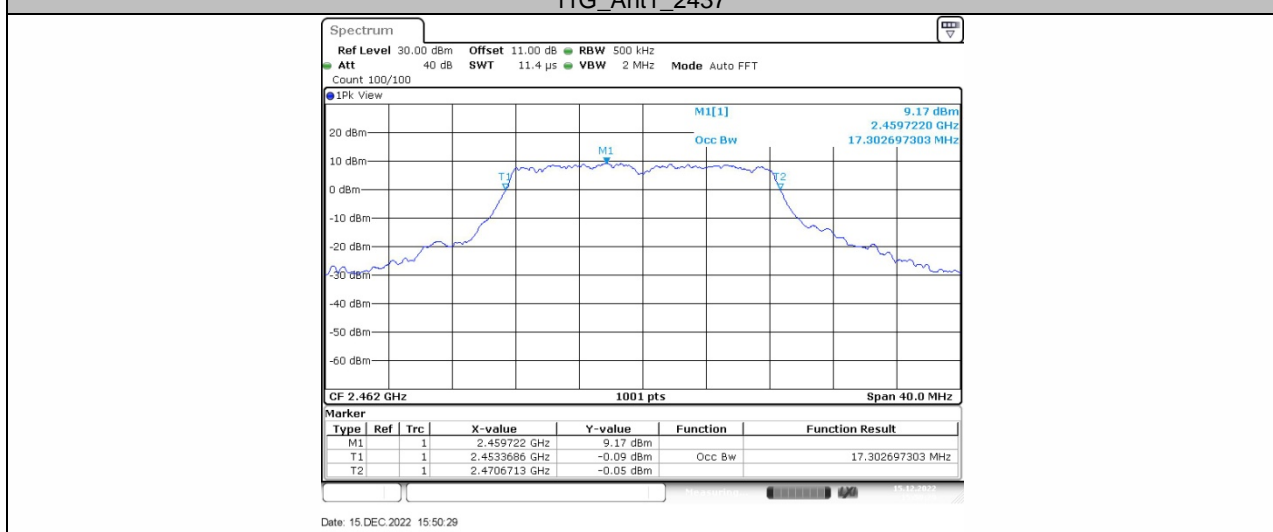
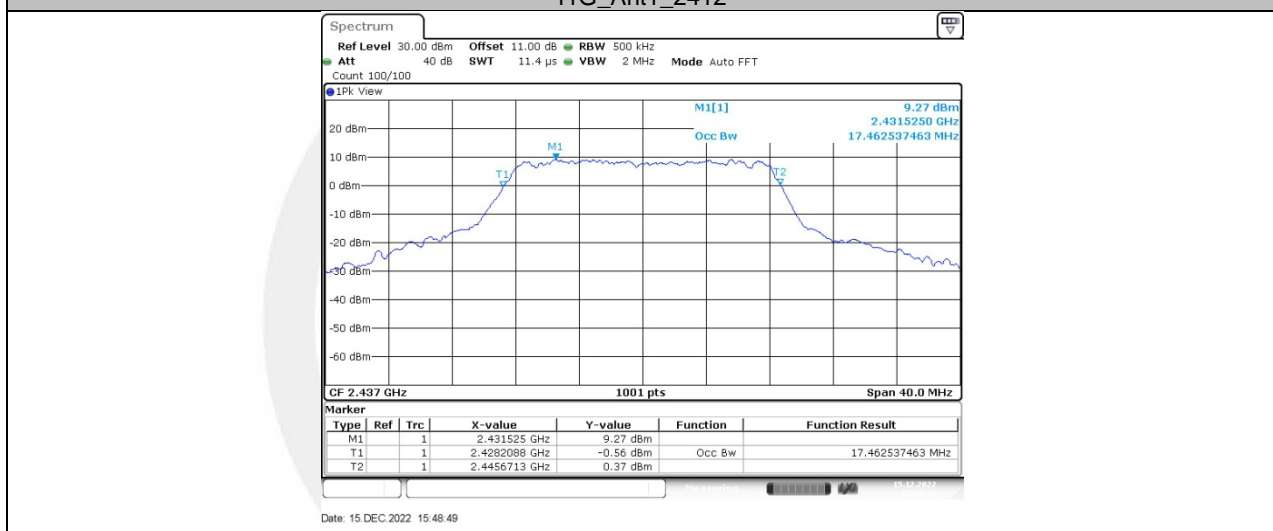
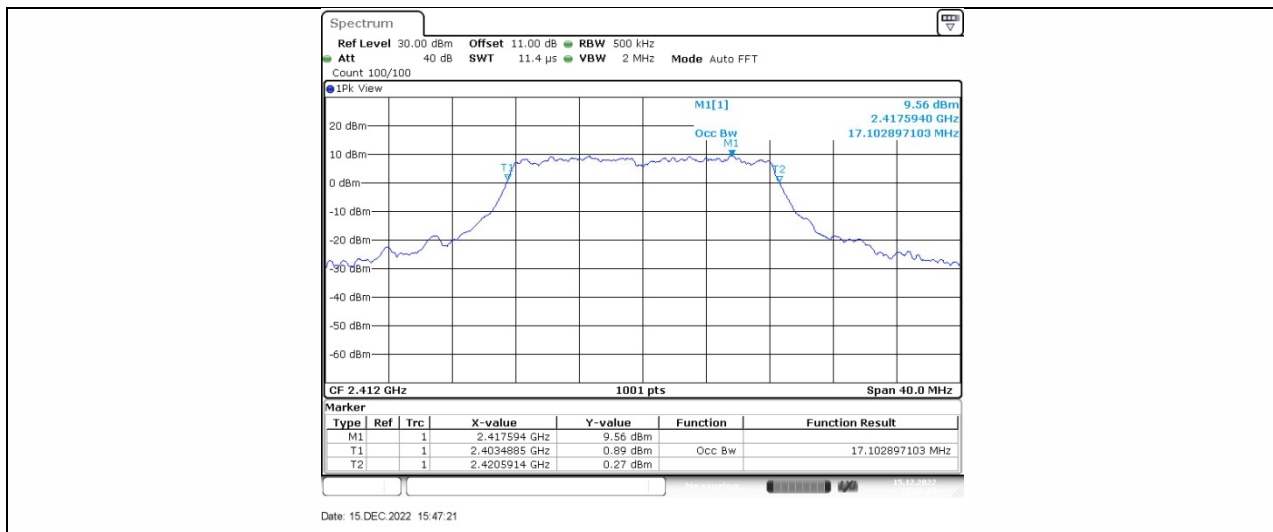

11G_Ant1_2462

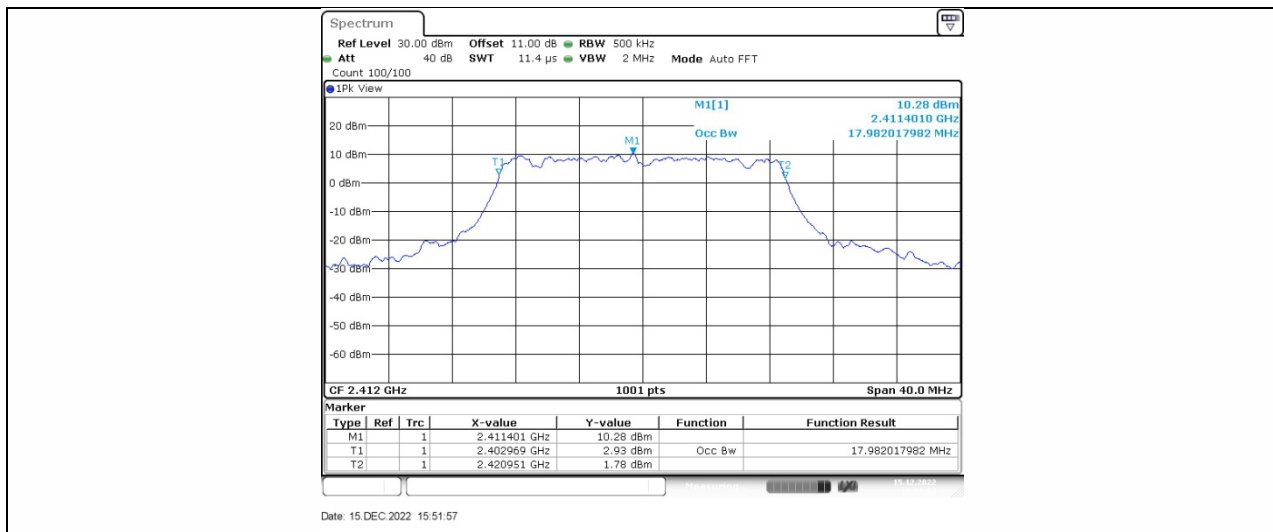

11N20SISO_Ant1_2412

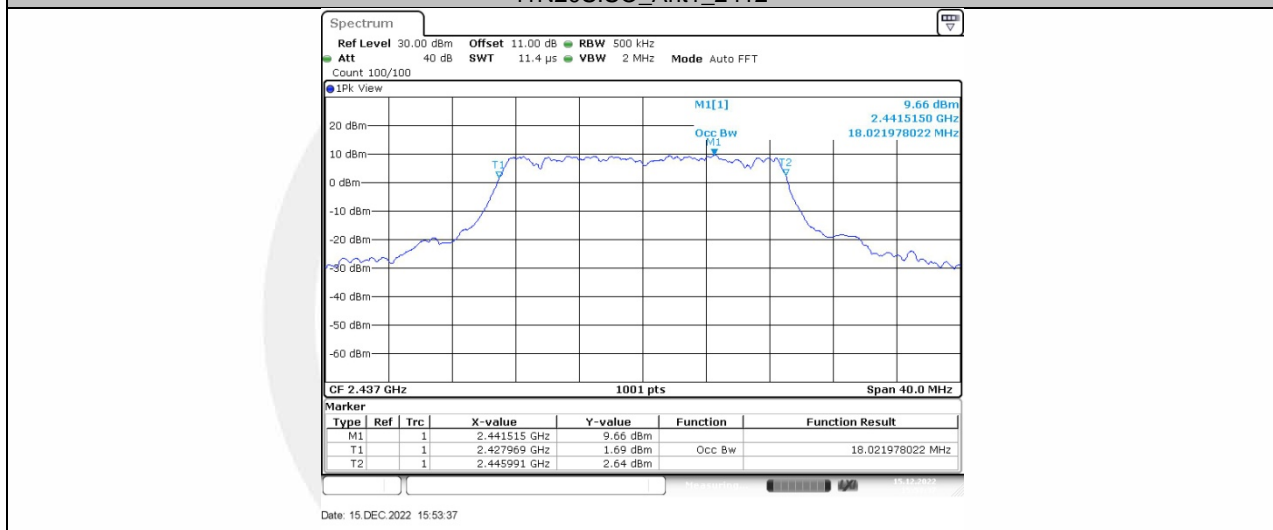

11N20SISO_Ant1_2437

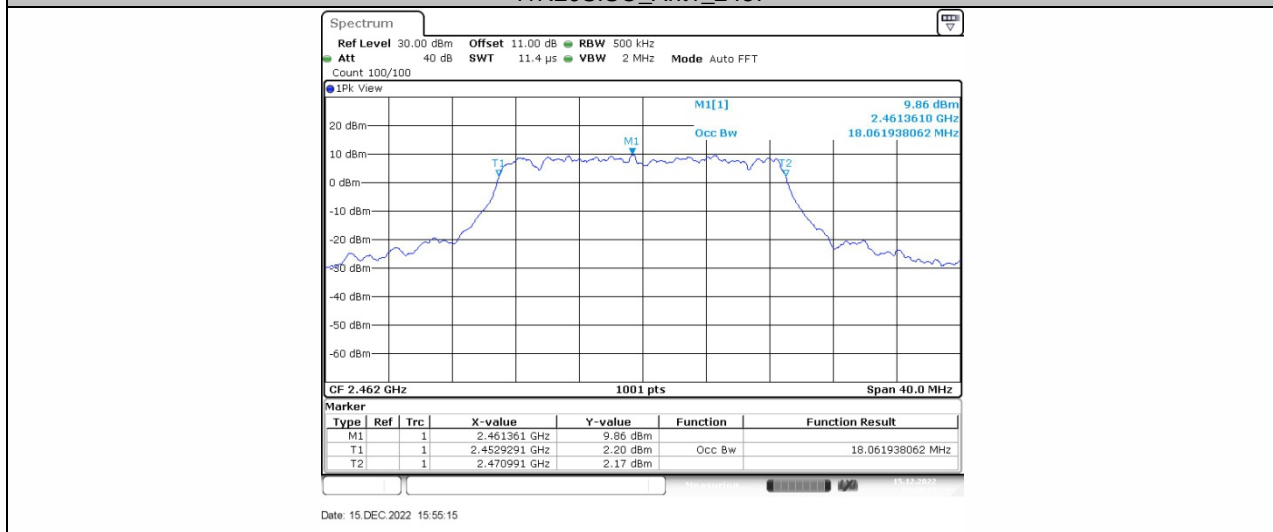

11N20SISO_Ant1_2462

8.3 MAXIMUM PEAK CONDUCTED OUTPUT POWER

8.3.1 Applicable Standard

According to FCC Part15.247 (b)(3) and KDB 558074 D01 15.247 Meas Guidance v05r02
 According to RSS-247, 5.4(d) and RSS-Gen6.12

8.3.2 Conformance Limit

The maximum conducted output power of the intentional radiator for systems using digital modulation in the 2400 - 2483.5 MHz bands shall not exceed: 1 Watt (30dBm).

8.3.3 Test Configuration

Test according to clause 6.1 radio frequency test setup

8.3.4 Test Procedure

- a) Set span to at least 1.5 times the OBW.
- b) Set RBW = 1-5% of the OBW, not to exceed 1 MHz.
- c) Set VBW $\geq 3 \times$ RBW.
- d) Number of points in sweep $\geq 2 \times$ span / RBW. (This gives bin-to-bin spacing \leq RBW/2, so that narrowband signals are not lost between frequency bins.)
- e) Sweep time = auto.
- f) Detector = RMS (i.e., power averaging), if available. Otherwise, use sample detector mode.
- g) If transmit duty cycle < 98 %, use a sweep trigger with the level set to enable triggering only on full power pulses. The transmitter shall operate at maximum power control level for the entire duration of every sweep. If the EUT transmits continuously (i.e., with no off intervals) or at duty cycle $\geq 98 \%$, and if each transmission is entirely at the maximum power control level, then the trigger shall be set to “free run” .
- h) Trace average at least 100 traces in power averaging (i.e., RMS) mode.
- i) Compute power by integrating the spectrum across the OBW of the signal using the instrument’s band power measurement function, with band limits set equal to the OBW band edges. If the instrument does not have a band power function, sum the spectrum levels (in power units) at intervals equal to the RBW extending across the entire OBW of the spectrum.

■ According to FCC Part 15.247(b)(4):

Conducted output power limit specified in paragraph (b) of this section is based on the use of antennas with directional gains that do not exceed 6 dBi. If transmitting antennas of directional gain greater than 6 dBi are used, the conducted output power from the intentional radiator shall be reduced below the stated values in paragraphs (b)(3) of this section, as appropriate, by the amount in dB that the directional gain of the antenna exceeds 6 dBi.

Note: If antenna Gain exceeds 6 dBi, then Output power Limit=30-(Gain- 6)

8.3.5 Test Results

Temperature:	25 °C
Relative Humidity:	45%
ATM Pressure:	1011 mbar

Note: N/A

TestMode	Antenna	Frequency[MHz]	AVG Power[dBm]	Conducted Limit[dBm]	Verdict
11B	Ant1	2412	16.16	≤30.00	PASS
		2437	17.27	≤30.00	PASS
		2462	16.79	≤30.00	PASS
11G	Ant1	2412	16.17	≤30.00	PASS
		2437	16.50	≤30.00	PASS
		2462	16.35	≤30.00	PASS
11N20SISO	Ant1	2412	16.21	≤30.00	PASS
		2437	16.21	≤30.00	PASS
		2462	16.24	≤30.00	PASS



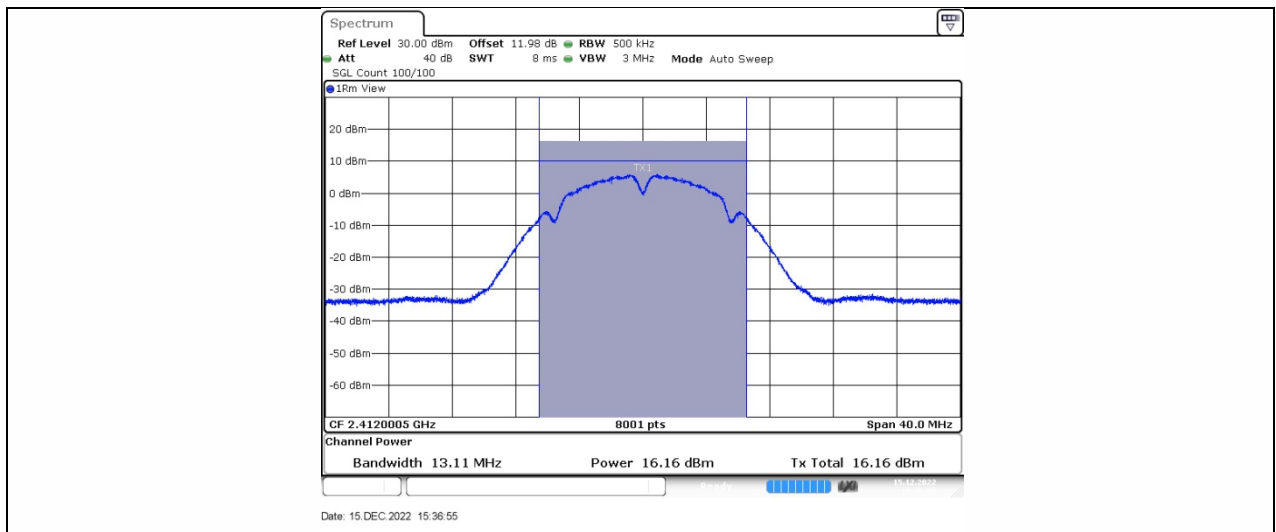

11B_Ant1_2412

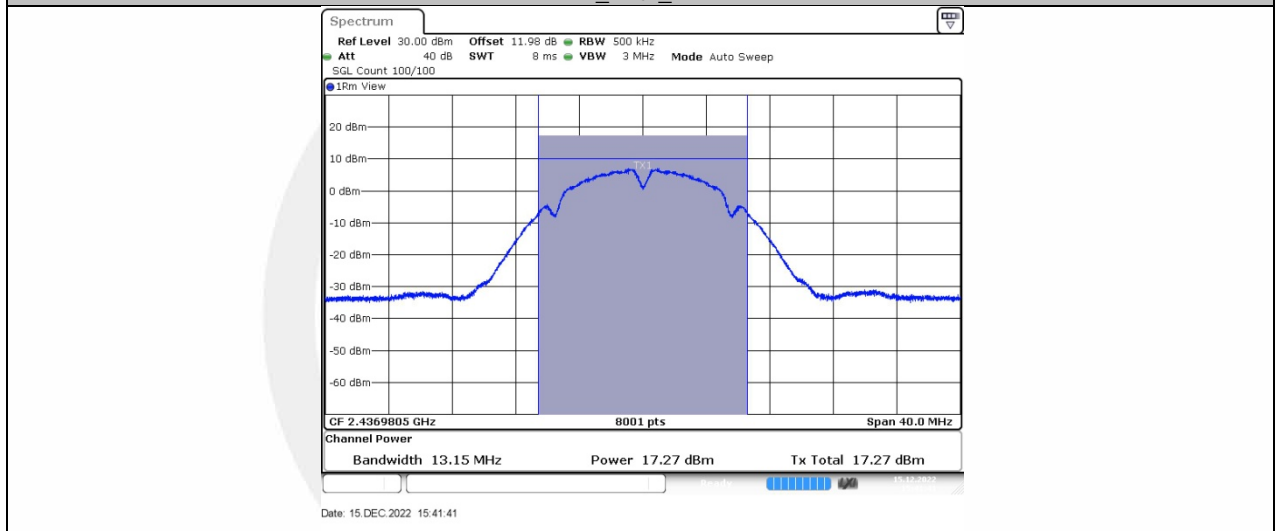

11B_Ant1_2437

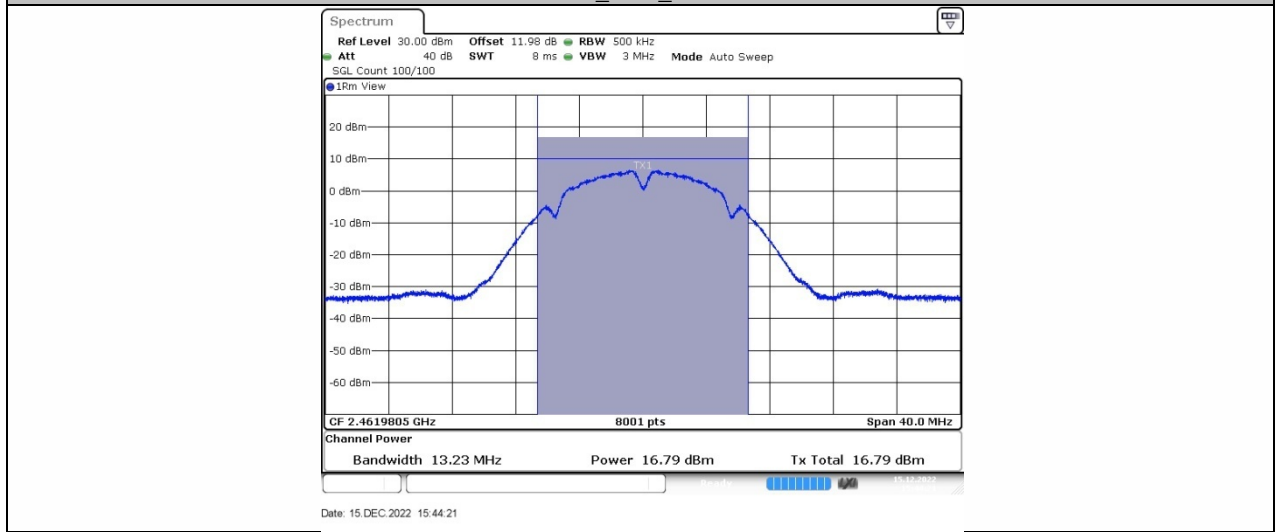

11B_Ant1_2462

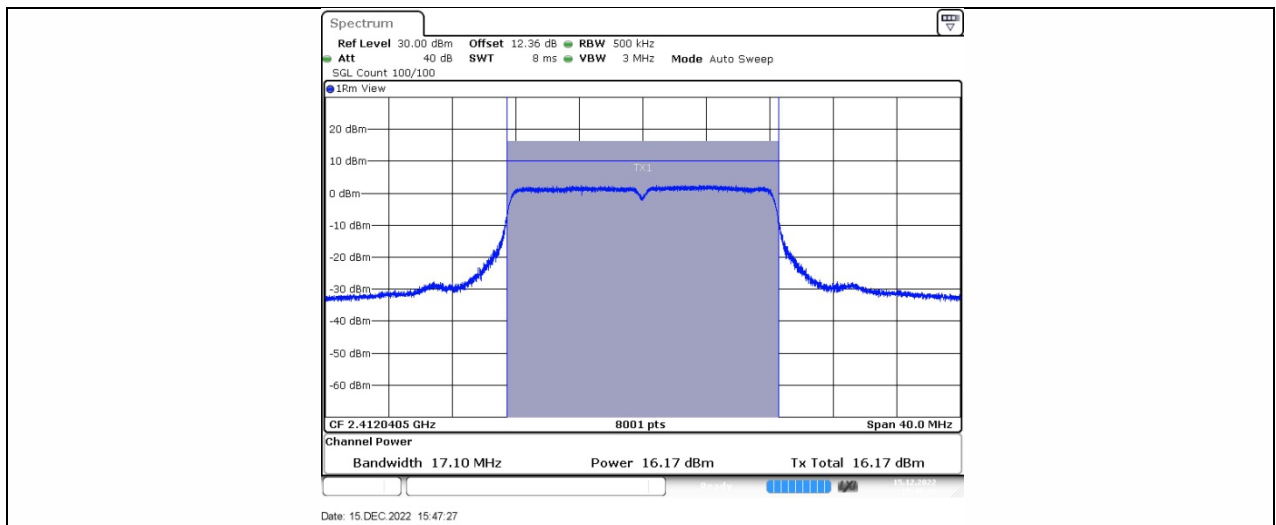

11G_Ant1_2412

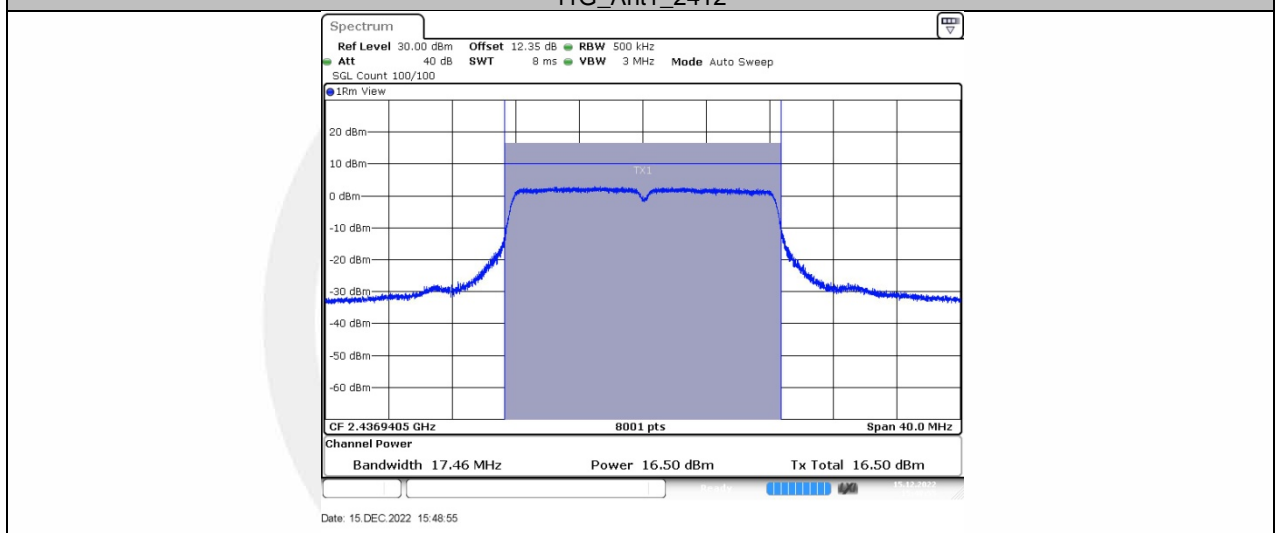

11G_Ant1_2437

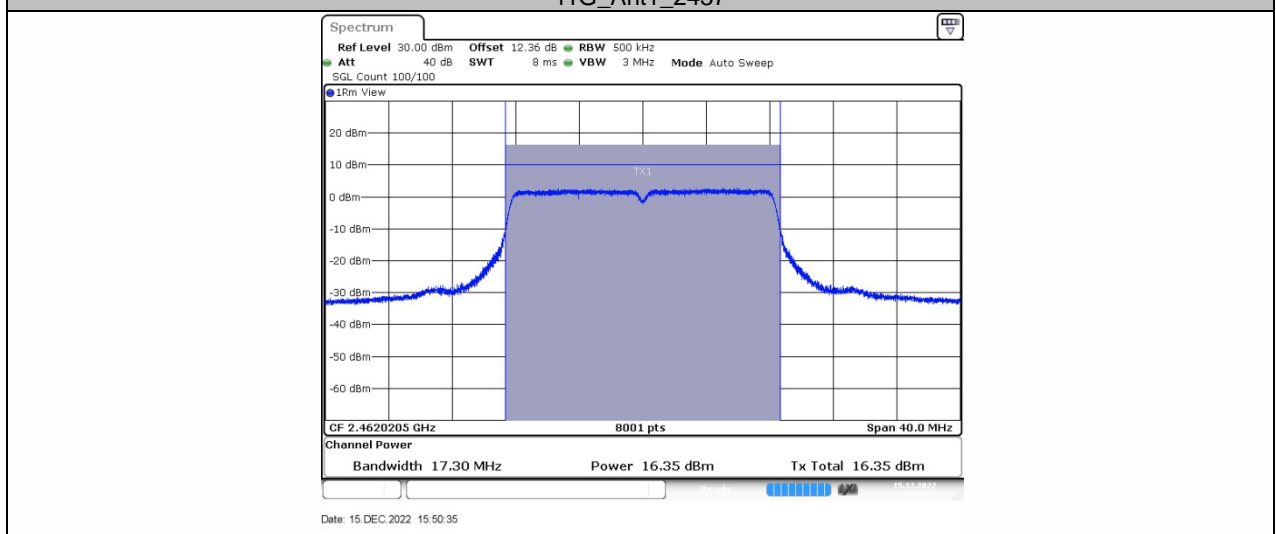

11G_Ant1_2462

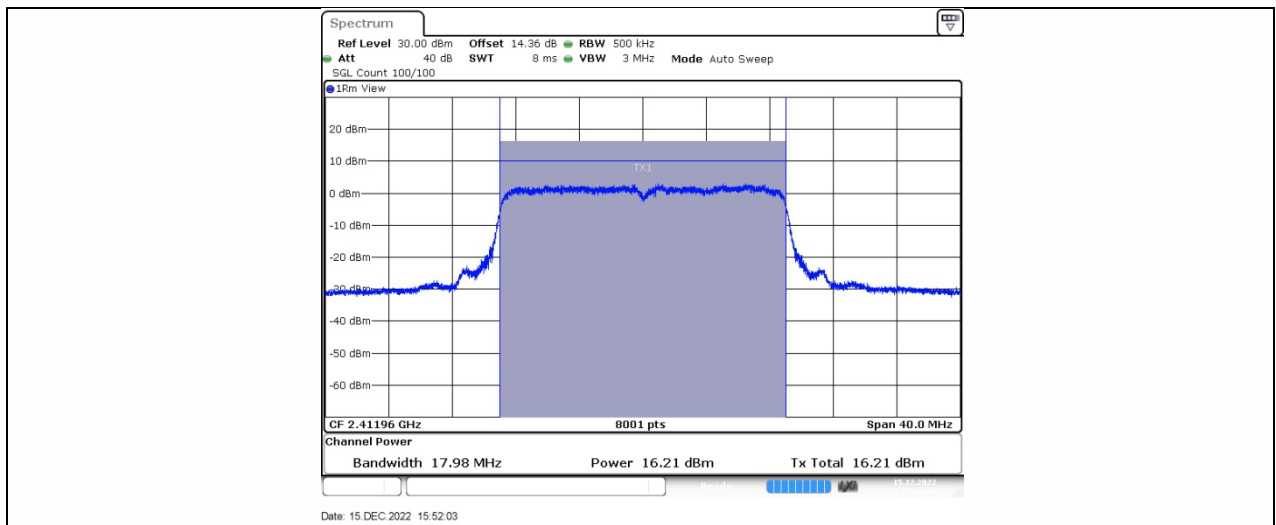

11N20SISO_Ant1_2412

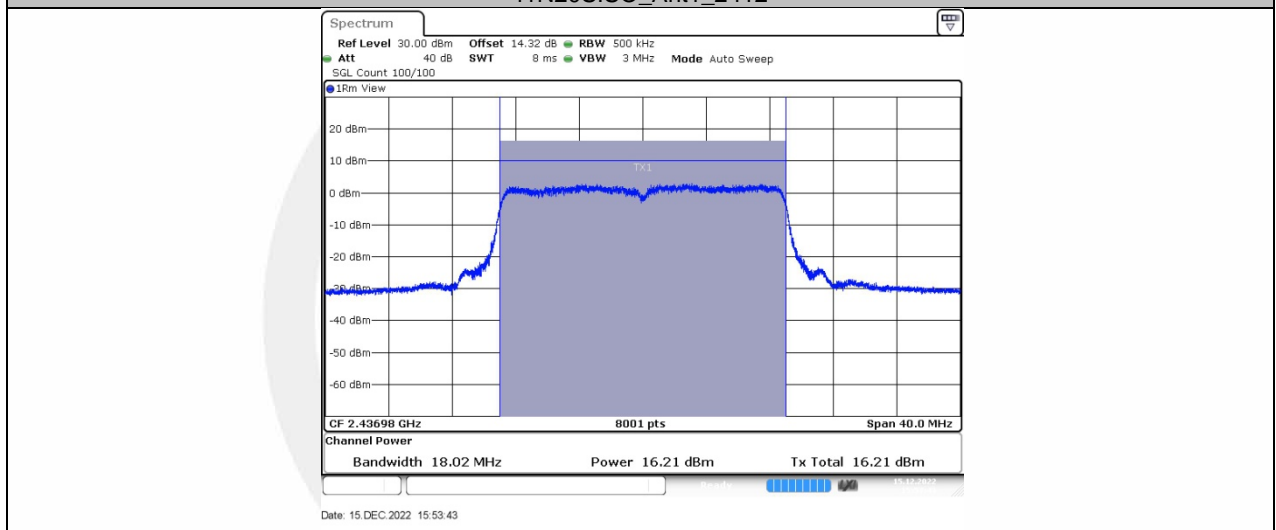

11N20SISO_Ant1_2437

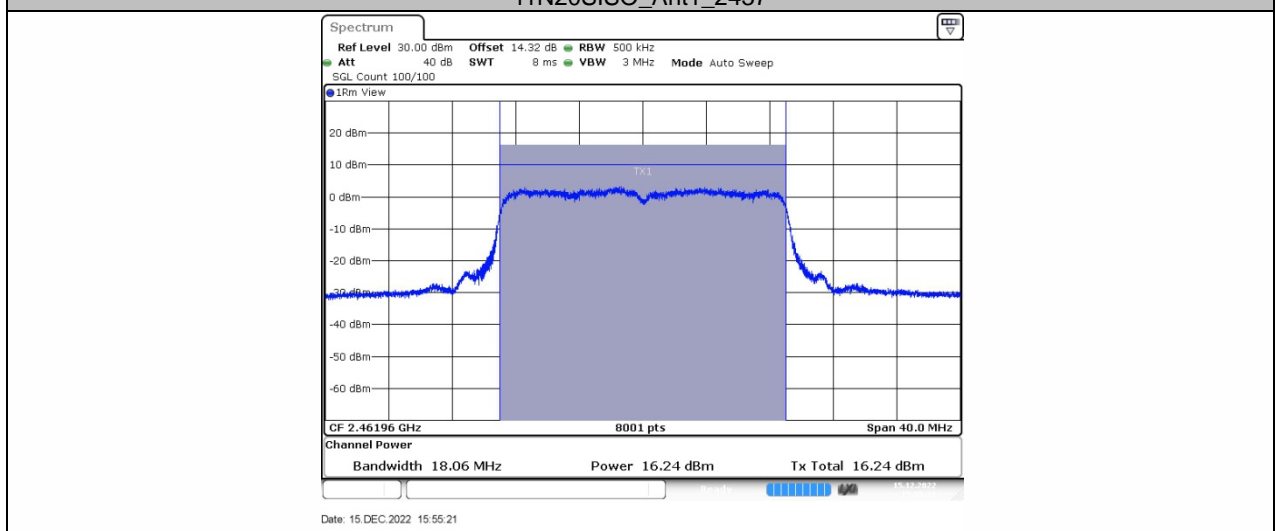

11N20SISO_Ant1_2462

8.4 MAXIMUM POWER SPECTRAL DENSITY

8.4.1 Applicable Standard

According to FCC Part15.247(e) and KDB 558074 D01 15.247 Meas Guidance v05r02

According to RSS-247, 5.2(b) and RSS-Gen6.12

8.4.2 Conformance Limit

The transmitter power spectral density conducted from the transmitter to the antenna shall not be greater than 8 dBm in any 3 kHz band during any time interval of continuous transmission. This power spectral density shall be determined in accordance with the provisions of section 5.4(d), (i.e. the power spectral density shall be determined using the same method as is used to determine the conducted output power).

8.4.3 Test Configuration

Test according to clause 6.1 radio frequency test setup

8.4.4 Test Procedure

This procedure shall be used if maximum peak conducted output power was used to demonstrate compliance

The transmitter output (antenna port) was connected to the spectrum analyzer

Set analyzer center frequency to DTS channel center frequency.

Set the span to 1.5 times the DTS bandwidth.

Set the RBW to: 3 kHz

Set the VBW to: 10 kHz.

Set Detector = peak.

Set Sweep time = auto couple.

Set Trace mode = max hold.

Allow trace to fully stabilize.

Use the peak marker function to determine the maximum amplitude level within the RBW.

8.4.5 Test Results

Temperature:	25 °C
Relative Humidity:	45%
ATM Pressure:	1011 mbar

Note: N/A

TestMode	Antenna	Frequency[MHz]	Result[dBm/3-100kHz]	Limit[dBm/3kHz]	Verdict
11B	Ant1	2412	-12.82	≤8.00	PASS
		2437	-11.22	≤8.00	PASS
		2462	-11.38	≤8.00	PASS
11G	Ant1	2412	-15.39	≤8.00	PASS
		2437	-15.69	≤8.00	PASS
		2462	-15.77	≤8.00	PASS
11N20SISO	Ant1	2412	-15.42	≤8.00	PASS
		2437	-11.85	≤8.00	PASS
		2462	-12.45	≤8.00	PASS



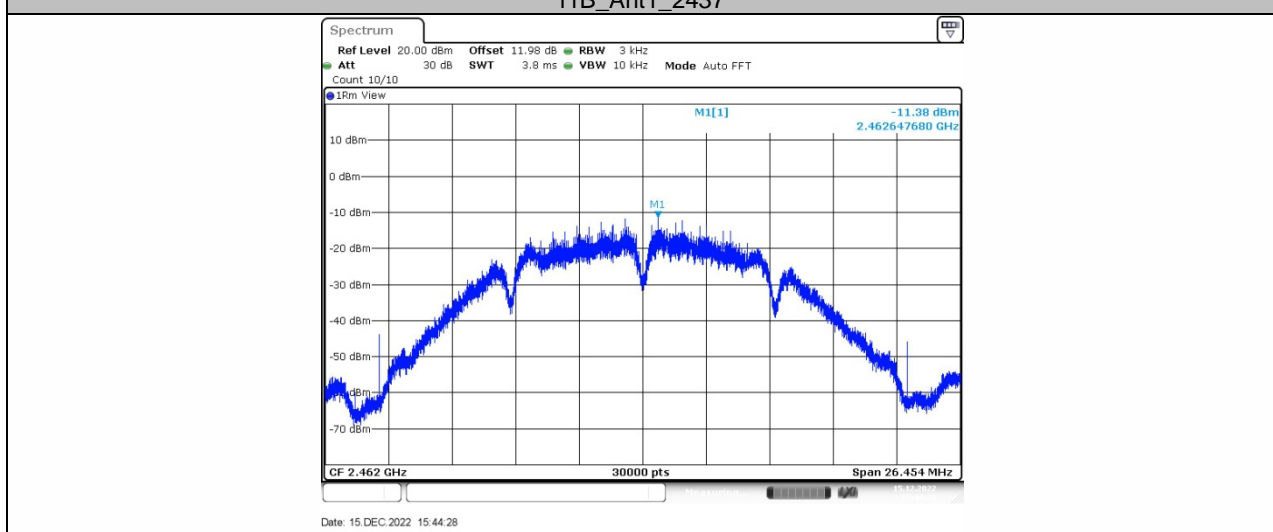
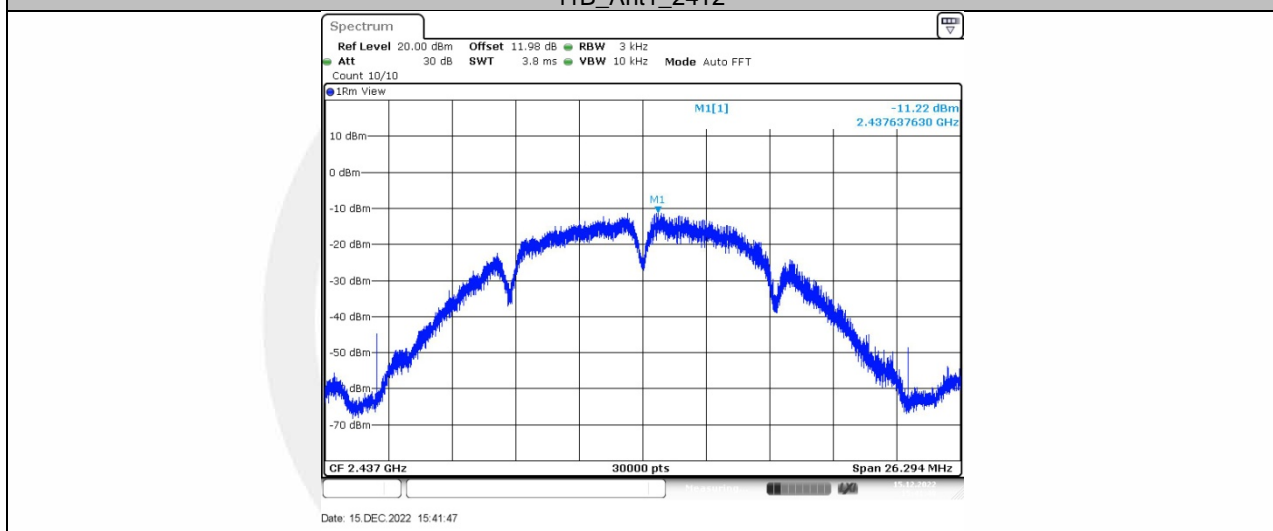
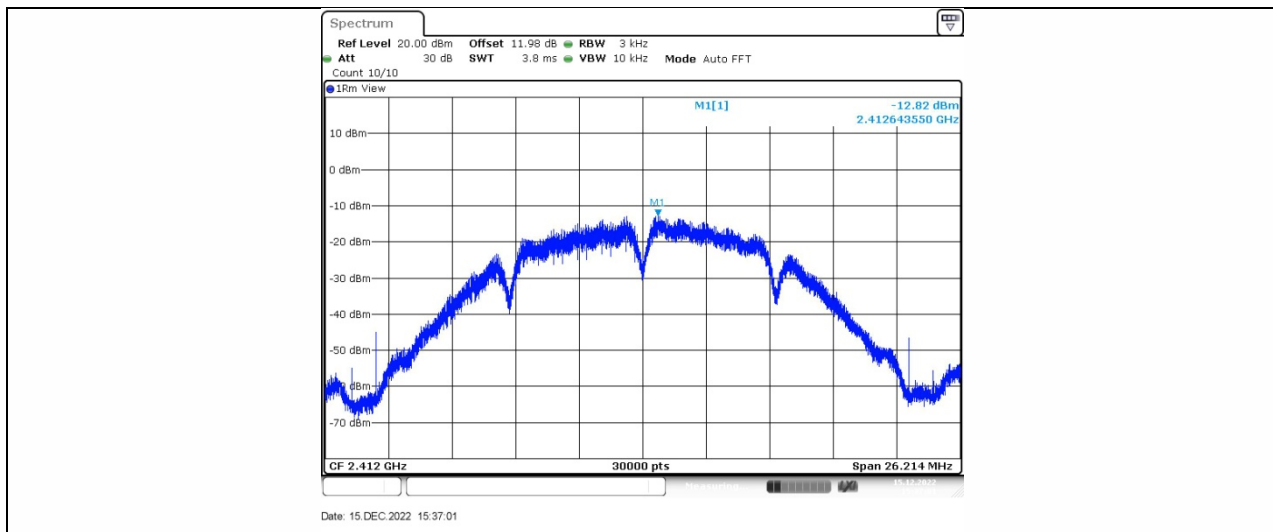

11B_Ant1_2462

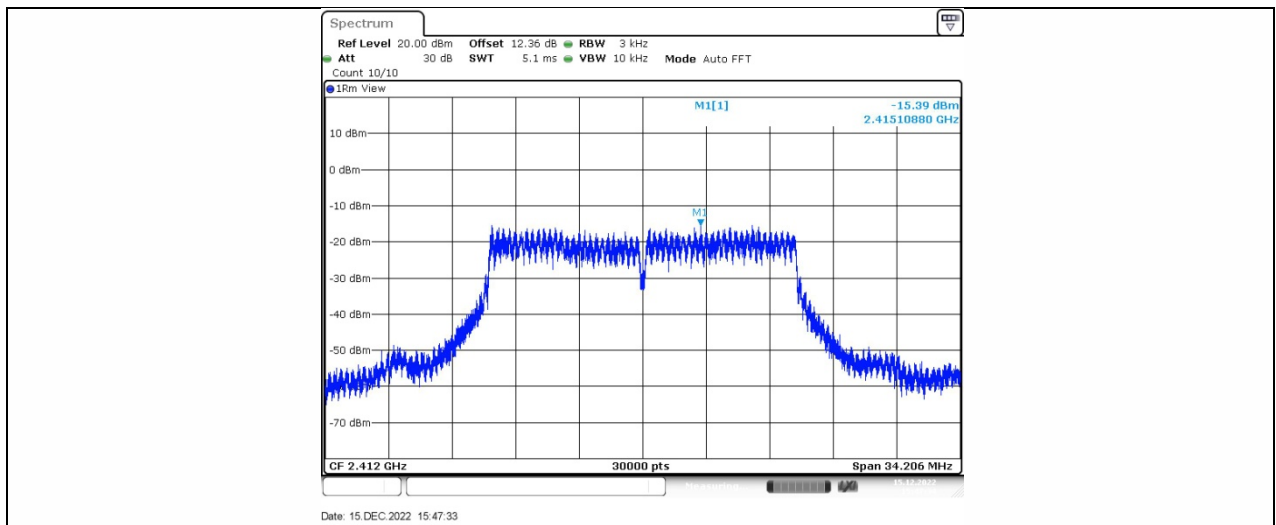

11G_Ant1_2412

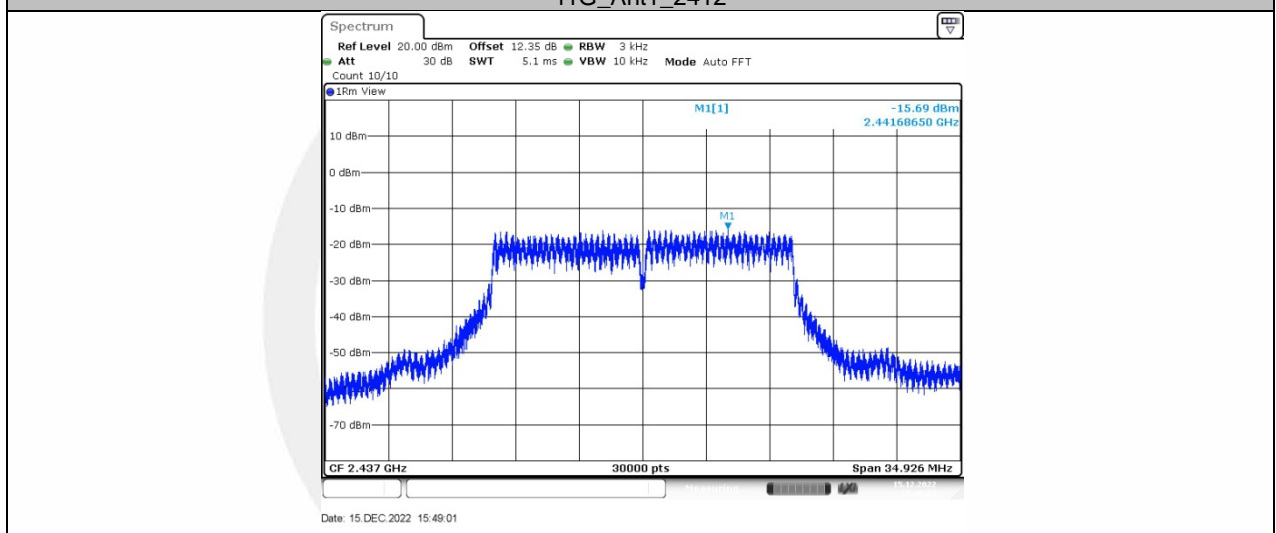

11G_Ant1_2437

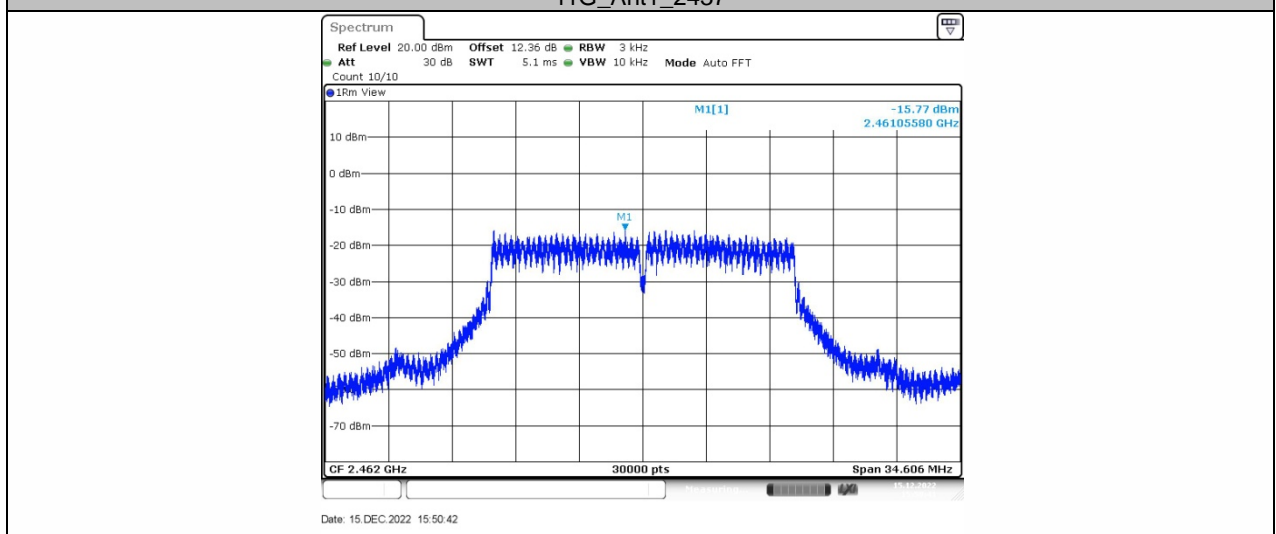

11G_Ant1_2462

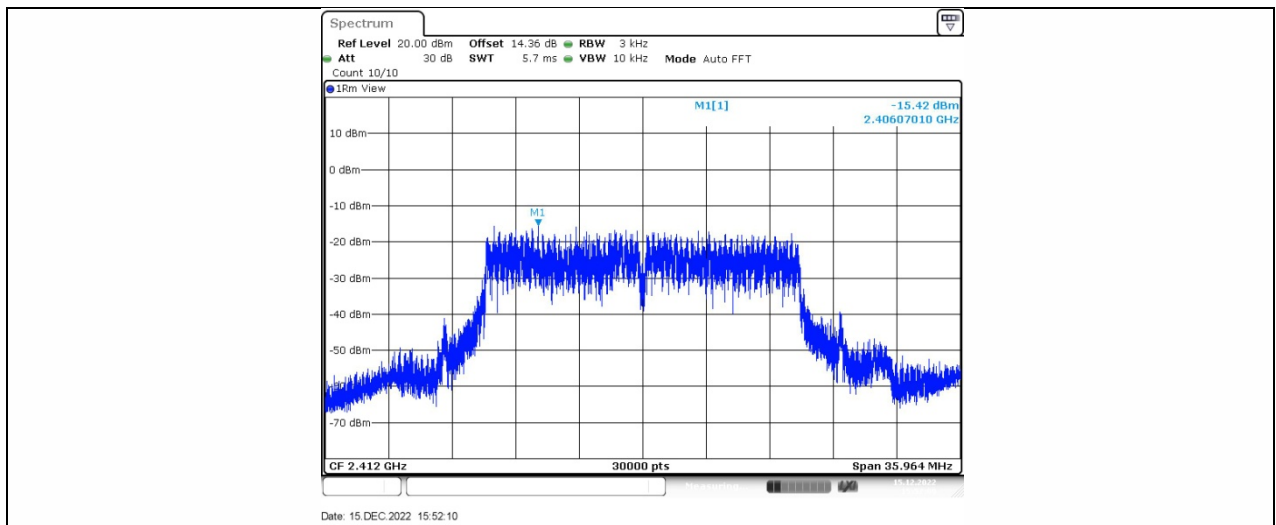

11N20SISO_Ant1_2412

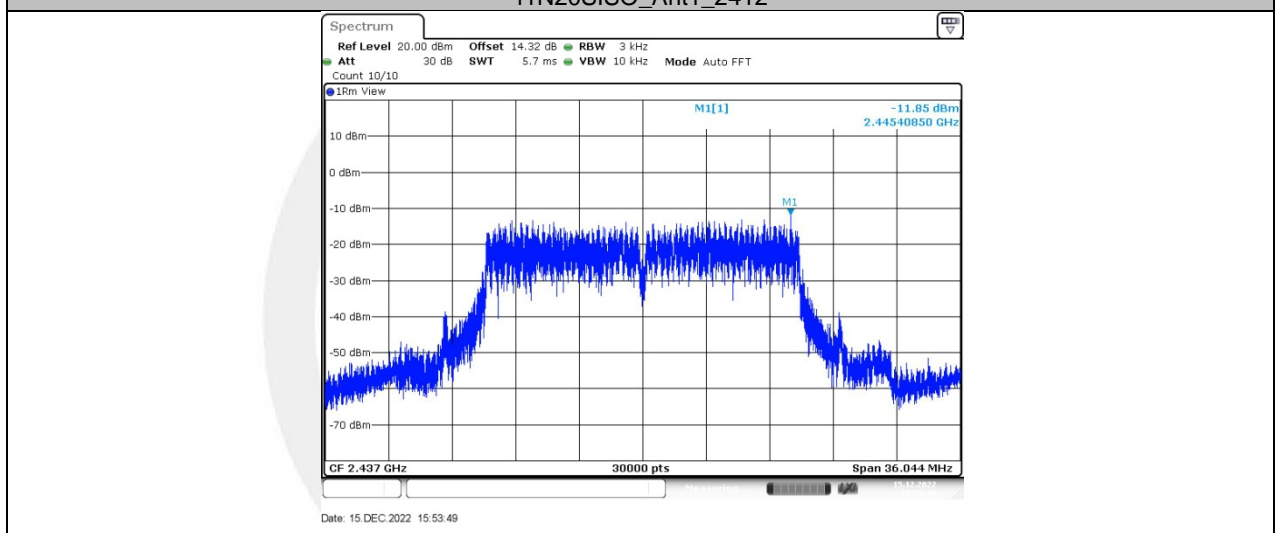

11N20SISO_Ant1_2437

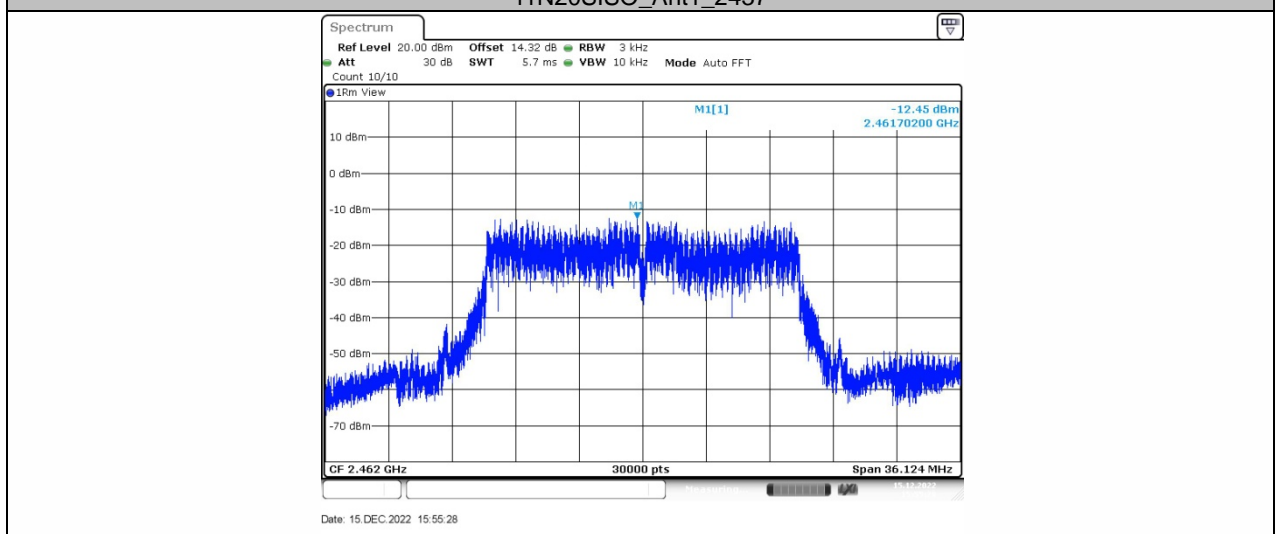

11N20SISO_Ant1_2462

8.5 UNWANTED EMISSIONS IN NON-RESTRICTED FREQUENCY BANDS

8.5.1 Applicable Standard

According to FCC Part15.247(d) and KDB 558074 D01 15.247 Meas Guidance v05r02

According to RSS-247, 5.5

8.5.2 Conformance Limit

According to FCC Part 15.247(d):

In any 100 kHz bandwidth outside the frequency band in which the spread spectrum or digitally modulated device is operating, the RF power that is produced shall be at least 20 dB below that in the 100 kHz bandwidth within the band that contains the highest level of the desired power, based on either an RF conducted or a radiated measurement, provided that the transmitter demonstrates compliance with the peak conducted power limits. If the transmitter complies with the conducted power limits based on the use of root-mean-square averaging over a time interval, as permitted under section 5.4(d), the attenuation required shall be 30 dB instead of 20 dB. Attenuation below the general field strength limits specified in RSS-Gen is not required.

8.5.3 Test Configuration

Test according to clause 6.1 radio frequency test setup

8.5.4 Test Procedure

The transmitter output (antenna port) was connected to the spectrum analyzer

■ Reference level measurement

Establish a reference level by using the following procedure:

Set instrument center frequency to DTS channel center frequency.

Set the span to ≥ 1.5 times the DTS bandwidth.

Set the RBW = 100 kHz.

Set the VBW $\geq 3 \times$ RBW.

Set Detector = peak.

Set Sweep time = auto couple.

Set Trace mode = max hold.

Allow trace to fully stabilize.

Use the peak marker function to determine the maximum PSD level.

Note that the channel found to contain the maximum PSD level can be used to establish the reference level.

■ Band-edge measurement

Use the following spectrum analyzer settings:

Span = wide enough to capture the peak level of the emission operating on the channel closest to the band-edge, as well as any modulation products which fall outside of the authorized band of operation

Set RBW $\geq 1\%$ of the span=100kHz Set VBW $\geq 3 \times$ RBW

Set Sweep = auto Set Detector function = peak Set Trace = max hold

Allow the trace to stabilize. Set the marker on the emission at the bandedge, or on the highest modulation product outside of the band, if this level is greater than that at the bandedge. Enable the marker-delta function, then use the marker-to-peak function to move the marker to the peak of the in-band emission. The marker-delta value now displayed must comply with the limit specified in this Section.

■ Emission level measurement

Set the center frequency and span to encompass frequency range to be measured.

Set the RBW = 100 kHz.

Set the VBW =300 kHz.

Set Detector = peak

Sweep time = auto couple.

Trace mode = max hold.

Allow trace to fully stabilize.

Use the peak marker function to determine the maximum amplitude level.

Ensure that the amplitude of all unwanted emissions outside of the authorized frequency band (excluding restricted frequency bands) are attenuated by at least the minimum requirements. Report the three highest emissions relative to the limit.

8.5.5 Test Results

Temperature:	25 °C
Relative Humidity:	45%
ATM Pressure:	1011 mbar

Note: N/A

All the antenna (Antenna 1) and modes (802.11b/g/n) have been tested and the worst (Antenna 1, 802.11b) result recorded was reported as below:

Test Mode	Antenna	Channel Name	Frequency [MHz]	RefLevel [dBm]	Result [dBm]	Limit [dBm]	Verdict
11B	Ant1	Low	2412	8.03	-36.56	≤ -21.97	PASS
		High	2462	7.71	-44.53	≤ -22.29	PASS



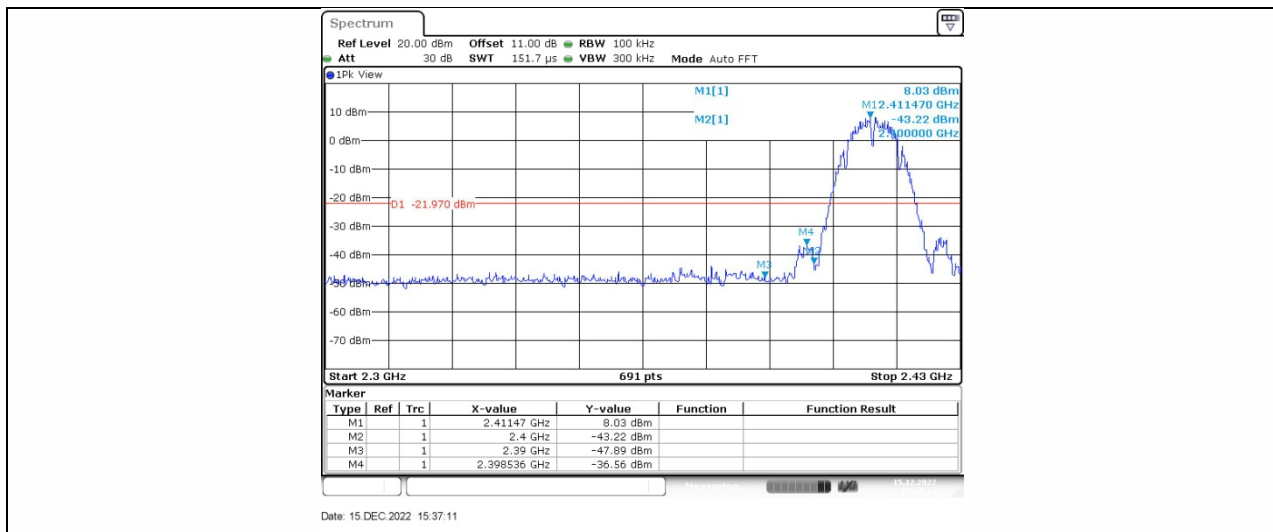

11B_Ant1_Low_2412

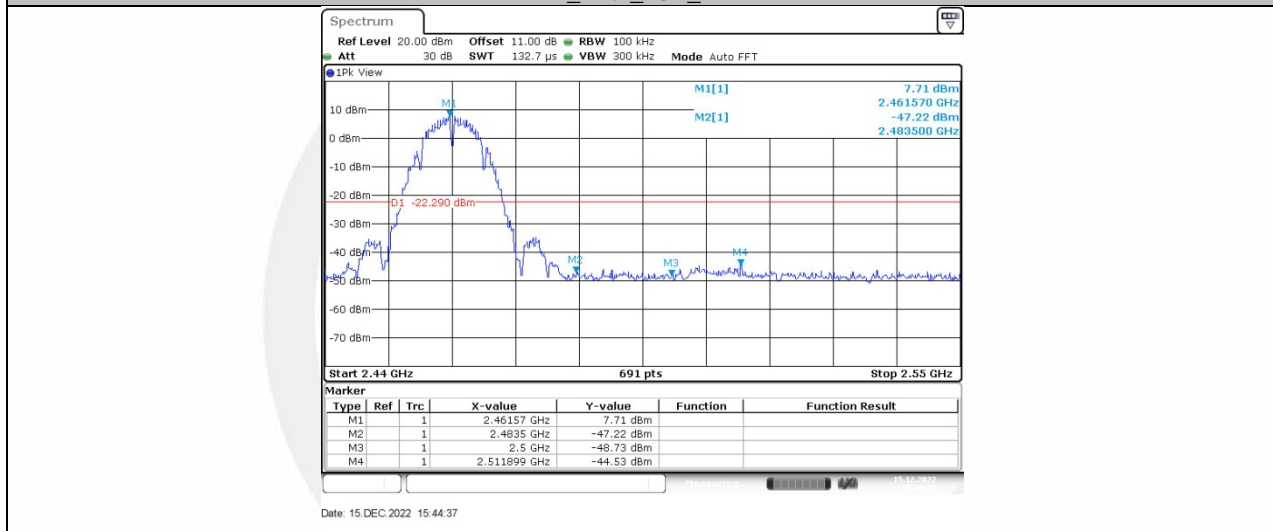

11B_Ant1_High_2462

TestMode	Antenna	Frequency[MHz]	FreqRange [Mhz]	RefLevel [dBm]	Result [dBm]	Limit [dBm]	Verdict
11B	Ant1	2412	Reference	8.74	8.74	---	PASS
			30~1000	8.74	-55.03	≤-21.26	PASS
			1000~26500	8.74	-42.95	≤-21.26	PASS
		2437	Reference	8.06	8.06	---	PASS
			30~1000	8.06	-54.6	≤-21.94	PASS
			1000~26500	8.06	-42.93	≤-21.94	PASS
		2462	Reference	7.37	7.37	---	PASS
			30~1000	7.37	-54.56	≤-22.63	PASS
			1000~26500	7.37	-43.49	≤-22.63	PASS



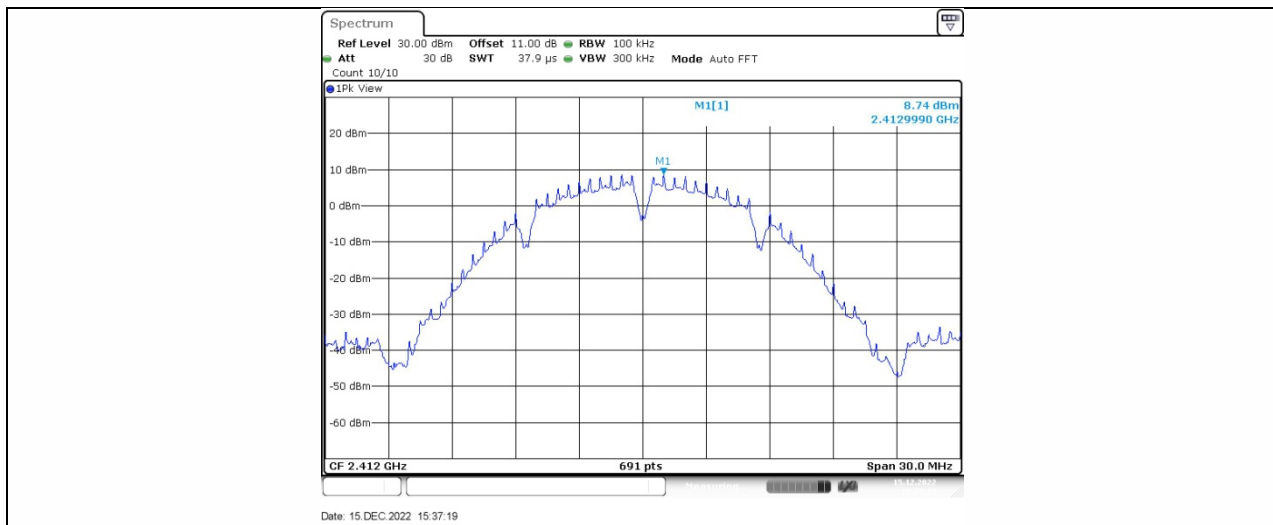

11B_Ant1_2412_0~Reference

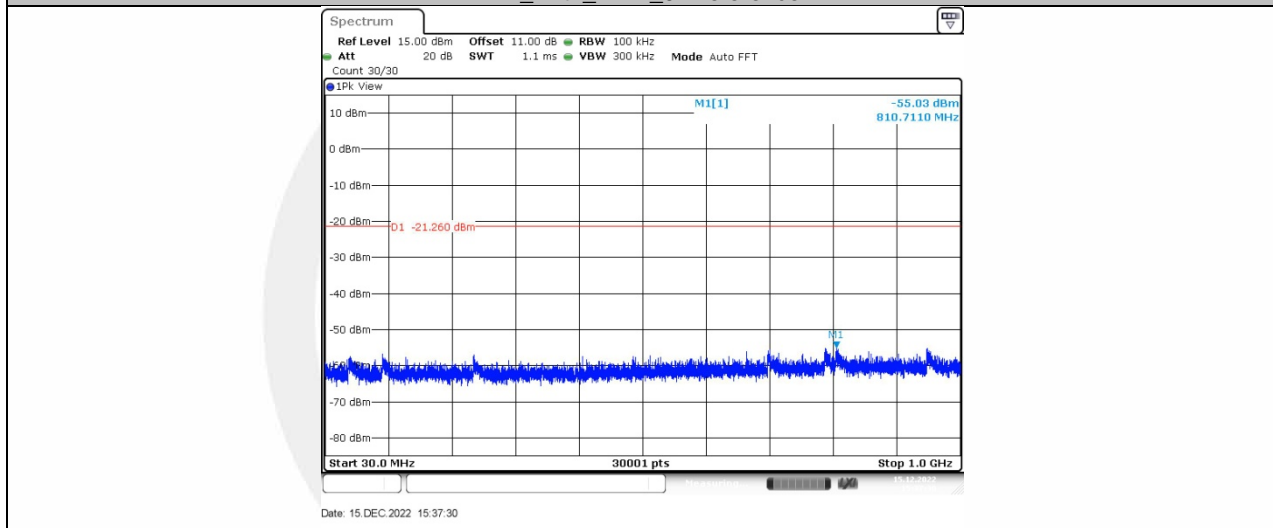

11B_Ant1_2412_30~1000

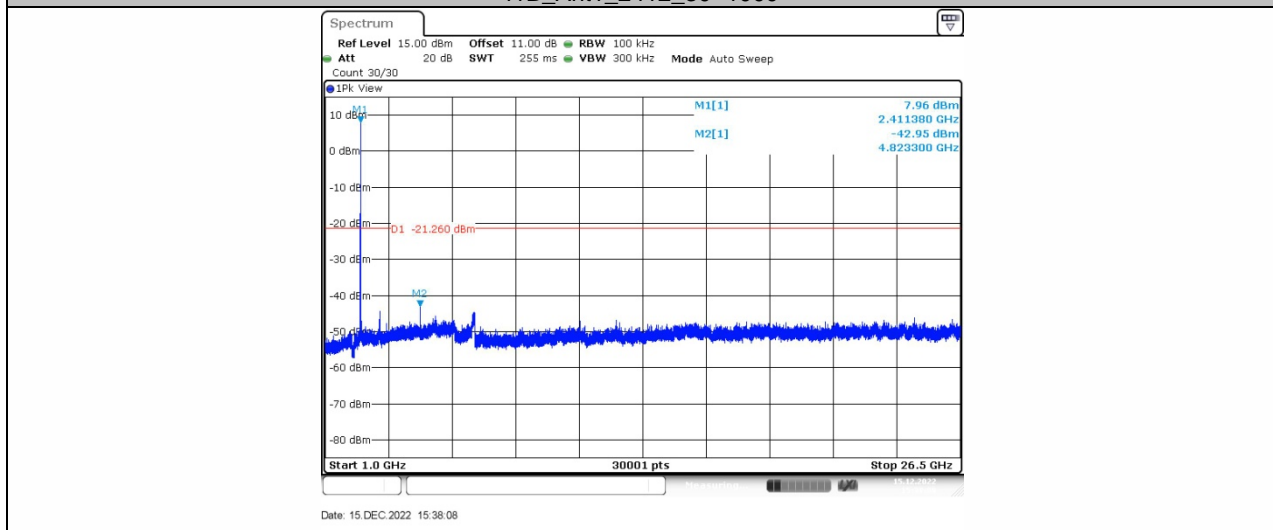

11B_Ant1_2412_1000~26500

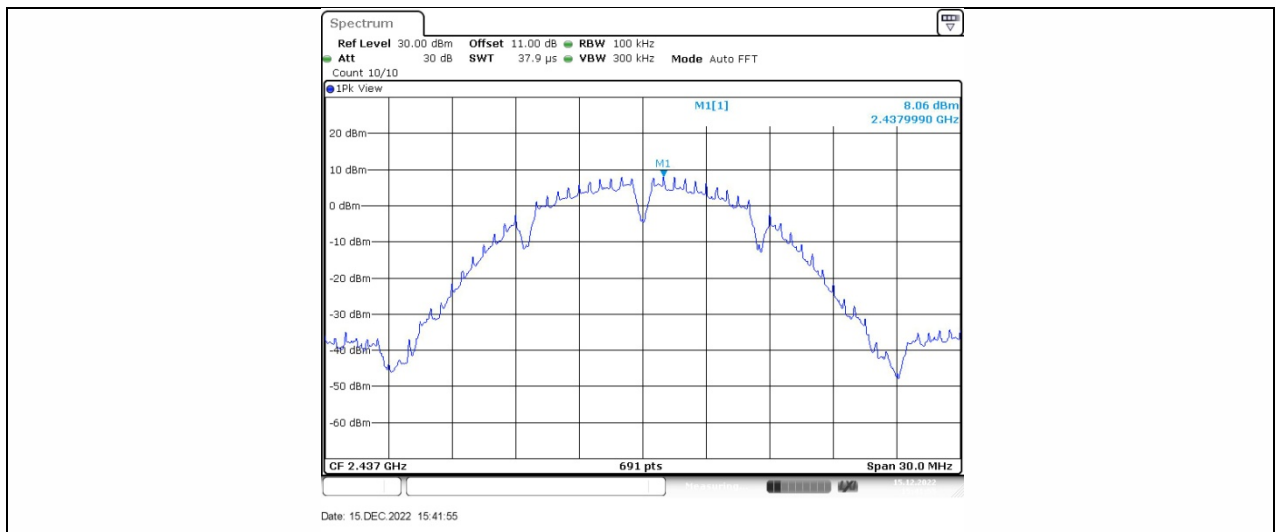

11B_Ant1_2437_0~Reference

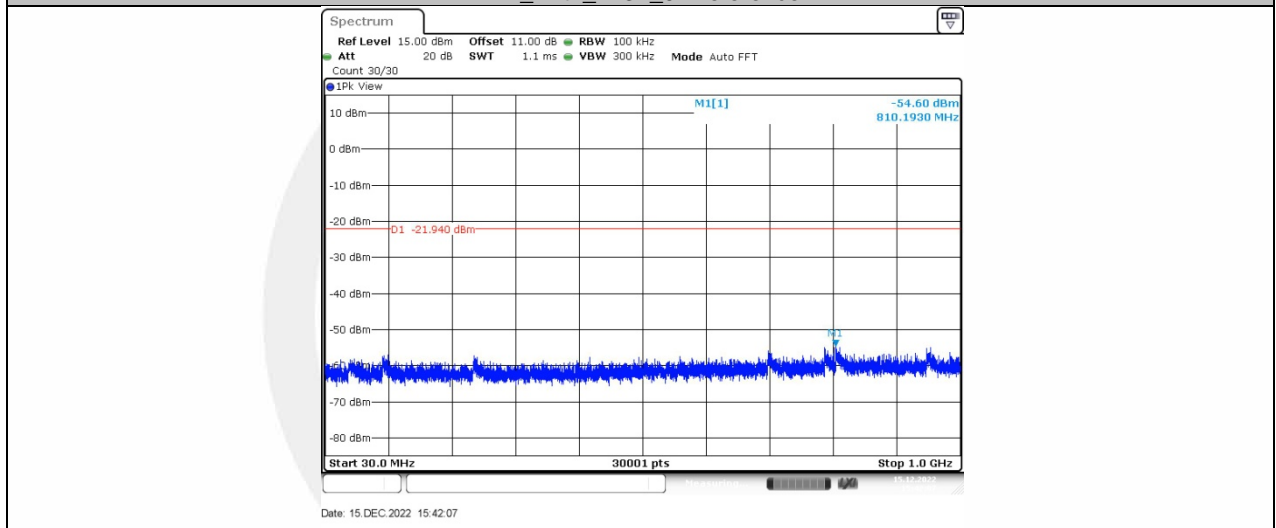

11B_Ant1_2437_30~1000

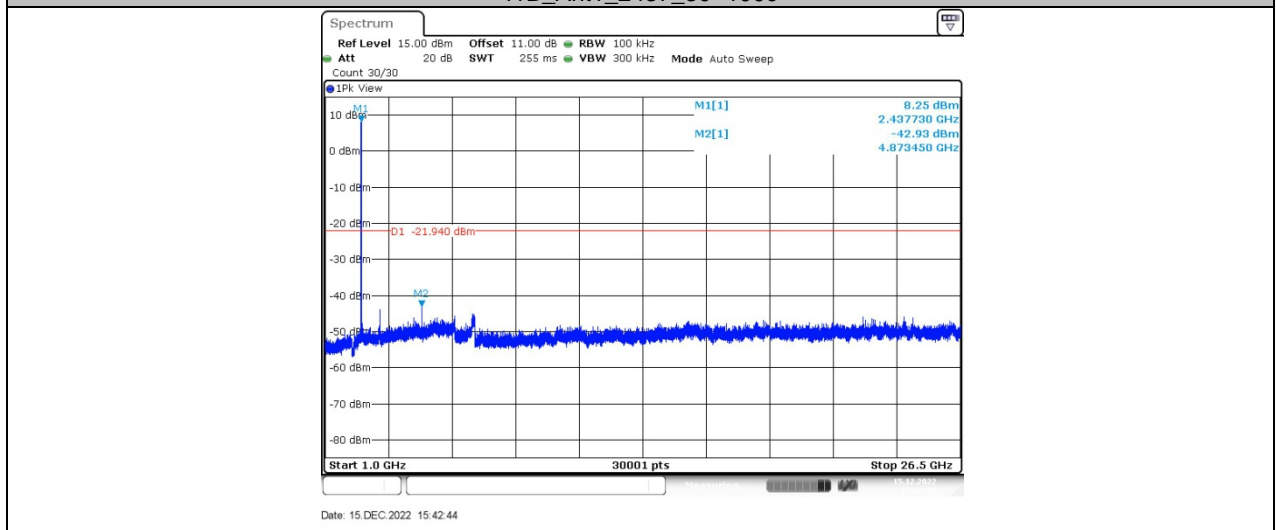

11B_Ant1_2437_1000~26500

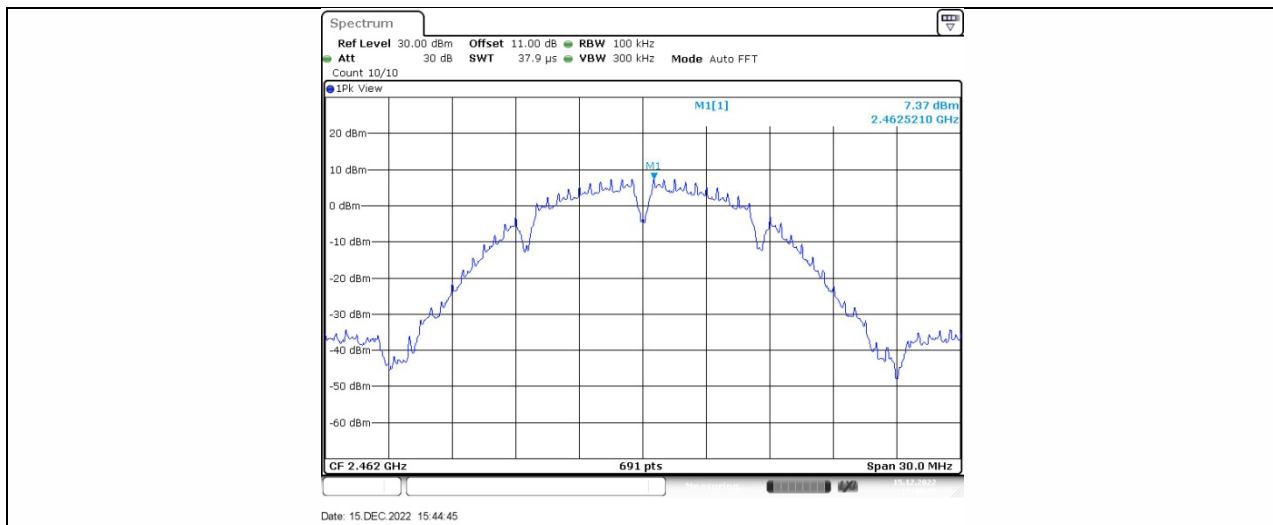

11B_Ant1_2462_0~Reference

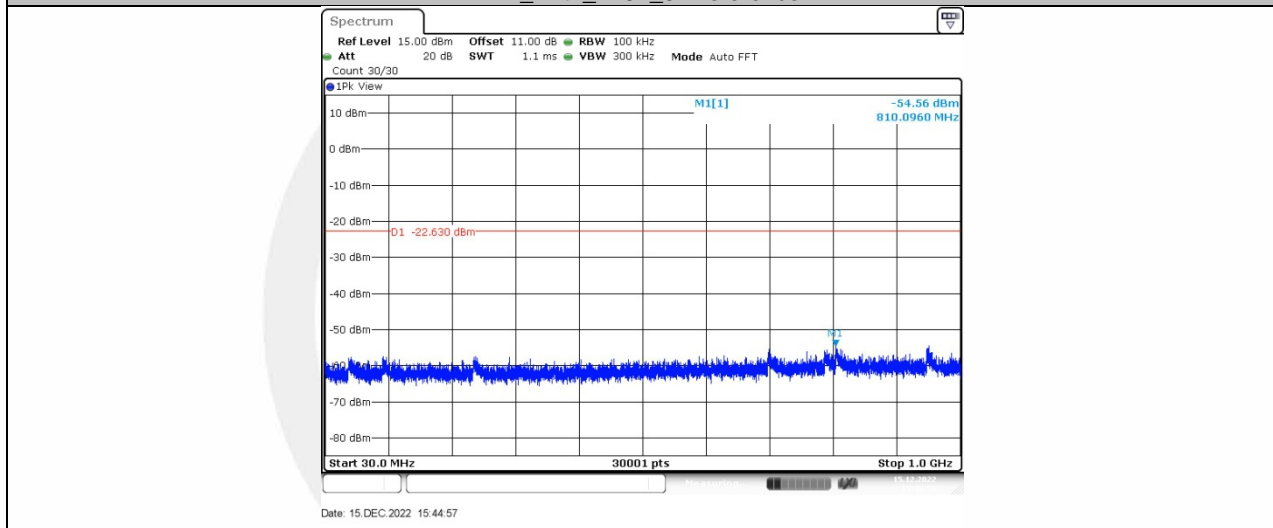

11B_Ant1_2462_30~1000

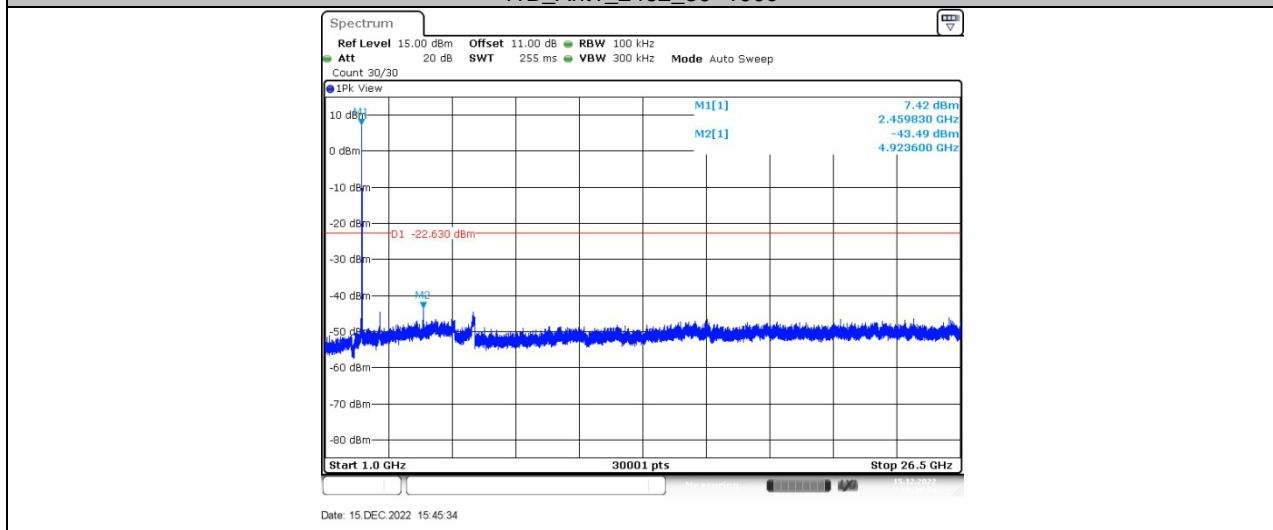

11B_Ant1_2462_1000~26500

8.6 RADIATED SPURIOUS EMISSION

8.6.1 Applicable Standard

According to FCC Part 15.247(d), 15.205, 15.209 and KDB 558074 D01 15.247 Meas Guidancev05r02
According to IC RSS-Gen and RSS-247

8.6.2 Conformance Limit

According to FCC Part 15.247(d): radiated emissions which fall in the restricted bands, as defined in §15.205(a), must also comply with the radiated emission limits specified in §15.209(a) (see §15.205(c)).

According to FCC Part 15.205, Restricted bands

According to IC RSS-Gen 8.10: radiated emissions which fall in the restricted bands, must also comply with the radiated emission limits.

According to IC RSS-Gen, Restricted bands

MHz	MHz	MHz	GHz
0.090-0.110	16.42-16.423	399.9-410	4.5-5.15
10.495-0.505	16.69475-16.69525	608-614	5.35-5.46
2.1735-2.1905	16.80425-16.80475	960-1240	7.25-7.75
4.125-4.128	25.5-25.67	1300-1427	8.025-8.5
4.17725-4.17775	37.5-38.25	1435-1626.5	9.0-9.2
4.20725-4.20775	73-74.6	1645.5-1646.5	9.3-9.5
6.215-6.218	74.8-75.2	1660-1710	10.6-12.7
6.26775-6.26825	123-138	2200-2300	14.47-14.5
8.291-8.294	149.9-150.05	2310-2390	15.35-16.2
8.362-8.366	156.52475-156.52525	2483.5-2500	17.7-21.4
8.37625-8.38675	156.7-156.9	2690-2900	22.01-23.12
8.41425-8.41475	162.0125-167.17	3260-3267	23.6-24.0
12.29-12.293	167.72-173.2	3332-3339	31.2-31.8
12.51975-12.52025	240-285	3345.8-3358	36.43-36.5
12.57675-12.57725	322-335.4	3600-4400	(2)
13.36-13.41			

According to FCC Part 15.205 the level of any transmitter spurious emission in Restricted bands shall not exceed the level of the emission specified in the following table

Restricted Frequency (MHz)	Field Strength ($\mu\text{V}/\text{m}$)	Field Strength ($\text{dB}\mu\text{V}/\text{m}$)	Measurement Distance
0.009-0.490	2400/F(KHz)	$20 \log (\mu\text{V}/\text{m})$	300
0.490-1.705	24000/F(KHz)	$20 \log (\mu\text{V}/\text{m})$	30
1.705-30	30	29.5	30
30-88	100	40	3
88-216	150	43.5	3
216-960	200	46	3
Above 960	500	54	3

8.6.3 Test Configuration

Test according to clause 6.2 radio frequency test setup

8.6.4 Test Procedure

This test is required for any spurious emission that falls in a Restricted Band, as defined in Section 15.205. It must be performed with the highest gain of each type of antenna proposed for use with the EUT. Use the following spectrum analyzer settings:

For Above 1GHz:

The EUT was placed on a turn table which is 1.5m above ground plane.

Maximum procedure was performed on the highest emissions to ensure EUT compliance.

Span = wide enough to fully capture the emission being measured

RBW = 1 MHz

VBW \geq RBW

Sweep = auto

Detector function = peak

Trace = max hold

For Below 1GHz:

The EUT was placed on a turn table which is 0.8m above ground plane.

Maximum procedure was performed on the highest emissions to ensure EUT compliance.

Span = wide enough to fully capture the emission being measured

RBW = 100 kHz for

VBW \geq RBW

Sweep = auto

Detector function = peak

Trace = max hold

For Below 30MHz:

The EUT was placed on a turn table which is 0.8m above ground plane.

Maximum procedure was performed on the highest emissions to ensure EUT compliance.

Span = wide enough to fully capture the emission being measured

RBW = 9kHz

VBW \geq RBW

Sweep = auto

Detector function = peak

Trace = max hold

For Below 150KHz:

The EUT was placed on a turn table which is 0.8m above ground plane.

Maximum procedure was performed on the highest emissions to ensure EUT compliance.

Span = wide enough to fully capture the emission being measured

RBW = 200Hz

VBW \geq RBW

Sweep = auto

Detector function = peak

Trace = max hold

Follow the guidelines in ANSI C63.10 with respect to maximizing the emission by rotating the EUT, measuring the emission while the EUT is situated in three orthogonal planes (if appropriate), adjusting the measurement antenna height and polarization, etc. A pre-amp and a high pass filter are required for this test, in order to provide the measuring system with sufficient sensitivity. Allow the trace to stabilize. The peak reading of the emission, after being corrected by the antenna factor, cable loss, pre-amp gain, etc., is the peak field strength, which must comply with the limit. Submit this data.

Now set the VBW to 10 Hz, while maintaining all of the other instrument settings. This peak level, once corrected, must comply with the limit. If the dwell time per channel of the hopping signal is less than 100 ms, then the reading obtained with the 10 Hz VBW may be further adjusted by a "duty cycle correction factor", derived from $20\log(\text{dwell time}/100 \text{ ms})$, in an effort to demonstrate compliance with the limit. Submit this data.

Repeat above procedures until all frequency measured was complete.

8.6.5 Test Results

Temperature:	26° C
Relative Humidity:	54%
ATM Pressure:	1011 mbar

■ Spurious Emission below 30MHz(9KHz to 30MHz)

Freq. (MHz)	Ant.Pol. H/V	Emission Level(dBuV/m)		Limit 3m(dBuV/m)		Over(dB)	
		PK	AV	PK	AV	PK	AV
--	--	--	--	--	--	--	--

Note: the amplitude of spurious emission that is attenuated by more than 20dB below the permissible limit has no need to be reported.

Distance extrapolation factor = $40\log(\text{Specific distance/ test distance})$ (dB);

Limit line = Specific limits(dBuV) + distance extrapolation factor



■ Spurious Emission Above 1GHz(1GHz to 25GHz)

All the antenna(Antenna 1)and modes(802.11b/g/n)have been tested and the worst(Antenna 1,802.11b) result recorded was report as below:

Test mode: 802.11b Frequency: Channel 1: 2412MHz

Freq. (MHz)	Ant. Pol.	Emission Level(dBuV/m)		Limit 3m(dBuV/m)		Over(dB)	
	H/V	PK	AV	PK	AV	PK	AV
4824.375	V	49.24	39.07	74.00	54.00	-24.76	-14.93
7235.625	V	56.54	44.74	74.00	54.00	-17.46	-9.26
17610	V	69.37	50.33	74.00	54.00	-4.63	-3.67
4824.375	H	54.58	39.30	74.00	54.00	-19.42	-14.70
7237.5	H	55.84	44.80	74.00	54.00	-18.16	-9.20
17587.5	H	69.61	50.04	74.00	54.00	-4.39	-3.96

Test mode: 802.11b Frequency: Channel 6: 2437MHz

Freq. (MHz)	Ant. Pol.	Emission Level(dBuV/m)		Limit 3m(dBuV/m)		Over(dB)	
	H/V	PK	AV	PK	AV	PK	AV
4873.125	V	49.71	38.63	74.00	54.00	-24.29	-15.37
7310.625	V	56.05	48.08	74.00	54.00	-17.95	-5.92
17589.37	V	69.61	51.08	74.00	54.00	-4.39	-2.92
4875	H	44.08	38.68	74.00	54.00	-29.92	-15.32
7310.625	H	50.52	44.67	74.00	54.00	-23.48	-9.33
17649.37	H	69.25	50.02	74.00	54.00	-4.75	-3.98

Test mode: 802.11b Frequency: Channel 11: 2462MHz

Freq. (MHz)	Ant. Pol.	Emission Level(dBuV/m)		Limit 3m(dBuV/m)		Over(dB)	
	H/V	PK	AV	PK	AV	PK	AV
4923.75	V	53.78	38.82	74.00	54.00	-20.22	-15.18
7383.75	V	54.63	44.08	74.00	54.00	-19.37	-9.92
17600.62	V	69.70	50.75	74.00	54.00	-4.30	-3.25
4923.75	H	56.41	38.80	74.00	54.00	-17.59	-15.20
7381.875	H	52.59	44.12	74.00	54.00	-21.41	-9.88
17973.75	H	69.05	48.15	74.00	54.00	-4.95	-5.85

- Note:**
- (1) All Readings are Peak Value (VBW=3MHz) and Average Value (VBW=10Hz).
 - (2) Emission Level= Reading Level+Correct Factor.
 - (3) Correct Factor= Ant_F + Cab_L - Preamp
 - (4) The reading of emissions are attenuated more than 20dB below the permissible limits or the field strength is too small to be measured.

■ Spurious Emission in Restricted Band 2310-2390MHz and 2483.5-2500MHz

All the antenna(Antenna 1) and modes(802.11b/g/n) have been tested and the worst(Antenna 1,802.11b) result recorded was reported as below:

Test mode: 802.11b Frequency: Channel 1: 2412MHz

Frequency (MHz)	Polarity	PK(dBuV/m) (VBW=3MHz)	Limit 3m (dBuV/m)	AV(dBuV/m) (VBW=10Hz)	Limit 3m (dBuV/m)
2387.27	H	62.30	74.00	49.49	54.00
2389.72	V	57.41	74.00	49.43	54.00

Test mode: 802.11b Frequency: Channel 11: 2462MHz

Frequency (MHz)	Polarity	PK(dBuV/m) (VBW=3MHz)	Limit 3m (dBuV/m)	AV(dBuV/m) (VBW=10Hz)	Limit 3m (dBuV/m)
2483.56	H	66.44	74.00	48.85	54.00
2483.64	V	60.60	74.00	46.10	54.00

- Note:**
- (1) All Readings are Peak Value (VBW=3MHz) and Average Value (VBW=10Hz).
 - (2) Emission Level= Reading Level+Correct Factor.
 - (3) Correct Factor= Ant_F + Cab_L - Preamp
 - (4) The reading of emissions are attenuated more than 20dB below the permissible limits or the field strength is too small to be measured.

Test Model	802.11b	Spurious Emission in Restricted Band 2310-2390MHz		Polarity: H
		Channel 1: 2412MHz	VBW=3MHz	

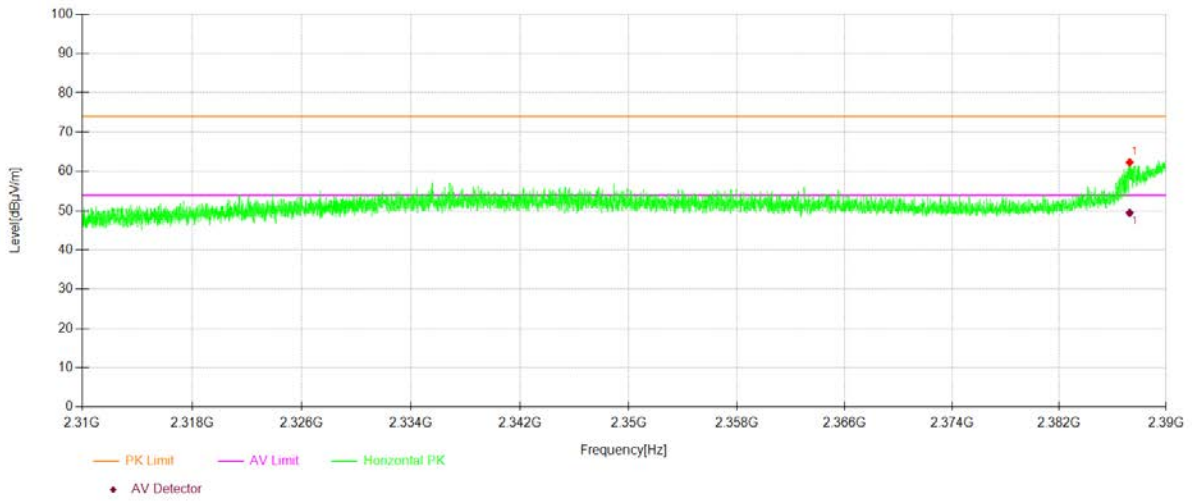

Test Model	802.11b	Spurious Emission in Restricted Band 2310-2390MHz		Polarity: V
		Channel 1: 2412MHz	VBW=3MHz	

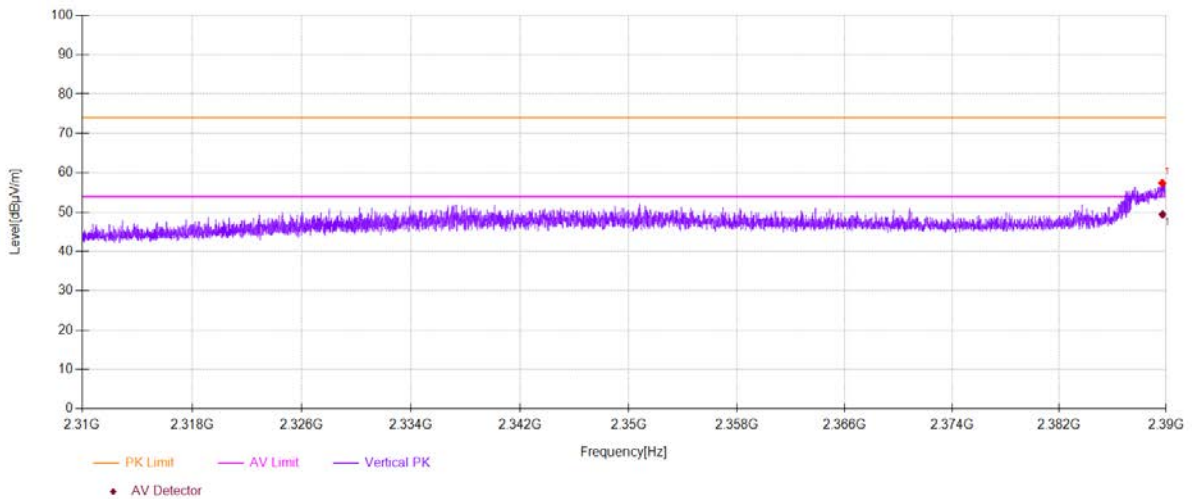

Test Model 802.11b Spurious Emission in Restricted Band 2483.5-2500MHz
 Channel 11: 2462MHz VBW=3MHz Polarity: H

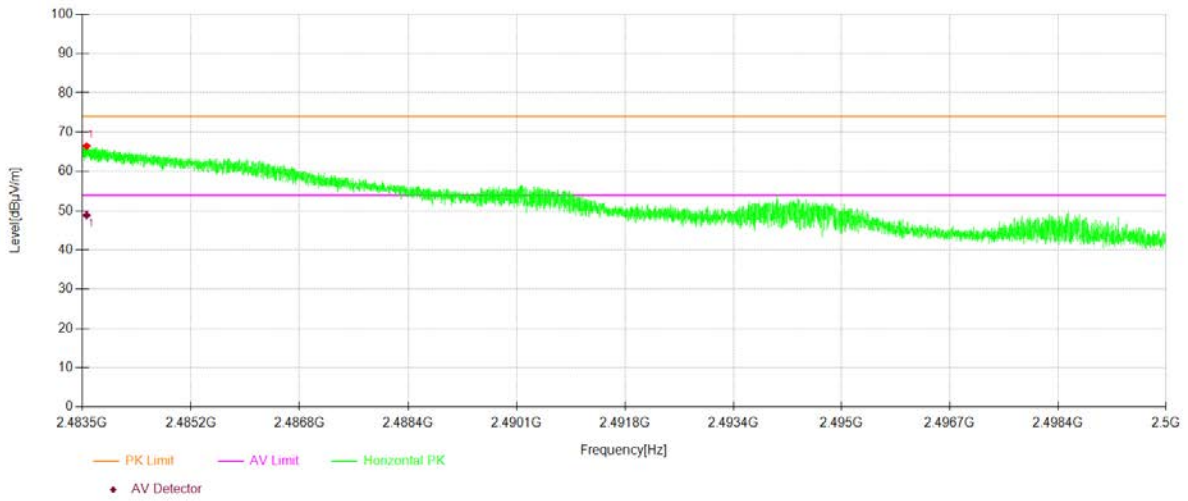

Test Model 802.11b Spurious Emission in Restricted Band 2483.5-2500MHz
 Channel 11: 2462MHz VBW=3MHz Polarity: V

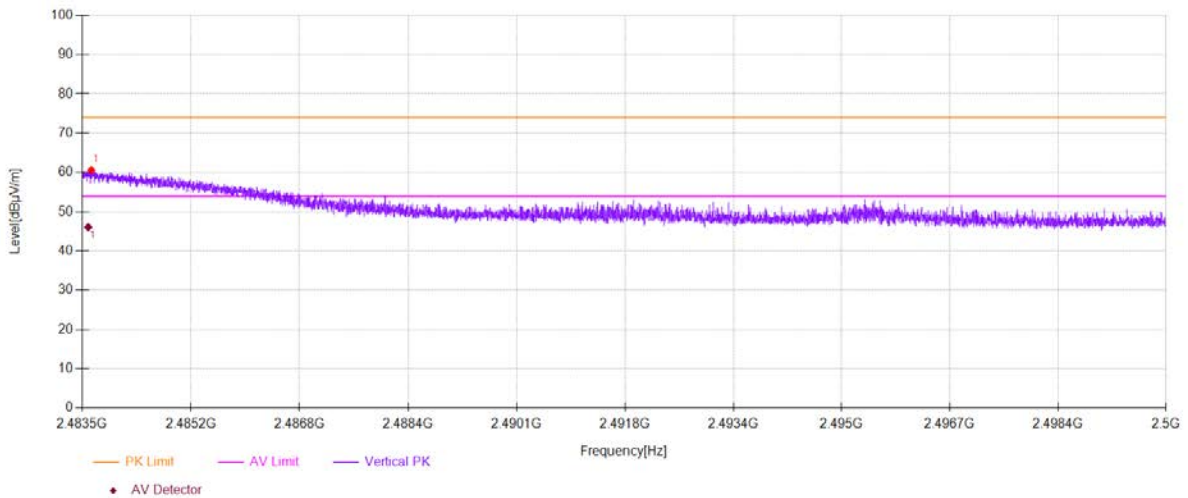

■ Spurious Emission below 1GHz (30MHz to 1GHz)

All the antenna(Antenna 1) and modes(802.11b/g/n) have been tested and the worst(Antenna 1,802.11b) result recorded was report as below:

Mode:	2412
-------	------

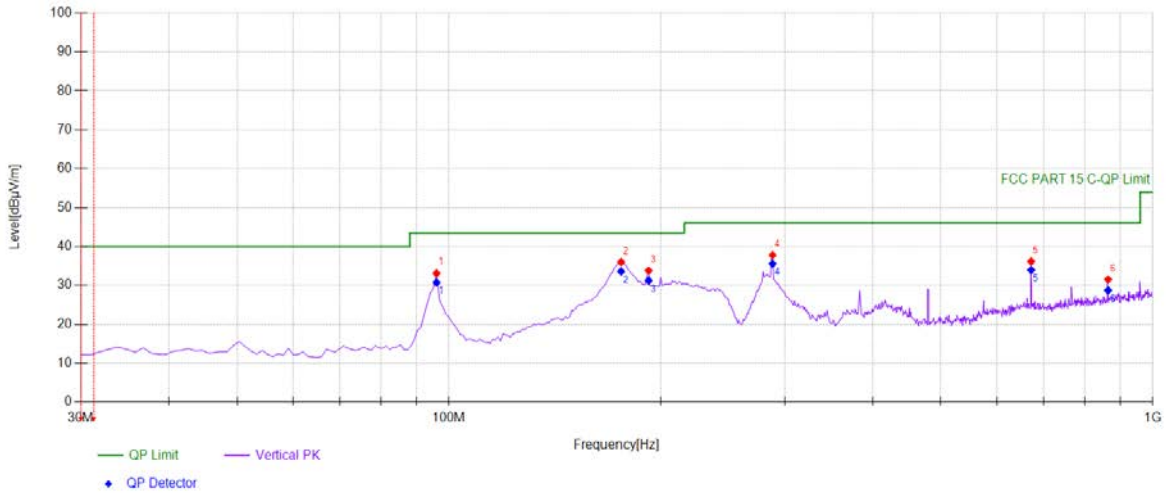

Suspected Data List										
NO	Freq. [MHz]	Reading [dBµV]	Factor [dB/m]	Level [dBµV/m]	Detector	Limit [dBµV/m]	Margin [dB]	Polarity	Angle[°]	Height [cm]
1	96.026	50.83	-17.73	33.10	PK	43.50	10.40	Vertical	112	100
2	175.6456	54.62	-18.64	35.98	PK	43.50	7.52	Vertical	265	100
3	192.1522	51.40	-17.61	33.79	PK	43.50	9.71	Vertical	252	100
4	288.2783	51.91	-14.16	37.75	PK	46.00	8.25	Vertical	122	100
5	671.8118	42.26	-6.14	36.12	PK	46.00	9.88	Vertical	200	100
6	864.0641	35.18	-3.67	31.51	PK	46.00	14.49	Vertical	247	100

Mode:	2412
-------	------

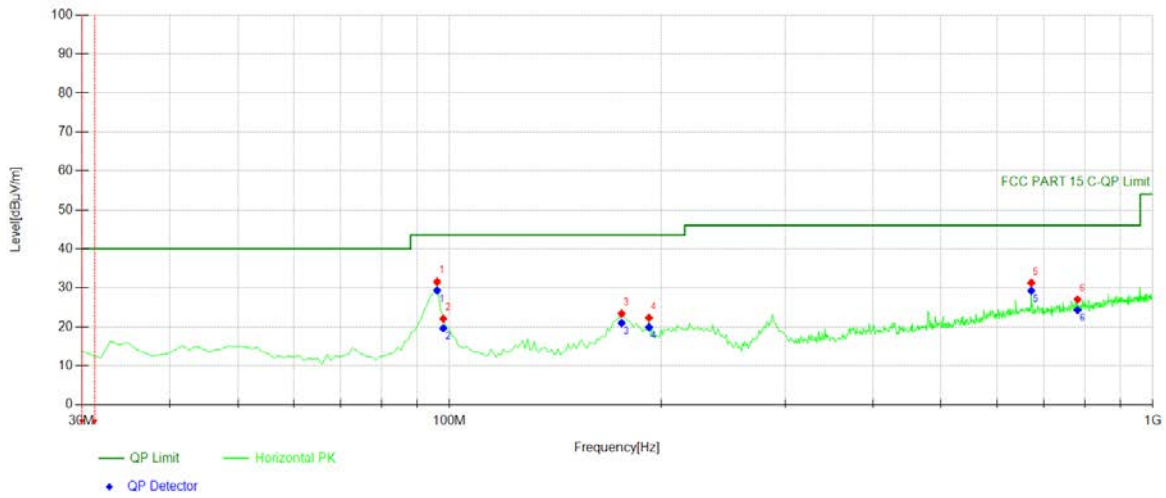

Suspected Data List										
NO.	Freq. [MHz]	Reading [dBµV]	Factor [dB/m]	Level [dBµV/m]	Detector	Limit [dBµV/m]	Margin [dB]	Polarity	Angle[°]	Height[m]
1	96.026	49.30	-17.73	31.57	PK	43.50	11.93	Horizontal	59	100
2	97.968	39.35	-17.28	22.07	PK	43.50	21.43	Horizontal	28	100
3	175.6456	42.03	-18.64	23.39	PK	43.50	20.11	Horizontal	128	100
4	192.1522	39.94	-17.61	22.33	PK	43.50	21.17	Horizontal	160	100
5	671.8118	37.46	-6.14	31.32	PK	46.00	14.68	Horizontal	329	100
6	781.5315	31.61	-4.60	27.01	PK	46.00	18.99	Horizontal	320	100

Mode:	2437
-------	------

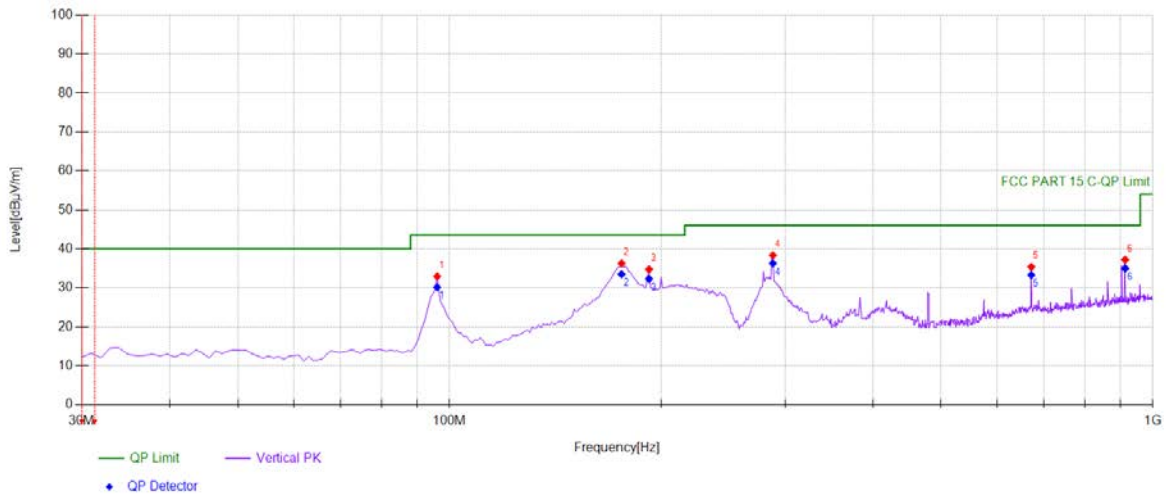

Suspected Data List										
NO.	Freq. [MHz]	Reading [dBµV]	Factor [dB/m]	Level [dBµV/m]	Detector	Limit [dBµV/m]	Margin [dB]	Polarity	Angle[°]	Height[m]
1	96.026	50.69	-17.73	32.96	PK	43.50	10.54	Vertical	116	100
2	175.6456	54.94	-18.64	36.30	PK	43.50	7.20	Vertical	82	100
3	192.1522	52.34	-17.61	34.73	PK	43.50	8.77	Vertical	239	100
4	288.2783	52.55	-14.16	38.39	PK	46.00	7.61	Vertical	140	100
5	671.8118	41.52	-6.14	35.38	PK	46.00	10.62	Vertical	212	100
6	913.5836	40.09	-2.85	37.24	PK	46.00	8.76	Vertical	149	100

Mode:	2437
-------	------

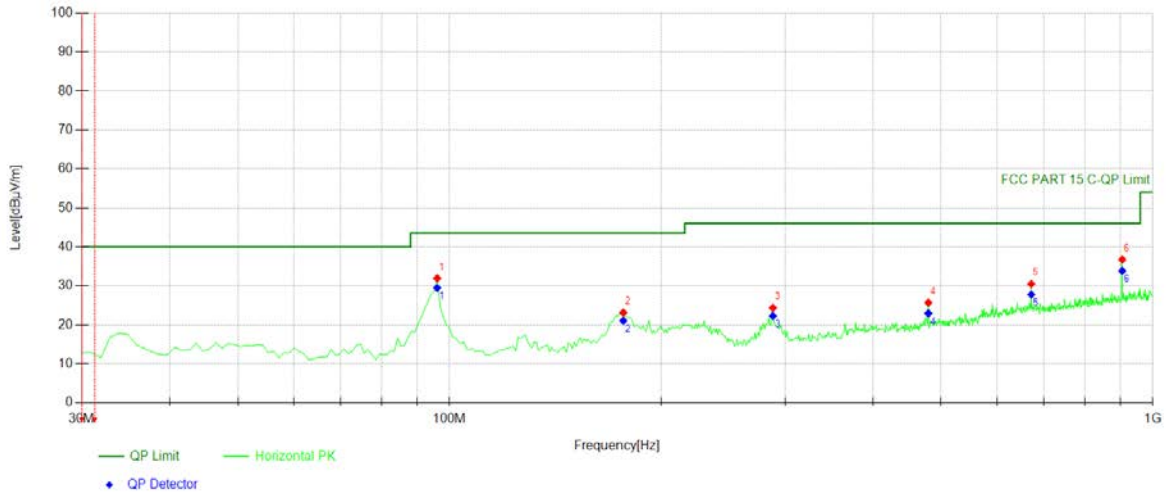

Suspected Data List										
NO	Freq. [MHz]	Reading [dBµV]	Factor [dB/m]	Level [dBµV/m]	Detector	Limit [dBµV/m]	Margin [dB]	Polarity	Angle[°]	Height [cm]
1	96.026	49.68	-17.73	31.95	PK	43.50	11.55	Horizontal	55	100
2	176.6166	41.75	-18.59	23.16	PK	43.50	20.34	Horizontal	156	100
3	288.2783	38.54	-14.16	24.38	PK	46.00	21.62	Horizontal	224	100
4	479.5596	35.51	-9.81	25.70	PK	46.00	20.30	Horizontal	101	100
5	671.8118	36.65	-6.14	30.51	PK	46.00	15.49	Horizontal	325	100
6	904.8448	39.59	-2.82	36.77	PK	46.00	9.23	Horizontal	60	100

Mode:	2462
-------	------

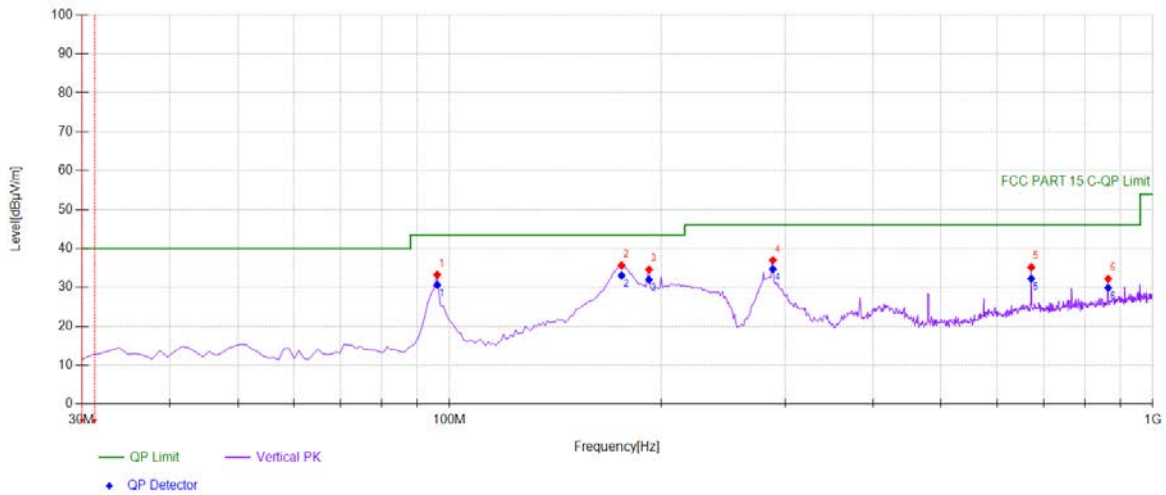

Suspected Data List										
NO.	Freq. [MHz]	Reading [dBµV]	Factor [dB/m]	Level [dBµV/m]	Detector	Limit [dBµV/m]	Margin [dB]	Polarity	Angle[°]	Height[m]
1	96.026	50.95	-17.73	33.22	PK	43.50	10.28	Vertical	118	100
2	175.6456	54.29	-18.64	35.65	PK	43.50	7.85	Vertical	67	100
3	192.1522	52.20	-17.61	34.59	PK	43.50	8.91	Vertical	246	100
4	288.2783	51.17	-14.16	37.01	PK	46.00	8.99	Vertical	132	100
5	671.8118	41.34	-6.14	35.20	PK	46.00	10.80	Vertical	204	100
6	864.0641	35.86	-3.67	32.19	PK	46.00	13.81	Vertical	301	100

Mode:	2462
-------	------

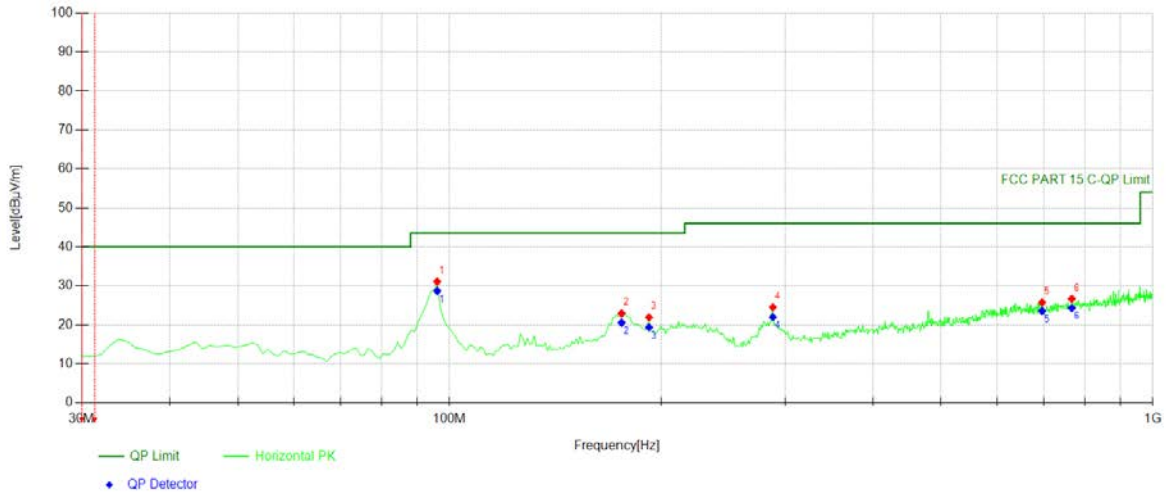

Suspected Data List										
NO.	Freq. [MHz]	Reading [dBµV]	Factor [dB/m]	Level [dBµV/m]	Detector	Limit [dBµV/m]	Margin [dB]	Polarity	Angle[°]	Height[m]
1	96.026	48.83	-17.73	31.10	PK	43.50	12.40	Horizontal	79	100
2	175.6456	41.58	-18.64	22.94	PK	43.50	20.56	Horizontal	145	100
3	192.1522	39.55	-17.61	21.94	PK	43.50	21.56	Horizontal	163	100
4	288.2783	38.71	-14.16	24.55	PK	46.00	21.45	Horizontal	218	100
5	696.0861	31.73	-5.98	25.75	PK	46.00	20.25	Horizontal	209	100
6	766.967	31.78	-5.10	26.68	PK	46.00	19.32	Horizontal	329	100

8.7 CONDUCTED EMISSION TEST

8.7.1 Applicable Standard

According to FCC Part 15.207(a)

According to IC RSS-Gen 8.8

8.7.2 Conformance Limit

Frequency(MHz)	Conducted Emission Limit	
	Quasi-peak	Average
0.15-0.5	66-56	56-46
0.5-5.0	56	46
5.0-30.0	60	50

Note: 1. The lower limit shall apply at the transition frequencies

2. The limit decreases in line with the logarithm of the frequency in the range of 0.15 to 0.50MHz.

8.7.3 Test Configuration

Test according to clause 6.3conducted emission test setup

8.7.4 Test Procedure

The EUT was placed on a table which is 0.8m above ground plane.

Maximum procedure was performed on the highest emissions to ensure EUT compliance.

Repeat above procedures until all frequency measured were complete.

8.7.5 Test Results

N/A

8.8 ANTENNA APPLICATION

8.8.1 Antenna Requirement

Standard	Requirement
FCC CRF Part15.203	An intentional radiator shall be designed to ensure that no antenna other than that furnished by the responsible party shall be used with the device. The use of a permanently attached antenna or of an antenna that uses a unique coupling to the intentional radiator shall be considered sufficient to comply with the provisions of this section. The manufacturer may design the unit so that a broken antenna can be replaced by the user, but the use of a standard antenna jack or electrical connector is prohibited.
FCC 47 CFR Part 15.247 (b)	If transmitting antennas of directional gain greater than 6dBi are used, the power shall be reduced by the amount in dB that the directional gain of the antenna exceeds 6dBi.
RSS-Gen Section 6.8	The applicant for equipment certification shall provide a list of all antenna types that may be used with the transmitter, where applicable (i.e. for transmitters with detachable antenna), indicating the maximum permissible antenna gain (in dBi) and the required impedance for each antenna. The test report shall demonstrate the compliance of the transmitter with the limit for maximum equivalent isotropically radiated power (e.i.r.p.) specified in the applicable RSS, when the transmitter is equipped with any antenna type, selected from this list.
RSS-247 Section 5.4	If the transmitter employs an antenna system that emits multiple directional beams, but does not emit multiple directional beams simultaneously, the total output power conducted to the array or arrays that comprise the device (i.e. the sum of the power supplied to all antennas, antenna elements, staves, etc., and summed across all carriers or frequency channels) shall not exceed the applicable output power limit. However, the total conducted output power shall be reduced by 1 dB below the specified limits for each 3 dB that the directional gain of the antenna/antenna array exceeds 6 dBi. The directional antenna gain shall be computed as the sum of 10 log (number of array elements or staves) plus the directional gain of the element or stave having the highest gain.

8.8.2 Result

PASS.

- Note:
- Antenna use a permanently attached antenna which is not replaceable.
 - Not using a standard antenna jack or electrical connector for antenna replacement
 - The antenna has to be professionally installed (please provide method of installation)

Please refer to the attached documentInternal Photos to show the antenna connector.

*** End of Report ***