



CTC Laboratories, Inc.

1-2/F., Building 2, Jiaquan Building, Guanlan High-Tech Park, Shenzhen, Guangdong, China
Tel: +86-755- 27521059 Fax: +86-755- 27521011 Http://www.sz-ctc.org.cn

TEST REPORT

Report No.: **CTC20200912E07**

FCC ID.....: **2AITMSV-1082X**

Applicant.....: **Shenzhen Smart Device Technology Co., LTD**
 Address.....: 17th-18th floor, Guoshi Mansion, Shahe West Road 1801,
 Nanshan, Shenzhen, China

Manufacturer.....: Shenzhen Smart Device Technology Co., LTD
 Address.....: 17th-18th floor, Guoshi Mansion, Shahe West Road 1801,
 Nanshan, Shenzhen, China

Product Name.....: **Smart Pass Management Module**

Trade Mark.....: N/A

Model/Type reference.....: SV-1082X

Listed Model(s): N/A

Standard.....: **FCC CFR Title 47 Part 15 Subpart C Section 15.247**

Date of receipt of test sample...: Jun. 05, 2020

Date of testing.....: Jun. 06, 2020 to Jun. 30, 2020

Date of issue.....: Jun. 30, 2020

Result.....: **PASS**

Compiled by:		
(Printed name+signature)	Terry Su	
Supervised by:		
(Printed name+signature)	Miller Ma	
Approved by:		
(Printed name+signature)	Walter Chen	

Testing Laboratory Name.....: **CTC Laboratories, Inc.**

Address.....: 1-2/F., Building 2, Jiaquan Building, Guanlan High-Tech Park,
 Shenzhen, Guangdong, China

This test report may be duplicated completely for legal use with the approval of the applicant. It should not be reproduced except in full, without the written approval of our laboratory. The client should not use it to claim product endorsement by CTC. The test results in the report only apply to the tested sample. The test report shall be invalid without all the signatures of testing engineers, reviewer and approver. Any objections must be raised to CTC within 15 days since the date when the report is received. It will not be taken into consideration beyond this limit. The test report merely correspond to the test sample.



Table of Contents

Page

1. TEST SUMMARY	3
1.1. TEST STANDARDS.....	3
1.2. REPORT VERSION.....	3
1.3. TEST DESCRIPTION.....	4
1.4. TEST FACILITY	5
1.5. MEASUREMENT UNCERTAINTY	5
1.6. ENVIRONMENTAL CONDITIONS	6
2. GENERAL INFORMATION	7
2.1. CLIENT INFORMATION	7
2.2. GENERAL DESCRIPTION OF EUT	7
2.3. ACCESSORY EQUIPMENT INFORMATION	8
2.4. OPERATION STATE.....	8
2.5. MEASUREMENT INSTRUMENTS LIST	10
3. TEST ITEM AND RESULTS	12
3.1. CONDUCTED EMISSION.....	12
3.2. RADIATED EMISSION	19
3.3. BAND EDGE EMISSIONS	45
3.4. DTS BANDWIDTH.....	61
3.5. PEAK OUTPUT POWER	66
3.6. POWER SPECTRAL DENSITY	68
3.7. DUTY CYCLE	73
3.8. ANTENNA REQUIREMENT	78



1. TEST SUMMARY

1.1. Test Standards

The tests were performed according to following standards:

[FCC Rules Part 15.247](#): Operation within the bands of 902-928MHz, 2400-2483.5MHz, and 5725-5850MHz.

[RSS 247 Issue 2](#): Standard Specifications for Frequency Hopping Systems (FHSs) and Digital Transmission Systems (DTSs) Operating in the Bands 902-928MHz, 2400-2483.5MHz and 5725-5850MHz.

[ANSI C63.10-2013](#): American National Standard for Testing Unlicensed Wireless Devices.

1.2. Report version

Revised No.	Date of issue	Description
01	Jun. 30, 2020	Original



1.3. Test Description

FCC Part 15 Subpart C (15.247) / RSS 247 Issue 2				
Test Item	Standard Section		Result	Test Engineer
	FCC	IC		
Antenna Requirement	15.203	/	Pass	Lucy Lan
Conducted Emission	15.207	RSS-Gen 8.8	Pass	Terry Su
Band Edge Emissions	15.247(d)	RSS 247 5.5	Pass	Lucy Lan
6dB Bandwidth	15.247(a)(2)	RSS 247 5.2 (a)	Pass	Lucy Lan
Conducted Max Output Power	15.247(b)(3)	RSS 247 5.4 (d)	Pass	Lucy Lan
Power Spectral Density	15.247(e)	RSS 247 5.2 (b)	Pass	Lucy Lan
Transmitter Radiated Spurious	15.209&15.247(d)	RSS 247 5.5& RSS-Gen 8.9	Pass	Lucy Lan

Note: The measurement uncertainty is not included in the test result.



1.4. Test Facility

CTC Laboratories, Inc.

Add: 1-2/F., Building 2, Jiaquan Building, Guanlan High-Tech Park, Shenzhen, Guangdong, China

Laboratory accreditation

The test facility is recognized, certified, or accredited by the following organizations:

CNAS-Lab Code: L5365

CTC Laboratories, Inc. has been assessed and proved to be in compliance with CNAS-CL01 Accreditation. Criteria for Testing and Calibration Laboratories (identical to ISO/IEC 17025:2017 General Requirements) for the Competence of Testing and Calibration Laboratories.

A2LA-Lab Cert. No.: 4340.01

CTC Laboratories, Inc. EMC Laboratory has been accredited by A2LA for technical competence in the field of electrical testing, and proved to be in compliance with ISO/IEC 17025:2017 General Requirements for the Competence of Testing and Calibration Laboratories and any additional program requirements in the identified field of testing.

Industry Canada (Registration No.: 9783A, CAB Identifier: CN0029)

CTC Laboratories, Inc. EMC Laboratory has been registered by Certification and Engineer Bureau of Industry Canada for the performance of with Registration NO.: 9783A on Jan, 2016.

FCC (Registration No.: 951311, Designation Number CN1208)

CTC Laboratories, Inc. EMC Laboratory has been registered and fully described in a report filed with the (FCC)Federal Communications Commission. The acceptance letter from the FCC is maintained in our files. Registration 951311, Aug 26, 2017.

1.5. Measurement Uncertainty

The data and results referenced in this document are true and accurate. The reader is cautioned that there may be errors within the calibration limits of the equipment and facilities. The measurement uncertainty was calculated for all measurements listed in this test report acc. to TR-100028-01 "Electromagnetic compatibility and Radio spectrum Matters (ERM); Uncertainties in the measurement of mobile radio equipment characteristics; Part 1" and TR-100028-02 "Electromagnetic compatibility and Radio spectrum Matters (ERM); Uncertainties in the measurement of mobile radio equipment characteristics; Part 2" and is documented in the CTC Laboratories, Inc. quality system acc. to DIN EN ISO/IEC 17025. Furthermore, component and process variability of devices similar to that tested may result in additional deviation. The manufacturer has the sole responsibility of continued compliance of the device.

Below is the best measurement capability for CTC Laboratories, Inc.



Test Items	Measurement Uncertainty	Notes
Transmitter power conducted	0.42 dB	(1)
Transmitter power Radiated	2.14 dB	(1)
Conducted spurious emissions 9kHz~40GHz	1.60 dB	(1)
Radiated spurious emissions 9kHz~40GHz	2.20 dB	(1)
Conducted Emissions 9kHz~30MHz	3.20 dB	(1)
Radiated Emissions 30~1000MHz	4.70 dB	(1)
Radiated Emissions 1~18GHz	5.00 dB	(1)
Radiated Emissions 18~40GHz	5.54 dB	(1)
Occupied Bandwidth	-----	(1)

Note (1): This uncertainty represents an expanded uncertainty expressed at approximately the 95% confidence level using a coverage factor of $k=1.96$.

1.6. Environmental conditions

During the measurement the environmental conditions were within the listed ranges:

Temperature:	21°C ~ 27°C
Relative Humidity:	40% ~ 60%
Air Pressure:	101kPa



2. GENERAL INFORMATION

2.1. Client Information

Applicant:	Shenzhen Smart Device Technology Co., LTD
Address:	17th-18th floor, Guoshi Mansion, Shahe West Road 1801, Nanshan, Shenzhen, China
Manufacturer:	Shenzhen Smart Device Technology Co., LTD
Address:	17th-18th floor, Guoshi Mansion, Shahe West Road 1801, Nanshan, Shenzhen, China

2.2. General Description of EUT

Product Name:	Smart Pass Management Module
Trade Mark:	N/A
Model/Type reference:	SV-1082X
Listed Model(s):	N/A
Power supply:	12Vdc/2.5A from AC/DC Adapter
Adapter Model 1:	ADP-3600K120 Input: AC100-240V 50/60Hz 1A Max Output: 12Vdc/3A
Adapter Model 2:	GQ36-120300-AU Input: AC100-240V 50/60Hz 1A Max Output: 12Vdc/3A
Adapter Model 3:	SOY-1200300US Input: AC100-240V 50/60Hz 1.2A Max Output: 12Vdc/3A
Hardware version:	N/A
Software version:	N/A
Test sample No.:	CTC200527-013-1-S0001
WIFI 802.11b/ g/ n(HT20)	
Modulation:	802.11b: DSSS(CCK, DQPSK, DBPSK) 802.11g/n: OFDM(BPSK, QPSK, 16QAM, 64QAM)
Operation frequency:	802.11b/g/n(HT20): 2412MHz~2462MHz
Channel number:	802.11b/g/n(HT20):11channels
Channel separation:	5MHz
Antenna type:	FPC Antenna
Antenna gain:	-1dBi



2.3. Accessory Equipment information

Equipment Information			
Name	Model	S/N	Manufacturer
/	/	/	/
Cable Information			
Name	Shielded Type	Ferrite Core	Length
/	/	/	/
Test Software Information			
Name	Software version	/	/
Ampak RF Test Tool	VER:5.6	/	/

2.4. Operation state

Operation Frequency List: The EUT has been tested under typical operating condition. The Applicant provides communication tools software to control the EUT for staying in continuous transmitting and receiving mode for testing.

Operation Frequency List:

Channel	Frequency (MHz)
01	2412
02	2417
03	2422
04	2427
05	2432
06	2437
07	2442
08	2447
09	2452
10	2457
11	2462

Note: CH 01~CH 11 for 802.11b/g/n(HT20).



Data Rated

Preliminary tests were performed in different data rate, and found which the below bit rate is worst case mode, so only show data which it is a worst case mode.

Mode	Data rate (worst mode)
802.11b	1Mbps
802.11g	6Mbps
802.11n(HT20)	MCS0

Test mode

For RF test items:
The engineering test program was provided and enabled to make EUT continuous transmit.
For AC power line conducted emissions:
The EUT was set to connect with the WLAN AP under large package sizes transmission.
For Radiated spurious emissions test item:
The engineering test program was provided and enabled to make EUT continuous transmit. The EUT in each of three orthogonal axis emissions had been tested, but only the worst case (X axis) data Recorded in the report.



2.5. Measurement Instruments List

Tonscend JS0806-2 Test system					
Item	Test Equipment	Manufacturer	Model No.	Serial No.	Calibrated until
1	Spectrum Analyzer	Rohde & Schwarz	FSU26	100105	Dec. 27, 2020
2	Spectrum Analyzer	Rohde & Schwarz	FUV40-N	101331	Mar. 15, 2021
3	MXG Vector Signal Generator	Agilent	N5182A	MY47420864	Dec. 27, 2020
4	Signal Generator	Agilent	E8257D	MY46521908	Dec. 27, 2020
5	Power Sensor	Agilent	U2021XA	MY5365004	Dec. 27, 2020
6	Power Sensor	Agilent	U2021XA	MY5365006	Dec. 27, 2020
7	Simultaneous Sampling DAQ	Agilent	U2531A	TW54493510	Dec. 27, 2020
8	Climate Chamber	TABAI	PR-4G	A8708055	Dec. 27, 2020
9	Wideband Radio Communication Tester	Rohde & Schwarz	CMW500	116410	Dec. 27, 2020
10	Climate Chamber	ESPEC	MT3065	/	Dec. 27, 2020
11	300328 v2.2.2 test system	TONSCEND	v2.6	/	/

Radiated Emission and Transmitter spurious emissions					
Item	Test Equipment	Manufacturer	Model No.	Serial No.	Calibrated until
1	EMI Test Receiver	Rohde & Schwarz	ESCI	100658	Dec. 27, 2020
2	High pass filter	micro-tranics	HPM50111	142	Dec. 27, 2020
3	Log-Bicon Antenna	Schwarzbeck	CBL6141A	4180	Dec. 27, 2020
4	Ultra-Broadband Antenna	ShwarzBeck	BBHA9170	25841	Dec. 27, 2020
5	Loop Antenna	LAPLAC	RF300	9138	Dec. 27, 2020
6	Spectrum Analyzer	Rohde & Schwarz	FSU26	100105	Dec. 27, 2020
7	Horn Antenna	Schwarzbeck	BBHA 9120D	647	Dec. 27, 2020
8	Pre-Amplifier	HP	8447D	1937A03050	Dec. 27, 2020
9	Pre-Amplifier	EMCI	EMC051835	980075	Dec. 27, 2020
10	Antenna Mast	UC	UC3000	N/A	N/A
11	Turn Table	UC	UC3000	N/A	N/A
12	Cable Below 1GHz	Schwarzbeck	AK9515E	33155	Dec. 27, 2020
13	Cable Above 1GHz	Hubersuhner	SUCOFLEX 102	DA1580	Dec. 27, 2020
14	Splitter	Mini-Circuit	ZAPD-4	400059	Dec. 27, 2020
15	RF Connection Cable	HUBER+SUHNER	RE-7-FL	N/A	Dec. 27, 2020
16	RF Connection Cable	Chengdu E-Microwave	---	---	Dec. 27, 2020
17	High pass filter	Compliance	BSU-6	34202	Dec. 27, 2020

CTC Laboratories, Inc.

1-2/F., Building 2, Jiaquan Building, Guanlan High-Tech Park, Shenzhen, Guangdong, China

Tel.: (86)755-27521059

Fax: (86)755-27521011

Http://www.sz-ctc.org.cn

For anti-fake verification, please visit the official website of Certification and Accreditation Administration of the People's Republic of China : yz.cnca.cn



		Direction systems			
18	Attenuator	Chengdu E-Microwave	EMCAXX-10 RNZ-3	---	Dec. 27, 2020
19	High and low temperature box	ESPEC	MT3065	12114019	Dec. 27, 2020

Conducted Emission					
Item	Test Equipment	Manufacturer	Model No.	Serial No.	Calibrated until
1	LISN	R&S	ENV216	101112	Dec. 27, 2020
2	LISN	R&S	ENV216	101113	Dec. 27, 2020
3	EMI Test Receiver	R&S	ESCI	100658	Dec. 27, 2020

Note:1. The Cal. Interval was one year.

2. The cable loss has calculated in test result which connection between each test instruments.

3. TEST ITEM AND RESULTS

3.1. Conducted Emission

Limit

FCC CFR Title 47 Part 15 Subpart C Section 15.207/ RSS - Gen 8.8:

Frequency range (MHz)	Limit (dBuV)	
	Quasi-peak	Average
0.15-0.5	66 to 56*	56 to 46*
0.5-5	56	46
5-30	60	50

* Decreases with the logarithm of the frequency.

Test Configuration

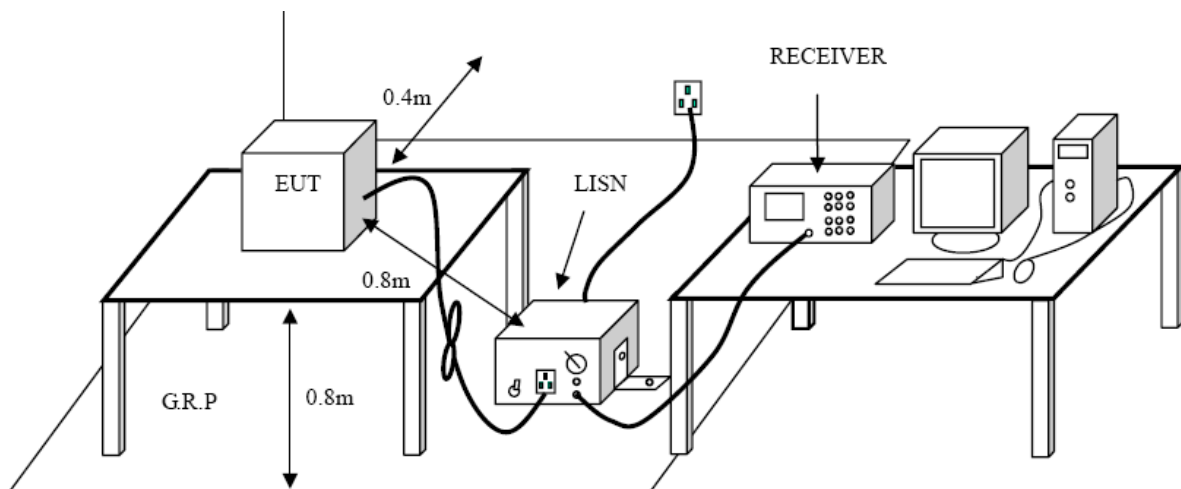

Test Procedure

1. The EUT was setup according to ANSI C63.10:2013 requirements.
2. The EUT was placed on a platform of nominal size, 1 m by 1.5 m, raised 80 cm above the conducting ground plane. The vertical conducting plane was located 40 cm to the rear of the EUT. All other surfaces of EUT were at least 80 cm from any other grounded conducting surface.
3. The EUT and simulators are connected to the main power through a line impedances stabilization network (LISN). The LISN provides a 50ohm /50uH coupling impedance for the measuring equipment. The peripheral devices are also connected to the main power through a LISN. (Please refer to the block diagram of the test setup and photographs)
4. Each current-carrying conductor of the EUT power cord, except the ground (safety) conductor, was individually connected through a LISN to the input power source.
5. The excess length of the power cord between the EUT and the LISN receptacle were folded back and forth at the center of the lead to form a bundle not exceeding 40 cm in length.
6. Conducted Emissions were investigated over the frequency range from 0.15MHz to 30MHz using a receiver bandwidth of 9 kHz.
7. During the above scans, the emissions were maximized by cable manipulation.

**Test Mode:**

Please refer to the clause 2.4.

Test Results

Test Voltage:	AC 120V/60 Hz
Adapter Model:	ADP-3600K120
Terminal:	Line

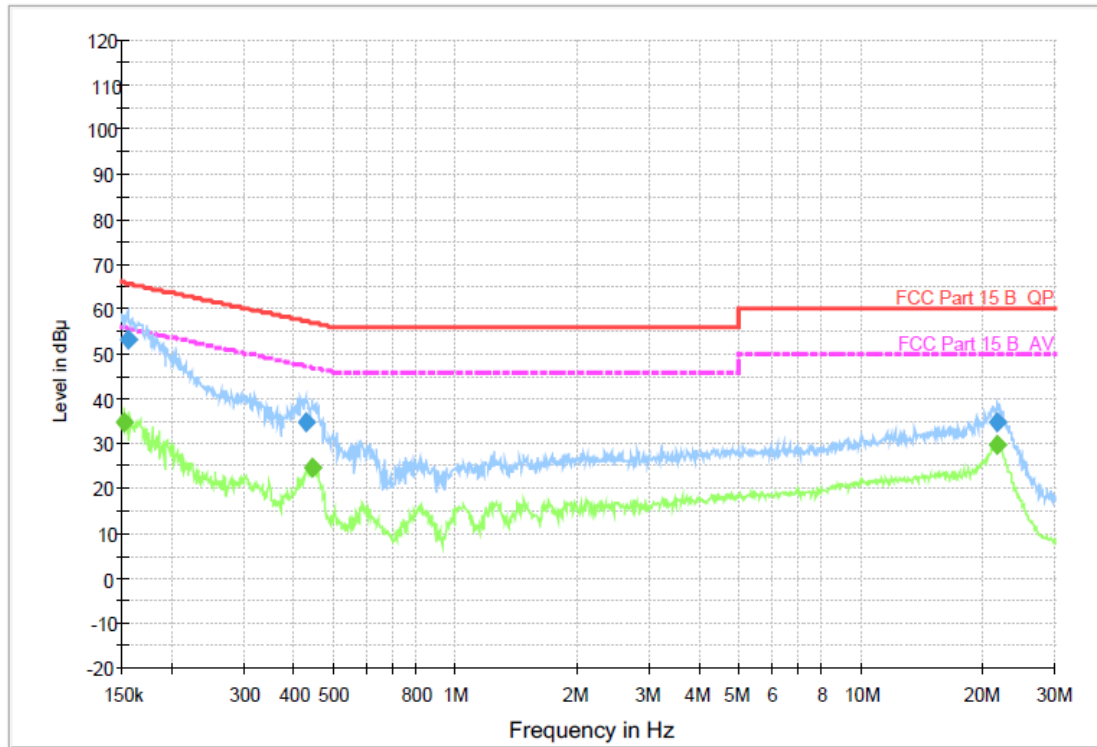
**Final Measurement Detector 1**

Frequency (MHz)	QuasiPeak (dB µ V)	Meas. Time (ms)	Bandwidth (kHz)	Filter	Line	Corr. (dB)	Margin (dB)	Limit (dB µ V)	Comment
0.154870	53.4	1000.00	9.000	On	L1	9.4	12.3	65.7	
0.425200	34.6	1000.00	9.000	On	L1	9.4	22.7	57.3	
21.691910	34.7	1000.00	9.000	On	L1	9.8	25.3	60.0	

Final Measurement Detector 2

Frequency (MHz)	Average (dB µ V)	Meas. Time (ms)	Bandwidth (kHz)	Filter	Line	Corr. (dB)	Margin (dB)	Limit (dB µ V)	Comment
0.151810	35.0	1000.00	9.000	On	L1	9.4	20.9	55.9	
0.442510	24.9	1000.00	9.000	On	L1	9.4	22.1	47.0	
21.605480	29.7	1000.00	9.000	On	L1	9.8	20.3	50.0	

Emission Level= Read Level+ Correct Factor



Test Voltage:	AC 120V/60 Hz
Adapter Model:	ADP-3600K120
Terminal:	Neutral

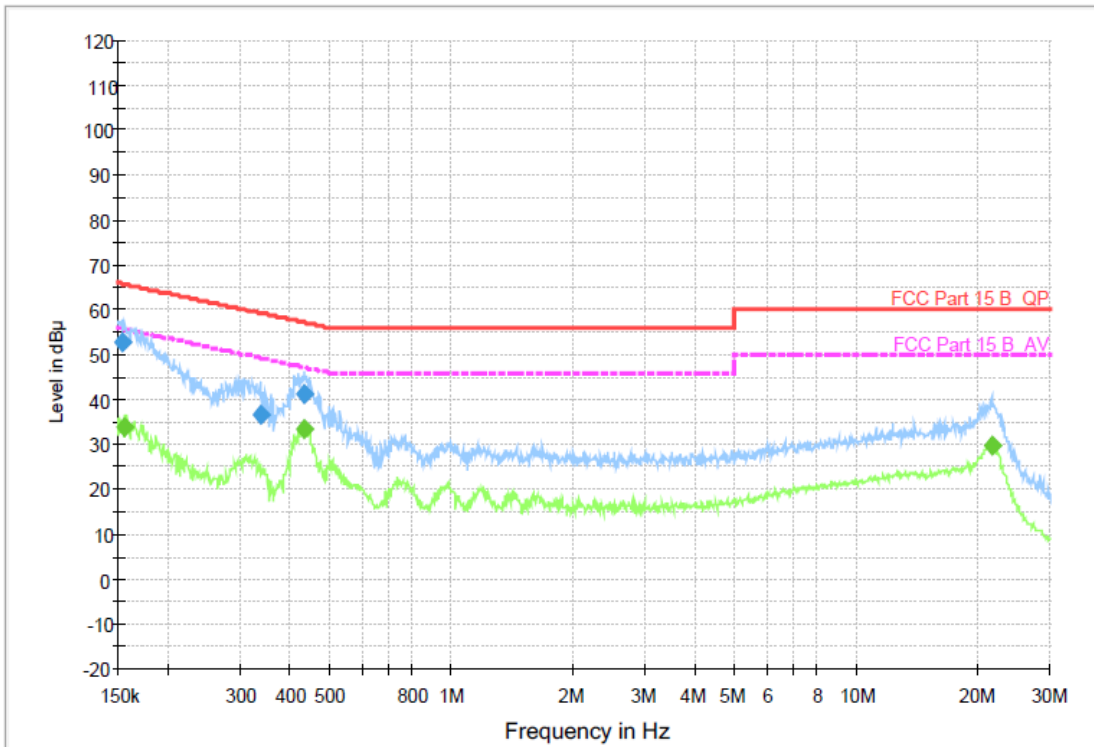

Final Measurement Detector 1

Frequency (MHz)	QuasiPeak (dB µV)	Meas. Time (ms)	Bandwidth (kHz)	Filter	Line	Corr. (dB)	Margin (dB)	Limit (dB µV)	Comment
0.153640	52.7	1000.00	9.000	On	N	9.4	13.1	65.8	
0.335970	36.8	1000.00	9.000	On	N	9.4	22.5	59.3	
0.432040	41.1	1000.00	9.000	On	N	9.4	16.1	57.2	

Final Measurement Detector 2

Frequency (MHz)	Average (dB µV)	Meas. Time (ms)	Bandwidth (kHz)	Filter	Line	Corr. (dB)	Margin (dB)	Limit (dB µV)	Comment
0.156110	34.0	1000.00	9.000	On	N	9.4	21.7	55.7	
0.432040	33.4	1000.00	9.000	On	N	9.4	13.8	47.2	
21.605480	29.8	1000.00	9.000	On	N	9.7	20.2	50.0	

Emission Level= Read Level+ Correct Factor



Test Voltage:	AC 120V/60 Hz
Adapter Model:	GQ36-120300-AU
Terminal:	Line

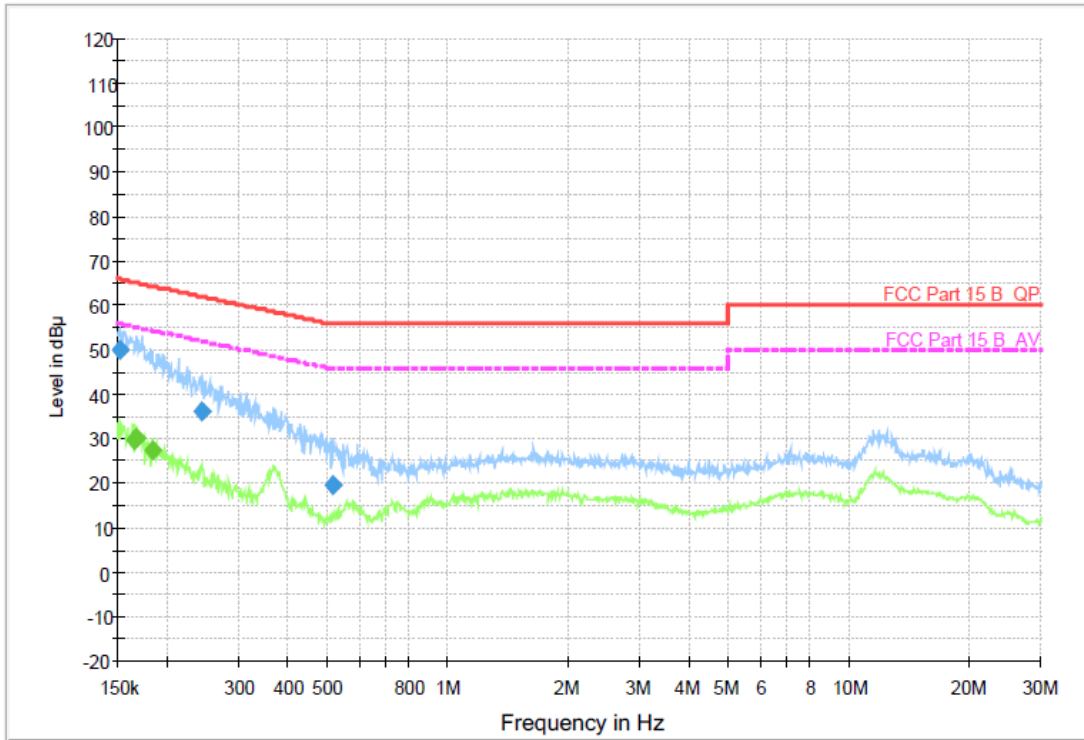

Final Measurement Detector 1

Frequency (MHz)	QuasiPeak (dB μ V)	Meas. Time (ms)	Bandwidth (kHz)	Filter	Line	Corr. (dB)	Margin (dB)	Limit (dB μ V)	Comment
0.151200	49.8	1000.00	9.000	On	L1	9.4	16.1	65.9	
0.244120	36.0	1000.00	9.000	On	L1	9.4	26.0	62.0	
0.517060	19.8	1000.00	9.000	On	L1	9.4	36.2	56.0	

Final Measurement Detector 2

Frequency (MHz)	Average (dB μ V)	Meas. Time (ms)	Bandwidth (kHz)	Filter	Line	Corr. (dB)	Margin (dB)	Limit (dB μ V)	Comment
0.165080	29.7	1000.00	9.000	On	L1	9.4	25.5	55.2	
0.167070	30.2	1000.00	9.000	On	L1	9.4	24.9	55.1	
0.183140	27.2	1000.00	9.000	On	L1	9.4	27.1	54.3	

Emission Level= Read Level+ Correct Factor

Test Voltage:	AC 120V/60 Hz
Adapter Model:	GQ36-120300-AU
Terminal:	Neutral

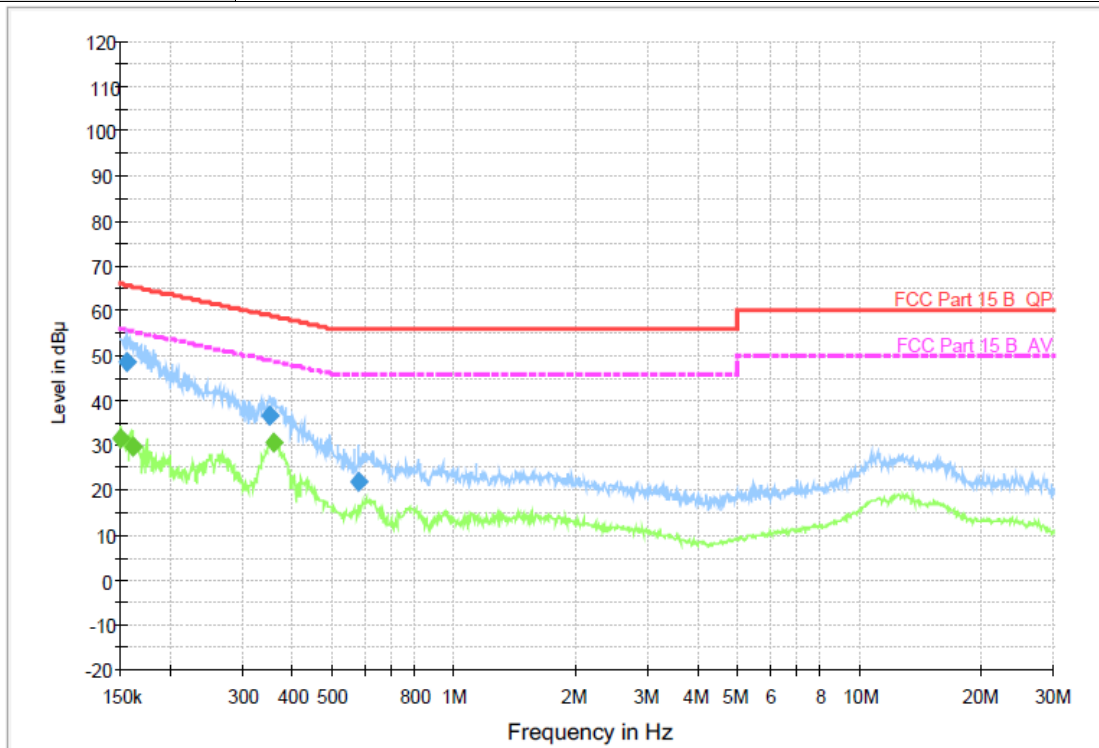

Final Measurement Detector 1

Frequency (MHz)	QuasiPeak (dB µ V)	Meas. Time (ms)	Bandwidth (kHz)	Filter	Line	Corr. (dB)	Margin (dB)	Limit (dB µ V)	Comment
0.154870	48.7	1000.00	9.000	On	N	9.4	17.0	65.7	
0.351050	36.5	1000.00	9.000	On	N	9.4	22.4	58.9	
0.578210	22.1	1000.00	9.000	On	N	9.4	33.9	56.0	

Final Measurement Detector 2

Frequency (MHz)	Average (dB µ V)	Meas. Time (ms)	Bandwidth (kHz)	Filter	Line	Corr. (dB)	Margin (dB)	Limit (dB µ V)	Comment
0.150600	31.5	1000.00	9.000	On	N	9.4	24.6	56.0	
0.161180	29.6	1000.00	9.000	On	N	9.4	25.8	55.4	
0.356700	30.4	1000.00	9.000	On	N	9.4	18.4	48.8	

Emission Level= Read Level+ Correct Factor



Test Voltage:	AC 120V/60 Hz
Adapter Model:	SOY-1200300US
Terminal:	Line

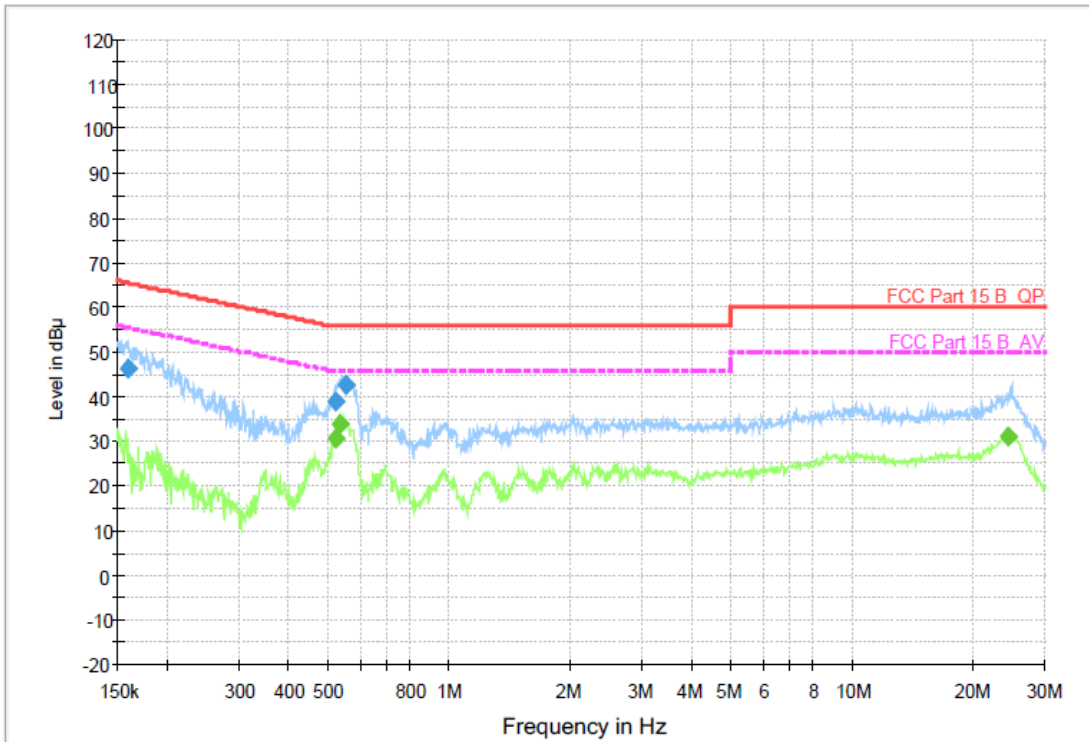

Final Measurement Detector 1

Frequency (MHz)	QuasiPeak (dB µ V)	Meas. Time (ms)	Bandwidth (kHz)	Filter	Line	Corr. (dB)	Margin (dB)	Limit (dB µ V)	Comment
0.159260	46.5	1000.00	9.000	On	L1	9.4	19.0	65.5	
0.519130	39.0	1000.00	9.000	On	L1	9.4	17.0	56.0	
0.551170	42.5	1000.00	9.000	On	L1	9.4	13.5	56.0	

Final Measurement Detector 2

Frequency (MHz)	Average (dB µ V)	Meas. Time (ms)	Bandwidth (kHz)	Filter	Line	Corr. (dB)	Margin (dB)	Limit (dB µ V)	Comment
0.519130	30.7	1000.00	9.000	On	L1	9.4	15.4	46.0	
0.531710	33.8	1000.00	9.000	On	L1	9.4	12.2	46.0	
24.257260	31.0	1000.00	9.000	On	L1	9.8	19.0	50.0	

Emission Level= Read Level+ Correct Factor



Test Voltage:	AC 120V/60 Hz
Adapter Model:	SOY-1200300US
Terminal:	Neutral

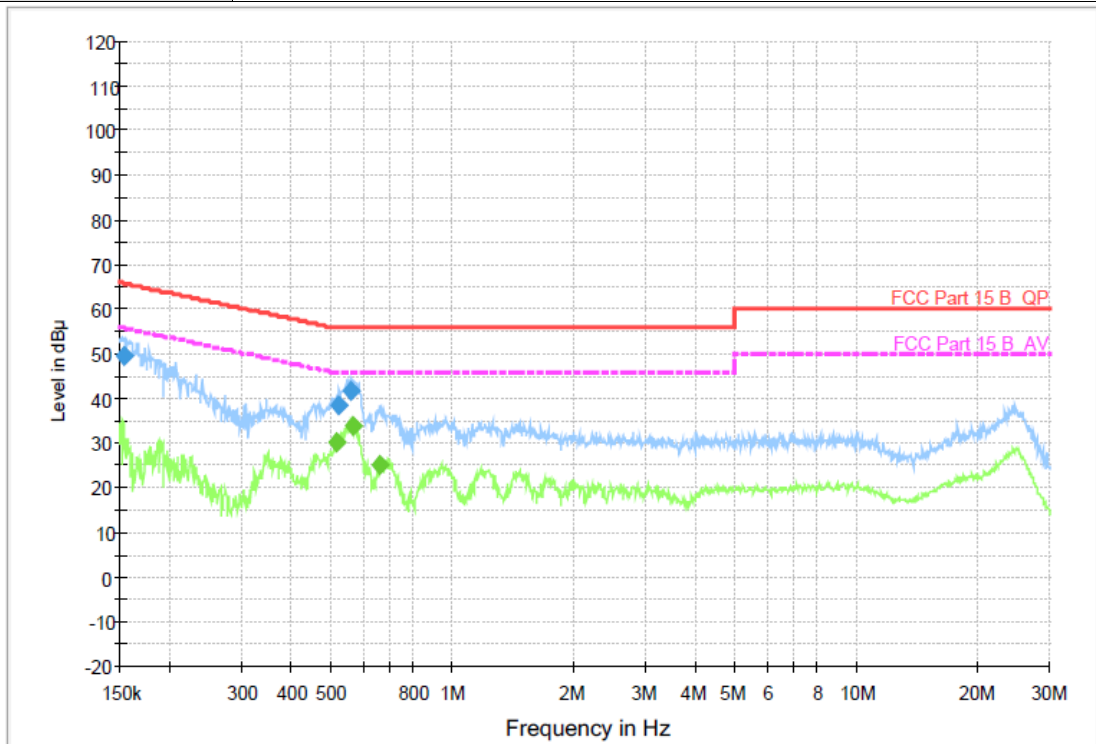

Final Measurement Detector 1

Frequency (MHz)	QuasiPeak (dB µ V)	Meas. Time (ms)	Bandwidth (kHz)	Filter	Line	Corr. (dB)	Margin (dB)	Limit (dB µ V)	Comment
0.154250	49.3	1000.00	9.000	On	N	9.4	16.5	65.8	
0.519130	38.6	1000.00	9.000	On	N	9.4	17.4	56.0	
0.562280	41.6	1000.00	9.000	On	N	9.4	14.4	56.0	

Final Measurement Detector 2

Frequency (MHz)	Average (dB µ V)	Meas. Time (ms)	Bandwidth (kHz)	Filter	Line	Corr. (dB)	Margin (dB)	Limit (dB µ V)	Comment
0.517060	30.0	1000.00	9.000	On	N	9.4	16.0	46.0	
0.566780	33.9	1000.00	9.000	On	N	9.4	12.1	46.0	
0.659630	25.0	1000.00	9.000	On	N	9.4	21.0	46.0	

Emission Level= Read Level+ Correct Factor

3.2. Radiated Emission

Limit

FCC CFR Title 47 Part 15 Subpart C Section 15.209/ RSS – Gen 8.9:

Frequency	Limit (dBuV/m @3m)	Value
30 MHz ~ 88 MHz	40.00	Quasi-peak
88 MHz ~ 216 MHz	43.50	Quasi-peak
216 MHz ~ 960 MHz	46.00	Quasi-peak
960 MHz ~ 1 GHz	54.00	Quasi-peak
Above 1 GHz	54.00	Average
	74.00	Peak

Note:

- (1) The tighter limit applies at the band edges.
- (2) Emission Level (dBuV/m)=20log Emission Level (uV/m).

Test Configuration

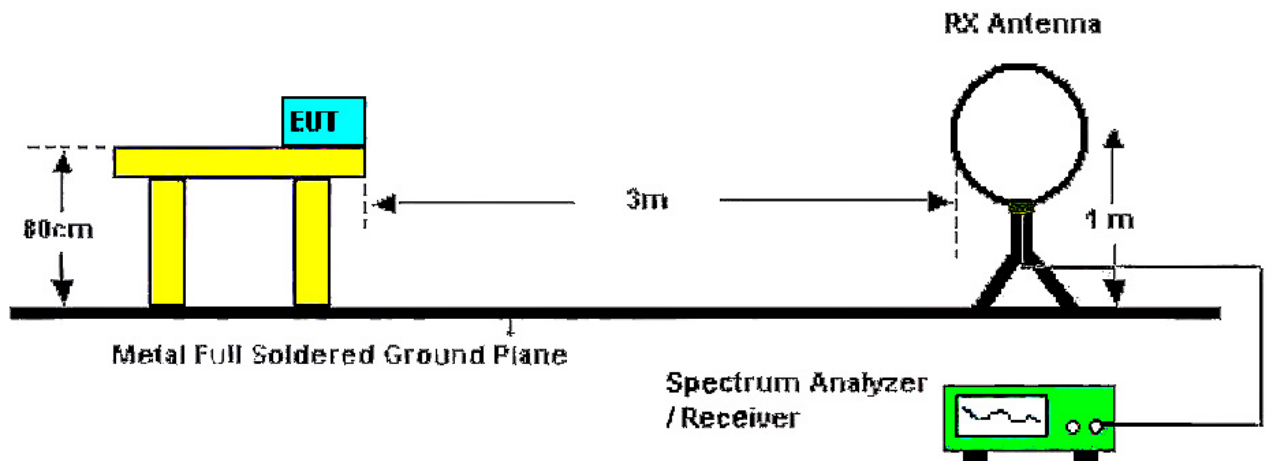

Below 30MHz Test Setup

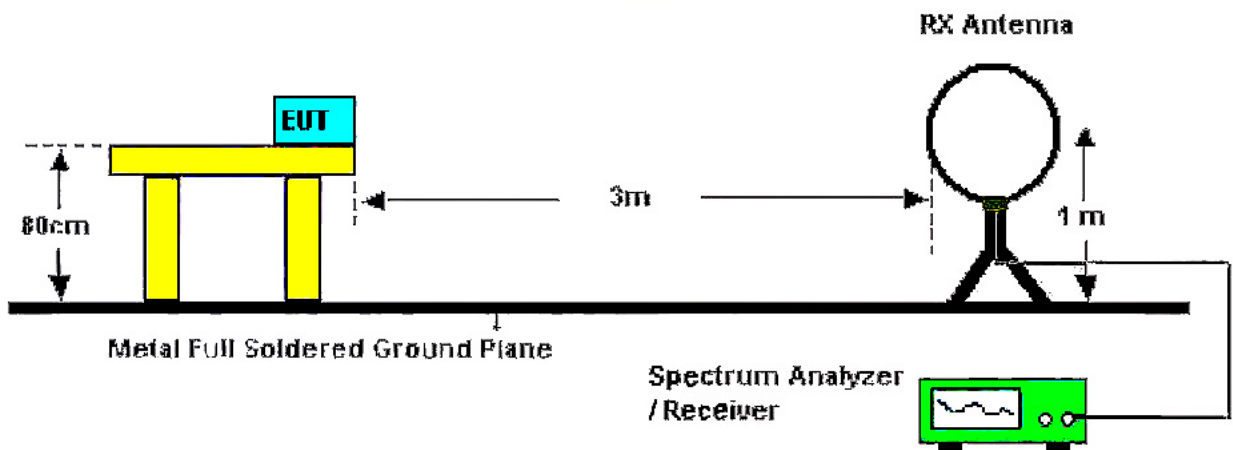

Below 1000MHz Test Setup

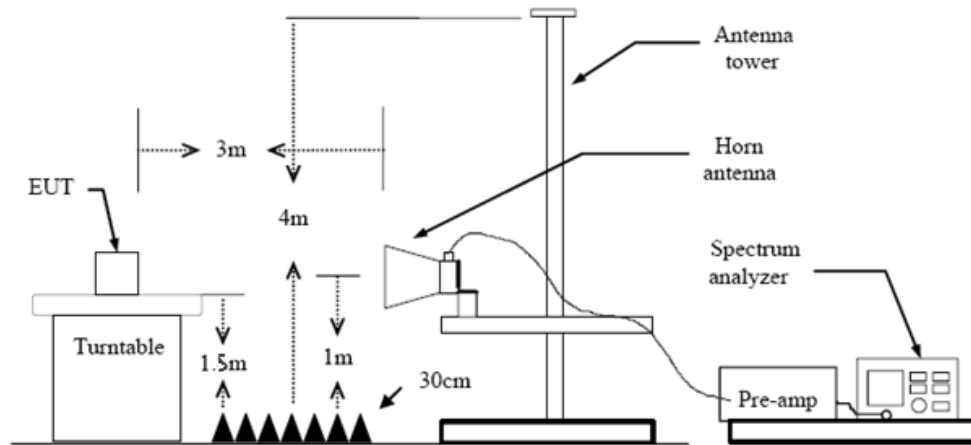

Above 1GHz Test Setup

Test Procedure

1. The EUT was setup and tested according to ANSI C63.10:2013
2. The EUT is placed on a turn table which is 0.8 meter above ground for below 1 GHz, and 1.5 m for above 1 GHz. The turn table is rotated 360 degrees to determine the position of the maximum emission level.
3. The EUT was set 3 meters from the receiving antenna, which was mounted on the top of a variable height antenna tower.
4. For each suspected emission, the EUT was arranged to its worst case and then tune the Antenna tower (from 1 m to 4 m) and turntable (from 0 degree to 360 degrees) to find the maximum reading. A pre-amp and a high pass filter are used for the test in order to get better signal level to comply with the guidelines.
5. Set to the maximum power setting and enable the EUT transmit continuously.

6. Use the following spectrum analyzer settings

- (1) Span shall wide enough to fully capture the emission being measured;

- (2) Below 1 GHz:

RBW=120 kHz, VBW=300 kHz, Sweep=auto, Detector function=peak, Trace=max hold;

If the emission level of the EUT measured by the peak detector is 3 dB lower than the applicable limit, the peak emission level will be reported. Otherwise, the emission measurement will be repeated using the quasi-peak detector and reported.

- (3) From 1 GHz to 10th harmonic:

RBW=1MHz, VBW=3MHz Peak detector for Peak value.

RBW=1MHz, VBW=3MHz RMS detector for Average value.

Test Mode

Please refer to the clause 2.4.

Test Result

9 KHz~30 MHz

From 9 KHz to 30 MHz: Conclusion: PASS

Note: The amplitude of spurious emissions which are attenuated by more than 20dB below the permissible value has no need to be reported.



30MHz-1GHz

Ant. Pol.	Horizontal
Adapter Model:	ADP-3600K120
Test Mode:	802.11b Mode 2412MHz
Remark:	Only worse case is reported

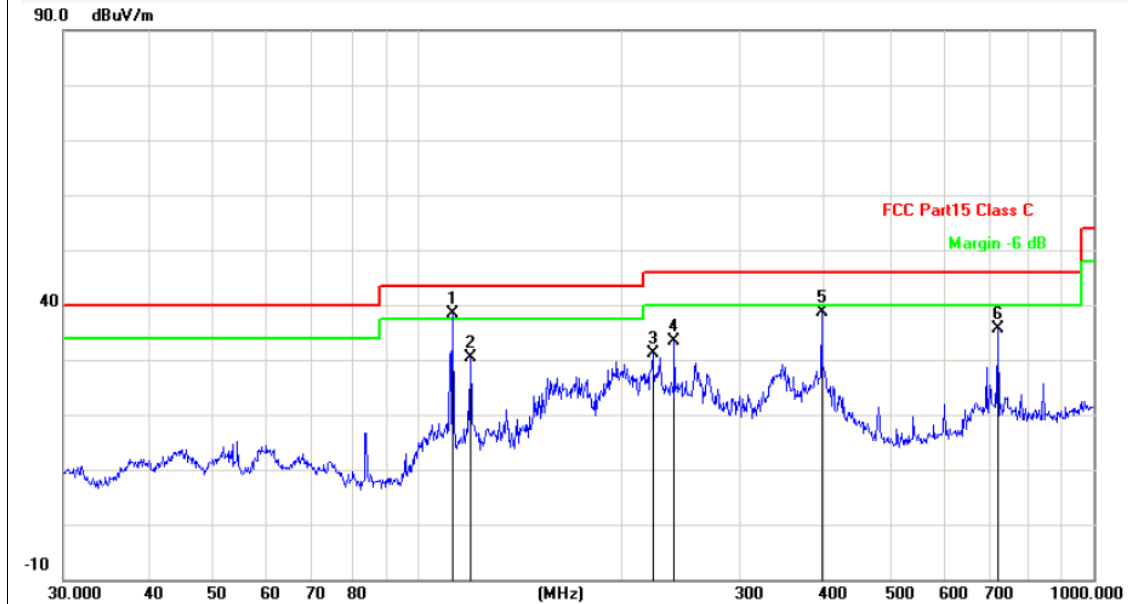

No.	Frequency (MHz)	Factor (dB/m)	Reading (dBuV)	Level (dBuV/m)	Limit (dBuV/m)	Margin (dB)	Detector
1	112.9196	-19.89	58.37	38.48	43.50	-5.02	QP
2	119.8556	-19.31	49.61	30.30	43.50	-13.20	QP
3	222.9502	-20.08	51.14	31.06	46.00	-14.94	QP
4	239.9873	-19.48	52.88	33.40	46.00	-12.60	QP
5	396.2415	-15.86	54.38	38.52	46.00	-7.48	QP
6	721.7259	-10.47	46.00	35.53	46.00	-10.47	QP

Remarks:

- Factor (dB/m) = Antenna Factor (dB/m)+Cable Factor (dB)-Pre-amplifier Factor
- Margin value = Level -Limit value



Ant. Pol.	Vertical
Adapter Model:	ADP-3600K120
Test Mode:	802.11b Mode 2412MHz
Remark:	Only worse case is reported

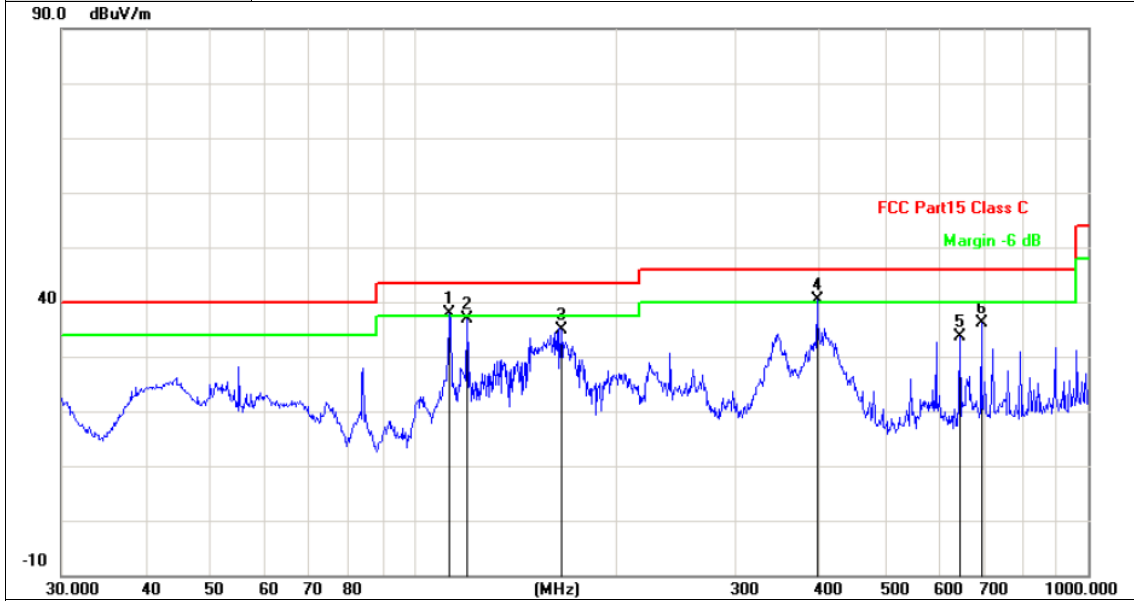

No.	Frequency (MHz)	Factor (dB/m)	Reading (dBuV)	Level (dBuV/m)	Limit (dBuV/m)	Margin (dB)	Detector
1	112.9196	-19.89	57.83	37.94	43.50	-5.56	QP
2	119.8556	-19.31	56.27	36.96	43.50	-6.54	QP
3	165.4866	-18.07	53.02	34.95	43.50	-8.55	QP
4	396.2415	-15.86	56.18	40.32	46.00	-5.68	QP
5	645.1195	-11.55	45.25	33.70	46.00	-12.30	QP
6	694.4174	-10.84	46.91	36.07	46.00	-9.93	QP

Remarks:

- Factor (dB/m) = Antenna Factor (dB/m)+Cable Factor (dB)-Pre-amplifier Factor
- Margin value = Level -Limit value



Ant. Pol.	Horizontal
Adapter Model:	GQ36-120300-AU
Test Mode:	802.11b Mode 2412MHz
Remark:	Only worse case is reported

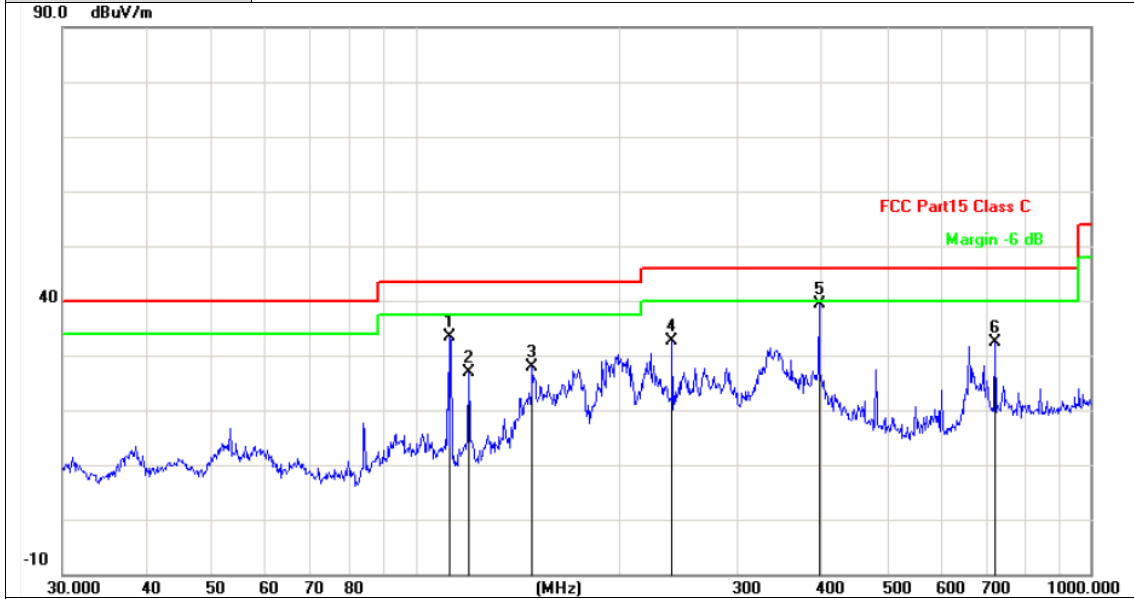

No.	Frequency (MHz)	Factor (dB/m)	Reading (dBuV)	Level (dBuV/m)	Limit (dBuV/m)	Margin (dB)	Detector
1	112.5244	-19.94	53.21	33.27	43.50	-10.23	QP
2	119.8556	-19.31	46.21	26.90	43.50	-16.60	QP
3	148.9625	-16.85	44.67	27.82	43.50	-15.68	QP
4	239.9873	-19.48	52.05	32.57	46.00	-13.43	QP
5	396.2415	-15.86	55.24	39.38	46.00	-6.62	QP
6	721.7259	-10.47	42.89	32.42	46.00	-13.58	QP

Remarks:

- Factor (dB/m) = Antenna Factor (dB/m)+Cable Factor (dB)-Pre-amplifier Factor
- Margin value = Level -Limit value



Ant. Pol.	Vertical
Adapter Model:	GQ36-120300-AU
Test Mode:	802.11b Mode 2412MHz
Remark:	Only worse case is reported

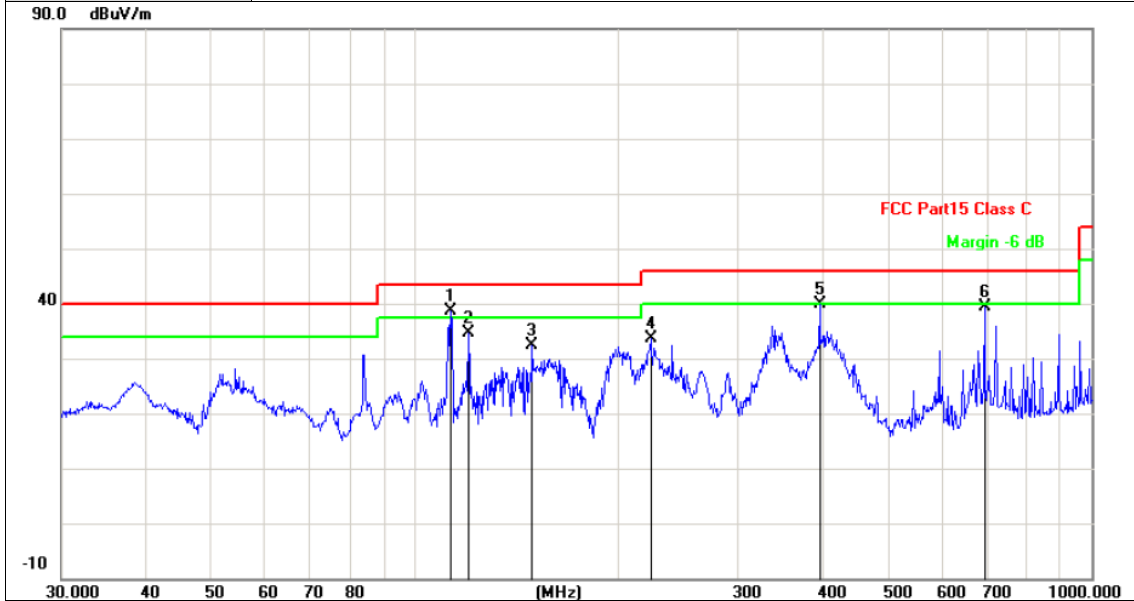

No.	Frequency (MHz)	Factor (dB/m)	Reading (dBuV)	Level (dBuV/m)	Limit (dBuV/m)	Margin (dB)	Detector
1	112.9196	-19.89	58.58	38.69	43.50	-4.81	QP
2	119.8556	-19.31	53.94	34.63	43.50	-8.87	QP
3	148.9625	-16.85	49.18	32.33	43.50	-11.17	QP
4	222.9502	-20.08	53.71	33.63	46.00	-12.37	QP
5	396.2415	-15.86	55.80	39.94	46.00	-6.06	QP
6	694.4174	-10.84	50.31	39.47	46.00	-6.53	QP

Remarks:
 1. Factor (dB/m) = Antenna Factor (dB/m)+Cable Factor (dB)-Pre-amplifier Factor
 2. Margin value = Level -Limit value



Ant. Pol.	Horizontal
Adapter Model:	SOY-1200300US
Test Mode:	802.11b Mode 2412MHz
Remark:	Only worse case is reported

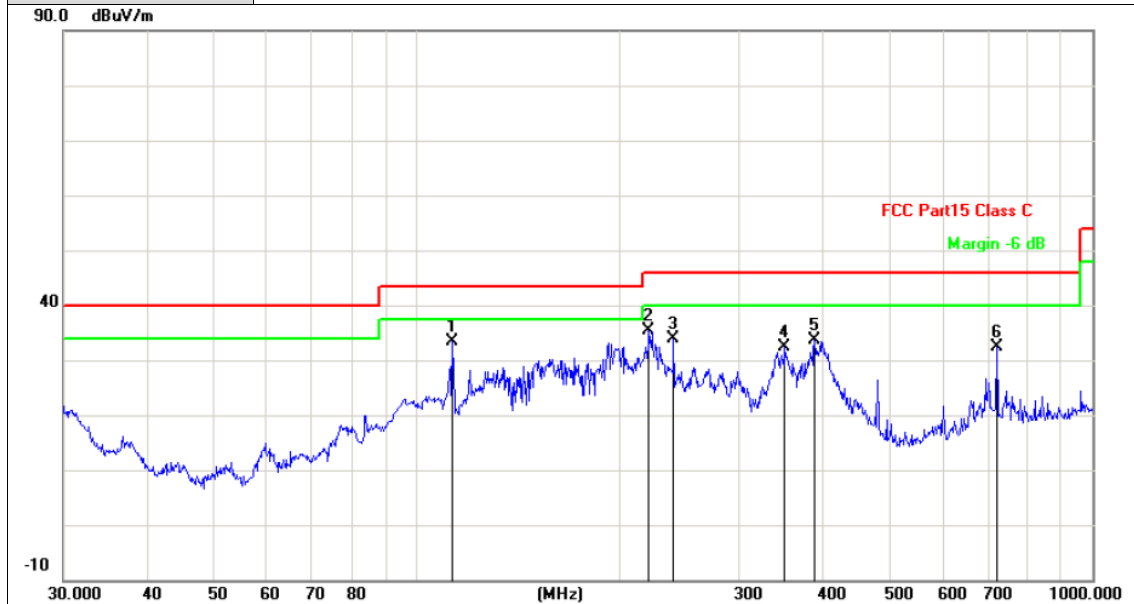

No.	Frequency (MHz)	Factor (dB/m)	Reading (dBuV)	Level (dBuV/m)	Limit (dBuV/m)	Margin (dB)	Detector
1	112.9196	-19.89	53.33	33.44	43.50	-10.06	QP
2	220.6171	-20.16	55.42	35.26	46.00	-10.74	QP
3	239.9873	-19.48	53.33	33.85	46.00	-12.15	QP
4	350.4768	-16.71	49.01	32.30	46.00	-13.70	QP
5	387.9920	-16.02	49.58	33.56	46.00	-12.44	QP
6	721.7259	-10.47	42.97	32.50	46.00	-13.50	QP

Remarks:

- Factor (dB/m) = Antenna Factor (dB/m)+Cable Factor (dB)-Pre-amplifier Factor
- Margin value = Level -Limit value



Ant. Pol.	Vertical
Adapter Model:	SOY-1200300US
Test Mode:	802.11b Mode 2412MHz
Remark:	Only worse case is reported

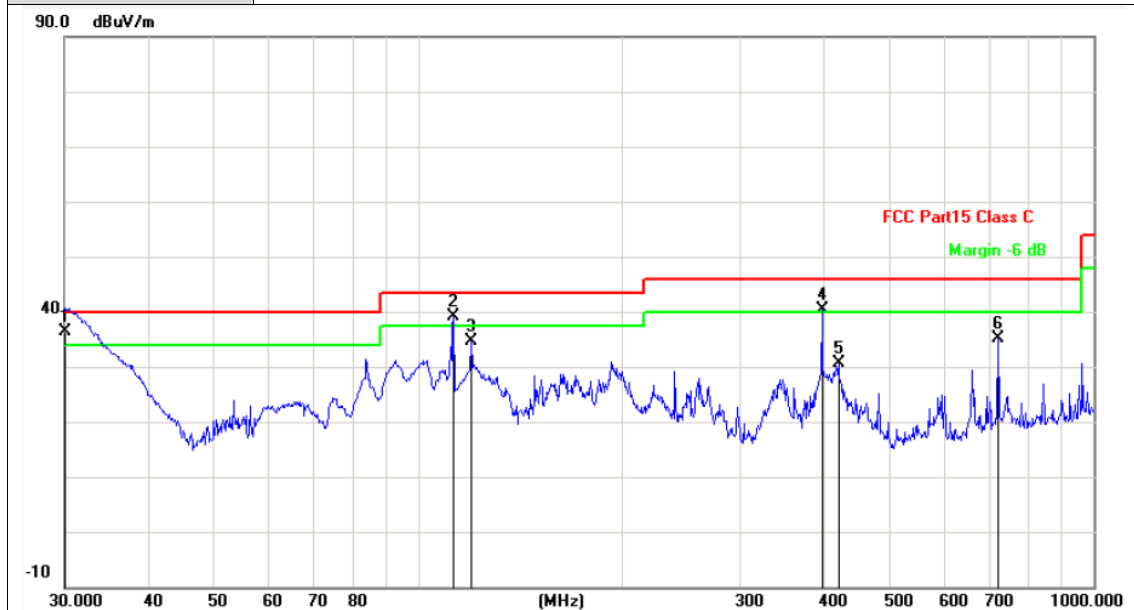

No.	Frequency (MHz)	Factor (dB/m)	Reading (dBuV)	Level (dBuV/m)	Limit (dBuV/m)	Margin (dB)	Detector
1	30.1054	-18.18	54.68	36.50	40.00	-3.50	QP
2	112.9196	-19.89	59.12	39.23	43.50	-4.27	QP
3	119.8556	-19.31	53.93	34.62	43.50	-8.88	QP
4	396.2415	-15.86	56.36	40.50	46.00	-5.50	QP
5	419.1081	-15.26	45.84	30.58	46.00	-15.42	QP
6	721.7259	-10.47	45.60	35.13	46.00	-10.87	QP

Remarks:

- Factor (dB/m) = Antenna Factor (dB/m)+Cable Factor (dB)-Pre-amplifier Factor
- Margin value = Level -Limit value



Adobe 1GHz

Ant. Pol.	Horizontal
Test Mode:	TX B Mode 2412MHz
Remark:	No report for the emission which more than 10 dB below the prescribed limit.

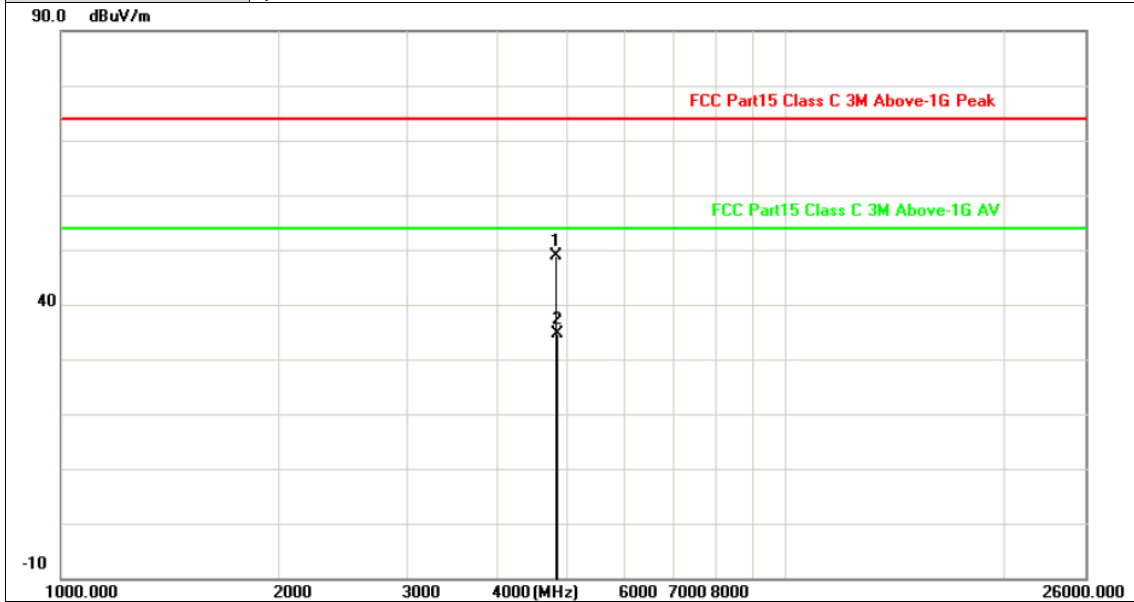

No.	Frequency (MHz)	Factor (dB/m)	Reading (dBuV)	Level (dBuV/m)	Limit (dBuV/m)	Margin (dB)	Detector
1	4823.494	5.16	43.65	48.81	74.00	-25.19	peak
2	4824.692	5.16	29.55	34.71	54.00	-19.29	AVG

Remarks:
 1. Factor (dB/m) = Antenna Factor (dB/m)+Cable Factor (dB)-Pre-amplifier Factor
 2. Margin value = Level -Limit value



Ant. Pol.	Vertical
Test Mode:	TX B Mode 2412MHz
Remark:	No report for the emission which more than 10 dB below the prescribed limit.

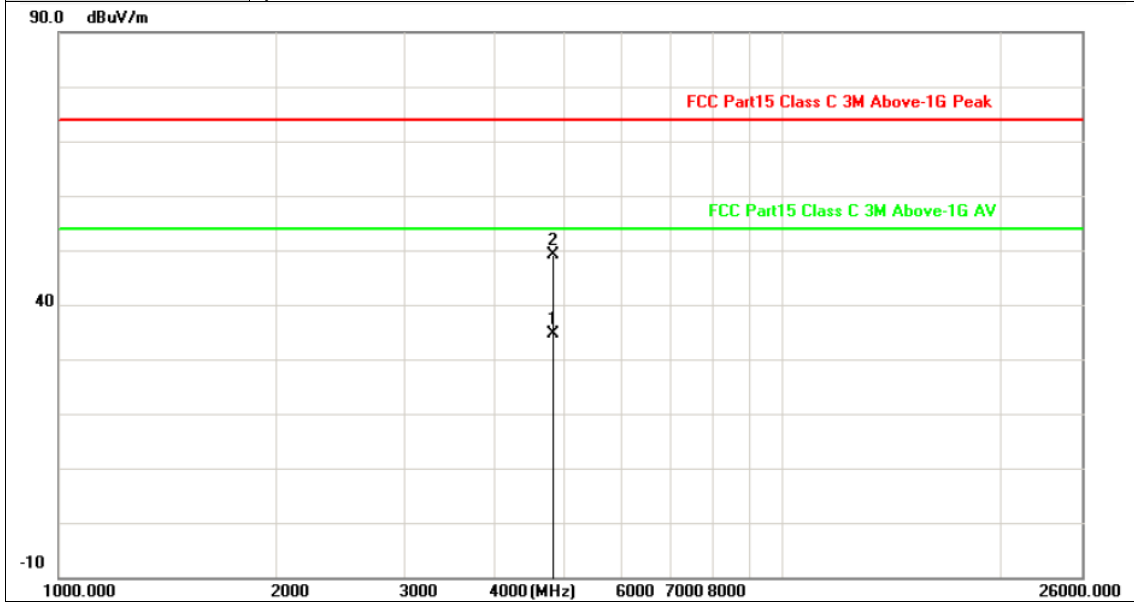

No.	Frequency (MHz)	Factor (dB/m)	Reading (dBuV)	Level (dBuV/m)	Limit (dBuV/m)	Margin (dB)	Detector
1	4823.995	5.16	29.58	34.74	54.00	-19.26	AVG
2	4824.004	5.16	43.94	49.10	74.00	-24.90	peak

Remarks:
 1. Factor (dB/m) = Antenna Factor (dB/m)+Cable Factor (dB)-Pre-amplifier Factor
 2. Margin value = Level -Limit value



Ant. Pol.	Horizontal
Test Mode:	TX B Mode 2437MHz
Remark:	No report for the emission which more than 10 dB below the prescribed limit.

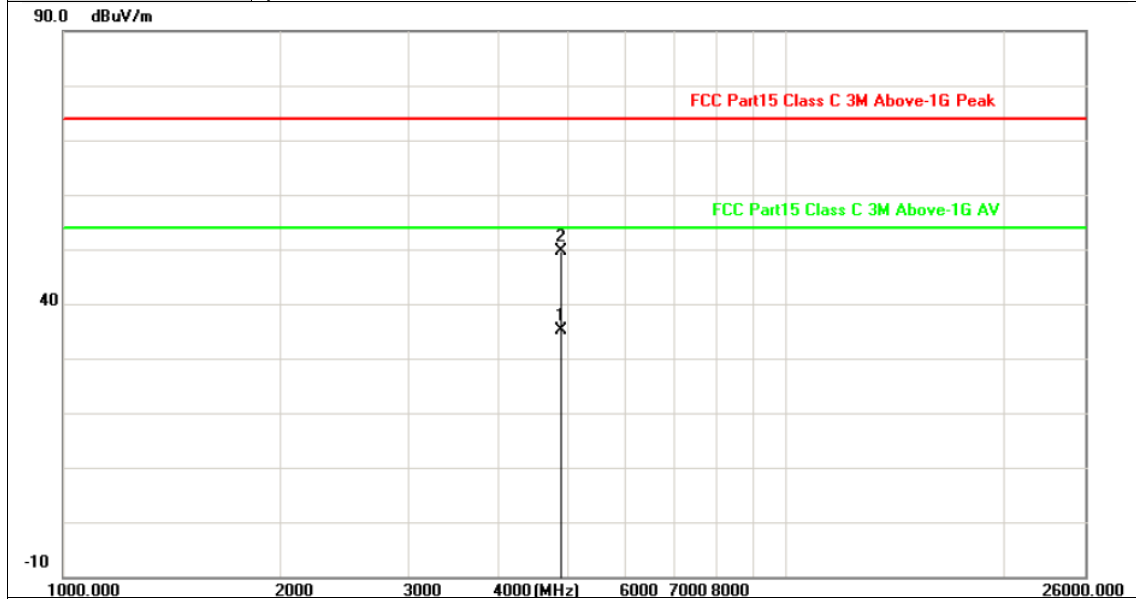

No.	Frequency (MHz)	Factor (dB/m)	Reading (dBuV)	Level (dBuV/m)	Limit (dBuV/m)	Margin (dB)	Detector
1	4873.282	5.20	29.96	35.16	54.00	-18.84	AVG
2	4874.372	5.20	44.48	49.68	74.00	-24.32	peak

Remarks:

- Factor (dB/m) = Antenna Factor (dB/m)+Cable Factor (dB)-Pre-amplifier Factor
- Margin value = Level -Limit value



Ant. Pol.	Vertical
Test Mode:	TX B Mode 2437MHz
Remark:	No report for the emission which more than 10 dB below the prescribed limit.

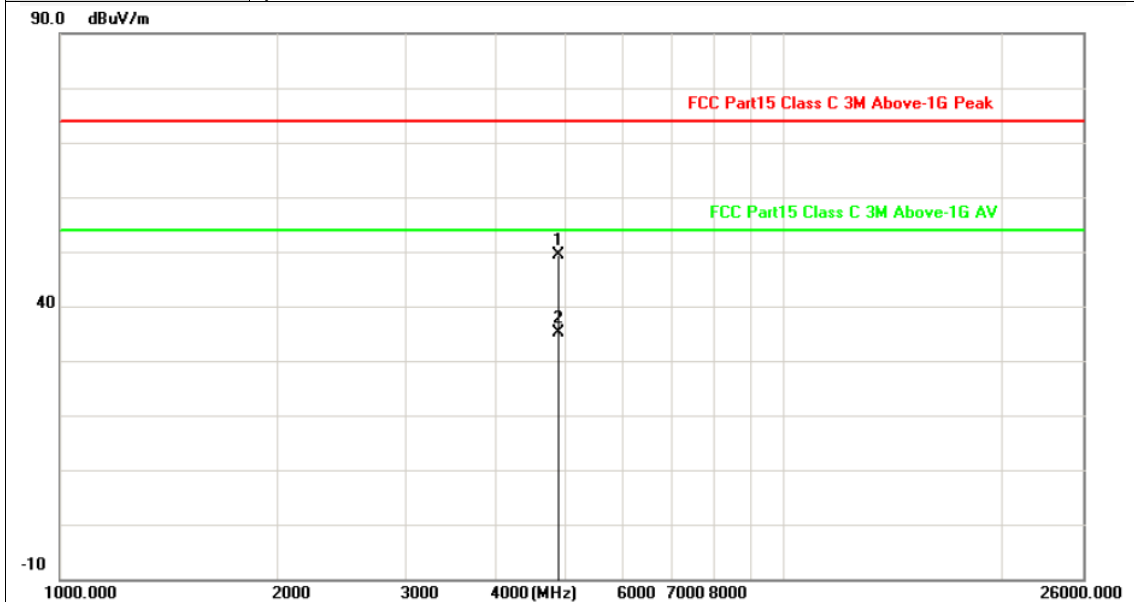

No.	Frequency (MHz)	Factor (dB/m)	Reading (dBuV)	Level (dBuV/m)	Limit (dBuV/m)	Margin (dB)	Detector
1	4874.001	5.20	44.30	49.50	74.00	-24.50	peak
2	4873.995	5.20	29.92	35.12	54.00	-18.88	AVG

Remarks:
 1. Factor (dB/m) = Antenna Factor (dB/m)+Cable Factor (dB)-Pre-amplifier Factor
 2. Margin value = Level -Limit value



Ant. Pol.	Horizontal
Test Mode:	TX B Mode 2462MHz
Remark:	No report for the emission which more than 10 dB below the prescribed limit.

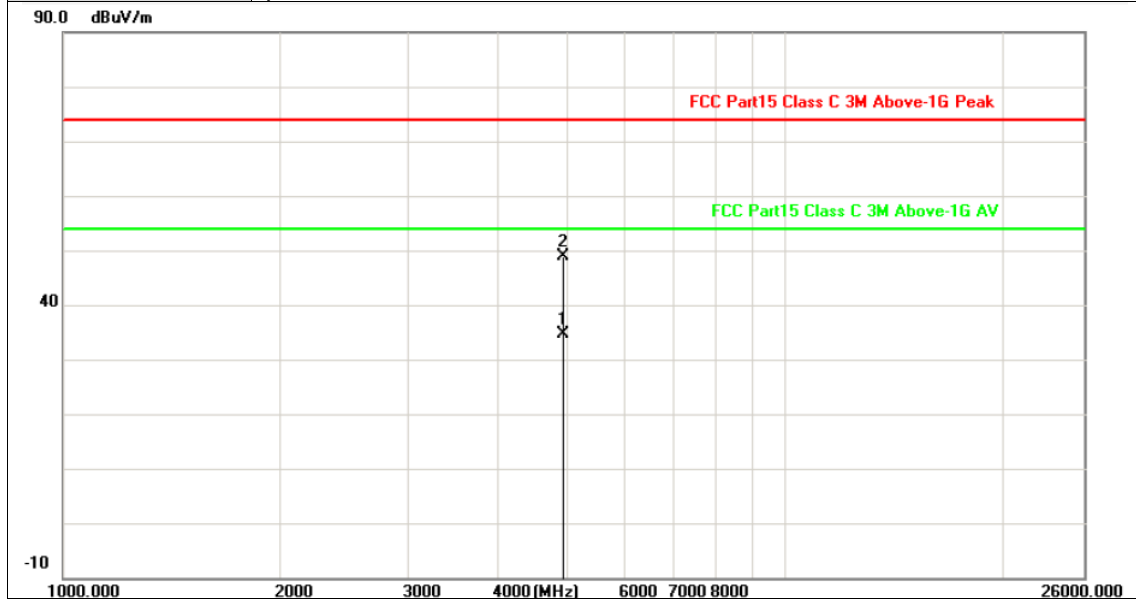

No.	Frequency (MHz)	Factor (dB/m)	Reading (dBuV)	Level (dBuV/m)	Limit (dBuV/m)	Margin (dB)	Detector
1	4924.636	5.23	29.51	34.74	54.00	-19.26	AVG
2	4923.418	5.23	43.74	48.97	74.00	-25.03	peak

Remarks:

- Factor (dB/m) = Antenna Factor (dB/m)+Cable Factor (dB)-Pre-amplifier Factor
- Margin value = Level -Limit value



Ant. Pol.	Vertical
Test Mode:	TX B Mode 2462MHz
Remark:	No report for the emission which more than 10 dB below the prescribed limit.

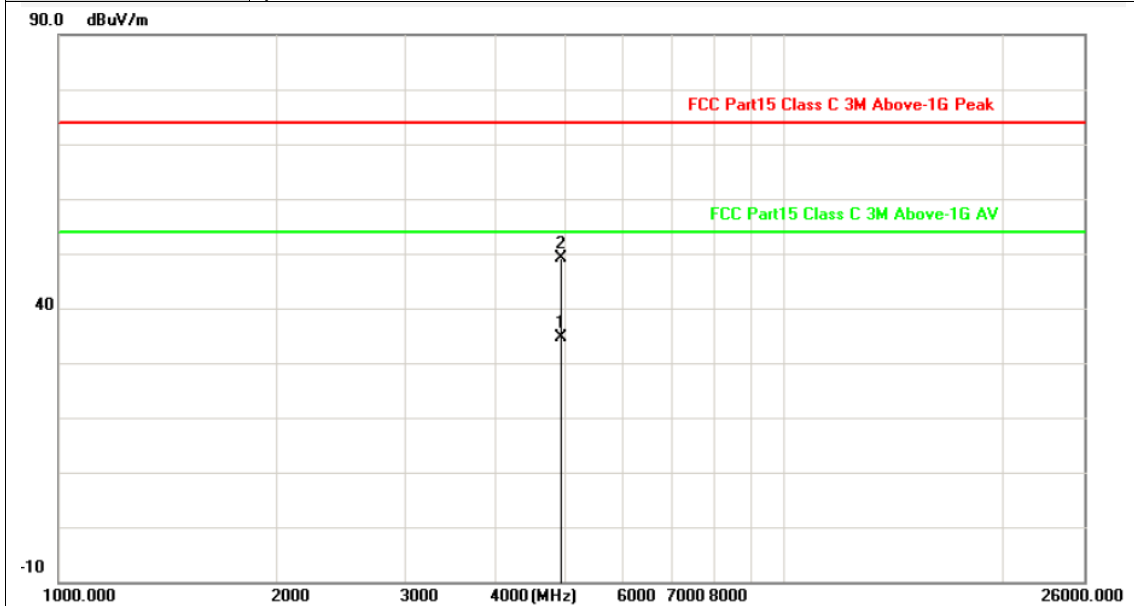

No.	Frequency (MHz)	Factor (dB/m)	Reading (dBuV)	Level (dBuV/m)	Limit (dBuV/m)	Margin (dB)	Detector
1	4923.998	5.23	29.43	34.66	54.00	-19.34	AVG
2	4924.003	5.23	43.78	49.01	74.00	-24.99	peak

Remarks:
 1. Factor (dB/m) = Antenna Factor (dB/m)+Cable Factor (dB)-Pre-amplifier Factor
 2. Margin value = Level -Limit value



Ant. Pol.	Horizontal
Test Mode:	TX G Mode 2412MHz
Remark:	No report for the emission which more than 10 dB below the prescribed limit.

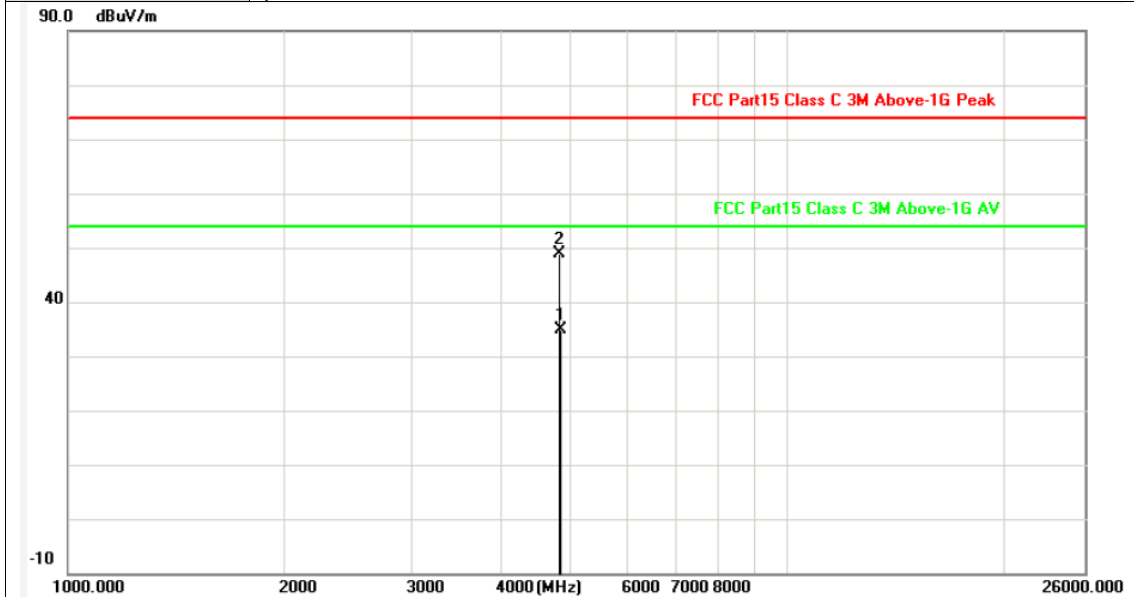

No.	Frequency (MHz)	Factor (dB/m)	Reading (dBuV)	Level (dBuV/m)	Limit (dBuV/m)	Margin (dB)	Detector
1	4824.678	5.16	29.62	34.78	54.00	-19.22	AVG
2	4823.934	5.16	43.64	48.80	74.00	-25.20	peak

Remarks:

- Factor (dB/m) = Antenna Factor (dB/m)+Cable Factor (dB)-Pre-amplifier Factor
- Margin value = Level -Limit value



Ant. Pol.	Vertical
Test Mode:	TX G Mode 2412MHz
Remark:	No report for the emission which more than 10 dB below the prescribed limit.

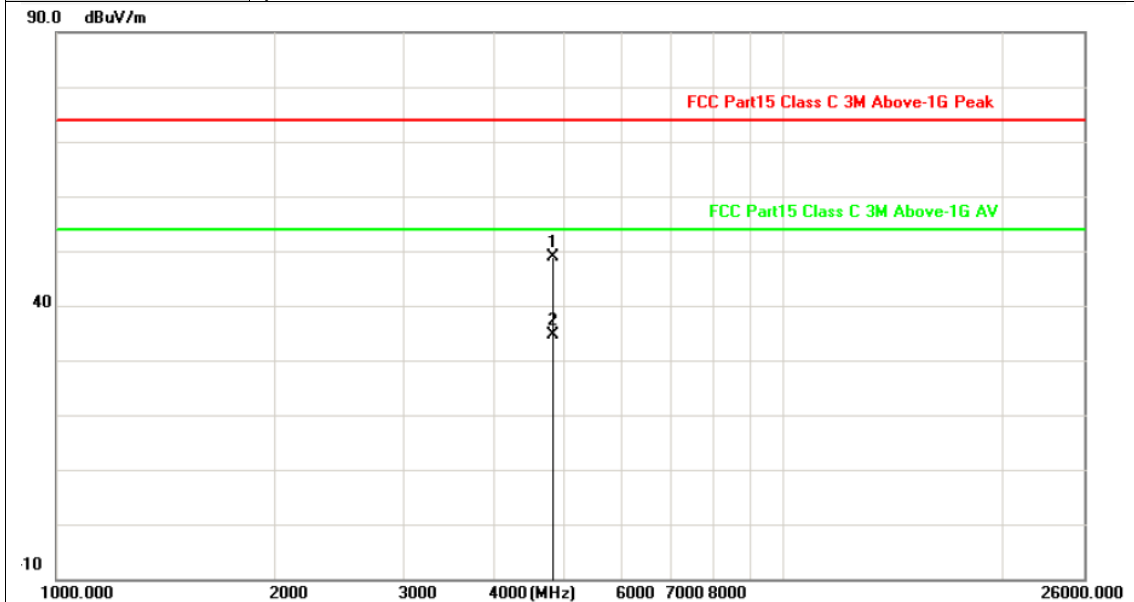

No.	Frequency (MHz)	Factor (dB/m)	Reading (dBuV)	Level (dBuV/m)	Limit (dBuV/m)	Margin (dB)	Detector
1	4823.998	5.16	43.65	48.81	74.00	-25.19	peak
2	4824.002	5.16	29.55	34.71	54.00	-19.29	AVG

Remarks:
 1. Factor (dB/m) = Antenna Factor (dB/m)+Cable Factor (dB)-Pre-amplifier Factor
 2. Margin value = Level -Limit value



Ant. Pol.	Horizontal
Test Mode:	TX G Mode 2437MHz
Remark:	No report for the emission which more than 10 dB below the prescribed limit.

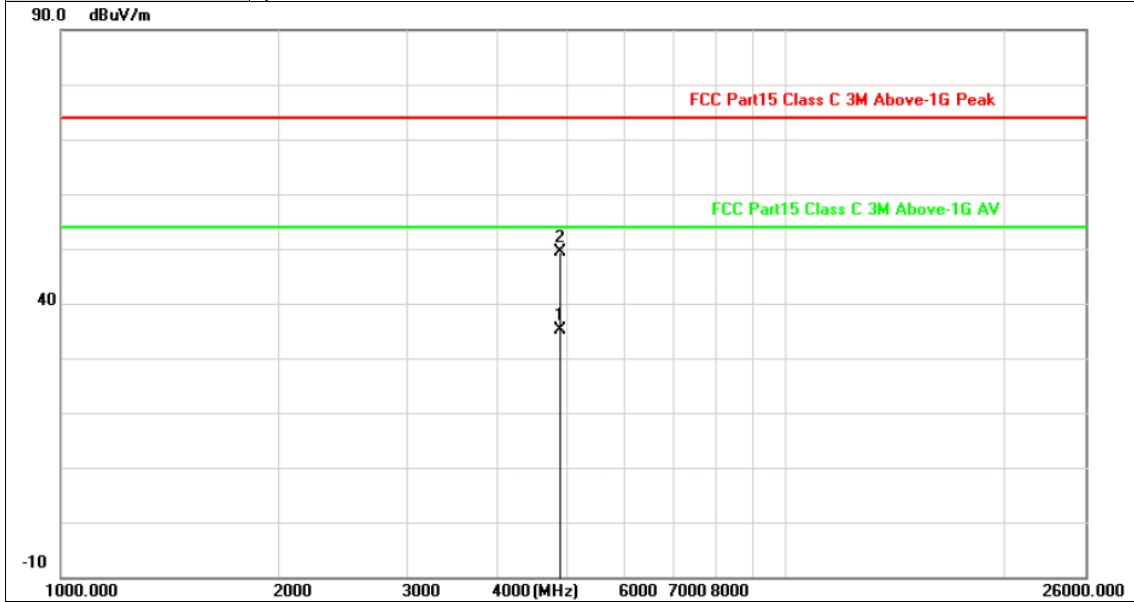

No.	Frequency (MHz)	Factor (dB/m)	Reading (dBuV)	Level (dBuV/m)	Limit (dBuV/m)	Margin (dB)	Detector
1	4874.002	5.20	29.94	35.14	54.00	-18.86	AVG
2	4873.996	5.20	44.18	49.38	74.00	-24.62	peak

Remarks:
 1. Factor (dB/m) = Antenna Factor (dB/m)+Cable Factor (dB)-Pre-amplifier Factor
 2. Margin value = Level -Limit value



Ant. Pol.	Vertical
Test Mode:	TX G Mode 2437MHz
Remark:	No report for the emission which more than 10 dB below the prescribed limit.

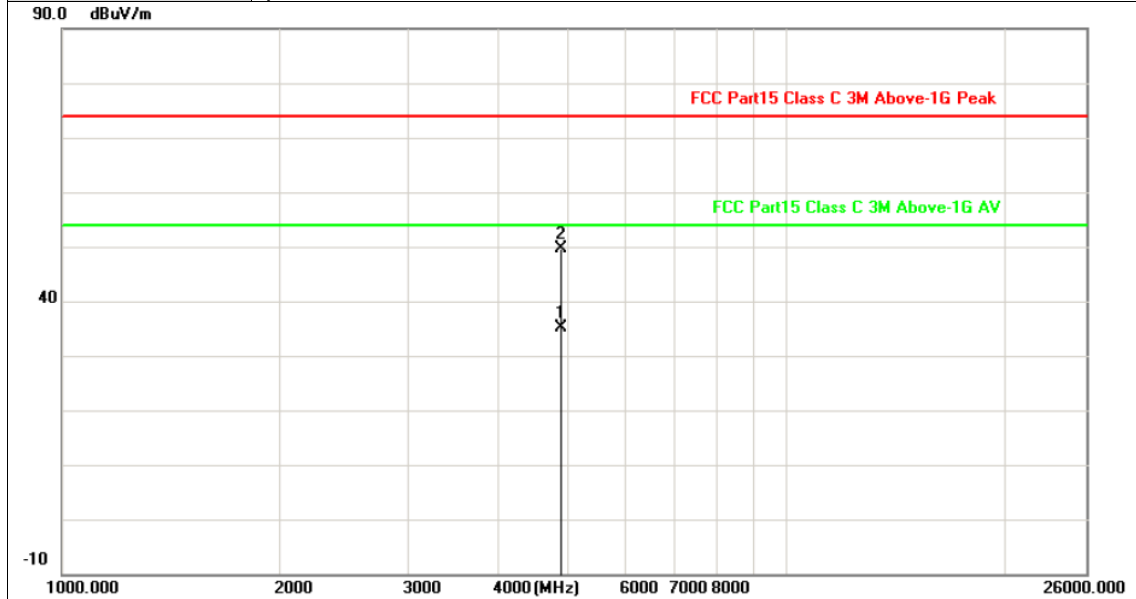

No.	Frequency (MHz)	Factor (dB/m)	Reading (dBuV)	Level (dBuV/m)	Limit (dBuV/m)	Margin (dB)	Detector
1	4873.995	5.20	29.92	35.12	54.00	-18.88	AVG
2	4873.999	5.20	44.44	49.64	74.00	-24.36	peak

Remarks:

- Factor (dB/m) = Antenna Factor (dB/m)+Cable Factor (dB)-Pre-amplifier Factor
- Margin value = Level -Limit value



Ant. Pol.	Horizontal
Test Mode:	TX G Mode 2462MHz
Remark:	No report for the emission which more than 10 dB below the prescribed limit.

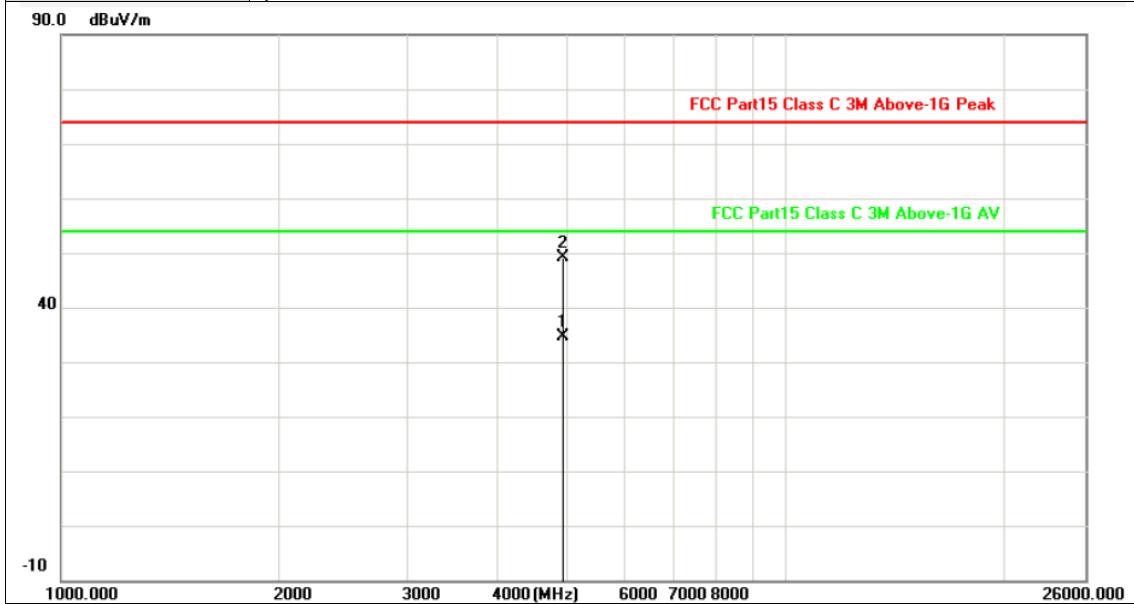

No.	Frequency (MHz)	Factor (dB/m)	Reading (dBuV)	Level (dBuV/m)	Limit (dBuV/m)	Margin (dB)	Detector
1	4924.005	5.23	29.43	34.66	54.00	-19.34	AVG
2	4923.998	5.23	43.84	49.07	74.00	-24.93	peak

Remarks:
 1. Factor (dB/m) = Antenna Factor (dB/m)+Cable Factor (dB)-Pre-amplifier Factor
 2. Margin value = Level -Limit value



Ant. Pol.	Vertical
Test Mode:	TX G Mode 2462MHz
Remark:	No report for the emission which more than 10 dB below the prescribed limit.

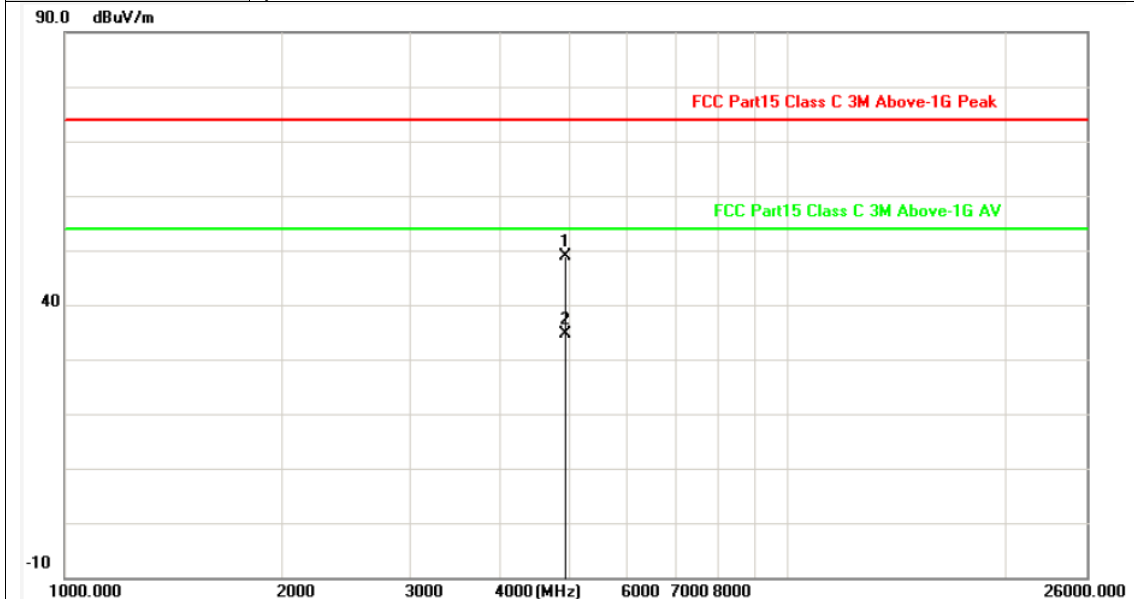

No.	Frequency (MHz)	Factor (dB/m)	Reading (dBuV)	Level (dBuV/m)	Limit (dBuV/m)	Margin (dB)	Detector
1	4924.001	5.23	43.61	48.84	74.00	-25.16	peak
2	4923.998	5.23	29.45	34.68	54.00	-19.32	AVG

Remarks:

- Factor (dB/m) = Antenna Factor (dB/m)+Cable Factor (dB)-Pre-amplifier Factor
- Margin value = Level -Limit value



Ant. Pol.	Horizontal
Test Mode:	TX N20 Mode 2412MHz
Remark:	No report for the emission which more than 10 dB below the prescribed limit.

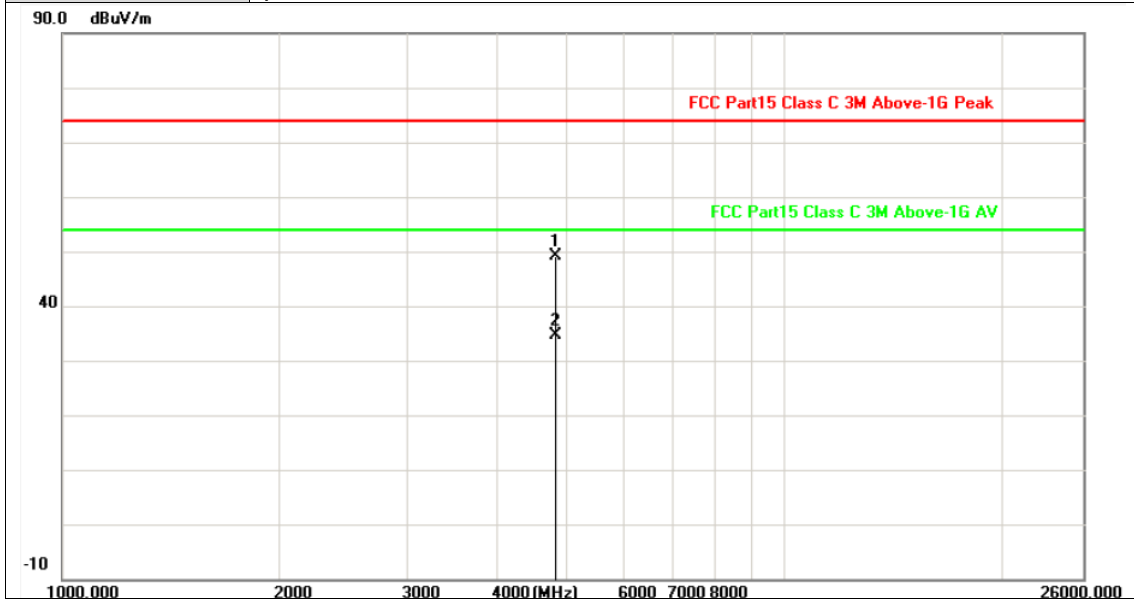

No.	Frequency (MHz)	Factor (dB/m)	Reading (dBuV)	Level (dBuV/m)	Limit (dBuV/m)	Margin (dB)	Detector
1	4823.995	5.16	44.08	49.24	74.00	-24.76	peak
2	4823.995	5.16	29.58	34.74	54.00	-19.26	AVG

Remarks:
 1. Factor (dB/m) = Antenna Factor (dB/m)+Cable Factor (dB)-Pre-amplifier Factor
 2. Margin value = Level -Limit value



Ant. Pol.	Vertical
Test Mode:	TX N20 Mode 2412MHz
Remark:	No report for the emission which more than 10 dB below the prescribed limit.

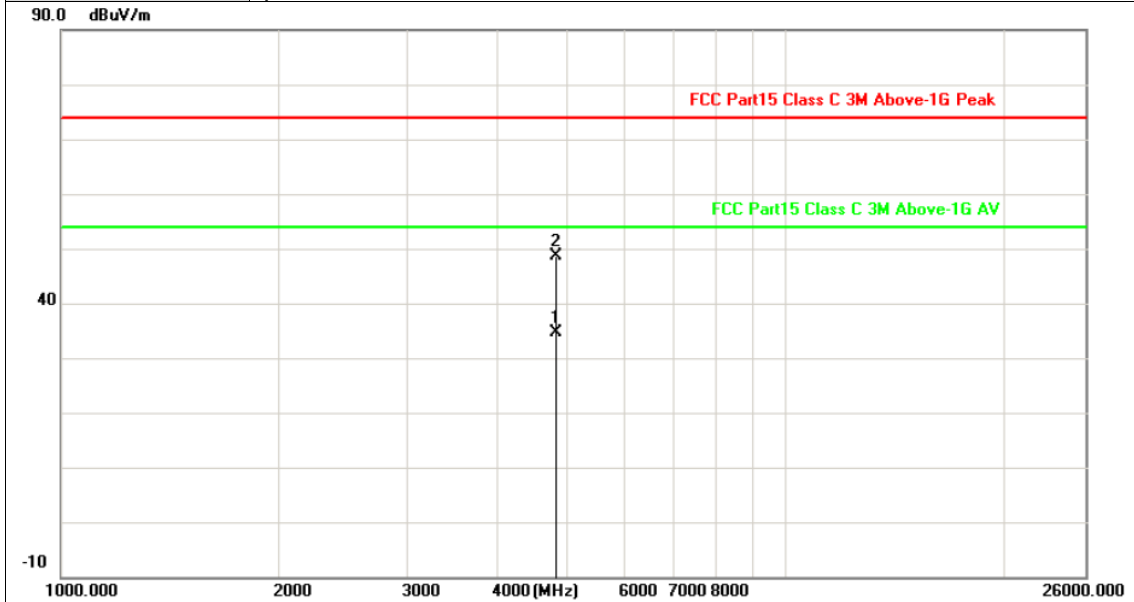

No.	Frequency (MHz)	Factor (dB/m)	Reading (dBuV)	Level (dBuV/m)	Limit (dBuV/m)	Margin (dB)	Detector
1	4824.005	5.16	29.58	34.74	54.00	-19.26	AVG
2	4824.004	5.16	43.59	48.75	74.00	-25.25	peak

Remarks:
 1. Factor (dB/m) = Antenna Factor (dB/m)+Cable Factor (dB)-Pre-amplifier Factor
 2. Margin value = Level -Limit value



Ant. Pol.	Horizontal
Test Mode:	TX N20 Mode 2437MHz
Remark:	No report for the emission which more than 10 dB below the prescribed limit.

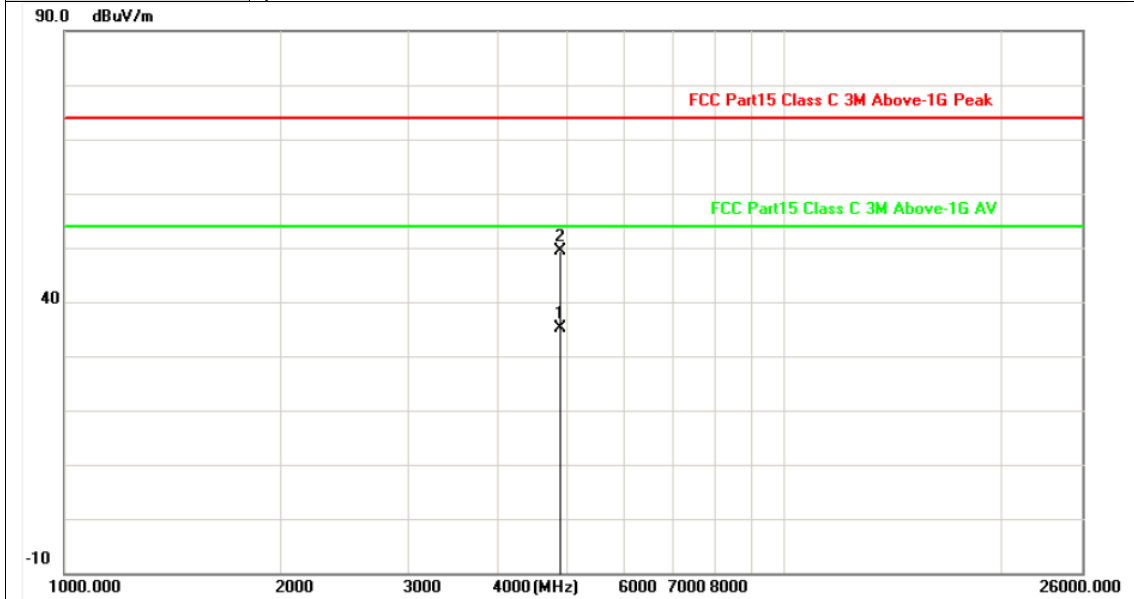

No.	Frequency (MHz)	Factor (dB/m)	Reading (dBuV)	Level (dBuV/m)	Limit (dBuV/m)	Margin (dB)	Detector
1	4873.995	5.20	29.91	35.11	54.00	-18.89	AVG
2	4874.001	5.20	44.28	49.48	74.00	-24.52	peak

Remarks:
 1. Factor (dB/m) = Antenna Factor (dB/m)+Cable Factor (dB)-Pre-amplifier Factor
 2. Margin value = Level -Limit value



Ant. Pol.	Vertical
Test Mode:	TX N20 Mode 2437MHz
Remark:	No report for the emission which more than 10 dB below the prescribed limit.

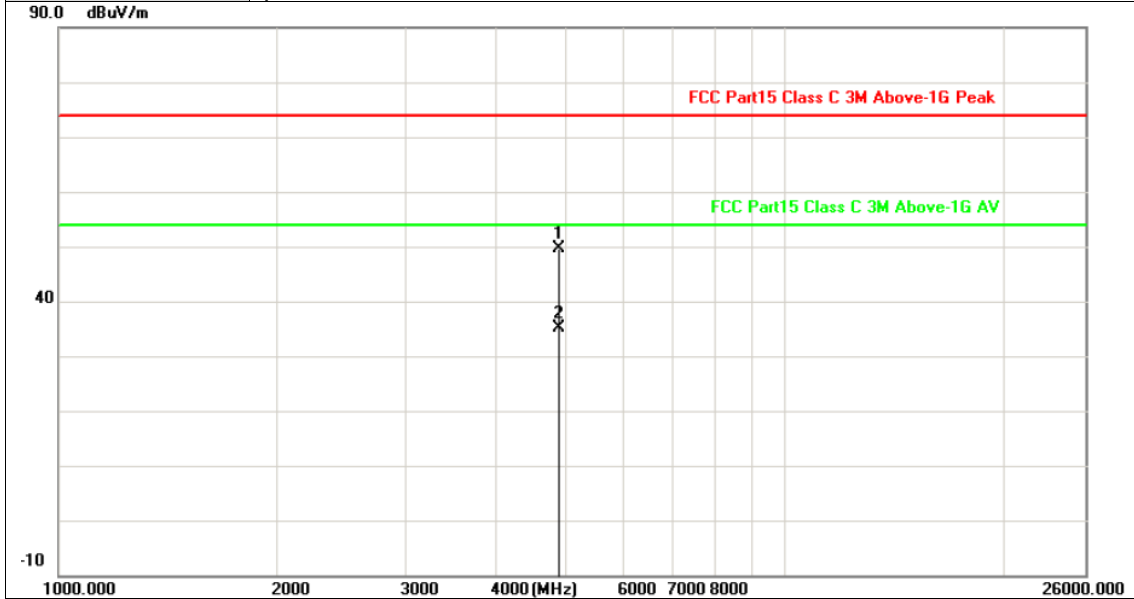

No.	Frequency (MHz)	Factor (dB/m)	Reading (dBuV)	Level (dBuV/m)	Limit (dBuV/m)	Margin (dB)	Detector
1	4874.004	5.20	44.36	49.56	74.00	-24.44	peak
2	4873.998	5.20	29.94	35.14	54.00	-18.86	AVG

Remarks:
 1. Factor (dB/m) = Antenna Factor (dB/m)+Cable Factor (dB)-Pre-amplifier Factor
 2. Margin value = Level -Limit value



Ant. Pol.	Horizontal
Test Mode:	TX N20 Mode 2462MHz
Remark:	No report for the emission which more than 10 dB below the prescribed limit.

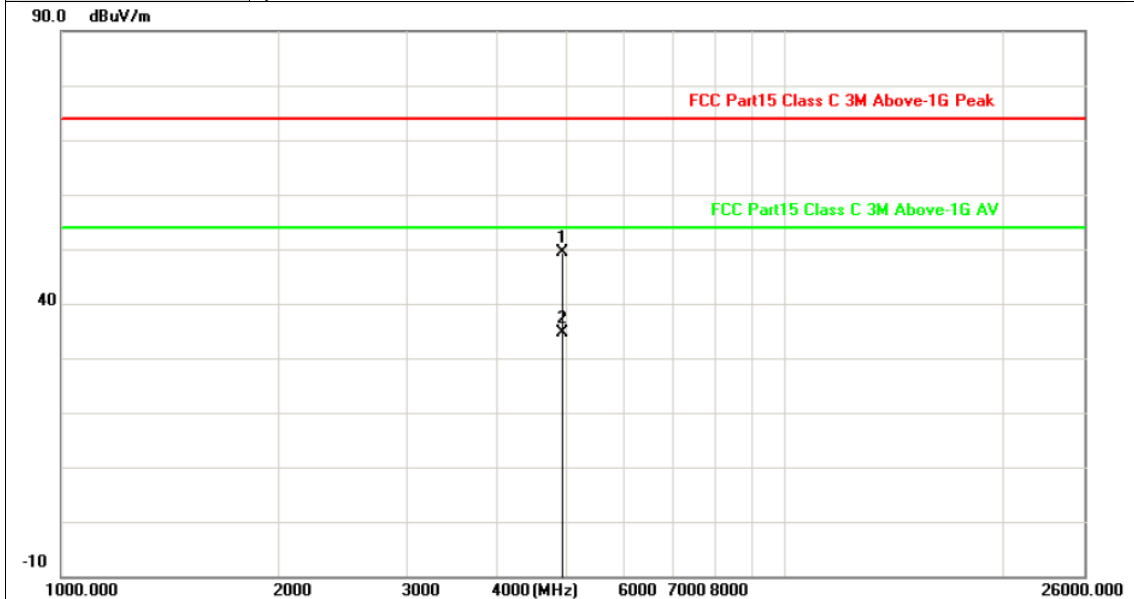

No.	Frequency (MHz)	Factor (dB/m)	Reading (dBuV)	Level (dBuV/m)	Limit (dBuV/m)	Margin (dB)	Detector
1	4924.005	5.23	44.14	49.37	74.00	-24.63	peak
2	4923.995	5.23	29.44	34.67	54.00	-19.33	AVG

Remarks:
 1. Factor (dB/m) = Antenna Factor (dB/m)+Cable Factor (dB)-Pre-amplifier Factor
 2. Margin value = Level -Limit value



Ant. Pol.	Vertical
Test Mode:	TX N20 Mode 2462MHz
Remark:	No report for the emission which more than 10 dB below the prescribed limit.

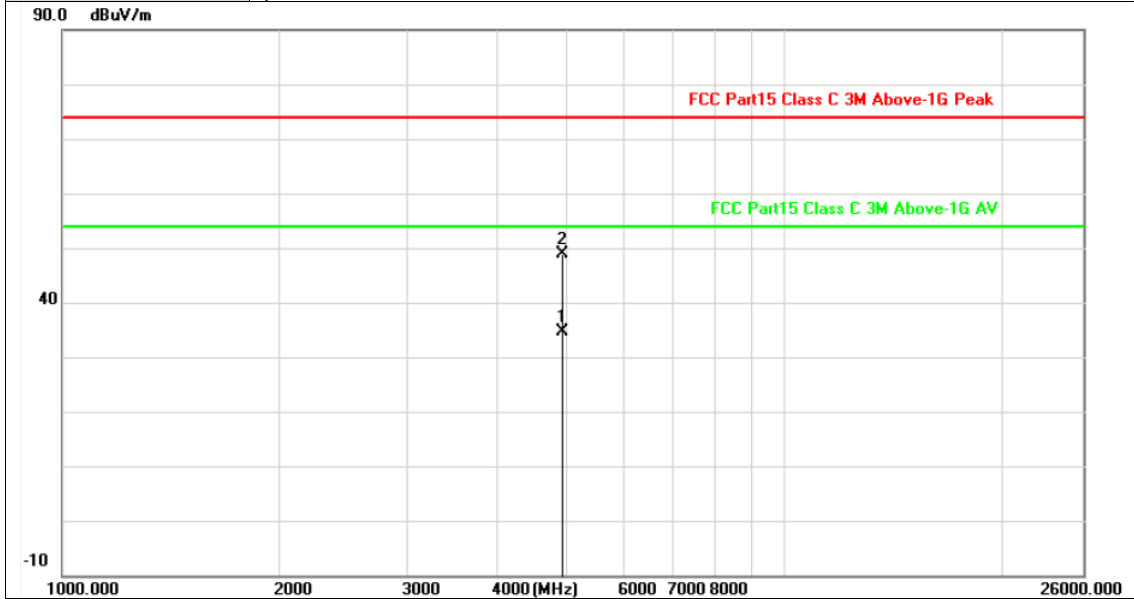

No.	Frequency (MHz)	Factor (dB/m)	Reading (dBuV)	Level (dBuV/m)	Limit (dBuV/m)	Margin (dB)	Detector
1	4923.998	5.23	29.44	34.67	54.00	-19.33	AVG
2	4924.001	5.23	43.56	48.79	74.00	-25.21	peak

Remarks:

- Factor (dB/m) = Antenna Factor (dB/m)+Cable Factor (dB)-Pre-amplifier Factor
- Margin value = Level -Limit value

3.3. Band Edge Emissions

Limit

FCC CFR Title 47 Part 15 Subpart C Section 15.247 (d)/ RSS 247 5.5:

Restricted Frequency Band (MHz)	(dBuV/m)(at 3m)	
	Peak	Average
2310 ~2390	74	54
2483.5 ~2500	74	54

Conducted band edge limit: The highest point of the operating frequency waveform down 20dB

Test Configuration

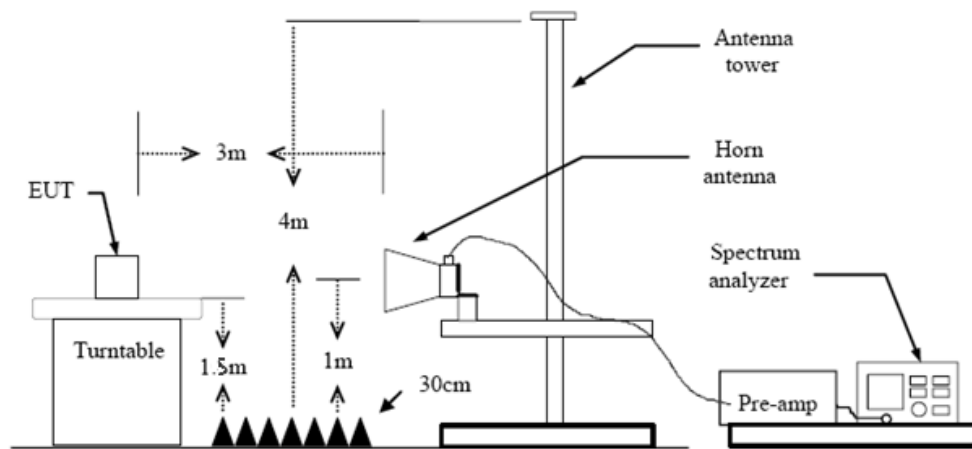

Test Procedure

1. The EUT was setup and tested according to ANSI C63.10:2013 requirements.
2. The EUT is placed on a turn table which is 1.5 meter above ground. The turn table is rotated 360 degrees to determine the position of the maximum emission level.
3. The EUT was positioned such that the distance from antenna to the EUT was 3 meters.
4. The antenna is scanned from 1 meter to 4 meters to find out the maximum emission level. This is repeated for both horizontal and vertical polarization of the antenna. In order to find the maximum emission, all of the interface cables were manipulated according to ANSI C63.10:2013 on radiated measurement.
5. The receiver set as follow:
 RBW=1MHz, VBW=3MHz Peak detector for Peak value.
 RBW=1MHz, VBW see note 1 with Peak Detector for Average Value.

Note 1: For measurements above 1 GHz the resolution bandwidth is set to 1 MHz, then the video bandwidth is set to 3 MHz for peak measurements and 1 MHz resolution bandwidth with 1/T video bandwidth with peak detector for average measurements. For the Duty Cycle please refer to clause 3.7 Duty Cycle.

2: Duty Cycle > 98%, VBW=10Hz.

Test Mode

Please refer to the clause 2.4.



Test Results

(1) Radiation Test

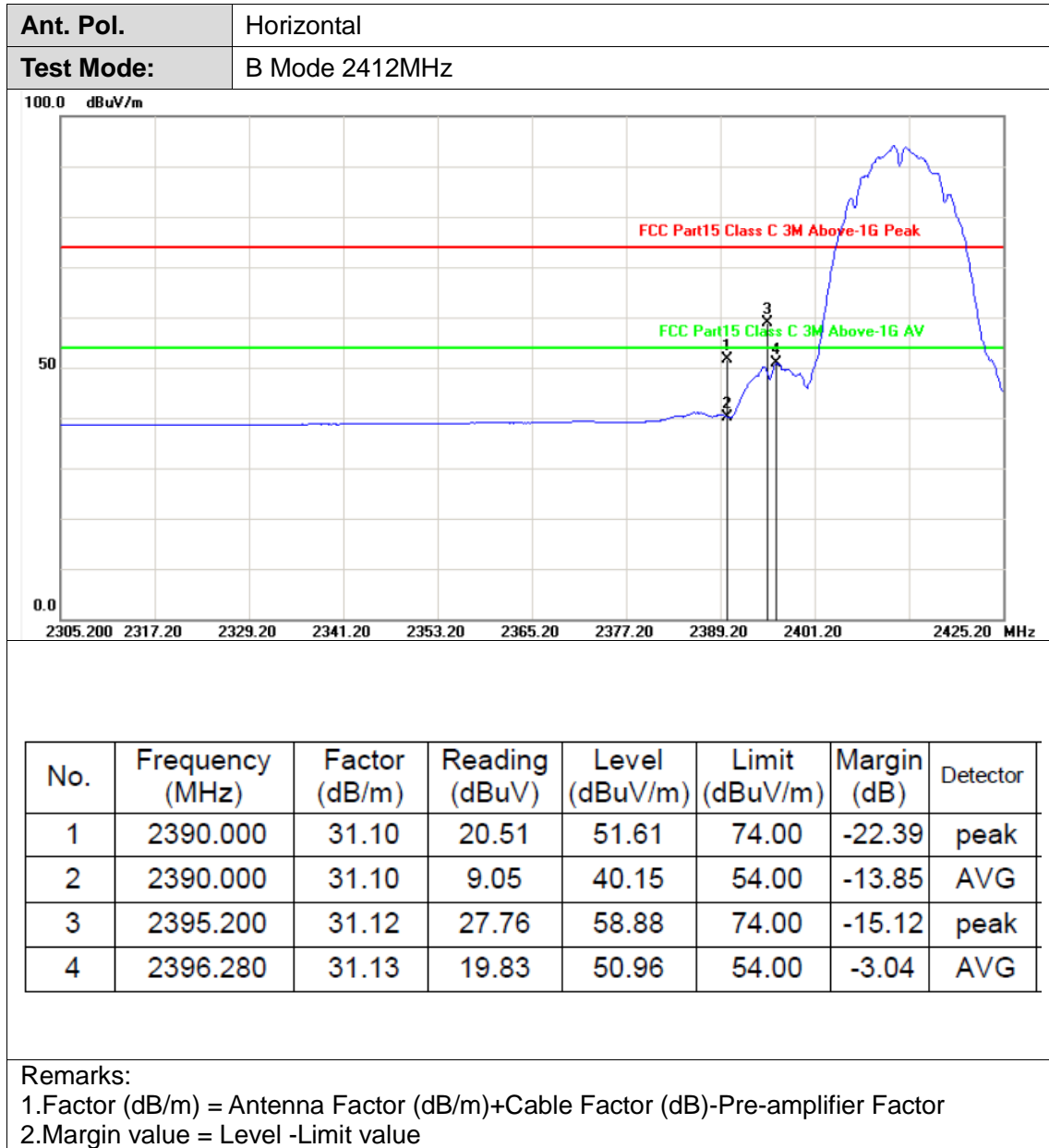

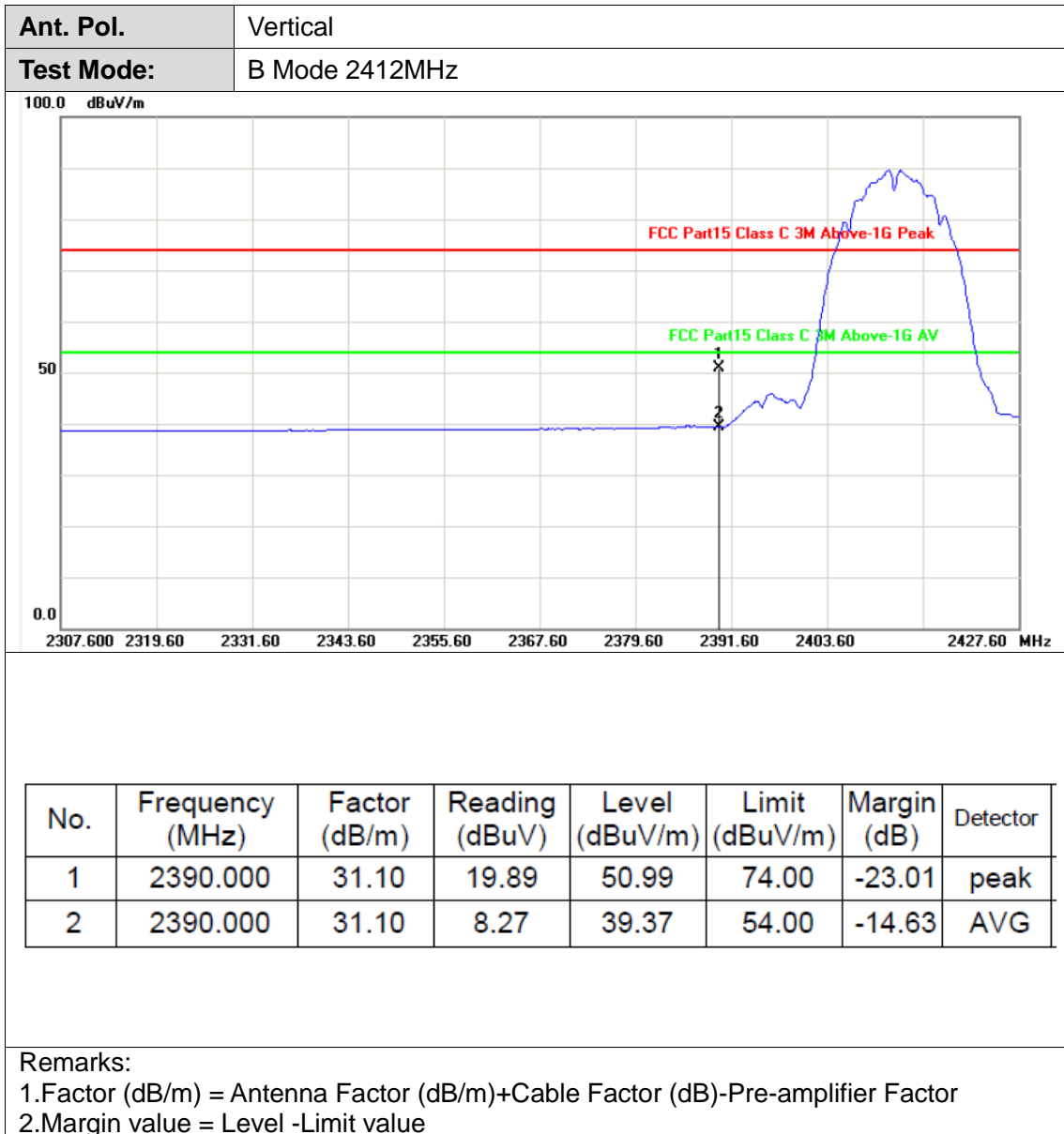



Ant. Pol.	Horizontal
Test Mode:	B Mode 2462 MHz

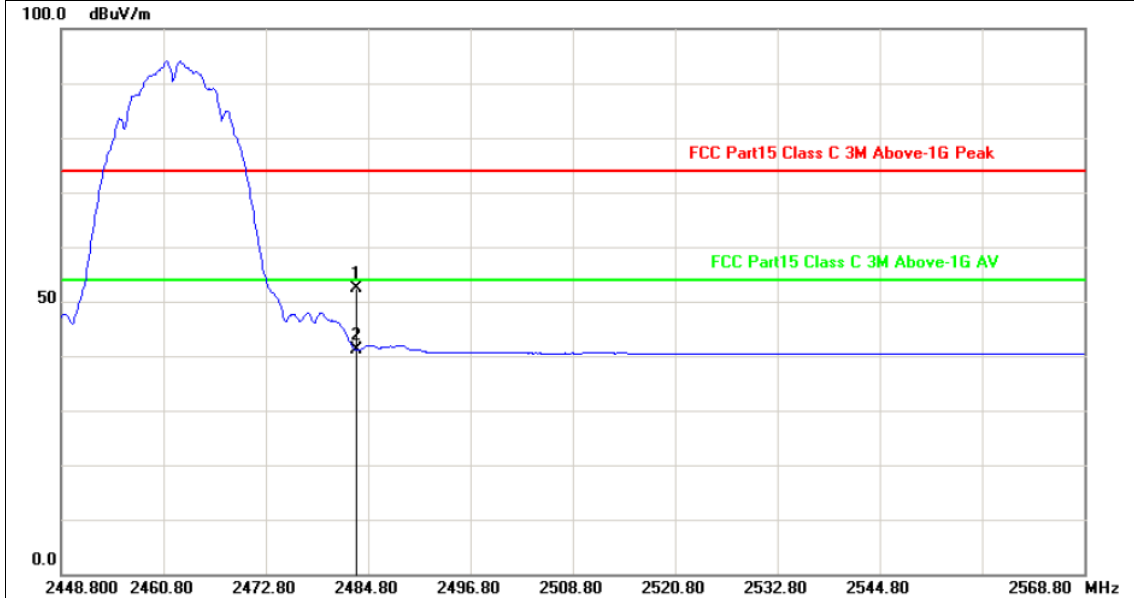

No.	Frequency (MHz)	Factor (dB/m)	Reading (dBuV)	Level (dBuV/m)	Limit (dBuV/m)	Margin (dB)	Detector
1	2483.500	31.50	20.93	52.43	74.00	-21.57	peak
2	2483.500	31.50	9.56	41.06	54.00	-12.94	AVG

Remarks:

- 1. Factor (dB/m) = Antenna Factor (dB/m)+Cable Factor (dB)-Pre-amplifier Factor
- 2. Margin value = Level -Limit value



Ant. Pol.	Vertical
Test Mode:	B Mode 2462 MHz

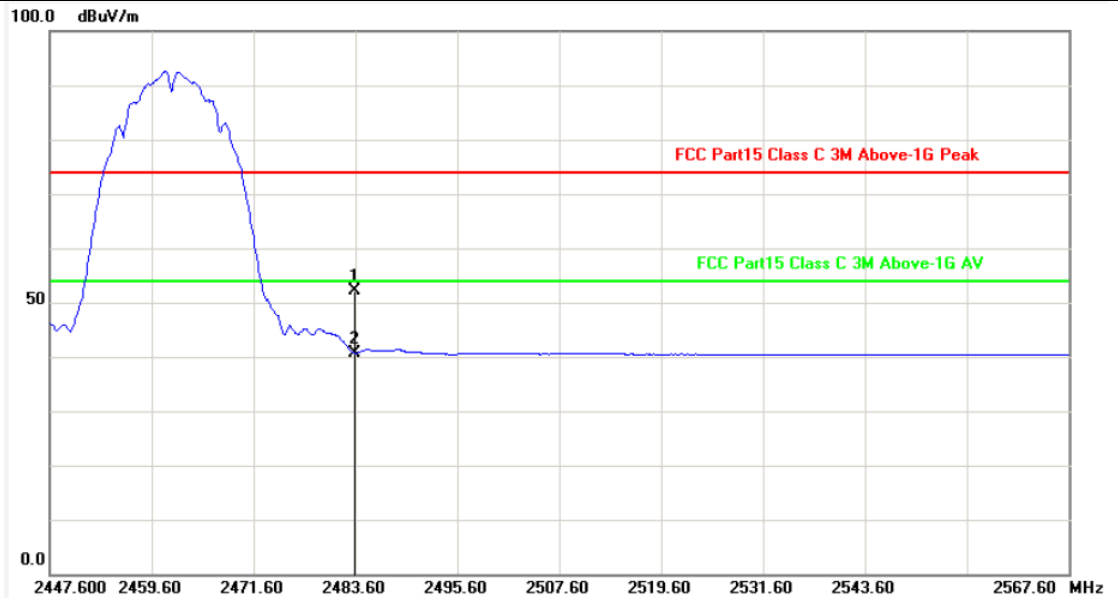

No.	Frequency (MHz)	Factor (dB/m)	Reading (dBuV)	Level (dBuV/m)	Limit (dBuV/m)	Margin (dB)	Detector
1	2483.500	31.50	20.56	52.06	74.00	-21.94	peak
2	2483.500	31.50	9.18	40.68	54.00	-13.32	AVG

Remarks:
 1. Factor (dB/m) = Antenna Factor (dB/m)+Cable Factor (dB)-Pre-amplifier Factor
 2. Margin value = Level -Limit value



Ant. Pol.	Horizontal
Test Mode:	G Mode 2412MHz

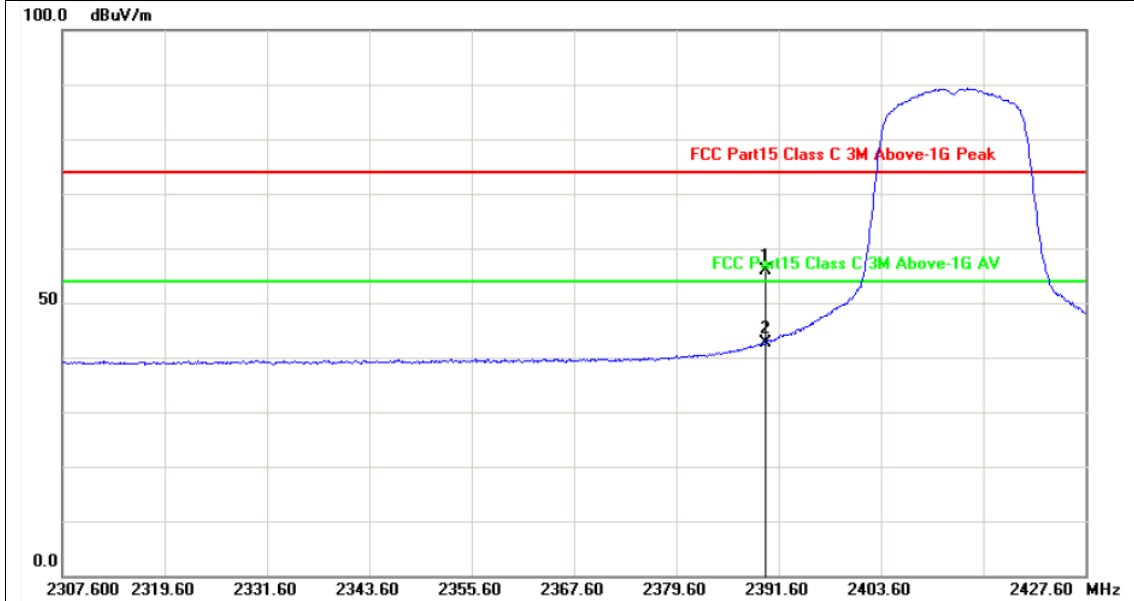

No.	Frequency (MHz)	Factor (dB/m)	Reading (dBuV)	Level (dBuV/m)	Limit (dBuV/m)	Margin (dB)	Detector
1	2390.000	31.10	24.73	55.83	74.00	-18.17	peak
2	2390.000	31.10	11.60	42.70	54.00	-11.30	AVG

Remarks:
 1. Factor (dB/m) = Antenna Factor (dB/m)+Cable Factor (dB)-Pre-amplifier Factor
 2. Margin value = Level -Limit value

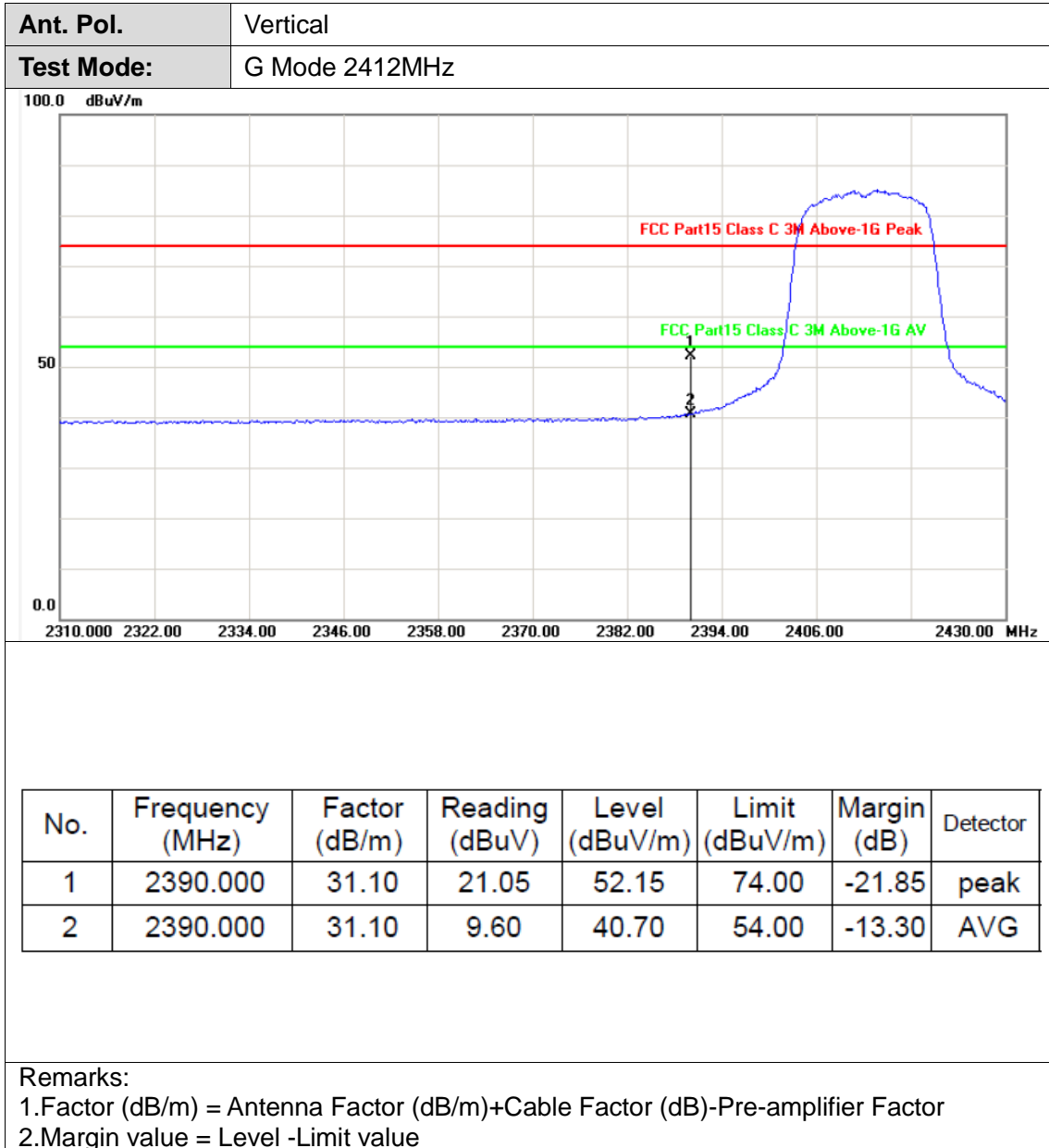



Ant. Pol.	Horizontal
Test Mode:	G Mode 2462MHz

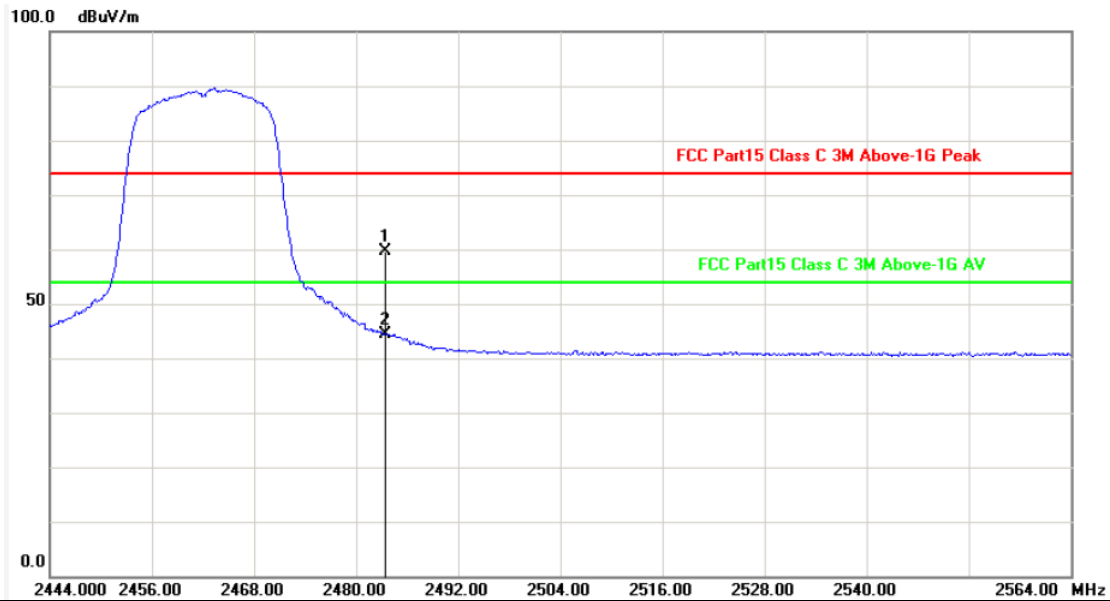

No.	Frequency (MHz)	Factor (dB/m)	Reading (dBuV)	Level (dBuV/m)	Limit (dBuV/m)	Margin (dB)	Detector
1	2483.500	31.50	28.07	59.57	74.00	-14.43	peak
2	2483.500	31.50	12.86	44.36	54.00	-9.64	AVG

Remarks:

1. Factor (dB/m) = Antenna Factor (dB/m)+Cable Factor (dB)-Pre-amplifier Factor
2. Margin value = Level -Limit value



Ant. Pol.	Vertical
Test Mode:	G Mode 2462MHz

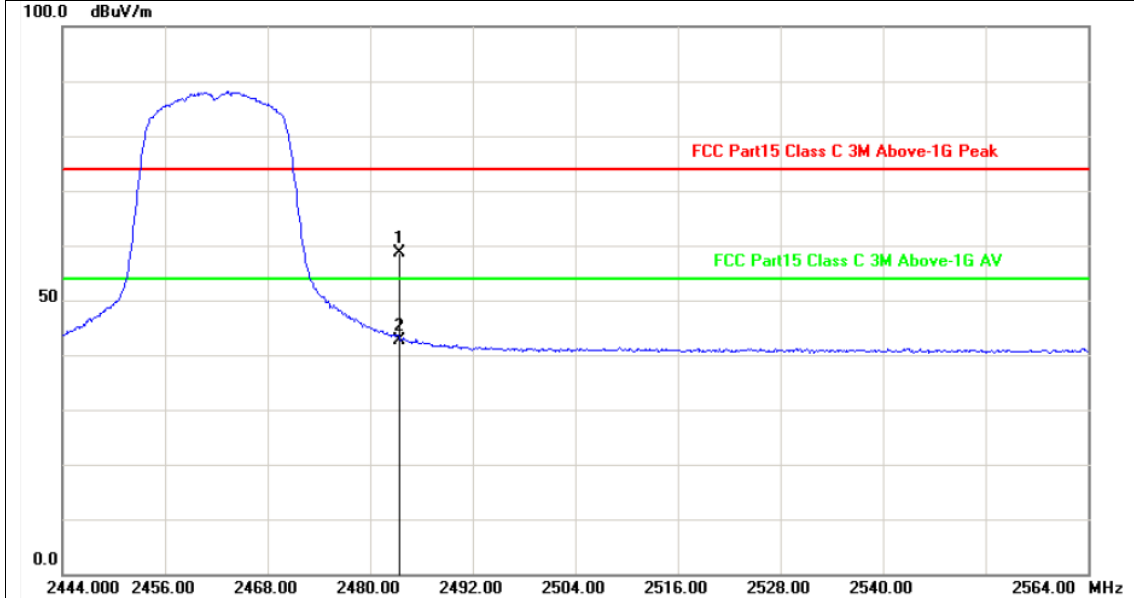

No.	Frequency (MHz)	Factor (dB/m)	Reading (dBuV)	Level (dBuV/m)	Limit (dBuV/m)	Margin (dB)	Detector
1	2483.500	31.50	27.06	58.56	74.00	-15.44	peak
2	2483.500	31.50	11.25	42.75	54.00	-11.25	AVG

Remarks:
 1. Factor (dB/m) = Antenna Factor (dB/m)+Cable Factor (dB)-Pre-amplifier Factor
 2. Margin value = Level -Limit value



Ant. Pol.	Horizontal
Test Mode:	N(HT20) Mode 2412MHz

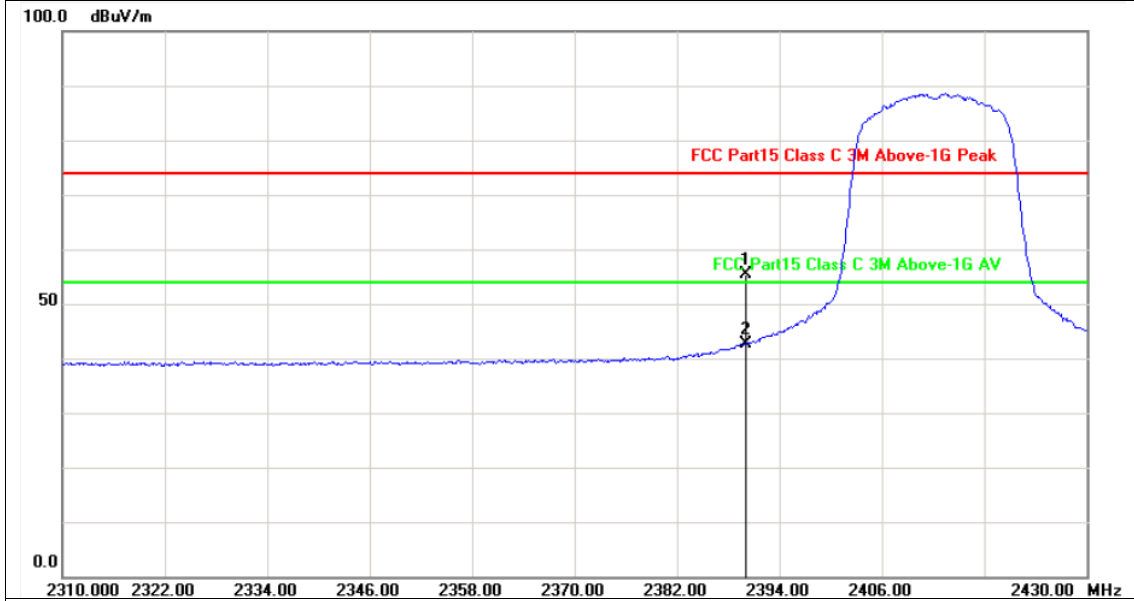

No.	Frequency (MHz)	Factor (dB/m)	Reading (dBuV)	Level (dBuV/m)	Limit (dBuV/m)	Margin (dB)	Detector
1	2390.000	31.10	24.19	55.29	74.00	-18.71	peak
2	2390.000	31.10	11.58	42.68	54.00	-11.32	AVG

Remarks:

- Factor (dB/m) = Antenna Factor (dB/m)+Cable Factor (dB)-Pre-amplifier Factor
- Margin value = Level -Limit value



Ant. Pol.	Vertical
Test Mode:	N(HT20) Mode 2412MHz

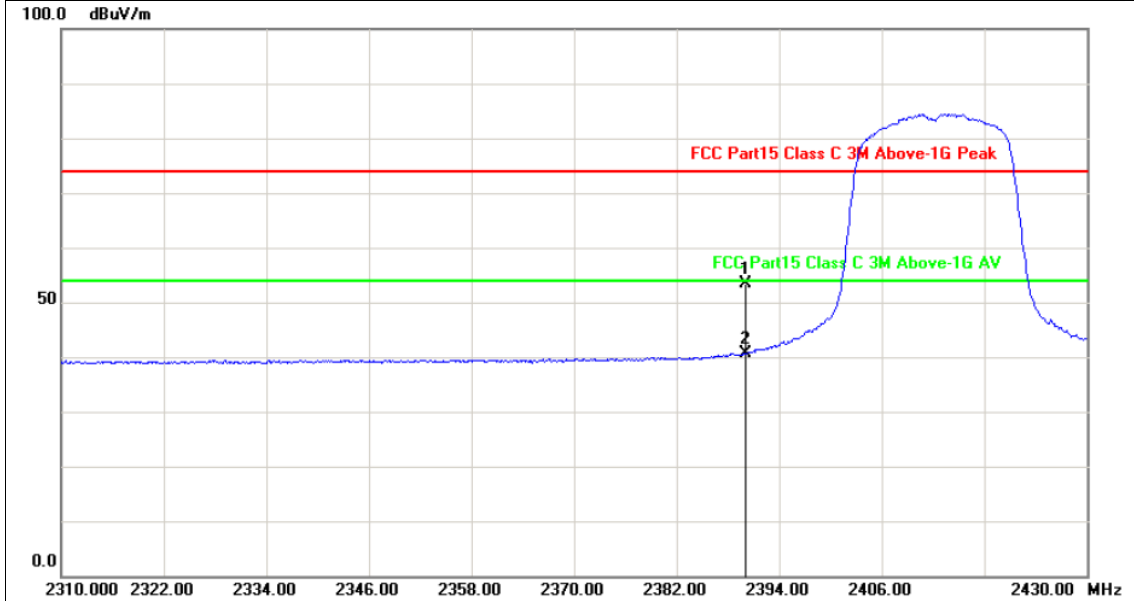

No.	Frequency (MHz)	Factor (dB/m)	Reading (dBuV)	Level (dBuV/m)	Limit (dBuV/m)	Margin (dB)	Detector
1	2390.000	31.10	22.17	53.27	74.00	-20.73	peak
2	2390.000	31.10	9.62	40.72	54.00	-13.28	AVG

Remarks:
 1. Factor (dB/m) = Antenna Factor (dB/m)+Cable Factor (dB)-Pre-amplifier Factor
 2. Margin value = Level -Limit value



Ant. Pol.	Horizontal
Test Mode:	N(HT20) Mode 2462MHz

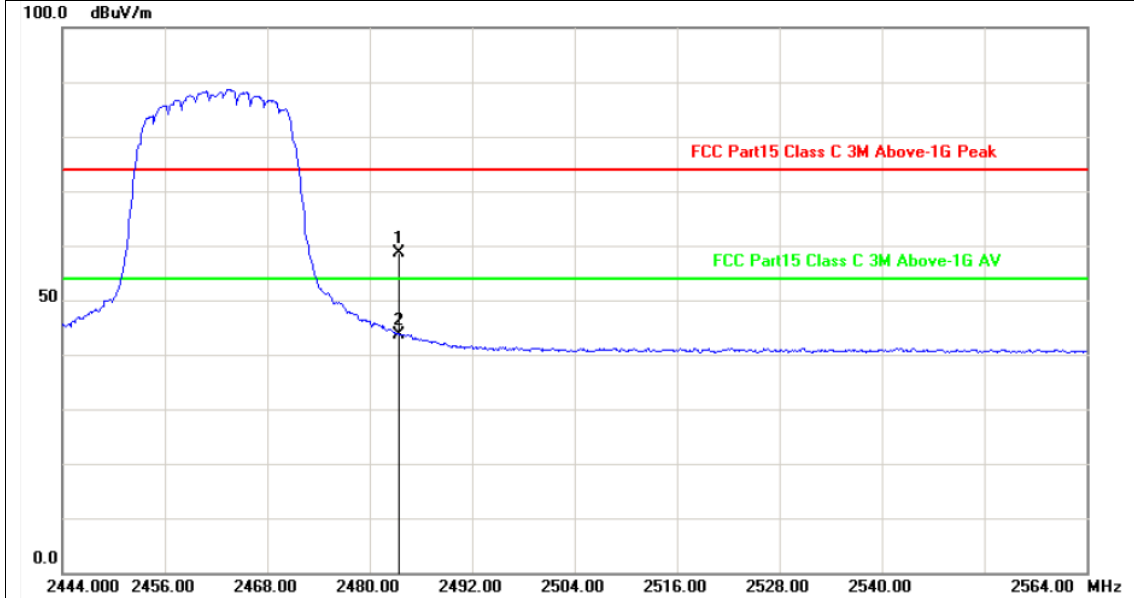

No.	Frequency (MHz)	Factor (dB/m)	Reading (dBuV)	Level (dBuV/m)	Limit (dBuV/m)	Margin (dB)	Detector
1	2483.500	31.50	27.22	58.72	74.00	-15.28	peak
2	2483.500	31.50	12.15	43.65	54.00	-10.35	AVG

Remarks:

- Factor (dB/m) = Antenna Factor (dB/m)+Cable Factor (dB)-Pre-amplifier Factor
- Margin value = Level -Limit value



Ant. Pol.	Vertical
Test Mode:	N(HT20) Mode 2462MHz

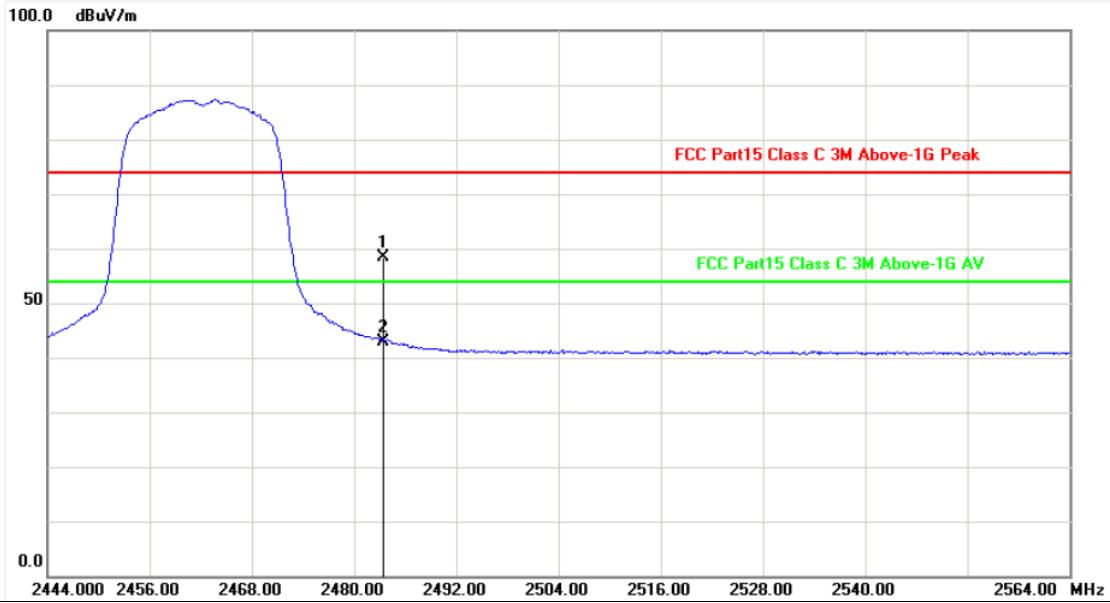

No.	Frequency (MHz)	Factor (dB/m)	Reading (dBuV)	Level (dBuV/m)	Limit (dBuV/m)	Margin (dB)	Detector
1	2483.500	31.50	26.85	58.35	74.00	-15.65	peak
2	2483.500	31.50	11.50	43.00	54.00	-11.00	AVG

Remarks:

- 1. Factor (dB/m) = Antenna Factor (dB/m)+Cable Factor (dB)-Pre-amplifier Factor
- 2. Margin value = Level -Limit value



(2) Conducted Test

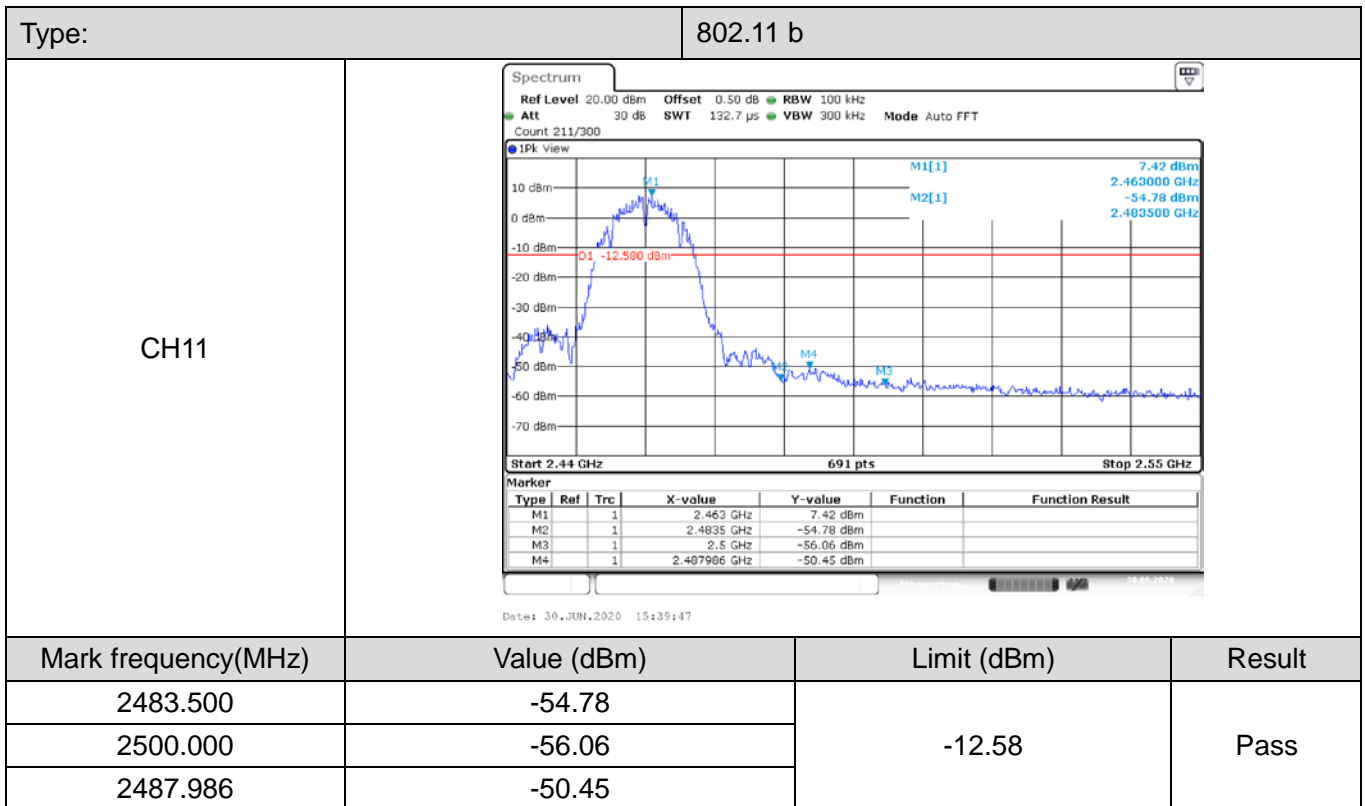
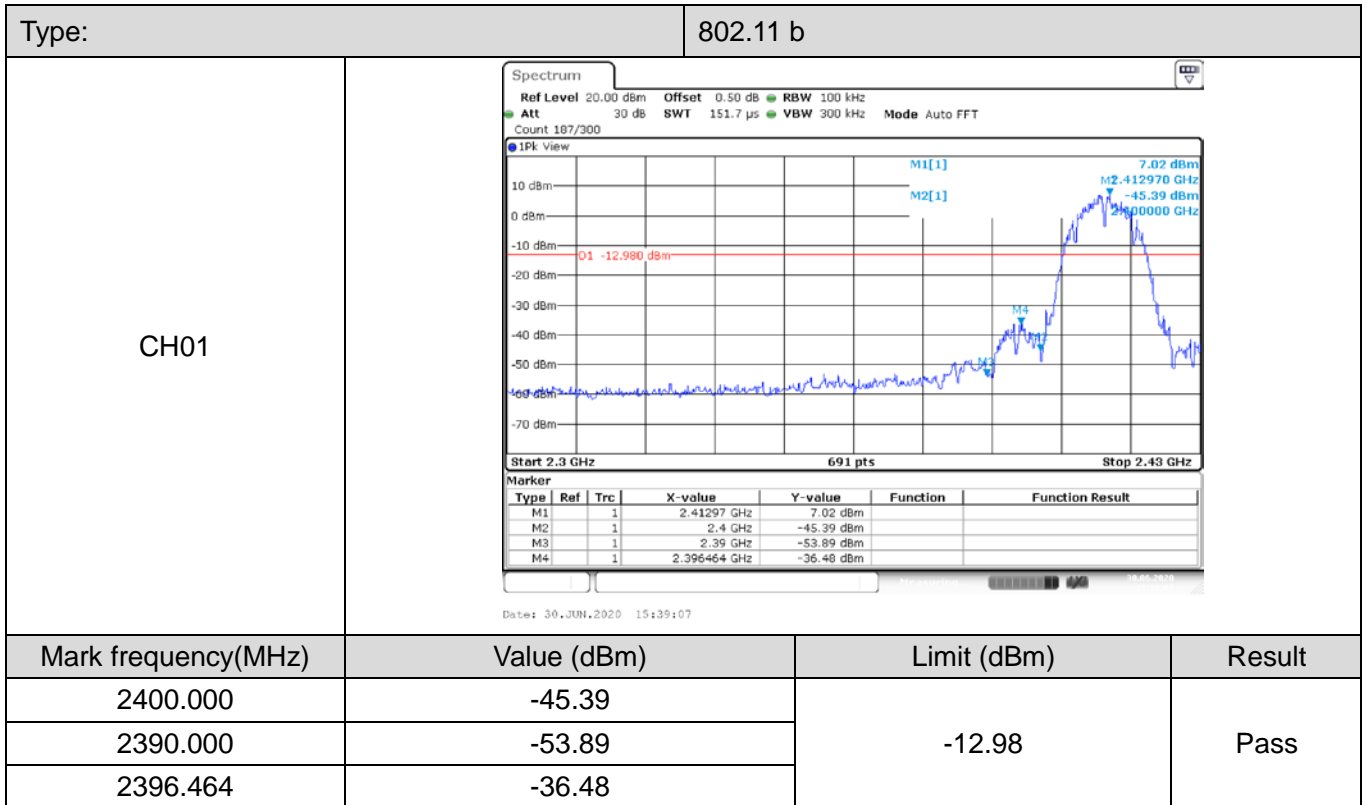

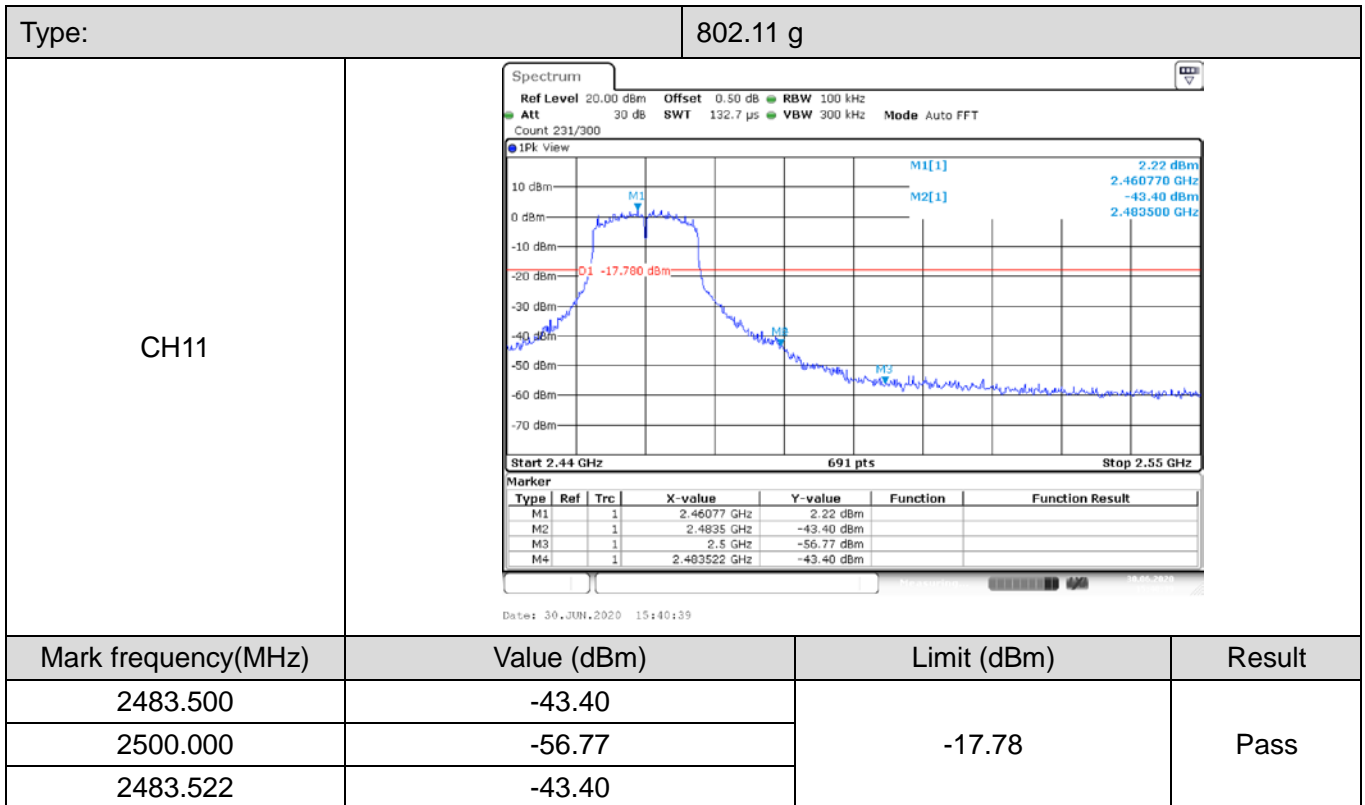
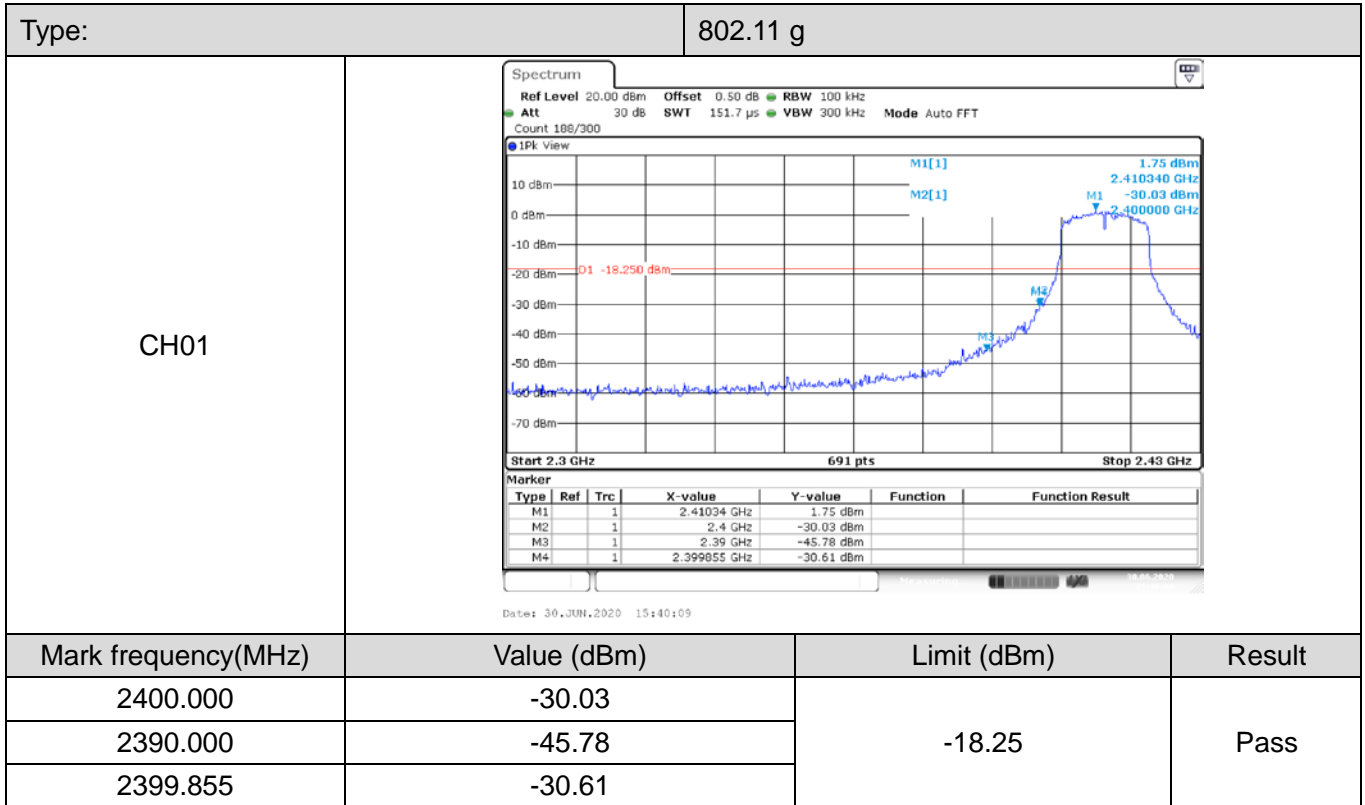

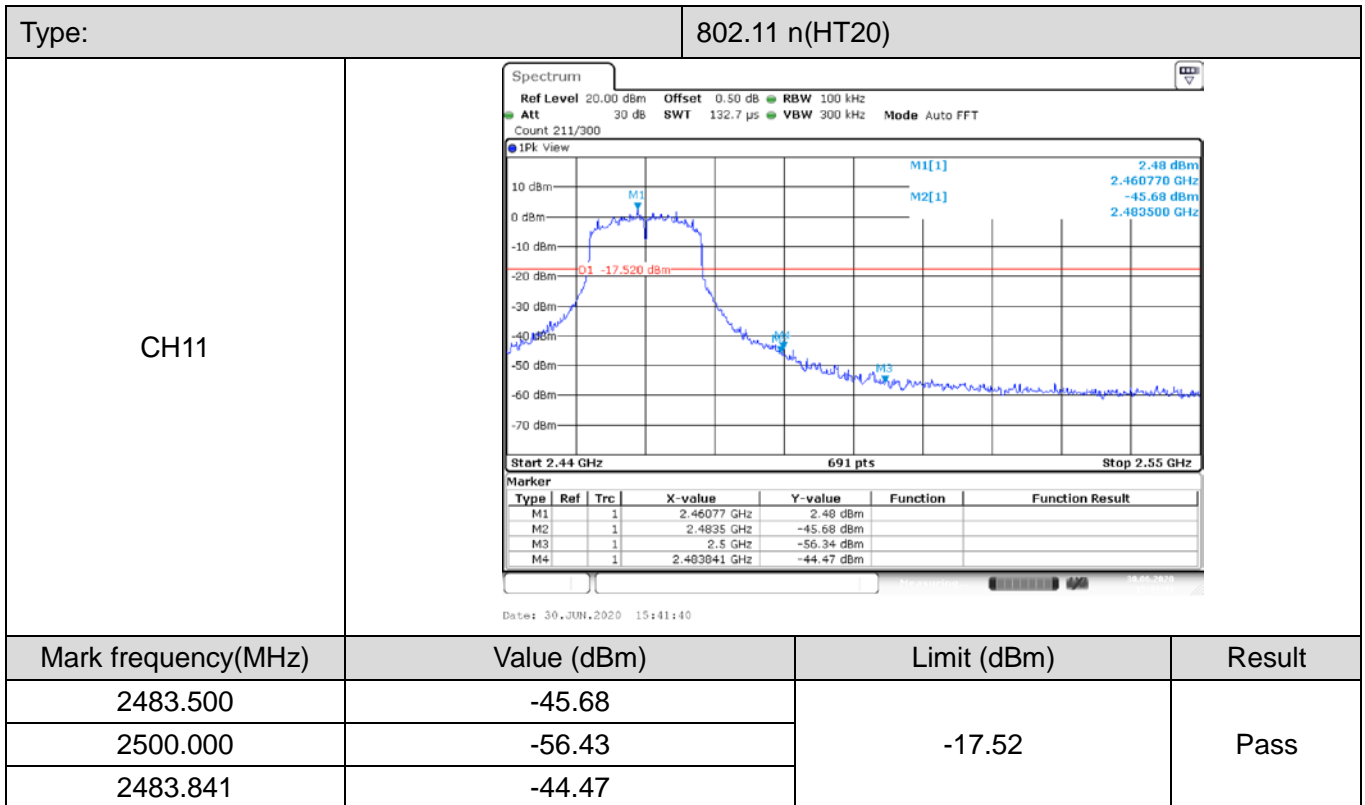
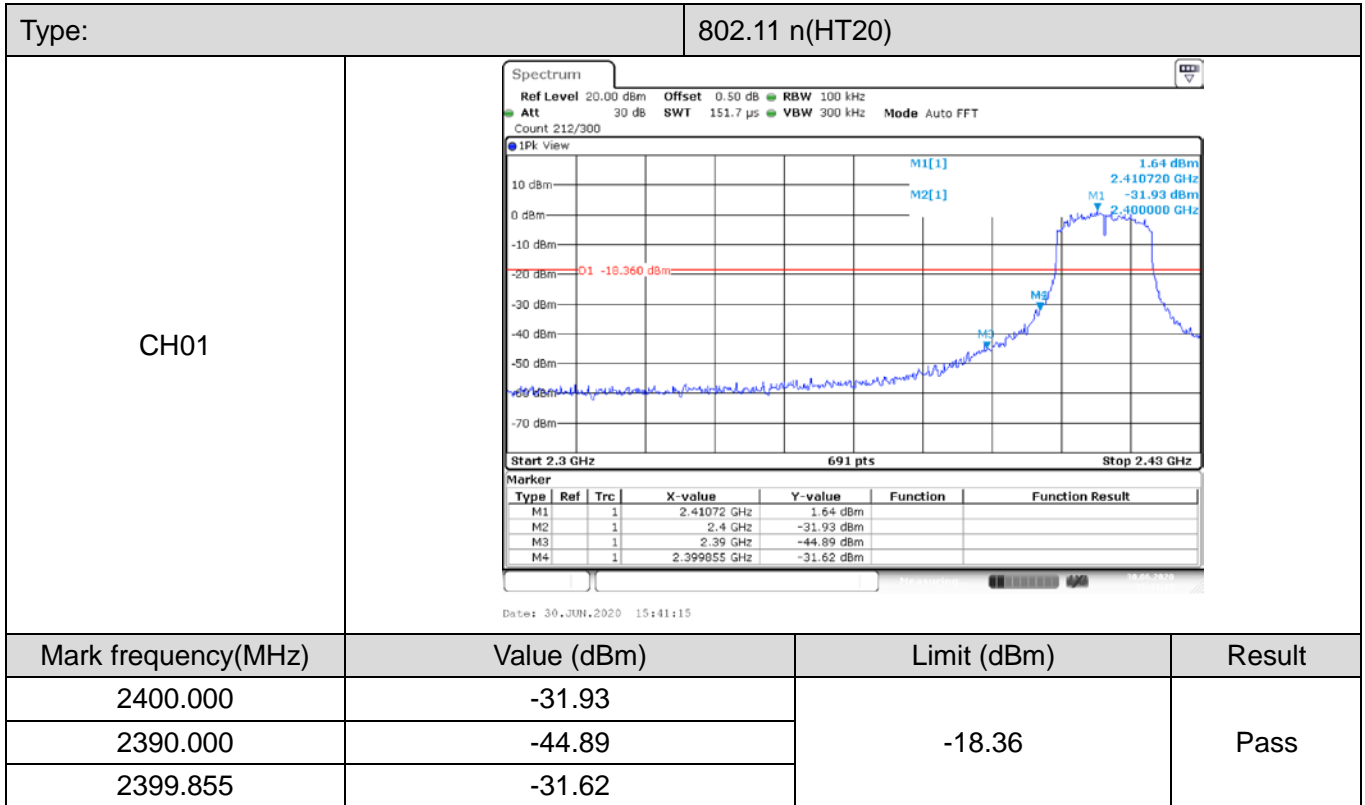

3.4. DTS Bandwidth

Limit

FCC CFR Title 47 Part 15 Subpart C Section 15.247 (a)(2)/ RSS-247 5.2 a:

Test Item	Limit	Frequency Range(MHz)
DTS Bandwidth	≥ 500 KHz (6dB bandwidth)	2400~2483.5

Test Configuration

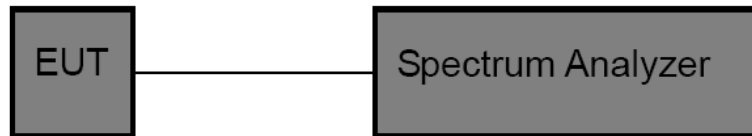

Test Procedure

1. The EUT was directly connected to the spectrum analyzer and antenna output port as show in the block diagram above.
2. DTS Spectrum Setting:
 - (1) Set RBW = 100 kHz.
 - (2) Set the video bandwidth (VBW) ≥ 3 RBW.
 - (3) Detector = Peak.
 - (4) Trace mode = Max hold.
 - (5) Sweep = Auto couple.OCB Spectrum Setting:
 - (1) Set RBW = 1% ~ 5% occupied bandwidth.
 - (2) Set the video bandwidth (VBW) ≥ 3 RBW.
 - (3) Detector = Peak.
 - (4) Trace mode = Max hold.
 - (5) Sweep = Auto couple.

NOTE: The EUT was set to continuously transmitting in each mode and low, Middle and high channel for the test.

Test Mode

Please refer to the clause 2.4.

**Test Results**

Type	Channel	6dB Bandwidth (MHz)	Limit (kHz)	Result
802.11b	01	9.120	≥500	Pass
	06	9.120		
	11	9.120		
802.11g	01	15.400	≥500	Pass
	06	15.160		
	11	15.400		
802.11n(HT20)	01	15.240	≥500	Pass
	06	15.120		
	11	15.200		



6dB Bandwidth

Type: 802.11 b

CH01

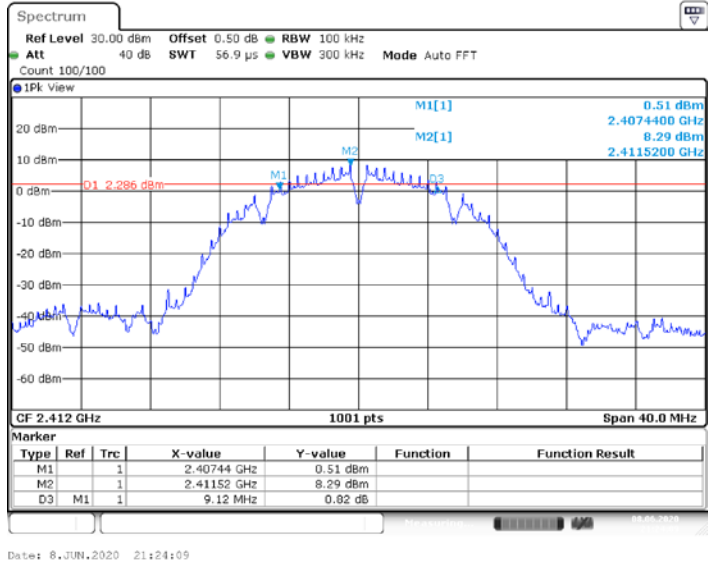

CH06

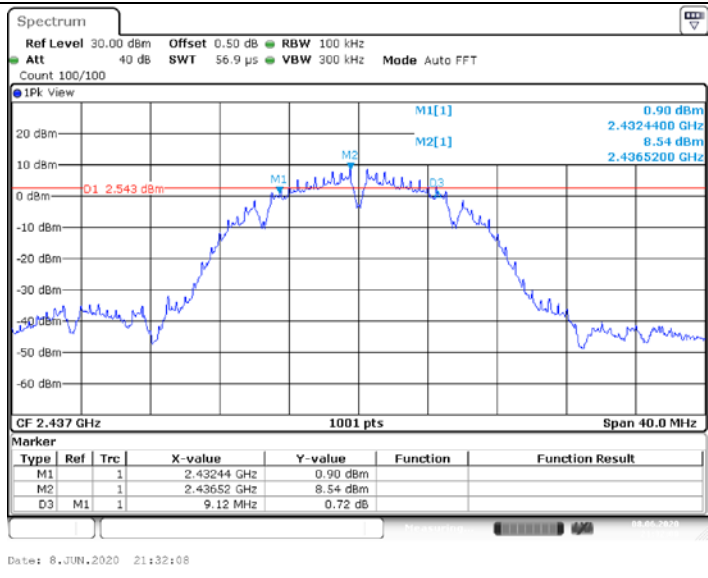

CH11

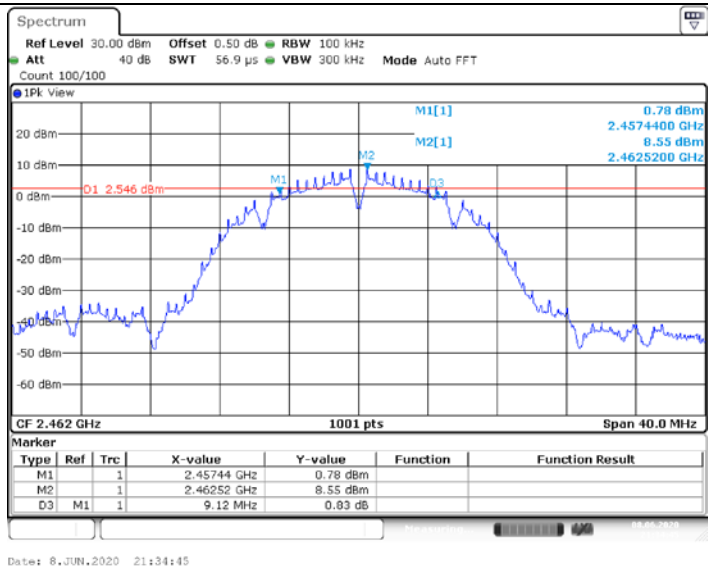

Type:	802.11 g																												
CH01	<p> Spectrum Ref Level 30.00 dBm Offset 0.50 dB RBW 100 kHz Att 40 dB SWT 56.9 μs VBW 300 kHz Mode Auto FFT Count 100/100 Mode Auto FFT IPk View M1[1] -2.29 dBm 2.4042000 GHz M2[1] 4.48 dBm 2.4132800 GHz O1 -1.516 dBm CF 2.412 GHz 1001 pts Span 40.0 MHz Marker <table border="1"> <thead> <tr> <th>Type</th> <th>Ref</th> <th>Trc</th> <th>X-value</th> <th>Y-value</th> <th>Function</th> <th>Function Result</th> </tr> </thead> <tbody> <tr> <td>M1</td> <td></td> <td>1</td> <td>2.4042 GHz</td> <td>-2.29 dBm</td> <td></td> <td></td> </tr> <tr> <td>M2</td> <td></td> <td>1</td> <td>2.41328 GHz</td> <td>4.48 dBm</td> <td></td> <td></td> </tr> <tr> <td>O3</td> <td>M1</td> <td>1</td> <td>15.4 MHz</td> <td>-0.02 dB</td> <td></td> <td></td> </tr> </tbody> </table> </p>	Type	Ref	Trc	X-value	Y-value	Function	Function Result	M1		1	2.4042 GHz	-2.29 dBm			M2		1	2.41328 GHz	4.48 dBm			O3	M1	1	15.4 MHz	-0.02 dB		
Type	Ref	Trc	X-value	Y-value	Function	Function Result																							
M1		1	2.4042 GHz	-2.29 dBm																									
M2		1	2.41328 GHz	4.48 dBm																									
O3	M1	1	15.4 MHz	-0.02 dB																									
CH06	<p> Spectrum Ref Level 30.00 dBm Offset 0.50 dB RBW 100 kHz Att 40 dB SWT 56.9 μs VBW 300 kHz Mode Auto FFT Count 100/100 Mode Auto FFT IPk View M1[1] -1.73 dBm 2.4294400 GHz M2[1] 4.54 dBm 2.4382800 GHz O1 -1.459 dBm CF 2.437 GHz 1001 pts Span 40.0 MHz Marker <table border="1"> <thead> <tr> <th>Type</th> <th>Ref</th> <th>Trc</th> <th>X-value</th> <th>Y-value</th> <th>Function</th> <th>Function Result</th> </tr> </thead> <tbody> <tr> <td>M1</td> <td></td> <td>1</td> <td>2.42944 GHz</td> <td>-1.73 dBm</td> <td></td> <td></td> </tr> <tr> <td>M2</td> <td></td> <td>1</td> <td>2.43828 GHz</td> <td>4.54 dBm</td> <td></td> <td></td> </tr> <tr> <td>O3</td> <td>M1</td> <td>1</td> <td>15.16 MHz</td> <td>-0.01 dB</td> <td></td> <td></td> </tr> </tbody> </table> </p>	Type	Ref	Trc	X-value	Y-value	Function	Function Result	M1		1	2.42944 GHz	-1.73 dBm			M2		1	2.43828 GHz	4.54 dBm			O3	M1	1	15.16 MHz	-0.01 dB		
Type	Ref	Trc	X-value	Y-value	Function	Function Result																							
M1		1	2.42944 GHz	-1.73 dBm																									
M2		1	2.43828 GHz	4.54 dBm																									
O3	M1	1	15.16 MHz	-0.01 dB																									
CH11	<p> Spectrum Ref Level 30.00 dBm Offset 0.50 dB RBW 100 kHz Att 40 dB SWT 56.9 μs VBW 300 kHz Mode Auto FFT Count 100/100 Mode Auto FFT IPk View M1[1] -2.08 dBm 2.4542000 GHz M2[1] 4.44 dBm 2.4645200 GHz O1 -1.563 dBm CF 2.462 GHz 1001 pts Span 40.0 MHz Marker <table border="1"> <thead> <tr> <th>Type</th> <th>Ref</th> <th>Trc</th> <th>X-value</th> <th>Y-value</th> <th>Function</th> <th>Function Result</th> </tr> </thead> <tbody> <tr> <td>M1</td> <td></td> <td>1</td> <td>2.4542 GHz</td> <td>-2.08 dBm</td> <td></td> <td></td> </tr> <tr> <td>M2</td> <td></td> <td>1</td> <td>2.46452 GHz</td> <td>4.44 dBm</td> <td></td> <td></td> </tr> <tr> <td>O3</td> <td>M1</td> <td>1</td> <td>15.4 MHz</td> <td>0.34 dB</td> <td></td> <td></td> </tr> </tbody> </table> </p>	Type	Ref	Trc	X-value	Y-value	Function	Function Result	M1		1	2.4542 GHz	-2.08 dBm			M2		1	2.46452 GHz	4.44 dBm			O3	M1	1	15.4 MHz	0.34 dB		
Type	Ref	Trc	X-value	Y-value	Function	Function Result																							
M1		1	2.4542 GHz	-2.08 dBm																									
M2		1	2.46452 GHz	4.44 dBm																									
O3	M1	1	15.4 MHz	0.34 dB																									

Type:		802.11n(HT20)																																
CH01	<p>Spectrum Ref Level 30.00 dBm Offset 0.50 dB RBW 100 kHz Att 40 dB SWT 56.9 μs VBW 300 kHz Mode Auto FFT Count 100/100</p> <p>IPk View</p> <table border="1"> <thead> <tr> <th>Marker</th> <th>Type</th> <th>Ref</th> <th>Trc</th> <th>X-value</th> <th>Y-value</th> <th>Function</th> <th>Function Result</th> </tr> </thead> <tbody> <tr> <td>M1</td> <td></td> <td></td> <td>1</td> <td>2.4044 GHz</td> <td>-3.76 dBm</td> <td></td> <td></td> </tr> <tr> <td>M2</td> <td></td> <td></td> <td>1</td> <td>2.41452 GHz</td> <td>3.79 dBm</td> <td></td> <td></td> </tr> <tr> <td>D3</td> <td>M1</td> <td></td> <td>1</td> <td>15.24 MHz</td> <td>0.33 dB</td> <td></td> <td></td> </tr> </tbody> </table> <p>CF 2.412 GHz 1001 pts Span 40.0 MHz Date: 8 JUN 2020 21:47:12</p>		Marker	Type	Ref	Trc	X-value	Y-value	Function	Function Result	M1			1	2.4044 GHz	-3.76 dBm			M2			1	2.41452 GHz	3.79 dBm			D3	M1		1	15.24 MHz	0.33 dB		
Marker	Type	Ref	Trc	X-value	Y-value	Function	Function Result																											
M1			1	2.4044 GHz	-3.76 dBm																													
M2			1	2.41452 GHz	3.79 dBm																													
D3	M1		1	15.24 MHz	0.33 dB																													
CH06	<p>Spectrum Ref Level 30.00 dBm Offset 0.50 dB RBW 100 kHz Att 40 dB SWT 56.9 μs VBW 300 kHz Mode Auto FFT Count 100/100</p> <p>IPk View</p> <table border="1"> <thead> <tr> <th>Marker</th> <th>Type</th> <th>Ref</th> <th>Trc</th> <th>X-value</th> <th>Y-value</th> <th>Function</th> <th>Function Result</th> </tr> </thead> <tbody> <tr> <td>M1</td> <td></td> <td></td> <td>1</td> <td>2.42948 GHz</td> <td>-2.13 dBm</td> <td></td> <td></td> </tr> <tr> <td>M2</td> <td></td> <td></td> <td>1</td> <td>2.43952 GHz</td> <td>3.89 dBm</td> <td></td> <td></td> </tr> <tr> <td>D3</td> <td>M1</td> <td></td> <td>1</td> <td>15.12 MHz</td> <td>-0.13 dB</td> <td></td> <td></td> </tr> </tbody> </table> <p>CF 2.437 GHz 1001 pts Span 40.0 MHz Date: 8 JUN 2020 21:50:12</p>		Marker	Type	Ref	Trc	X-value	Y-value	Function	Function Result	M1			1	2.42948 GHz	-2.13 dBm			M2			1	2.43952 GHz	3.89 dBm			D3	M1		1	15.12 MHz	-0.13 dB		
Marker	Type	Ref	Trc	X-value	Y-value	Function	Function Result																											
M1			1	2.42948 GHz	-2.13 dBm																													
M2			1	2.43952 GHz	3.89 dBm																													
D3	M1		1	15.12 MHz	-0.13 dB																													
CH11	<p>Spectrum Ref Level 30.00 dBm Offset 0.50 dB RBW 100 kHz Att 40 dB SWT 56.9 μs VBW 300 kHz Mode Auto FFT Count 100/100</p> <p>IPk View</p> <table border="1"> <thead> <tr> <th>Marker</th> <th>Type</th> <th>Ref</th> <th>Trc</th> <th>X-value</th> <th>Y-value</th> <th>Function</th> <th>Function Result</th> </tr> </thead> <tbody> <tr> <td>M1</td> <td></td> <td></td> <td>1</td> <td>2.45444 GHz</td> <td>-2.73 dBm</td> <td></td> <td></td> </tr> <tr> <td>M2</td> <td></td> <td></td> <td>1</td> <td>2.46328 GHz</td> <td>3.86 dBm</td> <td></td> <td></td> </tr> <tr> <td>D3</td> <td>M1</td> <td></td> <td>1</td> <td>15.2 MHz</td> <td>-0.77 dB</td> <td></td> <td></td> </tr> </tbody> </table> <p>CF 2.462 GHz 1001 pts Span 40.0 MHz Date: 8 JUN 2020 21:52:53</p>		Marker	Type	Ref	Trc	X-value	Y-value	Function	Function Result	M1			1	2.45444 GHz	-2.73 dBm			M2			1	2.46328 GHz	3.86 dBm			D3	M1		1	15.2 MHz	-0.77 dB		
Marker	Type	Ref	Trc	X-value	Y-value	Function	Function Result																											
M1			1	2.45444 GHz	-2.73 dBm																													
M2			1	2.46328 GHz	3.86 dBm																													
D3	M1		1	15.2 MHz	-0.77 dB																													

3.5. Peak Output Power

Limit

FCC CFR Title 47 Part 15 Subpart C Section 15.247 (b)(3)/ RSS-247 5.4:

Section	Test Item	Limit	Frequency Range(MHz)
CFR 47 FCC 15.247(b)(3)	Maximum conducted output power	1 Watt or 30dBm	2400~2483.5
ISED RSS-247 5.4 d	EIRP	4 Watt or 36dBm	2400~2483.5

Test Configuration

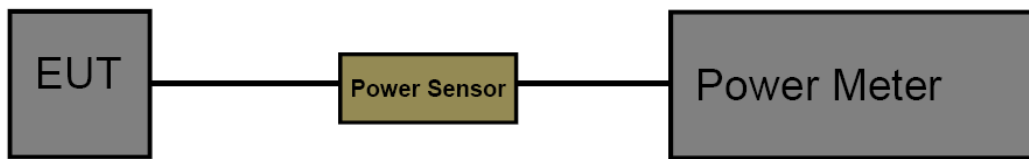

Test Procedure

1. The maximum conducted output power may be measured using a broadband Peak RF power meter.
2. Peak power measurements were performed only when the EUT was transmitting at its maximum power control level using a broadband power meter with a pulse sensor.
3. The power meter implemented triggering and gating capabilities which were set up such that power measurements were recorded only during the ON time of the transmitter.
4. Record the measurement data.

Test Mode

Please refer to the clause 2.3

Test Result



Test Mode	Channel	Result [Peak dBm]	Limit [dBm]	Verdict
802.11B	01	19.06	<=30	PASS
	06	19.18	<=30	PASS
	11	19.09	<=30	PASS
802.11G	01	23.02	<=30	PASS
	06	23.11	<=30	PASS
	11	23.16	<=30	PASS
802.11n(HT20)	01	22.34	<=30	PASS
	06	22.51	<=30	PASS
	11	22.37	<=30	PASS

Note: Test results increased RF cable loss by 0.5dB.



3.6. Power Spectral Density

Limit

FCC CFR Title 47 Part 15 Subpart C Section 15.247 (e)/ RSS-247 5.2 b:

Test Item	Limit	Frequency Range(MHz)
Power Spectral Density	8dBm(in any 3 kHz)	2400~2483.5

Test Configuration

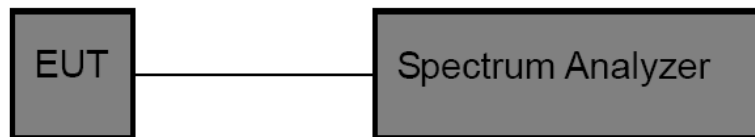

Test Procedure

1. The EUT was directly connected to the spectrum analyzer and antenna output port as show in the block diagram above.
2. The EUT was directly connected to the Spectrum Analyzer and antenna output port as show in the block diagram above. The measurement according to section 10.2 of KDB 558074 D01 DTS Meas Guidance v05r02.
3. Spectrum Setting:
 Set analyzer center frequency to DTS channel center frequency.
 Set the span to 1.5 times the DTS bandwidth.
 Set the RBW to: 3 kHz
 Set the VBW to: 10 kHz
 Detector: Peak
 Sweep time: auto
 Allow trace to fully stabilize. Then use the peak marker function to determine the maximum amplitude level.

Test Mode

Please refer to the clause 2.3

**Test Result**

Test Mode	Channel	Result [dBm/3kHz]	Limit [dBm/3kHz]	Verdict
802.11B	01	-5.95	<=8	PASS
	06	-6.06	<=8	PASS
	11	-6.38	<=8	PASS
802.11G	01	-9.44	<=8	PASS
	06	-10.11	<=8	PASS
	11	-9.83	<=8	PASS
802.11n(HT20)	01	-10.44	<=8	PASS
	06	-10.37	<=8	PASS
	11	-9.74	<=8	PASS



Type:		802.11 b
CH01		<p>Spectrum Ref Level 20.50 dBm Offset 0.50 dB RBW 3 kHz Att 30 dB SWT 3.2 ms VBW 10 kHz Mode Auto FFT Count 78/100 IPk View M1[1] -5.95 dBm 2.411301710 GHz CF 2.412 GHz 30000 pts Span 18.24 MHz Date: 30 JUN, 2020 19:26:42</p>
CH06		<p>Spectrum Ref Level 20.50 dBm Offset 0.50 dB RBW 3 kHz Att 30 dB SWT 3.2 ms VBW 10 kHz Mode Auto FFT Count 96/100 IPk View M1[1] -6.06 dBm 2.437923860 GHz CF 2.437 GHz 30000 pts Span 18.24 MHz Date: 30 JUN, 2020 19:27:04</p>
CH11		<p>Spectrum Ref Level 20.50 dBm Offset 0.50 dB RBW 3 kHz Att 30 dB SWT 3.2 ms VBW 10 kHz Mode Auto FFT Count 80/100 IPk View M1[1] -6.38 dBm 2.462893460 GHz CF 2.462 GHz 30000 pts Span 18.24 MHz Date: 30 JUN, 2020 19:27:31</p>

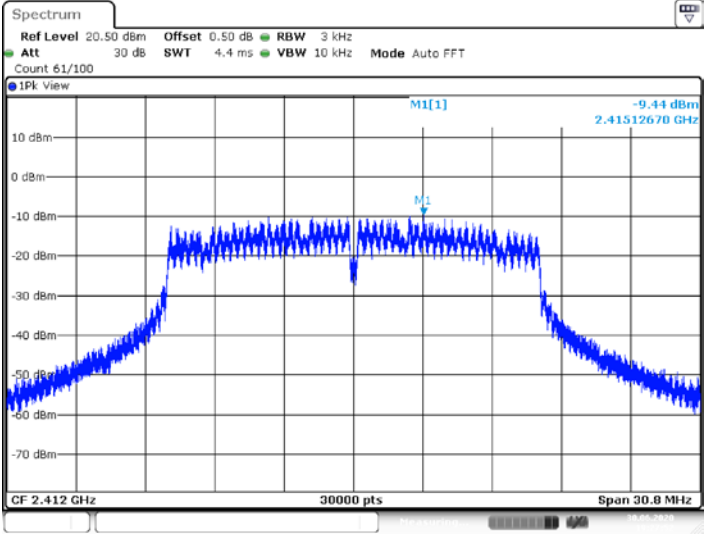
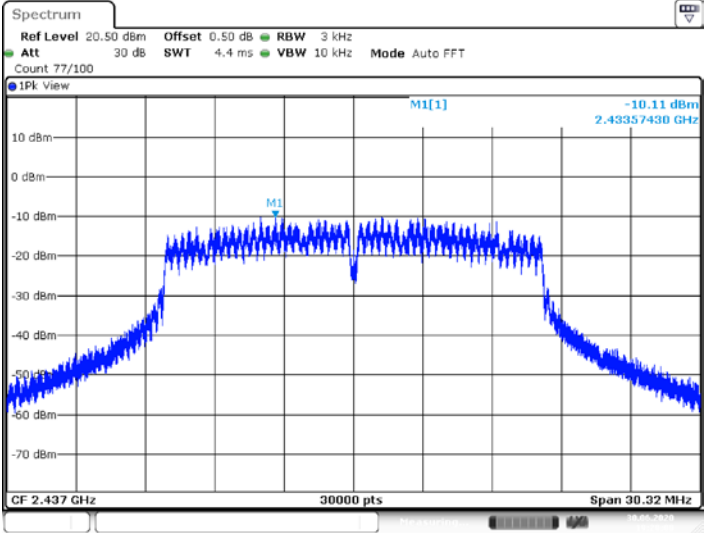
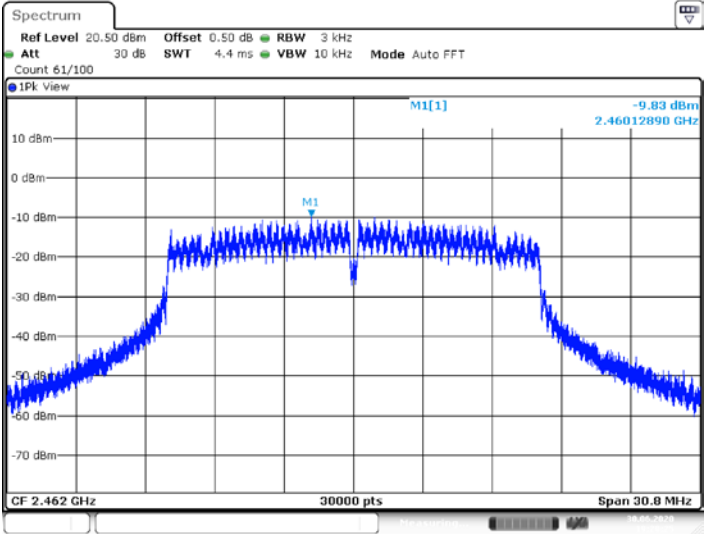

Type:		802.11 g
CH01		
CH06		
CH11		



Type:		802.11n(HT20)
CH01	<p>Spectrum Ref Level 20.50 dBm Offset 0.50 dB RBW 3 kHz Att 30 dB SWT 4.4 ms VBW 10 kHz Mode Auto FFT Count 61/100 1Pk View M1[1] -10.44 dBm 2.41046940 GHz CF 2.412 GHz 30000 pts Span 30.48 MHz Date: 30 JUN 2020 19:28:51</p>	
CH06	<p>Spectrum Ref Level 20.50 dBm Offset 0.50 dB RBW 3 kHz Att 30 dB SWT 4.4 ms VBW 10 kHz Mode Auto FFT Count 60/100 1Pk View M1[1] -10.37 dBm 2.43828270 GHz CF 2.437 GHz 30000 pts Span 30.24 MHz Date: 30 JUN 2020 19:29:07</p>	
CH11	<p>Spectrum Ref Level 20.50 dBm Offset 0.50 dB RBW 3 kHz Att 30 dB SWT 4.4 ms VBW 10 kHz Mode Auto FFT Count 61/100 1Pk View M1[1] -9.74 dBm 2.46450140 GHz CF 2.462 GHz 30000 pts Span 30.4 MHz Date: 30 JUN 2020 19:29:27</p>	

3.7. Duty Cycle

Limit

None, for report purposes only.

Test Configuration

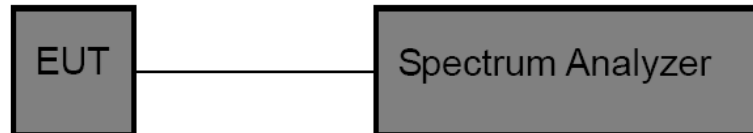

Test Procedure

1. The EUT was directly connected to the spectrum analyzer and antenna output port as show in the block diagram above.
2. The EUT was directly connected to the Spectrum Analyzer and antenna output port as show in the block diagram above. The measurement according to section 10.2 of KDB 558074 D01 DTS Meas Guidance v05r02.
3. Spectrum Setting:
Set analyzer center frequency to DTS channel center frequency.
Set the span to 0Hz
Set the RBW to 10MHz
Set the VBW to 10MHz
Detector: peak
Sweep time: auto
Allow trace to fully stabilize. Then use the peak marker function to determine the maximum amplitude level.

Test Mode

Please refer to the clause 2.3

**Test Result**

Test Mode	Channel	Transmission Duration [ms]	Transmission Period [ms]	Duty Cycle [%]	1/T Minimum VBW (kHz)	Final setting For VBW (kHz)
802.11B	01	8.39	8.43	99.50	0.12	0.01
	06	8.39	8.43	99.50	0.12	0.01
	11	8.39	8.43	99.53	0.12	0.01
802.11G	01	1.39	1.43	96.94	0.72	1
	06	1.39	1.43	96.94	0.72	1
	11	1.38	1.43	96.94	0.72	1
802.11n(HT20)	01	1.30	1.34	96.74	0.77	1
	06	1.30	1.34	96.74	0.77	1
	11	1.30	1.34	96.74	0.77	1

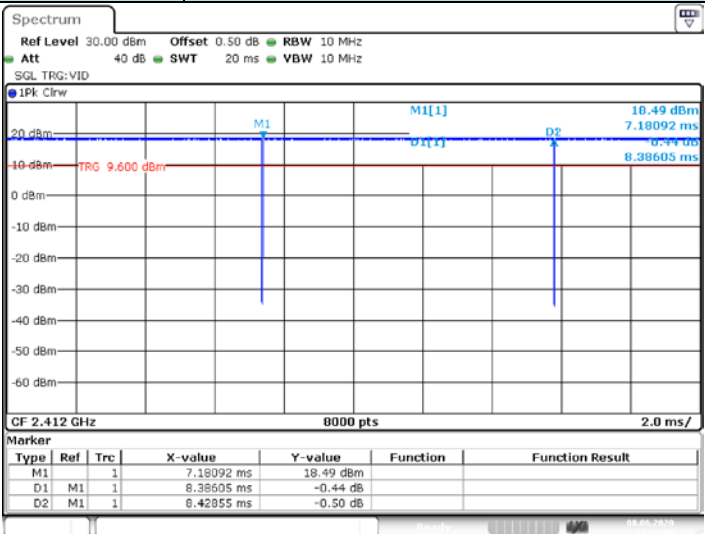
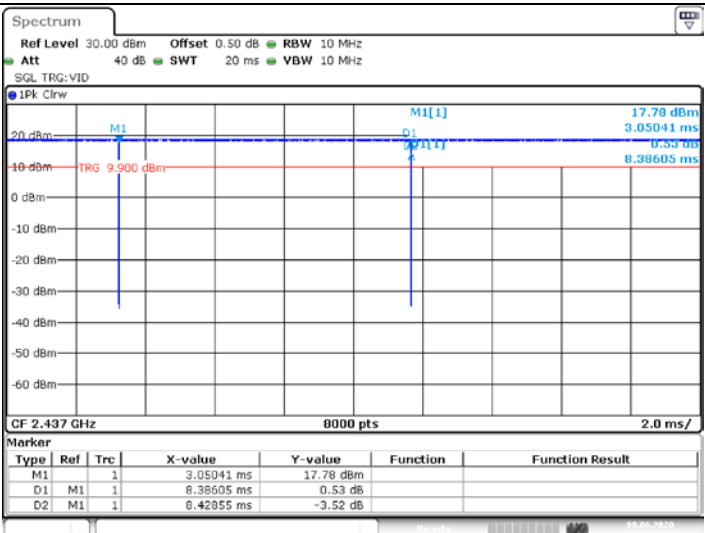
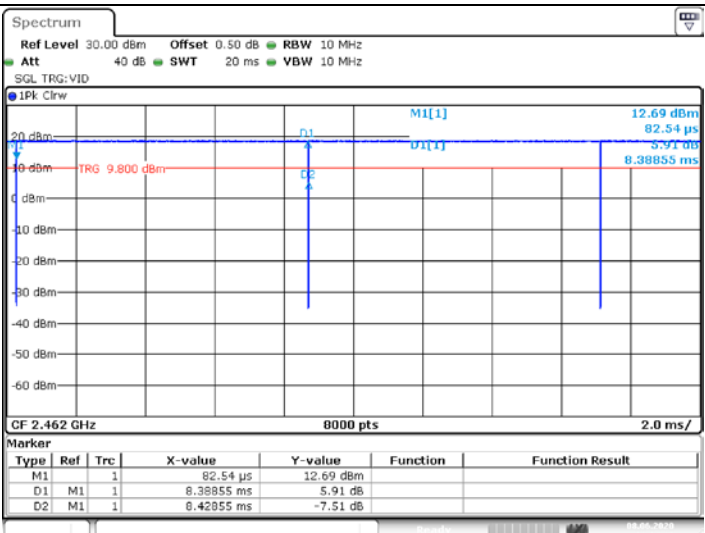

Type:	802.11 b																												
CH01	 <p>CF 2.412 GHz 8000 pts 2.0 ms/</p> <table border="1"> <thead> <tr> <th>Type</th> <th>Ref</th> <th>Trc</th> <th>X-value</th> <th>Y-value</th> <th>Function</th> <th>Function Result</th> </tr> </thead> <tbody> <tr> <td>M1</td> <td></td> <td>1</td> <td>7.18092 ms</td> <td>18.49 dBm</td> <td></td> <td></td> </tr> <tr> <td>D1</td> <td>M1</td> <td>1</td> <td>8.38605 ms</td> <td>-0.44 dB</td> <td></td> <td></td> </tr> <tr> <td>D2</td> <td>M1</td> <td>1</td> <td>8.42855 ms</td> <td>-0.50 dB</td> <td></td> <td></td> </tr> </tbody> </table> <p>Date: 8 JUN, 2020 21:23:42</p>	Type	Ref	Trc	X-value	Y-value	Function	Function Result	M1		1	7.18092 ms	18.49 dBm			D1	M1	1	8.38605 ms	-0.44 dB			D2	M1	1	8.42855 ms	-0.50 dB		
Type	Ref	Trc	X-value	Y-value	Function	Function Result																							
M1		1	7.18092 ms	18.49 dBm																									
D1	M1	1	8.38605 ms	-0.44 dB																									
D2	M1	1	8.42855 ms	-0.50 dB																									
CH06	 <p>CF 2.437 GHz 8000 pts 2.0 ms/</p> <table border="1"> <thead> <tr> <th>Type</th> <th>Ref</th> <th>Trc</th> <th>X-value</th> <th>Y-value</th> <th>Function</th> <th>Function Result</th> </tr> </thead> <tbody> <tr> <td>M1</td> <td></td> <td>1</td> <td>3.05041 ms</td> <td>17.78 dBm</td> <td></td> <td></td> </tr> <tr> <td>D1</td> <td>M1</td> <td>1</td> <td>8.38605 ms</td> <td>0.53 dB</td> <td></td> <td></td> </tr> <tr> <td>D2</td> <td>M1</td> <td>1</td> <td>8.42855 ms</td> <td>-3.52 dB</td> <td></td> <td></td> </tr> </tbody> </table> <p>Date: 8 JUN, 2020 21:31:41</p>	Type	Ref	Trc	X-value	Y-value	Function	Function Result	M1		1	3.05041 ms	17.78 dBm			D1	M1	1	8.38605 ms	0.53 dB			D2	M1	1	8.42855 ms	-3.52 dB		
Type	Ref	Trc	X-value	Y-value	Function	Function Result																							
M1		1	3.05041 ms	17.78 dBm																									
D1	M1	1	8.38605 ms	0.53 dB																									
D2	M1	1	8.42855 ms	-3.52 dB																									
CH11	 <p>CF 2.462 GHz 8000 pts 2.0 ms/</p> <table border="1"> <thead> <tr> <th>Type</th> <th>Ref</th> <th>Trc</th> <th>X-value</th> <th>Y-value</th> <th>Function</th> <th>Function Result</th> </tr> </thead> <tbody> <tr> <td>M1</td> <td></td> <td>1</td> <td>82.54 μs</td> <td>12.69 dBm</td> <td></td> <td></td> </tr> <tr> <td>D1</td> <td>M1</td> <td>1</td> <td>8.38855 ms</td> <td>5.91 dB</td> <td></td> <td></td> </tr> <tr> <td>D2</td> <td>M1</td> <td>1</td> <td>8.42855 ms</td> <td>-7.51 dB</td> <td></td> <td></td> </tr> </tbody> </table> <p>Date: 8 JUN, 2020 21:34:18</p>	Type	Ref	Trc	X-value	Y-value	Function	Function Result	M1		1	82.54 μs	12.69 dBm			D1	M1	1	8.38855 ms	5.91 dB			D2	M1	1	8.42855 ms	-7.51 dB		
Type	Ref	Trc	X-value	Y-value	Function	Function Result																							
M1		1	82.54 μs	12.69 dBm																									
D1	M1	1	8.38855 ms	5.91 dB																									
D2	M1	1	8.42855 ms	-7.51 dB																									



Type:	802.11 g																												
CH01	<p>Spectrum Ref Level 30.00 dBm Offset 0.50 dB RBW 10 MHz Att 40 dB SWT 10 ms VBW 10 MHz SQL TRG:VID</p> <p>IPk Clrw M1[1] 16.66 dBm 873.88 μs TRG 14.900 dBm 1.38517 ms</p> <p>CF 2.412 GHz 8000 pts 1.0 ms/</p> <table border="1"> <thead> <tr> <th>Type</th> <th>Ref</th> <th>Trc</th> <th>X-value</th> <th>Y-value</th> <th>Function</th> <th>Function Result</th> </tr> </thead> <tbody> <tr> <td>M1</td> <td></td> <td>1</td> <td>873.88 μs</td> <td>16.66 dBm</td> <td></td> <td></td> </tr> <tr> <td>D1</td> <td>M1</td> <td>1</td> <td>1.38517 ms</td> <td>3.28 dB</td> <td></td> <td></td> </tr> <tr> <td>D2</td> <td>M1</td> <td>1</td> <td>1.42893 ms</td> <td>-0.01 dB</td> <td></td> <td></td> </tr> </tbody> </table> <p>Date: 8 JUN 2020 21:37:13</p>	Type	Ref	Trc	X-value	Y-value	Function	Function Result	M1		1	873.88 μs	16.66 dBm			D1	M1	1	1.38517 ms	3.28 dB			D2	M1	1	1.42893 ms	-0.01 dB		
Type	Ref	Trc	X-value	Y-value	Function	Function Result																							
M1		1	873.88 μs	16.66 dBm																									
D1	M1	1	1.38517 ms	3.28 dB																									
D2	M1	1	1.42893 ms	-0.01 dB																									
CH06	<p>Spectrum Ref Level 30.00 dBm Offset 0.50 dB RBW 10 MHz Att 40 dB SWT 10 ms VBW 10 MHz SQL TRG:VID</p> <p>IPk Clrw M1[1] 16.55 dBm 95.04 μs TRG 15.900 dBm 1.38517 ms</p> <p>CF 2.437 GHz 8000 pts 1.0 ms/</p> <table border="1"> <thead> <tr> <th>Type</th> <th>Ref</th> <th>Trc</th> <th>X-value</th> <th>Y-value</th> <th>Function</th> <th>Function Result</th> </tr> </thead> <tbody> <tr> <td>M1</td> <td></td> <td>1</td> <td>95.04 μs</td> <td>16.55 dBm</td> <td></td> <td></td> </tr> <tr> <td>D1</td> <td>M1</td> <td>1</td> <td>1.38517 ms</td> <td>1.80 dB</td> <td></td> <td></td> </tr> <tr> <td>D2</td> <td>M1</td> <td>1</td> <td>1.42893 ms</td> <td>0.34 dB</td> <td></td> <td></td> </tr> </tbody> </table> <p>Date: 8 JUN 2020 21:41:29</p>	Type	Ref	Trc	X-value	Y-value	Function	Function Result	M1		1	95.04 μs	16.55 dBm			D1	M1	1	1.38517 ms	1.80 dB			D2	M1	1	1.42893 ms	0.34 dB		
Type	Ref	Trc	X-value	Y-value	Function	Function Result																							
M1		1	95.04 μs	16.55 dBm																									
D1	M1	1	1.38517 ms	1.80 dB																									
D2	M1	1	1.42893 ms	0.34 dB																									
CH11	<p>Spectrum Ref Level 30.00 dBm Offset 0.50 dB RBW 10 MHz Att 40 dB SWT 10 ms VBW 10 MHz SQL TRG:VID</p> <p>IPk Clrw M1[1] 16.62 dBm 785.42 μs TRG 15.100 dBm 1.38392 ms</p> <p>CF 2.462 GHz 8000 pts 1.0 ms/</p> <table border="1"> <thead> <tr> <th>Type</th> <th>Ref</th> <th>Trc</th> <th>X-value</th> <th>Y-value</th> <th>Function</th> <th>Function Result</th> </tr> </thead> <tbody> <tr> <td>M1</td> <td></td> <td>1</td> <td>785.42 μs</td> <td>16.62 dBm</td> <td></td> <td></td> </tr> <tr> <td>D1</td> <td>M1</td> <td>1</td> <td>1.38392 ms</td> <td>1.75 dB</td> <td></td> <td></td> </tr> <tr> <td>D2</td> <td>M1</td> <td>1</td> <td>1.42768 ms</td> <td>0.04 dB</td> <td></td> <td></td> </tr> </tbody> </table> <p>Date: 8 JUN 2020 21:44:03</p>	Type	Ref	Trc	X-value	Y-value	Function	Function Result	M1		1	785.42 μs	16.62 dBm			D1	M1	1	1.38392 ms	1.75 dB			D2	M1	1	1.42768 ms	0.04 dB		
Type	Ref	Trc	X-value	Y-value	Function	Function Result																							
M1		1	785.42 μs	16.62 dBm																									
D1	M1	1	1.38392 ms	1.75 dB																									
D2	M1	1	1.42768 ms	0.04 dB																									



Type:	802.11n(HT20)																												
CH01	<p>Spectrum Ref Level 30.00 dBm Offset 0.50 dB RBW 10 MHz Att 40 dB SWT 10 ms VBW 10 MHz SQL TRG:VID IPk Clrwr</p> <p>M1[1] 16.29 dBm 292.56 μs 1.29765 ms</p> <p>TRG: 14.560 dBm</p> <p>CF 2.412 GHz 8000 pts 1.0 ms/</p> <table border="1"> <thead> <tr> <th>Type</th> <th>Ref</th> <th>Trc</th> <th>X-value</th> <th>Y-value</th> <th>Function</th> <th>Function Result</th> </tr> </thead> <tbody> <tr> <td>M1</td> <td></td> <td>1</td> <td>292.56 μs</td> <td>16.29 dBm</td> <td></td> <td></td> </tr> <tr> <td>D1</td> <td>M1</td> <td>1</td> <td>1.29765 ms</td> <td>1.08 dB</td> <td></td> <td></td> </tr> <tr> <td>D2</td> <td>M1</td> <td>1</td> <td>1.34142 ms</td> <td>-0.01 dB</td> <td></td> <td></td> </tr> </tbody> </table> <p>Date: 8 JUN 2020 21:46:45</p>	Type	Ref	Trc	X-value	Y-value	Function	Function Result	M1		1	292.56 μs	16.29 dBm			D1	M1	1	1.29765 ms	1.08 dB			D2	M1	1	1.34142 ms	-0.01 dB		
Type	Ref	Trc	X-value	Y-value	Function	Function Result																							
M1		1	292.56 μs	16.29 dBm																									
D1	M1	1	1.29765 ms	1.08 dB																									
D2	M1	1	1.34142 ms	-0.01 dB																									
CH06	<p>Spectrum Ref Level 30.00 dBm Offset 0.50 dB RBW 10 MHz Att 40 dB SWT 10 ms VBW 10 MHz SQL TRG:VID IPk Clrwr</p> <p>M1[1] 16.09 dBm -31.23 μs 1.29765 ms</p> <p>TRG: 14.300 dBm</p> <p>CF 2.437 GHz 8000 pts 1.0 ms/</p> <table border="1"> <thead> <tr> <th>Type</th> <th>Ref</th> <th>Trc</th> <th>X-value</th> <th>Y-value</th> <th>Function</th> <th>Function Result</th> </tr> </thead> <tbody> <tr> <td>M1</td> <td></td> <td>1</td> <td>-31.23 μs</td> <td>16.09 dBm</td> <td></td> <td></td> </tr> <tr> <td>D1</td> <td>M1</td> <td>1</td> <td>1.29765 ms</td> <td>2.00 dB</td> <td></td> <td></td> </tr> <tr> <td>D2</td> <td>M1</td> <td>1</td> <td>1.34142 ms</td> <td>-0.03 dB</td> <td></td> <td></td> </tr> </tbody> </table> <p>Date: 8 JUN 2020 21:49:45</p>	Type	Ref	Trc	X-value	Y-value	Function	Function Result	M1		1	-31.23 μs	16.09 dBm			D1	M1	1	1.29765 ms	2.00 dB			D2	M1	1	1.34142 ms	-0.03 dB		
Type	Ref	Trc	X-value	Y-value	Function	Function Result																							
M1		1	-31.23 μs	16.09 dBm																									
D1	M1	1	1.29765 ms	2.00 dB																									
D2	M1	1	1.34142 ms	-0.03 dB																									
CH11	<p>Spectrum Ref Level 30.00 dBm Offset 0.50 dB RBW 10 MHz Att 40 dB SWT 10 ms VBW 10 MHz SQL TRG:VID IPk Clrwr</p> <p>M1[1] 15.91 dBm -129.99 μs 1.29765 ms</p> <p>TRG: 14.500 dBm</p> <p>CF 2.462 GHz 8000 pts 1.0 ms/</p> <table border="1"> <thead> <tr> <th>Type</th> <th>Ref</th> <th>Trc</th> <th>X-value</th> <th>Y-value</th> <th>Function</th> <th>Function Result</th> </tr> </thead> <tbody> <tr> <td>M1</td> <td></td> <td>1</td> <td>-129.99 μs</td> <td>15.91 dBm</td> <td></td> <td></td> </tr> <tr> <td>D1</td> <td>M1</td> <td>1</td> <td>1.29765 ms</td> <td>1.56 dB</td> <td></td> <td></td> </tr> <tr> <td>D2</td> <td>M1</td> <td>1</td> <td>1.34142 ms</td> <td>0.31 dB</td> <td></td> <td></td> </tr> </tbody> </table> <p>Date: 8 JUN 2020 21:52:26</p>	Type	Ref	Trc	X-value	Y-value	Function	Function Result	M1		1	-129.99 μs	15.91 dBm			D1	M1	1	1.29765 ms	1.56 dB			D2	M1	1	1.34142 ms	0.31 dB		
Type	Ref	Trc	X-value	Y-value	Function	Function Result																							
M1		1	-129.99 μs	15.91 dBm																									
D1	M1	1	1.29765 ms	1.56 dB																									
D2	M1	1	1.34142 ms	0.31 dB																									



3.8. Antenna requirement

Requirement

FCC CFR Title 47 Part 15 Subpart C Section 15.203:

An intentional radiator shall be designed to ensure that no antenna other than that furnished by the responsible party shall be used with the device. The use of a permanently attached antenna or of antenna that uses a unique coupling to the intentional radiator, the manufacturer may design the unit so that a broken antenna can be replaced by the user, but the use of a standard antenna jack or electrical connector is prohibited.

FCC CFR Title 47 Part 15 Subpart C Section 15.247(c) (1)(i):

(i) Systems operating in the 2400~2483.5 MHz band that is used exclusively for fixed. Point-to-point operations may employ transmitting antennas with directional gain greater than 6dBi provided the maximum conducted output power of the intentional radiator is reduced by 1 dB for every 3 dB that the directional gain of the antenna exceeds 6dBi.

Test Result

The directional gain of the antenna less than 6dBi, please refer to the EUT internal photographs antenna photo.

*****THE END*****