

# SAR Test Report

Report No.: AGC00552180405FH01

**FCC ID** : 2AHZ5CUBOTR11  
**APPLICATION PURPOSE** : Original Equipment  
**PRODUCT DESIGNATION** : Smart Phone  
**BRAND NAME** : CUBOT  
**MODEL NAME** : R11  
**CLIENT** : Shenzhen Huafurui Technology Co., Ltd.  
**DATE OF ISSUE** : May 24,2018  
**STANDARD(S)** : IEEE Std. 1528:2013  
FCC 47CFR § 2.1093  
IEEE/ANSI C95.1:2005  
**REPORT VERSION** : V1.0

Attestation of Global Compliance(Shenzhen) Co., Ltd.

**CAUTION:**

This report shall not be reproduced except in full without the written permission of the test laboratory and shall not be quoted out of context.



The results shown in this test report refer only to the sample(s) tested unless otherwise stated and the sample(s) are retained for 30 days only. The document is issued by AGC, this document cannot be reproduced except in full with our prior written permission. The more details and the authenticity of the report will be confirmed at <http://www.agc-cert.com>.

### Report Revise Record

Report Version	Revise Time	Issued Date	Valid Version	Notes
V1.0	/	May 24,2018	Valid	Initial Release

The results shown in this test report refer only to the sample(s) tested unless otherwise stated and the sample(s) are retained for 30 days only. The document is issued by AGC, this document cannot be reproduced except in full with our prior written permission. The more details and the authenticity of the report will be confirmed at <http://www.agc-cert.com>.

## Test Report Certification

Applicant Name	Shenzhen Huafului Technology Co., Ltd.
Applicant Address	Unit 1401 14/F, Jin qi zhi gu mansion Liu xianstreet ,Xili, Nan shan district Shenzhen, China.
Manufacturer Name	Shenzhen Huafului Technology Co., Ltd.
Manufacturer Address	Unit 1401 14/F, Jin qi zhi gu mansion Liu xianstreet ,Xili, Nan shan district Shenzhen, China.
Product Designation	Smart Phone
Brand Name	CUBOT
Model Name	R11
EUT Voltage	DC3.8V by battery
Applicable Standard	IEEE Std. 1528:2013 FCC 47CFR § 2.1093 IEEE/ANSI C95.1:2005
Test Date	Apr. 28,2018 to May. 08,2018
Report Template	AGCRT-US-3G3/SAR (2018-01-01)

Note: The results of testing in this report apply to the product/system which was tested only.



Tested By \_\_\_\_\_

Eric Zhou(Zhou Yongkang)

May. 08,2018



Checked By \_\_\_\_\_

Angela Li(Li Jiao)

May 24,2018



Authorized By \_\_\_\_\_

Forrest Lei(Lei Yonggang)

May 24,2018

Authorized Officer

The results shown in this test report refer only to the sample(s) tested unless otherwise stated and the sample(s) are retained for 30 days only. The document is issued by AGC, this document cannot be reproduced except in full with our prior written permission. The more details and the authenticity of the report will be confirmed at <http://www.agc-cert.com>.



**TABLE OF CONTENTS**

**1. SUMMARY OF MAXIMUM SAR VALUE ..... 5**

**2. GENERAL INFORMATION..... 6**

    2.1. EUT DESCRIPTION..... 6

**3. SAR MEASUREMENT SYSTEM..... 8**

    3.1. THE SATIMO SYSTEM USED FOR PERFORMING COMPLIANCE TESTS CONSISTS OF FOLLOWING ITEMS ..... 8

    3.2. COMOSAR E-FIELD PROBE ..... 9

    3.3. ROBOT..... 9

    3.4. VIDEO POSITIONING SYSTEM ..... 10

    3.5. DEVICE HOLDER ..... 10

    3.6. SAM TWIN PHANTOM..... 11

**4. SAR MEASUREMENT PROCEDURE..... 12**

    4.1. SPECIFIC ABSORPTION RATE (SAR)..... 12

    4.2. SAR MEASUREMENT PROCEDURE ..... 13

    4.3. RF EXPOSURE CONDITIONS ..... 15

**5. TISSUE SIMULATING LIQUID..... 17**

    5.1. THE COMPOSITION OF THE TISSUE SIMULATING LIQUID..... 17

    5.2. TISSUE DIELECTRIC PARAMETERS FOR HEAD AND BODY PHANTOMS ..... 17

    5.3. TISSUE CALIBRATION RESULT ..... 18

**6. SAR SYSTEM CHECK PROCEDURE ..... 21**

    6.1. SAR SYSTEM CHECK PROCEDURES ..... 21

    6.2. SAR SYSTEM CHECK..... 22

**7. EUT TEST POSITION..... 24**

    7.2. CHEEK POSITION ..... 25

    7.3. TILT POSITION..... 25

    7.4. BODY WORN POSITION ..... 26

**8. SAR EXPOSURE LIMITS ..... 27**

**9. TEST FACILITY ..... 28**

**10. TEST EQUIPMENT LIST ..... 29**

**11. MEASUREMENT UNCERTAINTY ..... 30**

**12. CONDUCTED POWER MEASUREMENT..... 33**

**13. TEST RESULTS ..... 42**

    13.1. SAR TEST RESULTS SUMMARY..... 42

**APPENDIX A. SAR SYSTEM CHECK DATA ..... 56**

**APPENDIX B. SAR MEASUREMENT DATA..... 76**

**APPENDIX C. TEST SETUP PHOTOGRAPHS..... 112**

**APPENDIX D. CALIBRATION DATA ..... 119**

The results shown in this test report refer only to the sample(s) tested unless otherwise stated and the sample(s) are retained for 30 days only. The document is issued by AGC, this document cannot be reproduced except in full with our prior written permission. The more details and the authenticity of the report will be confirmed at <http://www.agc-cert.com>.

## 1. SUMMARY OF MAXIMUM SAR VALUE

The maximum results of Specific Absorption Rate (SAR) found during testing for EUT are as follows:

Frequency Band	Highest Reported 1g-SAR(W/Kg)		SAR Test Limit (W/Kg)
	Head	Body-worn	
GSM 850	0.187	0.420	1.6
PCS 1900	0.088	0.635	
UMTS Band II	0.203	1.173	
UMTS Band V	0.186	0.530	
UMTS Band IV	0.174	0.872	
WIFI 2.4G	0.292	0.293	
Simultaneous Reported SAR	1.466		
SAR Test Result	PASS		

This device is compliance with Specific Absorption Rate (SAR) for general population/uncontrolled exposure limits (1.6W/Kg) specified in IEEE Std. 1528:2013; FCC 47CFR § 2.1093; IEEE/ANSI C95.1:2005 and the following specific FCC Test Procedures:

- KDB 447498 D01 General RF Exposure Guidance v06
- KDB 648474 D04 Handset SAR v01r03
- KDB 865664 D01 SAR Measurement 100MHz to 6GHz v01r04
- KDB 941225 D01 3G SAR Procedures v03r01
- KDB 941225 D06 Hotspot Mode v02r01
- KDB 248227 D01 802 11 Wi-Fi SAR v02r02

The results shown in this test report refer only to the sample(s) tested unless otherwise stated and the sample(s) are retained for 30 days only. The document is issued by AGC, this document cannot be reproduced except in full with our prior written permission. The more details and the authenticity of the report will be confirmed at <http://www.agc-cert.com>.



## 2. GENERAL INFORMATION

### 2.1. EUT Description

General Information	
Product Designation	Smart Phone
Test Model	R11
Hardware Version	WE368B_MB_V1.0
Software Version	CUBOT_R11_8011C_V02_20180313
Device Category	Portable
RF Exposure Environment	Uncontrolled
Antenna Type	PIFA Antenna
GSM and GPRS	
Support Band	<input checked="" type="checkbox"/> GSM 850 <input checked="" type="checkbox"/> PCS 1900 (U.S. Bands) <input checked="" type="checkbox"/> GSM 900 <input checked="" type="checkbox"/> DCS 1800 (Non-U.S. Bands)
GPRS Type	Class B
GPRS Class	Class 12(1Tx+4Rx, 2Tx+3Rx, 3Tx+2Rx, 4Tx+1Rx)
TX Frequency Range	GSM 850 : 820-850MHz;; PCS 1900: 1850-1910MHz;
RX Frequency Range	GSM 850 : 869~894MHz; PCS 1900: 1930~1990MHz
Release Version	R99
Type of modulation	GMSK for GSM/GPRS;
Antenna Gain	GSM850: 0.56dBi; PCS1900: 0.43dBi;
Max. Avg. Burst Power	GSM850: 31.77dBm ;PCS1900: 28.49dBm
WCDMA	
Support Band	<input checked="" type="checkbox"/> UMTS FDD Band II <input checked="" type="checkbox"/> UMTS FDD Band V <input checked="" type="checkbox"/> UMTS FDD Band IV (U.S. Bands) <input checked="" type="checkbox"/> UMTS FDD Band I <input checked="" type="checkbox"/> UMTS FDD Band VIII (Non-U.S. Bands)
HS Type	HSPA(HSUPA/HSDPA)
TX Frequency Range	WCDMA FDD Band II: 1850-1910MHz; WCDMA FDD Band V: 820-850MHz WCDMA FDD Band IV: 1712.4-1752.6MHz
RX Frequency Range	WCDMA FDD Band II: 1930-1990MHz; WCDMA FDD Band V: 869-894MHz WCDMA FDD Band IV: 2112.4-5152.6MHz
Release Version	Rel-6
Type of modulation	HSDPA:QPSK/16QAM; HSUPA:BPSK; WCDMA:QPSK
Antenna Gain	WCDMA850: 0.70dBi; WCDMA1900:0.58dBi; WCDMA1700:0.82dBi
Max. Avg. Burst Power	Band II: 21.44dBm; Band V: 21.59dBm; Band IV: 21.59dBm;

The results shown in this test report refer only to the sample(s) tested unless otherwise stated and the sample(s) are retained for 30 days only. The document is issued by AGC, this document cannot be reproduced except in full with our prior written permission. The more details and the authenticity of the report will be confirmed at <http://www.agc-cert.com>.

**EUT Description( Continue)**

<b>Bluetooth</b>	
Bluetooth Version	<input type="checkbox"/> V2.0 <input type="checkbox"/> V2.1 <input type="checkbox"/> V2.1+EDR <input checked="" type="checkbox"/> V3.0 <input type="checkbox"/> V3.0+HS <input checked="" type="checkbox"/> V4.0 <input type="checkbox"/> V4.1
Operation Frequency	2402~2480MHz
Type of modulation	<input checked="" type="checkbox"/> GFSK <input checked="" type="checkbox"/> $\pi/4$ -DQPSK <input checked="" type="checkbox"/> 8-DPSK
Peak Power	2.760dBm
Antenna Gain	1.12dBi
<b>WIFI</b>	
WIFI Specification	<input type="checkbox"/> 802.11a <input checked="" type="checkbox"/> 802.11b <input checked="" type="checkbox"/> 802.11g <input checked="" type="checkbox"/> 802.11n(20) <input checked="" type="checkbox"/> 802.11n(40)
Operation Frequency	2412~2462MHz
Average Power	11b:14.07dBm,11g:10.98dBm,11n(20):11.09dBm,11n(40):9.06dBm
Antenna Gain	1.12dBi
<b>Accessories</b>	
Battery	Brand name: CUBOT Model No. : R11 Voltage and Capacitance: 3.8 V & 2800mAh
Earphone	Brand name: N/A Model No. : N/A

Note:1.CMU200 can measure the average power and Peak power at the same time  
 2.The sample used for testing is end product.

Product	Type
	<input checked="" type="checkbox"/> Production unit <input type="checkbox"/> Identical Prototype

The results shown in this test report refer only to the sample(s) tested unless otherwise stated and the sample(s) are retained for 30 days only. The document is issued by AGC, this document cannot be reproduced except in full with our prior written permission. The more details and the authenticity of the report will be confirmed at <http://www.agc-cert.com>.



### 3. SAR MEASUREMENT SYSTEM

#### 3.1. The SATIMO system used for performing compliance tests consists of following items

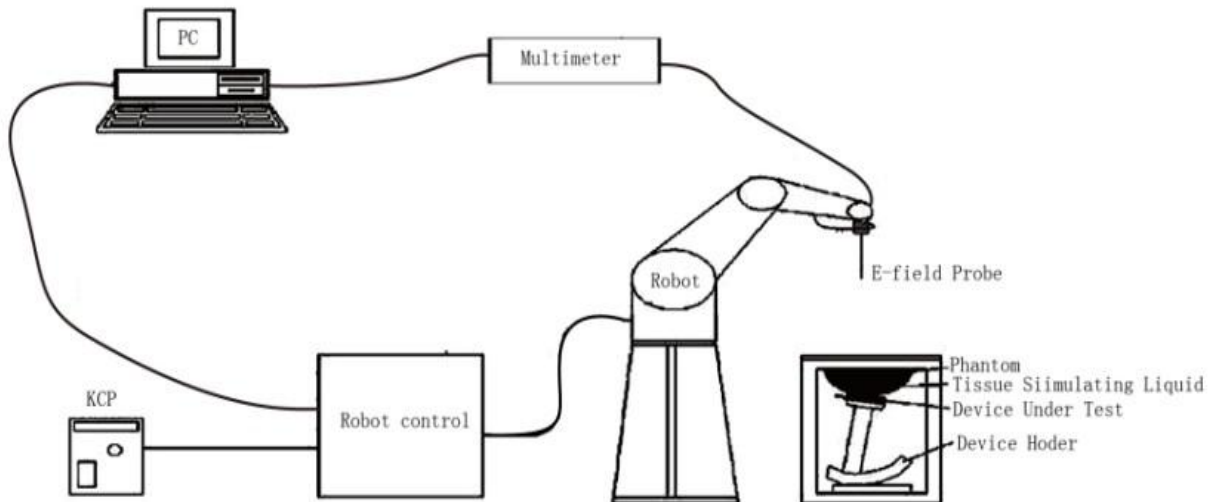

The COMOSAR system for performing compliance tests consists of the following items:

- The PC. It controls most of the bench devices and stores measurement data. A computer running WinXP and the Opensar software.
- The E-Field probe. The probe is a 3-axis system made of 3 distinct dipoles. Each dipole returns a voltage in function of the ambient electric field.
- The Keithley multimeter measures each probe dipole voltages.
- The SAM phantom simulates a human head. The measurement of the electric field is made inside the phantom.
- The liquids simulate the dielectric properties of the human head tissues.
- The network emulator controls the mobile phone under test.
- The validation dipoles are used to measure a reference SAR. They are used to periodically check the bench to make sure that there is no drift of the system characteristics over time.
- The phantom, the device holder and other accessories according to the targeted measurement.

The results shown in this test report refer only to the sample(s) tested unless otherwise stated and the sample(s) are retained for 30 days only. The document is issued by AGC, this document cannot be reproduced except in full with our prior written permission. The more details and the authenticity of the report will be confirmed at <http://www.agc-cert.com>.



### 3.2. COMOSAR E-Field Probe

The SAR measurement is conducted with the dosimetric probe manufactured by SATIMO. The probe is specially designed and calibrated for use in liquid with high permittivity. The dosimetric probe has special calibration in liquid at different frequency. SATIMO conducts the probe calibration in compliance with international and national standards (e.g. IEEE 1528 and relevant KDB files.) The calibration data are in Appendix D.

#### Isotropic E-Field Probe Specification

<b>Model</b>	SSE2	
<b>Manufacture</b>	MVG	
<b>Identification No.</b>	SN 08/16 EPGO282	
<b>Frequency</b>	0.7GHz-6GHz Linearity:±0.06dB(700MHz-6GHz)	
<b>Dynamic Range</b>	0.01W/Kg-100W/Kg Linearity:±0.06dB	
<b>Dimensions</b>	Overall length:330mm Length of individual dipoles:2mm Maximum external diameter:8mm Probe Tip external diameter:2.5mm Distance between dipoles/ probe extremity:1mm	
<b>Application</b>	High precision dosimetric measurements in any exposure scenario (e.g., very strong gradient fields). Only probe which enables compliance testing for frequencies up to 6 GHz with precision of better 30%.	

### 3.3. Robot

The COMOSAR system uses the KUKA robot from SATIMO SA (France).For the 6-axis controller COMOSAR system, the KUKA robot controller version from SATIMO is used.

The XL robot series have many features that are important for our application:

- High precision (repeatability 0.02 mm)
- High reliability (industrial design)
- Jerk-free straight movements
- Low ELF interference (the closed metallic construction shields against motor control fields)
- 6-axis controller



The results shown in this test report refer only to the sample(s) tested unless otherwise stated and the sample(s) are retained for 30 days only. The document is issued by AGC, this document cannot be reproduced except in full with our prior written permission. The more details and the authenticity of the report will be confirmed at <http://www.agc-cert.com>.

### 3.4. Video Positioning System

The video positioning system is used in OpenSAR to check the probe. Which is composed of a camera, LED, mirror and mechanical parts. The camera is piloted by the main computer with firewire link. During the process, the actual position of the probe tip with respect to the robot arm is measured, as well as the probe length and the horizontal probe offset. The software then corrects all movements, such that the robot coordinates are valid for the probe tip. The repeatability of this process is better than 0.1 mm. If a position has been taught with an aligned probe, the same position will be reached with another aligned probe within 0.1 mm, even if the other probe has different dimensions. During probe rotations, the probe tip will keep its actual position.

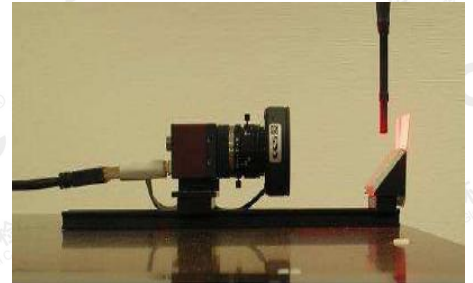

### 3.5. Device Holder

The COMOSAR device holder is designed to cope with different positions given in the standard. It has two scales for the device rotation (with respect to the body axis) and the device inclination (with respect to the line between the ear reference points). The rotation center for both scales is the ear reference point (EPR). Thus the device needs no repositioning when changing the angles. The COMOSAR device holder has been made out of low-loss POM material having the following dielectric parameters: relative permittivity  $\epsilon_r = 3$  and loss tangent  $\delta = 0.02$ . The amount of dielectric material has been reduced in the closest vicinity of the device, since measurements have suggested that the influence of the clamp on the test results could thus be lowered.

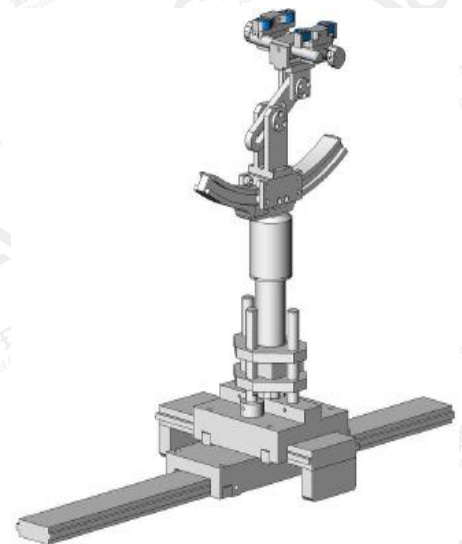

The results shown in this test report refer only to the sample(s) tested unless otherwise stated and the sample(s) are retained for 30 days only. The document is issued by AGC, this document cannot be reproduced except in full with our prior written permission. The more details and the authenticity of the report will be confirmed at <http://www.agc-cert.com>.



### 3.6. SAM Twin Phantom

The SAM twin phantom is a fiberglass shell phantom with 2mm shell thickness (except the ear region where shell thickness increases to 6mm). It has three measurement areas:

- Left head
- Right head
- Flat phantom



The bottom plate contains three pair of bolts for locking the device holder. The device holder positions are adjusted to the standard measurement positions in the three sections. A white cover is provided to tap the phantom during off-periods to prevent water evaporation and changes in the liquid parameters. On the phantom top, three reference markers are provided to identify the phantom position with respect to the robot.

The results shown in this test report refer only to the sample(s) tested unless otherwise stated and the sample(s) are retained for 30 days only. The document is issued by AGC, this document cannot be reproduced except in full with our prior written permission. The more details and the authenticity of the report will be confirmed at <http://www.agc-cert.com>.

## 4. SAR MEASUREMENT PROCEDURE

### 4.1. Specific Absorption Rate (SAR)

SAR is related to the rate at which energy is absorbed per unit mass in object exposed to a radio field. The SAR distribution in a biological body is complicated and is usually carried out by experimental techniques or numerical modeling. The standard recommends limits for two tiers of groups, occupational/controlled and occupational/uncontrolled, based on a person's awareness and ability to exercise control over his or her exposure. In general, occupational/controlled exposure limits are higher than the limits for general population/uncontrolled.

The SAR definition is the time derivative (rate) of the incremental energy (dW) absorbed by (dissipated in) an incremental mass (dm) contained in a volume element(dv) of given mass density (ρ). The equation description is as below:

$$SAR = \frac{d}{dt} \left( \frac{dW}{dm} \right) = \frac{d}{dt} \left( \frac{dW}{\rho dV} \right)$$

SAR is expressed in units of Watts per kilogram (W/Kg)

SAR can be obtained using either of the following equations:

$$SAR = \frac{\sigma E^2}{\rho}$$

$$SAR = c_h \left. \frac{dT}{dt} \right|_{t=0}$$

Where

SAR	is the specific absorption rate in watts per kilogram;
E	is the r.m.s. value of the electric field strength in the tissue in volts per meter;
σ	is the conductivity of the tissue in siemens per metre;
ρ	is the density of the tissue in kilograms per cubic metre;
c <sub>h</sub>	is the heat capacity of the tissue in joules per kilogram and Kelvin;
$\left. \frac{dT}{dt} \right _{t=0}$	is the initial time derivative of temperature in the tissue in kelvins per second

The results shown in this test report refer only to the sample(s) tested unless otherwise stated and the sample(s) are retained for 30 days only. The document is issued by AGC, this document cannot be reproduced except in full with our prior written permission. The more details and the authenticity of the report will be confirmed at <http://www.agc-cert.com>.



## 4.2. SAR Measurement Procedure

### Step 1: Power Reference Measurement

The Power Reference Measurement and Power Drift Measurement are for monitoring the power drift of the device under test in the batch process. The minimum distance of probe sensors to surface is 2.7mm This distance cannot be smaller than the distance os sensor calibration points to probe tip as `defined in the probe properties,

### Step 2: Area Scan

The Area Scan is used as a fast scan in two dimensions to find the area of high field values, before doing a fine measurement around the hot spot. The sophisticated interpolation routines implemented in SATIMO software can find the maximum locations even in relatively coarse grids. When an Area Scan has measured all reachable points, it computes the field maximal found in the scanned area, within a range of the global maximum. The range (in db) is specified in the standards for compliance testing. For example, a 2db range is required in IEEE Standard 1528, whereby 3db is a requirement when compliance is assessed in accordance with the ARIB standard (Japan) If one Zoom Scan follows the Area Scan, then only the absolute maximum will be taken as reference. For cases where multiple maximum are detected, the number of Zoom Scan has to be increased accordingly.

Area Scan Parameters extracted from KDB 865664 D01 SAR Measurement 100MHz to 6GHz

	≤ 3 GHz	> 3 GHz
Maximum distance from closest measurement point (geometric center of probe sensors) to phantom surface	5 ± 1 mm	$\frac{1}{2} \cdot \delta \cdot \ln(2) \pm 0.5$ mm
Maximum probe angle from probe axis to phantom surface normal at the measurement location	30° ± 1°	20° ± 1°
Maximum area scan spatial resolution: $\Delta x_{Area}$ , $\Delta y_{Area}$	≤ 2 GHz: ≤ 15 mm 2 – 3 GHz: ≤ 12 mm	3 – 4 GHz: ≤ 12 mm 4 – 6 GHz: ≤ 10 mm
	When the x or y dimension of the test device, in the measurement plane orientation, is smaller than the above, the measurement resolution must be ≤ the corresponding x or y dimension of the test device with at least one measurement point on the test device.	

### Step 3: Zoom Scan

Zoom Scan are used to assess the peak spatial SAR value within a cubic average volume containing 1g abd 10g of simulated tissue. The Zoom Scan measures points(refer to table below) within a cube whose base faces are centered on the maxima found in a preceding area scan job within the same procedure. When the measurement is done, the Zoom Scan evaluates the averaged SAR for 1g and 10g and displays these values next to the job's label.

The results shown in this test report refer only to the sample(s) tested unless otherwise stated and the sample(s) are retained for 30 days only. The document is issued by AGC, this document cannot be reproduced except in full with our prior written permission. The more details and the authenticity of the report will be confirmed at <http://www.agc-cert.com>.

Zoom Scan Parameters extracted from KDB865664 d01 SAR Measurement 100MHz to 6GHz

Maximum zoom scan spatial resolution: $\Delta x_{Zoom}$ , $\Delta y_{Zoom}$		$\leq 2$ GHz: $\leq 8$ mm 2 – 3 GHz: $\leq 5$ mm*	3 – 4 GHz: $\leq 5$ mm* 4 – 6 GHz: $\leq 4$ mm*
Maximum zoom scan spatial resolution, normal to phantom surface	uniform grid: $\Delta z_{Zoom}(n)$	$\leq 5$ mm	3 – 4 GHz: $\leq 4$ mm 4 – 5 GHz: $\leq 3$ mm 5 – 6 GHz: $\leq 2$ mm
	graded grid	$\Delta z_{Zoom}(1)$ : between 1 <sup>st</sup> two points closest to phantom surface	$\leq 4$ mm
		$\Delta z_{Zoom}(n>1)$ : between subsequent points	$\leq 1.5 \cdot \Delta z_{Zoom}(n-1)$
Minimum zoom scan volume	x, y, z	$\geq 30$ mm	3 – 4 GHz: $\geq 28$ mm 4 – 5 GHz: $\geq 25$ mm 5 – 6 GHz: $\geq 22$ mm
<p>Note: <math>\delta</math> is the penetration depth of a plane-wave at normal incidence to the tissue medium; see draft standard IEEE P1528-2011 for details.</p> <p>* When zoom scan is required and the <i>reported</i> SAR from the <i>area scan based 1-g SAR estimation</i> procedures of KDB 447498 is <math>\leq 1.4</math> W/kg, <math>\leq 8</math> mm, <math>\leq 7</math> mm and <math>\leq 5</math> mm zoom scan resolution may be applied, respectively, for 2 GHz to 3 GHz, 3 GHz to 4 GHz and 4 GHz to 6 GHz.</p>			

Step 4: Power Drift Measurement

The Power Drift Measurement measures the field at the same location as the most recent power reference measurement within the same procedure, and with the same settings. The Power Drift Measurement gives the field difference in dB from the reading conducted within the same settings. This allows a user to monitor the power drift of the device under test within a batch process. The measurement procedure is the same as Step 1.

The results shown in this test report refer only to the sample(s) tested unless otherwise stated and the sample(s) are retained for 30 days only. The document is issued by AGC, this document cannot be reproduced except in full with our prior written permission. The more details and the authenticity of the report will be confirmed at <http://www.agc-cert.com>.



### 4.3. RF Exposure Conditions

Test Configuration and setting:

The EUT is a model of GSM/WCDMA Portable Mobile Station (MS). It supports GSM/GPRS, WCDMA/HSPA, BT, WIFI, and support hot spot mode.

For WWAN SAR testing, the device was controlled by using a base station emulator. Communication between the device and the emulator were established by air link. The distance between the EUT and the antenna is larger than 50cm, and the output power radiated from the emulator antenna is at least 30db smaller than the output power of EUT.

For WLAN testing, the EUT is configured with the WLAN continuous TX tool through engineering command.

#### Antenna Location: (the back view)

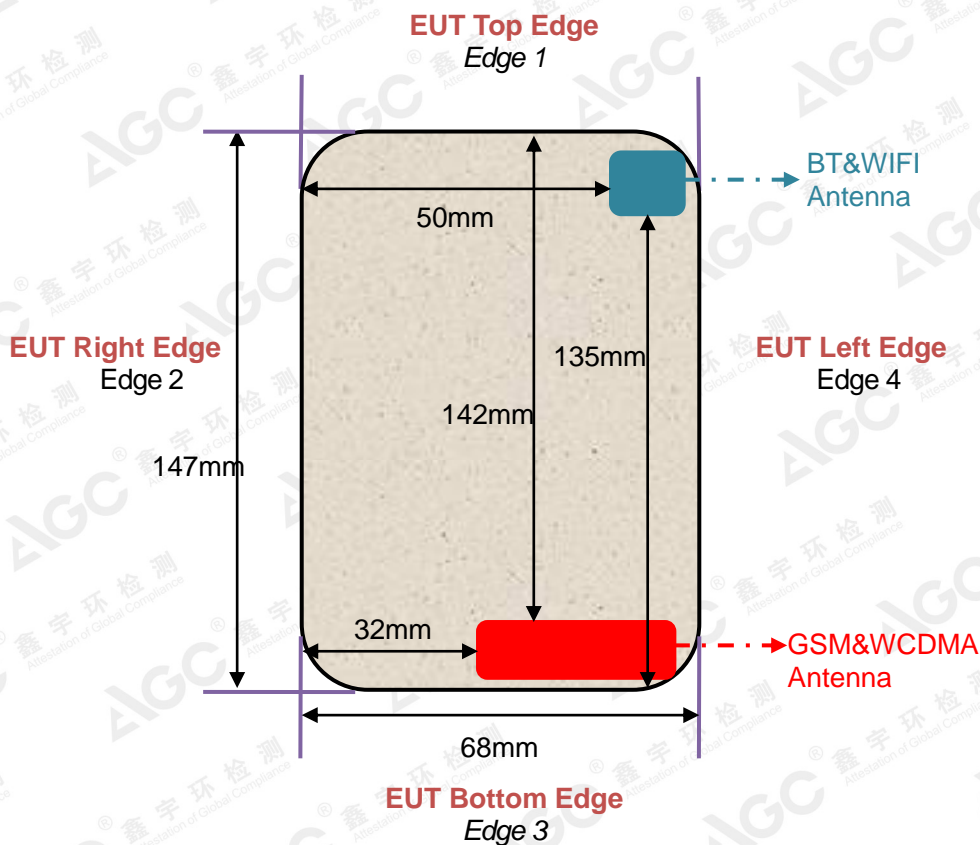

The results shown in this test report refer only to the sample(s) tested unless otherwise stated and the sample(s) are retained for 30 days only. The document is issued by AGC, this document cannot be reproduced except in full with our prior written permission. The more details and the authenticity of the report will be confirmed at <http://www.agc-cert.com>.

For WWAN mode:

Test Configurations	Antenna to edges/surface	SAR required	Note
<b>Head</b>			
Left Touch		Yes	--
Left Tilt		Yes	--
Right Touch		Yes	--
Right Tilt		Yes	--
<b>Body</b>			
Back	<25mm	Yes	--
Front	<25mm	Yes	--
<b>Hotspot</b>			
Back	<25mm	Yes	--
Front	<25mm	Yes	--
Edge 1 (Top)	142mm	No	SAR is not required for the distance between the antenna and the edge is >25mm as per KDB 941225 D06 Hotspot SAR
Edge 2 (Right)	32mm	No	SAR is not required for the distance between the antenna and the edge is >25mm as per KDB 941225 D06 Hotspot SAR
Edge 3 (Bottom)	1mm	Yes	--
Edge 4 (Left)	1mm	Yes	--

For WLAN mode:

Test Configurations	Antenna to edges/surface	SAR required	Note
<b>Head</b>			
Left Touch		Yes	--
Left Tilt		Yes	--
Right Touch		Yes	--
Right Tilt		Yes	--
<b>Body</b>			
Back	<25mm	Yes	--
Front	<25mm	Yes	--
<b>Hotspot</b>			
Back	<25mm	Yes	--
Front	<25mm	Yes	--
Edge 1 (Top)	1mm	Yes	--
Edge 2 (Right)	50mm	No	SAR is not required for the distance between the antenna and the edge is >25mm as per KDB 941225 D06 Hotspot SAR
Edge 3 (Bottom)	135mm	No	SAR is not required for the distance between the antenna and the edge is >25mm as per KDB 941225 D06 Hotspot SAR
Edge 4 (Left)	1mm	Yes	--

The results shown in this test report refer only to the sample(s) tested unless otherwise stated and the sample(s) are retained for 30 days only. The document is issued by AGC, this document cannot be reproduced except in full with our prior written permission. The more details and the authenticity of the report will be confirmed at <http://www.agc-cert.com>.



## 5. TISSUE SIMULATING LIQUID

For SAR measurement of the field distribution inside the phantom, the phantom must be filled with homogeneous tissue simulating liquid to a depth of at least 15cm. For head SAR testing the liquid height from the ear reference point (ERP) of the phantom to the liquid top surface is larger than 15cm For body SAR testing, the liquid height from the center of the flat phantom to the liquid top surface is larger than 15cm. The nominal dielectric values of the tissue simulating liquids in the phantom and the tolerance of 5% are listed in 5.2

### 5.1. The composition of the tissue simulating liquid

Ingredient (% Weight) Frequency (MHz)	Water	Nacl	Polysorbate 20	DGBE	1,2 Propanediol	Triton X-100
835 Head	50.36	1.25	48.39	0.0	0.0	0.0
835 Body	54.00	1	0.0	15	0.0	30
1750 Head	55.2	0.3	0.0	44.5	0.0	0.0
1750 Body	70	1	0.0	9	0.0	20
1900 Head	54.9	0.18	0.0	44.92	0.0	0.0
1900 Body	70	1	0.0	9	0.0	20
2450 Head	71.88	0.16	0.0	7.99	0.0	19.97
2450 Body	70	1	0.0	9	0.0	20

### 5.2. Tissue Dielectric Parameters for Head and Body Phantoms

The head tissue dielectric parameters recommended by the IEEE 1528 have been incorporated in the following table. These head parameters are derived from planar layer models simulating the highest expected SAR for the dielectric properties and tissue thickness variations in a human head. Other head and body tissue parameters that have not been specified in IEEE 1528 are derived from the tissue dielectric parameters computed from the 4-Cole-Cole equations described in Reference [12] and extrapolated according to the head parameters specified in IEEE 1528.

Target Frequency (MHz)	head		body	
	$\epsilon_r$	$\sigma$ (S/m)	$\epsilon_r$	$\sigma$ (S/m)
300	45.3	0.87	58.2	0.92
450	43.5	0.87	56.7	0.94
<b>835</b>	<b>41.5</b>	<b>0.90</b>	<b>55.2</b>	<b>0.97</b>
900	41.5	0.97	55.0	1.05
915	41.5	1.01	55.0	1.06
1450	40.5	1.20	54.0	1.30
1610	40.3	1.29	53.8	1.40
<b>1750</b>	<b>40.1</b>	<b>1.37</b>	<b>53.4</b>	<b>1.49</b>
<b>1800 – 2000</b>	<b>40.0</b>	<b>1.40</b>	<b>53.3</b>	<b>1.52</b>
<b>2450</b>	<b>39.2</b>	<b>1.80</b>	<b>52.7</b>	<b>1.95</b>
3000	38.5	2.40	52.0	2.73

( $\epsilon_r$  = relative permittivity,  $\sigma$  = conductivity and  $\rho = 1000$  kg/m<sup>3</sup>)

The results shown in this test report refer only to the sample(s) tested unless otherwise stated and the sample(s) are retained for 30 days only. The document is issued by AGC, this document cannot be reproduced except in full with our prior written permission. The more details and the authenticity of the report will be confirmed at <http://www.agc-cert.com>.

### 5.3. Tissue Calibration Result

The dielectric parameters of the liquids were verified prior to the SAR evaluation using SATIMO Dielectric Probe Kit and R&S Network Analyzer ZVL6.

Tissue Stimulant Measurement for 835MHz					
	Fr. (MHz)	Dielectric Parameters ( $\pm 5\%$ )		Tissue Temp [°C]	Test time
		$\epsilon_r$ 41.5 (39.425-43.575)	$\delta$ [s/m] 0.90(0.855-0.945)		
Head	824.2	42.85	0.88	21.3	Apr. 28,2018
	826.4	42.11	0.89		
	835	41.63	0.90		
	836.6	41.09	0.91		
	846.6	40.77	0.92		
	848.8	40.26	0.93		
	Fr. (MHz)	Dielectric Parameters ( $\pm 5\%$ )		Tissue Temp [°C]	Test time
		$\epsilon_r$ 55.20(52.44-57.96)	$\delta$ [s/m]0.97(0.9215-1.0185)		
Body	824.2	56.61	0.94	21.4	Apr. 28,2018
	826.4	55.99	0.95		
	835	55.37	0.96		
	836.6	54.64	0.97		
	846.6	54.10	0.98		
	848.8	53.88	0.99		

Tissue Stimulant Measurement for 1750MHz					
	Fr. (MHz)	Dielectric Parameters ( $\pm 5\%$ )		Tissue Temp [°C]	Test time
		$\epsilon_r$ 40.10(38.095-42.105)	$\delta$ [s/m]1.37(1.3015-1.439)		
Head	1712.5	41.61	1.33	21.5	May. 08,2018
	1732.5	41.09	1.35		
	1750	40.83	1.37		
	1752.5	40.22	1.40		
	Fr. (MHz)	Dielectric Parameters ( $\pm 5\%$ )		Tissue Temp [°C]	Test time
		$\epsilon_r$ 53.4(50.73-56.07)	$\delta$ [s/m] 1.49(1.4155-1.5645)		
Body	1712.5	55.17	1.45	21.7	May. 08,2018
	1732.5	54.39	1.48		
	1750	54.07	1.50		
	1752.5	53.55	1.52		

The results shown in this test report refer only to the sample(s) tested unless otherwise stated and the sample(s) are retained for 30 days only. The document is issued by AGC, this document cannot be reproduced except in full with our prior written permission. The more details and the authenticity of the report will be confirmed at <http://www.agc-cert.com>.



Tissue Stimulant Measurement for 1900MHz					
	Fr. (MHz)	Dielectric Parameters ( $\pm 5\%$ )		Tissue Temp [°C]	Test time
		$\epsilon_r 40.00(38.00-42.00)$	$\delta [s/m] 1.40(1.33-1.47)$		
Head	1850.2	41.05	1.37	21.2	May. 02,2018
	1880	40.61	1.39		
	1900	40.11	1.41		
	1909.8	39.59	1.43		
	Fr. (MHz)	Dielectric Parameters ( $\pm 5\%$ )		Tissue Temp [°C]	Test time
		$\epsilon_r 53.30(50.635-55.965)$	$\delta [s/m] 1.52(1.444-1.596)$		
Body	1850.2	54.88	1.50	21.4	May. 02,2018
	1880	54.16	1.51		
	1900	53.59	1.53		
	1909.8	53.04	1.55		

Tissue Stimulant Measurement for 1900MHz					
	Fr. (MHz)	Dielectric Parameters ( $\pm 5\%$ )		Tissue Temp [°C]	Test time
		$\epsilon_r 40.00(38.00-42.00)$	$\delta [s/m] 1.40(1.33-1.47)$		
Head	1852.4	41.05	1.35	21.1	May. 07,2018
	1880	40.63	1.38		
	1900	40.11	1.41		
	1907.6	39.53	1.42		
	Fr. (MHz)	Dielectric Parameters ( $\pm 5\%$ )		Tissue Temp	Test time
		$\epsilon_r 53.30(50.635-55.965)$	[°C] $\delta [s/m] 1.52(1.444-1.596)$		
Body	1852.4	54.16	1.48	21.3	May. 07,2018
	1880	53.71	1.50		
	1900	53.26	1.51		
	1907.6	52.44	1.53		

The results shown in this test report refer only to the sample(s) tested unless otherwise stated and the sample(s) are retained for 30 days only. The document is issued by AGC, this document cannot be reproduced except in full with our prior written permission. The more details and the authenticity of the report will be confirmed at <http://www.agc-cert.com>.

Tissue Stimulant Measurement for 2450MHz					
	Fr. (MHz)	Dielectric Parameters ( $\pm 5\%$ )		Tissue Temp [°C]	Test time
		$\epsilon_r$ 39.2(37.24-41.16)	$\delta$ [s/m]1.80(1.71-1.89)		
Head	2412	40.85	1.75	21.6	May. 04,2018
	2437	40.29	1.77		
	2450	39.61	1.82		
	2462	39.04	1.83		
	Fr. (MHz)	Dielectric Parameters ( $\pm 5\%$ )		Tissue Temp [°C]	Test time
		$\epsilon_r$ 52.7(50.065-55.335)	$\delta$ [s/m]1.95(1.8525-2.0475)		
Body	2412	54.85	1.88	21.8	May. 04,2018
	2437	54.16	1.90		
	2450	53.61	1.92		
	2462	53.04	1.93		

The results shown in this test report refer only to the sample(s) tested unless otherwise stated and the sample(s) are retained for 30 days only. The document is issued by AGC, this document cannot be reproduced except in full with our prior written permission. The more details and the authenticity of the report will be confirmed at <http://www.agc-cert.com>.



## 6. SAR SYSTEM CHECK PROCEDURE

### 6.1. SAR System Check Procedures

SAR system check is required to confirm measurement accuracy, according to the tissue dielectric media, probe calibration points and other system operating parameters required for measuring the SAR of a test device. The system verification must be performed for each frequency band and within the valid range of each probe calibration point required for testing the device. The same SAR probe(s) and tissue-equivalent media combinations used with each specific SAR system for system verification must be used for device testing. When multiple probe calibration points are required to cover substantially large transmission bands, independent system verifications are required for each probe calibration point. A system verification must be performed before each series of SAR measurements using the same probe calibration point and tissue-equivalent medium. Additional system verification should be considered according to the conditions of the tissue-equivalent medium and measured tissue dielectric parameters, typically every three to four days when the liquid parameters are remeasured or sooner when marginal liquid parameters are used at the beginning of a series of measurements.

Each SATIMO system is equipped with one or more system check kits. These units, together with the predefined measurement procedures within the SATIMO software, enable the user to conduct the system check and system validation. System kit includes a dipole, and dipole device holder.

The system check verifies that the system operates within its specifications. It's performed daily or before every SAR measurement. The system check uses normal SAR measurement in the flat section of the phantom with a matched dipole at a specified distance. The system check setup is shown as below.

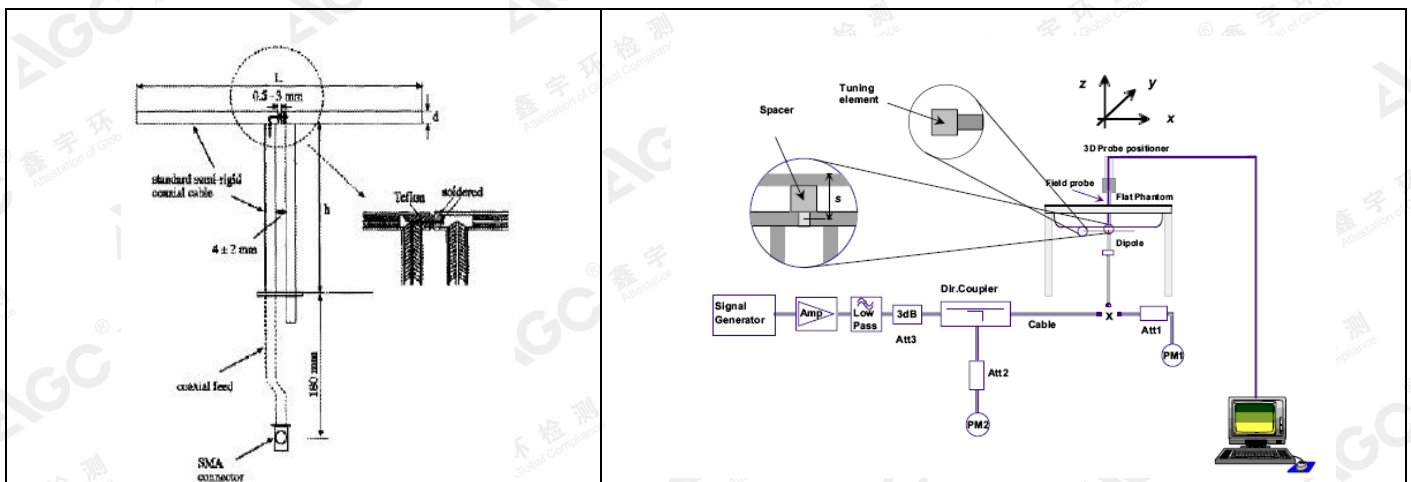

The results shown in this test report refer only to the sample(s) tested unless otherwise stated and the sample(s) are retained for 30 days only. The document is issued by AGC, this document cannot be reproduced except in full with our prior written permission. The more details and the authenticity of the report will be confirmed at <http://www.agc-cert.com>.

## 6.2. SAR System Check

### 6.2.1. Dipoles

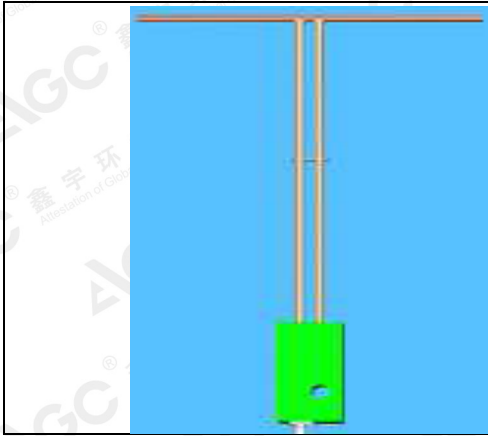

The dipoles used are based on the IEEE-1528 standard, and is complied with mechanical and electrical specifications in line with the requirements of IEEE. the table below provides details for the mechanical and electrical specifications for the dipoles.

Frequency	L (mm)	h (mm)	d (mm)
835MHz	161.0	89.8	3.6
1800MHz	71.6	41.7	3.6
1900MHz	68	39.5	3.6
2450MHz	51.5	30.4	3.6

The results shown in this test report refer only to the sample(s) tested unless otherwise stated and the sample(s) are retained for 30 days only. The document is issued by AGC, this document cannot be reproduced except in full with our prior written permission. The more details and the authenticity of the report will be confirmed at <http://www.agc-cert.com>.



### 6.2.2. System Check Result

System Performance Check at 835MHz& 1800MHz &1900MHz &2450MHz for Head								
Validation Kit: SN29/15 DIP 0G835-383& SN29/15 DIP 1G800-387&SN 29/15 DIP 1G900-389& SN 29/15DIP 2G450-393								
Frequency [MHz]	Target Value(W/Kg)		Reference Result ( $\pm 10\%$ )		Tested Value(W/Kg)		Tissue Temp. [°C]	Test time
	1g	10g	1g	10g	1g	10g		
835	10.04	6.43	9.036-11.044	5.787 -7.073	9.68	6.14	21.3	Apr. 28,2018
1800	37.43	19.88	33.687-41.173	17.892-21.868	38.72	21.05	21.5	May. 08,2018
1900	41.44	21.33	37.296-45.584	19.197-23.463	40.39	21.24	21.2	May. 02,2018
1900	41.44	21.33	37.296-45.584	19.197-23.463	38.33	20.31	21.1	May. 07,2018
2450	54.53	24.30	49.077-59.983	21.87-26.730	52.23	24.40	21.6	May. 04,2018

System Performance Check at 835 MHz &1900MHz & 2450MHz for Body								
Frequency [MHz]	Target Value(W/Kg)		Reference Result ( $\pm 10\%$ )		Tested Value(W/Kg)		Tissue Temp. [°C]	Test time
	1g	10g	1g	10g	1g	10g		
835	9.85	6.45	8.865-10.835	5.805-7.095	9.44	5.96	21.4	Apr. 28,2018
1800	36.53	19.80	32.877-40.183	17.82-21.780	37.61	20.37	21.7	May. 08,2018
1900	39.38	20.86	35.442-43.318	18.774-22.946	38.99	20.53	21.4	May. 02,2018
1900	39.38	20.86	35.442-43.318	18.774-22.946	36.00	19.25	21.3	May. 07,2018
2450	49.92	23.16	44.928-54.912	20.844-25.476	48.26	22.82	21.8	May. 04,2018

Note:

(1) We use a CW signal of 18dBm for system check, and then all SAR values are normalized to 1W forward power. The result must be within  $\pm 10\%$  of target value.

The results shown in this test report refer only to the sample(s) tested unless otherwise stated and the sample(s) are retained for 30 days only. The document is issued by AGC, this document cannot be reproduced except in full with our prior written permission. The more details and the authenticity of the report will be confirmed at <http://www.agc-cert.com>.

## 7. EUT TEST POSITION

This EUT was tested in **Right Cheek, Right Tilted, Left Cheek, Left Tilted, Body back, Body front and 4 edges.**

### 7.1. Define Two Imaginary Lines on the Handset

- (1) The vertical centerline passes through two points on the front side of the handset: the midpoint of the width  $w_t$  of the handset at the level of the acoustic output, and the midpoint of the width  $w_b$  of the handset.
- (2) The horizontal line is perpendicular to the vertical centerline and passes through the center of the acoustic output. The horizontal line is also tangential to the face of the handset at point A.
- (3) The two lines intersect at point A. Note that for many handsets, point A coincides with the center of the acoustic output; however, the acoustic output may be located elsewhere on the horizontal line. Also note that the vertical centerline is not necessarily to the front face of the handset, especially for clamshell handsets, handsets with flip covers, and other irregularly shaped handsets.

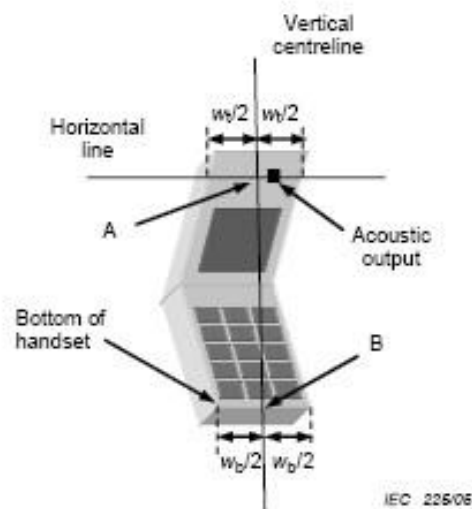
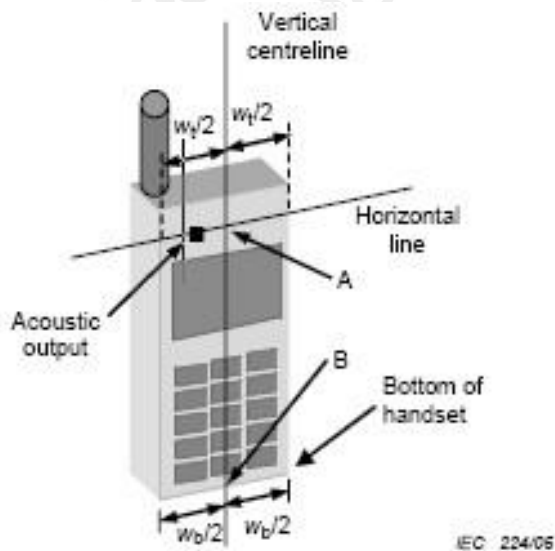

The results shown in this test report refer only to the sample(s) tested unless otherwise stated and the sample(s) are retained for 30 days only. The document is issued by AGC, this document cannot be reproduced except in full with our prior written permission. The more details and the authenticity of the report will be confirmed at <http://www.agc-cert.com>.



## 7.2. Cheek Position

- (1) To position the device with the vertical center line of the body of the device and the horizontal line crossing the center piece in a plane parallel to the sagittal plane of the phantom. While maintaining the device in this plane, align the vertical center line with the reference plane containing the ear and mouth reference point (M: Mouth, RE: Right Ear, and LE: Left Ear) and align the center of the ear piece with the line RE-LE.
- (2) To move the device towards the phantom with the ear piece aligned with the the line LE-RE until the phone touched the ear. While maintaining the device in the reference plane and maintaining the phone contact with ear, move the bottom of the phone until any point on the front side is in contact with the cheek of the phantom or until contact with the ear is lost



## 7.3. Tilt Position

- (1) To position the device in the “cheek” position described above.
- (2) While maintaining the device in the reference plane described above and pivoting against the ear, moves it outward away from the mouth by an angle of 15 degrees or until with the ear is lost.



The results shown in this test report refer only to the sample(s) tested unless otherwise stated and the sample(s) are retained for 30 days only. The document is issued by AGC, this document cannot be reproduced except in full with our prior written permission. The more details and the authenticity of the report will be confirmed at <http://www.agc-cert.com>.

#### 7.4. Body Worn Position

- (1) To position the EUT parallel to the phantom surface.
- (2) To adjust the EUT parallel to the flat phantom.
- (3) To adjust the distance between the EUT surface and the flat phantom to **5mm**.

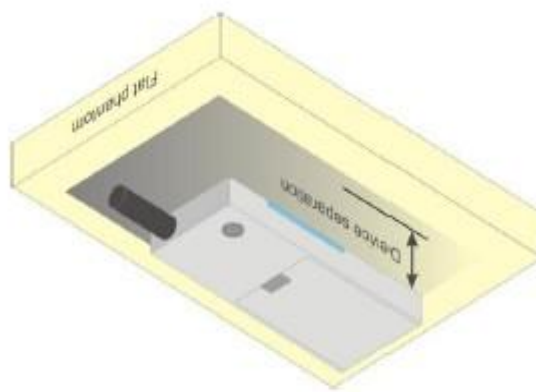
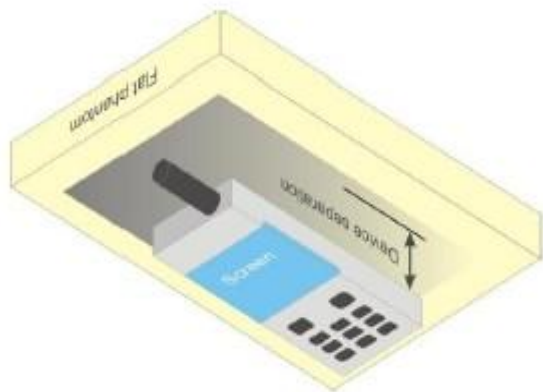

The results shown in this test report refer only to the sample(s) tested unless otherwise stated and the sample(s) are retained for 30 days only. The document is issued by AGC, this document cannot be reproduced except in full with our prior written permission. The more details and the authenticity of the report will be confirmed at <http://www.agc-cert.com>.



## 8. SAR EXPOSURE LIMITS

### Limits for General Population/Uncontrolled Exposure (W/kg)

Type Exposure	Uncontrolled Environment Limit (W/kg)
Spatial Peak SAR (1g cube tissue for brain or body)	1.60
Spatial Average SAR (Whole body)	0.08
Spatial Peak SAR (Limbs)	4.0

The results shown in this test report refer only to the sample(s) tested unless otherwise stated and the sample(s) are retained for 30 days only. The document is issued by AGC, this document cannot be reproduced except in full with our prior written permission. The more details and the authenticity of the report will be confirmed at <http://www.agc-cert.com>.

## 9. TEST FACILITY

<b>Test Site</b>	Attestation of Global Compliance (Shenzhen) Co., Ltd
<b>Location</b>	1-2F., Bldg.2, No.1-4, Chaxi Sanwei Technical Industrial Park, Gushu, Xixiang, Bao'an District B112-B113, Shenzhen 518012
<b>NVLAP Lab Code</b>	600153-0
<b>Designation Number</b>	CN5028
<b>Test Firm Registration Number</b>	682566
<b>Description</b>	Attestation of Global Compliance(Shenzhen) Co., Ltd is accredited by National Voluntary Laboratory Accreditation program, NVLAP Code 600153-0

The results shown in this test report refer only to the sample(s) tested unless otherwise stated and the sample(s) are retained for 30 days only. The document is issued by AGC, this document cannot be reproduced except in full with our prior written permission. The more details and the authenticity of the report will be confirmed at <http://www.agc-cert.com>.



## 10. TEST EQUIPMENT LIST

Equipment description	Manufacturer/ Model	Identification No.	Current calibration date	Next calibration date
SAR Probe	MVG	SN 08/16 EPGO282	Aug. 08,2017	Aug. 07,2018
Phantom	SATIMO	SN_4511_SAM90	Validated. No cal required.	Validated. No cal required.
Liquid	SATIMO	-	Validated. No cal required.	Validated. No cal required.
Comm Tester	Agilent-8960	GB46310822	Mar. 01,2018	Feb. 28,2019
Multimeter	Keithley 2000	1188656	Mar. 01,2018	Feb. 28,2019
Dipole	SATIMO SID835	SN29/15 DIP 0G835-383	July 05,2016	July 04,2019
Dipole	SATIMO SID1800	SN29/15 DIP 1G800-387	July 05,2016	July 04,2019
Dipole	SATIMO SID1900	SN 29/15 DIP 1G900-389	July 05,2016	July 04,2019
Dipole	SATIMO SID2450	SN29/15 DIP 2G450-393	July 05,2016	July 04,2019
Signal Generator	Agilent-E4438C	US41461365	Mar. 01,2018	Feb. 28,2019
Vector Analyzer	Agilent / E4440A	US41421290	Mar. 01,2018	Feb. 28,2019
Network Analyzer	Rhode & Schwarz ZVL6	SN100132	Mar. 01,2018	Feb. 28,2019
Attenuator	Warison /WATT-6SR1211	N/A	N/A	N/A
Attenuator	Mini-circuits / VAT-10+	N/A	N/A	N/A
Amplifier	EM30180	SN060552	Mar. 01,2018	Feb. 28,2019
Directional Couple	Werlatone/ C5571-10	SN99463	June 20,2017	June 19,2018
Directional Couple	Werlatone/ C6026-10	SN99482	June 20,2017	June 19,2018
Power Sensor	NRP-Z21	1137.6000.02	Oct. 12,2017	Oct. 11,2018
Power Sensor	NRP-Z23	US38261498	Mar. 01,2018	Feb. 28,2019
Power Viewer	R&S	V2.3.1.0	N/A	N/A

Note: Per KDB 865664 Dipole SAR Validation, AGC Lab has adopted 3 years calibration intervals. On annual basis, every measurement dipole has been evaluated and is in compliance with the following criteria:

1. There is no physical damage on the dipole;
2. System validation with specific dipole is within 10% of calibrated value;
3. Return-loss is within 20% of calibrated measurement;
4. Impedance is within 5Ω of calibrated measurement.

The results shown in this test report refer only to the sample(s) tested unless otherwise stated and the sample(s) are retained for 30 days only. The document is issued by AGC, this document cannot be reproduced except in full with our prior written permission. The more details and the authenticity of the report will be confirmed at <http://www.agc-cert.com>.

## 11. MEASUREMENT UNCERTAINTY

Measurement uncertainty for Dipole averaged over 1 gram / 10 gram.									
a	b	c	d	e f(d,k)	f	g	h cx/f/e	i cxg/e	k
Uncertainty Component	Sec.	Tol (± %)	Prob. Dist.	Div.	Ci (1g)	Ci (10g)	1g Ui (±%)	10g Ui (±%)	vi
<b>Measurement System</b>									
Probe calibration	E.2.1	5.831	N	1	1	1	5.83	5.83	∞
Axial Isotropy	E.2.2	0.695	R	$\sqrt{3}$	$\sqrt{0.5}$	$\sqrt{0.5}$	0.28	0.28	∞
Hemispherical Isotropy	E.2.2	1.045	R	$\sqrt{3}$	$\sqrt{0.5}$	$\sqrt{0.5}$	0.43	0.43	∞
Boundary effect	E.2.3	1.0	R	$\sqrt{3}$	1	1	0.58	0.58	∞
Linearity	E.2.4	0.685	R	$\sqrt{3}$	1	1	0.40	0.40	∞
System detection limits	E.2.4	1.0	R	$\sqrt{3}$	1	1	0.58	0.58	∞
Modulation response	E.2.5	3.0	R	$\sqrt{3}$	1	1	1.73	1.73	∞
Readout Electronics	E.2.6	0.021	N	1	1	1	0.021	0.021	∞
Response Time	E.2.7	0	R	$\sqrt{3}$	1	1	0	0	∞
Integration Time	E.2.8	1.4	R	$\sqrt{3}$	1	1	0.81	0.81	∞
RF ambient conditions-Noise	E.6.1	3.0	R	$\sqrt{3}$	1	1	1.73	1.73	∞
RF ambient conditions-reflections	E.6.1	3.0	R	$\sqrt{3}$	1	1	1.73	1.73	∞
Probe positioner mechanical tolerance	E.6.2	1.4	R	$\sqrt{3}$	1	1	0.81	0.81	∞
Probe positioning with respect to phantom shell	E.6.3	1.4	R	$\sqrt{3}$	1	1	0.81	0.81	∞
Extrapolation, interpolation, and integrations algorithms for max. SAR evaluation	E.5	2.3	R	$\sqrt{3}$	1	1	1.33	1.33	∞
<b>Test sample Related</b>									
Test sample positioning	E.4.2	2.6	N	1	1	1	2.6	2.6	∞
Device holder uncertainty	E.4.1	3	N	1	1	1	3	3	∞
Output power variation—SAR drift measurement	E.2.9	5	R	$\sqrt{3}$	1	1	2.89	2.89	∞
SAR scaling	E.6.5	5	R	$\sqrt{3}$	1	1	2.89	2.89	∞
<b>Phantom and tissue parameters</b>									
Phantom shell uncertainty—shape, thickness, and permittivity	E.3.1	4	R	$\sqrt{3}$	1	1	2.31	2.31	∞
Uncertainty in SAR correction for deviations in permittivity and conductivity	E.3.2	1.9	N	1	1	0.84	1.90	1.60	∞
Liquid conductivity measurement	E.3.3	4	N	1	0.78	0.71	3.12	2.84	M
Liquid permittivity measurement	E.3.3	5	N	1	0.23	0.26	1.15	1.30	M
Liquid conductivity—temperature uncertainty	E.3.4	2.5	R	$\sqrt{3}$	0.78	0.71	1.13	1.02	∞
Liquid permittivity—temperature uncertainty	E.3.4	2.5	R	$\sqrt{3}$	0.23	0.26	0.33	0.38	∞
Combined Standard Uncertainty			RSS				9.79	9.59	
Expanded Uncertainty (95% Confidence interval)			K=2				19.58	19.18	

The results shown in this test report refer only to the sample(s) tested unless otherwise stated and the sample(s) are retained for 30 days only. The document is issued by AGC, this document cannot be reproduced except in full with our prior written permission. The more details and the authenticity of the report will be confirmed at <http://www.agc-cert.com>.



System check uncertainty for Dipole averaged over 1 gram / 10 gram.									
a	b	c	d	e f(d,k)	f	g	h cx <sub>f</sub> /e	i cx <sub>g</sub> /e	k
Uncertainty Component	Sec.	Tol (±%)	Prob. Dist.	Div.	C <sub>i</sub> (1g)	C <sub>i</sub> (10g)	1g U <sub>i</sub> (±%)	10g U <sub>i</sub> (±%)	v <sub>i</sub>
<b>Measurement System</b>									
Probe calibration drift	E.2.1.3	0.5	N	1	1	1	0.50	0.50	∞
Axial Isotropy	E.2.2	0.695	R	√3	0	0	0.00	0.00	∞
Hemispherical Isotropy	E.2.2	1.045	R	√3	0	0	0.00	0.00	∞
Boundary effect	E.2.3	1.0	R	√3	0	0	0.00	0.00	∞
Linearity	E.2.4	0.685	R	√3	0	0	0.00	0.00	∞
System detection limits	E.2.4	1.0	R	√3	0	0	0.00	0.00	∞
Modulation response	E.2.5	3.0	R	√3	0	0	0.00	0.00	∞
Readout Electronics	E.2.6	0.021	N	1	0	0	0.00	0.00	∞
Response Time	E.2.7	0	R	√3	0	0	0.00	0.00	∞
Integration Time	E.2.8	1.4	R	√3	0	0	0.00	0.00	∞
RF ambient conditions-Noise	E.6.1	3.0	R	√3	0	0	0.00	0.00	∞
RF ambient conditions-reflections	E.6.1	3.0	R	√3	0	0	0.00	0.00	∞
Probe positioner mechanical tolerance	E.6.2	1.4	R	√3	1	1	0.81	0.81	∞
Probe positioning with respect to phantom shell	E.6.3	1.4	R	√3	1	1	0.81	0.81	∞
Extrapolation, interpolation, and integrations algorithms for max. SAR evaluation	E.5	2.3	R	√3	0	0	0.00	0.00	∞
<b>System check source (dipole)</b>									
Deviation of experimental dipoles	E.6.4	2	N	1	1	1	2	2	∞
Input power and SAR drift measurement	8,6.6.4	5	R	√3	1	1	2.89	2.89	∞
Dipole axis to liquid distance	8,E.6.6	2	R	√3	1	1	1.15	1.15	∞
<b>Phantom and tissue parameters</b>									
Phantom shell uncertainty—shape, thickness, and permittivity	E.3.1	4	R	√3	1	1	2.31	2.31	∞
Uncertainty in SAR correction for deviations in permittivity and conductivity	E.3.2	1.9	N	1	1	0.84	1.90	1.60	∞
Liquid conductivity measurement	E.3.3	4	N	1	0.78	0.71	3.12	2.84	M
Liquid permittivity measurement	E.3.3	5	N	1	0.23	0.26	1.15	1.30	M
Liquid conductivity—temperature uncertainty	E.3.4	2.5	R	√3	0.78	0.71	1.13	1.02	∞
Liquid permittivity—temperature uncertainty	E.3.4	2.5	R	√3	0.23	0.26	0.33	0.38	∞
Combined Standard Uncertainty				RSS			5.564	5.205	
Expanded Uncertainty (95% Confidence interval)				K=2			11.128	10.410	

The results shown in this test report refer only to the sample(s) tested unless otherwise stated and the sample(s) are retained for 30 days only. The document is issued by AGC, this document cannot be reproduced except in full with our prior written permission. The more details and the authenticity of the report will be confirmed at <http://www.agc-cert.com>.

System Validation uncertainty for Dipole averaged over 1 gram / 10 gram.									
a	b	c	d	e f(d,k)	f	g	h cx <sub>f</sub> /e	i cx <sub>g</sub> /e	k
Uncertainty Component	Sec.	Tol (±%)	Prob. Dist.	Div.	C <sub>i</sub> (1g)	C <sub>i</sub> (10g)	1g U <sub>i</sub> (±%)	10g U <sub>i</sub> (±%)	v <sub>i</sub>
<b>Measurement System</b>									
Probe calibration	E.2.1	5.831	N	1	1	1	5.83	5.83	∞
Axial Isotropy	E.2.2	0.695	R	√3	1	1	0.40	0.40	∞
Hemispherical Isotropy	E.2.2	1.045	R	√3	0	0	0.00	0.00	∞
Boundary effect	E.2.3	1.0	R	√3	1	1	0.58	0.58	∞
Linearity	E.2.4	0.685	R	√3	1	1	0.40	0.40	∞
System detection limits	E.2.4	1.0	R	√3	1	1	0.58	0.58	∞
Modulation response	E.2.5	3.0	R	√3	0	0	0.00	0.00	∞
Readout Electronics	E.2.6	0.021	N	1	1	1	0.021	0.021	∞
Response Time	E.2.7	0.0	R	√3	0	0	0.00	0.00	∞
Integration Time	E.2.8	1.4	R	√3	0	0	0.00	0.00	∞
RF ambient conditions-Noise	E.6.1	3.0	R	√3	1	1	1.73	1.73	∞
RF ambient conditions-reflections	E.6.1	3.0	R	√3	1	1	1.73	1.73	∞
Probe positioner mechanical tolerance	E.6.2	1.4	R	√3	1	1	0.81	0.81	∞
Probe positioning with respect to phantom shell	E.6.3	1.4	R	√3	1	1	0.81	0.81	∞
Extrapolation, interpolation, and integrations algorithms for max. SAR evaluation	E.5	2.3	R	√3	1	1	1.33	1.33	∞
<b>System check source (dipole)</b>									
Deviation of experimental dipole from numerical dipole	E.6.4	5.0	N	1	1	1	5.00	5.00	∞
Input power and SAR drift measurement	8,6.6.4	5.0	R	√3	1	1	2.89	2.89	∞
Dipole axis to liquid distance	8,E.6.6	2.0	R	√3	1	1	1.15	1.15	∞
<b>Phantom and tissue parameters</b>									
Phantom shell uncertainty—shape, thickness, and permittivity	E.3.1	4.0	R	√3	1	1	2.31	2.31	∞
Uncertainty in SAR correction for deviations in permittivity and conductivity	E.3.2	1.9	N	1	1	0.84	1.90	1.60	∞
Liquid conductivity measurement	E.3.3	4.0	N	1	0.78	0.71	3.12	2.84	M
Liquid permittivity measurement	E.3.3	5.0	N	1	0.23	0.26	1.15	1.30	M
Liquid conductivity—temperature uncertainty	E.3.4	2.5	R	√3	0.78	0.71	1.13	1.02	∞
Liquid permittivity—temperature uncertainty	E.3.4	2.5	R	√3	0.23	0.26	0.33	0.38	∞
Combined Standard Uncertainty			RSS				9.718	9.517	
Expanded Uncertainty (95% Confidence interval)			K=2				19.437	19.035	

The results shown in this test report refer only to the sample(s) tested unless otherwise stated and the sample(s) are retained for 30 days only. The document is issued by AGC, this document cannot be reproduced except in full with our prior written permission. The more details and the authenticity of the report will be confirmed at <http://www.agc-cert.com>.



## 12. CONDUCTED POWER MEASUREMENT

### GSM BAND

Mode	Frequency(MHz)	Avg. Burst Power(dBm)	Duty cycle Factor(dBm)	Frame Power(dBm)
Maximum Power <1>				
GSM 850	824.2	31.76	-9	22.76
	836.6	31.60	-9	22.60
	848.8	<b>31.77</b>	-9	22.77
GPRS 850 (1 Slot)	824.2	31.40	-9	22.40
	836.6	31.36	-9	22.36
	848.8	31.40	-9	22.40
GPRS 850 (2 Slot)	824.2	28.21	-6	22.21
	836.6	28.43	-6	<b>22.43</b>
	848.8	28.39	-6	22.39
GPRS 850 (3 Slot)	824.2	26.45	-4.26	22.19
	836.6	26.50	-4.26	22.24
	848.8	26.49	-4.26	22.23
GPRS 850 (4 Slot)	824.2	25.33	-3	22.33
	836.6	25.38	-3	22.38
	848.8	25.41	-3	22.41
Maximum Power <2>				
GSM 850	824.2	31.71	-9	22.71
	836.6	31.56	-9	22.56
	848.8	31.43	-9	22.43
GPRS 850 (1 Slot)	824.2	31.40	-9	22.40
	836.6	31.32	-9	22.32
	848.8	31.35	-9	22.35
GPRS 850 (2 Slot)	824.2	28.18	-6	22.18
	836.6	28.41	-6	22.41
	848.8	28.36	-6	22.36
GPRS 850 (3 Slot)	824.2	26.42	-4.26	22.16
	836.6	26.47	-4.26	22.21
	848.8	26.43	-4.26	22.17
GPRS 850 (4 Slot)	824.2	25.30	-3	22.30
	836.6	25.35	-3	22.35
	848.8	25.37	-3	22.37

The results shown in this test report refer only to the sample(s) tested unless otherwise stated and the sample(s) are retained for 30 days only. The document is issued by AGC, this document cannot be reproduced except in full with our prior written permission. The more details and the authenticity of the report will be confirmed at <http://www.agc-cert.com>.

**GSM BAND CONTINUE**

Mode	Frequency(MHz)	Avg. Burst Power(dBm)	Duty cycle Factor(dBm)	Frame Power(dBm)
Maximum Power <1>				
PCS1900	1850.2	28.46	-9	19.46
	1880	28.39	-9	19.39
	1909.8	<b>28.49</b>	-9	19.49
GPRS1900 (1 Slot)	1850.2	28.33	-9	19.33
	1880	28.41	-9	19.41
	1909.8	28.31	-9	19.31
GPRS1900 (2 Slot)	1850.2	25.34	-6	19.34
	1880	25.32	-6	19.32
	1909.8	25.40	-6	19.40
GPRS1900 (3 Slot)	1850.2	23.89	-4.26	<b>19.63</b>
	1880	23.77	-4.26	19.51
	1909.8	23.52	-4.26	19.26
GPRS1900 (4 Slot)	1850.2	22.52	-3	19.52
	1880	22.34	-3	19.34
	1909.8	22.41	-3	19.41
Maximum Power <2>				
PCS1900	1850.2	28.41	-9	19.41
	1880	28.36	-9	19.36
	1909.8	27.88	-9	18.88
GPRS1900 (1 Slot)	1850.2	28.30	-9	19.30
	1880	28.36	-9	19.36
	1909.8	28.28	-9	19.28
GPRS1900 (2 Slot)	1850.2	25.30	-6	19.30
	1880	25.25	-6	19.25
	1909.8	25.33	-6	19.33
GPRS1900 (3 Slot)	1850.2	23.85	-4.26	19.59
	1880	23.72	-4.26	19.46
	1909.8	23.50	-4.26	19.24
GPRS1900 (4 Slot)	1850.2	22.47	-3	19.47
	1880	22.31	-3	19.31
	1909.8	22.38	-3	19.38

**Note 1:**

The Frame Power (Source-based time-averaged Power) is scaled the maximum burst average power based on time slots. The calculated methods are show as following:

Frame Power = Max burst power (1 Up Slot) – 9 dB

Frame Power = Max burst power (2 Up Slot) – 6 dB

Frame Power = Max burst power (3 Up Slot) – 4.26 dB

Frame Power = Max burst power (4 Up Slot) – 3 dB

The results shown in this test report refer only to the sample(s) tested unless otherwise stated and the sample(s) are retained for 30 days only. The document is issued by AGC, this document cannot be reproduced except in full with our prior written permission. The more details and the authenticity of the report will be confirmed at <http://www.agc-cert.com>.



**UMTS BAND  
 HSDPA Setup Configuration:**

- The EUT was connected to Base Station Agilent E5515C referred to the Setup Configuration.
- The RF path losses were compensated into the measurements.
- A call was established between EUT and Based Station with following setting:
  - (1) Set Gain Factors( $\beta_c$  and  $\beta_d$ ) parameters set according to each
  - (2) Set RMC 12.2Kbps+HSDPA mode.
  - (3) Set Cell Power=-86dBm
  - (4) Set HS-DSCH Configuration Type to FRC (H-set 1, QPSK)
  - (5) Select HSDPA Uplink Parameters
  - (6) Set Delta ACK, Delta NACK and Delta CQI=8
  - (7) Set Ack - Nack Repetition Factor to 3
  - (8) Set CQI Feedback Cycle (k) to 4ms
  - (9) Set CQI Repetition Factor to 2
  - (10) Power Ctrl Mode=All Up bits
- The transmitted maximum output power was recorded.

 Table C.10.2.4:  $\beta$  values for transmitter characteristics tests with HS-DPCCH

Sub-test	$\beta_c$ (Note5)	$\beta_d$	$\beta_d$ (SF)	$\beta_c/\beta_d$	$\beta_{HS}$ (Note1, Note 2)	CM (dB) (Note 3)	MPR (dB) (Note 3)
1	2/15	15/15	64	2/15	4/15	0.0	0.0
2	12/15(Note 4)	15/15(Note 4)	64	12/15(Note 4)	24/15	1.0	0.0
3	15/15	8/15	64	15/8	30/15	1.5	0.5
4	15/15	4/15	64	15/4	30/15	1.5	0.5

Note 1:  $\Delta ACK, \Delta NACK$  and  $\Delta CQI = 30/15$  with  $\beta_{hs} = 30/15 * \beta_c$ .

Note 2: For the HS-DPCCH power mask requirement test in clause 5.2C, 5.7A, and the Error Vector Magnitude (EVM) with HS-DPCCH test in clause 5.13.1A, and HSDPA EVM with phase discontinuity in clause 5.13.1AA,  $\Delta ACK$  and  $\Delta NACK = 30/15$  with  $\beta_{hs} = 30/15 * \beta_c$ , and  $\Delta CQI = 24/15$  with  $\beta_{hs} = 24/15 * \beta_c$ .

Note 3: CM = 1 for  $\beta_c/\beta_d = 12/15$ ,  $h_s/c = 24/15$ . For all other combinations of DPDCH, DPCCH and HS-DPCCH the MPR is based on the relative CM difference. This is applicable for only UEs that support HSDPA in release 6 and later releases.

Note 4: For subtest 2 the  $c/d$  ratio of 12/15 for the TFC during the measurement period (TF1, TF0) is achieved by setting the signalled gain factors for the reference TFC (TF1, TF1) to  $c = 11/15$  and  $d = 15/15$ .

The results shown in this test report refer only to the sample(s) tested unless otherwise stated and the sample(s) are retained for 30 days only. The document is issued by AGC, this document cannot be reproduced except in full with our prior written permission. The more details and the authenticity of the report will be confirmed at <http://www.agc-cert.com>.

**HSUPA Setup Configuration:**

- The EUT was connected to Base Station Agilent E5515C referred to the Setup Configuration.
- The RF path losses were compensated into the measurements.
- A call was established between EUT and Base Station with following setting \* :
  - (1) Call Configs = 5.2B, 5.9B, 5.10B, and 5.13.2B with QPSK
  - (2) Set the Gain Factors ( $\beta_c$  and  $\beta_d$ ) and parameters (AG Index) were set according to each specific sub-test in the following table, C11.1.3, quoted from the TS 34.121
  - (3) Set Cell Power = -86 dBm
  - (4) Set Channel Type = 12.2k + HSPA
  - (5) Set UE Target Power
  - (6) Power Ctrl Mode= Alternating bits
  - (7) Set and observe the E-TFCI
  - (8) Confirm that E-TFCI is equal to the target E-TFCI of 75 for sub-test 1, and other subtest's E-TFCI
- The transmitted maximum output power was recorded.

 Table C.11.1.3:  $\beta$  values for transmitter characteristics tests with HS-DPCCH and E-DCH

Sub-test	$\beta_c$	$\beta_d$	$\beta_d$ (SF)	$\beta_c/\beta_d$	$\beta_{HS}$ (Note 1)	$\beta_{ec}$	$\beta_{ed}$ (Note 4) (Note 5)	$\beta_{ed}$ (SF)	$\beta_{ed}$ (Code s)	CM (dB) (Note 2)	MPR (dB) (Note 2) (Note 6)	AG Index (Note 5)	E-TF CI
1	11/15 (Note 3)	15/15 (Note 3)	64	11/15 (Note 3)	22/15	209/225	1309/225	4	1	1.0	0.0	20	75
2	6/15	15/15	64	6/15	12/15	12/15	94/75	4	1	3.0	2.0	12	67
3	15/15	9/15	64	15/9	30/15	30/15	$\beta_{ed1}$ : 47/15 $\beta_{ed2}$ : 47/15	4	2	2.0	1.0	15	92
4	2/15	15/15	64	2/15	4/15	2/15	56/75	4	1	3.0	2.0	17	71
5	15/15	0	-	-	5/15	5/15	47/15	4	1	1.0	0.0	12	67

Note 1: For sub-test 1 to 4,  $\Delta ACK$ ,  $\Delta NACK$  and  $\Delta CQI = 30/15$  with  $\beta_{hs} = 30/15 * \beta_c$ . For sub-test 5,  $\Delta ACK$ ,  $\Delta NACK$  and  $\Delta CQI = 5/15$  with  $\beta_{hs} = 5/15 * \beta_c$ .

Note 2: CM = 1 for  $\beta_c/\beta_d = 12/15$ ,  $hs/c = 24/15$ . For all other combinations of DPDCH, DPCCH, HS-DPCCH, E-DPDCH and E-DPCCH the MPR is based on the relative CM difference.

Note 3: For subtest 1 the  $c/d$  ratio of 11/15 for the TFC during the measurement period (TF1, TF0) is achieved by setting the signalled gain factors for the reference TFC (TF1, TF1) to  $c = 10/15$  and  $d = 15/15$ .

Note 4: In case of testing by UE using E-DPDCH Physical Layer category 1, Sub-test 3 is omitted according to TS25.306 Table 5.1g.

Note 5:  $\beta_{ed}$  cannot be set directly; it is set by Absolute Grant Value.

Note 6: For subtests 2, 3 and 4, UE may perform E-DPDCH power scaling at max power which could results in slightly smaller MPR values.



**UMTS BAND II**

Mode	Frequency (MHz)	Avg. Burst Power (dBm)
WCDMA 1900 RMC	1852.4	21.44
	1880	21.32
	1907.6	21.25
WCDMA 1900 AMR	1852.4	21.40
	1880	21.37
	1907.6	21.26
HSDPA Subtest 1	1852.4	20.49
	1880	20.52
	1907.6	20.43
HSDPA Subtest 2	1852.4	21.17
	1880	21.10
	1907.6	21.22
HSDPA Subtest 3	1852.4	20.56
	1880	20.66
	1907.6	20.59
HSDPA Subtest 4	1852.4	21.03
	1880	21.19
	1907.6	21.22
HSUPA Subtest 1	1852.4	20.26
	1880	20.17
	1907.6	20.34
HSUPA Subtest 2	1852.4	20.44
	1880	20.49
	1907.6	20.52
HSUPA Subtest 3	1852.4	20.11
	1880	20.59
	1907.6	20.64
HSUPA Subtest 4	1852.4	20.18
	1880	20.46
	1907.6	20.39
HSUPA Subtest 5	1852.4	20.45
	1880	20.21
	1907.6	20.44

The results shown in this test report refer only to the sample(s) tested unless otherwise stated and the sample(s) are retained for 30 days only. The document is issued by AGC, this document cannot be reproduced except in full with our prior written permission. The more details and the authenticity of the report will be confirmed at <http://www.agc-cert.com>.

**UMTS BAND V**

Mode	Frequency (MHz)	Avg. Burst Power (dBm)
WCDMA 850 RMC	826.4	21.36
	836.6	21.47
	846.6	<b>21.59</b>
WCDMA 850 AMR	826.4	20.42
	836.6	20.59
	846.6	20.48
HSDPA Subtest 1	826.4	20.26
	836.6	20.47
	846.6	20.64
HSDPA Subtest 2	826.4	20.79
	836.6	20.84
	846.6	20.65
HSDPA Subtest 3	826.4	20.56
	836.6	20.52
	846.6	20.69
HSDPA Subtest 4	826.4	20.33
	836.6	20.46
	846.6	20.42
HSUPA Subtest 1	826.4	21.12
	836.6	21.10
	846.6	21.04
HSUPA Subtest 2	826.4	20.24
	836.6	20.25
	846.6	20.33
HSUPA Subtest 3	826.4	20.50
	836.6	20.49
	846.6	20.57
HSUPA Subtest 4	826.4	20.17
	836.6	20.16
	846.6	20.22
HSUPA Subtest 5	826.4	20.33
	836.6	20.41
	846.6	20.44

The results shown in this test report refer only to the sample(s) tested unless otherwise stated and the sample(s) are retained for 30 days only. The document is issued by AGC, this document cannot be reproduced except in full with our prior written permission. The more details and the authenticity of the report will be confirmed at <http://www.agc-cert.com>.



**UMTS BAND IV**

Mode	Frequency (MHz)	Avg. Burst Power (dBm)
WCDMA 1700 RMC	1712.5	21.44
	1732.5	21.54
	1752.5	<b>21.59</b>
WCDMA 1700 AMR	1712.5	21.11
	1732.5	21.22
	1752.5	21.30
HSDPA Subtest 1	1712.5	20.54
	1732.5	20.39
	1752.5	20.40
HSDPA Subtest 2	1712.5	20.32
	1732.5	20.47
	1752.5	20.29
HSDPA Subtest 3	1712.5	20.01
	1732.5	20.06
	1752.5	20.05
HSDPA Subtest 4	1712.5	20.34
	1732.5	20.40
	1752.5	20.35
HSUPA Subtest 1	1712.5	20.09
	1732.5	20.11
	1752.5	20.04
HSUPA Subtest 2	1712.5	20.41
	1732.5	20.29
	1752.5	20.38
HSUPA Subtest 3	1712.5	20.42
	1732.5	20.44
	1752.5	20.37
HSUPA Subtest 4	1712.5	20.01
	1732.5	19.99
	1752.5	19.95
HSUPA Subtest 5	1712.5	20.33
	1732.5	20.24
	1752.5	20.31

The results shown in this test report refer only to the sample(s) tested unless otherwise stated and the sample(s) are retained for 30 days only. The document is issued by AGC, this document cannot be reproduced except in full with our prior written permission. The more details and the authenticity of the report will be confirmed at <http://www.agc-cert.com>.

According to 3GPP 25.101 sub-clause 6.2.2 , the maximum output power is allowed to be reduced by following the table.

Table 6.1aA: UE maximum output power with HS-DPCCH and E-DCH

UE Transmit Channel Configuration	CM(db)	MPR(db)
For all combinations of ,DPDCH,DPCCH HS-DPDCH,E-DPDCH and E-DPCCH	$0 \leq CM \leq 3.5$	$MAX(CM-1,0)$

Note: CM=1 for  $\beta_d/\beta_{d1}=12/15$ ,  $\beta_{ns}/\beta_c=24/15$ . For all other combinations of DPDCH, DPCCH, HS-DPCCH, E-DPDCH and E-DPCCH the MPR is based on the relative CM difference.

The device supports MPR to solve linearity issues (ACLR or SEM) due to the higher peak-to average ratios (PAR) of the HSUPA signal. This prevents saturating the full range of the TX DAC inside of device and provides a reduced power output to the RF transceiver chip according to the Cubic Metric (a function of the combinations of DPDCH, DPCCH, HS-DPCCH, E-DPDCH and E-DPCCH).

When E-DPDCH channels are present the beta gains on those channels are reduced firsts to try to get the power under the allowed limit. If the beta gains are lowered as far as possible, then a hard limiting is applied at the maximum allowed level.

The SW currently recalculates the cubic metric every time the beta gains on the E-DPDCH are reduced. The cubic metric will likely get lower each time this is done .However, there is no reported reduction of maximum output power in the HSUPA mode since the device also provides a compensation for the power back-off by increasing the gain of TX\_AGC in the transceiver (PA) device.

The end effect is that the DUT output power is identical to the case where there is no MPR in the device.

The results shown in this test report refer only to the sample(s) tested unless otherwise stated and the sample(s) are retained for 30 days only. The document is issued by AGC, this document cannot be reproduced except in full with our prior written permission. The more details and the authenticity of the report will be confirmed at <http://www.agc-cert.com>.



**WIFI**

Mode	Data Rate (Mbps)	Channel	Frequency(MHz)	Average Power (dBm)
802.11b	1	01	2412	<b>14.07</b>
		06	2437	13.04
		11	2462	13.84
802.11g	6	01	2412	8.78
		06	2437	10.66
		11	2462	10.98
802.11n(20)	6.5	01	2412	8.76
		06	2437	10.79
		11	2462	11.09
802.11n(40)	13.5	03	2422	8.59
		06	2437	8.44
		09	2452	9.06

**Bluetooth\_V3.0(BR/EDR)**

Modulation	Channel	Frequency(MHz)	Peak Power (dBm)
GFSK	0	2402	2.502
	39	2441	<b>2.760</b>
	78	2480	2.201
π/4-DQPSK	0	2402	1.994
	39	2441	2.271
	78	2480	1.710
8-DPSK	0	2402	1.554
	39	2441	1.840
	78	2480	1.311

**Bluetooth\_V4.0(BLE)**

Modulation	Channel	Frequency(MHz)	Peak Power (dBm)
GFSK	0	2402	-5.169
	19	2440	-4.752
	39	2480	-5.369

The results shown in this test report refer only to the sample(s) tested unless otherwise stated and the sample(s) are retained for 30 days only. The document is issued by AGC, this document cannot be reproduced except in full with our prior written permission. The more details and the authenticity of the report will be confirmed at <http://www.agc-cert.com>.

## 13. TEST RESULTS

### 13.1. SAR Test Results Summary

#### 13.1.1. Test position and configuration

Head SAR was performed with the device configured in the positions according to IEEE 1528-2013, Body-worn SAR was performed with the device 5mm from the phantom, and 4 Edges SAR was performed with the device 10mm from the phantom.

#### 13.1.2. Operation Mode

1. Per KDB 447498 D01 v06 ,for each exposure position, if the highest 1-g SAR is  $\leq 0.8$  W/kg, testing for low and high channel is optional.
2. Per KDB 865664 D01 v01r04,for each frequency band, if the measured SAR is  $\geq 0.8$ W/Kg, testing for repeated SAR measurement is required , that the highest measured SAR is only to be tested. When the SAR results are near the limit, the following procedures are required for each device to verify these types of SAR measurement related variation concerns by repeating the highest measured SAR configuration in each frequency band.
  - (1) When the original highest measured SAR is  $\geq 0.8$ W/Kg, repeat that measurement once.
  - (2) Perform a second repeated measurement only if the ratio of largest to smallest SAR for the original and first repeated measurements is  $>1.20$  or when the original or repeated measurement is  $\geq 1.45$  W/Kg.
  - (3) Perform a third repeated measurement only if the original, first and second repeated measurement is  $\geq 1.5$  W/Kg and ratio of largest to smallest SAR for the original, first and second measurement is  $\geq 1.20$ .
3. Body-worn exposure conditions are intended to voice call operations, therefore GSM voice call mode is selected to be test.
4. Per KDB 648474 D04 v01r03,when the reported SAR for a body-worn accessory measured without a headset connected to the handset is  $\leq 1.2$ W/Kg, SAR testing with a headset connected is not required.
5. Per KDB 248227 D01v02r02,for 2.4GHz 802.11g/n SAR testing is not required when the highest reported SAR for DSSS is adjusted by the ratio of OFDM to DSSS specified maximum output power and the adjusted SAR is  $\leq 1.2$ W/kg.
6. Per KDB 941225 D06 V02r01, When the same wireless mode transmission configurations for voice and data are required for SAR measurements, the more conservative configuration with a smaller separation distance should be tested for the overlapping SAR configurations.
7. Maximum Scaling SAR in order to calculate the Maximum SAR values to test under the standard Peak Power, Calculation method is as follows:  
Maximum Scaling SAR =tested SAR (Max.)  $\times$  [maximum turn-up power (mw)/ maximum measurement output power(mw) ]
8. Proximity sensor, just for avoiding the wrong operation in the phone screen when call, and has no influence on output power or SAR result

The results shown in this test report refer only to the sample(s) tested unless otherwise stated and the sample(s) are retained for 30 days only. The document is issued by AGC, this document cannot be reproduced except in full with our prior written permission. The more details and the authenticity of the report will be confirmed at <http://www.agc-cert.com>.



**13.1.3. Test Result**

SAR MEASUREMENT									
Depth of Liquid (cm):>15					Relative Humidity (%): 50.3				
Product: Smart Phone									
Test Mode: GSM850 with GMSK modulation									
Position	Mode	Ch.	Fr. (MHz)	Power Drift (<math>\pm 5\%</math>)	SAR (1g) (W/kg)	Max. Tune-up Power (dBm)	Meas. output Power (dBm)	Scaled SAR (W/Kg)	Limit (W/kg)
<b>SIM 1 Card</b>									
Left Cheek	voice	190	836.6	-0.15	0.138	31.77	31.60	0.144	1.6
Left Tilt	voice	190	836.6	0.22	0.092	31.77	31.60	0.096	1.6
Right Cheek	voice	190	836.6	0.13	<b>0.180</b>	31.77	31.60	<b>0.187</b>	1.6
Right Tilt	voice	190	836.6	-0.06	0.089	31.77	31.60	0.093	1.6
Body back	voice	190	836.6	-0.11	<b>0.401</b>	31.77	31.60	<b>0.417</b>	1.6
Body front	voice	190	836.6	0.02	0.240	31.77	31.60	0.250	1.6
Left Cheek	GPRS-2 slot	190	836.6	-0.00	0.133	28.50	28.43	0.135	1.6
Left Tilt	GPRS-2 slot	190	836.6	-0.10	0.087	28.50	28.43	0.088	1.6
Right Cheek	GPRS-2 slot	190	836.6	-0.04	<b>0.165</b>	28.50	28.43	<b>0.168</b>	1.6
Right Tilt	GPRS-2 slot	190	836.6	0.17	0.090	28.50	28.43	0.091	1.6
Body back	GPRS-2 slot	190	836.6	0.02	<b>0.413</b>	28.50	28.43	<b>0.420</b>	1.6
Body front	GPRS-2 slot	190	836.6	-0.07	0.237	28.50	28.43	0.241	1.6
Edge 1 (Top)	GPRS-2 slot	190	836.6	0.08	0.009	28.50	28.43	0.009	1.6
Edge 2(Right)	GPRS-2 slot	190	836.6	-0.18	0.173	28.50	28.43	0.176	1.6
Edge 3(Bottom)	GPRS-2 slot	190	836.6	-0.36	0.094	28.50	28.43	0.096	1.6
Edge 4(Left)	GPRS-2 slot	190	836.6	0.05	0.099	28.50	28.43	0.101	1.6

Note:

- When the 1-g Reported SAR is  $\leq 0.8$  W/kg, testing for low and high channel is optional. Refer to KDB 447498.
- The test separation for body back and body front is 5mm of all above table.
- The test separation for 4 Edges is 10mm of all above table.
- Measurements for SIM Card 2 are not conducted since SIM Card 1 show the highest output power

The results shown in this test report refer only to the sample(s) tested unless otherwise stated and the sample(s) are retained for 30 days only. The document is issued by AGC, this document cannot be reproduced except in full with our prior written permission. The more details and the authenticity of the report will be confirmed at <http://www.agc-cert.com>.

SAR MEASUREMENT									
Depth of Liquid (cm):>15					Relative Humidity (%): 51.5				
Product: Smart Phone									
Test Mode: PCS1900 with GMSK modulation									
Position	Mode	Ch.	Fr. (MHz)	Power Drift (<math>\leq \pm 5\%</math>)	SAR (1g) (W/kg)	Max. Tune-up Power (dBm)	Meas. output Power (dBm)	Scaled SAR (W/Kg)	Limit (W/kg)
<b>SIM 1 Card</b>									
Left Cheek	voice	661	1880.0	-0.31	0.068	28.50	28.39	0.070	1.6
Left Tilt	voice	661	1880.0	0.22	0.032	28.50	28.39	0.033	1.6
Right Cheek	voice	661	1880.0	0.56	<b>0.069</b>	28.50	28.39	<b>0.071</b>	1.6
Right Tilt	voice	661	1880.0	-0.13	0.019	28.50	28.39	0.019	1.6
Body back	voice	661	1880.0	0.01	<b>0.475</b>	28.50	28.39	<b>0.487</b>	1.6
Body front	voice	661	1880.0	0.07	0.418	28.50	28.39	0.429	1.6
Left Cheek	GPRS-3 slot	661	1880.0	-0.32	<b>0.086</b>	23.89	23.77	<b>0.088</b>	1.6
Left Tilt	GPRS-3 slot	661	1880.0	0.16	0.042	23.89	23.77	0.043	1.6
Right Cheek	GPRS-3 slot	661	1880.0	-0.03	0.051	23.89	23.77	0.052	1.6
Right Tilt	GPRS-3 slot	661	1880.0	-0.01	0.017	23.89	23.77	0.017	1.6
Body back	GPRS-3 slot	661	1880.0	0.20	<b>0.618</b>	23.89	23.77	<b>0.635</b>	1.6
Body front	GPRS-3 slot	661	1880.0	0.08	0.530	23.89	23.77	0.545	1.6
Edge 1 (Top)	GPRS-3 slot	661	1880.0	-0.19	0.024	23.89	23.77	0.025	1.6
Edge 2(Right)	GPRS-3 slot	661	1880.0	-0.03	0.076	23.89	23.77	0.078	1.6
Edge 3(Bottom)	GPRS-3 slot	661	1880.0	-0.17	0.485	23.89	23.77	0.499	1.6
Edge 4(Left)	GPRS-3 slot	661	1880.0	0.04	0.100	23.89	23.77	0.103	1.6

**Note:**

- When the 1-g Reported SAR is  $\leq 0.8$  W/kg, testing for low and high channel is optional. Refer to KDB 447498.
- The test separation for body back and body front is 5mm of all above table.
- The test separation for 4 Edges is 10mm of all above table.
- Measurements for SIM Card 2 are not conducted since SIM Card 1 show the highest output power

The results shown in this test report refer only to the sample(s) tested unless otherwise stated and the sample(s) are retained for 30 days only. The document is issued by AGC, this document cannot be reproduced except in full with our prior written permission. The more details and the authenticity of the report will be confirmed at <http://www.agc-cert.com>.



SAR MEASUREMENT									
Depth of Liquid (cm):>15					Relative Humidity (%):50.7				
Product: Smart Phone									
Test Mode: WCDMA Band II with QPSK modulation									
Position	Mode	Ch.	Fr. (MHz)	Power Drift (<±5%)	SAR (1g) (W/kg)	Max. Tune-up Power (dBm)	Meas. output Power (dBm)	Scaled SAR (W/Kg)	Limit (W/kg)
Left Cheek	RMC 12.2kbps	9400	1880	-0.33	<b>0.195</b>	21.50	21.32	<b>0.203</b>	1.6
Left Tilt	RMC 12.2kbps	9400	1880	-0.11	0.065	21.50	21.32	0.068	1.6
Right Cheek	RMC 12.2kbps	9400	1880	0.02	0.090	21.50	21.32	0.094	1.6
Right Tilt	RMC 12.2kbps	9400	1880	-0.06	0.049	21.50	21.32	0.051	1.6
Body back	RMC 12.2kbps	9262	1852.4	-0.15	0.950	21.50	21.44	0.963	1.6
Body back	RMC 12.2kbps	9400	1880	0.28	<b>1.125</b>	21.50	21.32	<b>1.173</b>	1.6
Body back	RMC 12.2kbps	9538	1907.6	0.53	1.098	21.50	21.25	1.163	1.6
Body front	RMC 12.2kbps	9262	1852.4	0.16	0.937	21.50	21.44	0.950	1.6
Body front	RMC 12.2kbps	9400	1880	-0.25	1.066	21.50	21.32	1.111	1.6
Body front	RMC 12.2kbps	9538	1907.6	-0.12	1.063	21.50	21.25	1.126	1.6
Edge 1 (Top)	RMC 12.2kbps	9400	1880	-0.15	0.040	21.50	21.32	0.042	1.6
Edge 2(Right)	RMC 12.2kbps	9400	1880	0.14	0.116	21.50	21.32	0.121	1.6
Edge 3(Bottom)	RMC 12.2kbps	9262	1852.4	0.15	0.784	21.50	21.44	0.795	1.6
Edge 3(Bottom)	RMC 12.2kbps	9400	1880	-0.26	0.881	21.50	21.32	0.918	1.6
Edge 3(Bottom)	RMC 12.2kbps	9538	1907.6	0.53	0.908	21.50	21.25	0.962	1.6
Edge 4(Left)	RMC 12.2kbps	9400	1880	0.12	0.192	21.50	21.32	0.200	1.6

**Note:**

- When the 1-g Reported SAR is  $\leq 0.8$  W/kg, testing for low and high channel is optional. Refer to KDB 447498.
- The test separation for body back and body front is 5mm of all above table.
- The test separation for 4 Edges is 10mm of all above table.

The results shown in this test report refer only to the sample(s) tested unless otherwise stated and the sample(s) are retained for 30 days only. The document is issued by AGC, this document cannot be reproduced except in full with our prior written permission. The more details and the authenticity of the report will be confirmed at <http://www.agc-cert.com>.

SAR MEASUREMENT									
Depth of Liquid (cm):>15					Relative Humidity (%): 50.3				
Product: Smart Phone									
Test Mode: WCDMA Band V with QPSK modulation									
Position	Mode	Ch.	Fr. (MHz)	Power Drift (<math>\leq \pm 5\%</math>)	SAR (1g) (W/kg)	Max. Tune-up Power (dBm)	Meas. output Power (dBm)	Scaled SAR (W/Kg)	Limit (W/kg)
Left Cheek	RMC 12.2kbps	4183	836.6	-0.33	0.147	21.59	21.47	0.151	1.6
Left Tilt	RMC 12.2kbps	4183	836.6	0.26	0.140	21.59	21.47	0.144	1.6
Right Cheek	RMC 12.2kbps	4183	836.6	-0.51	<b>0.181</b>	21.59	21.47	<b>0.186</b>	1.6
Right Tilt	RMC 12.2kbps	4183	836.6	-0.20	0.118	21.59	21.47	0.121	1.6
Body back	RMC 12.2kbps	4183	836.6	0.03	<b>0.516</b>	21.59	21.47	<b>0.530</b>	1.6
Body front	RMC 12.2kbps	4183	836.6	0.18	0.276	21.59	21.47	0.284	1.6
Edge 1 (Top)	RMC 12.2kbps	4183	836.6	-0.13	0.009	21.59	21.47	0.009	1.6
Edge 2(Right)	RMC 12.2kbps	4183	836.6	-0.25	0.202	21.59	21.47	0.208	1.6
Edge 3(Bottom)	RMC 12.2kbps	4183	836.6	0.19	0.113	21.59	21.47	0.116	1.6
Edge 4(Left)	RMC 12.2kbps	4183	836.6	0.06	0.114	21.59	21.47	0.117	1.6

Note:

- When the 1-g Reported SAR is  $\leq 0.8$  W/kg, testing for low and high channel is optional. Refer to KDB 447498.
- The test separation for body back and body front is 5mm of all above table.
- The test separation for 4 Edges is 10mm of all above table.

The results shown in this test report refer only to the sample(s) tested unless otherwise stated and the sample(s) are retained for 30 days only. The document is issued by AGC, this document cannot be reproduced except in full with our prior written permission. The more details and the authenticity of the report will be confirmed at <http://www.agc-cert.com>.



SAR MEASUREMENT									
Depth of Liquid (cm):>15					Relative Humidity (%): 48.1				
Product: Mobile Phone									
Test Mode: WCDMA Band IV with QPSK modulation									
Position	Mode	Ch.	Fr. (MHz)	Power Drift (<math>\leq \pm 5\%</math>)	SAR (1g) (W/kg)	Max. Tune-up Power (dBm)	Meas. output Power (dBm)	Scaled SAR (W/Kg)	Limit (W/kg)
Left Cheek	RMC 12.2kbps	8662	1732.5	-0.28	<b>0.172</b>	21.60	21.54	<b>0.174</b>	1.6
Left Tilt	RMC 12.2kbps	8662	1732.5	-0.53	0.071	21.60	21.54	0.072	1.6
Right Cheek	RMC 12.2kbps	8662	1732.5	0.16	0.134	21.60	21.54	0.136	1.6
Right Tilt	RMC 12.2kbps	8662	1732.5	-0.12	0.038	21.60	21.54	0.039	1.6
Body back	RMC 12.2kbps	8662	1732.5	0.05	0.721	21.60	21.54	0.731	1.6
Body front	RMC 12.2kbps	8562	1712.5	0.17	0.814	21.60	21.44	0.845	1.6
Body front	RMC 12.2kbps	8662	1732.5	0.04	0.858	21.60	21.54	0.870	1.6
Body front	RMC 12.2kbps	8763	1752.5	-0.20	<b>0.870</b>	21.60	21.59	<b>0.872</b>	1.6
Edge 1 (Top)	RMC 12.2kbps	8662	1732.5	0.03	0.026	21.60	21.54	0.026	1.6
Edge 2(Right)	RMC 12.2kbps	8662	1732.5	0.16	0.076	21.60	21.54	0.077	1.6
Edge 3(Bottom)	RMC 12.2kbps	8662	1732.5	-0.01	0.457	21.60	21.54	0.463	1.6
Edge 4(Left)	RMC 12.2kbps	8662	1732.5	-0.32	0.094	21.60	21.54	0.095	1.6

Note:

- When the 1-g Reported SAR is  $\leq 0.8$  W/kg, testing for low and high channel is optional. Refer to KDB 447498.
- The test separation for body back and body front is 5mm of all above table.
- The test separation for 4 Edges is 10mm of all above table.

The results shown in this test report refer only to the sample(s) tested unless otherwise stated and the sample(s) are retained for 30 days only. The document is issued by AGC, this document cannot be reproduced except in full with our prior written permission. The more details and the authenticity of the report will be confirmed at <http://www.agc-cert.com>.

SAR MEASUREMENT									
Depth of Liquid (cm):>15					Relative Humidity (%): 47.5				
Product: Smart Phone									
Test Mode:802.11b									
Position	Mode	Ch.	Fr. (MHz)	Power Drift (<±5%)	SAR (1g) (W/kg)	Max. Tune-up Power (dBm)	Meas. output Power (dBm)	Scaled SAR (W/Kg)	Limit (W/kg)
Left Cheek	DTS	6	2437	-0.25	0.191	14.07	13.04	0.242	1.6
Left Tilt	DTS	6	2437	0.16	0.212	14.07	13.04	0.269	1.6
Right Cheek	DTS	6	2437	-0.07	0.216	14.07	13.04	0.274	1.6
Right Tilt	DTS	6	2437	-0.23	<b>0.230</b>	14.07	13.04	<b>0.292</b>	1.6
Body back	DTS	6	2437	0.05	<b>0.231</b>	14.07	13.04	<b>0.293</b>	1.6
Body front	DTS	6	2437	-0.18	0.139	14.07	13.04	0.176	1.6
Edge 1 (Top)	DTS	6	2437	0.09	0.101	14.07	13.04	0.128	1.6
Edge 2(Right)	DTS	6	2437	-0.04	0.031	14.07	13.04	0.039	1.6
Edge 3(Bottom)	DTS	6	2437	-0.41	0.006	14.07	13.04	0.008	1.6
Edge 4(Left)	DTS	6	2437	0.06	0.059	14.07	13.04	0.075	1.6

Note:

- According to KDB248227, for 2.4GHz 802.11g/n SAR testing is not required when the highest reported SAR for DSSS is adjusted by the ratio of OFDM to DSSS specified maximum output power and the adjusted SAR is  $\leq 1.2W/kg$ .
- All of above "DTS" means data transmitters.
- The test separation for body back and body front is 5mm of all above table.
- The test separation for 4 Edges is 10mm of all above table.

Repeated SAR										
Product: Smart Phone										
Test Mode: WCDMA Band II& WCDMA Band IV										
Position	Mode	Ch.	Fr. (MHz)	Power Drift (<±5%)	Once SAR (1g) (W/kg)	Power Drift (<±5%)	Twice SAR (1g) (W/kg)	Power Drift (<±5%)	Third SAR (1g) (W/kg)	Limit (W/kg)
Body back	RMC 12.2kbps	9400	1880	-0.05	1.106	--	--	--	--	1.6
Body front	RMC 12.2kbps	8763	1752.5	0.12	0.808	--	--	--	--	1.6

The results shown in this test report refer only to the sample(s) tested unless otherwise stated and the sample(s) are retained for 30 days only. The document is issued by AGC, this document cannot be reproduced except in full with our prior written permission. The more details and the authenticity of the report will be confirmed at <http://www.agc-cert.com>.



**Simultaneous Multi-band Transmission Evaluation:**  
**Application Simultaneous Transmission information:**

NO	Simultaneous state	Portable Handset		
		Head	Body-worn	Hotspot
1	GSM(voice)+WLAN 2.4GHz (data)	Yes	Yes	-
2	WCDMA(voice)+WLAN 2.4GHz (data)	Yes	Yes	-
3	GSM(voice)+Bluetooth(data)	-	Yes	-
4	WCDMA(voice)+Bluetooth(data)	-	Yes	-
5	GSM (Data) + Bluetooth(data)	-	Yes	
6	GSM (Data) + WLAN 2.4GHz (data)	Yes	Yes	Yes
7	WCDMA (Data) + Bluetooth(data)	--	Yes	
8	WCDMA (Data) + WLAN 2.4GHz (data)	Yes	Yes	Yes

**NOTE:**

1. WIFI and BT share the same antenna, and cannot transmit simultaneously.
2. Simultaneous with every transmitter must be the same test position.
3. KDB 447498 D01, BT SAR is excluded as below table.
4. KDB 447498 D01, for handsets the test separation distance is determined by the smallest distance between the outer surface of the device and the user; which is 0mm for head SAR and 5mm for body-worn SAR.
5. According to KDB 447498 D01 4.3.1, Standalone SAR test exclusion is as follow:  
 For 100 MHz to 6 GHz and test separation distances  $\leq 50$  mm, the 1-g and 10-g SAR test exclusion thresholds are determined by the following:  

$$[(\text{max. power of channel, including tune-up tolerance, mW}) / (\text{min. test separation distance, mm})] \cdot [\sqrt{f(\text{GHz})}] \leq 3.0$$
 for 1-g SAR, and  $\leq 7.5$  for 10-g extremity SAR<sup>30</sup>, where
  - f(GHz) is the RF channel transmit frequency in GHz
  - Power and distance are rounded to the nearest mW and mm before calculation<sup>31</sup>
  - The result is rounded to one decimal place for comparison
  - The values 3.0 and 7.5 are referred to as numeric thresholds in step b) below
 The test exclusions are applicable only when the minimum test separation distance is  $\leq 50$  mm, and for transmission frequencies between 100 MHz and 6 GHz. When the minimum test separation distance is  $< 5$  mm, a distance of 5 mm according to 4.1 f) is applied to determine SAR test exclusion.
6. If the test separation distance is  $< 5$ mm, 5mm is used for excluded SAR calculation.
7. According to KDB 447498 D01 4.3.2, simultaneous transmission SAR test exclusion is as follow:
  - (1) Simultaneous transmission SAR test exclusion is determined for each operating configuration and exposure condition according to the reported standalone SAR of each applicable simultaneous transmitting antenna.
  - (2) Any transmitters and antennas should be considered when calculating simultaneous mode.
  - (3) For mobile phone and PC, it's the sum of all transmitters and antennas at the same mode with same position in each applicable exposure condition
  - (4) When the standalone SAR test exclusion of section 4.3.2 is applied to an antenna that transmits simultaneously with other antennas, the standalone SAR must be estimated according to the following to det
 
$$[(\text{max. power of channel, including tune-up tolerance, mW}) / (\text{min. test separation distance, mm})] \cdot [\sqrt{f(\text{GHz})} / x] \leq W/\text{kg}$$
 for test separation distances  $\leq 50$  mm;  
 where  $x = 7.5$  for 1-g SAR, and  $x = 18.75$  for 10-g SAR.

The results shown in this test report refer only to the sample(s) tested unless otherwise stated and the sample(s) are retained for 30 days only. The document is issued by AGC, this document cannot be reproduced except in full with our prior written permission. The more details and the authenticity of the report will be confirmed at <http://www.agc-cert.com>.

8. When the sum of SAR is larger than the limit, SAR test exclusion is determined by the SAR to peak location separation ratio. The simultaneous transmitting antennas in each operating mode and exposure condition combination must be considered one pair at a time to determine the SAR to peak location separation ratio to qualify for test exclusion. The ratio is determined by  $(SAR_1 + SAR_2)1.5/R_i$ , rounded to two decimal digits, and must be  $\leq 0.04$  for all antenna pairs in the configuration to qualify for 1-g SAR test exclusion.

Estimated SAR		Max Power including Tune-up Tolerance		Separation Distance (mm)	Estimated SAR (W/kg)
		dBm	mW		
BT	Head	3	1.995	0	0.083
	Body	3	1.995	5	0.083
				10	0.042

The results shown in this test report refer only to the sample(s) tested unless otherwise stated and the sample(s) are retained for 30 days only. The document is issued by AGC, this document cannot be reproduced except in full with our prior written permission. The more details and the authenticity of the report will be confirmed at <http://www.agc-cert.com>.



**Sum of the SAR for GSM 850 & Wi-Fi & BT:**

RF Exposure Conditions	Test Position	Simultaneous Transmission Scenario			Σ1-g SAR (W/Kg)	SPLSR (Yes/No)
		GSM 850	Wi-Fi DTS Band	Bluetooth		
Head (voice)	Left Touch	0.144	0.242		0.386	No
	Left Tilt	0.096	0.269		0.365	No
	Right Touch	0.187	0.274		0.461	No
	Right Tilt	0.093	0.292		0.385	No
Body-worn	Rear	0.417	0.293		0.710	No
		0.250		0.083	0.333	No
	Front	0.417	0.176		0.593	No
		0.250		0.083	0.333	No
Head (VoIP)	Left Touch	0.135	0.242		0.377	No
	Left Tilt	0.088	0.269		0.357	No
	Right Touch	0.168	0.274		0.442	No
	Right Tilt	0.091	0.292		0.383	No
Hotspot	Rear	0.420		0.083	0.503	No
		0.420	0.293		0.713	No
	Front	0.241		0.083	0.324	No
		0.241	0.176		0.417	No
	Edge 1	0.009	0.128		0.137	No
	Edge 2	0.176	0.039		0.215	No
	Edge 3	0.096	0.008		0.104	No
	Edge 4	0.101	0.075		0.176	No
	Edge 1	0.009		0.042	0.051	No
	Edge 2	0.176		0.042	0.218	No
	Edge 3	0.096		0.042	0.138	No
	Edge 4	0.101		0.042	0.143	No

**Note:**

- According to KDB 447498 D01 General RF Exposure Guidance, when the simultaneous transmission SAR is less than 1.6 W/Kg, SPLSR assessment is not required.
- SPLSR mean is "The SAR to Peak Location Separation Ratio"

The results shown in this test report refer only to the sample(s) tested unless otherwise stated and the sample(s) are retained for 30 days only. The document is issued by AGC, this document cannot be reproduced except in full with our prior written permission. The more details and the authenticity of the report will be confirmed at <http://www.agc-cert.com>.

**Sum of the SAR for GSM 1900 & Wi-Fi & BT:**

RF Exposure Conditions	Test Position	Simultaneous Transmission Scenario			Σ1-g SAR (W/Kg)	SPLSR (Yes/No)
		GSM 1900	Wi-Fi DTS Band	Bluetooth		
Head (voice)	Left Touch	0.070	0.242		0.312	No
	Left Tilt	0.033	0.269		0.302	No
	Right Touch	0.071	0.274		0.345	No
	Right Tilt	0.019	0.292		0.311	No
Body-worn	Rear	0.487	0.293		0.780	No
		0.429		0.083	0.512	No
	Front	0.487	0.176		0.663	No
		0.429		0.083	0.512	No
Head (VoIP)	Left Touch	0.088	0.242		0.330	No
	Left Tilt	0.043	0.269		0.312	No
	Right Touch	0.052	0.274		0.326	No
	Right Tilt	0.017	0.292		0.309	No
Hotspot	Rear	0.635		0.083	0.718	No
		0.635	0.293		0.928	No
	Front	0.545		0.083	0.628	No
		0.545	0.176		0.721	No
	Edge 1	0.025	0.128		0.153	No
	Edge 2	0.078	0.039		0.117	No
	Edge 3	0.499	0.008		0.507	No
	Edge 4	0.103	0.075		0.178	No
	Edge 1	0.025		0.042	0.067	No
	Edge 2	0.078		0.042	0.120	No
	Edge 3	0.499		0.042	0.541	No
	Edge 4	0.103		0.042	0.145	No

**Note:**

- According to KDB 447498 D01 General RF Exposure Guidance, when the simultaneous transmission SAR is less than 1.6 W/Kg, SPLSR assessment is not required.
- SPLSR mean is "The SAR to Peak Location Separation Ratio"

The results shown in this test report refer only to the sample(s) tested unless otherwise stated and the sample(s) are retained for 30 days only. The document is issued by AGC, this document cannot be reproduced except in full with our prior written permission. The more details and the authenticity of the report will be confirmed at <http://www.agc-cert.com>.



**Sum of the SAR for WCDMA Band II & Wi-Fi & BT:**

RF Exposure Conditions	Test Position	Simultaneous Transmission Scenario			Σ1-g SAR (W/Kg)	SPLSR (Yes/No)
		WCDMA Band II	Wi-Fi DTS Band	Bluetooth		
Head	Left Touch	0.203	0.242		0.445	No
	Left Tilt	0.068	0.269		0.337	No
	Right Touch	0.094	0.274		0.368	No
	Right Tilt	0.051	0.292		0.343	No
Hotspot	Rear	1.173	0.293		<b>1.466</b>	No
	Front	1.126	0.176		1.302	No
	Edge 1	0.042	0.128		0.170	No
	Edge 2	0.121	0.039		0.160	No
	Edge 3	0.962	0.008		0.970	No
	Edge 4	0.200	0.075		0.275	No
	Rear	1.173		0.083	1.256	No
	Front	1.126		0.083	1.209	No
	Edge 1	0.042		0.042	0.084	No
	Edge 2	0.121		0.042	0.163	No
	Edge 3	0.962		0.042	1.004	No
	Edge 4	0.200		0.042	0.242	No

**Note:**

- According to KDB 447498 D01 General RF Exposure Guidance, when the simultaneous transmission SAR is less than 1.6 W/Kg, SPLSR assessment is not required.
- SPLSR mean is "The SAR to Peak Location Separation Ratio"

The results shown in this test report refer only to the sample(s) tested unless otherwise stated and the sample(s) are retained for 30 days only. The document is issued by AGC, this document cannot be reproduced except in full with our prior written permission. The more details and the authenticity of the report will be confirmed at <http://www.agc-cert.com>.

**Sum of the SAR for WCDMA Band V & Wi-Fi & BT:**

RF Exposure Conditions	Test Position	Simultaneous Transmission Scenario			Σ1-g SAR (W/Kg)	SPLSR (Yes/No)
		WCDMA Band V	Wi-Fi DTS Band	Bluetooth		
Head	Left Touch	0.151	0.242		0.393	No
	Left Tilt	0.144	0.269		0.413	No
	Right Touch	0.186	0.274		0.460	No
	Right Tilt	0.121	0.292		0.413	No
Hotspot	Rear	0.530	0.293		0.823	No
	Front	0.284	0.176		0.460	No
	Edge 1	0.009	0.128		0.137	No
	Edge 2	0.208	0.039		0.247	No
	Edge 3	0.116	0.008		0.124	No
	Edge 4	0.117	0.075		0.192	No
	Rear	0.530		0.083	0.613	No
	Front	0.284		0.083	0.367	No
	Edge 1	0.009		0.042	0.051	No
	Edge 2	0.208		0.042	0.250	No
	Edge 3	0.116		0.042	0.158	No
	Edge 4	0.117		0.042	0.159	No

**Note:**

- According to KDB 447498 D01 General RF Exposure Guidance, when the simultaneous transmission SAR is less than 1.6 W/Kg, SPLSR assessment is not required.
- SPLSR mean is "The SAR to Peak Location Separation Ratio"

The results shown in this test report refer only to the sample(s) tested unless otherwise stated and the sample(s) are retained for 30 days only. The document is issued by AGC, this document cannot be reproduced except in full with our prior written permission. The more details and the authenticity of the report will be confirmed at <http://www.agc-cert.com>.



**Sum of the SAR for WCDMA Band IV & Wi-Fi & BT:**

RF Exposure Conditions	Test Position	Simultaneous Transmission Scenario			Σ1-g SAR (W/Kg)	SPLSR (Yes/No)
		WCDMA Band V	Wi-Fi DTS Band	Bluetooth		
Head	Left Touch	0.174	0.242		0.416	No
	Left Tilt	0.072	0.269		0.341	No
	Right Touch	0.136	0.274		0.410	No
	Right Tilt	0.039	0.292		0.331	No
Hotspot	Rear	0.731	0.293		1.024	No
	Front	0.872	0.176		1.048	No
	Edge 1	0.026	0.128		0.154	No
	Edge 2	0.077	0.039		0.116	No
	Edge 3	0.463	0.008		0.471	No
	Edge 4	0.095	0.075		0.170	No
	Rear	0.731		0.083	0.814	No
	Front	0.872		0.083	0.955	No
	Edge 1	0.026		0.042	0.068	No
	Edge 2	0.077		0.042	0.119	No
	Edge 3	0.463		0.042	0.505	No
	Edge 4	0.095		0.042	0.137	No

**Note:**

- According to KDB 447498 D01 General RF Exposure Guidance, when the simultaneous transmission SAR is less than 1.6 W/Kg, SPLSR assessment is not required.
- SPLSR mean is "The SAR to Peak Location Separation Ratio"

The results shown in this test report refer only to the sample(s) tested unless otherwise stated and the sample(s) are retained for 30 days only. The document is issued by AGC, this document cannot be reproduced except in full with our prior written permission. The more details and the authenticity of the report will be confirmed at <http://www.agc-cert.com>.

**APPENDIX A. SAR SYSTEM CHECK DATA**

Test Laboratory: AGC Lab

Date: Apr. 28,2018

System Check Head 835 MHz

DUT: Dipole 835 MHz Type: SID 835

Communication System CW; Communication System Band: D835 (835.0 MHz); Duty Cycle: 1:1; Conv.F=1.74  
Frequency: 835 MHz; Medium parameters used:  $f = 835$  MHz;  $\sigma=0.90$  mho/m;  $\epsilon_r = 41.63$ ;  $\rho= 1000$  kg/m<sup>3</sup> ;  
Phantom section: Flat Section; Input Power=18dBm  
Ambient temperature (°C):21.7, Liquid temperature (°C): 21.3

SATIMO Configuration

- Probe: SSE2; Calibrated: Aug. 08,2017; Serial No.: SN 08/16 EPGO282
- Sensor-Surface: 4mm (Mechanical Surface Detection)
- Phantom: SAM twin phantom
- Measurement SW: OpenSAR V4\_02\_35

Configuration/System Check 835MHz Head/Area Scan: Measurement grid: dx=8mm, dy=8mm

Configuration/System Check 835MHz Head/Zoom Scan: Measurement grid: dx=8mm,dy=8mm, dz=5mm

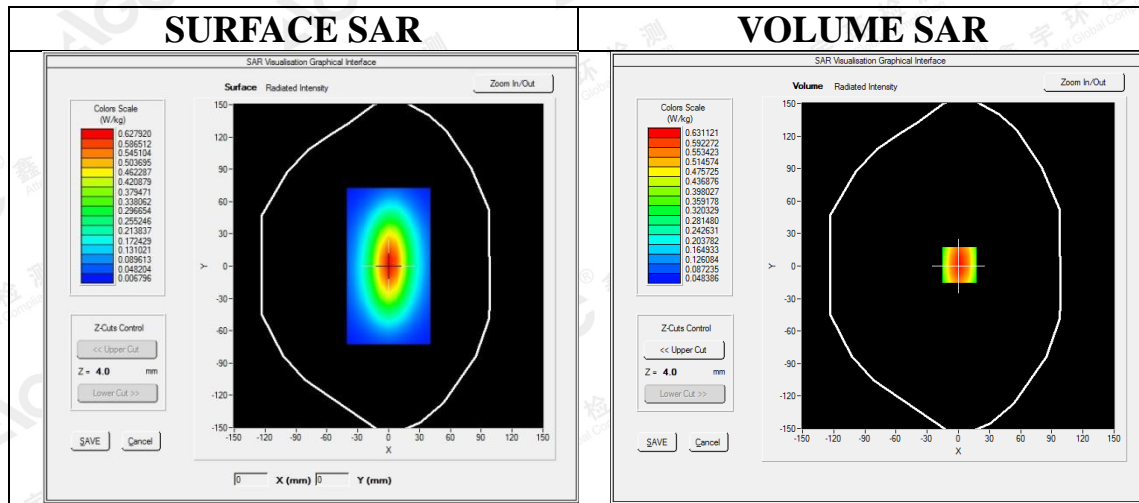

Maximum location: X=1.00, Y=1.00

SAR Peak: 0.90 W/kg

SAR 10g (W/Kg)	0.387415
SAR 1g (W/Kg)	0.610847

The results shown in this test report refer only to the sample(s) tested unless otherwise stated and the sample(s) are retained for 30 days only. The document is issued by AGC, this document cannot be reproduced except in full with our prior written permission. The more details and the authenticity of the report will be confirmed at <http://www.agc-cert.com>.



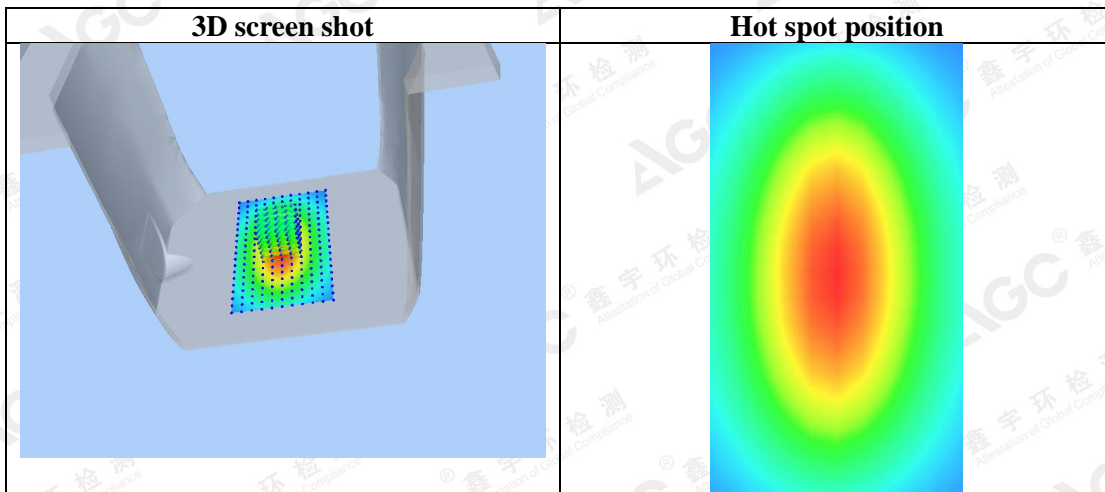
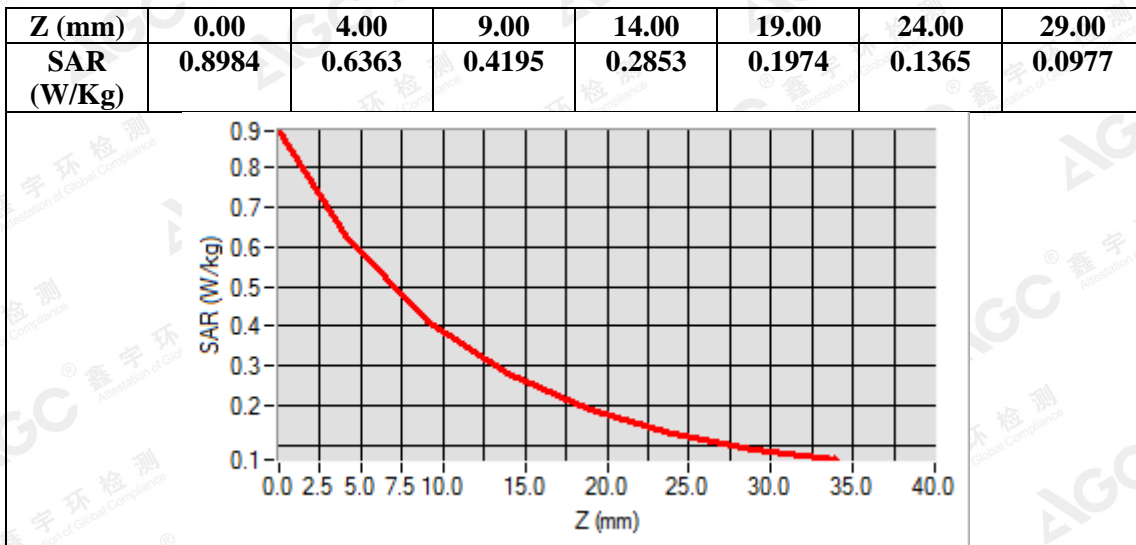

The results shown in this test report refer only to the sample(s) tested unless otherwise stated and the sample(s) are retained for 30 days only. The document is issued by AGC, this document cannot be reproduced except in full with our prior written permission. The more details and the authenticity of the report will be confirmed at <http://www.agc-cert.com>.

**Test Laboratory: AGC Lab**

**Date: Apr. 28,2018**

**System Check Body 835 MHz**

**DUT: Dipole 835 MHz Type: SID 835**

Communication System CW; Communication System Band: D835 (835.0 MHz); Duty Cycle: 1:1; Conv.F=1.81

Frequency: 835 MHz; Medium parameters used:  $f = 835$  MHz;  $\sigma=0.96$  mho/m;  $\epsilon_r = 55.37$ ;  $\rho = 1000$  kg/m<sup>3</sup> ;

Phantom section: Flat Section; Input Power=18dBm

Ambient temperature (°C):21.7, Liquid temperature (°C): 21.4

**SATIMO Configuration**

- Probe: SSE2; Calibrated: Aug. 08,2017; Serial No.: SN 08/16 EPGO282
- Sensor-Surface: 4mm (Mechanical Surface Detection)
- Phantom: SAM twin phantom
- Measurement SW: OpenSAR V4\_02\_35

**Configuration/System Check 835MHz Body/Area Scan: Measurement grid: dx=8mm, dy=8mm**

**Configuration/System Check 835MHz Body/Zoom Scan: Measurement grid: dx=8mm,dy=8mm, dz=5mm**

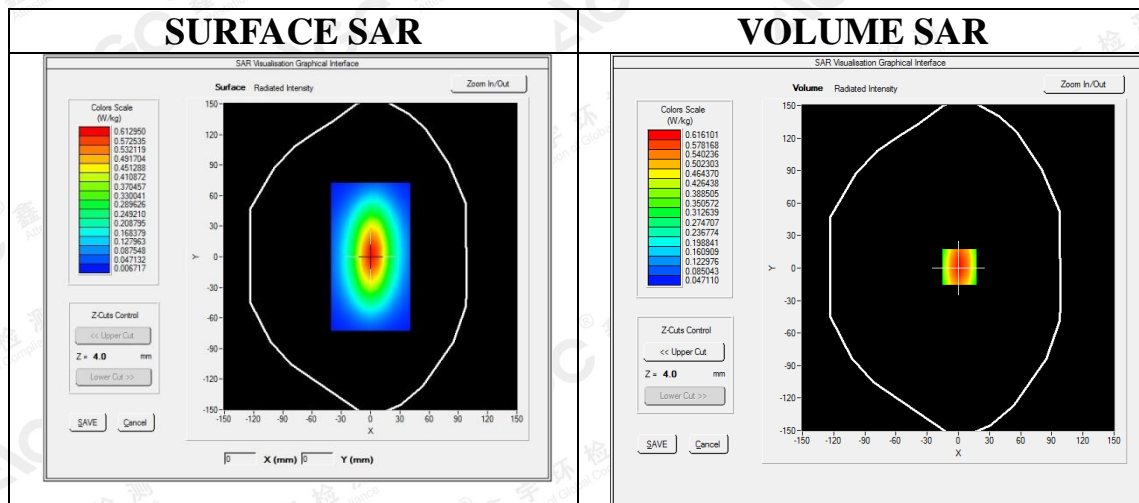

**Maximum location: X=1.00, Y=1.00**  
**SAR Peak: 0.87 W/kg**

<b>SAR 10g (W/Kg)</b>	0.376184
<b>SAR 1g (W/Kg)</b>	0.595543

The results shown in this test report refer only to the sample(s) tested unless otherwise stated and the sample(s) are retained for 30 days only. The document is issued by AGC, this document cannot be reproduced except in full with our prior written permission. The more details and the authenticity of the report will be confirmed at <http://www.agc-cert.com>.



Z (mm)	0.00	4.00	9.00	14.00	19.00	24.00	29.00
SAR (W/Kg)	0.8748	0.6233	0.4102	0.2785	0.1913	0.1367	0.0956

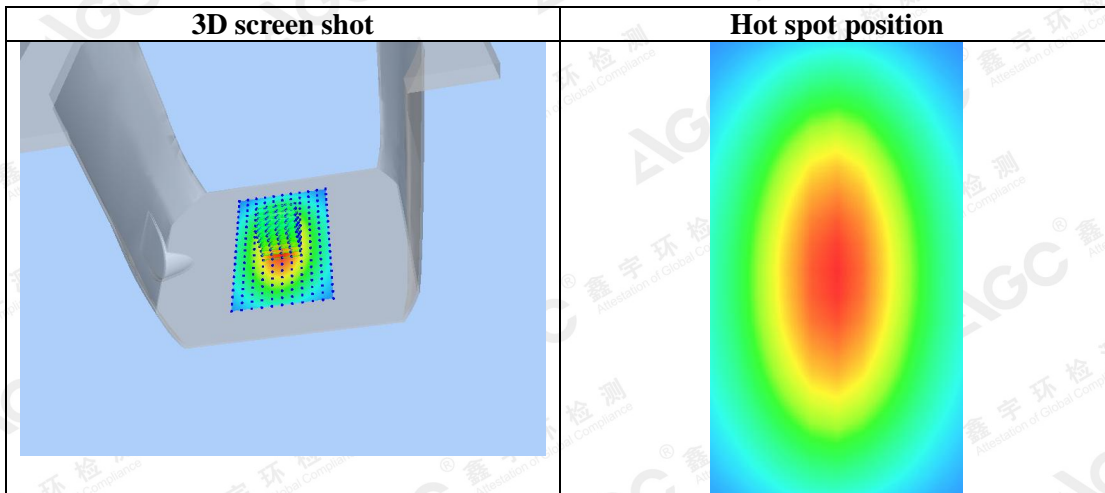
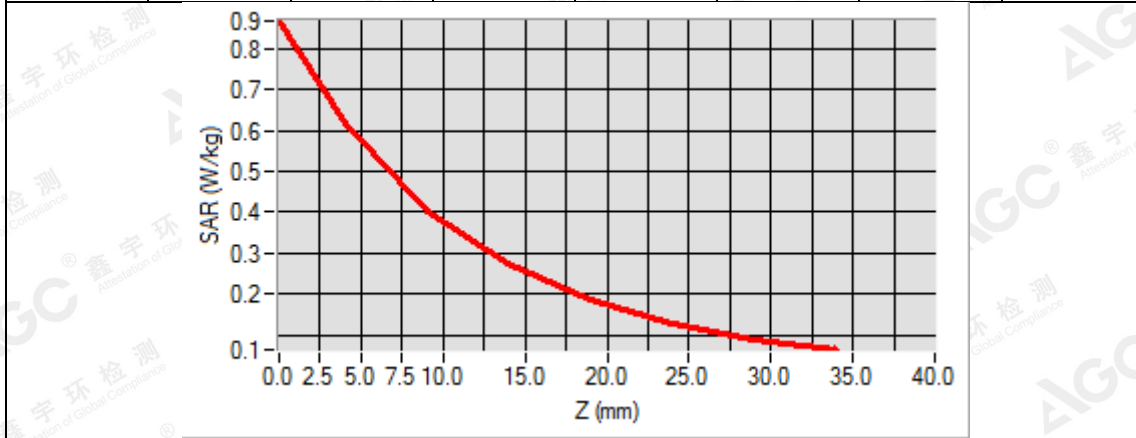

The results shown in this test report refer only to the sample(s) tested unless otherwise stated and the sample(s) are retained for 30 days only. The document is issued by AGC, this document cannot be reproduced except in full with our prior written permission. The more details and the authenticity of the report will be confirmed at <http://www.agc-cert.com>.

**Test Laboratory: AGC Lab**

**Date: May. 08,2018**

**System Check Head 1750MHz**

**DUT: Dipole 1800 MHz; Type: SID 1800**

Communication System: CW; Communication System Band: D1700 (1750.0 MHz); Duty Cycle: 1:1; Conv.F=2.03

Frequency: 1750MHz; Medium parameters used:  $f = 1800$  MHz;  $\sigma = 1.37$  mho/m;  $\epsilon_r = 40.83$ ;  $\rho = 1000$  kg/m<sup>3</sup> ;

Phantom section: Flat Section; Input Power=18dBm

Ambient temperature (°C): 22.0, Liquid temperature (°C): 21.5

**SATIMO Configuration:**

Probe: SSE2; Calibrated: Aug. 08,2017; Serial No.: SN 08/16 EPGO282

- Sensor-Surface: 4mm (Mechanical Surface Detection)
- Phantom: SAM twin phantom
- Measurement SW: OpenSAR V4\_02\_35

**Configuration/System Check 1750 Head/Area Scan:** Measurement grid: dx=8mm, dy=8mm

**Configuration/System Check 1750 Head/Zoom Scan:** Measurement grid: dx=8mm,dy=8mm, dz=5mm

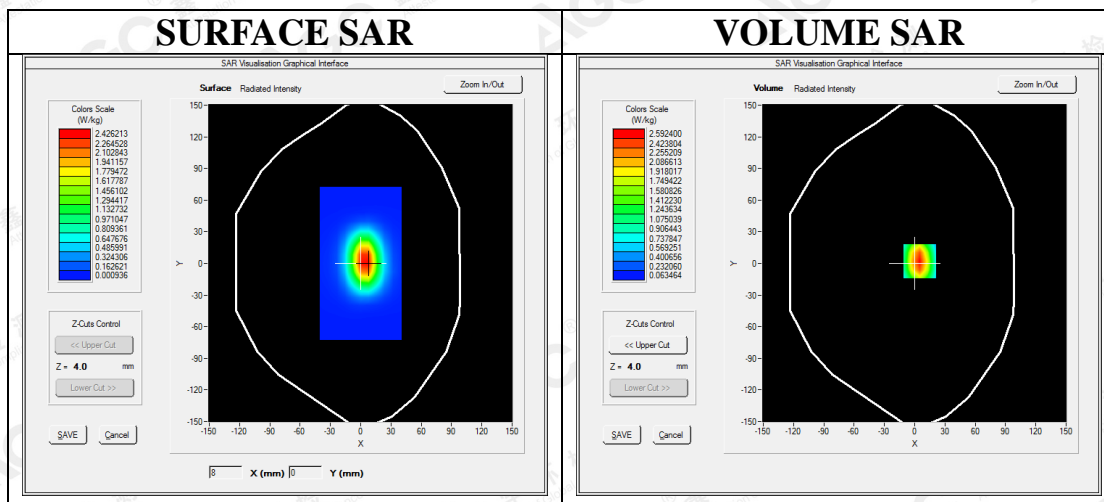

**Maximum location: X=5.00, Y=3.00**

**SAR Peak: 3.92 W/kg**

<b>SAR 10g (W/Kg)</b>	1.328152
<b>SAR 1g (W/Kg)</b>	2.443059

The results shown in this test report refer only to the sample(s) tested unless otherwise stated and the sample(s) are retained for 30 days only. The document is issued by AGC, this document cannot be reproduced except in full with our prior written permission. The more details and the authenticity of the report will be confirmed at <http://www.agc-cert.com>.



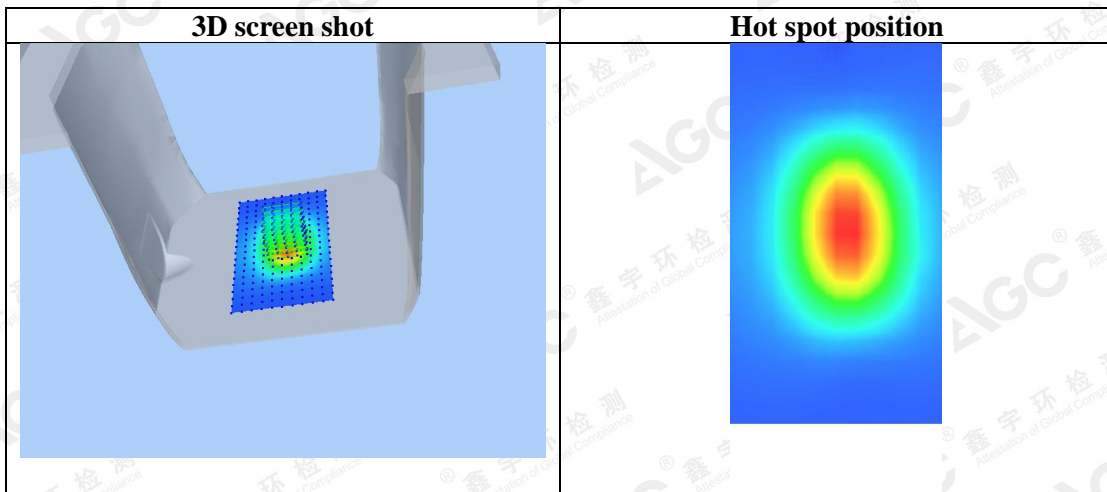
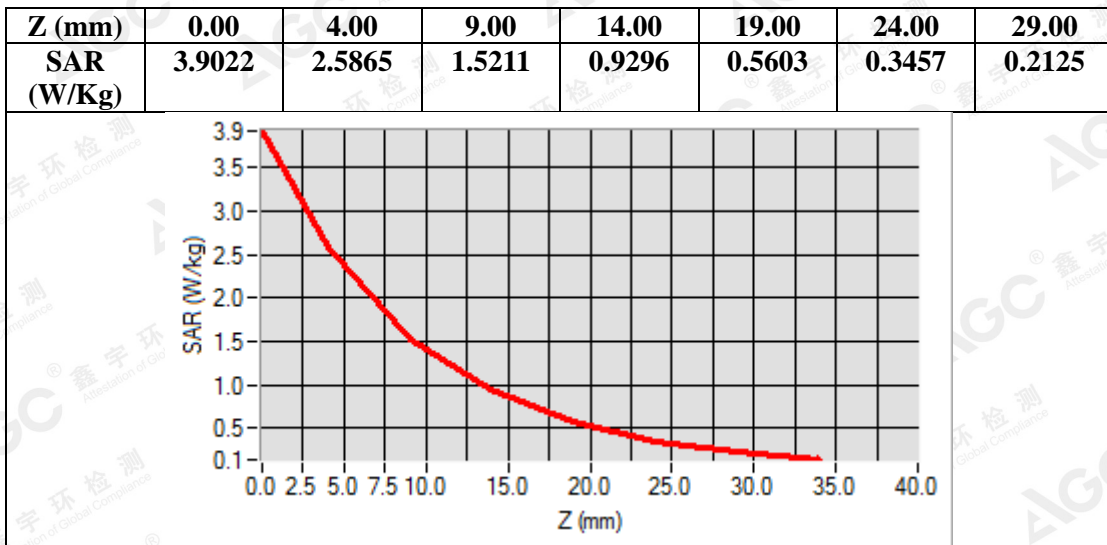

The results shown in this test report refer only to the sample(s) tested unless otherwise stated and the sample(s) are retained for 30 days only. The document is issued by AGC, this document cannot be reproduced except in full with our prior written permission. The more details and the authenticity of the report will be confirmed at <http://www.agc-cert.com>.

**Test Laboratory: AGC Lab**

**Date: May. 08,2018**

**System Check Body 1750MHz**

**DUT: Dipole 1800 MHz; Type: SID 1800**

Communication System: CW; Communication System Band: D1700 (1750.0 MHz); Duty Cycle:1:1; Conv.F=2.07

Frequency: 1750 MHz; Medium parameters used:  $f = 1800\text{MHz}$ ;  $\sigma = 1.50 \text{ mho/m}$ ;  $\epsilon_r = 54.07$ ;  $\rho = 1000 \text{ kg/m}^3$  ;

Phantom section: Flat Section; Input Power=18dBm

Ambient temperature ( $^{\circ}\text{C}$ ): 22.0, Liquid temperature ( $^{\circ}\text{C}$ ): 21.7

SATIMO Configuration:

Probe: SSE2; Calibrated: Aug. 08,2017; Serial No.: SN 08/16 EPGO282

- Sensor-Surface: 4mm (Mechanical Surface Detection)

- Phantom: SAM twin phantom

- Measurement SW: OpenSAR V4\_02\_35

**Configuration/System Check 1750MHz Body/Area Scan:** Measurement grid: dx=8mm,dy=8mm

**Configuration/System Check 1750MHz Body/Zoom Scan:** Measurement grid: dx=8mm,dy=8mm, dz=5mm

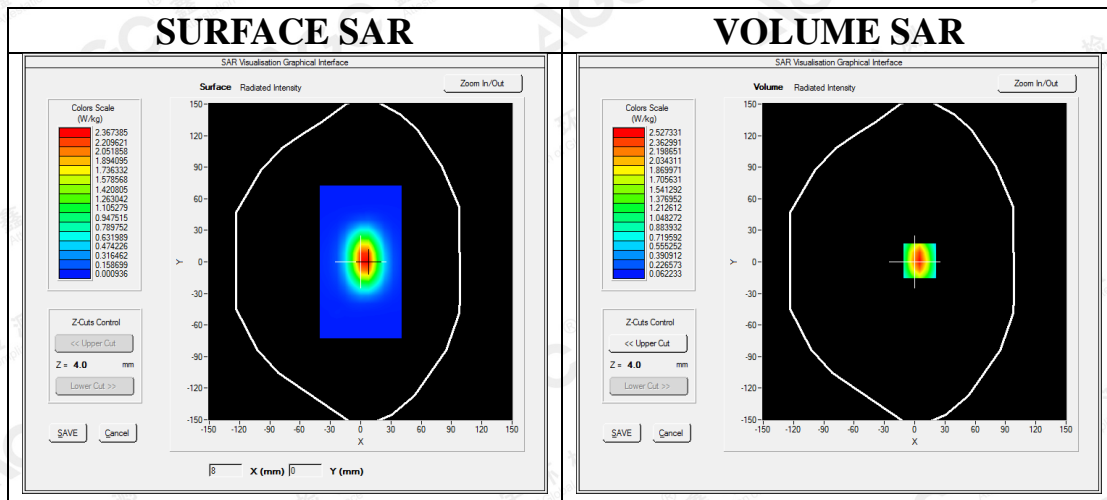

**Maximum location: X=5.00, Y=0.00**

**SAR Peak: 3.81 W/kg**

<b>SAR 10g (W/Kg)</b>	1.285184
<b>SAR 1g (W/Kg)</b>	2.372967

The results shown in this test report refer only to the sample(s) tested otherwise stated and the sample(s) are retained for 30 days only. The document is issued by AGC, this document cannot be reproduced except in full with our prior written permission. The more details and the authenticity of the report will be confirmed at <http://www.agc-cert.com>.



Z (mm)	0.00	4.00	9.00	14.00	19.00	24.00	29.00
SAR (W/Kg)	3.8053	2.5205	1.4871	0.9026	0.5439	0.3365	0.2028

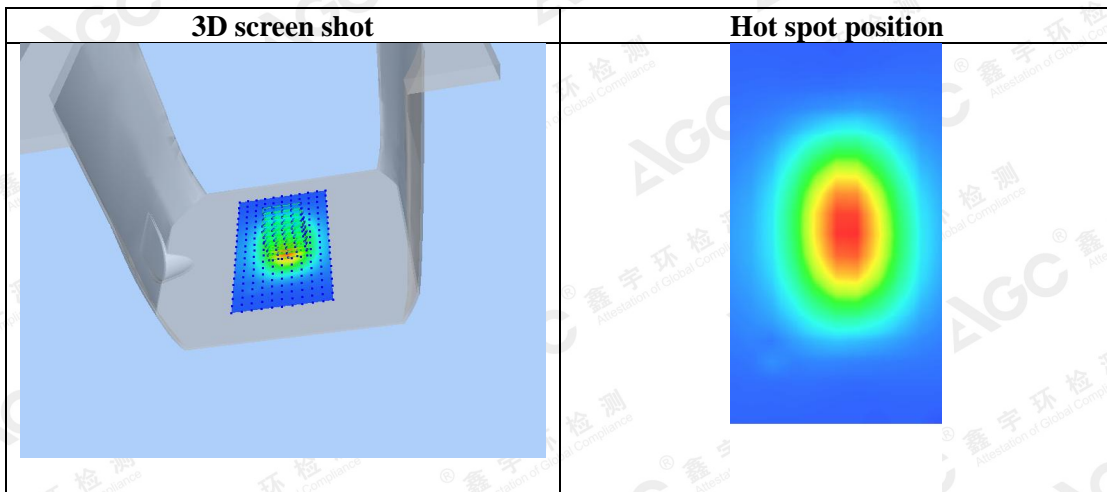
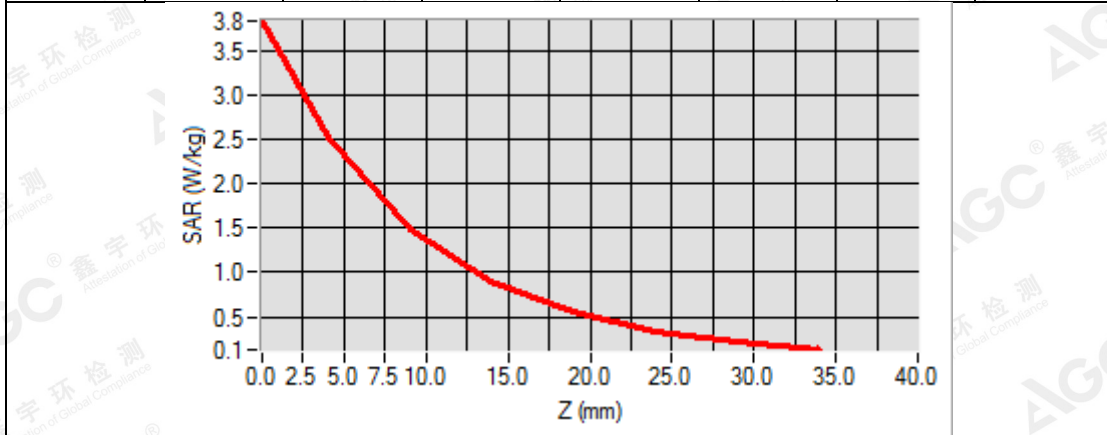

The results shown in this test report refer only to the sample(s) tested unless otherwise stated and the sample(s) are retained for 30 days only. The document is issued by AGC, this document cannot be reproduced except in full with our prior written permission. The more details and the authenticity of the report will be confirmed at <http://www.agc-cert.com>.

**Test Laboratory: AGC Lab**  
**System Check Head 1900MHz**  
**DUT: Dipole 1900 MHz; Type: SID 1900**

**Date: May. 02,2018**

Communication System: CW; Communication System Band: D1900 (1900.0 MHz); Duty Cycle:1:1; Conv.F=2.32  
Frequency: 1900 MHz; Medium parameters used:  $f = 1900$  MHz;  $\sigma = 1.41$  mho/m;  $\epsilon_r = 40.11$ ;  $\rho = 1000$  kg/m<sup>3</sup> ;  
Phantom section: Flat Section; Input Power=18dBm  
Ambient temperature (°C):21.7, Liquid temperature (°C): 21.2

SATIMO Configuration:

- Probe: SSE2; Calibrated: Aug. 08,2017; Serial No.: SN 08/16 EPGO282
- Sensor-Surface: 4mm (Mechanical Surface Detection)
- Phantom: SAM twin phantom
- Measurement SW: OpenSAR V4\_02\_35

**Configuration/System Check 1900MHz Head/Area Scan:** Measurement grid: dx=8mm, dy=8mm  
**Configuration/System Check 1900MHz Head/Zoom Scan:** Measurement grid: dx=8mm,dy=8mm, dz=5mm

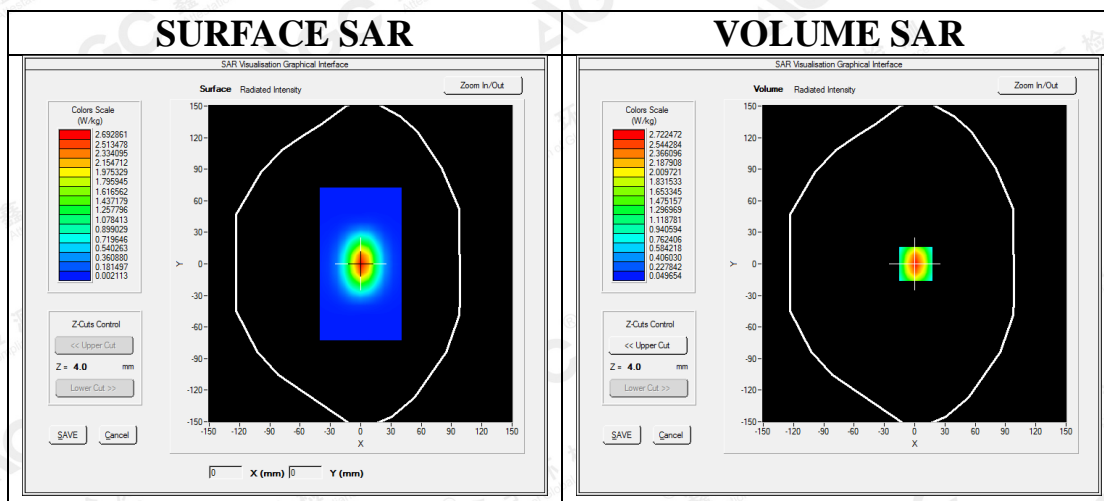

**Maximum location: X=1.00, Y=1.00**  
**SAR Peak: 4.19 W/kg**

<b>SAR 10g (W/Kg)</b>	1.340051
<b>SAR 1g (W/Kg)</b>	2.548710

The results shown in this test report refer only to the sample(s) tested unless otherwise stated and the sample(s) are retained for 30 days only. The document is issued by AGC, this document cannot be reproduced except in full with our prior written permission. The more details and the authenticity of the report will be confirmed at <http://www.agc-cert.com>.



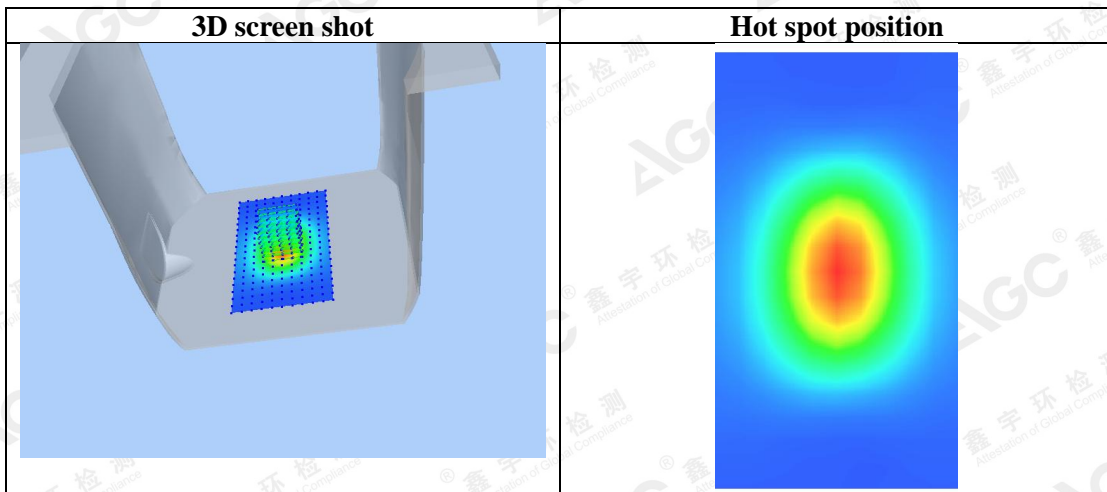
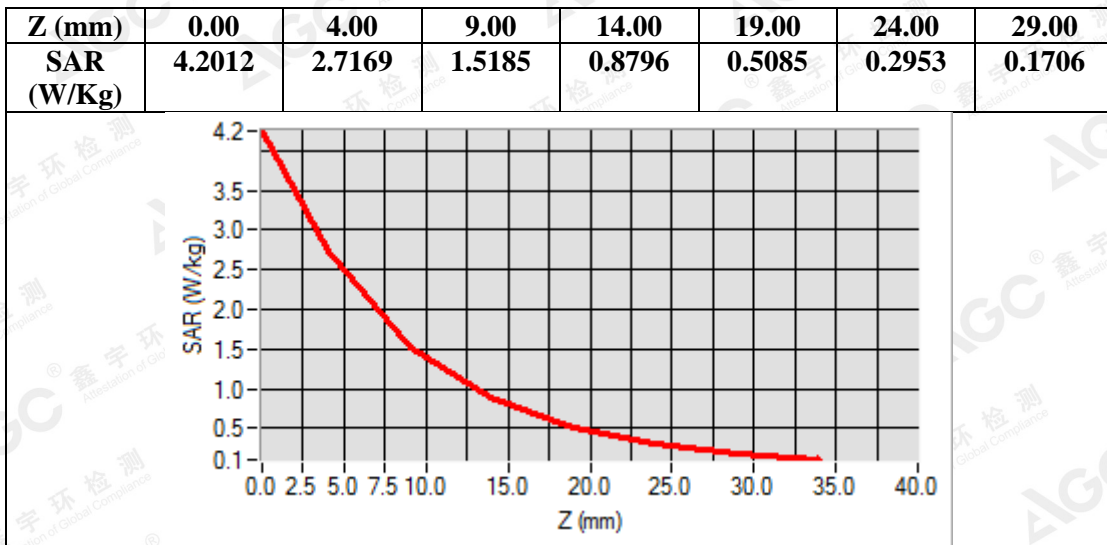

The results shown in this test report refer only to the sample(s) tested unless otherwise stated and the sample(s) are retained for 30 days only. The document is issued by AGC, this document cannot be reproduced except in full with our prior written permission. The more details and the authenticity of the report will be confirmed at <http://www.agc-cert.com>.

**Test Laboratory: AGC Lab**  
**System Check Body 1900MHz**  
**DUT: Dipole 1900 MHz; Type: SID 1900**

**Date: May. 02,2018**

Communication System: CW; Communication System Band: D1900 (1900.0 MHz); Duty Cycle:1:1; Conv.F=2.39  
Frequency: 1900 MHz; Medium parameters used:  $f = 1900$  MHz;  $\sigma=1.53$  mho/m;  $\epsilon_r=53.59$ ;  $\rho= 1000$  kg/m<sup>3</sup> ;  
Phantom section: Flat Section; Input Power=18dBm  
Ambient temperature (°C):21.7, Liquid temperature (°C): 21.4

SATIMO Configuration:

- Probe: SSE2; Calibrated: Aug. 08,2017; Serial No.: SN 08/16 EPGO282
- Sensor-Surface: 4mm (Mechanical Surface Detection)
- Phantom: SAM twin phantom
- Measurement SW: OpenSAR V4\_02\_35

**Configuration/System Check 1900MHz Body/Area Scan: Measurement grid: dx=8mm, dy=8mm**

**Configuration/System Check 1900MHz Body/Zoom Scan: Measurement grid: dx=8mm,dy=8mm, dz=5mm**

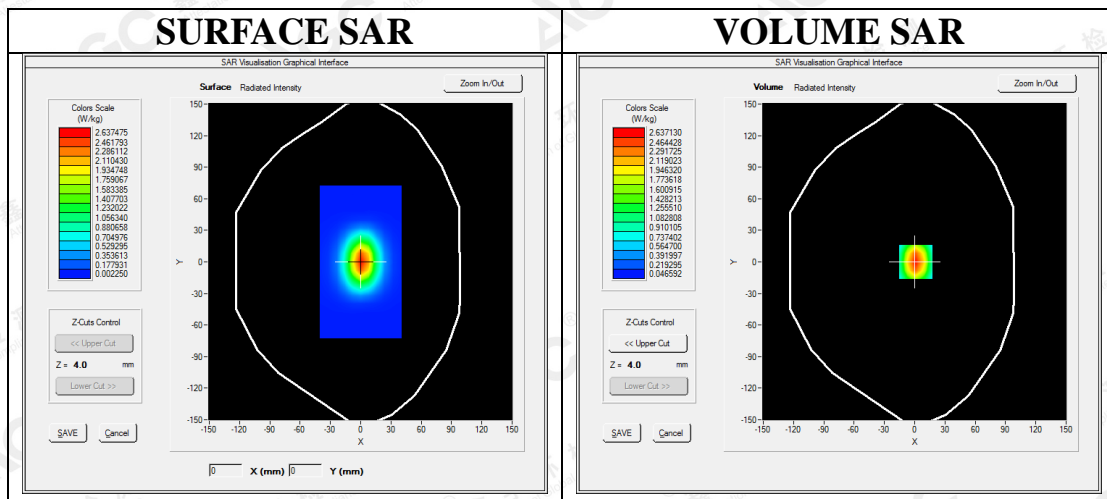

**Maximum location: X=1.00, Y=1.00**  
**SAR Peak: 4.07 W/kg**

<b>SAR 10g (W/Kg)</b>	1.295381
<b>SAR 1g (W/Kg)</b>	2.460173

The results shown in this test report refer only to the sample(s) tested unless otherwise stated and the sample(s) are retained for 30 days only. The document is issued by AGC, this document cannot be reproduced except in full with our prior written permission. The more details and the authenticity of the report will be confirmed at <http://www.agc-cert.com>.



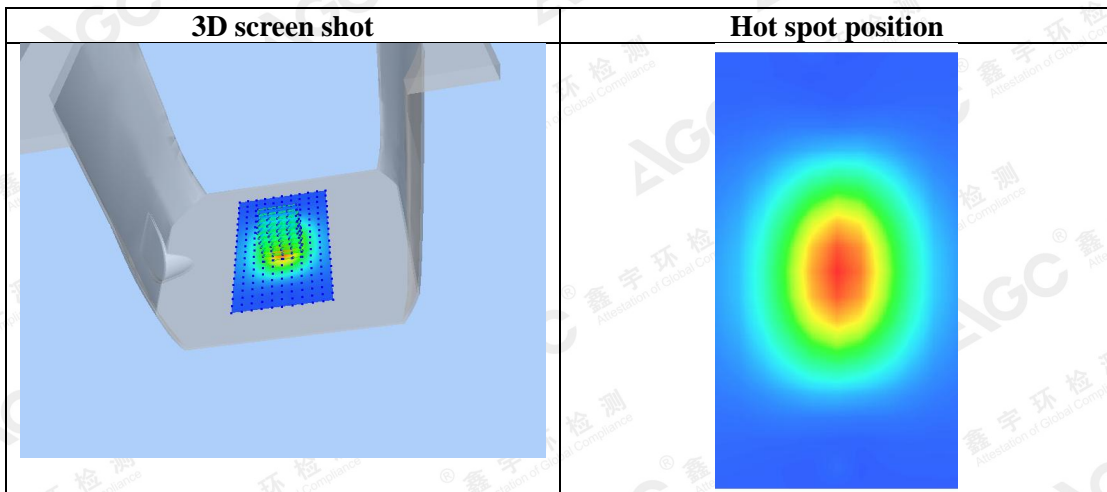
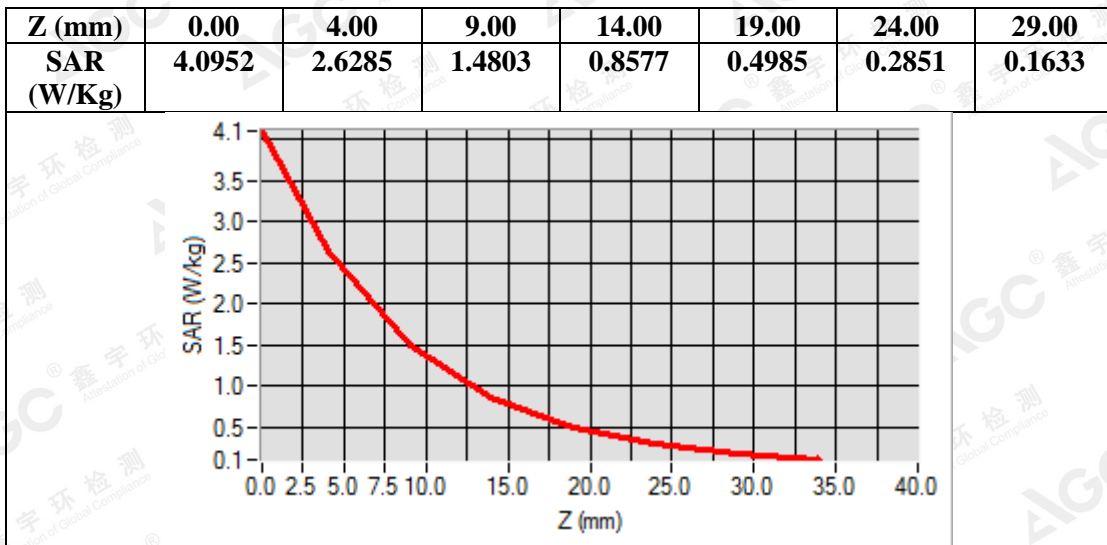

The results shown in this test report refer only to the sample(s) tested unless otherwise stated and the sample(s) are retained for 30 days only. The document is issued by AGC, this document cannot be reproduced except in full with our prior written permission. The more details and the authenticity of the report will be confirmed at <http://www.agc-cert.com>.

**Test Laboratory: AGC Lab**  
**System Check Head 1900MHz**  
**DUT: Dipole 1900 MHz; Type: SID 1900**

**Date: May. 07,2018**

Communication System: CW; Communication System Band: D1900 (1900.0 MHz); Duty Cycle:1:1; Conv.F=2.32  
Frequency: 1900 MHz; Medium parameters used:  $f = 1900$  MHz;  $\sigma=1.41$  mho/m;  $\epsilon_r=40.11$ ;  $\rho= 1000$  kg/m<sup>3</sup> ;  
Phantom section: Flat Section; Input Power=18dBm  
Ambient temperature (°C):21.7, Liquid temperature (°C): 21.1

SATIMO Configuration:

- Probe: SSE2; Calibrated: Aug. 08,2017; Serial No.: SN 08/16 EPGO282
- Sensor-Surface: 4mm (Mechanical Surface Detection)
- Phantom: SAM twin phantom
- Measurement SW: OpenSAR V4\_02\_35

**Configuration/System Check 1900MHz Head/Area Scan: Measurement grid: dx=8mm, dy=8mm**

**Configuration/System Check 1900MHz Head/Zoom Scan: Measurement grid: dx=8mm,dy=8mm, dz=5mm**

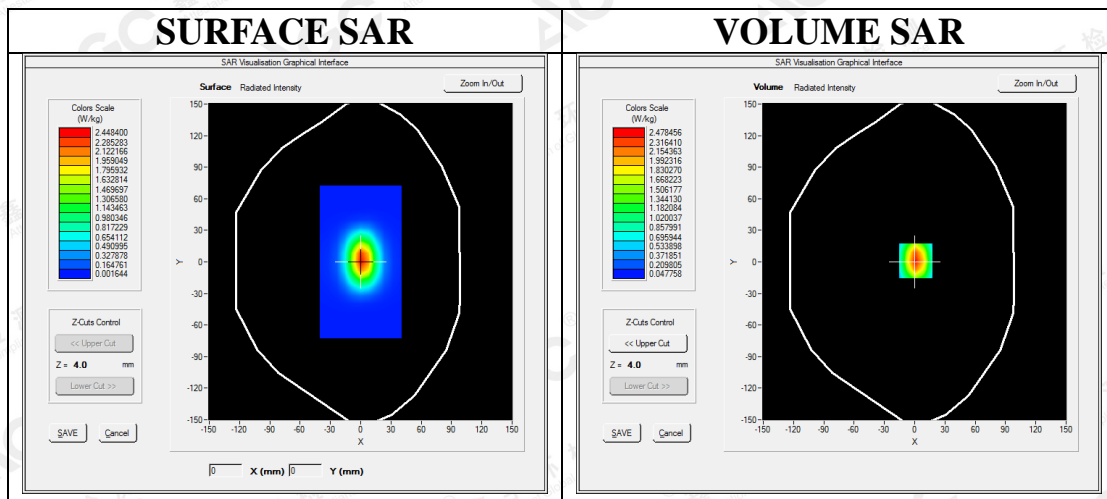

**Maximum location: X=1.00, Y=0.00**

**SAR Peak: 3.80 W/kg**

<b>SAR 10g (W/Kg)</b>	1.281443
<b>SAR 1g (W/Kg)</b>	2.418520

The results shown in this test report refer only to the sample(s) tested unless otherwise stated and the sample(s) are retained for 30 days only. The document is issued by AGC, this document cannot be reproduced except in full with our prior written permission. The more details and the authenticity of the report will be confirmed at <http://www.agc-cert.com>.



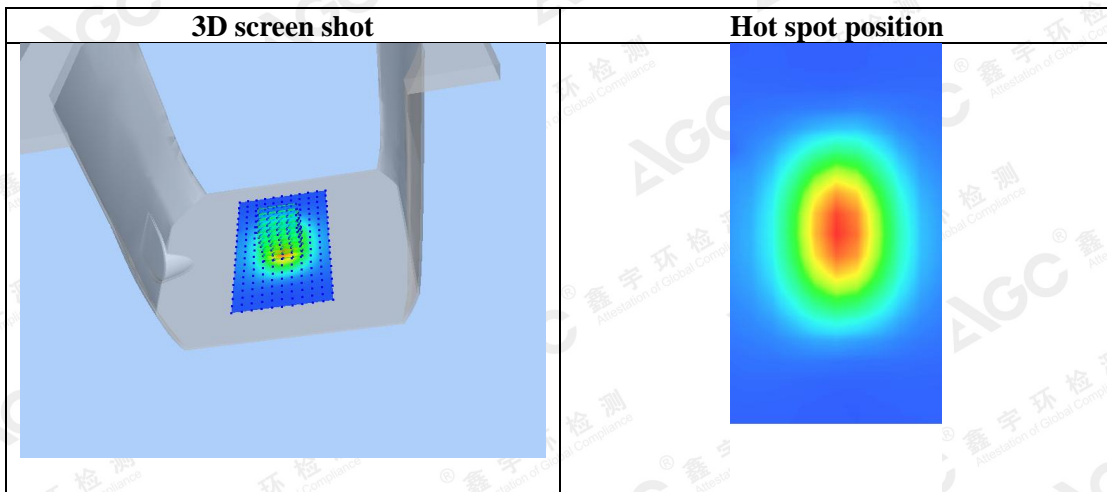
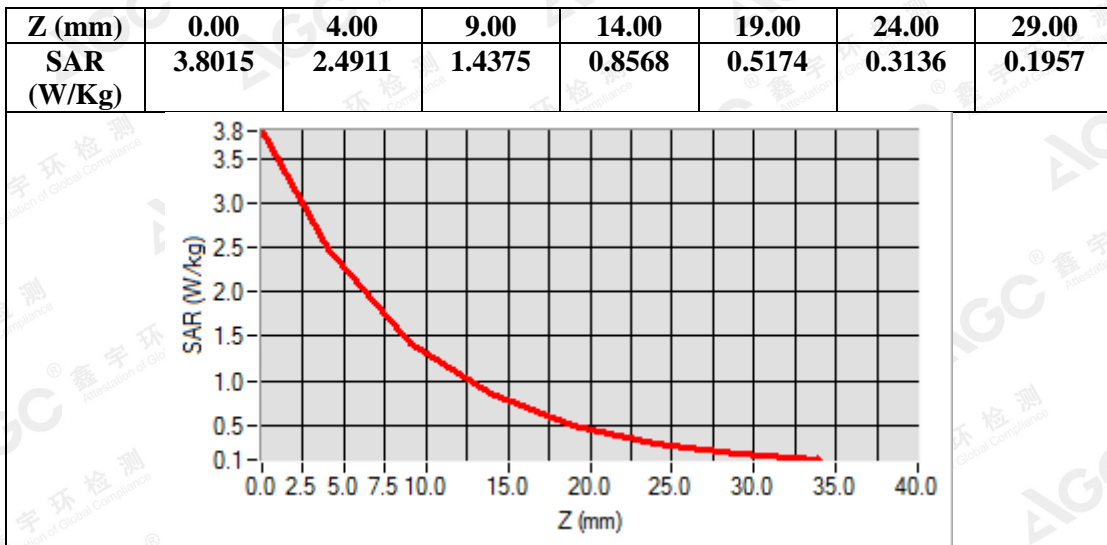

The results shown in this test report refer only to the sample(s) tested unless otherwise stated and the sample(s) are retained for 30 days only. The document is issued by AGC, this document cannot be reproduced except in full with our prior written permission. The more details and the authenticity of the report will be confirmed at <http://www.agc-cert.com>.

**Test Laboratory: AGC Lab**  
**System Check Body 1900MHz**  
**DUT: Dipole 1900 MHz; Type: SID 1900**

**Date: May. 07,2018**

Communication System: CW; Communication System Band: D1900 (1900.0 MHz); Duty Cycle:1:1; Conv.F=2.39  
Frequency: 1900 MHz; Medium parameters used:  $f = 1900$  MHz;  $\sigma = 1.51$  mho/m;  $\epsilon_r = 53.26$ ;  $\rho = 1000$  kg/m<sup>3</sup> ;  
Phantom section: Flat Section; Input Power=18dBm  
Ambient temperature (°C):21.7, Liquid temperature (°C): 21.3

**SATIMO Configuration:**

- Probe: SSE2; Calibrated: Aug. 08,2017; Serial No.: SN 08/16 EPGO282
- Sensor-Surface: 4mm (Mechanical Surface Detection)
- Phantom: SAM twin phantom
- Measurement SW: OpenSAR V4\_02\_35

**Configuration/System Check 1900MHz Body/Area Scan:** Measurement grid: dx=8mm, dy=8mm

**Configuration/System Check 1900MHz Body/Zoom Scan:** Measurement grid: dx=8mm,dy=8mm, dz=5mm

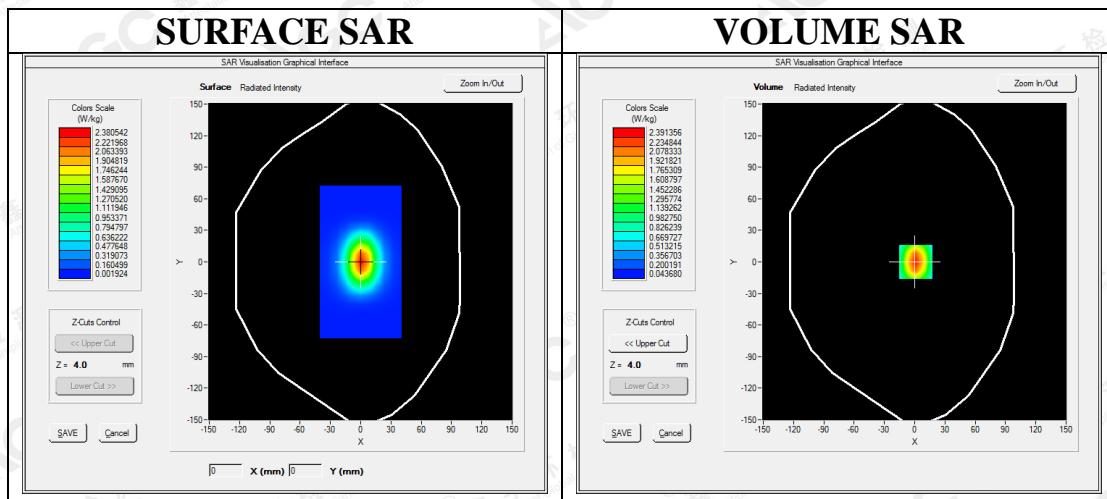

**Maximum location: X=0.00, Y=0.00**  
**SAR Peak: 3.70 W/kg**

<b>SAR 10g (W/Kg)</b>	1.214479
<b>SAR 1g (W/Kg)</b>	2.271542

The results shown in this test report refer only to the sample(s) tested unless otherwise stated and the sample(s) are retained for 30 days only. The document is issued by AGC, this document cannot be reproduced except in full with our prior written permission. The more details and the authenticity of the report will be confirmed at <http://www.agc-cert.com>.



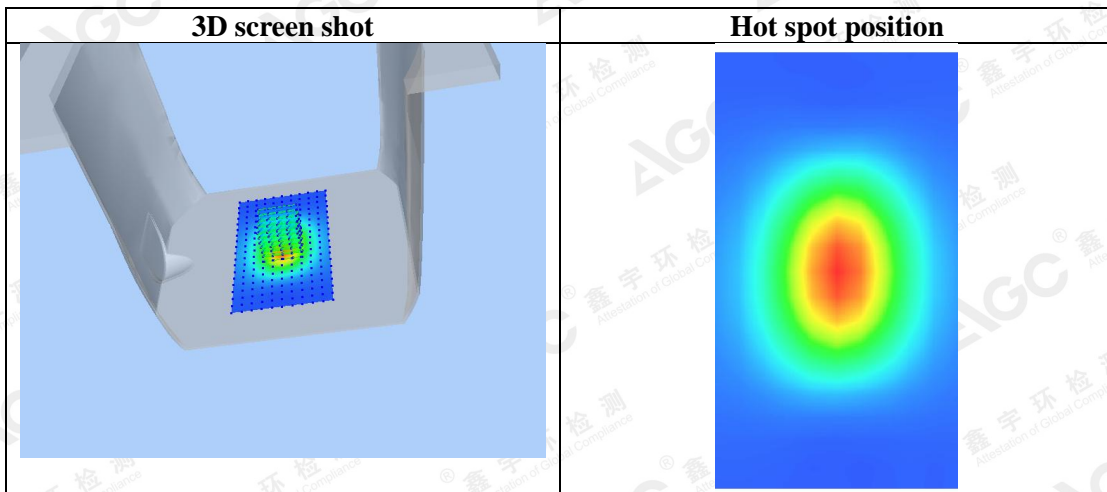
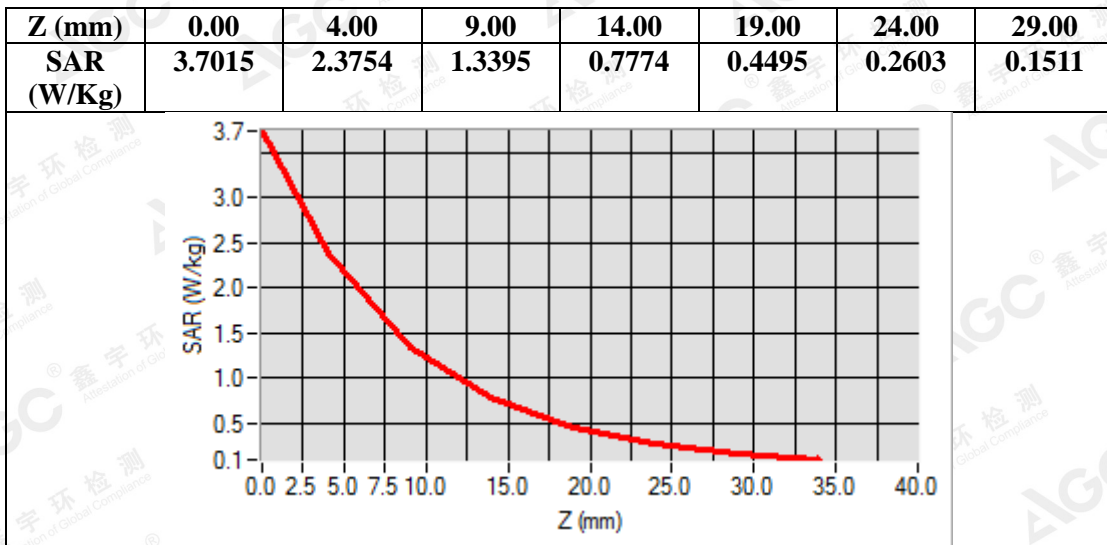

The results shown in this test report refer only to the sample(s) tested unless otherwise stated and the sample(s) are retained for 30 days only. The document is issued by AGC, this document cannot be reproduced except in full with our prior written permission. The more details and the authenticity of the report will be confirmed at <http://www.agc-cert.com>.

**Test Laboratory: AGC Lab**

**Date: May. 04,2018**

**System Check Head 2450 MHz**

**DUT: Dipole 2450 MHz Type: SID 2450**

Communication System CW; Communication System Band: D2450 (2450.0 MHz); Duty Cycle: 1:1; Conv.F=2.52

Frequency: 2450 MHz; Medium parameters used:  $f = 2450$  MHz;  $\sigma = 1.82$  mho/m;  $\epsilon_r = 39.61$ ;  $\rho = 1000$  kg/m<sup>3</sup> ;

Phantom section: Flat Section; Input Power=18dBm

Ambient temperature (°C):22.2, Liquid temperature (°C): 21.6

**SATIMO Configuration**

- Probe: SSE2; Calibrated: Aug. 08,2017; Serial No.: SN 08/16 EPGO282
- Sensor-Surface: 4mm (Mechanical Surface Detection)
- Phantom: SAM twin phantom
- Measurement SW: OpenSAR V4\_02\_35

**Configuration/System Check 2450MHz Head/Area Scan: Measurement grid: dx=8mm, dy=8mm**

**Configuration/System Check 2450MHz Head/Zoom Scan: Measurement grid: dx=5mm,dy=5mm, dz=5mm**

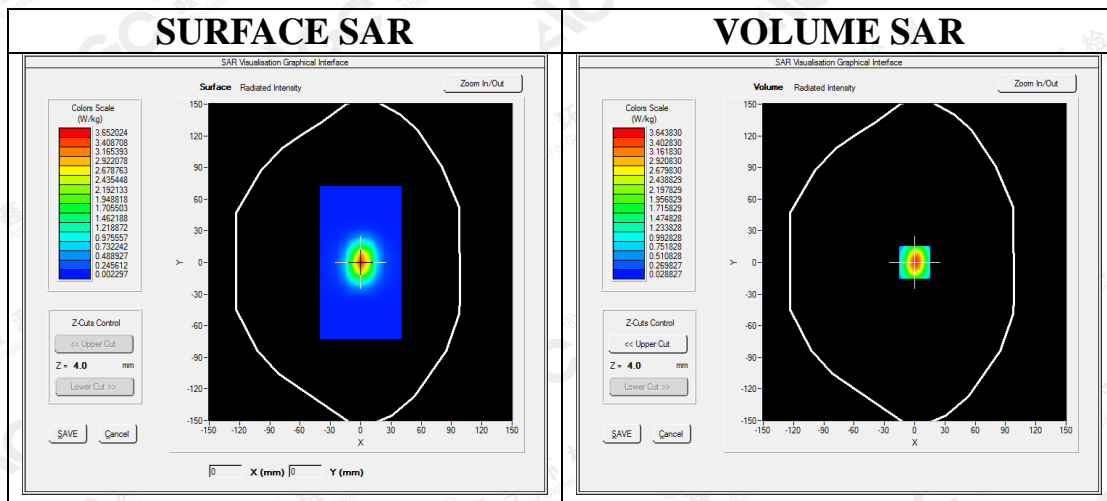

**Maximum location: X=0.00, Y=0.00**  
**SAR Peak: 5.90 W/kg**

<b>SAR 10g (W/Kg)</b>	1.539751
<b>SAR 1g (W/Kg)</b>	3.295317

The results shown in this test report refer only to the sample(s) tested unless otherwise stated and the sample(s) are retained for 30 days only. The document is issued by AGC, this document cannot be reproduced except in full with our prior written permission. The more details and the authenticity of the report will be confirmed at <http://www.agc-cert.com>.



Z (mm)	0.00	4.00	9.00	14.00	19.00	24.00	29.00
SAR (W/Kg)	5.9701	3.6395	1.8798	0.9722	0.5157	0.2703	0.1453

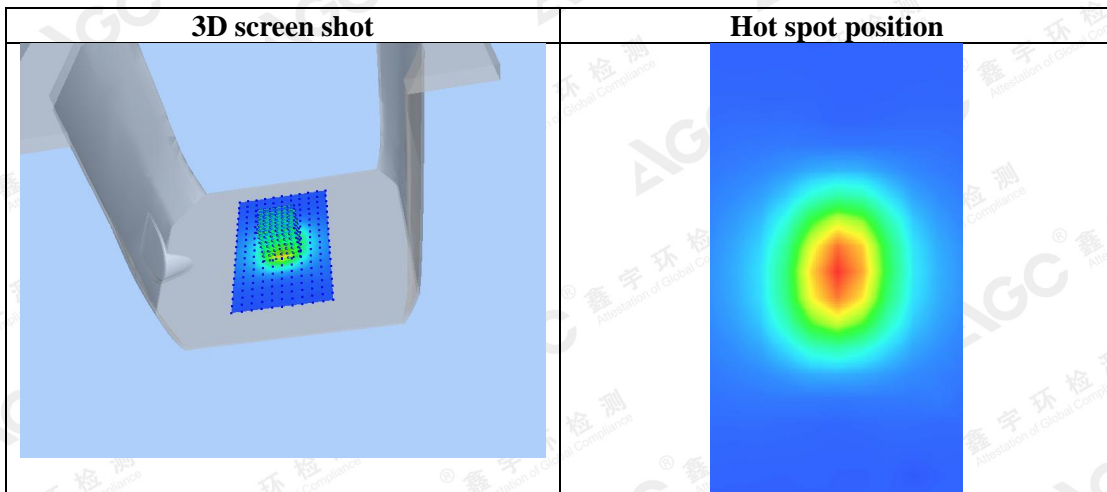
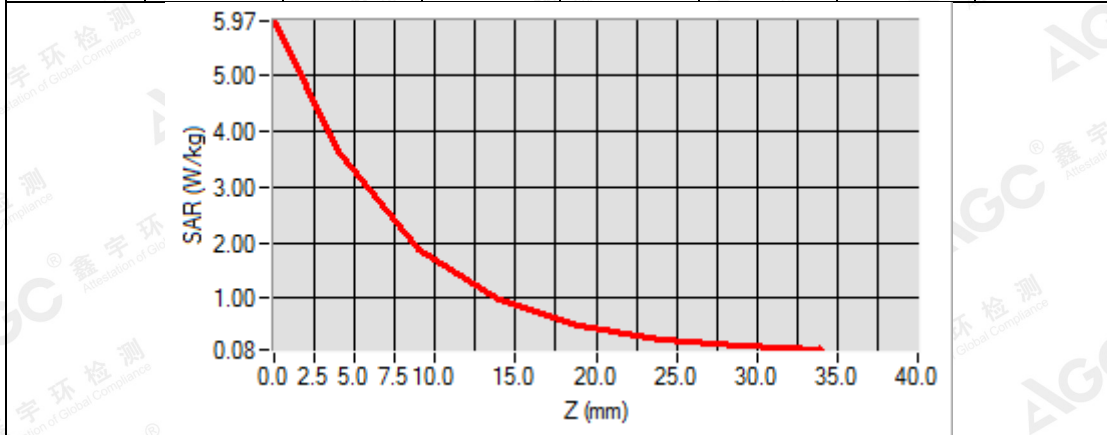

The results shown in this test report refer only to the sample(s) tested unless otherwise stated and the sample(s) are retained for 30 days only. The document is issued by AGC, this document cannot be reproduced except in full with our prior written permission. The more details and the authenticity of the report will be confirmed at <http://www.agc-cert.com>.

**Test Laboratory: AGC Lab**  
**System Check Body 2450 MHz**

**Date: May. 04,2018**

**DUT: Dipole 2450 MHz Type: SID 2450**

Communication System CW; Communication System Band: D2450 (2450.0 MHz); Duty Cycle: 1:1; Conv.F=2.58  
Frequency: 2450 MHz; Medium parameters used:  $f = 2450$  MHz;  $\sigma = 1.92$  mho/m;  $\epsilon_r = 53.61$ ;  $\rho = 1000$  kg/m<sup>3</sup> ;  
Phantom section: Flat Section; Input Power=18dBm  
Ambient temperature (°C):22.2, Liquid temperature (°C): 21.8

**SATIMO Configuration**

- Probe: SSE2; Calibrated: Aug. 08,2017; Serial No.: SN 08/16 EPGO282
- Sensor-Surface: 4mm (Mechanical Surface Detection)
- Phantom: SAM twin phantom
- Measurement SW: OpenSAR V4\_02\_35

**Configuration/System Check 2450MHz Body/Area Scan: Measurement grid: dx=8mm, dy=8mm**

**Configuration/System Check 2450MHz Body/Zoom Scan: Measurement grid: dx=5mm,dy=5mm, dz=5mm**

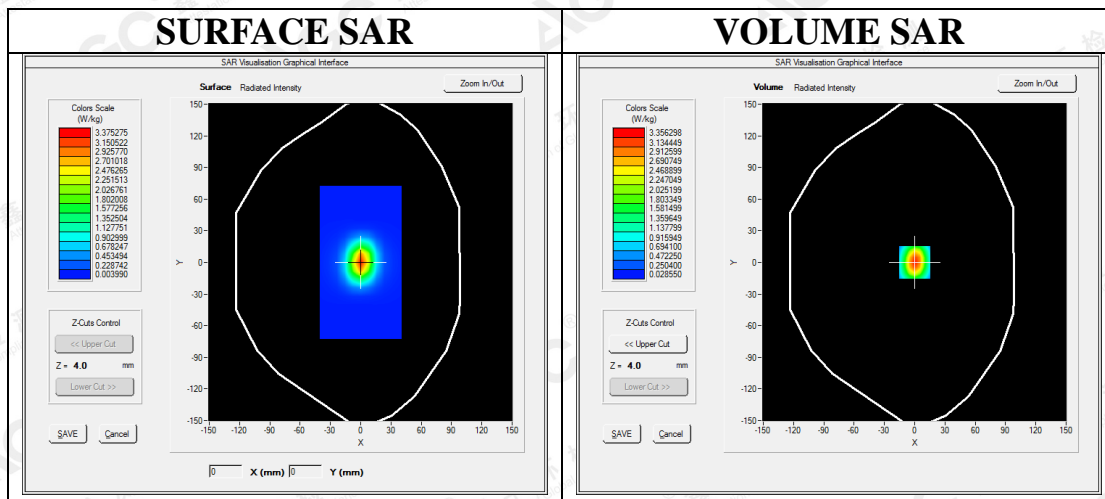

**Maximum location: X=0.00, Y=0.00**  
**SAR Peak: 5.44 W/kg**

<b>SAR 10g (W/Kg)</b>	1.439530
<b>SAR 1g (W/Kg)</b>	3.045117

The results shown in this test report refer only to the sample(s) tested unless otherwise stated and the sample(s) are retained for 30 days only. The document is issued by AGC, this document cannot be reproduced except in full with our prior written permission. The more details and the authenticity of the report will be confirmed at <http://www.agc-cert.com>.



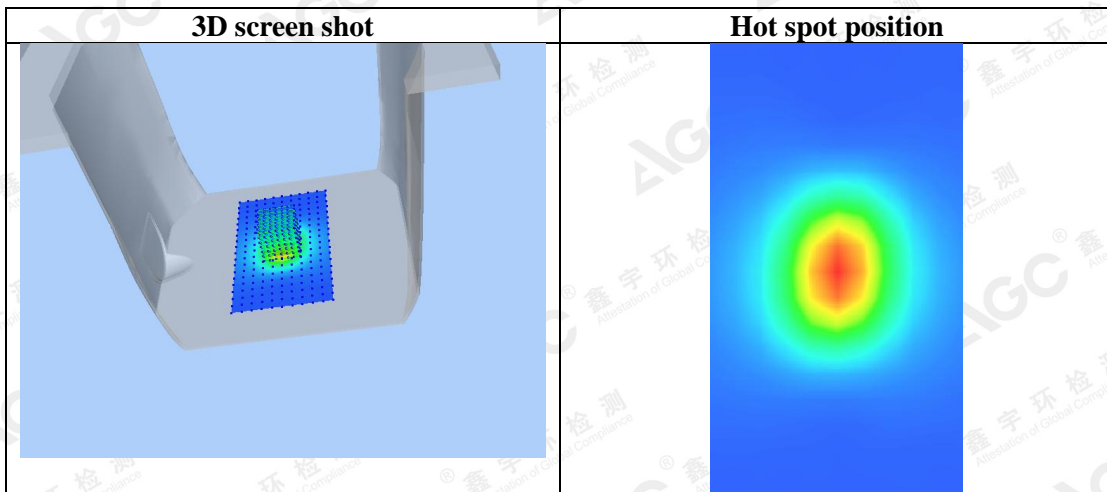
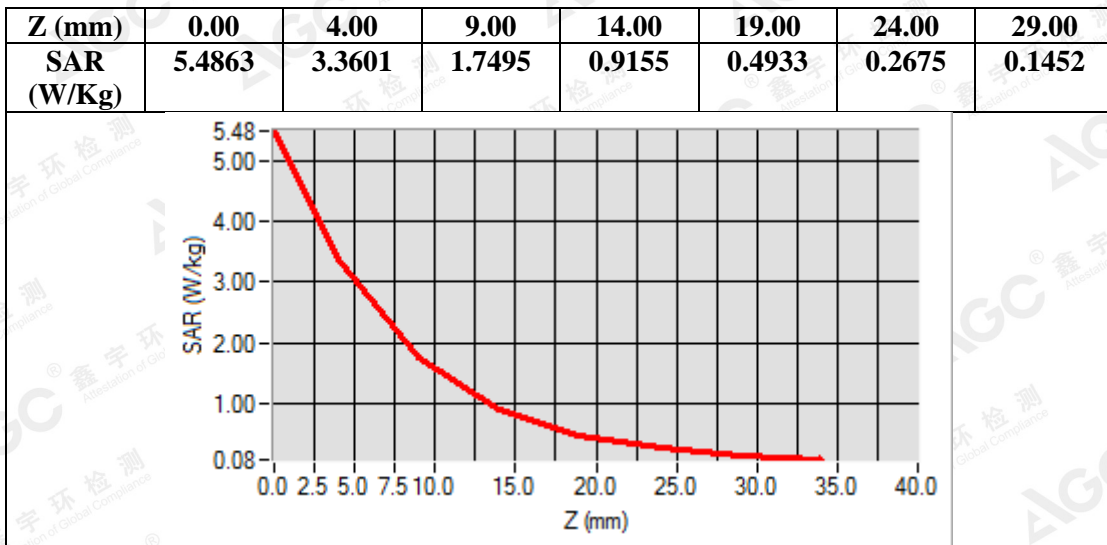

The results shown in this test report refer only to the sample(s) tested otherwise stated and the sample(s) are retained for 30 days only. The document is issued by AGC, this document cannot be reproduced except in full with our prior written permission. The more details and the authenticity of the report will be confirmed at <http://www.agc-cert.com>.

**APPENDIX B. SAR MEASUREMENT DATA**

Test Laboratory: AGC Lab  
GSM 850 Mid-Touch-Right <SIM 1>  
DUT: Smart Phone; Type: R11

Date: Apr. 28,2018

Communication System: Generic GSM; Communication System Band: GSM 850; Duty Cycle: 1:8.3; Conv.F=1.74;  
Frequency: 836.6 MHz; Medium parameters used:  $f = 835$  MHz;  $\sigma = 0.91$  mho/m;  $\epsilon_r = 41.09$ ;  $\rho = 1000$  kg/m<sup>3</sup> ;  
Phantom section: Right Section  
Ambient temperature (°C): 21.7, Liquid temperature (°C): 21.3

SATIMO Configuration:

- Probe: SSE2; Calibrated: Aug. 08,2017; Serial No.: SN 08/16 EPGO282
- Sensor-Surface: 4mm (Mechanical Surface Detection)
- Phantom: SAM twin phantom
- Measurement SW: OpenSAR V4\_02\_35

Configuration/GSM 850 Mid-Touch-Right/Area Scan: Measurement grid: dx=8mm, dy=8mm  
Configuration/GSM 850 Mid-Touch-Right/Zoom Scan: Measurement grid: dx=8mm,dy=8mm, dz=5mm;

Area Scan	sam_direct_droit2_surf8mm.txt
ZoomScan	5x5x7,dx=8mm dy=8mm dz=5mm,Complete
Phantom	Right head
Device Position	Cheek
Band	GSM 850
Channels	Middle
Signal	TDMA (Crest factor: 8.0)

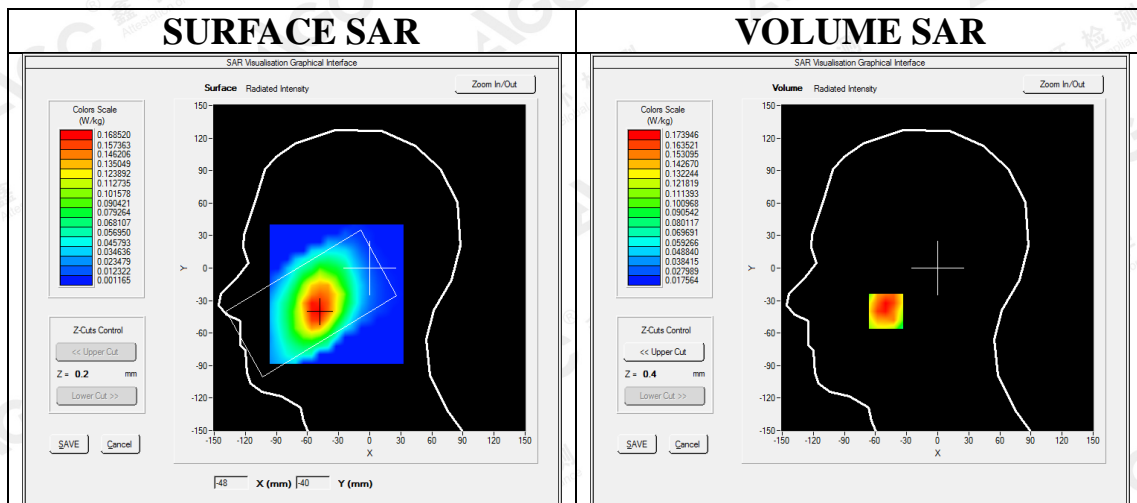

**Maximum location: X=-50.00, Y=-40.00**  
**SAR Peak: 0.30 W/kg**

<b>SAR 10g (W/Kg)</b>	0.122925
<b>SAR 1g (W/Kg)</b>	0.180486

The results shown in this test report refer only to the sample(s) tested unless otherwise stated and the sample(s) are retained for 30 days only. The document is issued by AGC, this document cannot be reproduced except in full with our prior written permission. The more details and the authenticity of the report will be confirmed at <http://www.agc-cert.com>.



Z (mm)	0.00	4.00	9.00	14.00	19.00	24.00	29.00
SAR (W/Kg)	0.2495	0.1739	0.1207	0.1115	0.0732	0.0736	0.0454

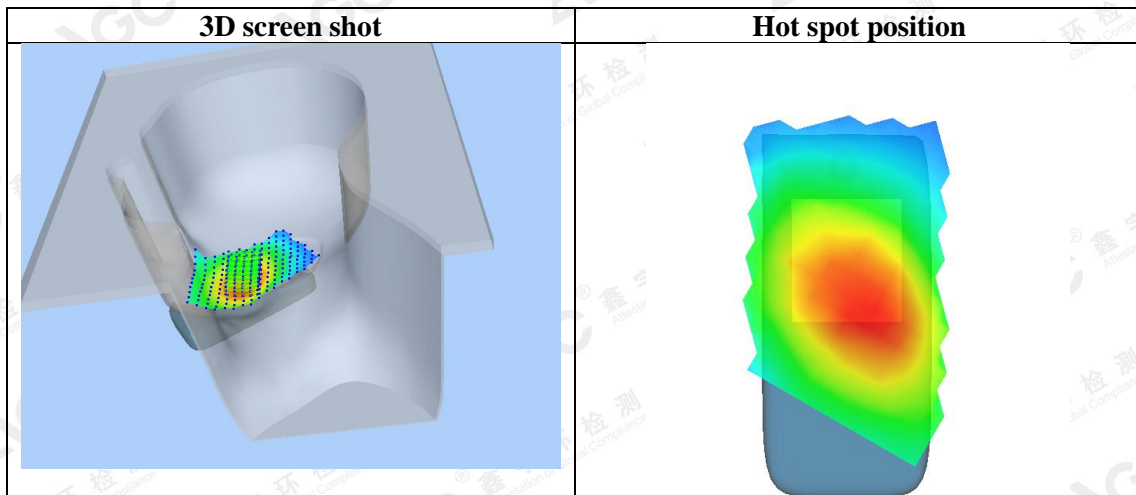
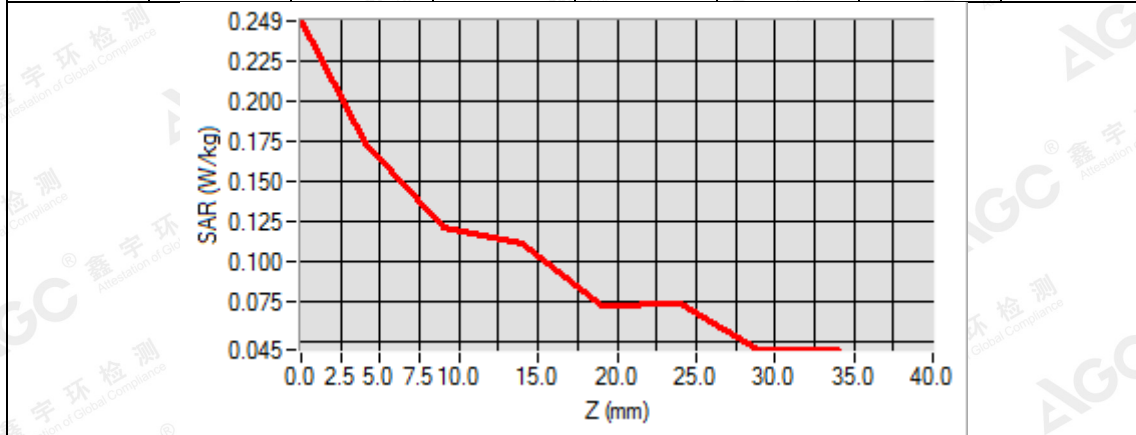

The results shown in this test report refer only to the sample(s) tested otherwise stated and the sample(s) are retained for 30 days only. The document is issued by AGC, this document cannot be reproduced except in full with our prior written permission. The more details and the authenticity of the report will be confirmed at <http://www.agc-cert.com>.

**Test Laboratory:** AGC Lab  
**GSM 850 Mid- Body- Back (MS)<SIM 1>**  
**DUT:** Smart Phone; **Type:** R11

**Date:** Apr. 28,2018

Communication System: Generic GSM; Communication System Band: GSM 850; Duty Cycle: 1:8.3; Conv.F=1.81;  
Frequency: 836.6 MHz; Medium parameters used: f = 835 MHz;  $\sigma = 0.97$  mho/m;  $\epsilon_r = 54.64$ ;  $\rho = 1000$  kg/m<sup>3</sup> ;  
Phantom section: Flat Section  
Ambient temperature (°C): 21.7, Liquid temperature (°C): 21.4

**SATIMO Configuration:**

- Probe: SSE2; Calibrated: Aug. 08,2017; Serial No.: SN 08/16 EPGO282
- Sensor-Surface: 4mm (Mechanical Surface Detection)
- Phantom: SAM twin phantom
- Measurement SW: OpenSAR V4\_02\_35

**Configuration/GSM 850 Mid-Body-Back/Area Scan:** Measurement grid: dx=8mm, dy=8mm

**Configuration/GSM 850 Mid-Body-Back/Zoom Scan:** Measurement grid: dx=8mm,dy=8mm, dz=5mm;

<b>Area Scan</b>	sam_direct_droit2_surf8mm.txt
<b>ZoomScan</b>	5x5x7,dx=8mm dy=8mm dz=5mm,Complete
<b>Phantom</b>	Validation plane
<b>Device Position</b>	Body Back
<b>Band</b>	GSM 850
<b>Channels</b>	Middle
<b>Signal</b>	TDMA (Crest factor: 8.0)

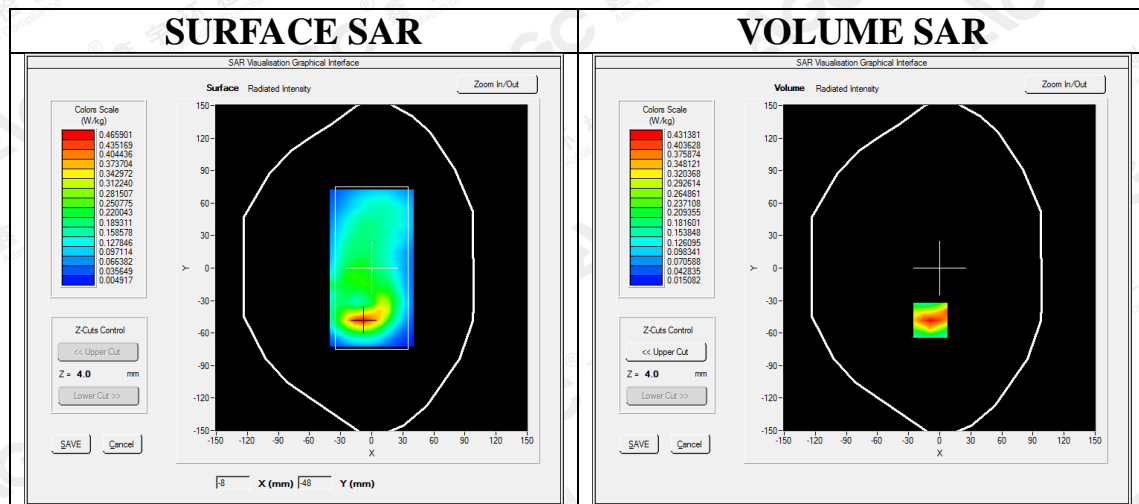

**Maximum location: X=-9.00, Y=-48.00**

**SAR Peak: 0.68 W/kg**

<b>SAR 10g (W/Kg)</b>	0.221252
<b>SAR 1g (W/Kg)</b>	0.401232

The results shown in this test report refer only to the sample(s) tested unless otherwise stated and the sample(s) are retained for 30 days only. The document is issued by AGC, this document cannot be reproduced except in full with our prior written permission. The more details and the authenticity of the report will be confirmed at <http://www.agc-cert.com>.



Z (mm)	0.00	4.00	9.00	14.00	19.00	24.00	29.00
SAR (W/Kg)	0.6833	0.4314	0.2422	0.1470	0.0932	0.0586	0.0384

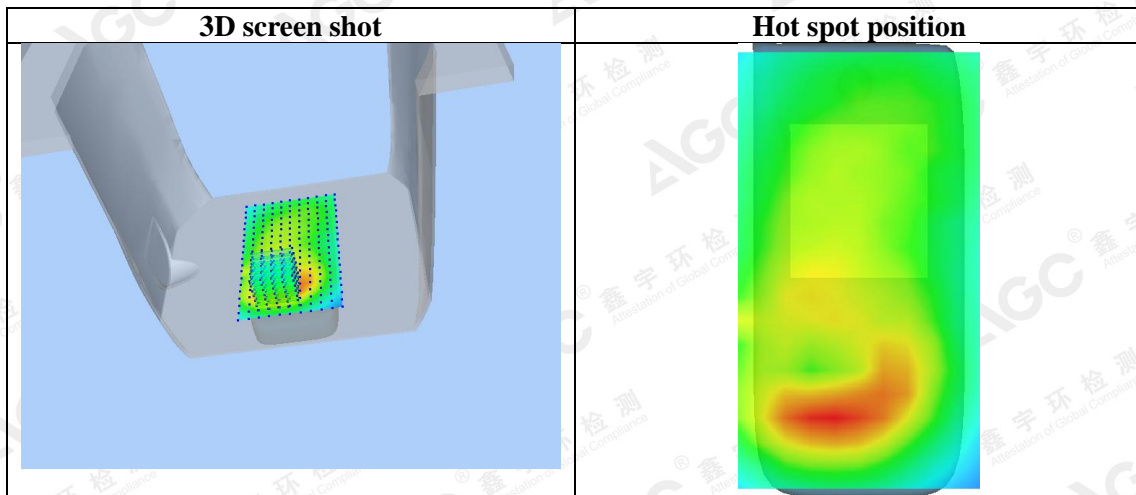
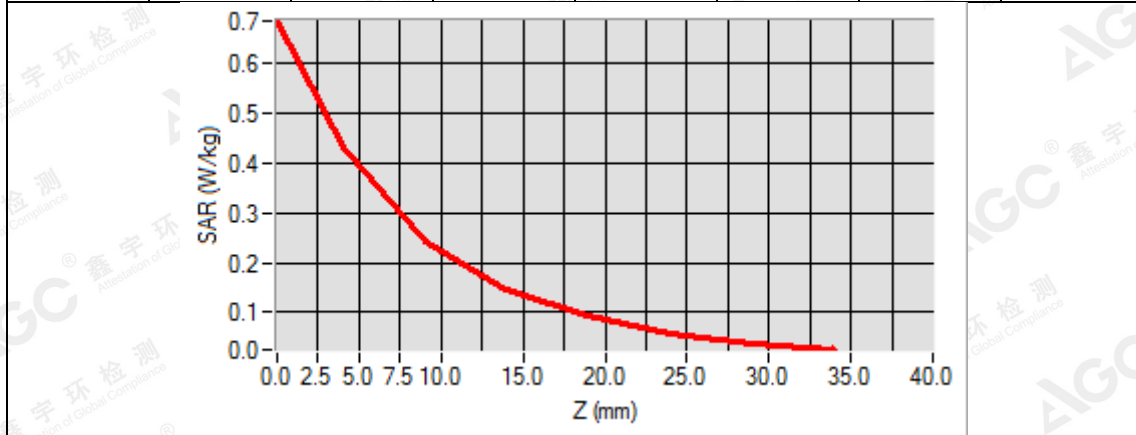

The results shown in this test report refer only to the sample(s) tested unless otherwise stated and the sample(s) are retained for 30 days only. The document is issued by AGC, this document cannot be reproduced except in full with our prior written permission. The more details and the authenticity of the report will be confirmed at <http://www.agc-cert.com>.

**Test Laboratory:** AGC Lab  
**GPRS 850 Mid- Touch-Right (2up)**  
**DUT:** Smart Phone; **Type:** R11

**Date:** Apr. 28,2018

Communication System: GPRS-2 Slot; Communication System Band: GSM 850; Duty Cycle: 1:4.2; Conv.F=1.74  
Frequency: 836.6 MHz; Medium parameters used: f = 835 MHz;  $\sigma=0.91$  mho/m;  $\epsilon_r=41.09$ ;  $\rho=1000$  kg/m<sup>3</sup>;  
Phantom section: Right Section  
Ambient temperature (°C): 21.7, Liquid temperature (°C): 21.3

**SATIMO Configuration:**

- Probe: SSE2; Calibrated: Aug. 08,2017; Serial No.: SN 08/16 EPGO282
- Sensor-Surface: 4mm (Mechanical Surface Detection)
- Phantom: SAM twin phantom
- Measurement SW: OpenSAR V4\_02\_35

**Configuration/GPRS 850 Mid-Touch-Right/Area Scan:** Measurement grid: dx=8mm, dy=8mm  
**Configuration/GPRS 850 Mid-Touch-Right/Zoom Scan:** Measurement grid: dx=8mm,dy=8mm, dz=5mm;

<b>Area Scan</b>	sam_direct_droit2_surf8mm.txt
<b>Zoom Scan</b>	5x5x7,dx=8mm dy=8mm dz=5mm,Complete
<b>Phantom</b>	Right head
<b>Device Position</b>	Cheek
<b>Band</b>	GSM 850
<b>Channels</b>	Middle
<b>Signal</b>	TDMA (Crest factor: 4.0)

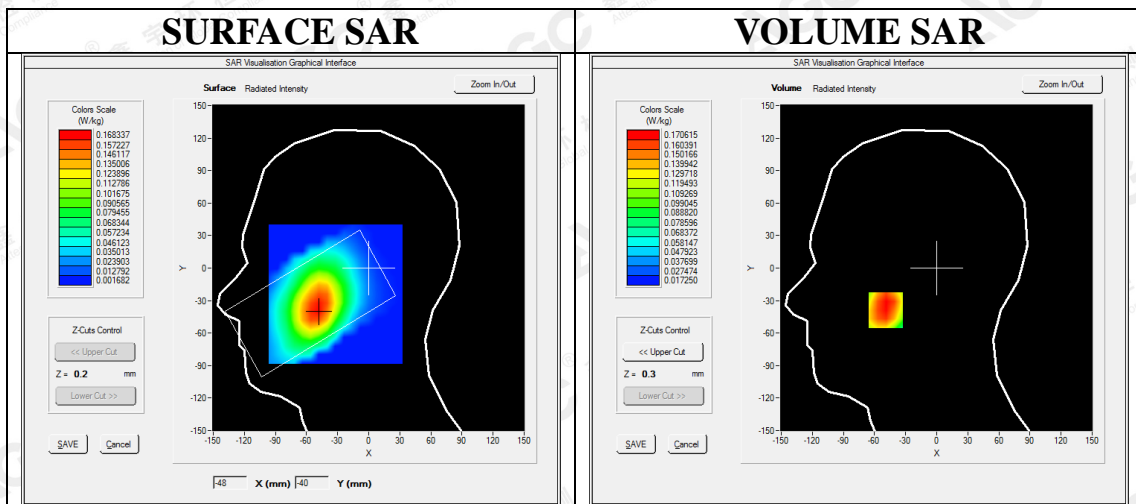

**Maximum location: X=-49.00, Y=-39.00**  
**SAR Peak: 0.22 W/kg**

<b>SAR 10g (W/Kg)</b>	0.122420
<b>SAR 1g (W/Kg)</b>	0.165389

The results shown in this test report refer only to the sample(s) tested unless otherwise stated and the sample(s) are retained for 30 days only. The document is issued by AGC, this document cannot be reproduced except in full with our prior written permission. The more details and the authenticity of the report will be confirmed at <http://www.agc-cert.com>.



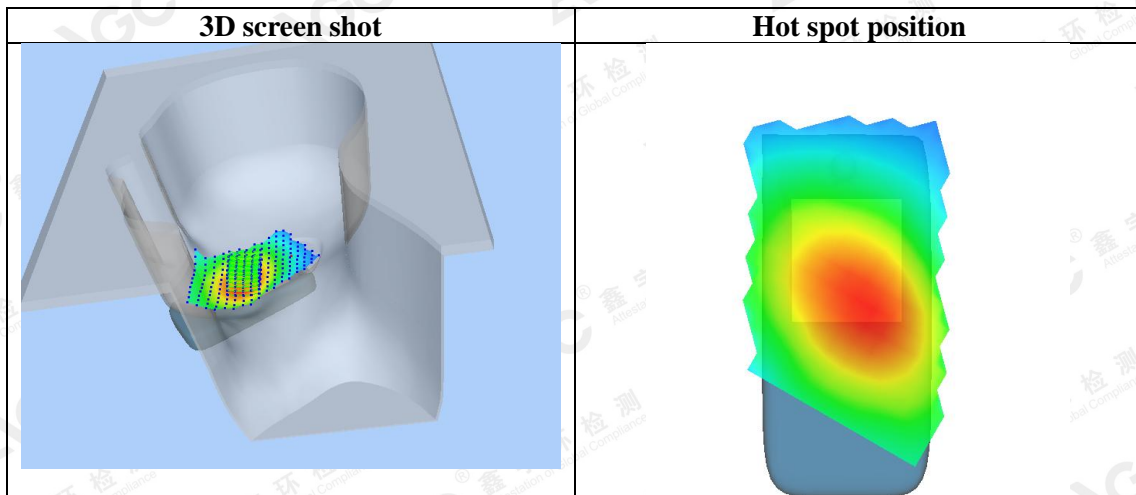
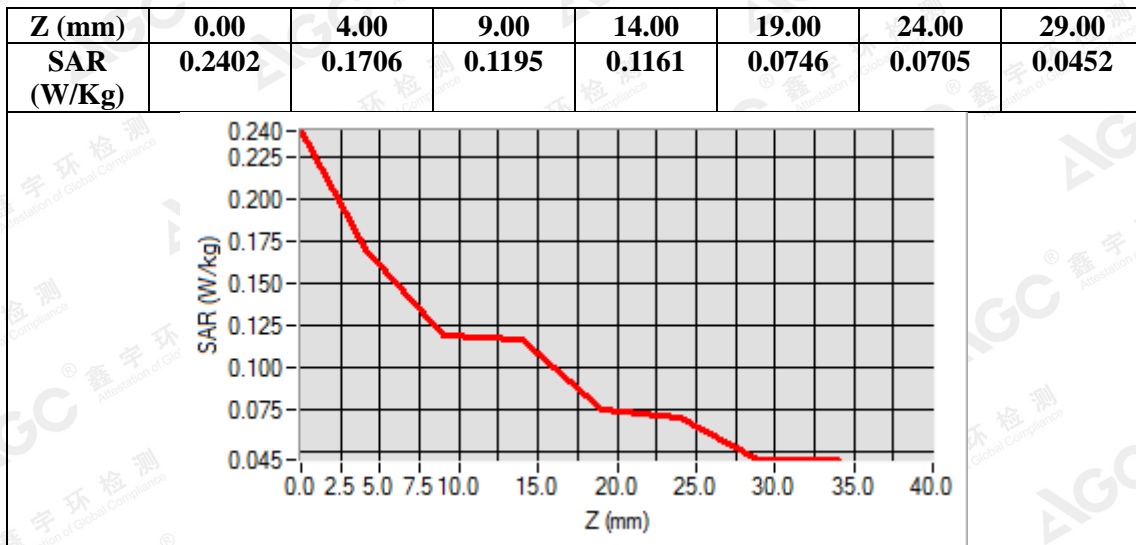

The results shown in this test report refer only to the sample(s) tested otherwise stated and the sample(s) are retained for 30 days only. The document is issued by AGC, this document cannot be reproduced except in full with our prior written permission. The more details and the authenticity of the report will be confirmed at <http://www.agc-cert.com>.

**Test Laboratory: AGC Lab**  
**GPRS 850 Mid- Body- Back (2up)**  
**DUT: Smart Phone; Type: R11**

**Date: Apr. 28,2018**

Communication System: GPRS-2 Slot; Communication System Band: GSM 850; Duty Cycle: 1:4.2; Conv.F=1.81;  
Frequency: 836.6 MHz; Medium parameters used:  $f = 835$  MHz;  $\sigma = 0.97$  mho/m;  $\epsilon_r = 54.64$ ;  $\rho = 1000$  kg/m<sup>3</sup> ;  
Phantom section: Flat Section  
Ambient temperature (°C): 21.7, Liquid temperature (°C): 21.4

**SATIMO Configuration:**

- Probe: SSE2; Calibrated: Aug. 08,2017; Serial No.: SN 08/16 EPGO282
- Sensor-Surface: 4mm (Mechanical Surface Detection)
- Phantom: SAM twin phantom
- Measurement SW: OpenSAR V4\_02\_35

**Configuration/GPRS 850 Mid-Body-Back/Area Scan:** Measurement grid: dx=8mm, dy=8mm

**Configuration/GPRS 850 Mid-Body-Back/Zoom Scan:** Measurement grid: dx=8mm,dy=8mm, dz=5mm;

<b>Area Scan</b>	sam_direct_droit2_surf8mm.txt
<b>Zoom Scan</b>	5x5x7,dx=8mm dy=8mm dz=5mm,Complete
<b>Phantom</b>	Validation plane
<b>Device Position</b>	Body Back
<b>Band</b>	GSM 850
<b>Channels</b>	Middle
<b>Signal</b>	TDMA (Crest factor: 4.0)

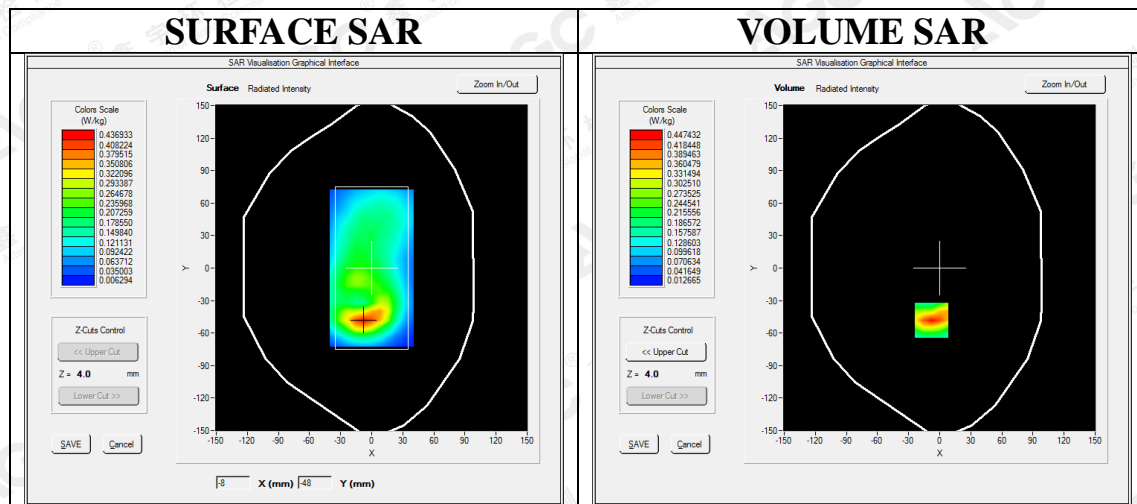

**Maximum location: X=-8.00, Y=-48.00**

**SAR Peak: 0.69 W/kg**

<b>SAR 10g (W/Kg)</b>	0.226065
<b>SAR 1g (W/Kg)</b>	0.412719

The results shown in this test report refer only to the sample(s) tested unless otherwise stated and the sample(s) are retained for 30 days only. The document is issued by AGC, this document cannot be reproduced except in full with our prior written permission. The more details and the authenticity of the report will be confirmed at <http://www.agc-cert.com>.



Z (mm)	0.00	4.00	9.00	14.00	19.00	24.00	29.00
SAR (W/Kg)	0.6936	0.4474	0.2586	0.1551	0.0984	0.0632	0.0391

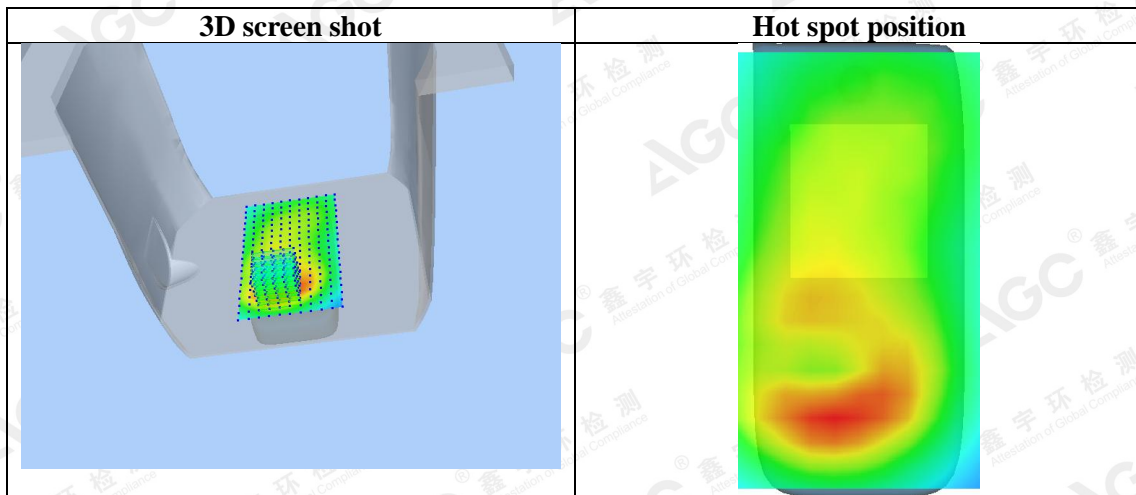
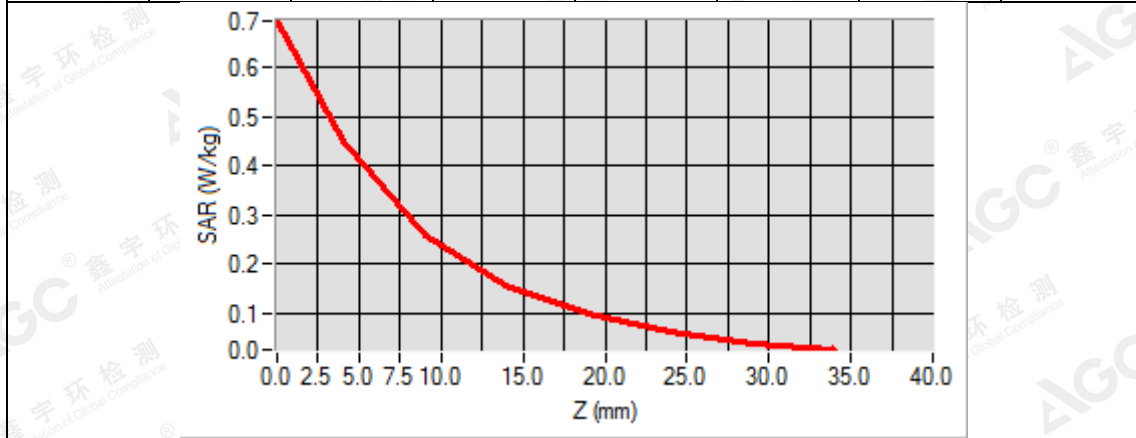

The results shown in this test report refer only to the sample(s) tested unless otherwise stated and the sample(s) are retained for 30 days only. The document is issued by AGC, this document cannot be reproduced except in full with our prior written permission. The more details and the authenticity of the report will be confirmed at <http://www.agc-cert.com>.

**Test Laboratory: AGC Lab**  
**PCS 1900 Mid-Touch-Right <SIM 1>**  
**DUT: Smart Phone; Type: R11**

**Date: May. 02,2018**

Communication System: Generic GSM; Communication System Band: PCS 1900; Duty Cycle: 1:8.3; Conv.F=2.32;  
Frequency: 1880 MHz; Medium parameters used:  $f = 1900$  MHz;  $\sigma = 1.39$  mho/m;  $\epsilon_r = 40.61$ ;  $\rho = 1000$  kg/m<sup>3</sup> ;  
Phantom section: Right Section  
Ambient temperature (°C): 21.7, Liquid temperature (°C): 21.2

**SATIMO Configuration:**

- Probe: SSE2; Calibrated: Aug. 08,2017; Serial No.: SN 08/16 EPGO282
- Sensor-Surface: 4mm (Mechanical Surface Detection)
- Phantom: SAM twin phantom
- Measurement SW: OpenSAR V4\_02\_35

**Configuration/PCS1900 Mid-Touch-Right/Area Scan: Measurement grid: dx=8mm, dy=8mm**

**Configuration/PCS1900 Mid-Touch-Right/Zoom Scan: Measurement grid: dx=8mm,dy=8mm, dz=5mm;**

<b>Area Scan</b>	sam_direct_droit2_surf8mm.txt
<b>ZoomScan</b>	5x5x7,dx=8mm dy=8mm dz=5mm,Complete
<b>Phantom</b>	Right head
<b>Device Position</b>	Cheek
<b>Band</b>	PCS 1900
<b>Channels</b>	Middle
<b>Signal</b>	TDMA (Crest factor: 8.0)

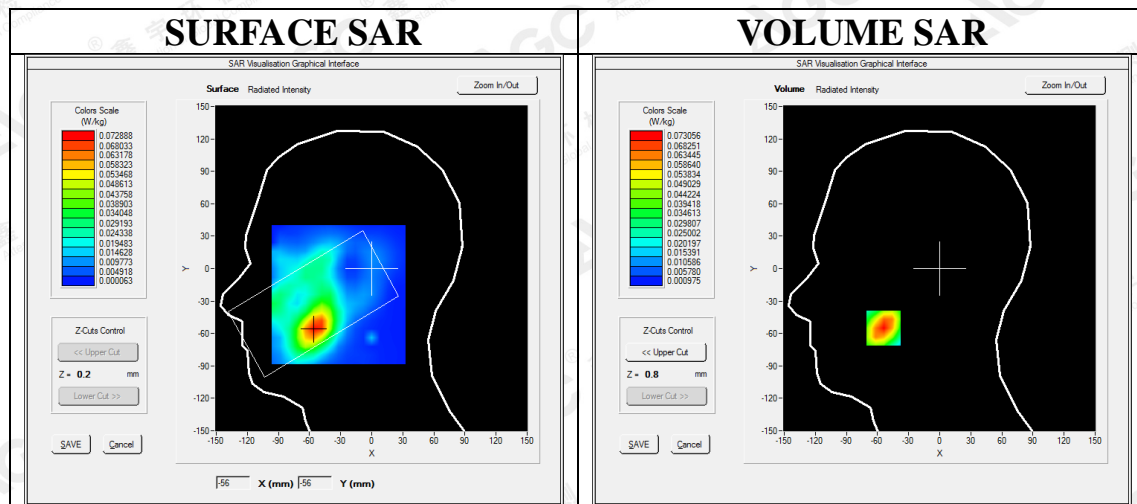

**Maximum location: X=-54.00, Y=-55.00**

**SAR Peak: 0.11 W/kg**

<b>SAR 10g (W/Kg)</b>	0.038800
<b>SAR 1g (W/Kg)</b>	0.069275

The results shown in this test report refer only to the sample(s) tested unless otherwise stated and the sample(s) are retained for 30 days only. The document is issued by AGC, this document cannot be reproduced except in full with our prior written permission. The more details and the authenticity of the report will be confirmed at <http://www.agc-cert.com>.



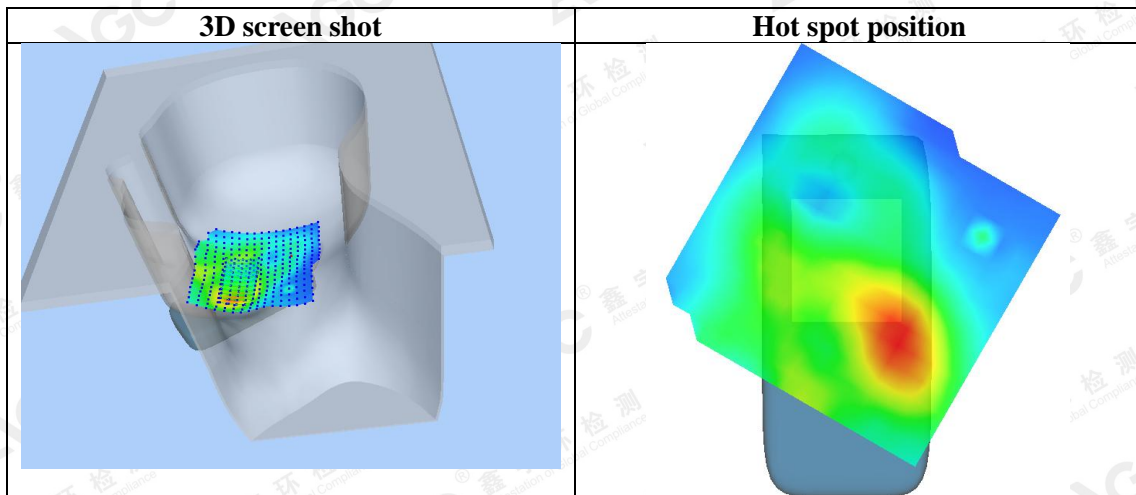
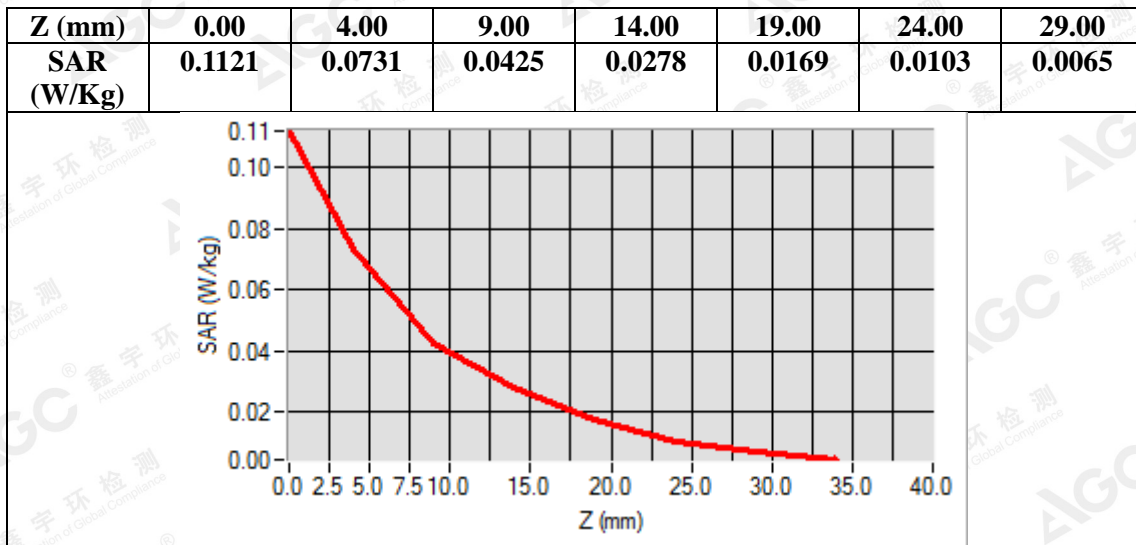

The results shown in this test report refer only to the sample(s) tested otherwise stated and the sample(s) are retained for 30 days only. The document is issued by AGC, this document cannot be reproduced except in full with our prior written permission. The more details and the authenticity of the report will be confirmed at <http://www.agc-cert.com>.

**Test Laboratory:** AGC Lab  
**PCS 1900 Mid-Body-Back (MS)<SIM 1>**  
**DUT:** Smart Phone; **Type:** R11

**Date:** May. 02,2018

Communication System: Generic GSM; Communication System Band: PCS 1900; Duty Cycle: 1:8.3; Conv.F=2.39;  
Frequency: 1880 MHz; Medium parameters used:  $f = 1900$  MHz;  $\sigma = 1.51$  mho/m;  $\epsilon_r = 54.16$ ;  $\rho = 1000$  kg/m<sup>3</sup> ;  
Phantom section: Flat Section  
Ambient temperature (°C): 21.7, Liquid temperature (°C): 21.4

**SATIMO Configuration:**

- Probe: SSE2; Calibrated: Aug. 08,2017; Serial No.: SN 08/16 EPGO282
- Sensor-Surface: 4mm (Mechanical Surface Detection)
- Phantom: SAM twin phantom
- Measurement SW: OpenSAR V4\_02\_35

**Configuration/PCS1900 Mid-Body-Back/Area Scan:** Measurement grid: dx=8mm, dy=8mm  
**Configuration/PCS1900 Mid-Body-Back/Zoom Scan:** Measurement grid: dx=8mm,dy=8mm, dz=5mm;

<b>Area Scan</b>	sam_direct_droit2_surf8mm.txt
<b>ZoomScan</b>	5x5x7,dx=8mm dy=8mm dz=5mm,Complete
<b>Phantom</b>	Validation plane
<b>Device Position</b>	Body Back
<b>Band</b>	PCS 1900
<b>Channels</b>	Middle
<b>Signal</b>	TDMA (Crest factor: 8.0)

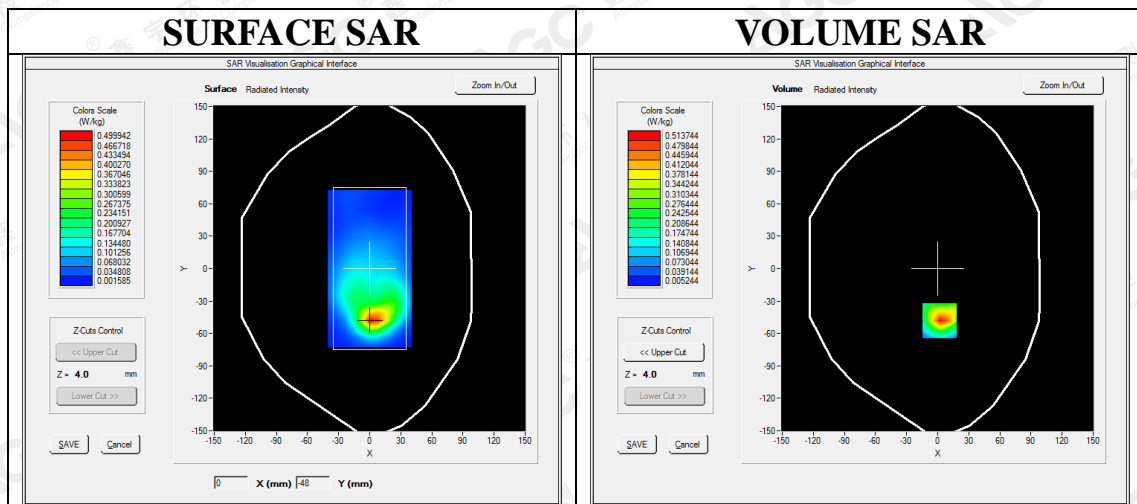

**Maximum location: X=2.00, Y=-48.00**  
**SAR Peak: 0.84 W/kg**

<b>SAR 10g (W/Kg)</b>	0.233042
<b>SAR 1g (W/Kg)</b>	0.475305

The results shown in this test report refer only to the sample(s) tested unless otherwise stated and the sample(s) are retained for 30 days only. The document is issued by AGC, this document cannot be reproduced except in full with our prior written permission. The more details and the authenticity of the report will be confirmed at <http://www.agc-cert.com>.



Z (mm)	0.00	4.00	9.00	14.00	19.00	24.00	29.00
SAR (W/Kg)	0.8300	0.5137	0.2768	0.1555	0.0904	0.0518	0.0278

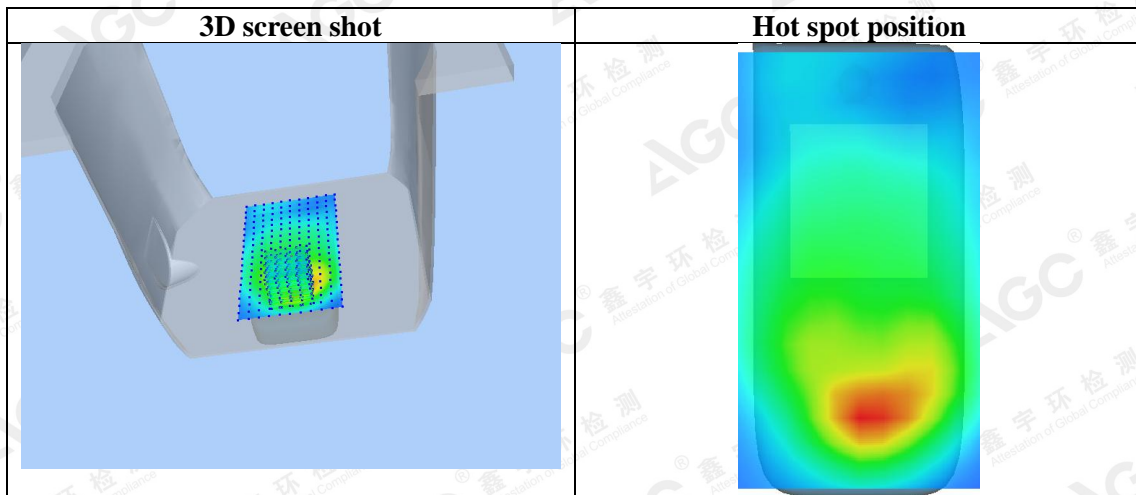
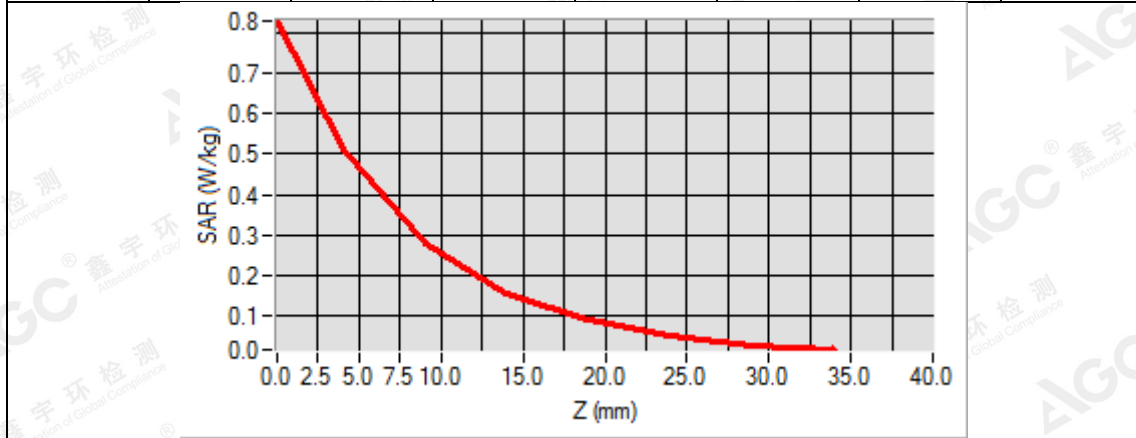

The results shown in this test report refer only to the sample(s) tested unless otherwise stated and the sample(s) are retained for 30 days only. The document is issued by AGC, this document cannot be reproduced except in full with our prior written permission. The more details and the authenticity of the report will be confirmed at <http://www.agc-cert.com>.

**Test Laboratory: AGC Lab**  
**GPRS 1900 Mid-Touch- Left (3up)**  
**DUT: Smart Phone; Type: R11**

**Date: May. 02,2018**

Communication System: GPRS-3Slot; Communication System Band: PCS 1900; Duty Cycle: 1:2.7; Conv.F=2.32;  
Frequency: 1880 MHz; Medium parameters used:  $f = 1900$  MHz;  $\sigma = 1.39$  mho/m;  $\epsilon_r = 40.61$ ;  $\rho = 1000$  kg/m<sup>3</sup> ;  
Phantom section: Left Section  
Ambient temperature (°C): 21.7, Liquid temperature (°C): 21.2

**SATIMO Configuration:**

- Probe: SSE2; Calibrated: Aug. 08,2017; Serial No.: SN 08/16 EPGO282
- Sensor-Surface: 4mm (Mechanical Surface Detection)
- Phantom: SAM twin phantom
- Measurement SW: OpenSAR V4\_02\_35

**Configuration/GPRS1900 Mid-Touch-Left/Area Scan:** Measurement grid: dx=8mm, dy=8mm

**Configuration/GPRS1900 Mid-Touch-Left/Zoom Scan:** Measurement grid: dx=8mm,dy=8mm, dz=5mm;

<b>Area Scan</b>	sam_direct_droit2_surf8mm.txt
<b>Zoom Scan</b>	5x5x7,dx=8mm dy=8mm dz=5mm,Complete
<b>Phantom</b>	Left head
<b>Device Position</b>	Cheek
<b>Band</b>	PCS 1900
<b>Channels</b>	Middle
<b>Signal</b>	TDMA (Crest factor: 2.7)

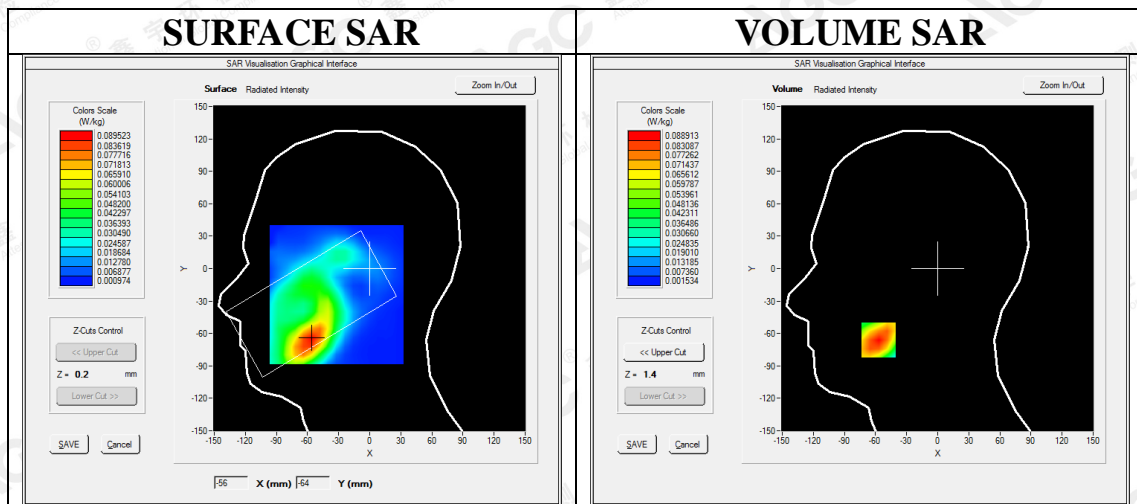

**Maximum location: X=-57.00, Y=-66.00**

**SAR Peak: 0.14 W/kg**

<b>SAR 10g (W/Kg)</b>	0.049745
<b>SAR 1g (W/Kg)</b>	0.085647

The results shown in this test report refer only to the sample(s) tested unless otherwise stated and the sample(s) are retained for 30 days only. The document is issued by AGC, this document cannot be reproduced except in full with our prior written permission. The more details and the authenticity of the report will be confirmed at <http://www.agc-cert.com>.



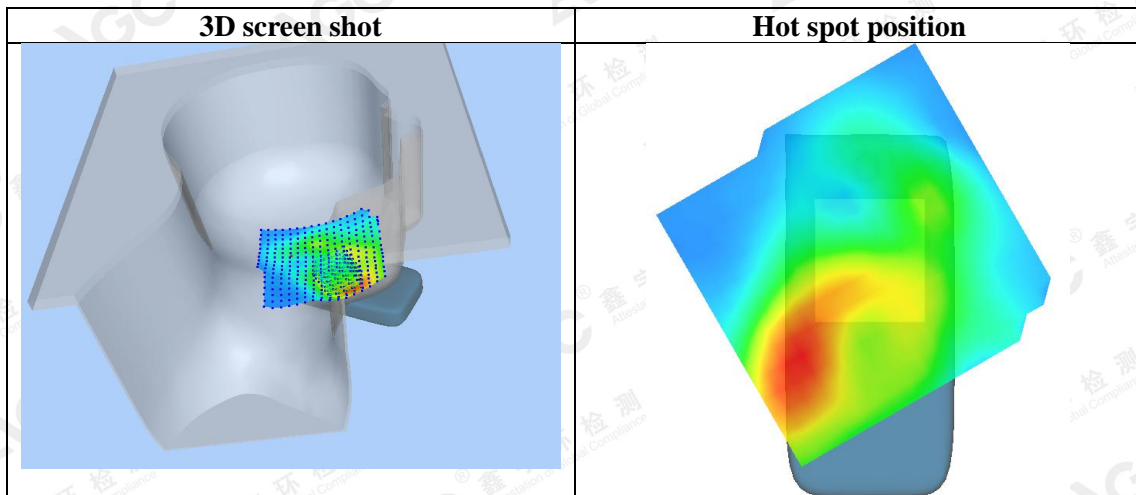
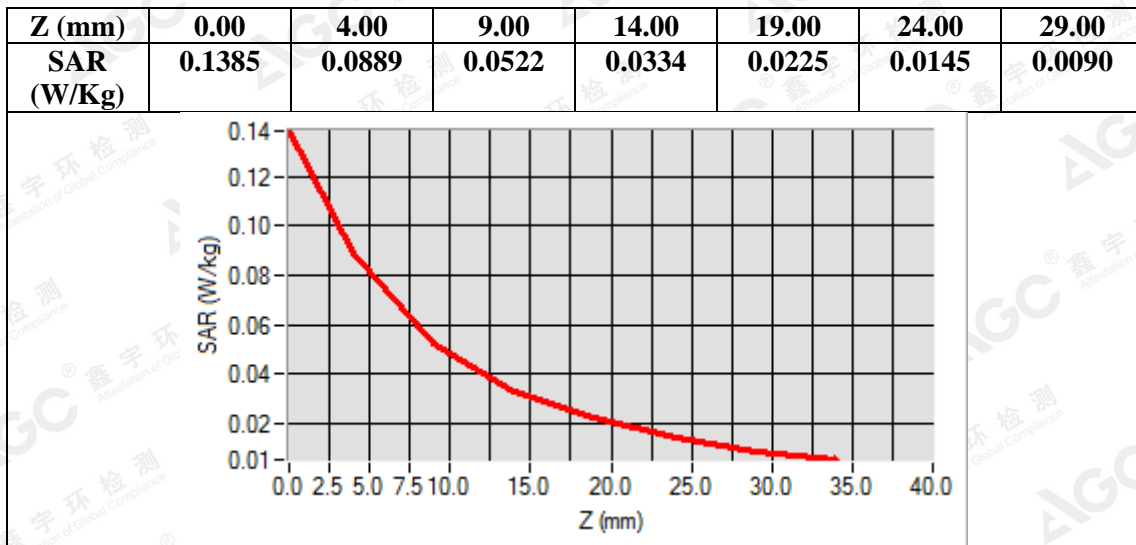

The results shown in this test report refer only to the sample(s) tested otherwise stated and the sample(s) are retained for 30 days only. The document is issued by AGC, this document cannot be reproduced except in full with our prior written permission. The more details and the authenticity of the report will be confirmed at <http://www.agc-cert.com>.

**Test Laboratory: AGC Lab**  
**GPRS 1900 Mid-Body-Back (3up)**  
**DUT: Smart Phone; Type: R11**

**Date: May. 02,2018**

Communication System: GPRS-3Slot; Communication System Band: PCS 1900; Duty Cycle: 1:2.7; Conv.F=2.39;  
Frequency: 1880 MHz; Medium parameters used:  $f = 1900$  MHz;  $\sigma = 1.51$  mho/m;  $\epsilon_r = 54.16$ ;  $\rho = 1000$  kg/m<sup>3</sup> ;  
Phantom section: Flat Section  
Ambient temperature (°C): 21.7, Liquid temperature (°C): 21.4

SATIMO Configuration:

- Probe: SSE2; Calibrated: Aug. 08,2017; Serial No.: SN 08/16 EPGO282
- Sensor-Surface: 4mm (Mechanical Surface Detection)
- Phantom: SAM twin phantom
- Measurement SW: OpenSAR V4\_02\_35

**Configuration/GPRS1900 Mid-Body-Back/Area Scan:** Measurement grid: dx=8mm, dy=8mm

**Configuration/GPRS1900 Mid-Body-Back/Zoom Scan:** Measurement grid: dx=8mm,dy=8mm, dz=5mm;

<b>Area Scan</b>	sam_direct_droit2_surf8mm.txt
<b>Zoom Scan</b>	5x5x7,dx=8mm dy=8mm dz=5mm,Complete
<b>Phantom</b>	Validation plane
<b>Device Position</b>	Body Back
<b>Band</b>	PCS 1900
<b>Channels</b>	Middle
<b>Signal</b>	TDMA (Crest factor: 2.7)

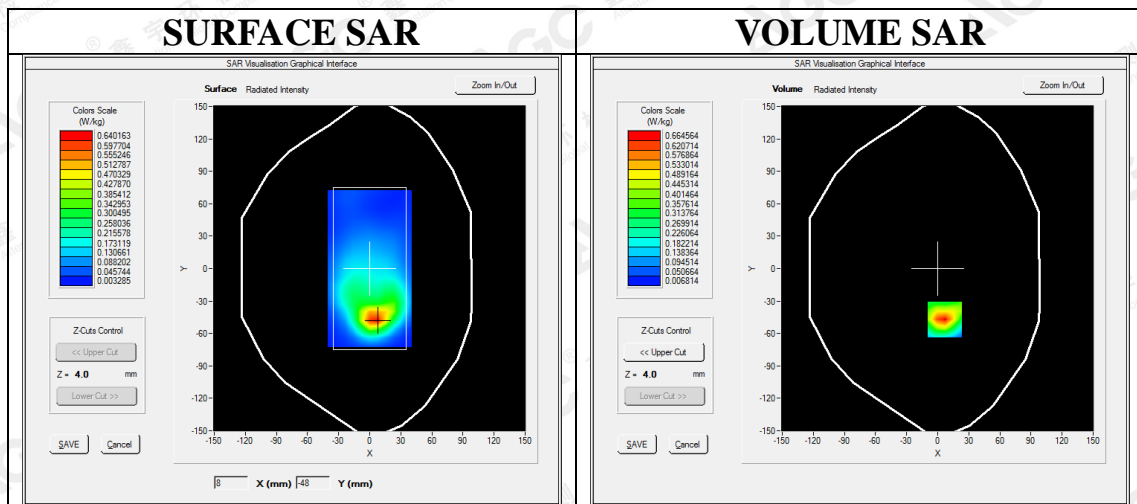

**Maximum location: X=7.00, Y=-47.00**

**SAR Peak: 1.07 W/kg**

<b>SAR 10g (W/Kg)</b>	0.306870
<b>SAR 1g (W/Kg)</b>	0.617552

The results shown in this test report refer only to the sample(s) tested unless otherwise stated and the sample(s) are retained for 30 days only. The document is issued by AGC, this document cannot be reproduced except in full with our prior written permission. The more details and the authenticity of the report will be confirmed at <http://www.agc-cert.com>.



Z (mm)	0.00	4.00	9.00	14.00	19.00	24.00	29.00
SAR (W/Kg)	1.0756	0.6646	0.3508	0.1998	0.1077	0.0588	0.0339

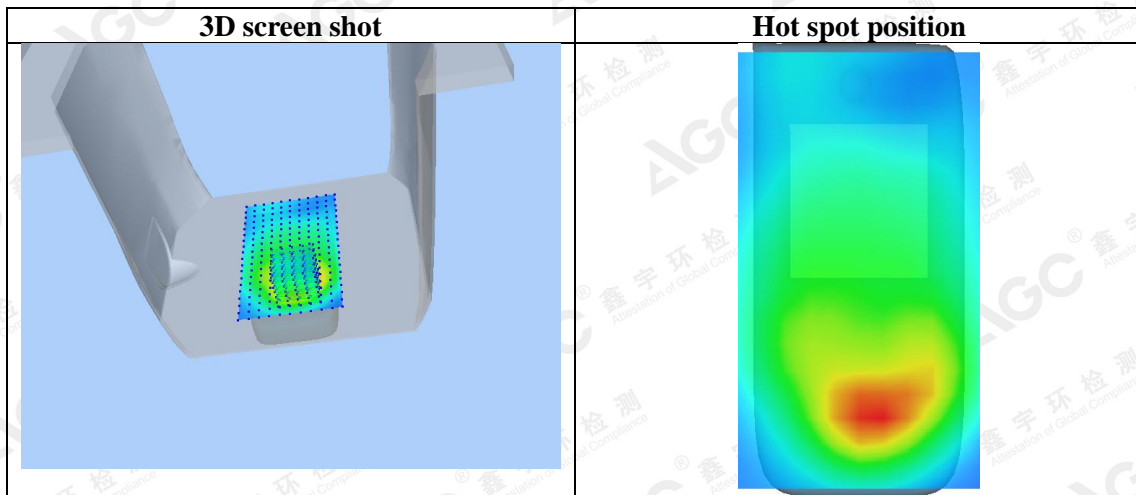
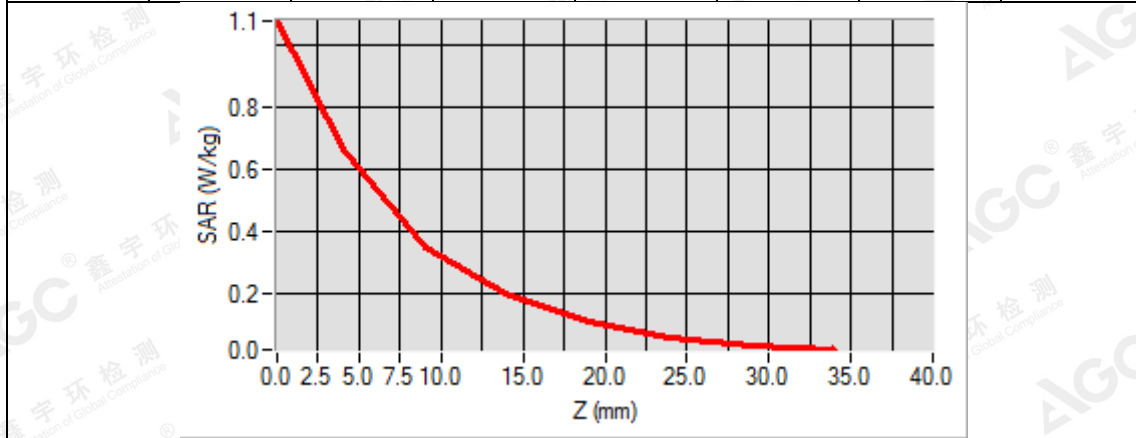

The results shown in this test report refer only to the sample(s) tested unless otherwise stated and the sample(s) are retained for 30 days only. The document is issued by AGC, this document cannot be reproduced except in full with our prior written permission. The more details and the authenticity of the report will be confirmed at <http://www.agc-cert.com>.

**Test Laboratory: AGC Lab**  
**WCDMA Band II Mid-Touch-Left (RMC)**  
**DUT: Smart Phone; Type: R11**

**Date: May. 07,2018**

Communication System: UMTS; Communication System Band: Band II UTRA/FDD ;Duty Cycle:1:1; Conv.F=2.32;  
Frequency: 1880 MHz; Medium parameters used: f = 1900 MHz;  $\sigma = 1.38$  mho/m;  $\epsilon_r = 40.63$ ;  $\rho = 1000$  kg/m<sup>3</sup> ;  
Phantom section: Left Section  
Ambient temperature (°C): 21.7, Liquid temperature (°C): 21.1

**SATIMO Configuration:**

- Probe: SSE2; Calibrated: Aug. 08,2017; Serial No.: SN 08/16 EPGO282
- Sensor-Surface: 4mm (Mechanical Surface Detection)
- Phantom: SAM twin phantom
- Measurement SW: OpenSAR V4\_02\_35

**Configuration/ WCDMA Band II Mid-Touch-Left/Area Scan:** Measurement grid: dx=8mm, dy=8mm  
**Configuration/ WCDMA Band II Mid-Touch-Left/Zoom Scan:** Measurement grid:dx=8mm,dy=8mm,dz=5mm;

<b>Area Scan</b>	sam_direct_droit2_surf8mm.txt
<b>ZoomScan</b>	5x5x7,dx=8mm dy=8mm dz=5mm,Complete
<b>Phantom</b>	Left head
<b>Device Position</b>	Cheek
<b>Band</b>	WCDMA Band II
<b>Channels</b>	Middle
<b>Signal</b>	CDMA (Crest factor: 1.0)

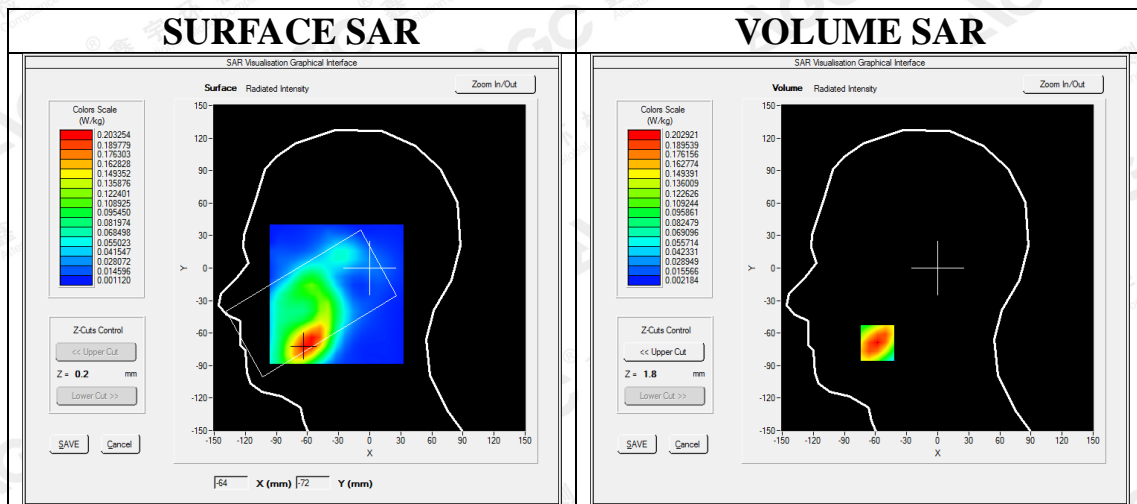

**Maximum location: X=-58.00, Y=-69.00**  
**SAR Peak: 0.30 W/kg**

<b>SAR 10g (W/Kg)</b>	0.112992
<b>SAR 1g (W/Kg)</b>	0.195241

The results shown in this test report refer only to the sample(s) tested unless otherwise stated and the sample(s) are retained for 30 days only. The document is issued by AGC, this document cannot be reproduced except in full with our prior written permission. The more details and the authenticity of the report will be confirmed at <http://www.agc-cert.com>.



Z (mm)	0.00	4.00	9.00	14.00	19.00	24.00	29.00
SAR (W/Kg)	0.3072	0.2029	0.1212	0.0786	0.0496	0.0306	0.0187

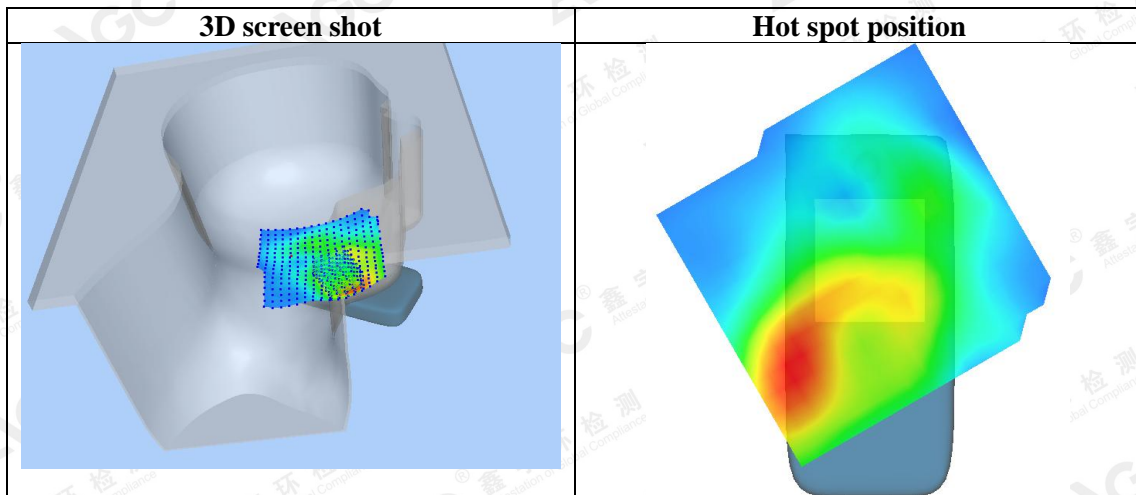
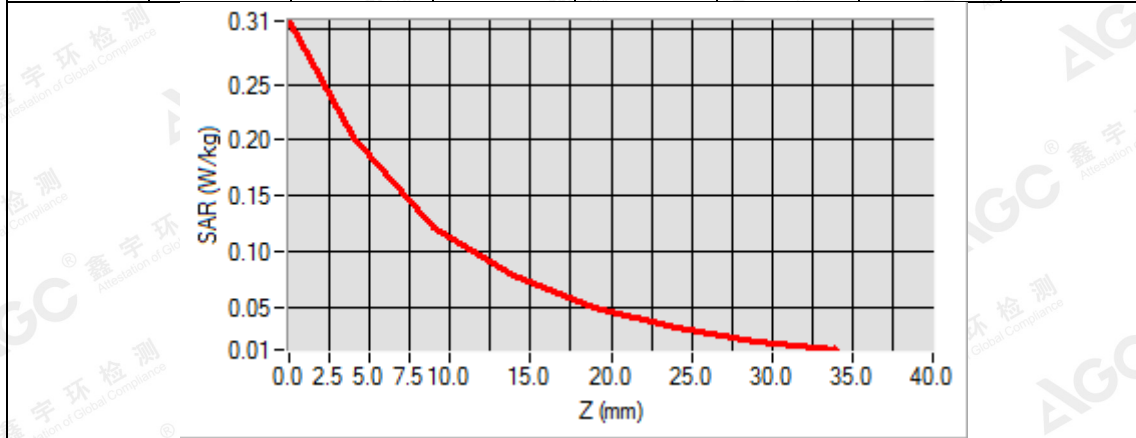

The results shown in this test report refer only to the sample(s) tested otherwise stated and the sample(s) are retained for 30 days only. The document is issued by AGC, this document cannot be reproduced except in full with our prior written permission. The more details and the authenticity of the report will be confirmed at <http://www.agc-cert.com>.

**Test Laboratory: AGC Lab**  
**WCDMA Band II Mid-Body-Towards Grounds (RMC 12.2kbps)**  
**DUT: Smart Phone; Type: R11**

**Date: May. 07,2018**

Communication System: UMTS; Communication System Band: Band II UTRA/FDD ;Duty Cycle:1:1; Conv.F=2.39;  
Frequency: 1880 MHz; Medium parameters used:  $f = 1900$  MHz;  $\sigma = 1.50$  mho/m;  $\epsilon_r = 53.71$ ;  $\rho = 1000$  kg/m<sup>3</sup> ;  
Phantom section: Flat Section  
Ambient temperature (°C): 21.7, Liquid temperature (°C): 21.3

SATIMO Configuration:

- Probe: SSE2; Calibrated: Aug. 08,2017; Serial No.: SN 08/16 EPGO282
- Sensor-Surface: 4mm (Mechanical Surface Detection)
- Phantom: SAM twin phantom
- Measurement SW: OpenSAR V4\_02\_35

**Configuration/ WCDMA band II Mid-Body-back/Area Scan:** Measurement grid: dx=8mm, dy=8mm

**Configuration/ WCDMA band II Mid-Body-back/Zoom Scan:** Measurement grid: dx=8mm,dy=8mm, dz=5mm;

<b>Area Scan</b>	sam_direct_droit2_surf8mm.txt
<b>ZoomScan</b>	5x5x7,dx=8mm dy=8mm dz=5mm,Complete
<b>Phantom</b>	Validation plane
<b>Device Position</b>	Body Back
<b>Band</b>	WCDMA band II
<b>Channels</b>	Middle
<b>Signal</b>	CDMA (Crest factor: 1.0)

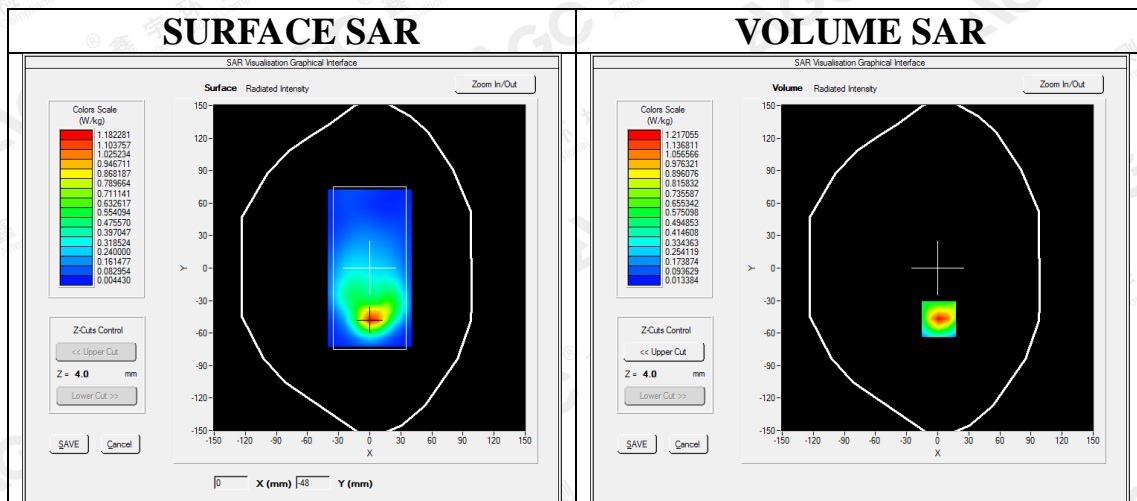

**Maximum location: X=1.00, Y=-47.00**

**SAR Peak: 1.96 W/kg**

<b>SAR 10g (W/Kg)</b>	0.559531
<b>SAR 1g (W/Kg)</b>	1.124875

The results shown in this test report refer only to the sample(s) tested unless otherwise stated and the sample(s) are retained for 30 days only. The document is issued by AGC, this document cannot be reproduced except in full with our prior written permission. The more details and the authenticity of the report will be confirmed at <http://www.agc-cert.com>.



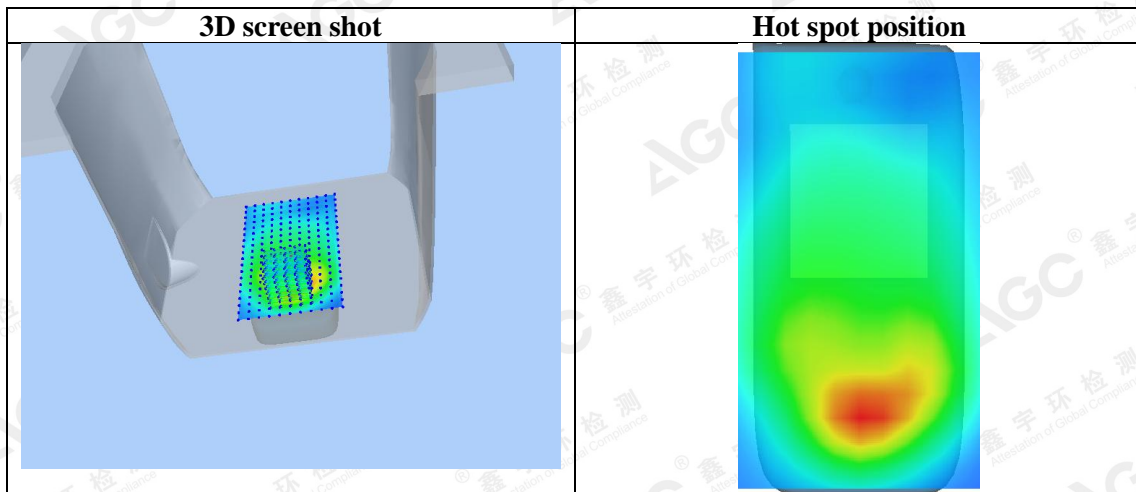
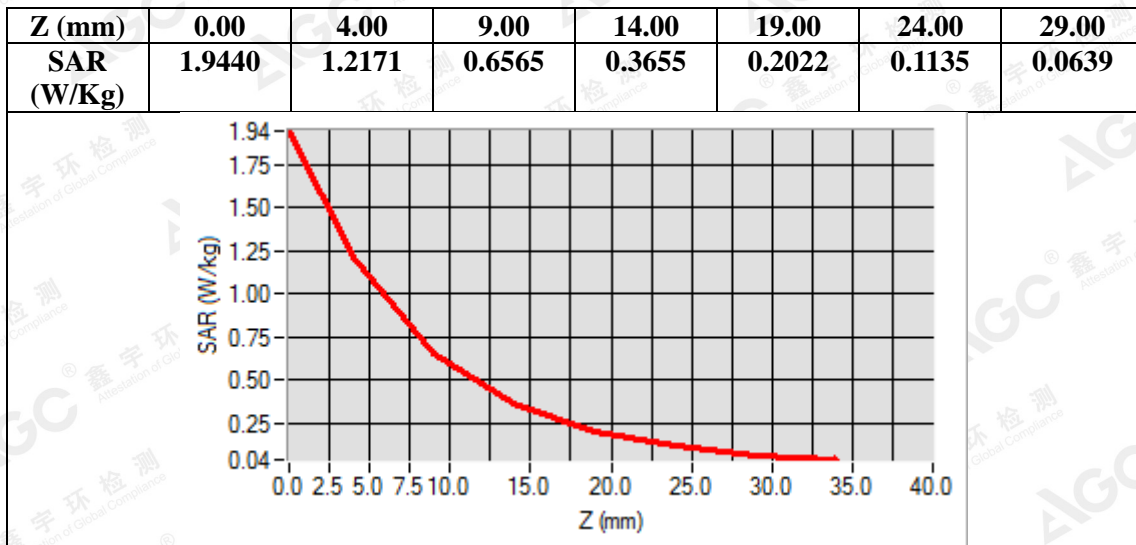

The results shown in this test report refer only to the sample(s) tested otherwise stated and the sample(s) are retained for 30 days only. The document is issued by AGC, this document cannot be reproduced except in full with our prior written permission. The more details and the authenticity of the report will be confirmed at <http://www.agc-cert.com>.

Test Laboratory: AGC Lab

Date: Apr. 28,2018

WCDMA Band V Mid-Touch-Right (RMC)

DUT: Smart Phone; Type: R11

Communication System: UMTS; Communication System Band: BAND V UTRA/FDD ; Duty Cycle:1: 1; Conv.F=1.74;  
Frequency: 836.6 MHz; Medium parameters used: f = 835MHz;  $\sigma=0.91$  mho/m;  $\epsilon_r=41.09$ ;  $\rho=1000$  kg/m<sup>3</sup> ;  
Phantom section: Right Section  
Ambient temperature (°C): 21.7, Liquid temperature (°C): 21.3

SATIMO Configuration:

- Probe: SSE2; Calibrated: Aug. 08,2017; Serial No.: SN 08/16 EPGO282
- Sensor-Surface: 4mm (Mechanical Surface Detection)
- Phantom: SAM twin phantom
- Measurement SW: OpenSAR V4\_02\_35

Configuration/ WCDMA Band V Mid-Touch-Right/Area Scan: Measurement grid: dx=8mm, dy=8mm

Configuration/ WCDMA Band V Mid-Touch-Right/Zoom Scan: Measurement grid: dx=8mm,dy=8mm, dz=5mm;

Area Scan	sam_direct_droit2_surf8mm.txt
ZoomScan	5x5x7,dx=8mm dy=8mm dz=5mm,Complete
Phantom	Right head
Device Position	Cheek
Band	WCDMA Band V
Channels	Middle
Signal	CDMA (Crest factor: 1.0)

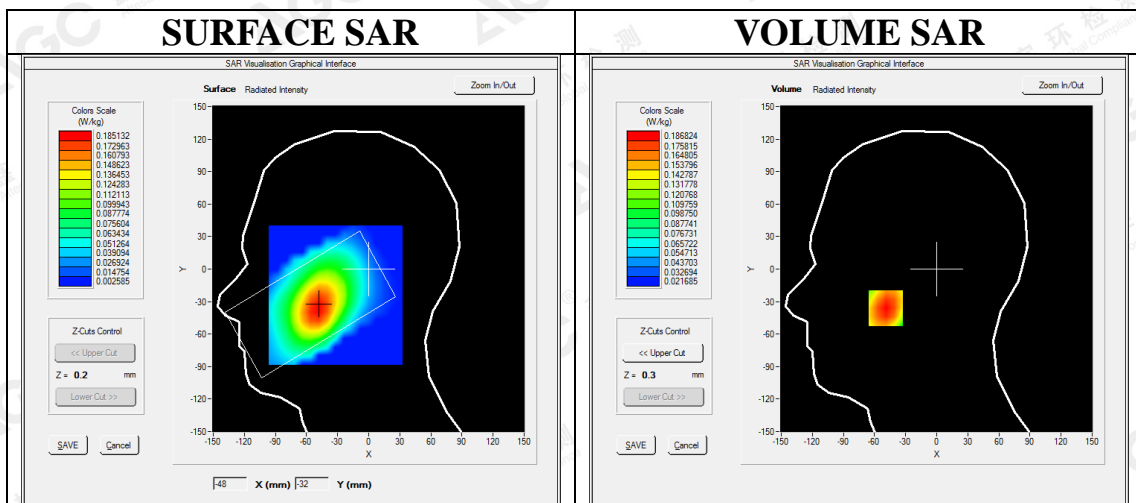

Maximum location: X=-49.00, Y=-36.00

SAR Peak: 0.23 W/kg

SAR 10g (W/Kg)	0.135570
SAR 1g (W/Kg)	0.181093

The results shown in this test report refer only to the sample(s) tested unless otherwise stated and the sample(s) are retained for 30 days only. The document is issued by AGC, this document cannot be reproduced except in full with our prior written permission. The more details and the authenticity of the report will be confirmed at <http://www.agc-cert.com>.



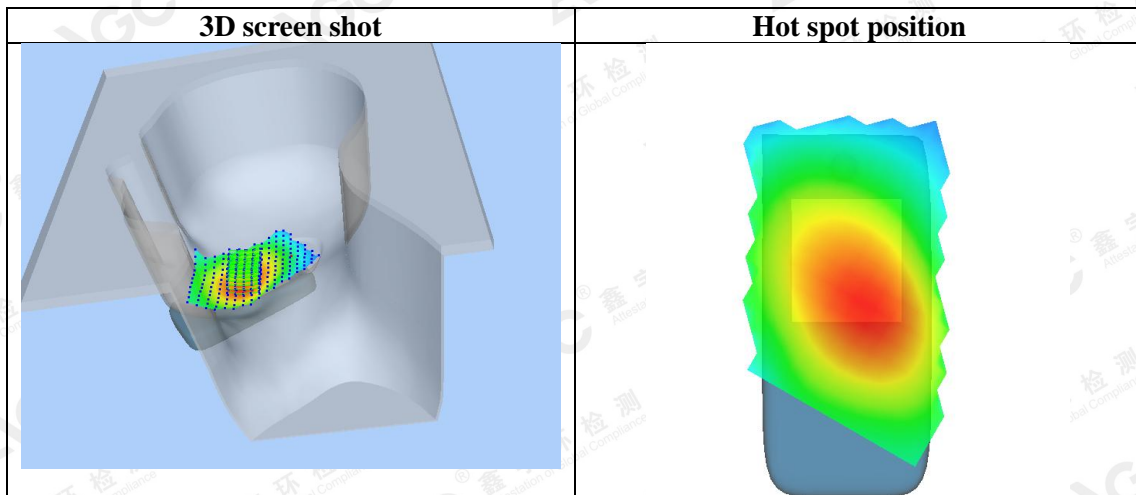
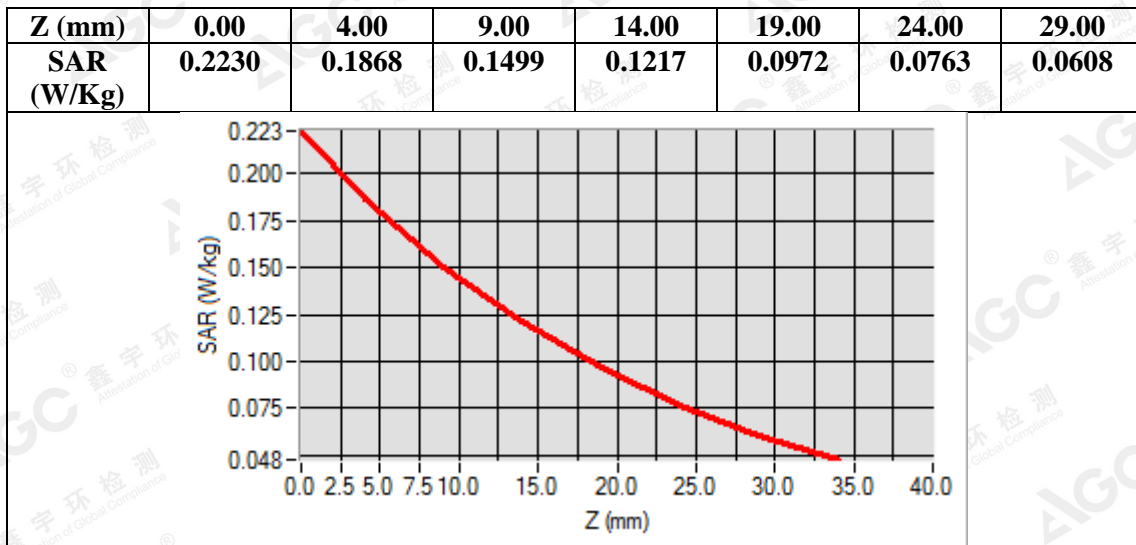

The results shown in this test report refer only to the sample(s) tested unless otherwise stated and the sample(s) are retained for 30 days only. The document is issued by AGC, this document cannot be reproduced except in full with our prior written permission. The more details and the authenticity of the report will be confirmed at <http://www.agc-cert.com>.

Test Laboratory: AGC Lab

Date: Apr. 28,2018

WCDMA Band V Mid-Body-Towards Grounds (RMC)

DUT: Smart Phone; Type: R11

Communication System: UMTS; Communication System Band: BAND V UTRA/FDD; Duty Cycle:1: 1; Conv.F=1.81; Frequency: 836.6 MHz; Medium parameters used:  $f = 835\text{MHz}$ ;  $\sigma = 0.97 \text{ mho/m}$ ;  $\epsilon_r = 54.64$ ;  $\rho = 1000 \text{ kg/m}^3$ ; Phantom section: Flat Section  
Ambient temperature (°C): 21.7, Liquid temperature (°C): 21.4

SATIMO Configuration:

- Probe: SSE2; Calibrated: Aug. 08,2017; Serial No.: SN 08/16 EPGO282
- Sensor-Surface: 4mm (Mechanical Surface Detection)
- Phantom: SAM twin phantom
- Measurement SW: OpenSAR V4\_02\_35

Configuration/ WCDMA Band V Mid-Body-Back/Area Scan: Measurement grid: dx=8mm, dy=8mm

Configuration/ WCDMA Band V Mid-Body-Back/Zoom Scan: Measurement grid: dx=8mm,dy=8mm, dz=5mm;

Area Scan	sam_direct_droit2_surf8mm.txt
ZoomScan	5x5x7,dx=8mm dy=8mm dz=5mm,Complete
Phantom	Validation plane
Device Position	Body Back
Band	WCDMA Band V
Channels	Middle
Signal	CDMA (Crest factor: 1.0)

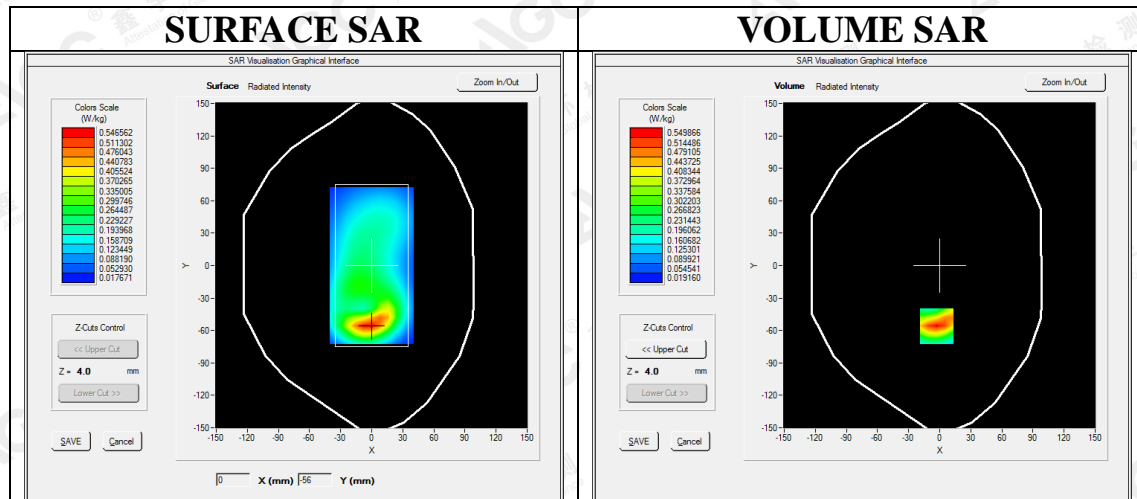

Maximum location: X=-3.00, Y=-56.00  
SAR Peak: 0.86 W/kg

SAR 10g (W/Kg)	0.278118
SAR 1g (W/Kg)	0.515814

The results shown in this test report refer only to the sample(s) tested unless otherwise stated and the sample(s) are retained for 30 days only. The document is issued by AGC, this document cannot be reproduced except in full with our prior written permission. The more details and the authenticity of the report will be confirmed at <http://www.agc-cert.com>.



Z (mm)	0.00	4.00	9.00	14.00	19.00	24.00	29.00
SAR (W/Kg)	0.8661	0.5499	0.3087	0.1846	0.1139	0.0718	0.0461

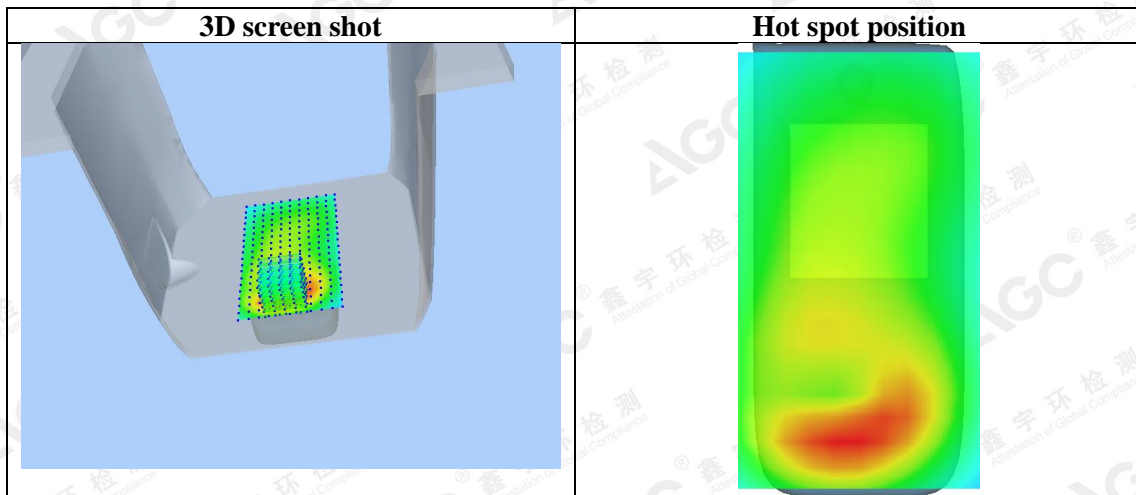
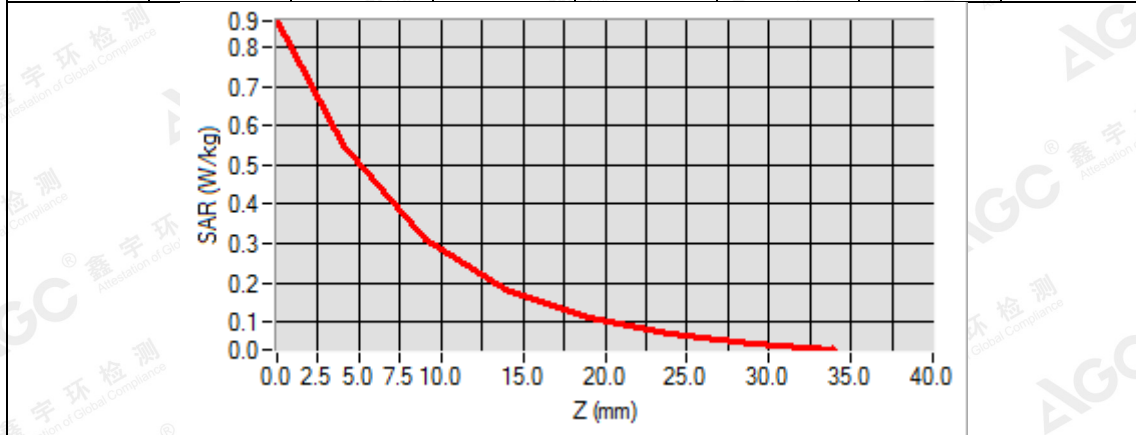

The results shown in this test report refer only to the sample(s) tested unless otherwise stated and the sample(s) are retained for 30 days only. The document is issued by AGC, this document cannot be reproduced except in full with our prior written permission. The more details and the authenticity of the report will be confirmed at <http://www.agc-cert.com>.

**Test Laboratory: AGC Lab**  
**WCDMA Band IV Mid-Touch-Left (RMC)**  
**DUT: Mobile Phone; Type: Platinum 4.0**

**Date: May. 08,2018**

Communication System: UMTS; Communication System Band: BAND IV UTRA/FDD; Duty Cycle:1: 1; Conv.F=2.03;  
Frequency: 1732.5 MHz; Medium parameters used:  $f = 1800\text{MHz}$ ;  $\sigma = 1.35 \text{ mho/m}$ ;  $\epsilon_r = 41.09$ ;  $\rho = 1000 \text{ kg/m}^3$  ;  
Phantom section: Left Section  
Ambient temperature ( $^{\circ}\text{C}$ ): 22.0, Liquid temperature ( $^{\circ}\text{C}$ ): 21.5

**SATIMO Configuration:**

- Probe: SSE2; Calibrated: Aug. 08,2017; Serial No.: SN 08/16 EPGO282
- Sensor-Surface: 4mm (Mechanical Surface Detection)
- Phantom: SAM twin phantom
- Measurement SW: OpenSAR V4\_02\_35

**Configuration/ WCDMA BandIV Mid-Touch-Left/Area Scan:** Measurement grid: dx=8mm, dy=8mm  
**Configuration/ WCDMA BandIV Mid-Touch-Left/Zoom Scan:** Measurement grid: dx=8mm, dy=8mm, dz=5mm

<b>Area Scan</b>	sam_direct_droit2_surf8mm.txt
<b>ZoomScan</b>	5x5x7,dx=8mm dy=8mm dz=5mm,Complete
<b>Phantom</b>	Left head
<b>Device Position</b>	Cheek
<b>Band</b>	WCDMA Band IV
<b>Channels</b>	Middle
<b>Signal</b>	CDMA (Crest factor: 1.0)

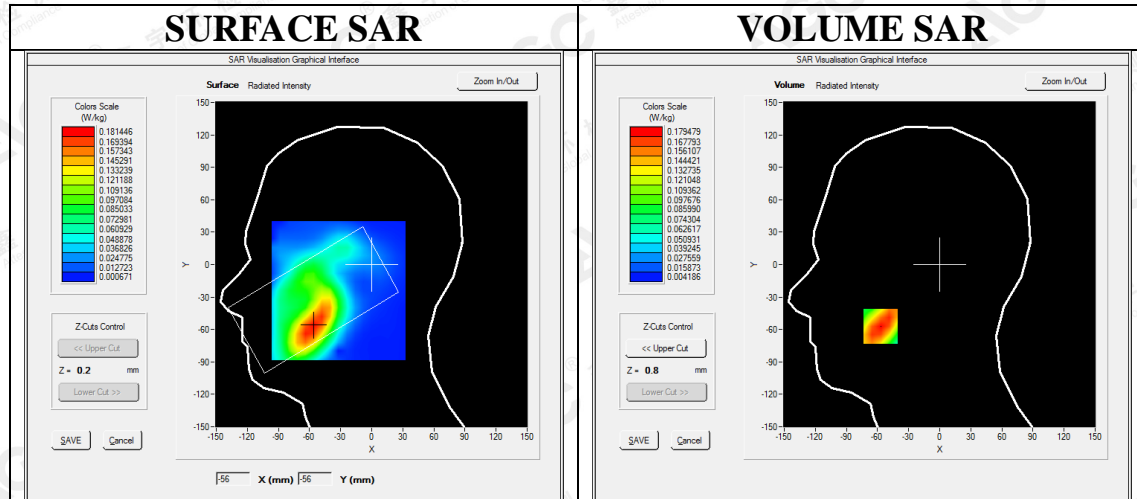

**Maximum location: X=-57.00, Y=-57.00**  
**SAR Peak: 0.26 W/kg**

<b>SAR 10g (W/Kg)</b>	0.102284
<b>SAR 1g (W/Kg)</b>	0.171531

The results shown in this test report refer only to the sample(s) tested unless otherwise stated and the sample(s) are retained for 30 days only. The document is issued by AGC, this document cannot be reproduced except in full with our prior written permission. The more details and the authenticity of the report will be confirmed at <http://www.agc-cert.com>.



Z (mm)	0.00	4.00	9.00	14.00	19.00	24.00	29.00
SAR (W/Kg)	0.2606	0.1795	0.1116	0.0709	0.0447	0.0284	0.0181

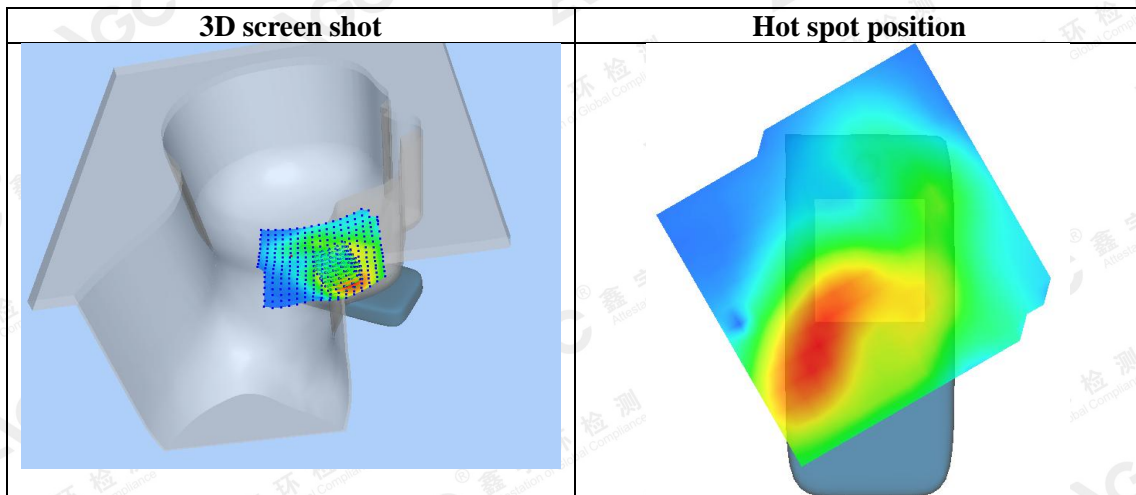
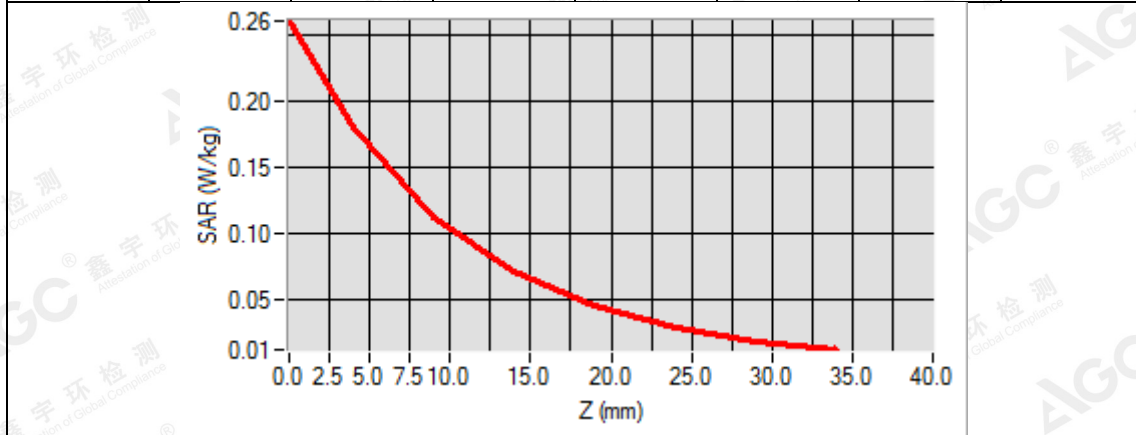

The results shown in this test report refer only to the sample(s) tested otherwise stated and the sample(s) are retained for 30 days only. The document is issued by AGC, this document cannot be reproduced except in full with our prior written permission. The more details and the authenticity of the report will be confirmed at <http://www.agc-cert.com>.

**Test Laboratory: AGC Lab**  
**WCDMA Band IV High-Body- Towards Phantom (RMC)**  
**DUT: Mobile Phone; Type: Platinum 4.0**

**Date: May. 08,2018**

Communication System: UMTS; Communication System Band: BAND IV UTRA/FDD; Duty Cycle: 1: 1; Conv.F=2.07  
Frequency: 1752.5 MHz; Medium parameters used:  $f = 1800\text{MHz}$ ;  $\sigma = 1.48 \text{ mho/m}$ ;  $\epsilon_r = 54.39$ ;  $\rho = 1000 \text{ kg/m}^3$  ;  
Phantom section: Flat Section  
Ambient temperature (°C): 22.0, Liquid temperature (°C): 21.7

- SATIMO Configuration:  
Probe: SSE2; Calibrated: Aug. 08,2017; Serial No.: SN 08/16 EPGO282
- Sensor-Surface: 4mm (Mechanical Surface Detection)
  - Phantom: SAM twin phantom
  - Measurement SW: OpenSAR V4\_02\_35

**Configuration/ WCDMA Band IV High-Body-Front/Area Scan:** Measurement grid: dx=8mm, dy=8mm  
**Configuration/ WCDMA Band IV High-Body-Front/Zoom Scan:** Measurement grid: dx=8mm, dy=8mm, dz=5mm;

<b>Area Scan</b>	sam_direct_droit2_surf8mm.txt
<b>ZoomScan</b>	5x5x7,dx=8mm dy=8mm dz=5mm,Complete
<b>Phantom</b>	Validation plane
<b>Device Position</b>	Body Front
<b>Band</b>	WCDMA Band IV
<b>Channels</b>	High
<b>Signal</b>	CDMA (Crest factor: 1.0)

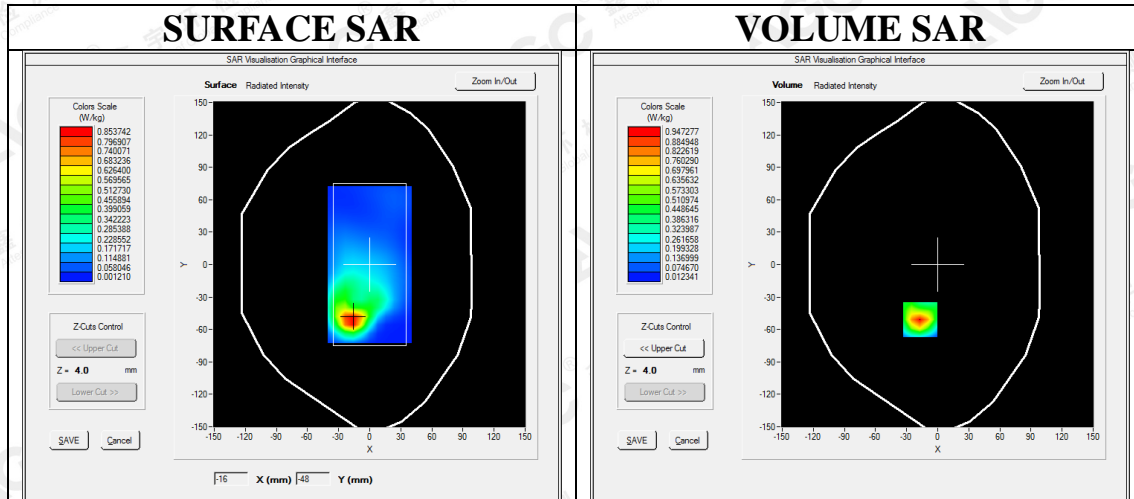

**Maximum location: X=-17.00, Y=-51.00**  
**SAR Peak: 1.50 W/kg**

<b>SAR 10g (W/Kg)</b>	0.422364
<b>SAR 1g (W/Kg)</b>	0.869800

The results shown in this test report refer only to the sample(s) tested unless otherwise stated and the sample(s) are retained for 30 days only. The document is issued by AGC, this document cannot be reproduced except in full with our prior written permission. The more details and the authenticity of the report will be confirmed at <http://www.agc-cert.com>.



Z (mm)	0.00	4.00	9.00	14.00	19.00	24.00	29.00
SAR (W/Kg)	1.4998	0.9473	0.5190	0.2963	0.1673	0.0959	0.0553

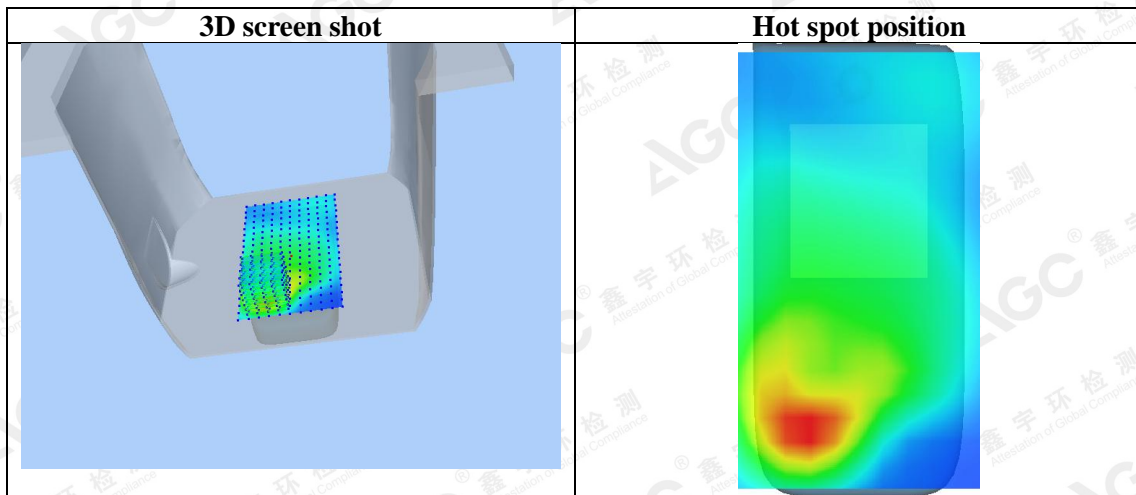
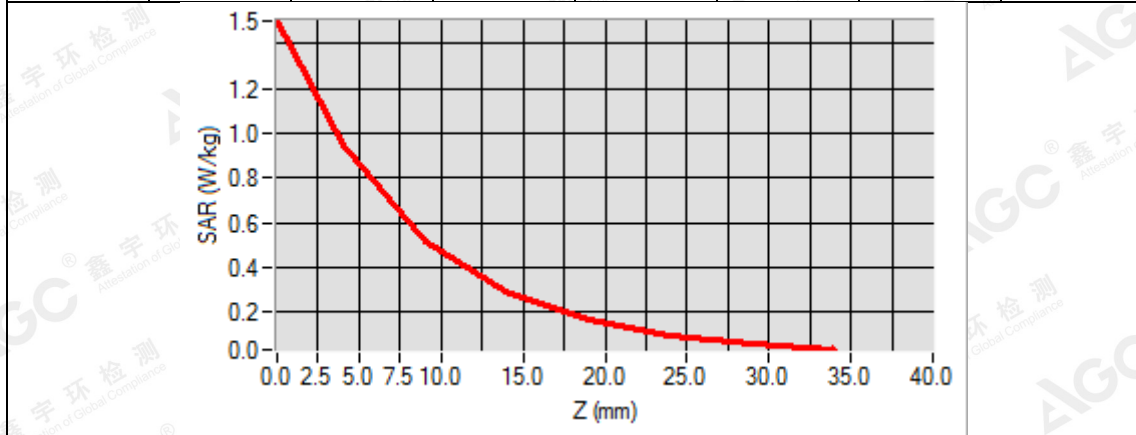

The results shown in this test report refer only to the sample(s) tested unless otherwise stated and the sample(s) are retained for 30 days only. The document is issued by AGC, this document cannot be reproduced except in full with our prior written permission. The more details and the authenticity of the report will be confirmed at <http://www.agc-cert.com>.

**WIFI MODE**

Test Laboratory: AGC Lab

802.11b Mid-Tilt-Right

DUT: Smart Phone; Type: R11

Date: May. 04,2018

Communication System: Wi-Fi; Communication System Band: 802.11b; Duty Cycle: 1:1; Conv.F=2.52;  
Frequency: 2437 MHz; Medium parameters used:  $f = 2450$  MHz;  $\sigma = 1.77$  mho/m;  $\epsilon_r = 40.29$ ;  $\rho = 1000$  kg/m<sup>3</sup> ;  
Phantom section: Right Section  
Ambient temperature (°C):22.2, Liquid temperature (°C): 21.6

SATIMO Configuration:

- Probe: SSE2; Calibrated: Aug. 08,2017; Serial No.: SN 08/16 EPGO282
- Sensor-Surface: 4mm (Mechanical Surface Detection)
- Phantom: SAM twin phantom
- Measurement SW: OpenSAR V4\_02\_35

Configuration/802.11b Mid- Tilt-Right/Area Scan: Measurement grid: dx=8mm, dy=8mm

Configuration/802.11b Mid- Tilt-Right/Zoom Scan: Measurement grid: dx=5mm,dy=5mm, dz=5mm;

Area Scan	sam_direct_droit2_surf8mm.txt
ZoomScan	7x7x7,dx=5mm dy=5mm dz=5mm
Phantom	Right head
Device Position	Tilt
Band	2450MHz
Channels	Middle
Signal	Crest factor: 1.0

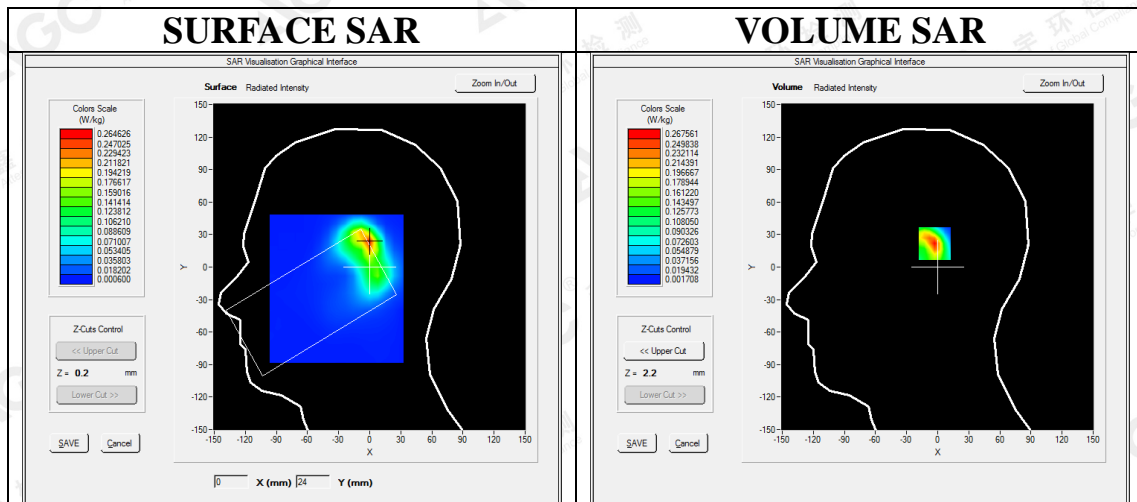

**Maximum location: X=0.00, Y=23.00**

**SAR Peak: 0.43 W/kg**

<b>SAR 10g (W/Kg)</b>	0.107359
<b>SAR 1g (W/Kg)</b>	0.229935

The results shown in this test report refer only to the sample(s) tested unless otherwise stated and the sample(s) are retained for 30 days only. The document is issued by AGC, this document cannot be reproduced except in full with our prior written permission. The more details and the authenticity of the report will be confirmed at <http://www.agc-cert.com>.



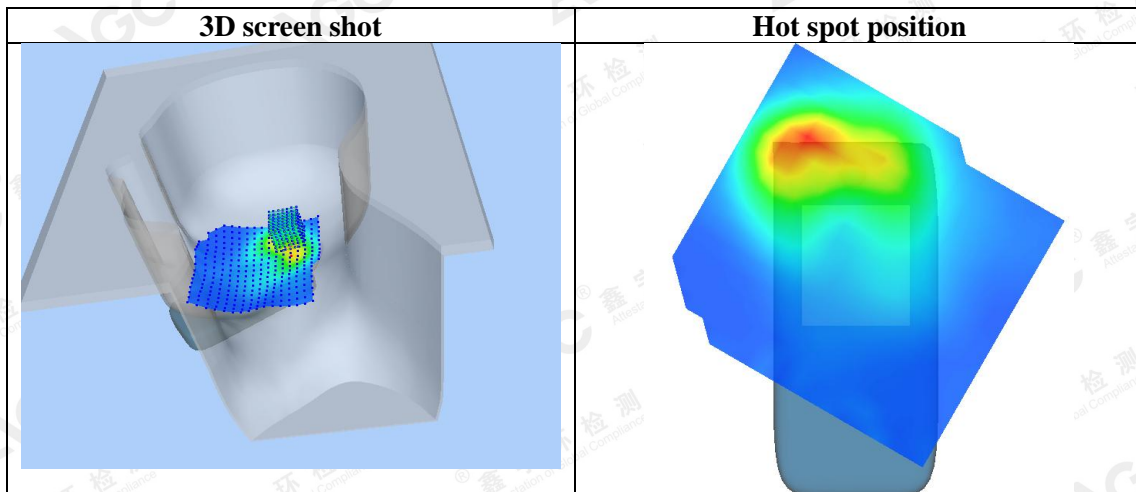
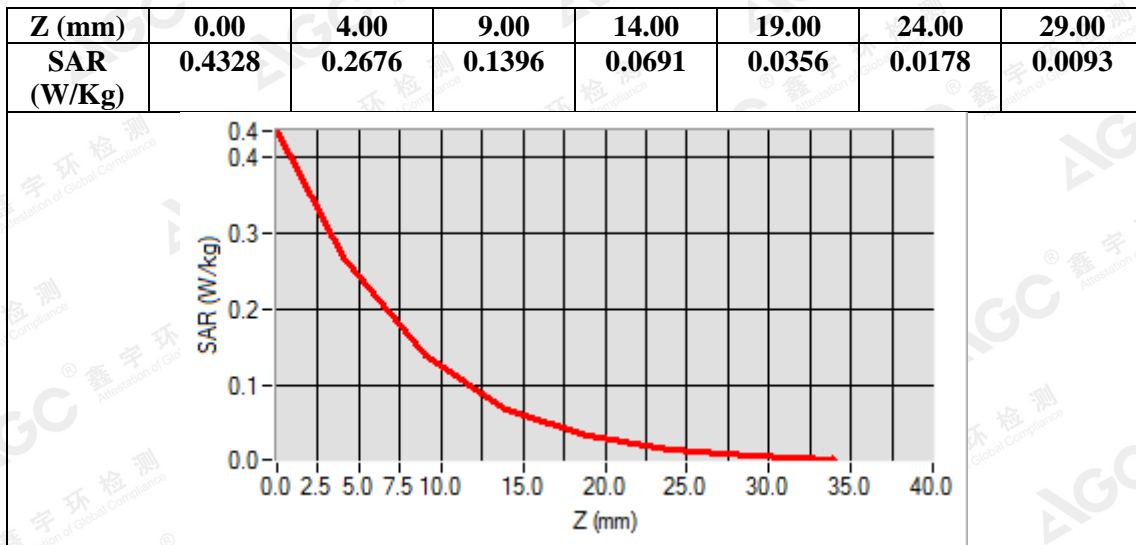

The results shown in this test report refer only to the sample(s) tested unless otherwise stated and the sample(s) are retained for 30 days only. The document is issued by AGC, this document cannot be reproduced except in full with our prior written permission. The more details and the authenticity of the report will be confirmed at <http://www.agc-cert.com>.

**Test Laboratory: AGC Lab**  
**802.11b Mid-Body-Worn- Back (DTS)**  
**DUT: Smart Phone; Type: R11**

**Date: May. 04,2018**

Communication System: Wi-Fi; Communication System Band: 802.11b; Duty Cycle: 1:1; Conv.F=2.58;  
Frequency: 2437 MHz; Medium parameters used:  $f = 2450$  MHz;  $\sigma = 1.90$  mho/m;  $\epsilon_r = 54.16$ ;  $\rho = 1000$  kg/m<sup>3</sup> ;  
Phantom section: Flat Section  
Ambient temperature (°C):22.2, Liquid temperature (°C): 21.8

**SATIMO Configuration:**

- Probe: SSE2; Calibrated: Aug. 08,2017; Serial No.: SN 08/16 EPGO282
- Sensor-Surface: 4mm (Mechanical Surface Detection)
- Phantom: SAM twin phantom
- Measurement SW: OpenSAR V4\_02\_35

**Configuration/802.11b Mid- Body- Back /Area Scan:** Measurement grid: dx=8mm, dy=8mm  
**Configuration/802.11b Mid- Body- Back /Zoom Scan:** Measurement grid: dx=5mm,dy=5mm, dz=5mm;

<b>Area Scan</b>	sam_direct_droit2_surf8mm.txt
<b>ZoomScan</b>	7x7x7,dx=5mm dy=5mm dz=5mm
<b>Phantom</b>	Validation plane
<b>Device Position</b>	Body Back
<b>Band</b>	2450MHz
<b>Channels</b>	Middle
<b>Signal</b>	Crest factor: 1.0

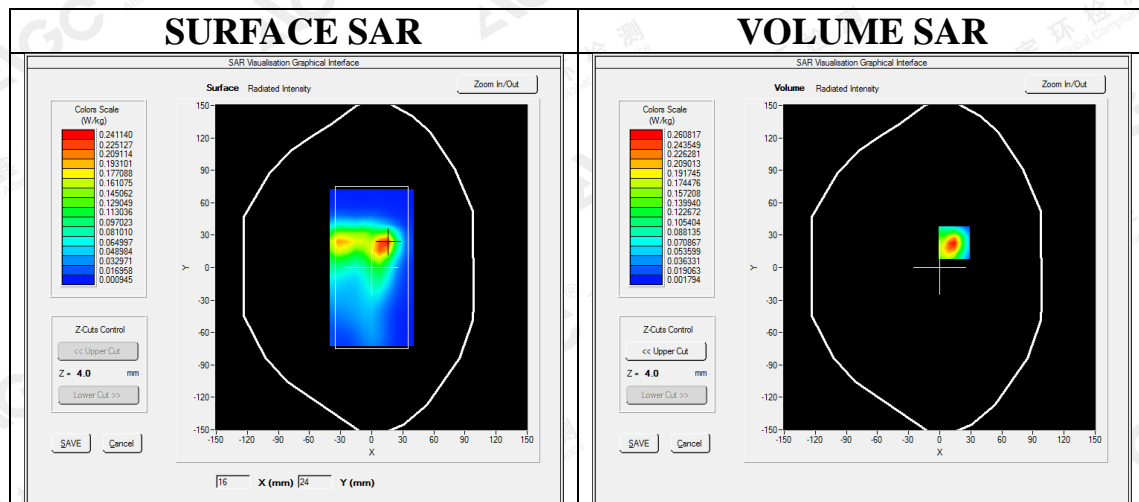

**Maximum location: X=14.00, Y=23.00**  
**SAR Peak: 0.45 W/kg**

<b>SAR 10g (W/Kg)</b>	0.103447
<b>SAR 1g (W/Kg)</b>	0.231265

The results shown in this test report refer only to the sample(s) tested unless otherwise stated and the sample(s) are retained for 30 days only. The document is issued by AGC, this document cannot be reproduced except in full with our prior written permission. The more details and the authenticity of the report will be confirmed at <http://www.agc-cert.com>.



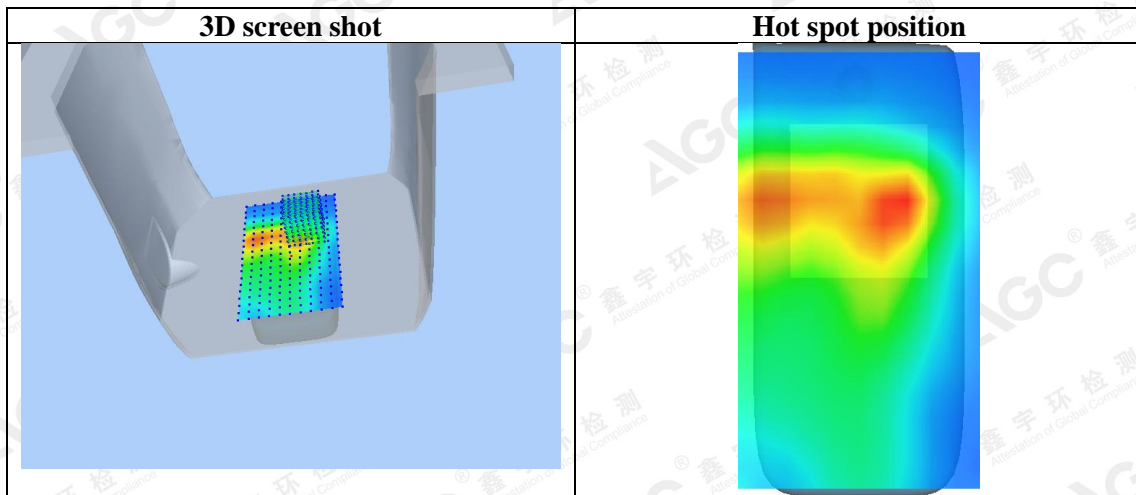
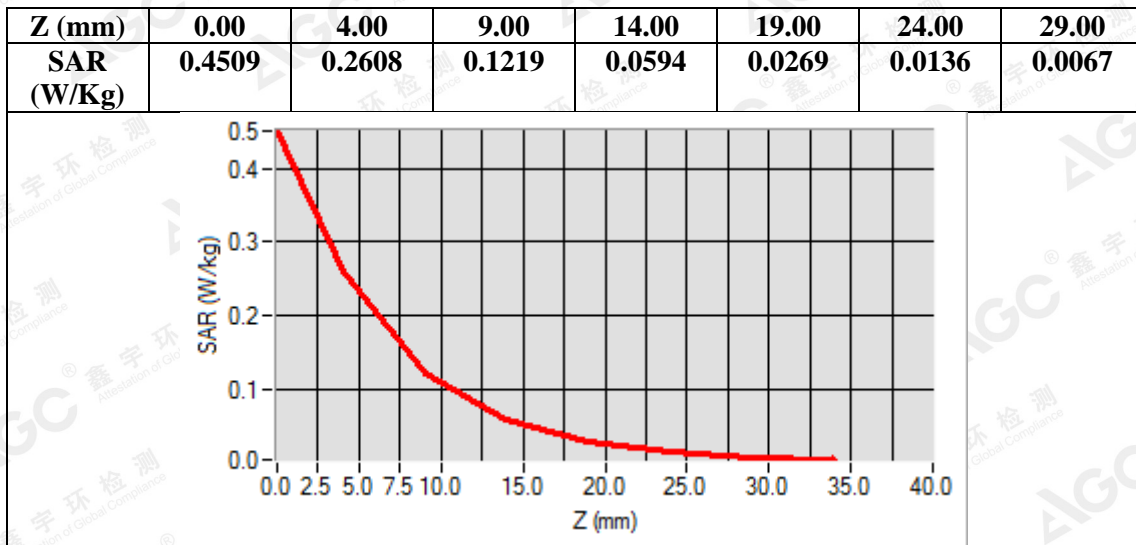

The results shown in this test report refer only to the sample(s) tested unless otherwise stated and the sample(s) are retained for 30 days only. The document is issued by AGC, this document cannot be reproduced except in full with our prior written permission. The more details and the authenticity of the report will be confirmed at <http://www.agc-cert.com>.

**Repeated SAR**

**Test Laboratory:** AGC Lab  
**WCDMA Band II Mid-Body-Towards Grounds (RMC 12.2kbps)**  
**DUT:** Smart Phone; **Type:** R11

**Date:** May. 07,2018

Communication System: UMTS; Communication System Band: Band II UTRA/FDD ;Duty Cycle:1:1; Conv.F=2.39;  
Frequency: 1880 MHz; Medium parameters used: f = 1900 MHz;  $\sigma=1.50$  mho/m;  $\epsilon_r=53.71$ ;  $\rho=1000$  kg/m<sup>3</sup> ;  
Phantom section: Flat Section  
Ambient temperature (°C): 21.7, Liquid temperature (°C): 21.3

**SATIMO Configuration:**

- Probe: SSE2; Calibrated: Aug. 08,2017; Serial No.: SN 08/16 EPGO282
- Sensor-Surface: 4mm (Mechanical Surface Detection)
- Phantom: SAM twin phantom
- Measurement SW: OpenSAR V4\_02\_35

**Configuration/ WCDMA band II Mid-Body-back/Area Scan:** Measurement grid: dx=8mm, dy=8mm

**Configuration/ WCDMA band II Mid-Body-back/Zoom Scan:** Measurement grid: dx=8mm,dy=8mm, dz=5mm;

<b>Area Scan</b>	sam_direct_droit2_surf8mm.txt
<b>ZoomScan</b>	5x5x7,dx=8mm dy=8mm dz=5mm,Complete
<b>Phantom</b>	Validation plane
<b>Device Position</b>	Body Back
<b>Band</b>	WCDMA band II
<b>Channels</b>	Middle
<b>Signal</b>	CDMA (Crest factor: 1.0)

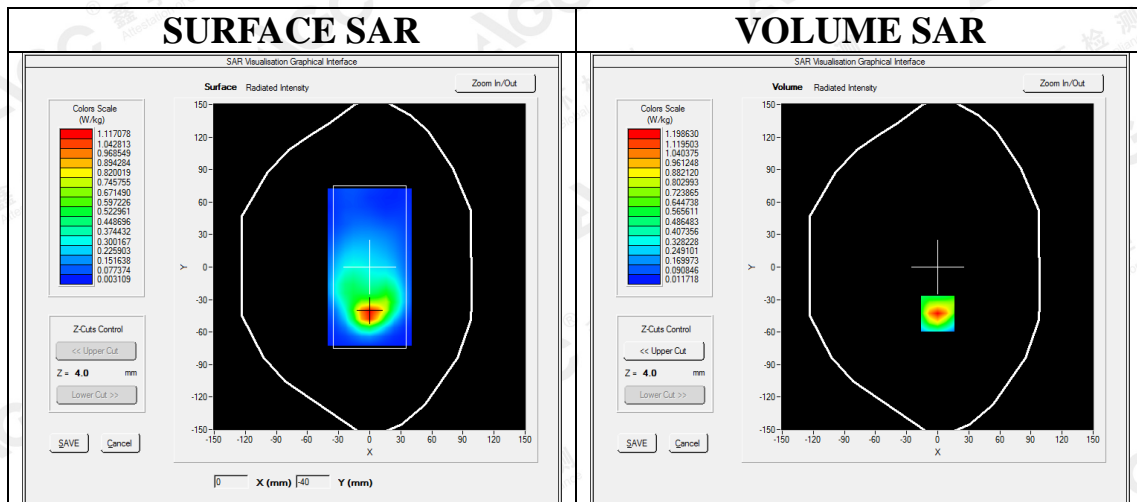

**Maximum location: X=0.00, Y=-43.00**

**SAR Peak: 1.93 W/kg**

<b>SAR 10g (W/Kg)</b>	0.543442
<b>SAR 1g (W/Kg)</b>	1.106173

The results shown in this test report refer only to the sample(s) tested unless otherwise stated and the sample(s) are retained for 30 days only. The document is issued by AGC, this document cannot be reproduced except in full with our prior written permission. The more details and the authenticity of the report will be confirmed at <http://www.agc-cert.com>.



Z (mm)	0.00	4.00	9.00	14.00	19.00	24.00	29.00
SAR (W/Kg)	1.9450	1.1986	0.6315	0.3460	0.1890	0.1053	0.0594

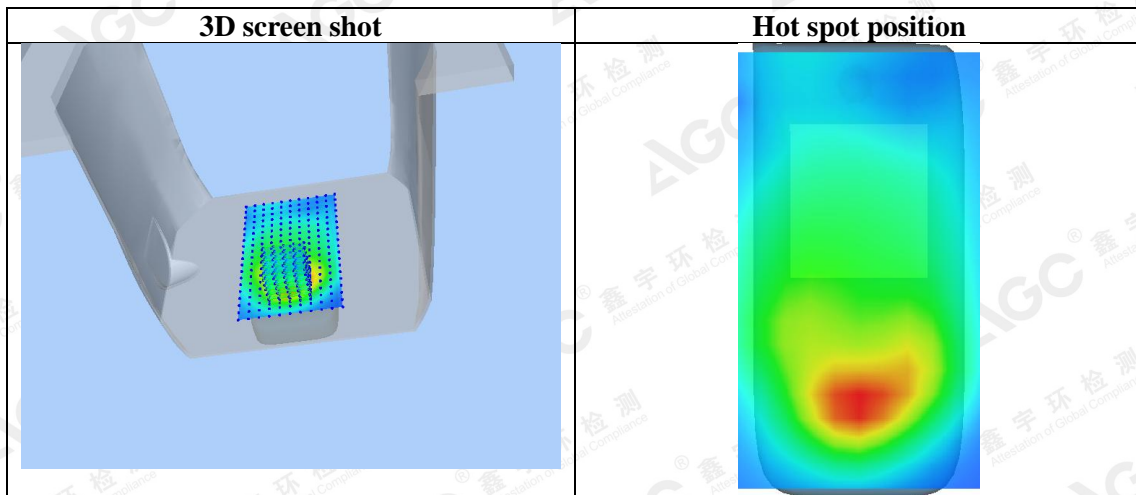
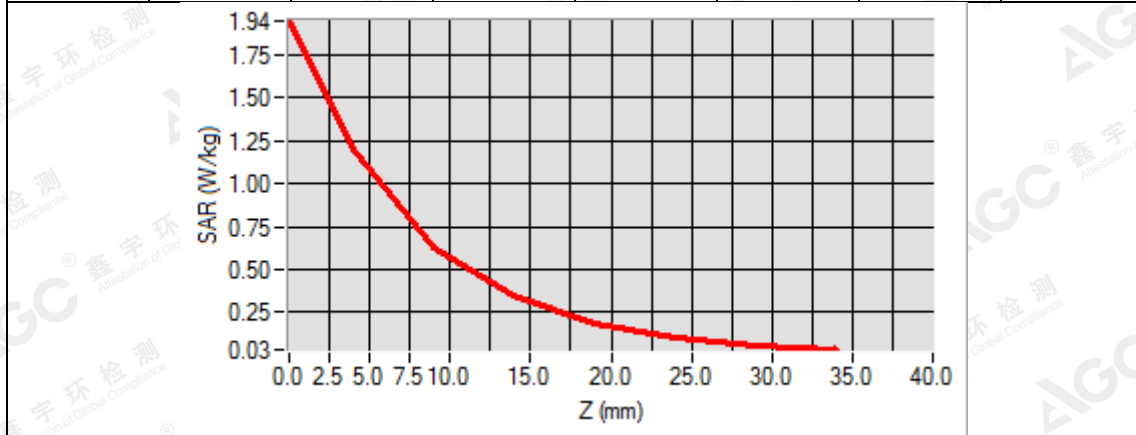

The results shown in this test report refer only to the sample(s) tested otherwise stated and the sample(s) are retained for 30 days only. The document is issued by AGC, this document cannot be reproduced except in full with our prior written permission. The more details and the authenticity of the report will be confirmed at <http://www.agc-cert.com>.

**Test Laboratory: AGC Lab**  
**WCDMA Band IV High-Body- Towards Phantom (RMC)**  
**DUT: Mobile Phone; Type: Platinum 4.0**

**Date: May. 08,2018**

Communication System: UMTS; Communication System Band: BAND IV UTRA/FDD;Duty Cycle:1: 1; Conv.F=2.07  
Frequency: 1752.5 MHz; Medium parameters used:  $f = 1800\text{MHz}$ ;  $\sigma = 1.48 \text{ mho/m}$ ;  $\epsilon_r = 54.39$ ;  $\rho = 1000 \text{ kg/m}^3$  ;  
Phantom section: Flat Section  
Ambient temperature (°C): 22.0, Liquid temperature (°C): 21.7

**SATIMO Configuration:**

- Probe: SSE2; Calibrated: Aug. 08,2017; Serial No.: SN 08/16 EPGO282
- Sensor-Surface: 4mm (Mechanical Surface Detection)
- Phantom: SAM twin phantom
- Measurement SW: OpenSAR V4\_02\_35

**Configuration/ WCDMA Band IV High-Body-Front/Area Scan:** Measurement grid: dx=8mm, dy=8mm  
**Configuration/ WCDMA Band IV High-Body-Front/Zoom Scan:** Measurement grid: dx=8mm,dy=8mm, dz=5mm;

<b>Area Scan</b>	sam_direct_droit2_surf8mm.txt
<b>ZoomScan</b>	5x5x7,dx=8mm dy=8mm dz=5mm,Complete
<b>Phantom</b>	Validation plane
<b>Device Position</b>	Body Front
<b>Band</b>	WCDMA Band IV
<b>Channels</b>	High
<b>Signal</b>	CDMA (Crest factor: 1.0)

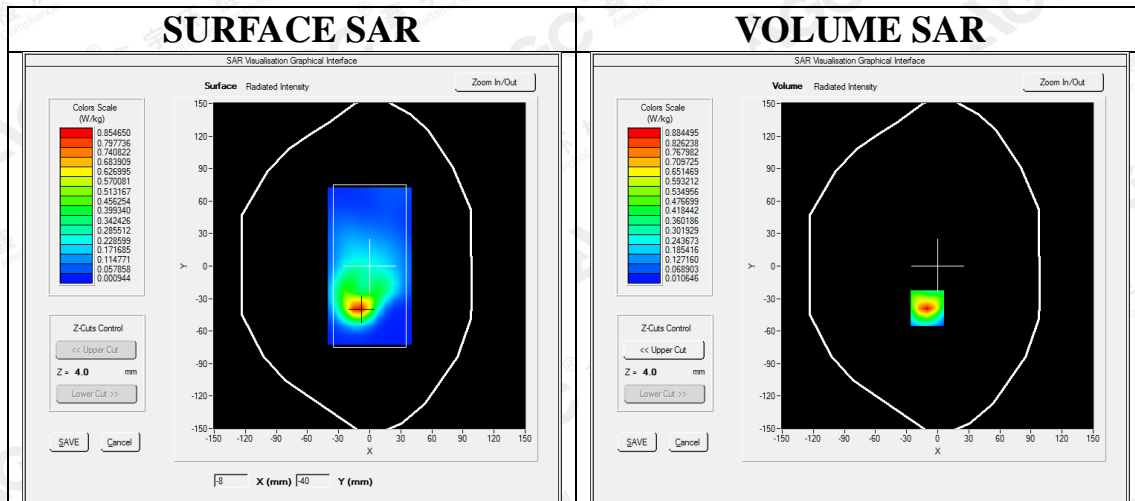

**Maximum location: X=-10.00, Y=-39.00**  
**SAR Peak: 1.39 W/kg**

<b>SAR 10g (W/Kg)</b>	0.397656
<b>SAR 1g (W/Kg)</b>	0.808136

The results shown in this test report refer only to the sample(s) tested unless otherwise stated and the sample(s) are retained for 30 days only. The document is issued by AGC, this document cannot be reproduced except in full with our prior written permission. The more details and the authenticity of the report will be confirmed at <http://www.agc-cert.com>.



Z (mm)	0.00	4.00	9.00	14.00	19.00	24.00	29.00
SAR (W/Kg)	1.3875	0.8845	0.4903	0.2805	0.1588	0.0910	0.0527

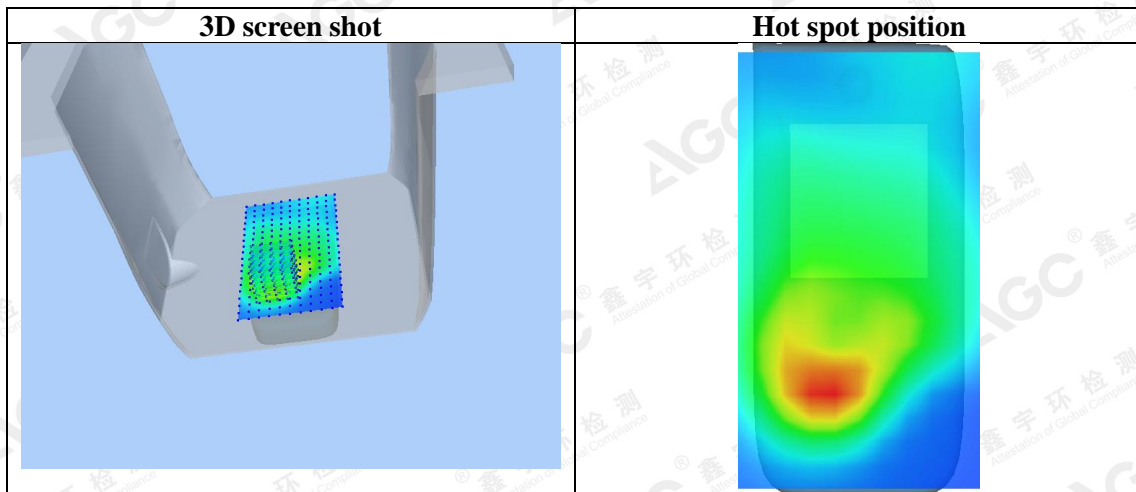
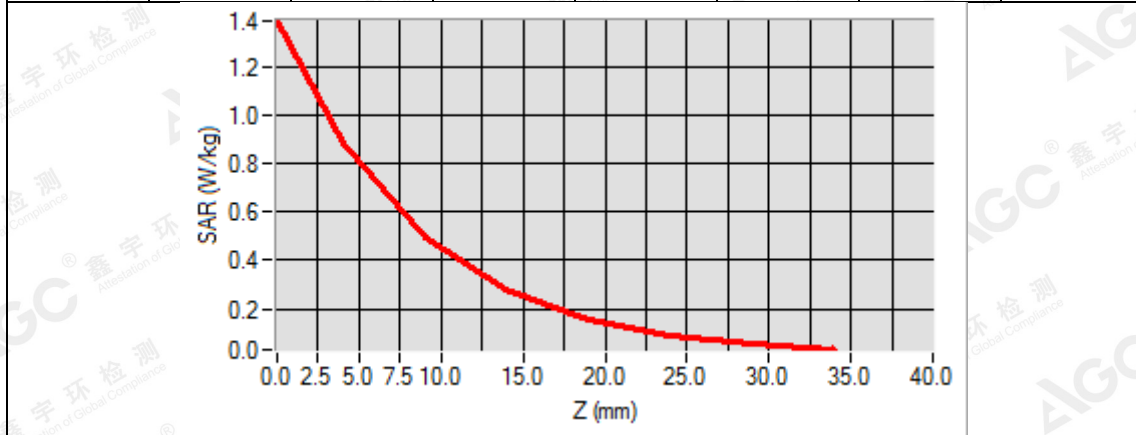

The results shown in this test report refer only to the sample(s) tested unless otherwise stated and the sample(s) are retained for 30 days only. The document is issued by AGC, this document cannot be reproduced except in full with our prior written permission. The more details and the authenticity of the report will be confirmed at <http://www.agc-cert.com>.

**APPENDIX C. TEST SETUP PHOTOGRAPHS**  
LEFT- CHEEK TOUCH

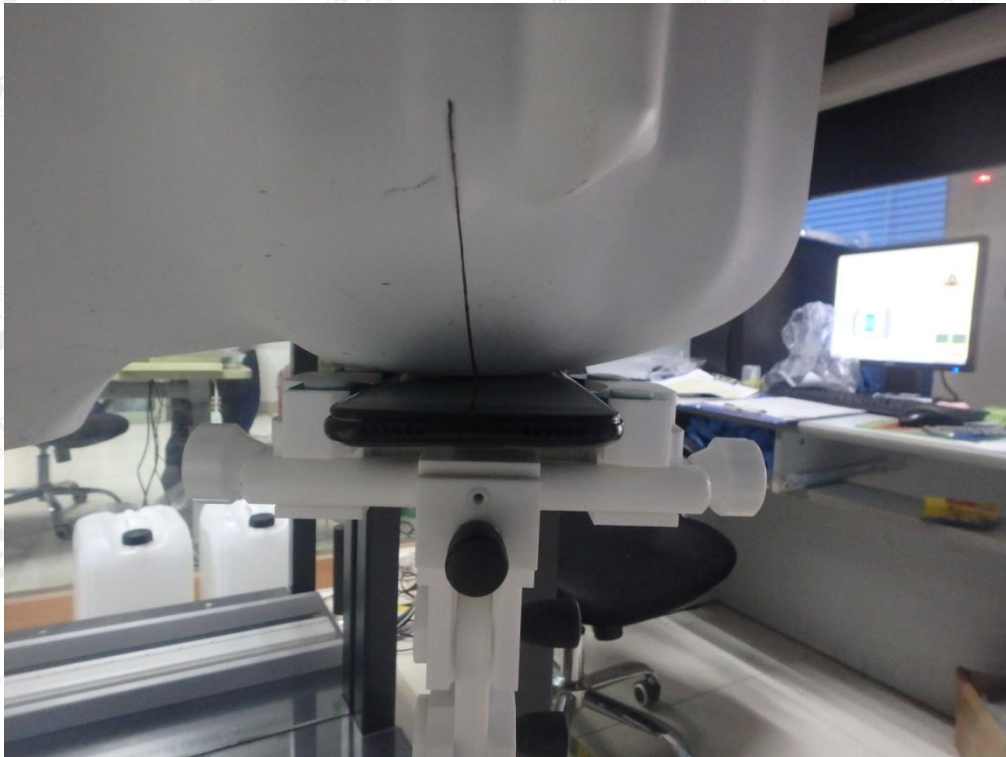

LEFT-TILT 15°

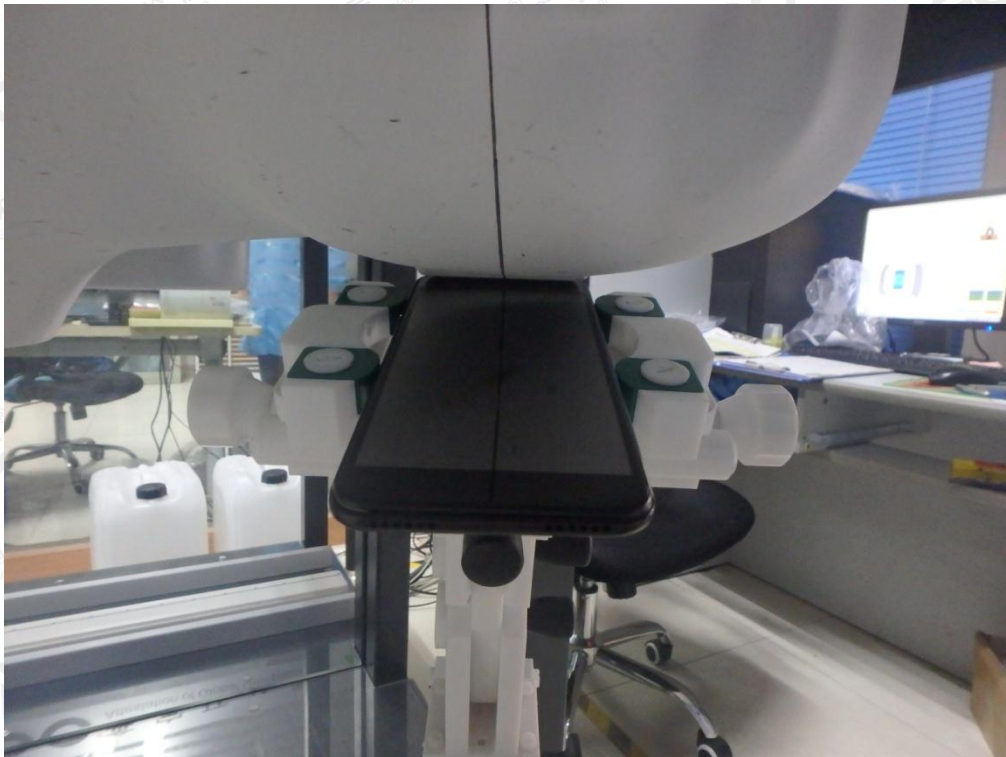

The results shown in this test report refer only to the sample(s) tested unless otherwise stated and the sample(s) are retained for 30 days only. The document is issued by AGC, this document cannot be reproduced except in full with our prior written permission. The more details and the authenticity of the report will be confirmed at <http://www.agc-cert.com>.



RIGHT- CHEEK TOUCH



RIGHT-TILT 15°

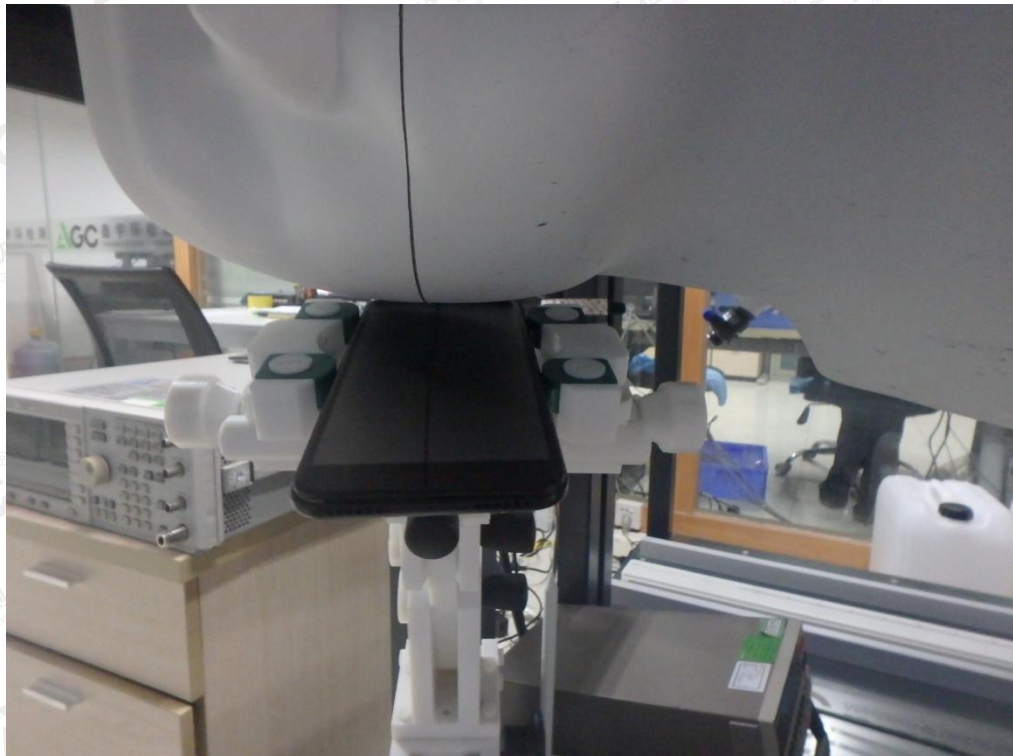

The results shown in this test report refer only to the sample(s) tested unless otherwise stated and the sample(s) are retained for 30 days only. The document is issued by AGC, this document cannot be reproduced except in full with our prior written permission. The more details and the authenticity of the report will be confirmed at <http://www.agc-cert.com>.



Body Back 5mm



Body Front 5mm



The results shown in this test report refer only to the sample(s) tested otherwise stated and the sample(s) are retained for 30 days only. The document is issued by AGC, this document cannot be reproduced except in full with our prior written permission. The more details and the authenticity of the report will be confirmed at <http://www.agc-cert.com>.



Edge 1(Top) 10mm

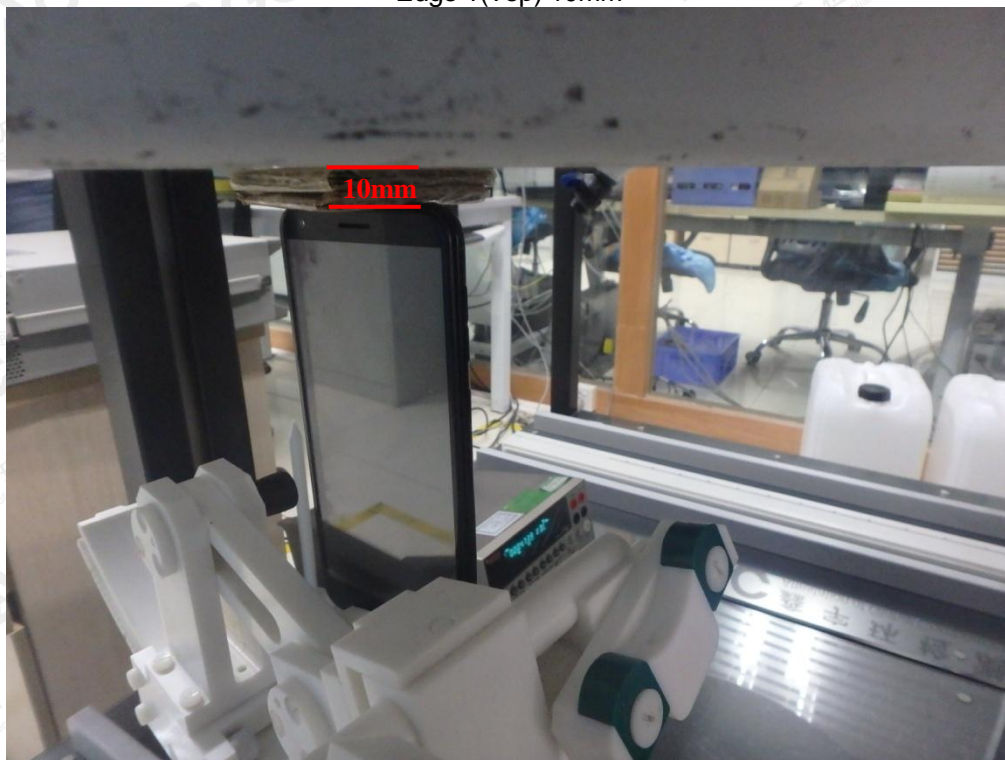

Edge 2(Right) 10mm

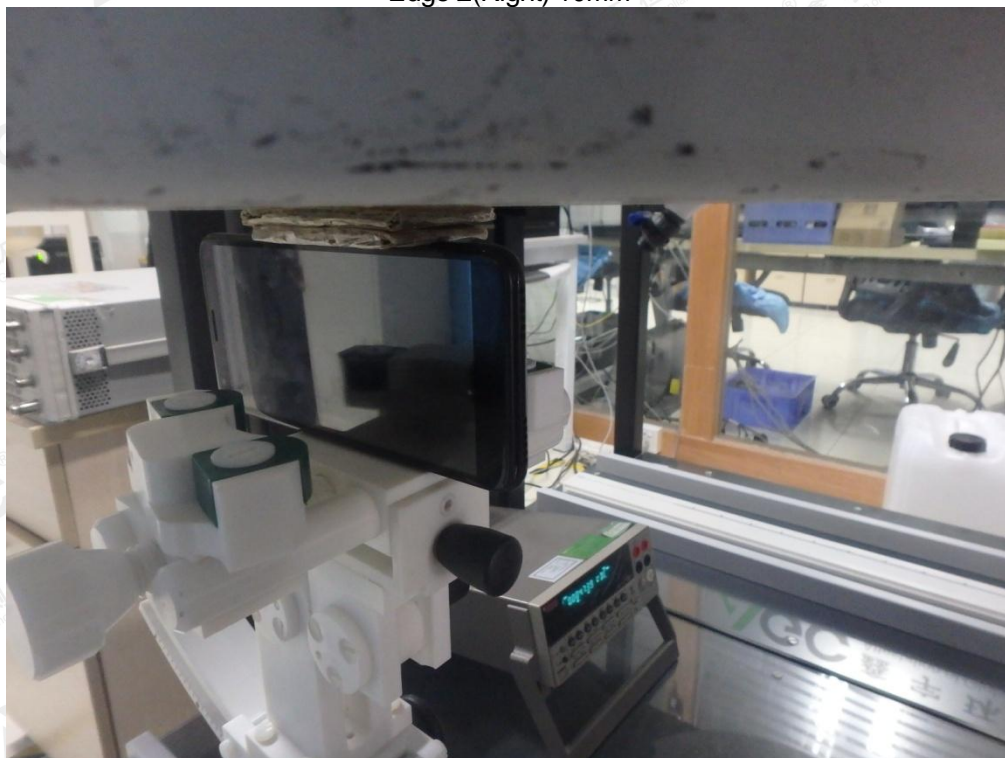

The results shown in this test report refer only to the sample(s) tested otherwise stated and the sample(s) are retained for 30 days only. The document is issued by AGC, this document cannot be reproduced except in full with our prior written permission. The more details and the authenticity of the report will be confirmed at <http://www.agc-cert.com>.



Edge 3(Bottom) 10mm



Edge 4(Left) 10mm

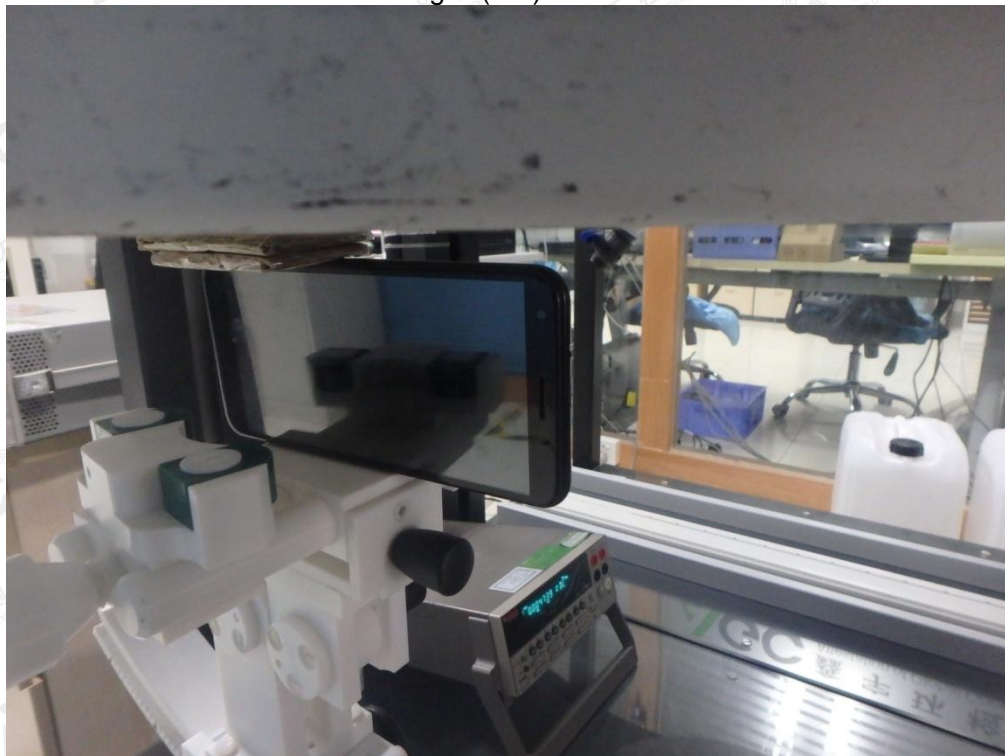

The results shown in this test report refer only to the sample(s) tested otherwise stated and the sample(s) are retained for 30 days only. The document is issued by AGC, this document cannot be reproduced except in full with our prior written permission. The more details and the authenticity of the report will be confirmed at <http://www.agc-cert.com>.



**DEPTH OF THE LIQUID IN THE PHANTOM—ZOOM IN**

Note : The position used in the measurement were according to IEEE 1528-2013

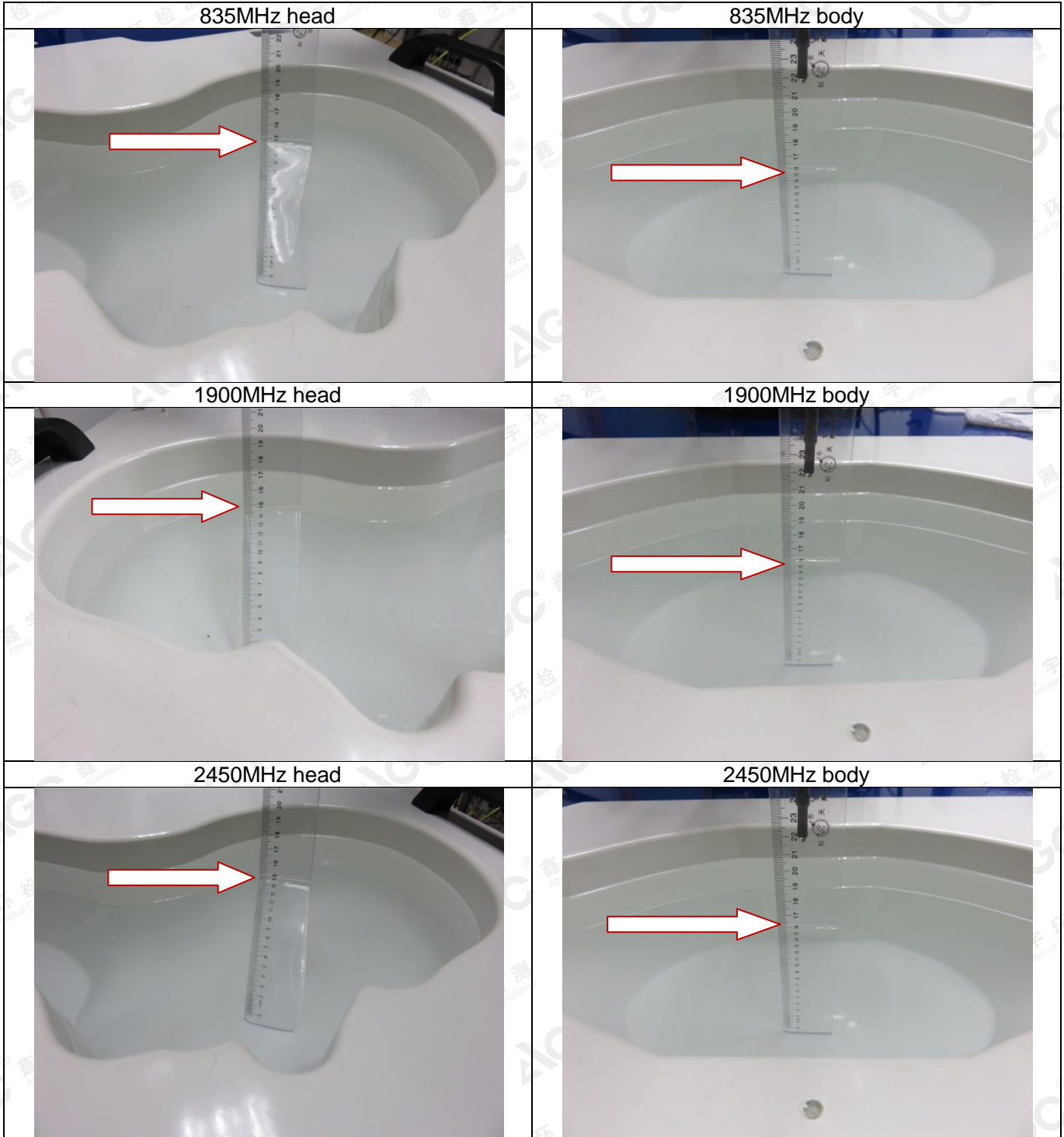

The results shown in this test report refer only to the sample(s) tested unless otherwise stated and the sample(s) are retained for 30 days only. The document is issued by AGC, this document cannot be reproduced except in full with our prior written permission. The more details and the authenticity of the report will be confirmed at <http://www.agc-cert.com>.



The results shown in this test report refer only to the sample(s) tested unless otherwise stated and the sample(s) are retained for 30 days only. The document is issued by AGC, this document cannot be reproduced except in full with our prior written permission. The more details and the authenticity of the report will be confirmed at <http://www.agc-cert.com>.



## APPENDIX D. CALIBRATION DATA

Refer to Attached files.

The results shown in this test report refer only to the sample(s) tested unless otherwise stated and the sample(s) are retained for 30 days only. The document is issued by AGC, this document cannot be reproduced except in full with our prior written permission. The more details and the authenticity of the report will be confirmed at <http://www.agc-cert.com>.