

E-350

User Manual

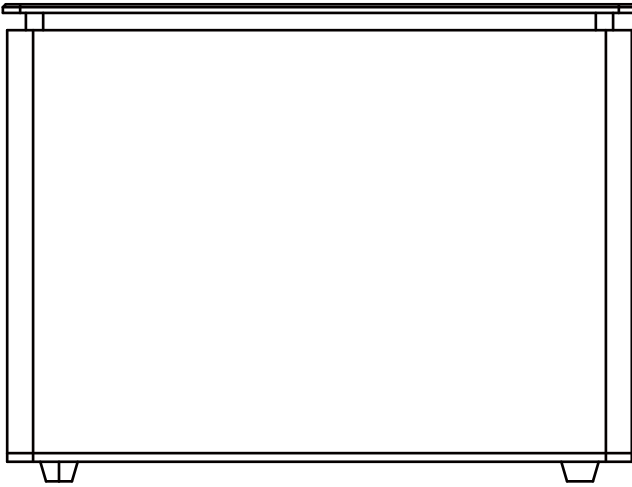

The manual contains the important notes and instructions for use.

Before using the product, please read the book carefully.

Please keep the book safe after reading.

Catalog

- 1. Important information- 2 -
- 2. Packing list.....- 4 -
- 3. Function introduction.....- 4 -
- 4. Troubleshooting Methods- 15 -
- 5. Specification- 16 -

1. Important information

Please read and understand all the instructions before using the product.

Damage caused by failure to comply with the instructions is not covered under warranty.

WARNING

Risk of electric shock or fire

- Do not let the product and accessories contact rain or water. Do not put liquid containers (such as vases) on the product. If liquid flows inside the product, please immediately shut down the product and contact the customer service center.
- Do not place the products and accessories near fire or other heat sources, including direct sunlight.
- In the lightning weather, the product should be shut down.

Beware of short-circuited or fire

- Before the product is connected to a power supply socket, please ensure that the voltage of power supply and products on the back or bottom printing values match. If the voltage is different, do not connect the product to the power socket.

Beware of damage to the product

- Do not put this product places where it can be damaged.
- Upon delivery, if the product is at a temperature that is below 5°C, please open the product packaging and wait for it to reach room temperature. Then connect it to the power socket for charging.
- This part of the product may be made of glass. Please handle with care.

Be careful of overheating

- Do not install the product in enclosed spaces. Be sure to set aside at least 4 inches around the product for ventilation purposes.

Cleaning products

- Only use the micro fiber cleaning cloth to clean the product.

Environmental protection

- The product is made by recyclable and high quality materials. Do not put together the product with other living garbage. Please understand the local classification about collecting electronic, electrical products and battery set. The correct disposal of these products will help to avoid the potentially negative impact on the environment and human health. This product contains a battery that cannot be discarded as the general living garbage. Please understand the local classification about collecting these types of batteries. The correct disposal of the battery helps to avoid the potentially negative impact on the environment and human health.
- Production date:042016 / California 93120 Phase 2 / Compliant for Formaldehyde
Made in China / Manufacturer: QFX Inc / 2957 E. 46th street, Vernon, CA, 90058, USA

Adapter

- Use only power supplies listed in the user instructions: <Input: I/P:AC 100-240V 50-60Hz>, <Output: O/P:DC 15.0V,1200mA >
- Only use the attachments / accessories specified by manufacturer

FCC Statement

- Changes or modifications not expressly approved by the party responsible for compliance could void the user' s authority to operate the equipment.
- This equipment has been tested and found to comply with the limits for a Class B digital device, pursuant to Part 15 of the FCC Rules. These limits are designed to provide reasonable protection against harmful interference in a residential installation. This equipment generates, uses and can radiate radio frequency energy and, if not installed and used in accordance with the instructions, may cause harmful interference to radio communications. However, there is no guarantee that interference will not occur in a particular installation.
- If this equipment does cause harmful interference to radio or television reception, which can be determined by turning the equipment off and on, the user is encouraged to try to correct the interference by one or more of the following measures:
 - Reorient or relocate the receiving antenna.
 - Increase the separation between the equipment and receiver.
 - Connect the equipment into an outlet on a circuit different from that to which the receiver is connected.
 - Consult the dealer or an experienced radio/TV technician for help.

- This equipment complies with FCC RF radiation exposure limits set forth for an uncontrolled environment.
- This equipment should be installed and operated with a minimum distance of 20 centimeters between the radiator and your body.

2. Packing list

- E-350 x 1
- User manual x 1
- 3.5mm audio cable x 1
- Adapter (15V,1. 2A) x 1

3. Function introduction

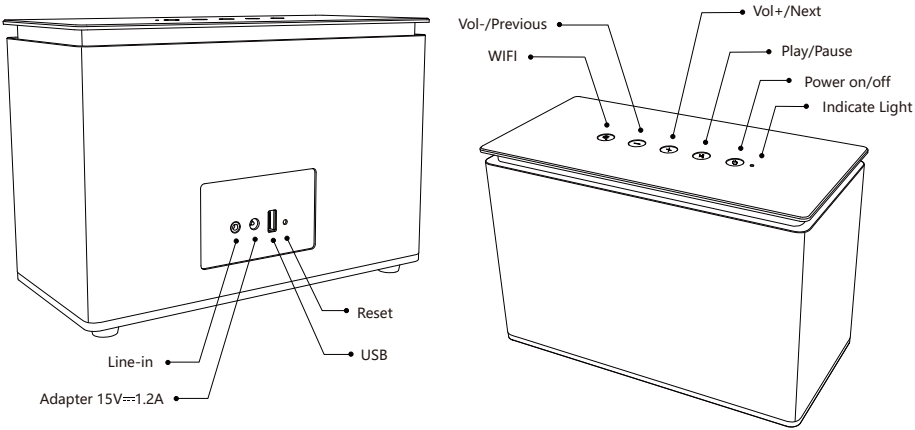

➤ Operations Guide

This product has 5 keys: Power on/off, Play/Pause, Wi-Fi, Vol+/Next and Vol-/Previous. The function of keys:

1. Power on/off: long press for power on/off.
2. Vol+/Next and Vol-/Previous:

State	Long/Short press	Double click
Wi-Fi mode	Vol+,Vol-	Next/Previous
Line-in mode	Vol+,Vol-	NA
Bluetooth mode	Vol+,Vol-	Next/Previous

3. Play/Pause:

State	Short press
Wi-Fi mode & Music playing	Play / Pause
Bluetooth mode & Music playing	Play / Pause
Line-in mode& Music playing	Mute

4. Wi-Fi:

State	Long press
Wi-Fi mode	Connect the slave speaker to main speaker
Bluetooth mode	Disconnect Bluetooth
State	Short press
Any mode	Switch to other mode

Wi-Fi speaker web setting

1. When you turn on the speaker, WiFi will automatically start.
2. After PC or smart phone connects E-350 through Wi-Fi (The default SSID is E-350_XXXX, XXXX and is a random number). Customer could access the site: <http://10.10.10.254> and enter the setting page. There are two tabs: Wi-Fi and Setting.
3. Wi-Fi tab: To setup the connection between Wi-Fi speaker and AP. Customers could use PC or smart phone to access internet through Wi-Fi speaker after connected.

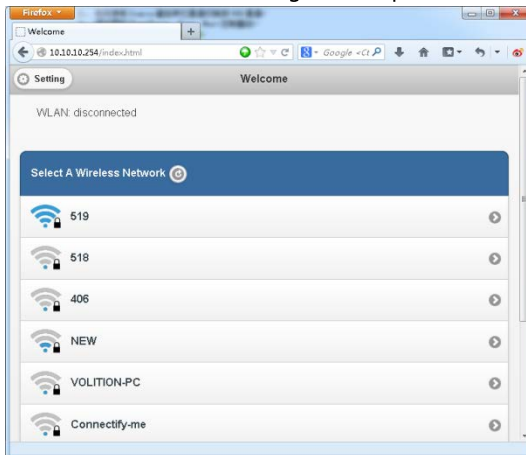

4. Setting Tab:

There are 3 sub tabs in setting tab: Status, System and Network.

- (1) **Status Tab:** Customer could view the firmware version, UUID of Wi-Fi speaker.



(2) **System Tab:** Customer could reset the Wi-Fi speaker and local upgrade firmware in “Other” option and online upgrade firmware in “Firmware Online Upgrade” .

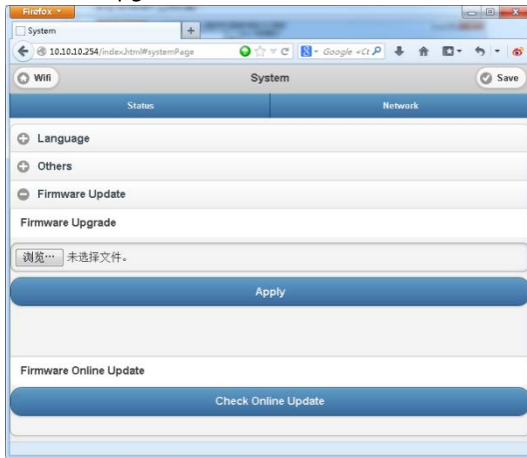

(3) **Network tab:** Customer could set the SSID, password and encryption type of Wi-Fi speaker.

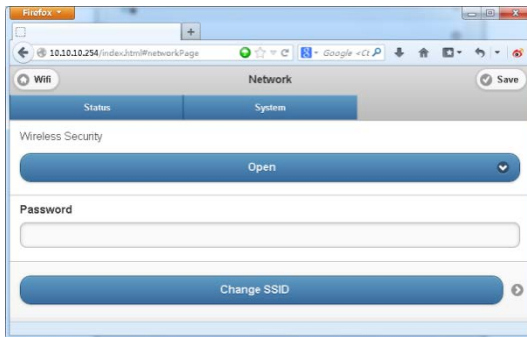

➤ **Music Playing**

1. Wi-Fi Mode:

Customer could use APP to search **E-350** and add it to the management list, then play the music that they want. If Customer wants two speakers to play the same music at the same time then enter **(Multi-Room mode)**, Please carry out the corresponding operation according to the APP. Customer could automatically install the APP by Android Market or App Store. In the Android Market or App Store search "**QFXTunes**", download and complete the installation.

2. Bluetooth Mode:

(1) First power on, press the "Wi-Fi" to Bluetooth mode , Wi-Fi pairing key flashes (with waiting for connection tone), please search for Bluetooth devices "**E-350**" in your mobile phone or Tablet PC and pair. When the pairing is successful, the key keeps on lighting.

(2) If you need to switch to another Bluetooth terminal, long press the Bluetooth pairing key, the blue indicator light flashes, once again into the Bluetooth pairing state, repeat steps (1).

(3) If the Bluetooth terminal is successful paired before shutdown, the machine will automatically connect to the last successful paired terminal after next boot (do not need reconnection). The blue indicator light does not flash.

3. Line-in Mode:

When 3.5mm audio cable is inserted into the Line-in port, machine automatically switches to Line-in mode.

4. USB Charging Mode:

Press the "Wi-Fi" to USB charging mode and it will charge your mobile phone or other electronic devices.

- **If there is no signal input, such as pause playback, the product will be in standby mode for 15 minutes**
- **The speaker use the communication protocol is 802.11b / g / n**
- **The power of networked standby mode is 2.4W.**
- **Clear WiFi preset password, followed by five combinations of buttons: Play, Vol+, Power, Play, Power**

➤ Connecting

1. Brief Introduction

- (1) Open the app.
- (2) Click the Icon 'Add Device', select the WIFI channel.
- (3) Press the speaker "WIFI" button until the blue light flashes quickly.
- (4) Click continue, click the link after entering the router password, wait to add equipment.

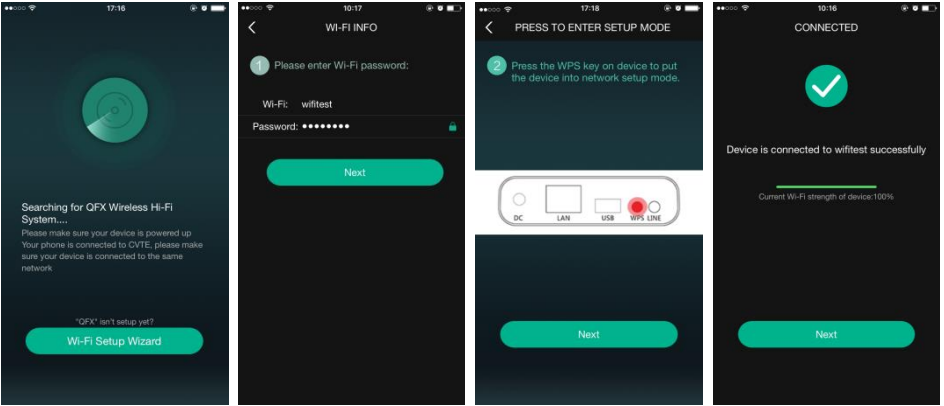

2. Adding a device connected to the Router

Open the app again, it will find all devices connected

3. How to add other non-connected devices

Connected other devices to a wireless network, please follow these step :

Step 1: Click the icon '+' on the Device list.

Step 2: Then add a device as the first time add same device.

Step 3: After the addition, you can see the newly added device appears in the device list, as shown:

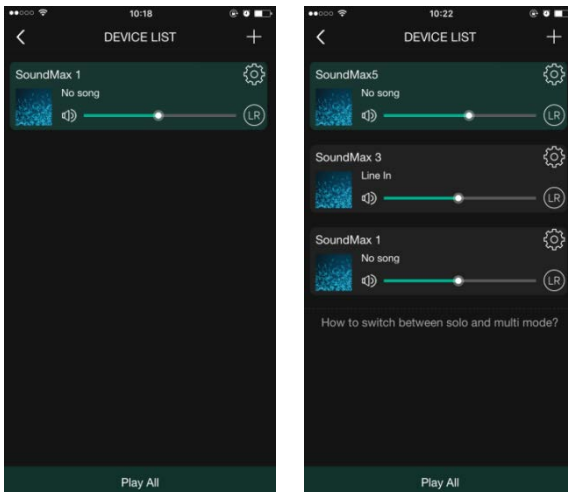

4. Renaming Devices

After adding a device, the device name can be changed according to your needs. Step as shown:

- (1) Click the **"Settings"** button in the interface of device lists.
- (2) Renaming the device : Customizing or choosing the recommended name.

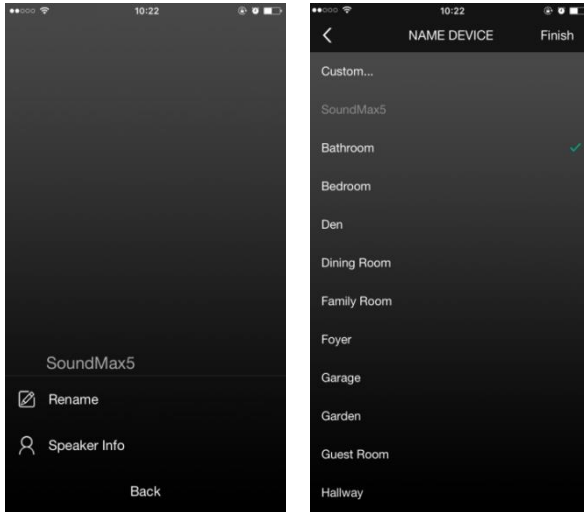

➤ APP functions

1. Search function

With the search function you can search for music according to your needs, either on artist or on song.

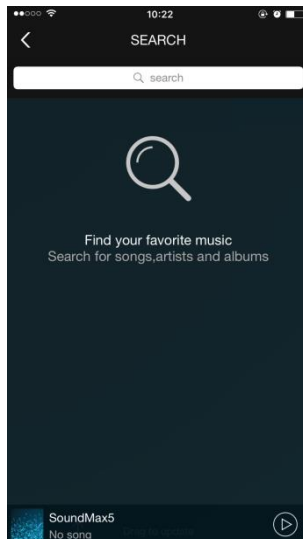

2. My favorite Function

Collect your favorite songs function that allows you to choose your favorite songs.

Step 1: Click on the heart- shaped icon on the player interface, the song can be bookmarked in " my favorite" list;

Step 2: Click go to my favorite list in the control interface and there you can see your collection of songs.

2.1: Managing Favorite Song list

Step 1: Click on the song name on the right.

Step 2: You can choose to delete the song or add to another playlist selected from " my favorites" list.

3.1: My Music - Local Music

Step 1: Click on the phone to enter the local music playlists;

Step 2: Click the icon ,which is in the upper right corner to refresh and search new songs for to add to the local playlists;

Step 3: Click the icon to the right of the song name. You can operate the songs, " Add to Favorites" , " Add to list" and so on.

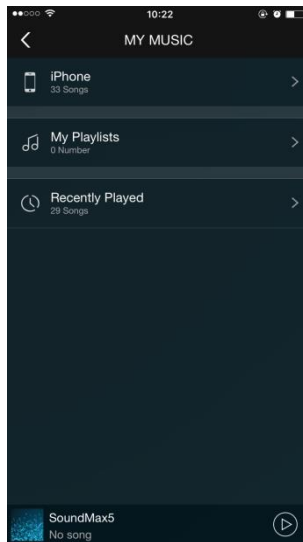

3.2: My Music Playlist

Step 1: You can create a new list: click on the " + " in my music playlist;

Step 2: After entering a name click "OK" to create a new song list.

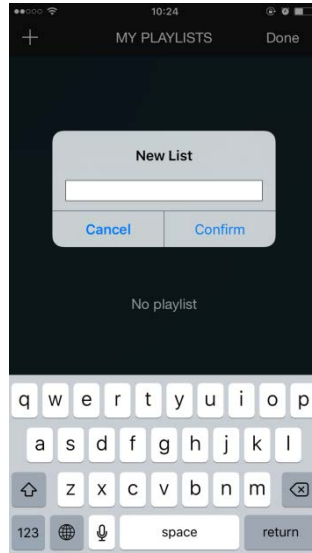
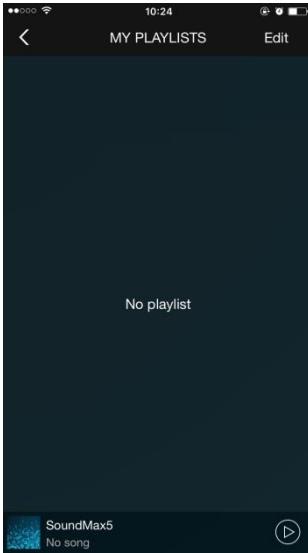

4. Online Radio Station (Tune-In)

Online radio (Tune-In) provides you millions of radio stations from around the world.

(1) Click " Tune-In" to enter the user interface.

(2) Choose the radio station you want to listen to in the list.

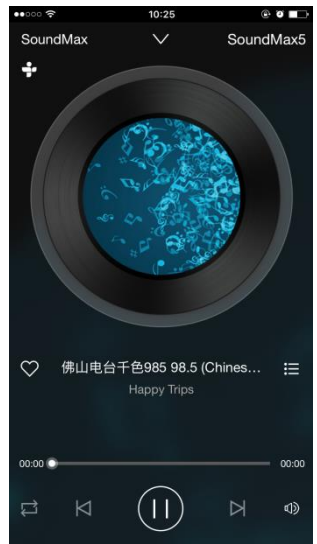
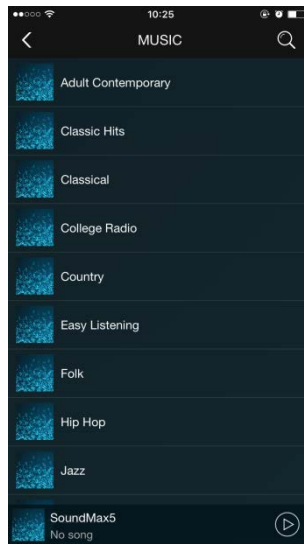
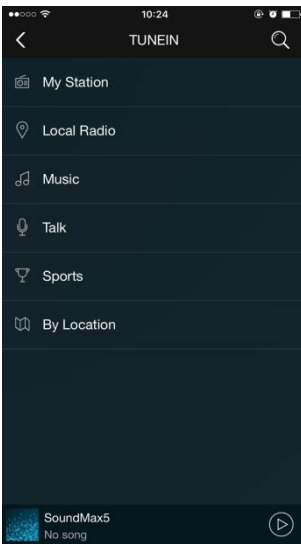

5: iHeartRadio

iHeartRadio, which is integrated in the app, is a digital broadcast & audio streaming media player that is free to use all over the world. It includes millions of online radio stations and you can also create personalized radio stations.



6. Spotify

A better way to listen at home - Spotify Connect lets you play Spotify through your home speakers or TV, using the Spotify app as a remote. You'll need a Spotify Premium account to use Spotify Connect. If you don't have it, just go to <http://www.spotify.com/freetrial> for your free 30-day trial.

Step 1: Connect your device to the same wi-fi network as your phone, tablet or PC running the Spotify app.

Step 2: Open the Spotify app, and play any song.

Step 3: Tap the "song image" in the bottom left of the screen.

Step 4: Tap the "Connect" icon

Step 5. Pick your device from the list.

For more information on how to set up and use Spotify Connect please visit

www.spotify.com/connect.

7. Synchronization & separate play

The E-350 can play music in two or more speakers at the same time. Slide to the left and enter the device list, you can control all the devices, such as increase/decrease the volume, select songs, sound way, etc.

In the device list, you click on the text "How to switch between solo and Multi mode" to know more about the function of the multi-room function.



How to update firmware WiFi

Online update :

1. Turn on the speaker, change it into wifi mode, after it prompts wifi network ready voice, use PC to connect the wifi signal of speaker.
2. Enter "10.10.10.254" in the browser of PC.
3. Connected network

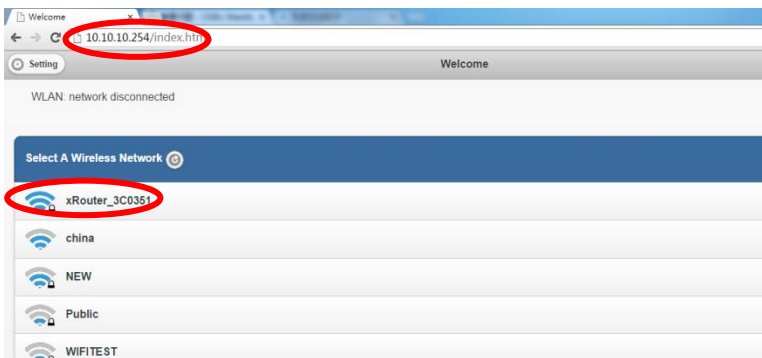

4. Then select "Setting"
5. lick "System"
6. Click "Online Update"

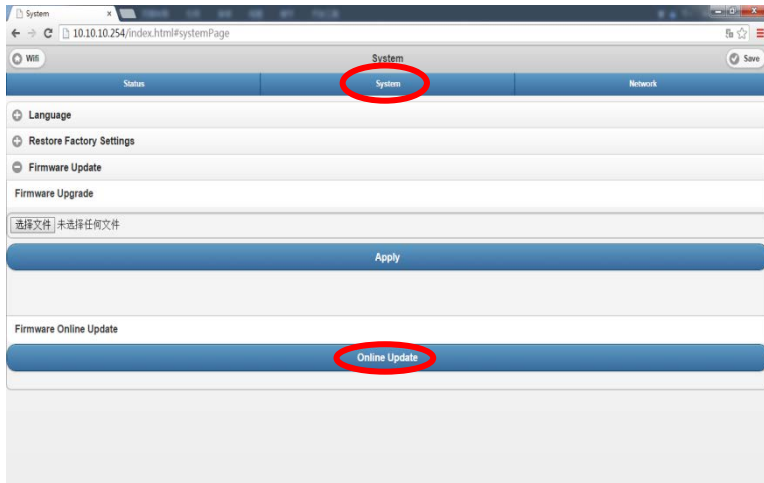

7. It will automatically download firmware upgrades, when it's upgraded successfully, the web will show a message.



APP update :

If you see "New" icon next to setting button, a new firmware is available for your unit. In order to apply this firmware tap on "New" and you will see a pop up message. Plug in adapter, then select upgrade and wait until the device upgrade process finishes without other operations .

> Interface icon and functions

This icon shows that it is played by DLNA

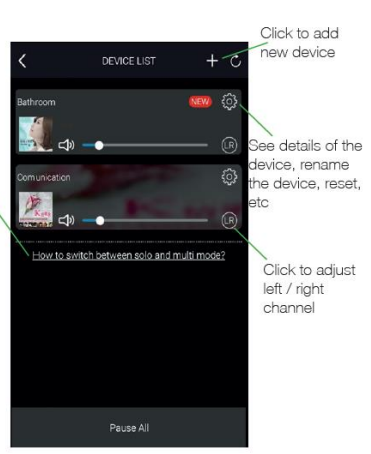
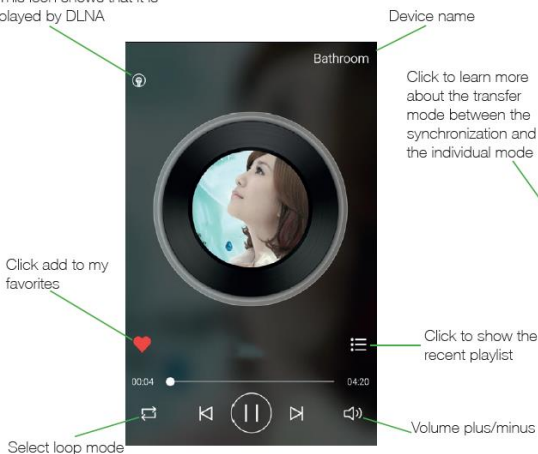

➤ How to clean the Machine

Warning :

1. Turn off machine before cleaning it.
2. Do not use volatile solvents (such as ethanol, rosin, toluene solvent) to clean the machine. This type of chemicals may damage the machine.
3. Use cotton or microfiber cleaning cloth.
4. In the cleaning process, do not water droplets into the product panels and speakers causing malfunction.

4. Troubleshooting Methods

The following table contains common problems and solutions, please read carefully.

Problem	Solution
The speaker has no sound	Make sure the machine was charged before used; Try to increase the volume; Please reselect the audio input channel; Please make sure that all cables are correctly connected;
The speaker murmur	Please make sure that all cables are correctly connected; Please replace the other audio cable; Please ensure the equipment that connected audio cable output itself did not murmur;
No power or No charging	Please make sure that the adapter and the host is connected correctly; Please check the power adapter voltage and current demand;
Wi-Fi mode without sound	Please check whether the PC or smart phone and machine are in the same Lan or not; Please check whether the machine is in Wi-Fi mode or not; If using the app, please check whether the music is sent to the speaker or not;
Line-in mode without sound	Please check whether the audio cable is properly connected or not;
The keys have no function	Plug the adapter, then power on; Use a toothpick or needle to press the reset hole, then power on;

5. Specification

Model	E-350
speaker	1×4 inch Coaxial speaker, 4ohm
Frequency response	75Hz-20KHz (-10dB)
Power amplifier	Class D @ 20W × 1CH
THD	< 10%
SNR	>75dB(A)
Sound pressure level	84dB (1M@1W)
Play mode	Wi-Fi/Bluetooth/Line-in/USB
Adapter	DC 15V,1.2A
Product size	219×106×155mm
Wi-Fi	Support 802.11 b/g/n
	Support STA/AP/AP Client
	Support Airplay, DLNA, Qplay

Operation Temperature: -20°C ~ 55°C

Operation Humidity: 20%-80%RH