

FCC REPORT

(UNII)

Applicant: APRIX LATINOAMERICA S.A.

Address of Applicant: ADVANCED 099 BLDG SUITE 4 C CALLE BEATRIZ M DE CABAL PANAMA

Equipment Under Test (EUT)

Product Name: Tablet PC

Model No.: Aprix Tab8ii, Tab X1, Tab X2, Tab 10ii

Trade mark: APRIX/KONNEN

FCC ID: 2AHJQ-APT8IIB

Applicable standards: FCC CFR Title 47 Part 15 Subpart E Section 15.407

Date of sample receipt: 09 May, 2019

Date of Test: 09 May, to 30 May, 2019

Date of report issued: 24 Nov., 2020

Test Result: PASS*

* In the configuration tested, the EUT complied with the standards specified above.

Authorized Signature:



Bruce Zhang

Laboratory Manager

This report details the results of the testing carried out on one sample. The results contained in this test report do not relate to other samples of the same product and does not permit the use of the JYT product certification mark. The manufacturer should ensure that all products in series production are in conformity with the product sample detailed in this report.

This report may only be reproduced and distributed in full. If the product in this report is used in any configuration other than that detailed in the report, the manufacturer must ensure the new system complies with all relevant standards.

This document cannot be reproduced except in full, without prior written approval of the Company. Any unauthorized alteration, forgery or falsification of the content or appearance of this document is unlawful and offenders may be prosecuted to the fullest extent of the law. Unless otherwise stated the results shown in this test report refer only to the sample(s) tested and such sample(s) are retained for 90 days only.

2 Version

Version No.	Date	Description
00	24 Nov., 2020	Original

Remark:

The new Product Name, Model No., FCC ID: 2AHJQ-APT8IIB and the certified FCC ID: 2AHJQ-APT8IIA are electrically identical, so the test data of the new FCC ID: 2AHJQ-APT8IIB is all derived from the FCC test report of the certified FCC ID: 2AHJQ-APT8IIA.

Tested by: Mike.ou **Date:** 24 Nov., 2020
Test Engineer

Reviewed by: Wimer Zhang **Date:** 24 Nov., 2020
Project Engineer

3 Contents

	Page
1 COVER PAGE	1
2 VERSION	2
3 CONTENTS	3
4 TEST SUMMARY	4
5 GENERAL INFORMATION	5
5.1 CLIENT INFORMATION.....	5
5.2 GENERAL DESCRIPTION OF E.U.T.....	5
5.3 TEST ENVIRONMENT AND TEST MODE.....	6
5.4 DESCRIPTION OF SUPPORT UNITS	7
5.5 MEASUREMENT UNCERTAINTY.....	7
5.6 RELATED SUBMITTAL(S) / GRANT (S)	7
5.7 LABORATORY FACILITY	7
5.8 LABORATORY LOCATION.....	7
5.9 TEST INSTRUMENTS LIST	8
6 TEST RESULTS AND MEASUREMENT DATA	9
6.1 ANTENNA REQUIREMENT	9
6.2 CONDUCTED EMISSION.....	10
6.3 CONDUCTED OUTPUT POWER	13
6.4 OCCUPY BANDWIDTH.....	18
6.5 POWER SPECTRAL DENSITY	24
6.6 BAND EDGE.....	29
6.7 SPURIOUS EMISSION.....	36
6.7.1 Restricted Band	36
6.7.2 Unwanted Emissions out of the Restricted Bands	43
6.8 FREQUENCY STABILITY	53
7 TEST SETUP PHOTO	55
8 EUT CONSTRUCTIONAL DETAILS	56

4 Test Summary

Test Item	Section in CFR 47	Test Result
Antenna requirement	15.203 & 15.407 (a)	Pass*
AC Power Line Conducted Emission	15.207	Pass*
Conducted Peak Output Power	15.407 (a) (1) (iv)	Pass*
26dB Occupied Bandwidth	15.407 (a) (5)	Pass*
Power Spectral Density	15.407 (a) (1) (iv)	Pass*
Band Edge	15.407(b)	Pass*
Spurious Emission	15.407 (b) & 15.205 & 15.209	Pass*
Frequency Stability	15.407(g)	Pass*

Pass: The EUT complies with the essential requirements in the standard.

Pass: The new Product Name, Model No., FCC ID: 2AHJQ-APT8IIB and the certified FCC ID: 2AHJQ-APT8IIA are electrically identical, so the test data of the new FCC ID: 2AHJQ-APT8IIB is all derived from the FCC test report of the certified FCC ID: 2AHJQ-APT8IIA.*

N/A: N/A: Not Applicable.

5 General Information

5.1 Client Information

Applicant:	APRIX LATINOAMERICA S.A.
Address:	ADVANCED 099 BLDG SUITE 4 C CALLE BEATRIZ M DE CABAL PANAMA
Manufacturer:	Todos industrial limited
Address:	Room 308, Building #5, Cofoc (Fuan) Robotics Industrial Park, No.90, Dayang Road, Fuyong Street, Shenzhen City, P.R. China

5.2 General Description of E.U.T.

Product Name:	Tablet PC
Model No.:	Aprix Tab8ii, Tab X1, Tab X2, Tab 10ii
Operation Frequency:	5150MHz-5250MHz
Channel numbers:	Band 1: 802.11a/n-HT20/ac-HT20: 4, 802.11n-HT40/ac-HT40: 2, 802.11ac-HT80: 1
Channel separation:	802.11802.11a/n-HT20/ac-HT20: 20MHz, 802.11 n-HT40/ac-HT40: 40MHz, 802.11 ac-HT80: 80MHz
Modulation technology (IEEE 802.11a):	BPSK, QPSK, 16-QAM, 64-QAM
Modulation technology (IEEE 802.11n):	BPSK, QPSK, 16-QAM, 64-QAM
Modulation technology (IEEE 802.11ac):	BPSK, QPSK, 16-QAM, 64-QAM, 256-QAM
Data speed (IEEE 802.11a):	6Mbps, 9Mbps,12Mbps,18Mbps, 24Mbps, 36Mbps, 48Mbps, 54Mbps
Data speed (IEEE 802.11n20):	MCS0: 6.5Mbps, MCS1:13Mbps,MCS2:19.5Mbps, MCS3:26Mbps, MCS4:39Mbps, MCS5:52Mbps, MCS6:58.5Mbps, MCS7:65Mbps
Data speed (IEEE 802.11n40):	MCS0:15Mbps, MCS1:30Mbps, MCS2:45Mbps, MCS3:60Mbps, MCS4:90Mbps, MCS5:120Mbps, MCS6:135Mbps, MCS7:150Mbps
Data speed (IEEE 802.11ac):	Up to 433.3Mbps
Antenna Type:	Internal Antenna
Antenna gain:	1.02 dBi
Power supply:	Rechargeable Li-ion polymer Battery DC3.8V/4500mAh
AC adapter:	Model: BY120502000 Input: AC100-240V, 50/60Hz, 0.3A Output: DC 5.0V, 2A
Remark:	Model No.: Aprix Tab8ii, Tab X1, Tab X2, Tab 10ii, were identical inside, the electrical circuit design, layout, components used and internal wiring, the only difference being model name.
Test Sample Condition:	The test samples were provided in good working order with no visible defects.

Operation Frequency each of channel					
Band 1					
802.11a/n-HT20/ac-HT20		802.11n-HT40/ac-HT40		802.11ac-HT80	
Channel	Frequency	Channel	Frequency	Channel	Frequency
36	5180MHz	38	5190MHz	42	5210MHz
40	5200MHz	46	5230MHz		
44	5220MHz				
48	5240MHz				

Note:

In section 15.31(m), regards to the operating frequency range over 10 MHz, the Lowest frequency, the middle frequency, and the highest frequency of channel were selected to perform the test, and the selected channel see below:

Band 1					
802.11a/n-HT20/ac-HT20		802.11n-HT40/ac-HT40		802.11ac-HT80	
Channel	Frequency	Channel	Frequency	Channel	Frequency
Lowest	5180MHz	Lowest	5190MHz	Middle	5210MHz
Middle	5200MHz	Highest	5230MHz		
Highest	5240MHz				

5.3 Test environment and test mode

Operating Environment:	
Temperature:	24.0 °C
Humidity:	54 % RH
Atmospheric Pressure:	1010 mbar
Test mode:	
Continuously transmitting mode	Keep the EUT in 100% duty cycle transmitting with modulation.
We have verified the construction and function in typical operation. All the test modes were carried out with the EUT in transmitting operation, which was shown in this test report and defined as follows:	
Per-scan all kind of data rate, and found the follow list were the worst case.	
Mode	Data rate
802.11a	6 Mbps
802.11n20	6.5 Mbps
802.11n40	13 Mbps
802.11ac	29.3 Mbps

5.4 Description of Support Units

N/A

5.5 Measurement Uncertainty

Parameters	Expanded Uncertainty
Conducted Emission (9kHz ~ 30MHz)	±1.60 dB (k=2)
Radiated Emission (9kHz ~ 30MHz)	±3.12 dB (k=2)
Radiated Emission (30MHz ~ 1000MHz)	±4.54 dB (k=2)
Radiated Emission (1GHz ~ 18GHz)	±5.84 dB (k=2)
Radiated Emission (18GHz ~ 40GHz)	±3.36 dB (k=2)

5.6 Related Submittal(s)/ Grant (s)

This is an original grant, no related submittals and grants.

5.7 Laboratory Facility

The test facility is recognized, certified, or accredited by the following organizations:

- **FCC - Designation No.: CN1211**
JianYan Testing Group Shenzhen Co., Ltd. has been accredited as a testing laboratory by FCC(Federal Communications Commission). The test firm Registration No. is 727551.
- **ISED – CAB identifier.: CN0021**
The 3m Semi-anechoic chamber of JianYan Testing Group Shenzhen Co., Ltd. has been Registered by Certification and Engineering Bureau of Industry Canada for radio equipment testing with Registration No.: 10106A-1.
- **A2LA - Registration No.: 4346.01**
This laboratory is accredited in accordance with the recognized International Standard ISO/IEC 17025:2005 General requirements for the competence of testing and calibration laboratories. The test scope can be found as below link: <https://portal.a2la.org/scopepdf/4346-01.pdf>

5.8 Laboratory Location

JianYan Testing Group Shenzhen Co., Ltd.
 Address: No.110~116, Building B, Jinyuan Business Building, Xixiang Road, Bao'an District, Shenzhen, Guangdong, China
 Tel: +86-755-23118282, Fax:+86-755-23116366
 Email: info@ccis-cb.com, Website: <http://www.ccis-cb.com>

5.9 Test Instruments list

Test Equipment	Manufacturer	Model No.	Serial No.	Cal. Date (mm-dd-yy)	Cal. Due date (mm-dd-yy)
3m SAC	SAEMC	9m*6m*6m	966	07-22-2017	07-21-2020
BiConiLog Antenna	SCHWARZBECK	VULB9163	497	03-18-2019	03-17-2020
Biconical Antenna	SCHWARZBECK	VUBA9117	359	06-22-2017	06-21-2020
Horn Antenna	SCHWARZBECK	BBHA9120D	916	03-18-2019	03-17-2020
Horn Antenna	SCHWARZBECK	BBHA9120D	1805	06-22-2017	06-21-2020
Horn Antenna	SCHWARZBECK	BBHA 9170	BBHA9170582	11-21-2018	11-20-2019
EMI Test Software	AUDIX	E3	Version: 6.110919b		
Pre-amplifier	HP	8447D	2944A09358	03-18-2019	03-17-2020
Pre-amplifier	CD	PAP-1G18	11804	03-18-2019	03-17-2020
Spectrum analyzer	Rohde & Schwarz	FSP30	101454	03-18-2019	03-17-2020
Spectrum analyzer	Rohde & Schwarz	FSP40	100363	11-21-2018	11-20-2019
EMI Test Receiver	Rohde & Schwarz	ESRP7	101070	03-18-2019	03-17-2020
Spectrum Analyzer	Agilent	N9020A	MY50510123	11-10-2018	11-09-2019
Signal Generator	Rohde & Schwarz	SMX	835454/016	03-18-2019	03-17-2020
Signal Generator	R&S	SMR20	1008100050	03-18-2019	03-17-2020
RF Switch Unit	MWRFTTEST	MW200	N/A	N/A	N/A
Test Software	MWRFTTEST	MTS8200	Version: 2.0.0.0		
Cable	ZDECL	Z108-NJ-NJ-81	1608458	03-18-2019	03-17-2020
Cable	MICRO-COAX	MFR64639	K10742-5	03-18-2019	03-17-2020
Cable	SUHNER	SUCOFLEX100	58193/4PE	03-18-2019	03-17-2020
DC Power Supply	XinNuoEr	WYK-10020K	1409050110020	10-31-2018	10-30-2019
Temperature Humidity Chamber	HengPu	HPGDS-500	20140828008	09-24-2018	09-23-2019
Simulated Station	Rohde & Schwarz	CMW500	140493	07-16-2018	07-15-2019

Conducted Emission:					
Test Equipment	Manufacturer	Model No.	Serial No.	Cal. Date (mm-dd-yy)	Cal. Due date (mm-dd-yy)
EMI Test Receiver	Rohde & Schwarz	ESCI	101189	03-18-2019	03-17-2020
Pulse Limiter	SCHWARZBECK	OSRAM 2306	9731	03-18-2019	03-17-2020
LISN	CHASE	MN2050D	1447	03-18-2019	03-17-2020
LISN	Rohde & Schwarz	ESH3-Z5	8438621/010	07-21-2018	07-20-2019
Cable	HP	10503A	N/A	03-18-2019	03-17-2020
EMI Test Software	AUDIX	E3	Version: 6.110919b		

6 Test results and Measurement Data

6.1 Antenna requirement

Standard requirement:	FCC Part15 E Section 15.203 /407(a)
<p>15.203 requirement: An intentional radiator shall be designed to ensure that no antenna other than that furnished by the responsible party shall be used with the device. The use of a permanently attached antenna or of an antenna that uses a unique coupling to the intentional radiator, the manufacturer may design the unit so that a broken antenna can be replaced by the user, but the use of a standard antenna jack or electrical connector is prohibited. This requirement does not apply to carrier current devices or to devices operated under the provisions of §15.211, § 15.213, § 15.217, § 15.219, or § 15.221. Further, this requirement does not apply to intentional radiators that must be professionally installed, such as perimeter protection systems and some field disturbance sensors, or to other intentional radiators which, in accordance with § 15.31(d), must be measured at the installation site. However, the installer shall be responsible for ensuring that the proper antenna is employed so that the limits in this part are not exceeded.</p>	
E.U.T Antenna:	
<p>The Wi-Fi antenna is an Internal antenna which cannot replace by end-user, the best case gain of the antenna is 1.02 dBi.</p>	

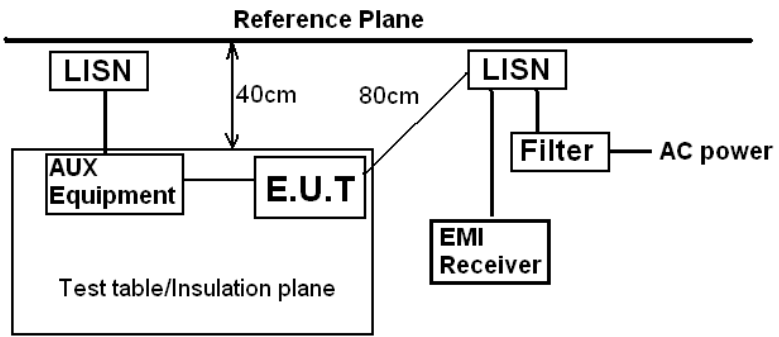

6.2 Conducted Emission

Test Requirement:	FCC Part15 C Section 15.207		
Test Method:	ANSI C63.10: 2013		
Test Frequency Range:	150kHz to 30MHz		
Class / Severity:	Class B		
Receiver setup:	RBW=9kHz, VBW=30kHz		
Limit:	Frequency range (MHz)	Limit (dBUV)	
		Quasi-peak	
	0.15-0.5	66 to 56*	0.15-0.5
	0.5-5	56	0.5-5
	5-30	60	5-30
	* Decreases with the logarithm of the frequency.		
Test procedure	<ol style="list-style-type: none"> The E.U.T and simulators are connected to the main power through a line impedance stabilization network (L.I.S.N.). It provides a 50ohm/50uH coupling impedance for the measuring equipment. The peripheral devices are also connected to the main power through a LISN that provides a 50ohm/50uH coupling impedance with 50ohm termination. (Please refer to the block diagram of the test setup and photographs). Both sides of A.C. line are checked for maximum conducted interference. In order to find the maximum emission, the relative positions of equipment and all of the interface cables must be changed according to ANSI C63.10: 2013 on conducted measurement. 		
Test setup:	 <p><i>Remark:</i> E.U.T: Equipment Under Test LISN: Line Impedance Stabilization Network Test table height=0.8m</p>		
Test Instruments:	Refer to section 5.9 for details		
Test mode:	Refer to section 5.3 for details.		
Test results:	Passed		

Measurement Data:

Product name:	Tablet PC	Product model:	APRIX TAB8II
Test by:	Mike	Test mode:	5G Wi-Fi Tx mode
Test frequency:	150 kHz ~ 30 MHz	Phase:	Line
Test voltage:	AC 120 V/60 Hz	Environment:	Temp:22.5°C Humi:55%

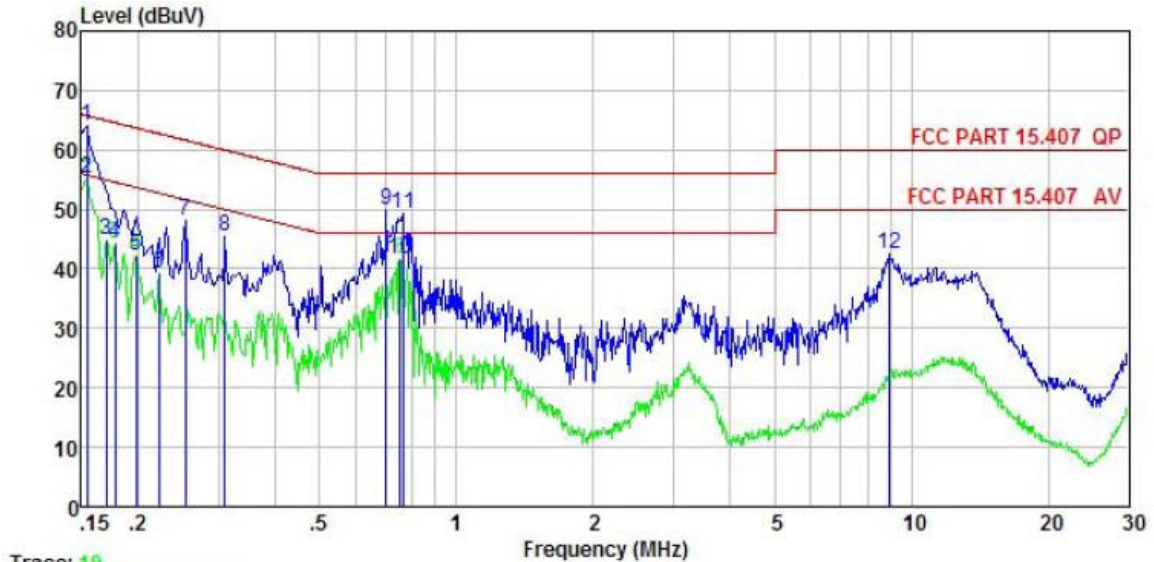

Trace: 19

	Freq	Read Level	LISN Factor	Cable Loss	Level	Limit Line	Over Limit	Remark
	MHz	dBuV	dB	dB	dBuV	dBuV	dB	
1	0.154	53.58	-0.45	10.78	63.91	65.78	-1.87	QP
2	0.154	44.82	-0.45	10.78	55.15	55.78	-0.63	Average
3	0.170	34.62	-0.43	10.77	44.96	54.94	-9.98	Average
4	0.178	33.81	-0.43	10.77	44.15	54.59	-10.44	Average
5	0.198	31.94	-0.41	10.76	42.29	53.71	-11.42	Average
6	0.222	28.83	-0.40	10.76	39.19	52.74	-13.55	Average
7	0.253	37.79	-0.40	10.75	48.14	61.64	-13.50	QP
8	0.310	34.99	-0.38	10.74	45.35	59.97	-14.62	QP
9	0.701	39.43	-0.38	10.77	49.82	56.00	-6.18	QP
10	0.751	31.32	-0.38	10.79	41.73	46.00	-4.27	Average
11	0.763	39.03	-0.38	10.80	49.45	56.00	-6.55	QP
12	8.916	32.16	-0.58	10.89	42.47	60.00	-17.53	QP

Notes:

1. An initial pre-scan was performed on the line and neutral lines with peak detector.
2. Quasi-Peak and Average measurement were performed at the frequencies with maximized peak emission.
3. Final Level=Receiver Read level+ LISN Factor + Cable Loss.

Product name:	Tablet PC	Product model:	APRIX TAB8II
Test by:	Mike	Test mode:	5G Wi-Fi Tx mode
Test frequency:	150 kHz ~ 30 MHz	Phase:	Neutral
Test voltage:	AC 120 V/60 Hz	Environment:	Temp: 22.5°C Humi: 55%

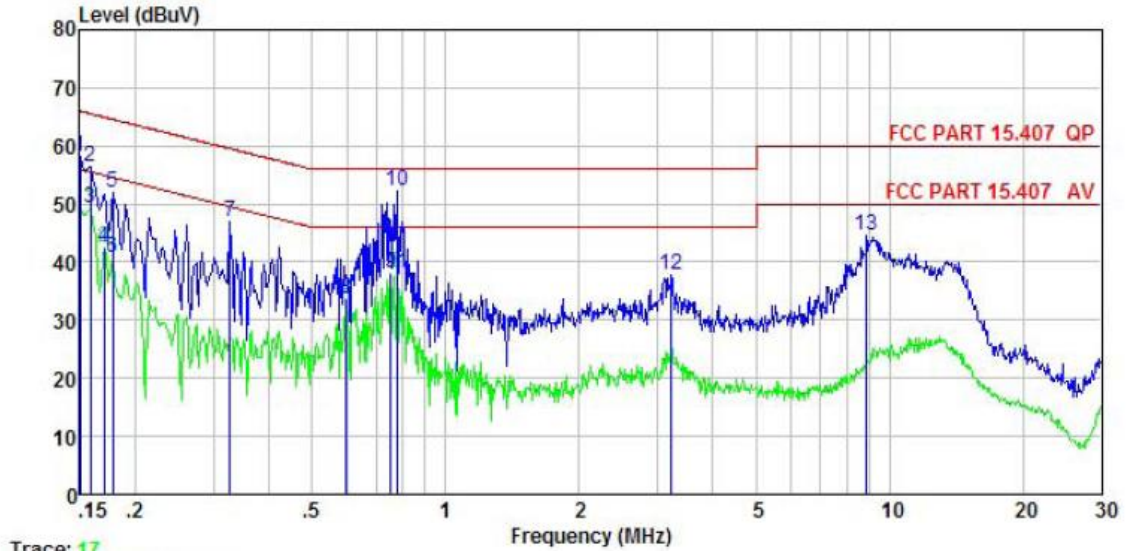

Trace: 17

	Read Freq	Level	LISN Factor	Cable Loss	Level	Limit Line	Over Limit	Remark
	MHz	dBuV	dB	dB	dBuV	dBuV	dB	
1	0.150	48.20	-0.68	10.78	58.30	66.00	-7.70	QP
2	0.158	46.39	-0.68	10.77	56.48	65.56	-9.08	QP
3	0.158	39.30	-0.68	10.77	49.39	55.56	-6.17	Average
4	0.170	32.48	-0.68	10.77	42.57	54.94	-12.37	Average
5	0.178	41.74	-0.69	10.77	51.82	64.59	-12.77	QP
6	0.178	30.68	-0.69	10.77	40.76	54.59	-13.83	Average
7	0.327	36.97	-0.63	10.73	47.07	59.53	-12.46	QP
8	0.598	23.48	-0.64	10.77	33.61	46.00	-12.39	Average
9	0.751	27.91	-0.64	10.79	38.06	46.00	-7.94	Average
10	0.775	42.01	-0.64	10.80	52.17	56.00	-3.83	QP
11	0.775	27.94	-0.64	10.80	38.10	46.00	-7.90	Average
12	3.224	27.59	-0.68	10.91	37.82	56.00	-18.18	QP
13	8.869	34.52	-0.78	10.89	44.63	60.00	-15.37	QP

Notes:

1. An initial pre-scan was performed on the line and neutral lines with peak detector.
2. Quasi-Peak and Average measurement were performed at the frequencies with maximized peak emission.
3. Final Level=Receiver Read level + LISN Factor + Cable Loss.

6.3 Conducted Output Power

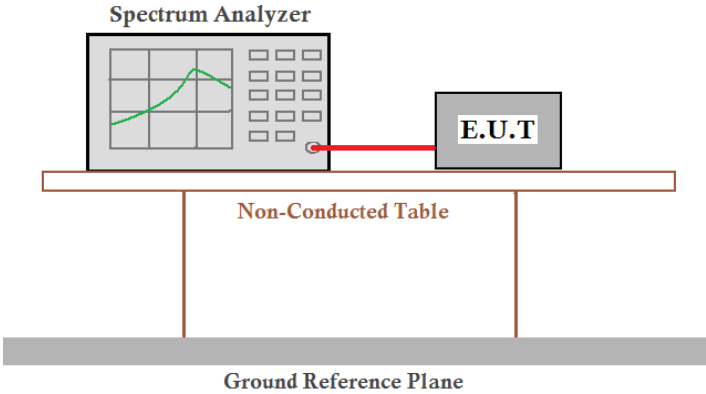
Test Requirement:	FCC Part15 E Section 15.407 (a) (1) (iv)
Test Method:	ANSI C63.10: 2013, KDB789033
Limit:	(iv) For client devices in the 5.15-5.25 GHz band, the maximum conducted output power over the frequency band of operation shall not exceed 250 mW provided the maximum antenna gain does not exceed 6 dBi.
Test setup:	 <p>The diagram illustrates the test setup. A Spectrum Analyzer is connected to an E.U.T. (Equipment Under Test) via a red cable. Both are placed on a Non-Conducted Table, which sits on a Ground Reference Plane.</p>
Test Instruments:	Refer to section 5.9 for details
Test mode:	Refer to section 5.3 for details
Test results:	Passed

Measurement Data:

Band 1				
Mode	Test CH	Conducted Output power (dBm)	Limit (dBm)	Result
802.11a	Lowest	3.96	24.00	Pass
	Middle	3.88		
	Highest	3.62		
802.11n20	Lowest	3.58	24.00	Pass
	Middle	3.56		
	Highest	3.29		
802.11n40	Lowest	3.49	24.00	Pass
	Highest	3.14		
802.11ac20	Lowest	3.63	24.00	Pass
	Middle	3.57		
	Highest	3.26		
802.11ac40	Lowest	3.42	24.00	Pass
	Highest	3.62		
802.11ac80	Lowest	3.28	24.00	Pass

Test plot as follows:
Band 1:

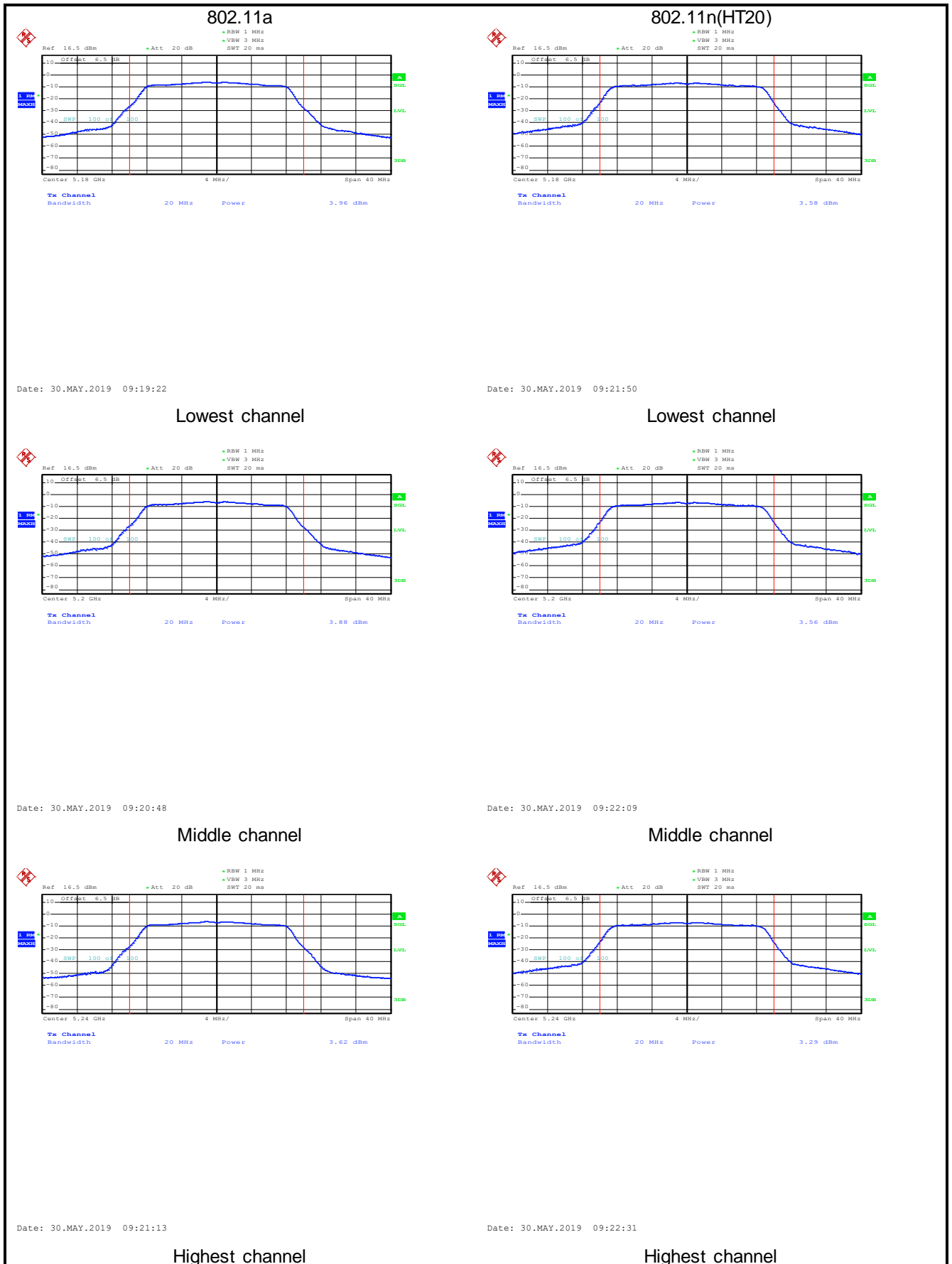

802.11n(HT40)

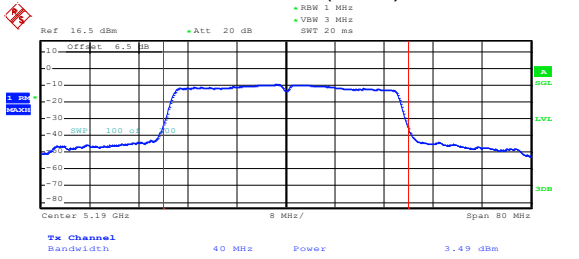

802.11ac(HT20)

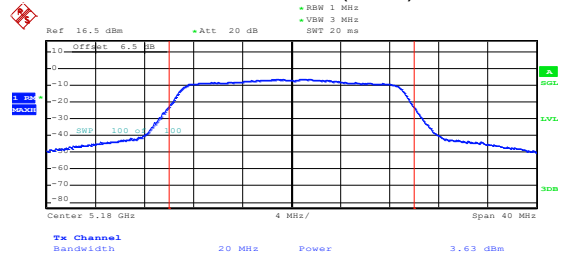

Date: 30.MAY.2019 09:24:55

Date: 30.MAY.2019 09:23:03

Lowest channel

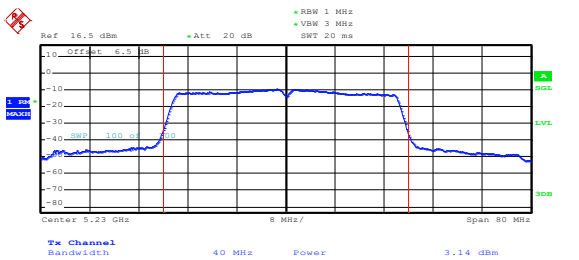

Lowest channel

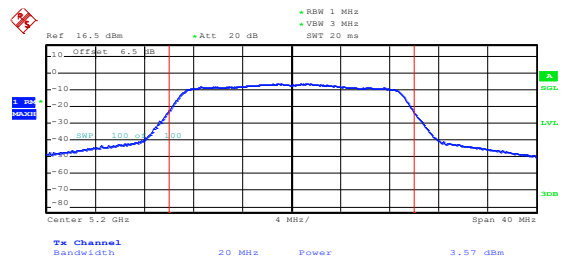

Date: 30.MAY.2019 09:25:16

Date: 30.MAY.2019 09:23:32

Highest channel

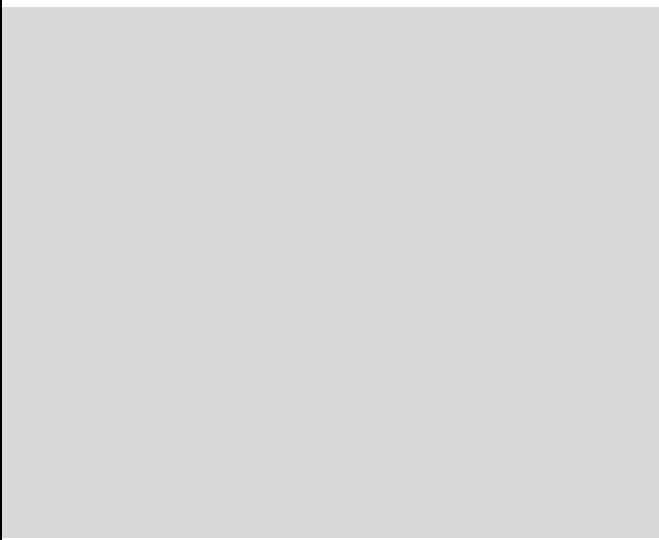

Middle channel

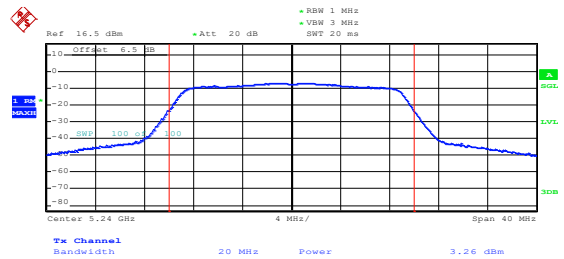

Date: 30.MAY.2019 09:23:57

Highest channel

802.11ac(HT40)

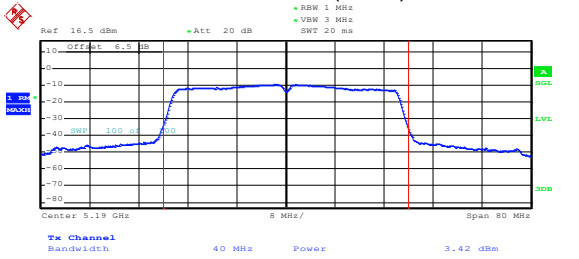

Date: 30.MAY.2019 09:26:07

802.11ac(HT80)

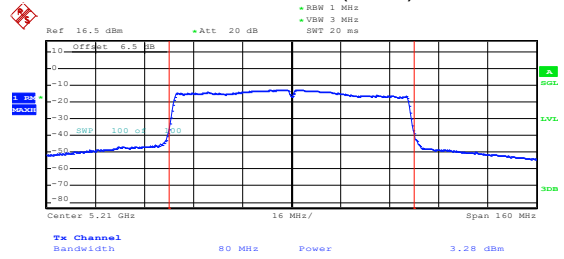

Date: 30.MAY.2019 09:27:37

Lowest channel

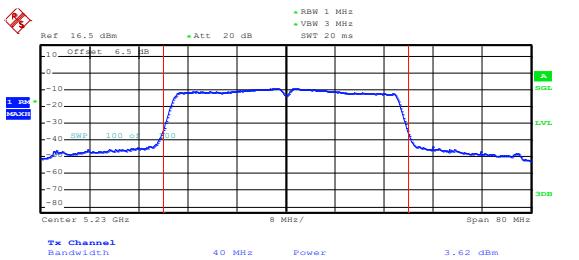

Date: 30.MAY.2019 09:26:35

Middle channel

Highest channel

6.4 Occupy Bandwidth

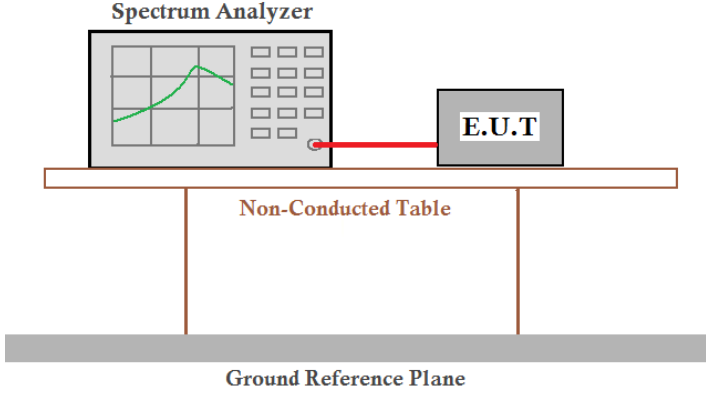
Test Requirement:	FCC Part15 E Section 15.407 (a) (5)
Test Method:	ANSI C63.10:2013 and KDB 789033
Limit:	Band 1: N/A (26dB Emission Bandwidth and 99% Occupy Bandwidth)
Test setup:	 <p>The diagram illustrates the test setup. A Spectrum Analyzer is connected via a red cable to an E.U.T. (Equipment Under Test). Both are placed on a Non-Conducted Table. Below the table is a Ground Reference Plane.</p>
Test Instruments:	Refer to section 5.9 for details
Test mode:	Refer to section 5.3 for details
Test results:	Passed

Measurement Data:

Band 1:

Test Channel	26dB Emission Bandwidth (MHz)						Limit	Result
	802.11a	802.11n (HT20)	802.11n (HT40)	802.11ac (HT20)	802.11ac (HT40)	802.11ac (HT80)		
Lowest	21.01	21.06	38.86	21.24	39.04	---	N/A	PASS
Middle	21.08	21.30	---	21.12	---	79.52		
Highest	19.91	19.06	38.65	20.03	39.01	---		
Test Channel	99% Occupy Bandwidth (MHz)						Limit	Result
	802.11a	802.11n (HT20)	802.11n (HT40)	802.11ac (HT20)	802.11ac (HT40)	802.11ac (HT80)		
Lowest	17.03	18.04	36.15	18.08	36.15	---	N/A	PASS
Middle	16.97	18.02	---	18.04	---	75.46		
Highest	16.99	18.04	36.15	18.08	36.16	---		

Test plot as follows:
Band 1:

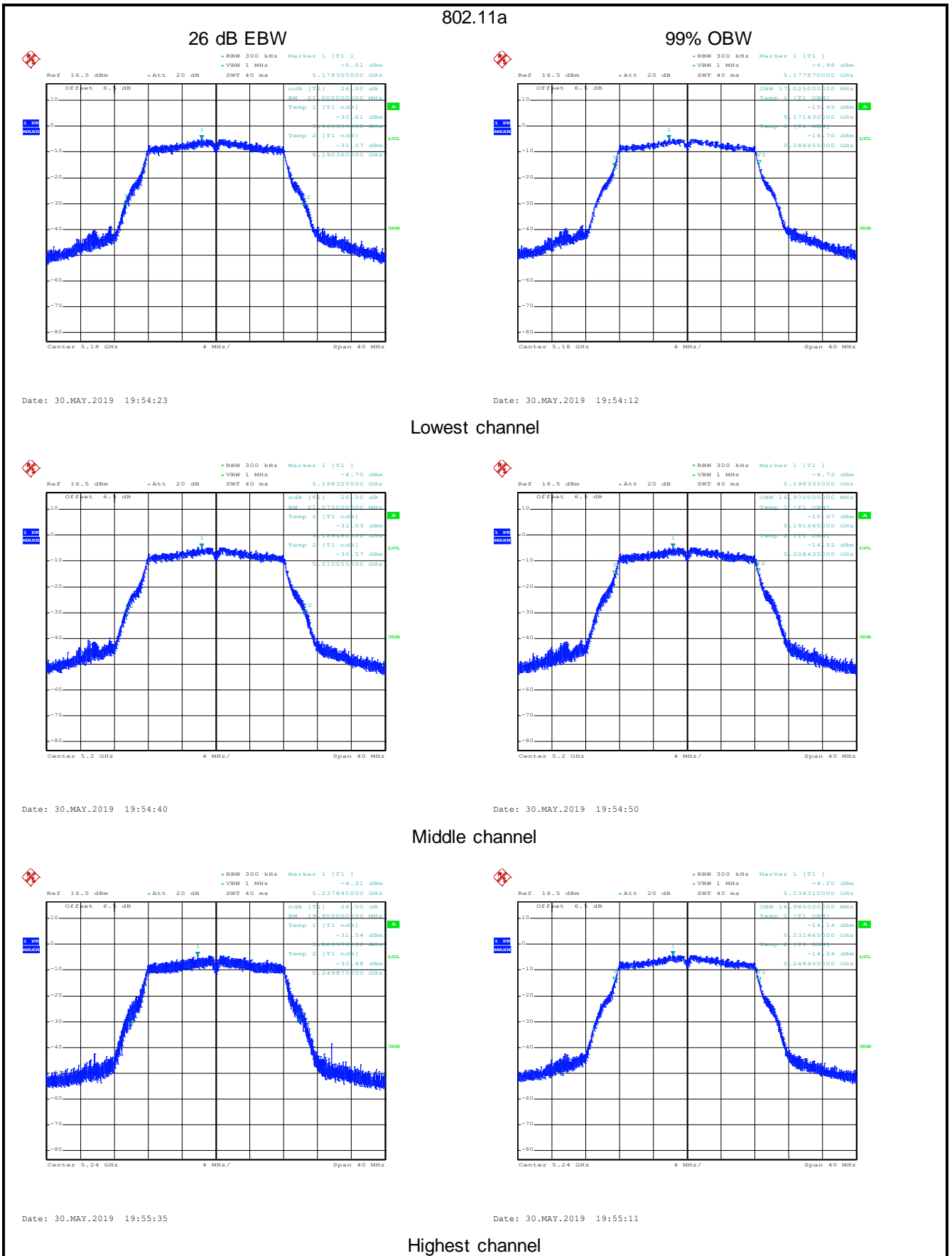

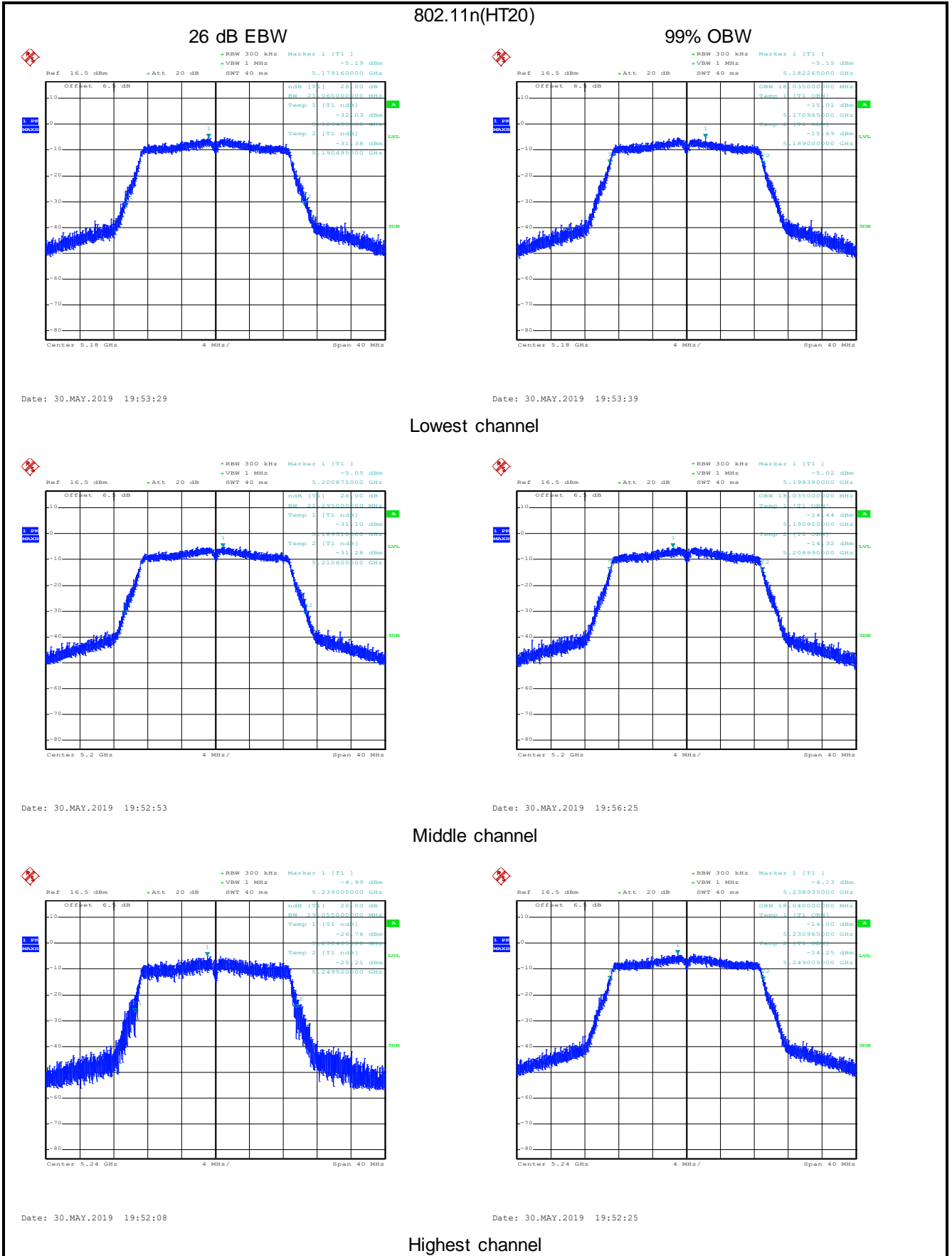

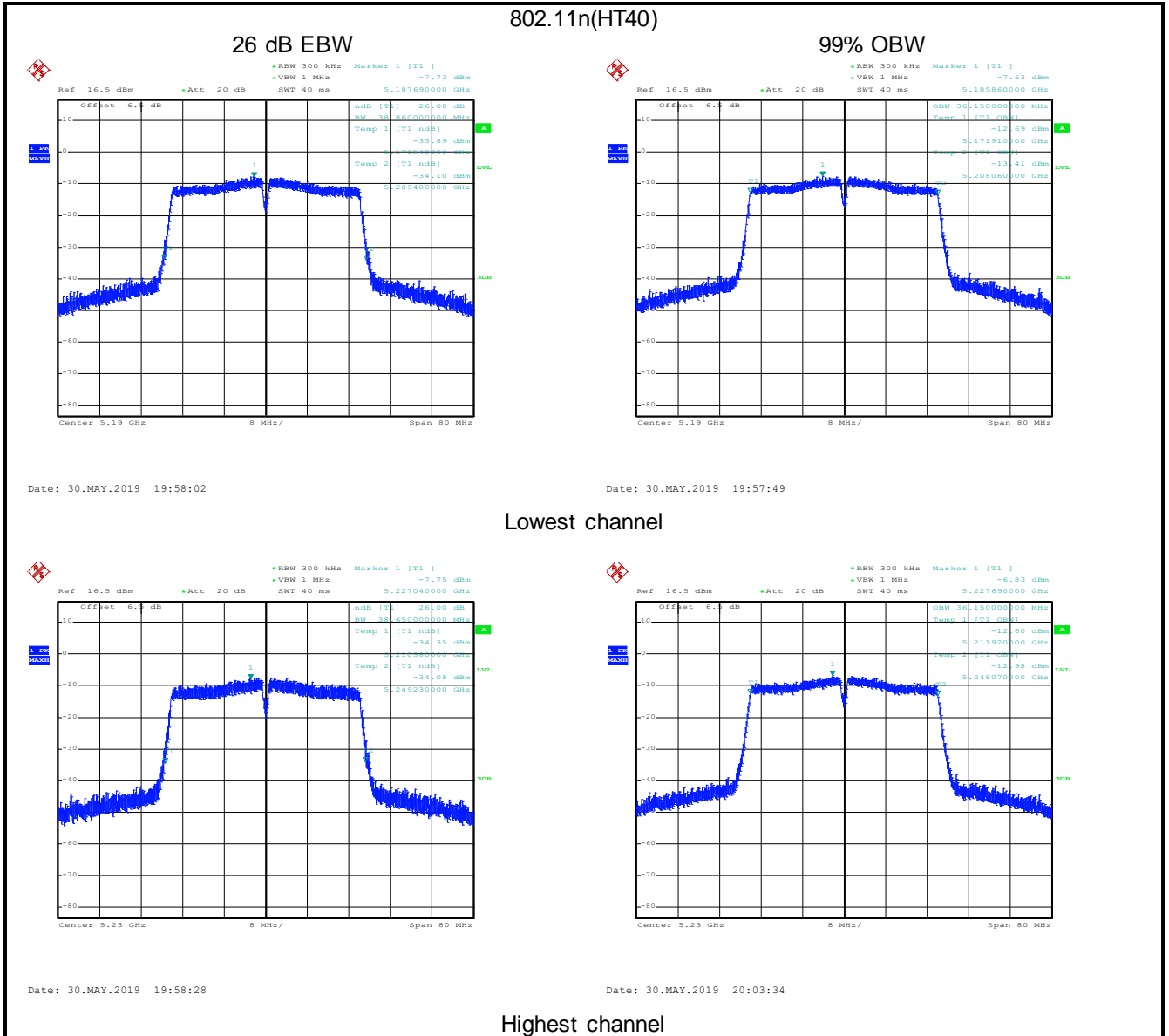

802.11ac(HT20)

26 dB EBW

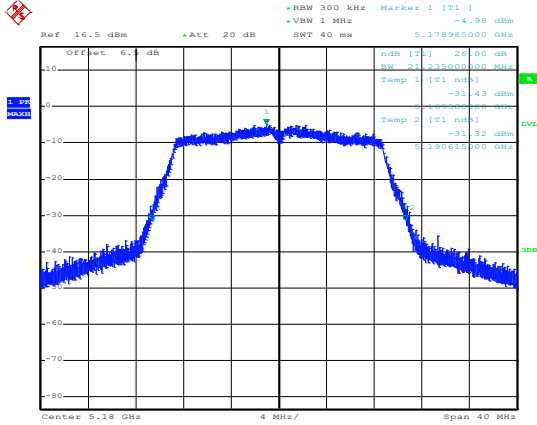

99% OBW

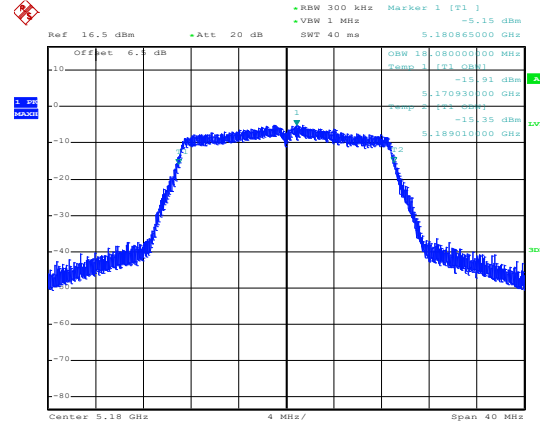

Date: 30.MAY.2019 19:55:56

Date: 30.MAY.2019 19:56:11

Lowest channel

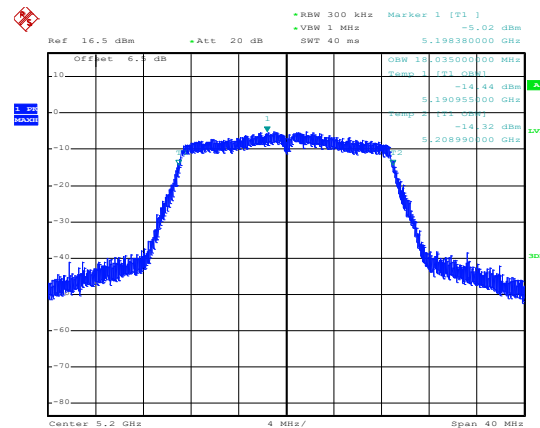
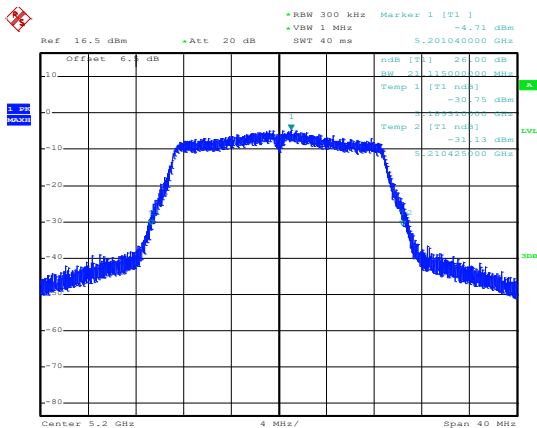

Date: 30.MAY.2019 19:56:36

Date: 30.MAY.2019 19:56:25

Middle channel

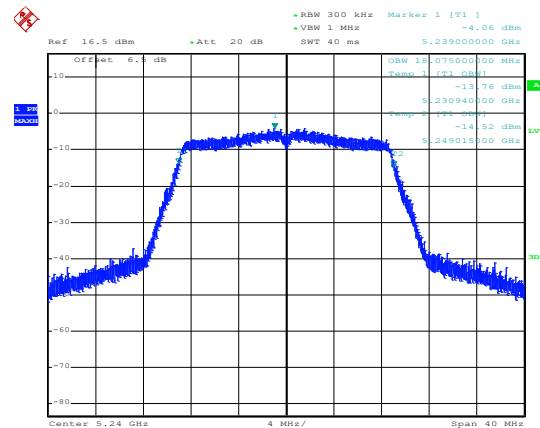
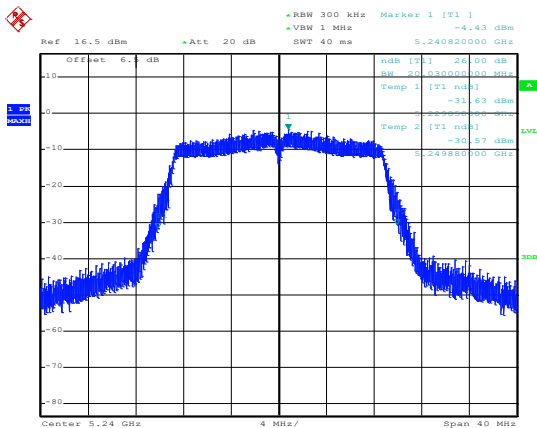

Date: 30.MAY.2019 19:56:56

Date: 30.MAY.2019 19:57:10

Highest channel

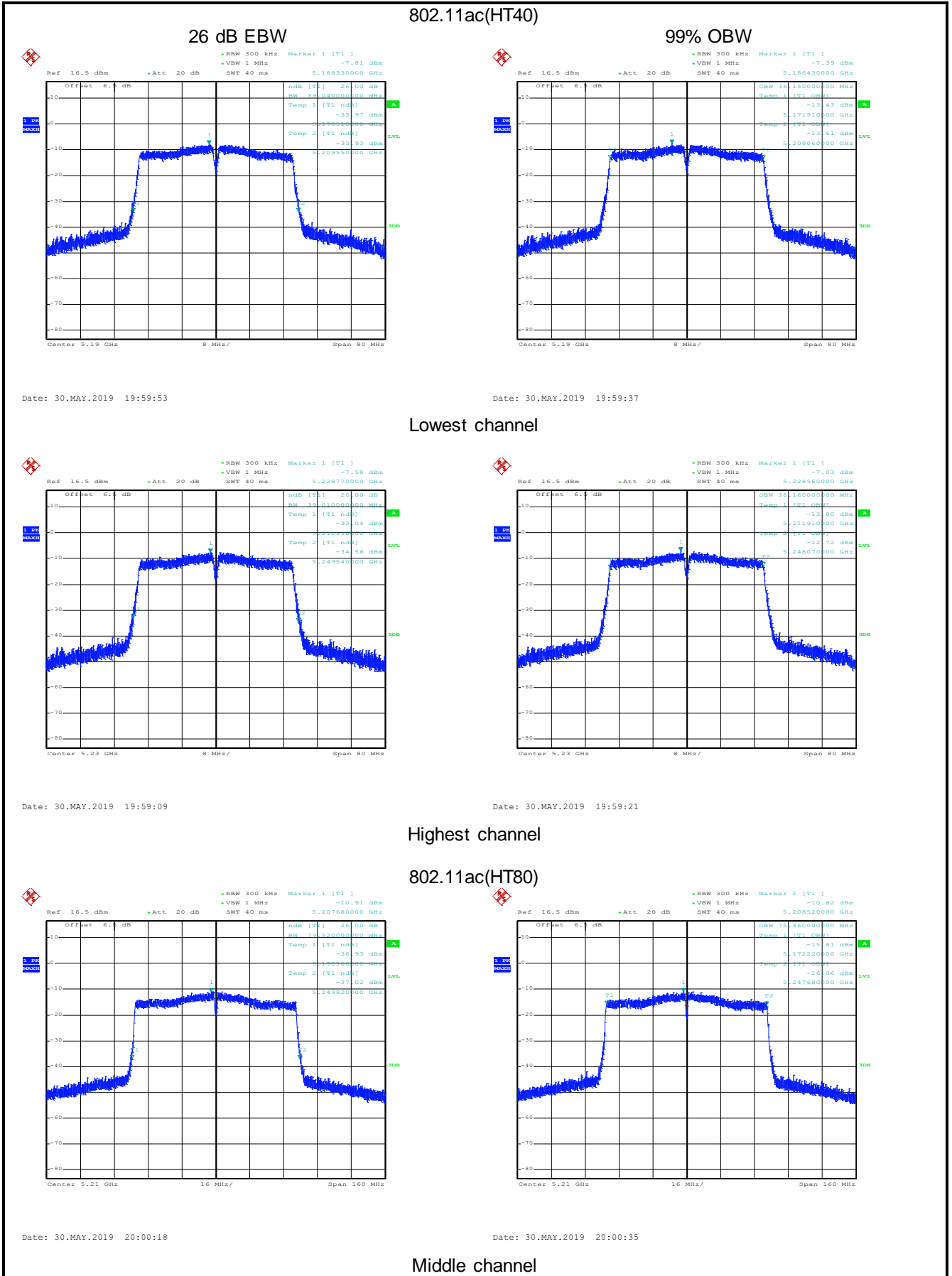

6.5 Power Spectral Density

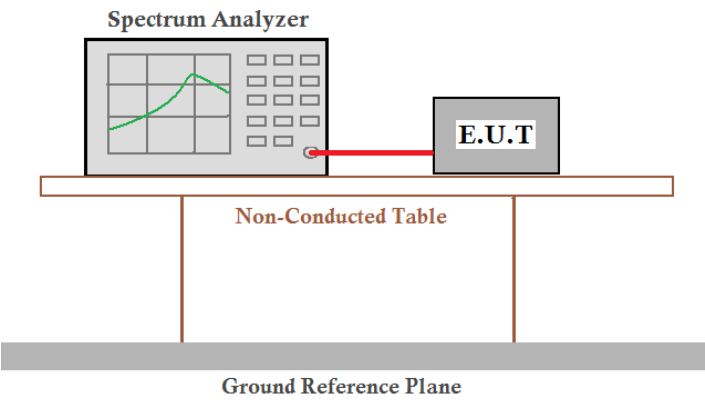
Test Requirement:	FCC Part15 E Section 15.407 (a) (1) (iv)
Test Method:	ANSI C63.10:2013, KDB 789033
Limit:	Band 1: 11 dBm/MHz
Test setup:	 <p>The diagram illustrates the test setup. A Spectrum Analyzer is connected to an E.U.T. (Equipment Under Test) via a red cable. Both are placed on a Non-Conducted Table, which is supported by two vertical legs. Below the table is a Ground Reference Plane.</p>
Test Instruments:	Refer to section 5.9 for details
Test mode:	Refer to section 5.3 for details
Test results:	Passed

Measurement Data:

Band 1				
Mode	Test CH	PSD (dBm)	Limit (dBm)	Result
802.11a	Lowest	-5.70	11.00	Pass
	Middle	-5.93		
	Highest	-6.22		
802.11n(HT20)	Lowest	-6.40	11.00	Pass
	Middle	-6.73		
	Highest	-6.72		
802.11n(HT40)	Lowest	-9.17	11.00	Pass
	Highest	-9.52		
802.11ac(HT20)	Lowest	-6.46	11.00	Pass
	Middle	-6.30		
	Highest	-6.97		
802.11ac(HT40)	Lowest	-9.17	11.00	Pass
	Highest	-9.57		
802.11ac(HT80)	Middle	-12.92	11.00	Pass

Test plot as follows:

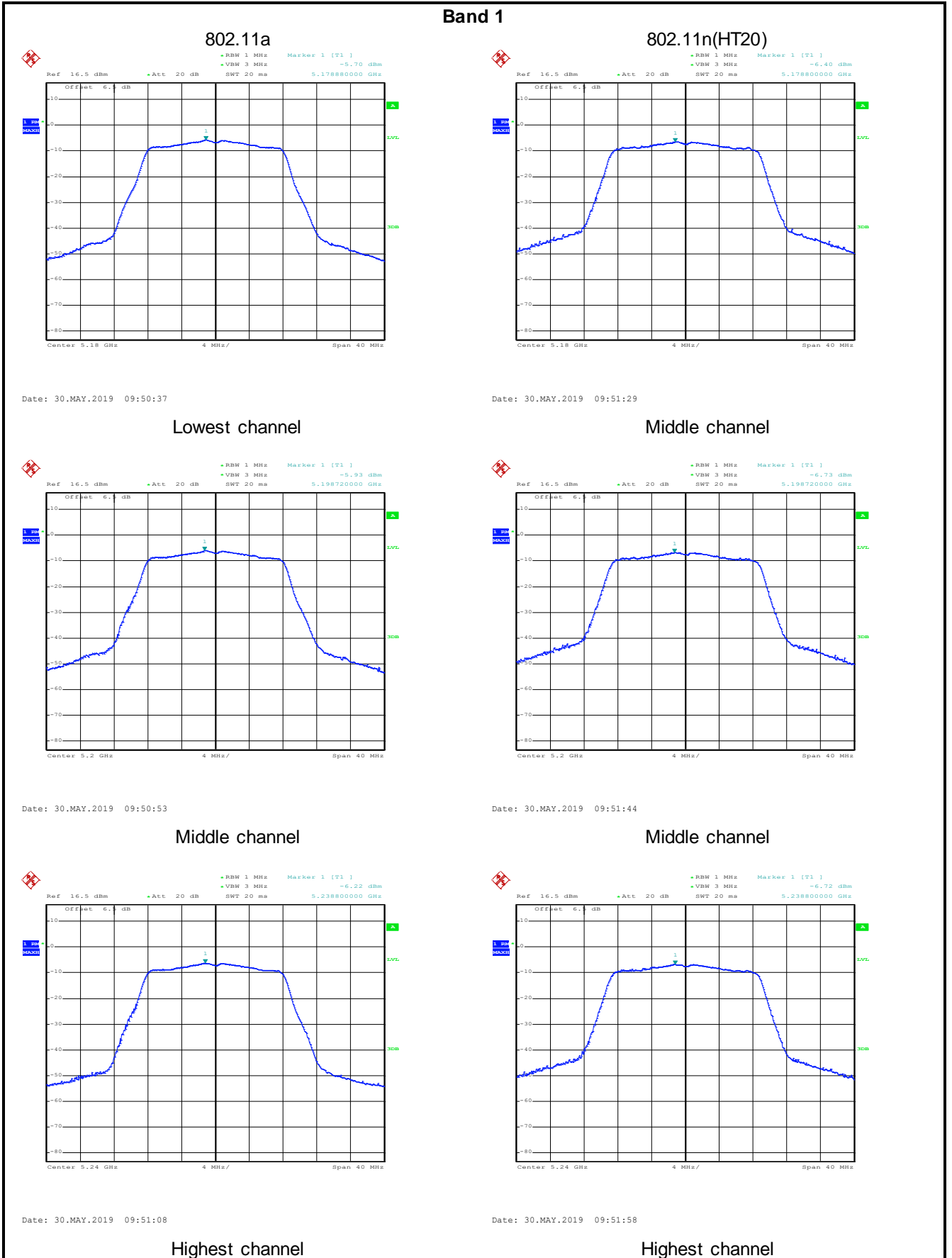

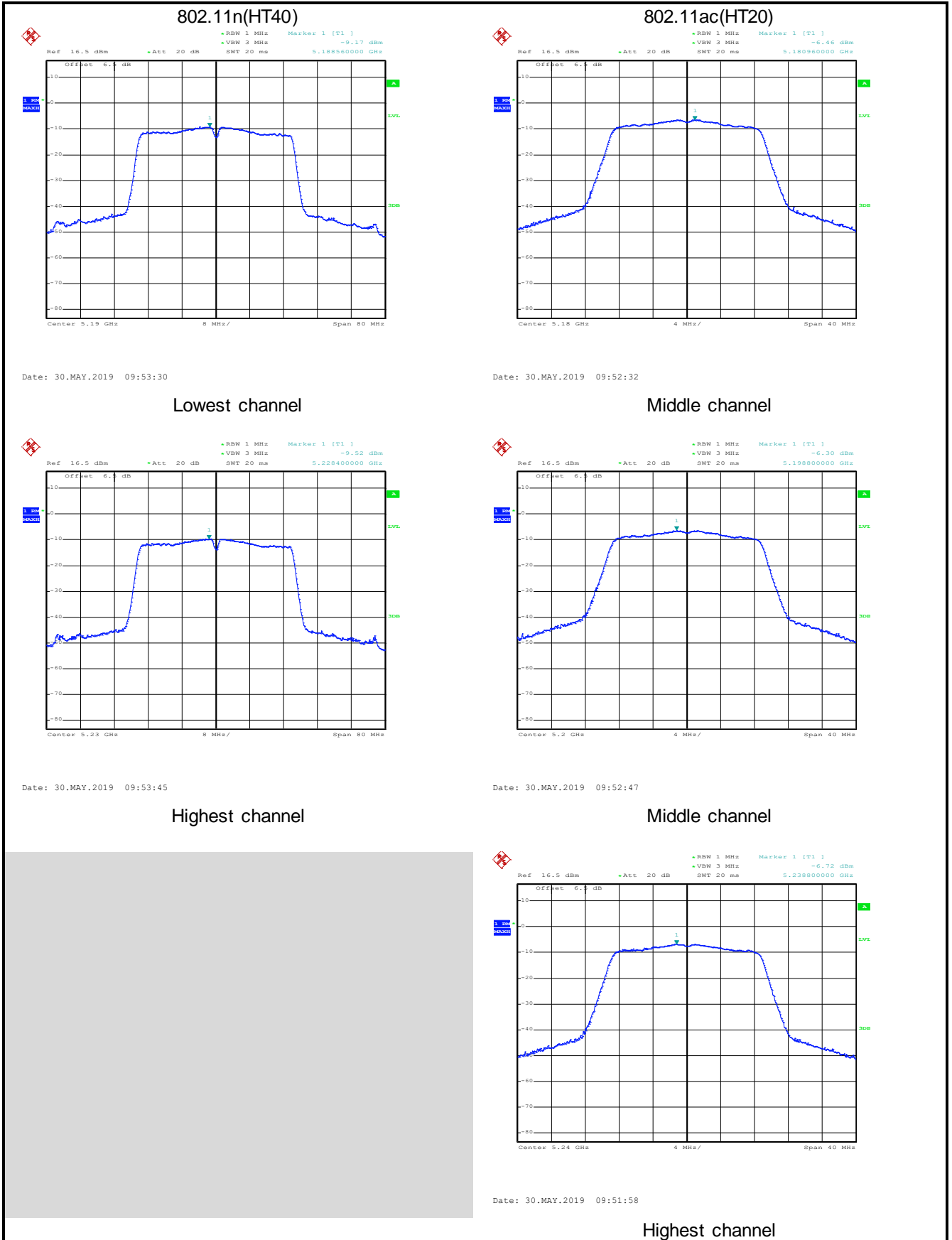

802.11ac(HT40)

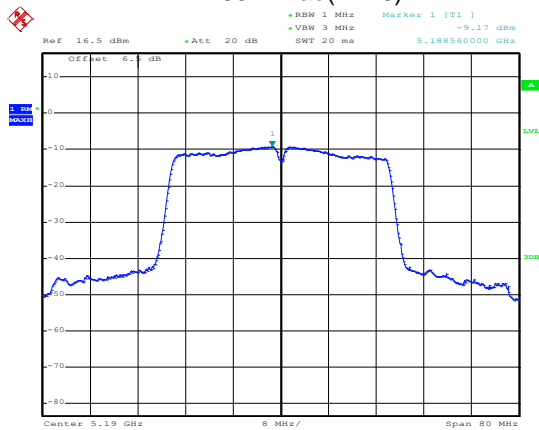

Date: 30.MAY.2019 09:54:09

Lowest channel

802.11ac(HT80)

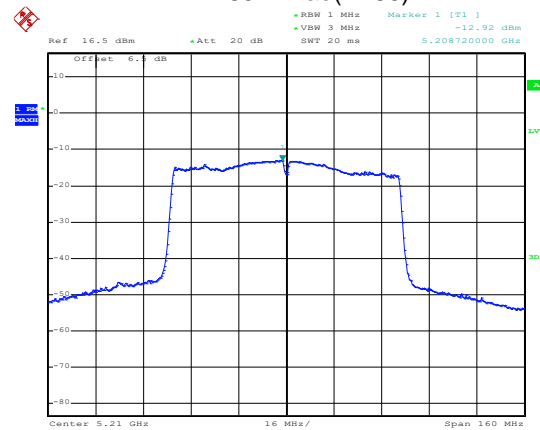

Date: 30.MAY.2019 09:54:48

Middle channel

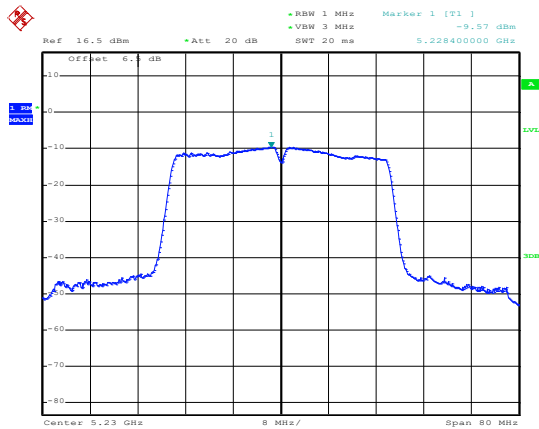

Date: 30.MAY.2019 09:54:23

Highest channel

6.6 Band Edge

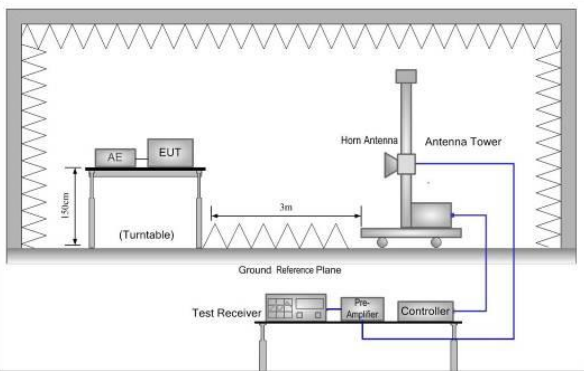
Test Requirement:	FCC Part 15 E Section 15.407 (b)			
Test Method:	ANSI C63.10:2013 , KDB 789033			
Receiver setup:	Detector	RBW	VBW	Remark
	Quasi-peak	120kHz	300kHz	Quasi-peak Value
	RMS	1MHz	3MHz	Average Value
Limit:	Band	Limit (dBuV/m @3m)		Remark
	Band 1	68.20		Peak Value
		54.00		Average Value
<p>For transmitters operating in the 5.15-5.25 GHz band: All emissions outside of the 5.15-5.35 GHz band shall not exceed an e.i.r.p. of -27 dBm/MHz.</p> <p>Remark:</p> <ol style="list-style-type: none"> Band 1 limit: $E[dB\mu V/m] = EIRP[dBm] + 95.2 = 68.2 \text{ dBuV/m}$, for $EIRP[dBm] = -27 \text{ dBm}$. 				
Test Procedure:	<ol style="list-style-type: none"> The EUT was placed on the top of a rotating table 0.8 meters above the ground at a 3 meter camber. The table was rotated 360 degrees to determine the position of the highest radiation. The EUT was set 3 meters away from the interference-receiving antenna, which was mounted on the top of a variable-height antenna tower. The antenna height is varied from one meter to four meters above the ground to determine the maximum value of the field strength. Both horizontal and vertical polarizations of the antenna are set to make the measurement. For each suspected emission, the EUT was arranged to its worst case and then the antenna was tuned to heights from 1 meter to 4 meters and the rotatable was turned from 0 degrees to 360 degrees to find the maximum reading. The test-receiver system was set to Peak Detect Function and Specified Bandwidth with Maximum Hold Mode. If the emission level of the EUT in peak mode was 10dB lower than the limit specified, then testing could be stopped and the peak values of the EUT would be reported. Otherwise the emissions that did not have 10dB margin would be re-tested one by one using peak, quasi-peak or average method as specified and then reported in a data sheet. 			
Test setup:				
Test Instruments:	Refer to section 5.9 for details			
Test mode:	Refer to section 5.3 for details			
Test results:	Passed			

Measurement Data (worst case):
Band 1:

Band 1 – 802.11a								
Test channel: Lowest channel								
Detector: Peak Value								
Frequency (MHz)	Read Level (dBuV/m)	Antenna Factor (dB)	Cable Loss (dB)	Preamp Factor (dB)	Level (dBuV/m)	Limit Line (dBuV/m)	Over Limit (dB)	Polarization
5150.00	48.93	31.77	7.05	41.93	45.82	68.20	-22.38	Horizontal
5150.00	49.12	31.77	7.05	41.93	46.01	68.20	-22.19	Vertical
Detector: Average Value								
Frequency (MHz)	Read Level (dBuV/m)	Antenna Factor (dB)	Cable Loss (dB)	Preamp Factor (dB)	Level (dBuV/m)	Limit Line (dBuV/m)	Over Limit (dB)	Polarization
5150.00	38.46	31.77	7.05	41.93	35.35	54.00	-18.65	Horizontal
5150.00	39.23	31.77	7.05	41.93	36.12	54.00	-17.88	Vertical
Test channel: Highest channel								
Detector: Peak Value								
Frequency (MHz)	Read Level (dBuV/m)	Antenna Factor (dB)	Cable Loss (dB)	Preamp Factor (dB)	Level (dBuV/m)	Limit Line (dBuV/m)	Over Limit (dB)	Polarization
5350.00	48.47	31.77	7.11	41.89	45.46	68.20	-22.74	Horizontal
5350.00	47.96	31.77	7.11	41.89	44.95	68.20	-23.25	Vertical
Detector: Average Value								
Frequency (MHz)	Read Level (dBuV/m)	Antenna Factor (dB)	Cable Loss (dB)	Preamp Factor (dB)	Level (dBuV/m)	Limit Line (dBuV/m)	Over Limit (dB)	Polarization
5350.00	38.64	31.77	7.11	41.89	35.63	54.00	-18.37	Horizontal
5350.00	39.05	31.77	7.11	41.89	36.04	54.00	-17.96	Vertical
<i>Remark:</i>								
1. <i>Final Level = Receiver Read level + Antenna Factor + Cable Loss – Preamplifier Factor.</i>								
2. <i>The emission levels of other frequencies are very lower than the limit and not show in test report.</i>								

Band 1 – 802.11n(HT20)								
Test channel: Lowest channel								
Detector: Peak								
Frequency (MHz)	Read Level (dBuV/m)	Antenna Factor (dB)	Cable Loss (dB)	Preamp Factor (dB)	Level (dBuV/m)	Limit Line (dBuV/m)	Over Limit (dB)	Polarization
5150.00	48.14	31.77	7.05	41.93	45.03	68.20	-23.17	Horizontal
5150.00	48.23	31.77	7.05	41.93	45.12	68.20	-23.08	Vertical
Detector: Average								
Frequency (MHz)	Read Level (dBuV/m)	Antenna Factor (dB)	Cable Loss (dB)	Preamp Factor (dB)	Level (dBuV/m)	Limit Line (dBuV/m)	Over Limit (dB)	Polarization
5150.00	38.67	31.77	7.05	41.93	35.56	54.00	-18.44	Horizontal
5150.00	38.53	31.77	7.05	41.93	35.42	54.00	-18.58	Vertical
Test channel: Highest channel								
Detector: Peak Value								
Frequency (MHz)	Read Level (dBuV/m)	Antenna Factor (dB)	Cable Loss (dB)	Preamp Factor (dB)	Level (dBuV/m)	Limit Line (dBuV/m)	Over Limit (dB)	Polarization
5350.00	48.53	31.77	7.11	41.89	45.52	68.20	-22.68	Horizontal
5350.00	48.59	31.77	7.11	41.89	45.58	68.20	-22.62	Vertical
Detector: Average Value								
Frequency (MHz)	Read Level (dBuV/m)	Antenna Factor (dB)	Cable Loss (dB)	Preamp Factor (dB)	Level (dBuV/m)	Limit Line (dBuV/m)	Over Limit (dB)	Polarization
5350.00	38.16	31.77	7.11	41.89	35.15	54.00	-18.85	Horizontal
5350.00	38.27	31.77	7.11	41.89	35.26	54.00	-18.74	Vertical
<i>Remark:</i>								
1. <i>Final Level= Receiver Read level + Antenna Factor + Cable Loss – Preamplifier Factor.</i>								
2. <i>The emission levels of other frequencies are very lower than the limit and not show in test report.</i>								

Band 1 – 802.11n(HT40)								
Test channel: Lowest channel								
Detector: Peak Value								
Frequency (MHz)	Read Level (dBuV/m)	Antenna Factor (dB)	Cable Loss (dB)	Preamp Factor (dB)	Level (dBuV/m)	Limit Line (dBuV/m)	Over Limit (dB)	Polarization
5150.00	49.21	31.77	7.05	41.93	46.10	68.20	-22.10	Horizontal
5150.00	49.53	31.77	7.05	41.93	46.42	68.20	-21.78	Vertical
Detector: Average Value								
Frequency (MHz)	Read Level (dBuV/m)	Antenna Factor (dB)	Cable Loss (dB)	Preamp Factor (dB)	Level (dBuV/m)	Limit Line (dBuV/m)	Over Limit (dB)	Polarization
5150.00	39.52	31.77	7.05	41.93	36.41	54.00	-17.59	Horizontal
5150.00	39.46	31.77	7.05	41.93	36.35	54.00	-17.65	Vertical
Test channel: Highest channel								
Detector: Peak Value								
Frequency (MHz)	Read Level (dBuV/m)	Antenna Factor (dB)	Cable Loss (dB)	Preamp Factor (dB)	Level (dBuV/m)	Limit Line (dBuV/m)	Over Limit (dB)	Polarization
5350.00	48.67	31.77	7.11	41.89	41.89	68.20	-26.31	Horizontal
5350.00	48.53	31.77	7.11	41.89	41.89	68.20	-26.31	Vertical
Detector: Average Value								
Frequency (MHz)	Read Level (dBuV/m)	Antenna Factor (dB)	Cable Loss (dB)	Preamp Factor (dB)	Level (dBuV/m)	Limit Line (dBuV/m)	Over Limit (dB)	Polarization
5350.00	38.91	31.77	7.11	41.89	35.90	54.00	-18.10	Horizontal
5350.00	38.36	31.77	7.11	41.89	35.35	54.00	-18.65	Vertical
<i>Remark:</i>								
1. <i>Final Level= Receiver Read level + Antenna Factor + Cable Loss – Preamplifier Factor.</i>								
2. <i>The emission levels of other frequencies are very lower than the limit and not show in test report.</i>								

Band 1 – 802.11ac(HT20)								
Test channel: Lowest channel								
Detector: Peak Value								
Frequency (MHz)	Read Level (dBuV/m)	Antenna Factor (dB)	Cable Loss (dB)	Preamp Factor (dB)	Level (dBuV/m)	Limit Line (dBuV/m)	Over Limit (dB)	Polarization
5150.00	49.22	31.77	7.05	41.93	46.11	68.20	-22.09	Horizontal
5150.00	48.78	31.77	7.05	41.93	45.67	68.20	-22.53	Vertical
Detector: Average Value								
Frequency (MHz)	Read Level (dBuV/m)	Antenna Factor (dB)	Cable Loss (dB)	Preamp Factor (dB)	Level (dBuV/m)	Limit Line (dBuV/m)	Over Limit (dB)	Polarization
5150.00	39.12	31.77	7.05	41.93	36.01	54.00	-17.99	Horizontal
5150.00	38.36	31.77	7.05	41.93	35.25	54.00	-18.75	Vertical
Test channel: Highest channel								
Detector: Peak Value								
Frequency (MHz)	Read Level (dBuV/m)	Antenna Factor (dB)	Cable Loss (dB)	Preamp Factor (dB)	Level (dBuV/m)	Limit Line (dBuV/m)	Over Limit (dB)	Polarization
5350.00	48.74	31.77	7.11	41.89	45.73	68.20	-22.47	Horizontal
5350.00	48.53	31.77	7.11	41.89	45.52	68.20	-22.68	Vertical
Detector: Average Value								
Frequency (MHz)	Read Level (dBuV/m)	Antenna Factor (dB)	Cable Loss (dB)	Preamp Factor (dB)	Level (dBuV/m)	Limit Line (dBuV/m)	Over Limit (dB)	Polarization
5350.00	38.46	31.77	7.11	41.89	35.45	54.00	-18.55	Horizontal
5350.00	38.91	31.77	7.11	41.89	35.90	54.00	-18.10	Vertical
<i>Remark:</i>								
1. <i>Final Level= Receiver Read level + Antenna Factor + Cable Loss – Preamplifier Factor.</i>								
2. <i>The emission levels of other frequencies are very lower than the limit and not show in test report.</i>								

Band 1 – 802.11ac(HT40)								
Test channel: Lowest channel								
Detector: Peak Value								
Frequency (MHz)	Read Level (dBuV/m)	Antenna Factor (dB)	Cable Loss (dB)	Preamp Factor (dB)	Level (dBuV/m)	Limit Line (dBuV/m)	Over Limit (dB)	Polarization
5150.00	49.52	31.77	7.05	41.93	46.41	68.20	-21.79	Horizontal
5150.00	48.37	31.77	7.05	41.93	45.26	68.20	-22.94	Vertical
Detector: Average Value								
Frequency (MHz)	Read Level (dBuV/m)	Antenna Factor (dB)	Cable Loss (dB)	Preamp Factor (dB)	Level (dBuV/m)	Limit Line (dBuV/m)	Over Limit (dB)	Polarization
5150.00	39.53	31.77	7.05	41.93	36.42	54.00	-17.58	Horizontal
5150.00	38.14	31.77	7.05	41.93	35.03	54.00	-18.97	Vertical
Test channel: Highest channel								
Detector: Peak Value								
Frequency (MHz)	Read Level (dBuV/m)	Antenna Factor (dB)	Cable Loss (dB)	Preamp Factor (dB)	Level (dBuV/m)	Limit Line (dBuV/m)	Over Limit (dB)	Polarization
5350.00	48.53	31.77	7.11	41.89	45.52	68.20	-22.68	Horizontal
5350.00	48.36	31.77	7.11	41.89	45.35	68.20	-22.85	Vertical
Detector: Average Value								
Frequency (MHz)	Read Level (dBuV/m)	Antenna Factor (dB)	Cable Loss (dB)	Preamp Factor (dB)	Level (dBuV/m)	Limit Line (dBuV/m)	Over Limit (dB)	Polarization
5350.00	38.23	31.77	7.11	41.89	35.22	54.00	-18.78	Horizontal
5350.00	38.09	31.77	7.11	41.89	35.08	54.00	-18.92	Vertical
<i>Remark:</i>								
1. <i>Final Level= Receiver Read level + Antenna Factor + Cable Loss – Preamplifier Factor.</i>								
2. <i>The emission levels of other frequencies are very lower than the limit and not show in test report.</i>								

Band 1 – 802.11ac(HT80)								
Test channel: Lowest channel								
Detector: Peak Value								
Frequency (MHz)	Read Level (dBuV/m)	Antenna Factor (dB)	Cable Loss (dB)	Preamp Factor (dB)	Level (dBuV/m)	Limit Line (dBuV/m)	Over Limit (dB)	Polarization
5150.00	49.64	31.77	7.05	41.93	46.53	68.20	-21.67	Horizontal
5150.00	49.48	31.77	7.05	41.93	46.37	68.20	-21.83	Vertical
Detector: Average Value								
Frequency (MHz)	Read Level (dBuV/m)	Antenna Factor (dB)	Cable Loss (dB)	Preamp Factor (dB)	Level (dBuV/m)	Limit Line (dBuV/m)	Over Limit (dB)	Polarization
5150.00	40.03	31.77	7.05	41.93	36.92	54.00	-17.08	Horizontal
5150.00	40.11	31.77	7.05	41.93	37.00	54.00	-17.00	Vertical
Test channel: Highest channel								
Detector: Peak Value								
Frequency (MHz)	Read Level (dBuV/m)	Antenna Factor (dB)	Cable Loss (dB)	Preamp Factor (dB)	Level (dBuV/m)	Limit Line (dBuV/m)	Over Limit (dB)	Polarization
5350.00	48.30	31.77	7.11	41.89	41.89	68.20	-26.31	Horizontal
5350.00	48.08	31.77	7.11	41.89	41.89	68.20	-26.31	Vertical
Detector: Average Value								
Frequency (MHz)	Read Level (dBuV/m)	Antenna Factor (dB)	Cable Loss (dB)	Preamp Factor (dB)	Level (dBuV/m)	Limit Line (dBuV/m)	Over Limit (dB)	Polarization
5350.00	38.24	31.77	7.11	41.89	35.23	54.00	-18.77	Horizontal
5350.00	38.16	31.77	7.11	41.89	35.15	54.00	-18.85	Vertical
<i>Remark:</i>								
1. <i>Final Level = Receiver Read level + Antenna Factor + Cable Loss – Pre-amplifier Factor.</i>								
2. <i>The emission levels of other frequencies are very lower than the limit and not show in test report.</i>								

6.7 Spurious Emission

6.7.1 Restricted Band

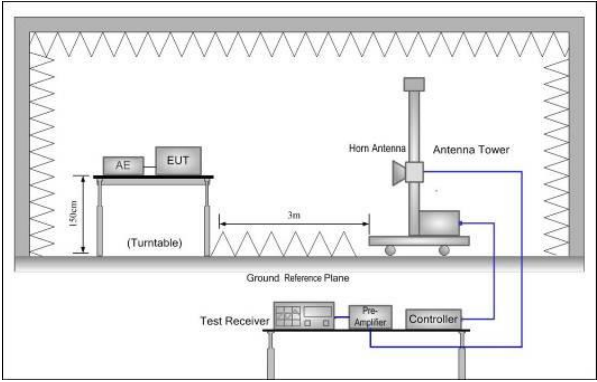
Test Requirement:	FCC Part15 E Section 15.407(b)				
Test Method:	ANSI C63.10: 2013				
Test Frequency Range:	4.5 GHz to 5.15 GHz and 5.35GHz to 5.46GHz				
Test site:	Measurement Distance: 3m				
Receiver setup:	Frequency	Detector	RBW	VBW	Remark
	Above 1GHz	Peak	1MHz	3MHz	Peak Value
RMS		1MHz	3MHz	Average Value	
Limit:	Frequency	Limit (dBuV/m @3m)			Remark
	Above 1GHz	74.00			Peak Value
54.00			Average Value		
Test Procedure:	<ol style="list-style-type: none"> The EUT was placed on the top of a rotating table 1.5 meters above the ground at a 3 meter camber. The table was rotated 360 degrees to determine the position of the highest radiation. The EUT was set 3 meters away from the interference-receiving antenna, which was mounted on the top of a variable-height antenna tower. The antenna height is varied from one meter to four meters above the ground to determine the maximum value of the field strength. Both horizontal and vertical polarizations of the antenna are set to make the measurement. For each suspected emission, the EUT was arranged to its worst case and then the antenna was tuned to heights from 1 meter to 4 meters and the rota table was turned from 0 degrees to 360 degrees to find the maximum reading. The test-receiver system was set to Peak Detect Function and Specified Bandwidth with Maximum Hold Mode. If the emission level of the EUT in peak mode was 10dB lower than the limit specified, then testing could be stopped and the peak values of the EUT would be reported. Otherwise the emissions that did not have 10dB margin would be re-tested one by one using peak, quasi-peak or average method as specified and then reported in a data sheet. 				
Test setup:					
Test Instruments:	Refer to section 5.9 for details				
Test mode:	Refer to section 5.3 for details				
Test results:	Passed				

Measurement Data (worst case):
Band 1:

Band 1 – 802.11a								
Test channel: Lowest channel								
Detector: Peak Value								
Frequency (MHz)	Read Level (dBuV/m)	Antenna Factor (dB)	Cable Loss (dB)	Preamp Factor (dB)	Level (dBuV/m)	Limit Line (dBuV/m)	Over Limit (dB)	Polarization
4500.00	48.36	34.50	6.80	42.05	47.61	74.00	-26.39	Horizontal
4500.00	48.13	34.50	6.80	42.05	47.38	74.00	-26.62	Vertical
Detector: Average Value								
Frequency (MHz)	Read Level (dBuV/m)	Antenna Factor (dB)	Cable Loss (dB)	Preamp Factor (dB)	Level (dBuV/m)	Limit Line (dBuV/m)	Over Limit (dB)	Polarization
4500.00	38.43	34.50	6.80	42.05	37.68	54.00	-16.32	Horizontal
4500.00	39.10	34.50	6.80	42.05	38.35	54.00	-15.65	Vertical
Test channel: Highest channel								
Detector: Peak Value								
Frequency (MHz)	Read Level (dBuV/m)	Antenna Factor (dB)	Cable Loss (dB)	Preamp Factor (dB)	Level (dBuV/m)	Limit Line (dBuV/m)	Over Limit (dB)	Polarization
5460.00	39.06	34.90	7.18	41.85	39.29	74.00	-34.71	Horizontal
5460.00	38.67	34.90	7.18	41.85	38.90	74.00	-35.10	Vertical
Detector: Average Value								
Frequency (MHz)	Read Level (dBuV/m)	Antenna Factor (dB)	Cable Loss (dB)	Preamp Factor (dB)	Level (dBuV/m)	Limit Line (dBuV/m)	Over Limit (dB)	Polarization
5460.00	38.47	34.90	7.18	41.85	38.70	54.00	-15.30	Horizontal
5460.00	38.64	34.90	7.18	41.85	38.87	54.00	-15.13	Vertical
Remark:								
1. <i>Final Level = Receiver Read level + Antenna Factor + Cable Loss – Preamplifier Factor.</i>								
2. <i>The emission levels of other frequencies are very lower than the limit and not show in test report.</i>								

Band 1 – 802.11n(HT20)								
Test channel: Lowest channel								
Detector: Peak Value								
Frequency (MHz)	Read Level (dBuV/m)	Antenna Factor (dB)	Cable Loss (dB)	Preamp Factor (dB)	Level (dBuV/m)	Limit Line (dBuV/m)	Over Limit (dB)	Polarization
4500.00	48.89	34.50	6.80	42.05	48.14	74.00	-25.86	Horizontal
4500.00	48.34	34.50	6.80	42.05	47.59	74.00	-26.41	Vertical
Detector: Average Value								
Frequency (MHz)	Read Level (dBuV/m)	Antenna Factor (dB)	Cable Loss (dB)	Preamp Factor (dB)	Level (dBuV/m)	Limit Line (dBuV/m)	Over Limit (dB)	Polarization
4500.00	38.16	34.50	6.80	42.05	37.41	54.00	-16.59	Horizontal
4500.00	38.06	34.50	6.80	42.05	37.31	54.00	-16.69	Vertical
Test channel: Highest channel								
Detector: Peak Value								
Frequency (MHz)	Read Level (dBuV/m)	Antenna Factor (dB)	Cable Loss (dB)	Preamp Factor (dB)	Level (dBuV/m)	Limit Line (dBuV/m)	Over Limit (dB)	Polarization
5460.00	49.11	34.90	7.18	41.85	49.34	74.00	-24.66	Horizontal
5460.00	48.45	34.90	7.18	41.85	48.68	74.00	-25.32	Vertical
Detector: Average Value								
Frequency (MHz)	Read Level (dBuV/m)	Antenna Factor (dB)	Cable Loss (dB)	Preamp Factor (dB)	Level (dBuV/m)	Limit Line (dBuV/m)	Over Limit (dB)	Polarization
5460.00	39.06	34.90	7.18	41.85	39.29	54.00	-14.71	Horizontal
5460.00	38.06	34.90	7.18	41.85	38.29	54.00	-15.71	Vertical
Remark:								
1. <i>Final Level = Receiver Read level + Antenna Factor + Cable Loss – Preamplifier Factor.</i>								
2. <i>The emission levels of other frequencies are very lower than the limit and not show in test report.</i>								

Band 1 – 802.11n(HT40)								
Test channel: Lowest channel								
Detector: Peak Value								
Frequency (MHz)	Read Level (dBuV/m)	Antenna Factor (dB)	Cable Loss (dB)	Preamp Factor (dB)	Level (dBuV/m)	Limit Line (dBuV/m)	Over Limit (dB)	Polarization
4500.00	49.26	34.50	6.80	42.05	48.51	74.00	-25.49	Horizontal
4500.00	49.34	34.50	6.80	42.05	48.59	74.00	-25.41	Vertical
Detector: Average Value								
Frequency (MHz)	Read Level (dBuV/m)	Antenna Factor (dB)	Cable Loss (dB)	Preamp Factor (dB)	Level (dBuV/m)	Limit Line (dBuV/m)	Over Limit (dB)	Polarization
4500.00	38.21	34.50	6.80	42.05	37.46	54.00	-16.54	Horizontal
4500.00	39.53	34.50	6.80	42.05	38.78	54.00	-15.22	Vertical
Test channel: Highest channel								
Detector: Peak Value								
Frequency (MHz)	Read Level (dBuV/m)	Antenna Factor (dB)	Cable Loss (dB)	Preamp Factor (dB)	Level (dBuV/m)	Limit Line (dBuV/m)	Over Limit (dB)	Polarization
5460.00	48.17	34.90	7.18	41.85	48.40	74.00	-25.60	Horizontal
5460.00	48.29	34.90	7.18	41.85	48.52	74.00	-25.48	Vertical
Detector: Average Value								
Frequency (MHz)	Read Level (dBuV/m)	Antenna Factor (dB)	Cable Loss (dB)	Preamp Factor (dB)	Level (dBuV/m)	Limit Line (dBuV/m)	Over Limit (dB)	Polarization
5460.00	38.64	34.90	7.18	41.85	38.87	54.00	-15.13	Horizontal
5460.00	38.32	34.90	7.18	41.85	38.55	54.00	-15.45	Vertical
Remark:								
1. <i>Final Level = Receiver Read level + Antenna Factor + Cable Loss – Preamplifier Factor.</i>								
2. <i>The emission levels of other frequencies are very lower than the limit and not show in test report.</i>								

Band 1 – 802.11ac(HT20)								
Test channel: Lowest channel								
Detector: Peak Value								
Frequency (MHz)	Read Level (dBuV/m)	Antenna Factor (dB)	Cable Loss (dB)	Preamp Factor (dB)	Level (dBuV/m)	Limit Line (dBuV/m)	Over Limit (dB)	Polarization
4500.00	48.71	34.50	6.80	42.05	47.96	74.00	-26.04	Horizontal
4500.00	47.14	34.50	6.80	42.05	46.39	74.00	-27.61	Vertical
Detector: Average Value								
Frequency (MHz)	Read Level (dBuV/m)	Antenna Factor (dB)	Cable Loss (dB)	Preamp Factor (dB)	Level (dBuV/m)	Limit Line (dBuV/m)	Over Limit (dB)	Polarization
4500.00	38.39	34.50	6.80	42.05	37.64	54.00	-16.36	Horizontal
4500.00	37.98	34.50	6.80	42.05	37.23	54.00	-16.77	Vertical
Test channel: Highest channel								
Detector: Peak Value								
Frequency (MHz)	Read Level (dBuV/m)	Antenna Factor (dB)	Cable Loss (dB)	Preamp Factor (dB)	Level (dBuV/m)	Limit Line (dBuV/m)	Over Limit (dB)	Polarization
5460.00	48.79	34.90	7.18	41.85	49.02	74.00	-24.98	Horizontal
5460.00	48.73	34.90	7.18	41.85	48.96	74.00	-25.04	Vertical
Detector: Average Value								
Frequency (MHz)	Read Level (dBuV/m)	Antenna Factor (dB)	Cable Loss (dB)	Preamp Factor (dB)	Level (dBuV/m)	Limit Line (dBuV/m)	Over Limit (dB)	Polarization
5460.00	38.24	34.90	7.18	41.85	38.47	54.00	-15.53	Horizontal
5460.00	38.26	34.90	7.18	41.85	38.49	54.00	-15.51	Vertical
Remark:								
1. <i>Final Level = Receiver Read level + Antenna Factor + Cable Loss – Preamplifier Factor.</i>								
2. <i>The emission levels of other frequencies are very lower than the limit and not show in test report.</i>								

Band 1 – 802.11ac(HT40)								
Test channel: Lowest channel								
Detector: Peak Value								
Frequency (MHz)	Read Level (dBuV/m)	Antenna Factor (dB)	Cable Loss (dB)	Preamp Factor (dB)	Level (dBuV/m)	Limit Line (dBuV/m)	Over Limit (dB)	Polarization
4500.00	48.16	34.50	6.80	42.05	47.41	74.00	-26.59	Horizontal
4500.00	48.67	34.50	6.80	42.05	47.92	74.00	-26.08	Vertical
Detector: Average Value								
Frequency (MHz)	Read Level (dBuV/m)	Antenna Factor (dB)	Cable Loss (dB)	Preamp Factor (dB)	Level (dBuV/m)	Limit Line (dBuV/m)	Over Limit (dB)	Polarization
4500.00	38.49	34.50	6.80	42.05	37.74	54.00	-16.26	Horizontal
4500.00	38.62	34.50	6.80	42.05	37.87	54.00	-16.13	Vertical
Test channel: Highest channel								
Detector: Peak Value								
Frequency (MHz)	Read Level (dBuV/m)	Antenna Factor (dB)	Cable Loss (dB)	Preamp Factor (dB)	Level (dBuV/m)	Limit Line (dBuV/m)	Over Limit (dB)	Polarization
5460.00	48.89	34.90	7.18	41.85	49.12	74.00	-24.88	Horizontal
5460.00	48.71	34.90	7.18	41.85	48.94	74.00	-25.06	Vertical
Detector: Average Value								
Frequency (MHz)	Read Level (dBuV/m)	Antenna Factor (dB)	Cable Loss (dB)	Preamp Factor (dB)	Level (dBuV/m)	Limit Line (dBuV/m)	Over Limit (dB)	Polarization
5460.00	38.25	34.90	7.18	41.85	38.48	54.00	-15.52	Horizontal
5460.00	38.19	34.90	7.18	41.85	38.42	54.00	-15.58	Vertical
Remark:								
1. <i>Final Level = Receiver Read level + Antenna Factor + Cable Loss – Preamplifier Factor.</i>								
2. <i>The emission levels of other frequencies are very lower than the limit and not show in test report.</i>								

Band 1 – 802.11ac(HT80)								
Test channel: Lowest channel								
Detector: Peak Value								
Frequency (MHz)	Read Level (dBuV/m)	Antenna Factor (dB)	Cable Loss (dB)	Preamp Factor (dB)	Level (dBuV/m)	Limit Line (dBuV/m)	Over Limit (dB)	Polarization
4500.00	48.26	34.50	6.80	42.05	47.51	74.00	-26.49	Horizontal
4500.00	48.76	34.50	6.80	42.05	48.01	74.00	-25.99	Vertical
Detector: Average Value								
Frequency (MHz)	Read Level (dBuV/m)	Antenna Factor (dB)	Cable Loss (dB)	Preamp Factor (dB)	Level (dBuV/m)	Limit Line (dBuV/m)	Over Limit (dB)	Polarization
4500.00	38.06	34.50	6.80	42.05	37.31	54.00	-16.69	Horizontal
4500.00	38.34	34.50	6.80	42.05	37.59	54.00	-16.41	Vertical
Test channel: Highest channel								
Detector: Peak Value								
Frequency (MHz)	Read Level (dBuV/m)	Antenna Factor (dB)	Cable Loss (dB)	Preamp Factor (dB)	Level (dBuV/m)	Limit Line (dBuV/m)	Over Limit (dB)	Polarization
5460.00	49.52	34.90	7.18	41.85	49.75	74.00	-24.25	Horizontal
5460.00	49.13	34.90	7.18	41.85	49.36	74.00	-24.64	Vertical
Detector: Average Value								
Frequency (MHz)	Read Level (dBuV/m)	Antenna Factor (dB)	Cable Loss (dB)	Preamp Factor (dB)	Level (dBuV/m)	Limit Line (dBuV/m)	Over Limit (dB)	Polarization
5460.00	39.16	34.90	7.18	41.85	39.39	54.00	-14.61	Horizontal
5460.00	39.03	34.90	7.18	41.85	39.26	54.00	-14.74	Vertical
Remark:								
1. <i>Final Level = Receiver Read level + Antenna Factor + Cable Loss – Preamplifier Factor.</i>								
2. <i>The emission levels of other frequencies are very lower than the limit and not show in test report.</i>								

6.7.2 Unwanted Emissions out of the Restricted Bands

Test Requirement:	FCC Part15 C Section 15.209 and 15.205				
Test Method:	ANSI C63.10: 2013				
Test Frequency Range:	30MHz to 40GHz				
Test site:	Measurement Distance: 3m				
Receiver setup:	Frequency	Detector	RBW	VBW	Remark
	30MHz-1GHz	Quasi-peak	100kHz	300kHz	Quasi-peak Value
	Above 1GHz	Peak	1MHz	3MHz	Peak Value
RMS		1MHz	3MHz	Average Value	
Limit:	Frequency	Limit (dBuV/m @3m)		Remark	
	30MHz-88MHz	40.0		Quasi-peak Value	
	88MHz-216MHz	43.5		Quasi-peak Value	
	216MHz-960MHz	46.0		Quasi-peak Value	
	Above 1GHz	68.20		Peak Value	
		54.00		Average Value	
<i>Remark:</i> <i>Above 1GHz limit:</i> $E[dB\mu V/m] = EIRP[dBm] + 95.2 = 68.2 \text{ dBuV/m, for } EIPR[dBm] = -27 \text{ dBm.}$					
Test Procedure:	<ol style="list-style-type: none"> The EUT was placed on the top of a rotating table 0.8m(below 1GHz)/1.5m(above 1GHz) above the ground at a 3 meter camber. The table was rotated 360 degrees to determine the position of the highest radiation. The EUT was set 3 meters away from the interference-receiving antenna, which was mounted on the top of a variable-height antenna tower. The antenna height is varied from one meter to four meters above the ground to determine the maximum value of the field strength. Both horizontal and vertical polarizations of the antenna are set to make the measurement. For each suspected emission, the EUT was arranged to its worst case and then the antenna was tuned to heights from 1 meter to 4 meters and the rota table was turned from 0 degrees to 360 degrees to find the maximum reading. The test-receiver system was set to Peak Detect Function and Specified Bandwidth with Maximum Hold Mode. If the emission level of the EUT in peak mode was 10dB lower than the limit specified, then testing could be stopped and the peak values of the EUT would be reported. Otherwise the emissions that did not have 10dB margin would be re-tested one by one using peak, quasi-peak or average method as specified and then reported in a data sheet. 				
Test setup:	Below 1GHz				
Above 1GHz					

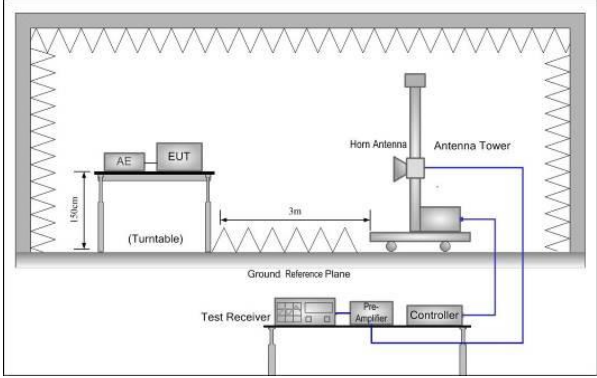
	
<p>Test Instruments:</p>	<p>Refer to section 5.9 for details</p>
<p>Test mode:</p>	<p>Refer to section 5.3 for details</p>
<p>Test results:</p>	<p>Passed</p>

Measurement Data (worst case):

Below 1GHz

Product Name:	Tablet PC	Product Model:	APRIX TAB8II
Test By:	Mike	Test mode:	5G Wi-Fi Tx mode
Test Frequency:	30 MHz ~ 1 GHz	Polarization:	Vertical
Test Voltage:	AC 120/60Hz	Environment:	Temp:24℃ Huni:57%

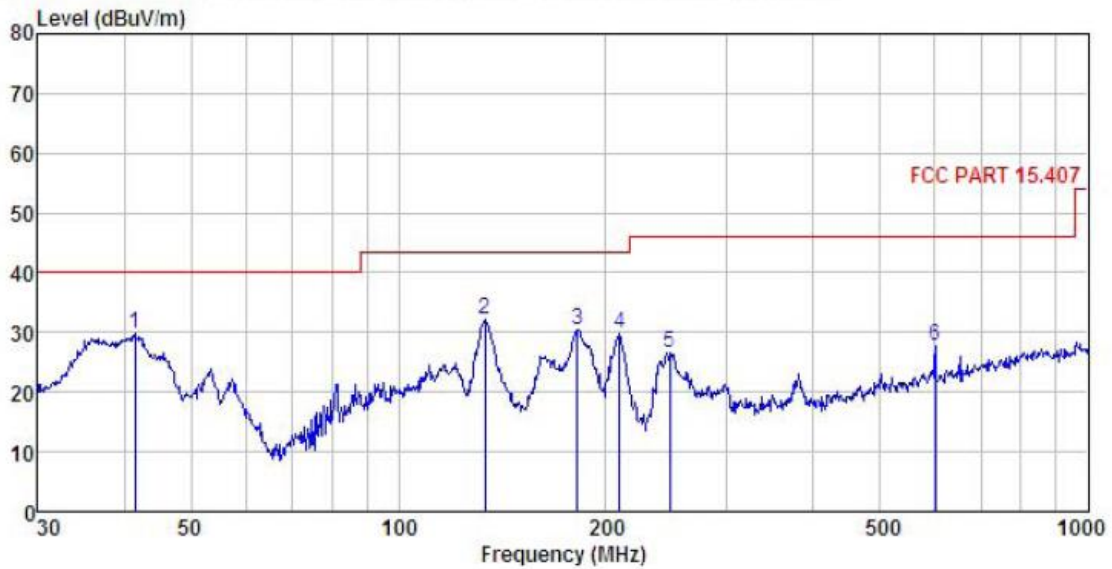

	ReadAntenna	Cable Preamp	Limit	Over					
Freq	Level	Factor	Loss	Factor	Level				
MHz	dBuV	dB/m	dB	dB	dBuV/m				
1	41.422	46.00	12.37	1.24	29.89	29.72	40.00	-10.28	QP
2	133.619	49.25	9.91	2.33	29.31	32.18	43.50	-11.32	QP
3	181.920	46.62	10.03	2.74	28.96	30.43	43.50	-13.07	QP
4	209.313	44.55	11.04	2.86	28.77	29.68	43.50	-13.82	QP
5	247.682	39.83	12.62	2.81	28.55	26.71	46.00	-19.29	QP
6	601.427	33.12	19.51	3.94	28.93	27.64	46.00	-18.36	QP

Remark:

- Final Level = Receiver Read level + Antenna Factor + Cable Loss - Preamplifier Factor.
- The emission levels of other frequencies are very lower than the limit and not show in test report.

Product Name:	Tablet PC	Product Model:	APRIX TAB8II
Test By:	Mike	Test mode:	5G Wi-Fi Tx mode
Test Frequency:	30 MHz ~ 1 GHz	Polarization:	Horizontal
Test Voltage:	AC 120/60Hz	Environment:	Temp:24℃ Huni:57%

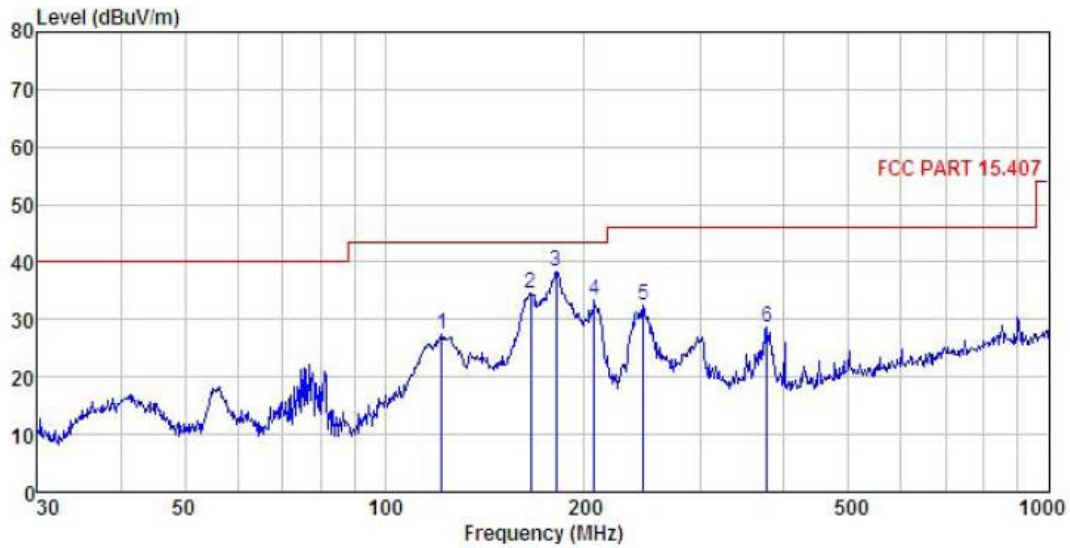

	ReadAntenna	Cable Preamp	Limit	Over				
Freq	Level	Factor	Loss	Factor	Level	Line	Limit	Remark
-----	-----	-----	-----	-----	-----	-----	-----	-----
MHz	dBuV	dB/m	dB	dB	dBuV/m	dBuV/m	dB	
1	121.976	43.77	10.74	2.19	29.38	27.32	43.50	-16.18 QP
2	166.068	51.54	9.49	2.63	29.08	34.58	43.50	-8.92 QP
3	181.283	54.67	10.01	2.74	28.96	38.46	43.50	-5.04 QP
4	207.123	48.41	10.92	2.86	28.78	33.41	43.50	-10.09 QP
5	245.090	45.69	12.50	2.82	28.57	32.44	46.00	-13.56 QP
6	377.259	39.09	14.99	3.09	28.68	28.49	46.00	-17.51 QP

Remark:

1. Final Level= Receiver Read level + Antenna Factor + Cable Loss – Preamplifier Factor.
2. The emission levels of other frequencies are very lower than the limit and not show in test report.

Above 1GHz:
Band 1:

Band 1 – 802.11a								
Test channel: Lowest channel								
Detector: Peak Value								
Frequency (MHz)	Read Level (dBuV)	Antenna Factor (dB/m)	Cable Loss (dB)	Preamp Factor (dB)	Level (dBuV/m)	Limit Line (dBuV/m)	Over Limit (dB)	Polarization
10360.00	48.39	40.10	9.82	41.97	56.34	68.20	-11.86	Vertical
10360.00	48.16	40.10	9.82	41.97	56.11	68.20	-12.09	Horizontal
Detector: Average Value								
Frequency (MHz)	Read Level (dBuV)	Antenna Factor (dB/m)	Cable Loss (dB)	Preamp Factor (dB)	Level (dBuV/m)	Limit Line (dBuV/m)	Over Limit (dB)	Polarization
10360.00	38.67	40.10	9.82	41.97	46.62	54.00	-7.38	Vertical
10360.00	38.49	40.10	9.82	41.97	46.44	54.00	-7.56	Horizontal
Test channel: Middle channel								
Detector: Peak Value								
Frequency (MHz)	Read Level (dBuV)	Antenna Factor (dB/m)	Cable Loss (dB)	Preamp Factor (dB)	Level (dBuV/m)	Limit Line (dBuV/m)	Over Limit (dB)	Polarization
10400.00	48.72	40.00	9.85	41.95	56.62	68.20	-11.58	Vertical
10400.00	48.43	40.00	9.85	41.95	56.33	68.20	-11.87	Horizontal
Detector: Average Value								
Frequency (MHz)	Read Level (dBuV)	Antenna Factor (dB/m)	Cable Loss (dB)	Preamp Factor (dB)	Level (dBuV/m)	Limit Line (dBuV/m)	Over Limit (dB)	Polarization
10400.00	38.71	40.00	9.85	41.95	46.61	54.00	-7.39	Vertical
10400.00	38.96	40.00	9.85	41.95	46.86	54.00	-7.14	Horizontal
Test channel: Highest channel								
Detector: Peak Value								
Frequency (MHz)	Read Level (dBuV)	Antenna Factor (dB/m)	Cable Loss (dB)	Preamp Factor (dB)	Level (dBuV/m)	Limit Line (dBuV/m)	Over Limit (dB)	Polarization
10480.00	48.93	39.70	9.96	41.88	56.71	68.20	-11.49	Vertical
10480.00	49.67	39.70	9.96	41.88	57.45	68.20	-10.75	Horizontal
Detector: Average Value								
Frequency (MHz)	Read Level (dBuV)	Antenna Factor (dB/m)	Cable Loss (dB)	Preamp Factor (dB)	Level (dBuV/m)	Limit Line (dBuV/m)	Over Limit (dB)	Polarization
10480.00	39.12	39.70	9.96	41.88	46.90	54.00	-7.10	Vertical
10480.00	39.23	39.70	9.96	41.88	47.01	54.00	-6.99	Horizontal
Remark:								
1. <i>Final Level = Receiver Read level + Antenna Factor + Cable Loss – Pre-amplifier Factor.</i>								
2. <i>The emission levels of other frequencies are very lower than the limit and not show in test report.</i>								

Band 1 – 802.11n(HT20)								
Test channel: Lowest channel								
Detector: Peak Value								
Frequency (MHz)	Read Level (dBuV)	Antenna Factor (dB/m)	Cable Loss (dB)	Preamp Factor (dB)	Level (dBuV/m)	Limit Line (dBuV/m)	Over Limit (dB)	Polarization
10360.00	49.16	40.10	9.82	41.97	57.11	68.20	-11.09	Vertical
10360.00	49.07	40.10	9.82	41.97	57.02	68.20	-11.18	Horizontal
Detector: Average Value								
Frequency (MHz)	Read Level (dBuV)	Antenna Factor (dB/m)	Cable Loss (dB)	Preamp Factor (dB)	Level (dBuV/m)	Limit Line (dBuV/m)	Over Limit (dB)	Polarization
10360.00	38.67	40.10	9.82	41.97	46.62	54.00	-7.38	Vertical
10360.00	38.49	40.10	9.82	41.97	46.44	54.00	-7.56	Horizontal
Test channel: Middle channel								
Detector: Peak Value								
Frequency (MHz)	Read Level (dBuV)	Antenna Factor (dB/m)	Cable Loss (dB)	Preamp Factor (dB)	Level (dBuV/m)	Limit Line (dBuV/m)	Over Limit (dB)	Polarization
10400.00	48.37	40.00	9.85	41.95	56.27	68.20	-11.93	Vertical
10400.00	48.26	40.00	9.85	41.95	56.16	68.20	-12.04	Horizontal
Detector: Average Value								
Frequency (MHz)	Read Level (dBuV)	Antenna Factor (dB/m)	Cable Loss (dB)	Preamp Factor (dB)	Level (dBuV/m)	Limit Line (dBuV/m)	Over Limit (dB)	Polarization
10400.00	38.30	40.00	9.85	41.95	46.20	54.00	-7.80	Vertical
10400.00	38.13	40.00	9.85	41.95	46.03	54.00	-7.97	Horizontal
Test channel: Highest channel								
Detector: Peak Value								
Frequency (MHz)	Read Level (dBuV)	Antenna Factor (dB/m)	Cable Loss (dB)	Preamp Factor (dB)	Level (dBuV/m)	Limit Line (dBuV/m)	Over Limit (dB)	Polarization
10480.00	48.37	39.70	9.96	41.88	56.15	68.20	-12.05	Vertical
10480.00	49.43	39.70	9.96	41.88	57.21	68.20	-10.99	Horizontal
Detector: Average Value								
Frequency (MHz)	Read Level (dBuV)	Antenna Factor (dB/m)	Cable Loss (dB)	Preamp Factor (dB)	Level (dBuV/m)	Limit Line (dBuV/m)	Over Limit (dB)	Polarization
10480.00	38.32	39.70	9.96	41.88	46.10	54.00	-7.90	Vertical
10480.00	39.05	39.70	9.96	41.88	46.83	54.00	-7.17	Horizontal
Remark:								
1. Final Level = Receiver Read level + Antenna Factor + Cable Loss – Pre-amplifier Factor.								
2. The emission levels of other frequencies are very lower than the limit and not show in test report.								

Band 1 – 802.11n(HT40)								
Test channel: Lowest channel								
Detector: Peak Value								
Frequency (MHz)	Read Level (dBuV)	Antenna Factor (dB/m)	Cable Loss (dB)	Preamp Factor (dB)	Level (dBuV/m)	LimitLine (dBuV/m)	Over Limit (dB)	Polarization
10380.00	48.17	40.00	9.85	41.95	56.07	68.20	-12.13	Vertical
10380.00	48.26	40.00	9.85	41.95	56.16	68.20	-12.04	Horizontal
Detector: Average Value								
Frequency (MHz)	Read Level (dBuV)	Antenna Factor (dB/m)	Cable Loss (dB)	Preamp Factor (dB)	Level (dBuV/m)	LimitLine (dBuV/m)	Over Limit (dB)	Polarization
10380.00	38.26	40.00	9.85	41.95	46.16	54.00	-7.84	Vertical
10380.00	38.36	40.00	9.85	41.95	46.26	54.00	-7.74	Horizontal
Test channel: Highest channel								
Detector: Peak Value								
Frequency (MHz)	Read Level (dBuV)	Antenna Factor (dB/m)	Cable Loss (dB)	Preamp Factor (dB)	Level (dBuV/m)	LimitLine (dBuV/m)	Over Limit (dB)	Polarization
10460.00	48.23	39.80	9.92	41.90	56.05	68.20	-12.15	Vertical
10460.00	48.31	39.80	9.92	41.90	56.13	68.20	-12.07	Horizontal
Detector: Average Value								
Frequency (MHz)	Read Level (dBuV)	Antenna Factor (dB/m)	Cable Loss (dB)	Preamp Factor (dB)	Level (dBuV/m)	LimitLine (dBuV/m)	Over Limit (dB)	Polarization
10460.00	38.29	39.80	9.92	41.90	46.11	54.00	-7.89	Vertical
10460.00	38.16	39.80	9.92	41.90	45.98	54.00	-8.02	Horizontal
Remark:								
1. <i>Final Level = Receiver Read level + Antenna Factor + Cable Loss – Preamplifier Factor.</i>								
2. <i>The emission levels of other frequencies are very lower than the limit and not show in test report.</i>								

Band 1 – 802.11ac(HT20)								
Test channel: Lowest channel								
Detector: Peak Value								
Frequency (MHz)	Read Level (dBuV)	Antenna Factor (dB/m)	Cable Loss (dB)	Preamp Factor (dB)	Level (dBuV/m)	Limit Line (dBuV/m)	Over Limit (dB)	Polarization
10360.00	48.79	40.10	9.82	41.97	56.74	68.20	-11.46	Vertical
10360.00	48.17	40.10	9.82	41.97	56.12	68.20	-12.08	Horizontal
Detector: Average Value								
Frequency (MHz)	Read Level (dBuV)	Antenna Factor (dB/m)	Cable Loss (dB)	Preamp Factor (dB)	Level (dBuV/m)	Limit Line (dBuV/m)	Over Limit (dB)	Polarization
10360.00	38.26	40.10	9.82	41.97	46.21	54.00	-7.79	Vertical
10360.00	38.31	40.10	9.82	41.97	46.26	54.00	-7.74	Horizontal
Test channel: Middle channel								
Detector: Peak Value								
Frequency (MHz)	Read Level (dBuV)	Antenna Factor (dB/m)	Cable Loss (dB)	Preamp Factor (dB)	Level (dBuV/m)	Limit Line (dBuV/m)	Over Limit (dB)	Polarization
10400.00	48.92	40.00	9.85	41.95	56.82	68.20	-11.38	Vertical
10400.00	48.91	40.00	9.85	41.95	56.81	68.20	-11.39	Horizontal
Detector: Average Value								
Frequency (MHz)	Read Level (dBuV)	Antenna Factor (dB/m)	Cable Loss (dB)	Preamp Factor (dB)	Level (dBuV/m)	Limit Line (dBuV/m)	Over Limit (dB)	Polarization
10400.00	38.26	40.00	9.85	41.95	46.16	54.00	-7.84	Vertical
10400.00	39.06	40.00	9.85	41.95	46.96	54.00	-7.04	Horizontal
Test channel: Highest channel								
Detector: Peak Value								
Frequency (MHz)	Read Level (dBuV)	Antenna Factor (dB/m)	Cable Loss (dB)	Preamp Factor (dB)	Level (dBuV/m)	Limit Line (dBuV/m)	Over Limit (dB)	Polarization
10480.00	48.37	39.70	9.96	41.88	56.15	68.20	-12.05	Vertical
10480.00	48.73	39.70	9.96	41.88	56.51	68.20	-11.69	Horizontal
Detector: Average Value								
Frequency (MHz)	Read Level (dBuV)	Antenna Factor (dB/m)	Cable Loss (dB)	Preamp Factor (dB)	Level (dBuV/m)	Limit Line (dBuV/m)	Over Limit (dB)	Polarization
10480.00	38.26	39.70	9.96	41.88	46.04	54.00	-7.96	Vertical
10480.00	38.69	39.70	9.96	41.88	46.47	54.00	-7.53	Horizontal
Remark:								
1. Final Level = Receiver Read level + Antenna Factor + Cable Loss – Pre-amplifier Factor.								
2. The emission levels of other frequencies are very lower than the limit and not show in test report.								

Band 1 – 802.11ac(HT40)								
Test channel: Lowest channel								
Detector: Peak Value								
Frequency (MHz)	Read Level (dBuV)	Antenna Factor (dB/m)	Cable Loss (dB)	Preamp Factor (dB)	Level (dBuV/m)	LimitLine (dBuV/m)	Over Limit (dB)	Polarization
10380.00	48.67	40.10	9.82	41.97	56.62	68.20	-11.58	Vertical
10380.00	48.81	40.10	9.82	41.97	56.76	68.20	-11.44	Horizontal
Detector: Average Value								
Frequency (MHz)	Read Level (dBuV)	Antenna Factor (dB/m)	Cable Loss (dB)	Preamp Factor (dB)	Level (dBuV/m)	LimitLine (dBuV/m)	Over Limit (dB)	Polarization
10380.00	37.96	40.10	9.82	41.97	45.91	54.00	-8.09	Vertical
10380.00	38.10	40.10	9.82	41.97	46.05	54.00	-7.95	Horizontal
Test channel: Highest channel								
Detector: Peak Value								
Frequency (MHz)	Read Level (dBuV)	Antenna Factor (dB/m)	Cable Loss (dB)	Preamp Factor (dB)	Level (dBuV/m)	LimitLine (dBuV/m)	Over Limit (dB)	Polarization
10460.00	48.97	40.00	9.85	41.95	56.87	68.20	-11.33	Vertical
10460.00	48.76	40.00	9.85	41.95	56.66	68.20	-11.54	Horizontal
Detector: Average Value								
Frequency (MHz)	Read Level (dBuV)	Antenna Factor (dB/m)	Cable Loss (dB)	Preamp Factor (dB)	Level (dBuV/m)	LimitLine (dBuV/m)	Over Limit (dB)	Polarization
10460.00	38.21	40.00	9.85	41.95	46.11	54.00	-7.89	Vertical
10460.00	38.29	40.00	9.85	41.95	46.19	54.00	-7.81	Horizontal
Remark:								
1. <i>Final Level = Receiver Read level + Antenna Factor + Cable Loss – Preamplifier Factor.</i>								
2. <i>The emission levels of other frequencies are very lower than the limit and not show in test report.</i>								

Band 1 – 802.11ac(HT80)								
Test channel: Middle channel								
Detector: Peak Value								
Frequency (MHz)	Read Level (dBuV)	Antenna Factor (dB/m)	Cable Loss (dB)	Preamp Factor (dB)	Level (dBuV/m)	Limit Line (dBuV/m)	Over Limit (dB)	Polarization
10420.00	49.12	40.00	9.85	41.95	57.02	68.20	-11.18	Vertical
10420.00	49.21	40.00	9.85	41.95	57.11	68.20	-11.09	Horizontal
Detector: Average Value								
Frequency (MHz)	Read Level (dBuV)	Antenna Factor (dB/m)	Cable Loss (dB)	Preamp Factor (dB)	Level (dBuV/m)	Limit Line (dBuV/m)	Over Limit (dB)	Polarization
10420.00	39.06	40.00	9.85	41.95	46.96	54.00	-7.04	Vertical
10420.00	39.11	40.00	9.85	41.95	47.01	54.00	-6.99	Horizontal
<i>Remark:</i>								
1. <i>Final Level = Receiver Read level + Antenna Factor + Cable Loss – Pre-amplifier Factor.</i>								
2. <i>The emission levels of other frequencies are very lower than the limit and not show in test report.</i>								

6.8 Frequency stability

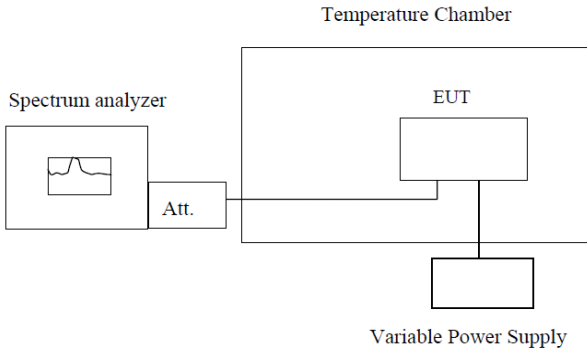
Test Requirement:	FCC Part15 E Section 15.407 (g)
Limit:	Manufacturers of U-NII devices are responsible for ensuring frequency stability such that an emission is maintained within the band of operation under all conditions of normal operation as specified in the user's manual.
Test setup:	 <p style="text-align: center;">Temperature Chamber</p> <p style="text-align: center;">Spectrum analyzer Att. EUT</p> <p style="text-align: center;">Variable Power Supply</p> <p>Note : Measurement setup for testing on Antenna connector</p>
Test procedure:	<ol style="list-style-type: none"> 1. The EUT is installed in an environment test chamber with external power source. 2. Set the chamber to operate at 50 centigrade and external power source to output at nominal voltage of EUT. 3. A sufficient stabilization period at each temperature is used prior to each frequency measurement. 4. When temperature is stabled, measure the frequency stability. 5. The test shall be performed under -30 to 50 centigrade and 85 to 115 percent of the nominal voltage. Change setting of chamber and external power source to complete all conditions.
Test Instruments:	Refer to section 5.9 for details
Test mode:	Refer to section 5.3 for details
Test results:	Passed

Measurement Data (the worst channel):
Band 1:
Voltage vs. Frequency Stability (Lowest channel=5180MHz)

Test conditions		Frequency(MHz)	Max. Deviation (ppm)
Temp(°C)	Voltage(ac)		
20	102V	5179.987453	2.42
	120V	5179.976771	4.48
	138V	5179.964956	4.83

Temperature vs. Frequency Stability (Lowest channel=5180MHz)

Test conditions		Frequency(MHz)	Max. Deviation (ppm)
Voltage(ac)	Temp(°C)		
120V	-20	5179.989463	2.03
	-10	5179.986437	2.61
	0	5179.979862	3.89
	10	5179.984316	3.03
	20	5179.993446	1.27
	30	5179.998763	0.24
	40	5179.989679	1.99
	50	5179.989734	1.98