

Industrial Internet Innovation Center (Shanghai) Co.,Ltd.

SRD TEST REPORT

PRODUCT	Smart counter scale
BRAND	SUNMI
MODEL	ACS-F2521,ACS-F2522,ACS-F2523
APPLICANT	Shanghai Sunmi Technology Co.,Ltd.
FCC ID	2AH25S2CC
IC	22621-S2CC
ISSUE DATE	March 1, 2024
STANDARD(S)	FCC Part15E, RSS-247 Issue 3

Prepared by: *Tao Lingyan*

Reviewed by: *Yang Fan*

Approved by: *Zhang Min*







CAUTION:

This report shall not be reproduced except in full without the written permission of the test laboratory and shall not be quoted out of context.

CONTENTS

1. SUMMARY OF TEST REPORT	3
1.1 TEST STANDARD.....	3
1.2 REFERENCE DOCUMENT(S).....	3
1.3 SUMMARY OF TEST RESULTS.....	3
1.4 DATA PROVIDED BY APPLICANT.....	4
2. GENERAL INFORMATION OF THE LABORATORY	5
2.1 TESTING LABORATORY	5
2.2 LABORATORY ENVIRONMENTAL REQUIREMENTS.....	5
2.3 PROJECT INFORMATION	5
3. GENERAL INFORMATION OF THE CUSTOMER	6
3.1 APPLICANT	6
3.2 MANUFACTURER	6
4. GENERAL INFORMATION OF THE PRODUCT.....	7
4.1 PRODUCT DESCRIPTION FOR EQUIPMENT UNDER TEST (EUT).....	7
4.2 INTERNAL IDENTIFICATION OF AE USED DURING THE TEST.....	7
4.3 ADDITIONAL INFORMATION	8
4.4 EUT TEST RF CONFIGURATION	9
5. TEST CONFIGURATION INFORMATION	10
5.1 LABORATORY ENVIRONMENTAL CONDITIONS.....	10
5.2 TEST EQUIPMENTS UTILIZED.....	10
5.3 MEASUREMENT UNCERTAINTY	12
6. TEST REQUIREMENTS.....	13
6.1 DFS TECHNICAL REQUIREMENTS AND RADAR TEST WAVEFORMS.....	13
7. TEST RESULTS.....	18
7.1 DFS DETECTION THRESHOLDS.....	18
7.2 CHANNEL LOADING	20
7.3 IN-SERVICE MONITORING FOR CHANNEL MOVE TIME, CHANNEL CLOSING TRANSMISSION TIME AND NON-OCCUPANCY PERIOD.....	21
ANNEX A: REVISED HISTORY	24
ANNEX B: ACCREDITATION CERTIFICATE.....	25

1. Summary of Test Report

1.1 Test Standard

No.	Test Standard	Title	Version
1	FCC Part15E	Title 47 of the Code of Federal Regulations; Chapter I Part 15 - Radio frequency devices	--
2	RSS-247 Issue 3	Digital Transmission Systems (DTSs), Frequency Hopping Systems (FHSs) and Licence-Exempt Local Area Network (LE-LAN) Devices	2013

1.2 Reference Document(s)

No.	Test Standard	Title	Version
1	ANSI 63.10	Methods of Measurement of Radio-Noise Emissions from Low-Voltage Electrical and Electronic Equipment in the Range of 9 kHz to 40 GHz	2013
2	KDB 905462 D02 UNII DFS Compliance Procedures New Rules v02	COMPLIANCE MEASUREMENT PROCEDURES FOR UNLICENSED-NATIONAL INFORMATION INFRASTRUCTURE DEVICES OPERATING IN THE 5250-5350 MHz AND 5470-5725 MHz BANDS INCORPORATING DYNAMIC FREQUENCY SELECTION	--

Note: KDB 905462 D02 UNII DFS Compliance Procedures New Rules v02 is not A2LA certified.

1.3 Summary of Test Results

No.	Measurement Items	FCC Rules	IC Rules	Verdict
1	Non-Occupancy Period	15.407(h) (2)	RSS-247 6.3	Pass
2	Channel Closing Transmission Time	15.407(h) (2)	RSS-247 6.3	Pass
3	Channel Move Time	15.407(h) (2)	RSS-247 6.3	Pass

Note 1:

The ACS-F2521,ACS-F2522,ACS-F2523 manufactured by Shanghai Sunmi Technology Co.,Ltd. is a new products for testing.

There are three configurations S03aa&S08aa (Mainly Supply), S16aa (Secondary Supply) and S12(Thirdly supply) in this project. We mainly tested the S03aa&S08aa (Mainly Supply), and the S16aa (Secondary Supply) and S12(Thirdly supply) tested the worst mode of the mainly supply, and recorded the test results of the worst mode respectively in the report.

The description of the differences between S03aa&S08aa (Mainly Supply), S16aa (Secondary Supply) and S12(Thirdly supply) are as follows:

Model	Screen size
ACS-F2521: S16aa (Secondary Supply)	15.6" screen+10.1" screen
ACS-F2522: S08aa (Mainly Supply)	15.6" screen+15.6" screen

ACS-F2523: S12aa (Thirdly Supply)	15.6" screen
-----------------------------------	--------------

Industrial Internet Innovation Center (Shanghai) Co., Ltd. only performed test cases which identified with Pass/Fail/Inc result in section 1.3.

Industrial Internet Innovation Center (Shanghai) Co., Ltd. has verified that the compliance of the tested device specified in section 4 of this test report is successfully evaluated according to the procedure and test methods as defined in type certification requirement listed in section 1 of this test report.

Note 2:
5G RLAN used a FPC antenna with max Gain 0.78/0.88/0.93dBi that complied with 15.203 Requirements.

1.4 Data Provided by Applicant

No.	Item(s)	Data
1	Antenna gain of EUT	0.78/0.88/0.93 dBi

Note:
The data of antenna gain is provided by the Antenna specification may affect the validity of the test results in this report, and the impact and consequences of this shall be undertaken by the customer.

2. General Information of The Laboratory

2.1 Testing Laboratory

Lab Name	Industrial Internet Innovation Center (Shanghai) Co.,Ltd.
Address	Building 4, No. 766, Jingang Road, Pudong, Shanghai, China
Telephone	021-68866880
FCC Registration No.	708870
FCC Designation No.	CN1364
IC Designation No.	10766A
CAB identifier	CN0067

2.2 Laboratory Environmental Requirements

Temperature	15°C~35°C
Relative Humidity	25%RH~75%RH
Atmospheric Pressure	86kPa~106kPa

2.3 Project Information

Project Manager	Gao Hongning
Test Date	January 02, 2024 to February 02, 2024

3. General Information of The Customer

3.1 Applicant

Company	Shanghai Sunmi Technology Co.,Ltd.
Address	Room 505,No.388,Song Hu Road,Yang Pu District,Shanghai,China
Telephone	+86 17302160204

3.2 Manufacturer

Company	Shanghai Sunmi Technology Co.,Ltd.
Address	Room 505,No.388,Song Hu Road,Yang Pu District,Shanghai,China
Telephone	+86 17302160204

4. General Information of The Product

4.1 Product Description for Equipment under Test (EUT)

Product Name	Smart counter scale
Model name	ACS-F2521,ACS-F2522,ACS-F2523
Date of Receipt	S03aa/S08aa/S16aa/S12aa:February 02, 2024
EUT ID*	S03aa/S08aa/S16aa/S12aa
SN/IMEI	NA
Supported Radio Technology and Bands	BT 4.2 BR/EDR/BLE WLAN 802.11b/g/n WLAN 802.11a/n/ac
Hardware Version	RK3568_MB_V2.0
Software Version	3.0.11
FCC ID	2AH25S2CC
IC	22621-S2CC
NOTE1: EUT ID is the internal identification code of the laboratory. NOTE2: Samples in the test report are provided by the customer. The test results are only applicable to the samples received by the laboratory.	

4.2 Internal Identification of AE used during the test

AE ID*	Description	Model	SN/Remark
CB04	Adapter	CYSE65-240250	Jiangsu Chenyang Electron Co., Ltd. 24V,2.5A
UB04	AC Cable	N/A	N/A
AE1	Notebook PC	DELL Latitude E6510	N/A
AE2	LAN Cable	N/A	N/A
AE3	Keyboard	KB212-B	CN-0Y88XT-65890-12I-005Q-A00
AE4	Mouse	MS111-P	CN-011D3V-71581-19J-1A64
AE5	Earphone	N/A	N/A
AE6	Micro SD card	Kingston SDC4/4GB 77	N/A
AE7	Cash Box	NC020	N/A
AE8	Telephone	HA8000(28) P/T S	N/A

AE9	U disk	Kingston DTSE9 16GB	N/A
AE10	U disk	Kingston DTSE9 16GB	N/A
AE11	USB Cable	N/A	N/A
AE12	Object of weight	N/A	N/A

NOTE: AE ID is the internal identification code of the laboratory.

4.3 Additional Information

Operating Frequency Range	U-NII-2A(5260MHz-5320MHz) U-NII-2C(5500MHz-5700MHz)
Operating Mode	Slave without radar detection

Test frequency list

UNII-2A:

BW_20M	Channel	52	56	60	64
	Freq. (MHz)	5260	5280	5300	5320
BW_40M	Channel	54		62	
	Freq. (MHz)	5270		5310	
BW_80M	Channel	58			
	Freq. (MHz)	5290			

UNII-2C:

BW_20M	Channel	100	104	108	112	116	120	124	128	132	136	140	
	Freq. (MHz)	5500	5520	5540	5560	5580	5600	5620	5640	5660	5680	5700	
BW_40M	Channel	102		110		118		126		134		/	
	Freq. (MHz)	5510		5550		5590		5630		5670		/	
BW_80M	Channel	106				122				/			
	Freq. (MHz)	5530				5610							

Note: "/" Represents empty

Maximum Output Power and E.I.R.P.

Frequency Band (MHz)	Max Output Power (dBm)	Antenna Gain (dBi)	Max. e.i.r.p. (dBm)	Max. e.i.r.p. (mW)
5290	11.2	0.88	12.09	16.18
5530	7.61	0.93	8.54	7.14

Note:

U-NII devices operating in the 5.25-5.35 GHz band and the 5.47-5.725GHz shall employ a TPC mechanism. A TPC mechanism is not required for systems with an e.i.r.p. of less than 500mW.

4.4 EUT Test RF Configuration

EUT uses iperf.apk working control emission measurement.

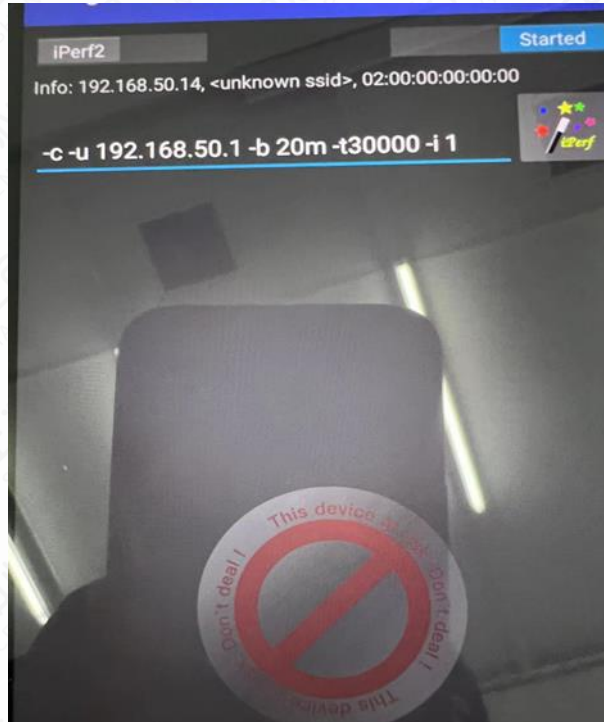

5. Test Configuration Information

5.1 Laboratory Environmental Conditions

5.1.1 Permanent Facilities

Relative Humidity	Min. = 45 %, Max. = 55 %		
Atmospheric Pressure	101kPa		
Temperature	Normal	Minimum	Maximum
	25°C	-10°C	40°C
Working Voltage of EUT	Normal	Minimum	Maximum
	24V	22.8V	25.2V

5.2 Test Equipments Utilized

5.2.1 Conducted test system

No.	Name	Model	S/N	SW Version	HW Version	Manufacturer	Cal. Date	Cal. Interval
1	Test Software	TS1120	10727	V3.2.22	N/A	Tonsce nd	N/A	N/A
2	Automatic control unit	JS0806-2	2218060623	N/A	N/A	Tonsce nd	2023-05-06	1 Year
3	Wireless communication comprehensive tester	CMW500	164865	V3.8.12	N/A	R&S	2023-07-26	1 Year
4	Spectrum Analyzer	FSQ40	200063	V4.75	N/A	R&S	2023-10-16	1 Year
5	Analog Signal Generator	SMF	104770	V3.0.13.0-2.20.530.15.4	N/A	R&S	2023-10-16	1 year
6	Vector Signal Generator	SMCV100B	103691	V5.00.122.24	N/A	R&S	2023-07-27	1 Year
7	Programmable Power Supply	Keithley 2303	4039070	N/A	N/A	Keithley	2023-06-23	1 Year
8	Temperature box	B-TF-107C	BTF107C-201804107	N/A	N/A	Boyi	2023-06-28	1 Year
9	Network test unit AP	GT-AXE11000	N2IGOX401637KWF	V3.0.0.4.386_45940	N/A	ASUS	N/A	N/A
10	Vector Signal Generator	SMBV100A	257904	V4.15.125.49	N/A	R&S	2023-10-16	1 Year

5.2.2 Test Environment

Shielding Room1 (6.0 meters×3.0 meters×2.7 meters) did not exceed following limits along the conducted RF performance testing:

Temperature	Min. = 15 °C, Max. = 35 °C
Relative humidity	Min. = 20 %, Max. = 75 %
Shielding effectiveness	> 100 dB
Ground system resistance	< 0.5 Ω
Temperature	Min. = 15 °C, Max. = 35 °C

Control room did not exceed following limits along the EMC testing:

Temperature	Min. = 15 °C, Max. = 35 °C
Relative humidity	Min. =30 %, Max. = 60 %
Shielding effectiveness	> 100 dB
Electrical insulation	> 10 kΩ
Ground system resistance	< 0.5 Ω

Fully-anechoic chamber1 (9.8 meters×6.7 meters×6.7 meters) did not exceed following limits along the EMC testing:

Temperature	Min. = 15 °C, Max. = 35 °C
Relative humidity	Min. = 25 %, Max. = 75 %
Shielding effectiveness	> 100 dB
Electrical insulation	> 10 kΩ
Ground system resistance	< 0.5 Ω
VSWR	Between 0 and 6 dB, from 1GHz to 18GHz
Site Attenuation Deviation	Between -4 and 4 dB,30MHz to 1GHz



5.3 Measurement Uncertainty

Measurement Uncertainty of Channel Shutdown:

The assessed measurement uncertainty to ensure 95% confidence level for the normal distribution is with the coverage factor $K=1.96, U=2.69\text{dB}$.

Measurement Uncertainty of Conduction test

Measurement Items	Range	Confidence Level	Calculated Uncertainty
Emission Bandwidth	5150-5850MHz	95%	$\pm 1.9\%$
Maximum Conduct Output Power	5150-5850MHz	95%	$\pm 1.18\text{ dB}$
Power Spectral Density	5150-5850MHz	95%	$\pm 0.98\text{ dB}$
Band Edge Measurements	5150-5850MHz	95%	$\pm 1.21\text{dB}$
Unwanted Emissions Measurement	9kHz-40GHz	95%	9kHz-7GHz: $\pm 1.21\text{dB}$ 7GHz-40GHz: $\pm 3.31\text{dB}$
Frequency Stability	5150-5850MHz	95%	$\pm 1.9\%$

6. Test Requirements

6.1 DFS Technical Requirements and Radar Test Waveforms

6.1.1 DFS Overview

Table 6-1 Applicability of DFS Requirements Prior to Use of a Channel

Requirement	Operational Mode		
	Master	Client Without Radar Detection	Client With Radar Detection
Non-Occupancy Period	Yes	Not required	Yes
DFS Detection Threshold	Yes	Not required	Yes
Channel Availability Check Time	Yes	Not required	Not required
U-NII Detection Bandwidth	Yes	Not required	Yes

Table 6-2 Applicability of DFS requirements during normal operation

Requirement	Operational Mode	
	Master Device or Client with Radar Detection	Client Without Radar Detection
DFS Detection Threshold	Yes	Not required
Channel Closing Transmission Time	Yes	Yes
Channel Move Time	Yes	Yes
U-NII Detection Bandwidth	Yes	Not required

Additional requirements for devices with multiple bandwidth modes	Master Device or Client with Radar Detection	Client Without Radar Detection
U-NII Detection Bandwidth	All BW modes must be tested	Not required
Statistical Performance Check	All BW modes must be tested	Not required
Channel Closing Transmission Time	Test using widest BW mode available	Test using the widest BW mode available for the link
Channel Move Time	Test using widest BW mode available	Test using the widest BW mode available for the link
All other tests	Any single BW mode	Not required

Note: Frequencies selected for statistical performance check should include several frequencies within the radar detection bandwidth and frequencies near the edge of the radar detection bandwidth. For 802.11 devices it is suggested to select frequencies in each of the bonded 20 MHz channels and the channel center frequency.

6.1.2 DFS Detection Thresholds

Table 6-3 DFS Detection Thresholds for Master Devices and Client Devices with Radar Detection

Maximum Transmit Power	Value (See Notes 1, 2, and 3)
EIRP \geq 200 milliwatt	-64 dBm
EIRP < 200 milliwatt and power spectral density < 10 dBm/MHz	-62 dBm
EIRP < 200 milliwatt that do not meet the power spectral density requirement	-64 dBm

Note 1: This is the level at the input of the receiver assuming a 0 dBi receive antenna.

Note 2: Throughout these test procedures an additional 1 dB has been added to the amplitude of the test transmission waveforms to account for variations in measurement equipment. This will ensure that the test signal is at or above the detection threshold level to trigger a DFS response.

Note3: EIRP is based on the highest antenna gain. For MIMO devices refer to KDB Publication 662911 D01.

Table 6-4 DFS Response Requirement Values

Parameter	Value
Non-occupancy period	Minimum 30 minutes
Channel Availability Check Time	60 seconds
Channel Move Time	10 seconds See Note 1.
Channel Closing Transmission Time	200 milliseconds + an aggregate of 60 milliseconds over remaining 10 second period. See Notes 1 and 2.
U-NII Detection Bandwidth	Minimum 100% of the U-NII 99% transmission power bandwidth. See Note 3.

Note 1: Channel Move Time and the Channel Closing Transmission Time should be performed with Radar Type 0. The measurement timing begins at the end of the Radar Type 0 burst.

Note 2: The Channel Closing Transmission Time is comprised of 200 milliseconds starting at the beginning of the Channel Move Time plus any additional intermittent control signals required to facilitate a Channel move (an aggregate of 60 milliseconds) during the remainder of the 10 second period. The aggregate duration of control signals will not count quiet periods in between transmissions.

Note 3: During the U-NII Detection Bandwidth detection test, radar type 0 should be used. For each frequency step the minimum percentage of detection is 90 percent. Measurements are performed with no data traffic.

6.1.3 Radar Test Waveforms
Short Pulse Radar Test Waveforms

Radar Type	Pulse Width (μsec)	PRI (μsec)	Number of Pulses	Minimum Percentage of Successful Detection	Minimum Number of Trials
0	1	1428	18	See Note 1	See Note 1
1	1	Test A: 15 unique PRI values randomly selected from the list of 23 PRI values in Table 5a	Roundup	60%	30
		Test B: 15 unique PRI values randomly selected within the range of 518-3066 μsec, with a minimum increment of 1 μsec, excluding PRI values selected in Test A			
2	1-5	150-230	23-29	60%	30
3	6-10	200-500	16-18	60%	30
4	11-20	200-500	12-16	60%	30
Aggregate (Radar Types 1-4)				80%	120
Note 1: Short Pulse Radar Type 0 should be used for the detection bandwidth test, channel move time, and channel closing time tests.					

Pulse Repetition Intervals Values for Test A

Pulse Repetition Frequency Number	Pulse Repetition Frequency (Pulses Per Second)	Pulse Repetition Interval (Microseconds)
1	1930.5	518
2	1858.7	538
3	1792.1	558
4	1730.1	578
5	1672.2	598
6	1618.1	618
7	1567.4	638
8	1519.8	658
9	1474.9	678
10	1432.7	698
11	1392.8	718
12	1355	738
13	1319.3	758
14	1285.3	778
15	1253.1	798
16	1222.5	818
17	1193.3	838
18	1165.6	858

19	1139	878
20	1113.6	898
21	1089.3	918
22	1066.1	938
23	326.2	3066

The aggregate is the average of the percentage of successful detections of Short Pulse Radar Types 1-4. For example, the following table indicates how to compute the aggregate of percentage of successful detections.

Radar Type	Number of Trials	Number of Successful Detections	Minimum Percentage of Successful Detection
1	35	29	82.9%
2	30	18	60%
3	30	27	90%
4	50	44	88%
Aggregate $(82.9\% + 60\% + 90\% + 88\%)/4 = 80.2\%$			

Long Pulse Radar Test Waveform

Radar Type	Pulse Width (μsec)	Chirp Width (MHz)	PRI (μsec)	Number of Pulses per Burst	Number of Bursts	Minimum Percentage of Successful Detection	Minimum Number of Trials
5	50-100	5-20	1000-2000	1-3	8-20	80%	30

The parameters for this waveform are randomly chosen. Thirty unique waveforms are required for the Long Pulse Radar Type waveforms. If more than 30 waveforms are used for the Long Pulse Radar Type waveforms, then each additional waveform must also be unique and not repeated from the previous waveforms.

Frequency Hopping Radar Test Waveform

Radar Type	Pulse Width (μsec)	PRI (μsec)	Pulses per Hop	Hopping Rate (kHz)	Hopping Sequence Length (msec)	Minimum Percentage of Successful Detection	Minimum Number of Trials
6	1	333	9	0.333	300	70%	30

For the Frequency Hopping Radar Type, the same Burst parameters are used for each waveform. The hopping sequence is different for each waveform and a 100-length segment is selected from the hopping sequence defined by the following algorithm: The first frequency in a hopping sequence is selected randomly from the group of 475 integer frequencies from 5250 – 5724 MHz. Next, the frequency that was just chosen is removed from the group and a frequency is randomly selected from the remaining 474 frequencies in the group. This process continues until all 475 frequencies are chosen for the set. For selection of a random frequency, the frequencies remaining within the group are always treated as equally likely.

6.1.4 Set-up

Set-up B is a set-up whereby the UUT is an RLAN device operating in slave mode, with or without Radar Interference Detection function. This set-up also contains an RLAN device operating in master mode. The radar test signals are injected into the master device. The UUT (slave device) is associated with the master device.

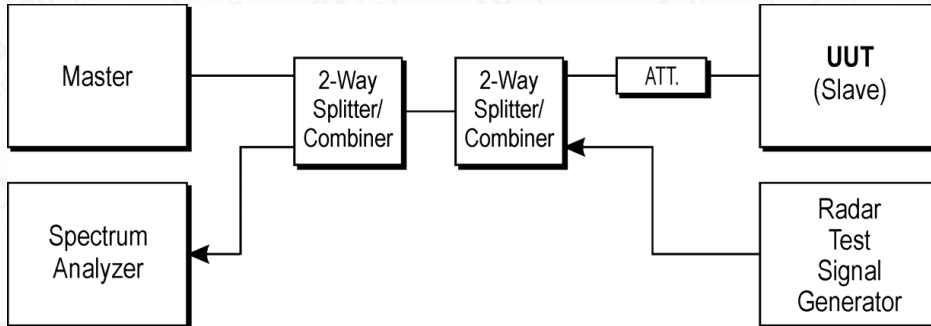

Pic 6-6: Set-up B

7. Test Results

7.1 DFS Detection Thresholds

7.1.1 Method of Measurement

A spectrum analyzer is used to establish the test signal level for each radar type. During this process, there are no transmissions by either the Master Device or Client Device. The spectrum analyzer is switched to the zero span (time domain) mode at the frequency of the Radar Waveform generator. The peak detector function of the spectrum analyzer is utilized. The spectrum analyzer resolution bandwidth (RBW) and video bandwidth (VBW) are set to at least 3 MHz.

The signal generator amplitude and/or step attenuators are set so that the power level measured at the spectrum analyzer is equal to the DFS Detection Threshold that is required for the tests. The signal generator and attenuator settings are recorded for use during the test.

7.1.2 The Calibration is listed below:

TestMode	Frequency[dbm]	Radar Type	Result	Limit[dbm]	Verdict
11A	5260	Type0	-62.46	-62.00	PASS
11A	5500	Type0	-62.10	-62.00	PASS
11N40SISO	5270	Type0	-62.50	-62.00	PASS
11N40SISO	5510	Type0	-62.11	-62.00	PASS
11AC80SISO	5290	Type0	-62.35	-62.00	PASS
11AC80SISO	5530	Type0	-62.49	-62.00	PASS

Test Graphs

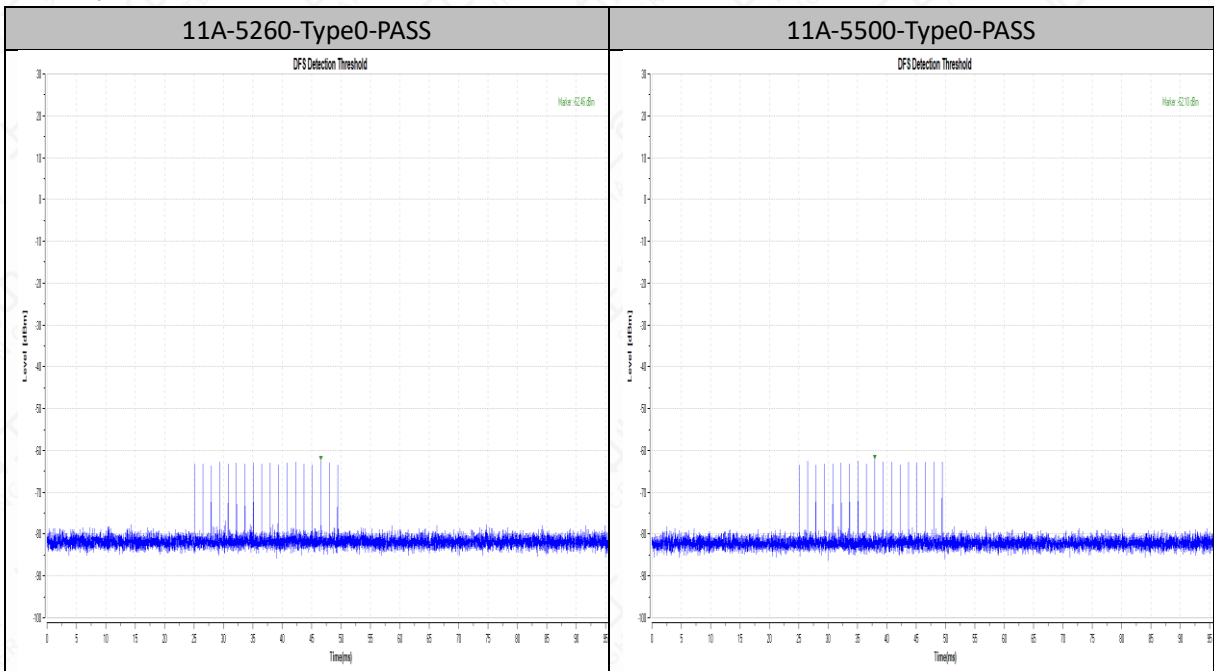

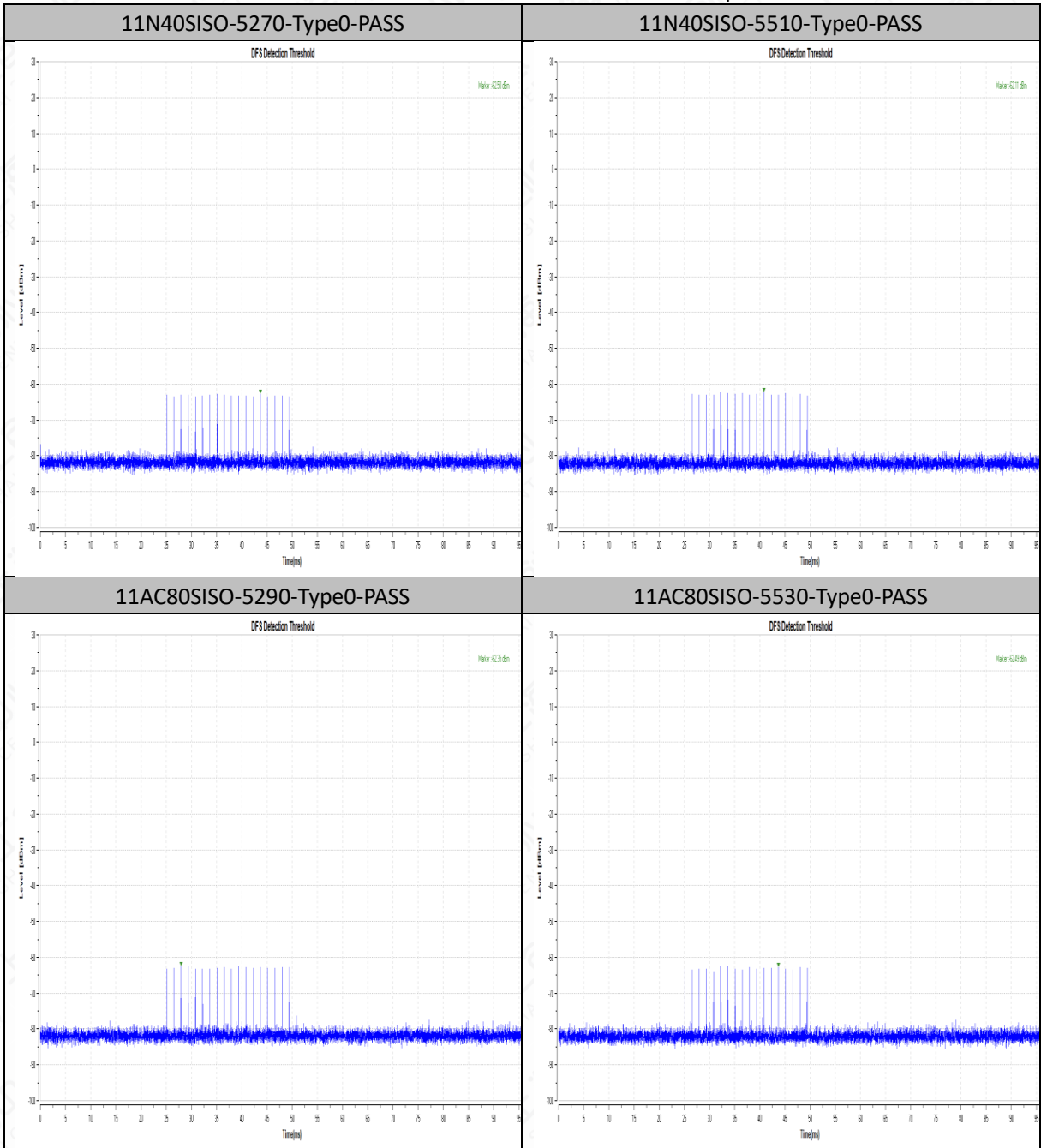

7.2 Channel loading

7.2.1 Method of Measurement

System testing will be performed with channel-loading using means appropriate to the data types that are used by the unlicensed device. The following requirements apply:

<input type="checkbox"/>	a) The data file must be of a type that is typical for the device (i.e., MPEG-2, MPEG-4, WAV, MP3, MP4, AVI, etc.) and must generally be transmitting in a streaming mode.
<input type="checkbox"/>	b) Software to ping the client is permitted to simulate data transfer but must have random ping intervals.
<input checked="" type="checkbox"/>	c) Timing plots are required with calculations demonstrating a minimum channel loading of approximately 17% or greater. For example, channel loading can be estimated by setting the spectrum analyzer for zero span and approximate the Time On/ (Time On + Off Time). This can be done with any appropriate channel BW and modulation type.
<input type="checkbox"/>	d) Unicast or Multicast protocols are preferable but other protocols may be used. The appropriate protocol used must be described in the test procedures.

7.2.2 Test Result

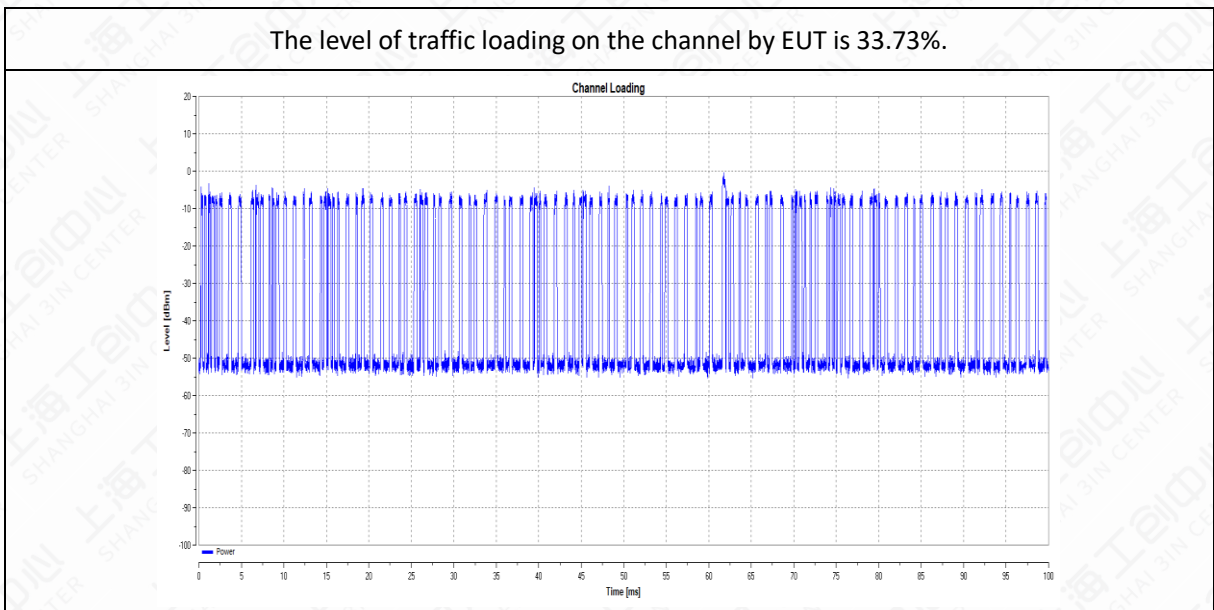

7.3 In-Service Monitoring for Channel Move Time, Channel Closing Transmission Time and Non-Occupancy Period

7.3.1 Method of Measurement

These tests define how the following DFS parameters are verified during In-Service Monitoring;

- Channel Closing Transmission Time
- Channel Move Time
- Non-Occupancy Period

The steps below define the procedure to determine the above mentioned parameters when a radar Burst with a level equal to the DFS Detection Threshold + 1dB is generated on the Operating Channel of the U-NII device (In- Service Monitoring).

- a) One frequency will be chosen from the Operating Channels of the EUT within the 5250-5350 MHz or 5470-5725 MHz bands. For 802.11 devices, the test frequency must contain control signals. This can be verified by disabling channel loading and monitoring the spectrum analyzer. If no control signals are detected, another frequency must be selected within the emission bandwidth where control signals are detected.
- b) In case the EUT is a U-NII device operating as a Client Device (with or without DFS), a U-NII device operating as a Master Device will be used to allow the EUT (Client device) to Associate with the Master Device. In case the EUT is a Master Device, a U-NII device operating as a Client Device will be used and it is assumed that the Client will Associate with the EUT (Master). In both cases for conducted tests, the Radar Waveform generator will be connected to the Master Device. For radiated tests, the emissions of the Radar Waveform generator will be directed towards the Master Device. If the Master Device has antenna gain, the main beam of the antenna will be directed toward the radar emitter.
- c) Vertical polarization is used for testing.
- d) Stream the channel loading test file from the Master Device to the Client Device on the test Channel for the entire period of the test.
- e) At time T₀ the Radar Waveform generator sends a Burst of pulses for one of the Radar Type 0 in Table 5 at levels defined in Table 3, on the Operating Channel. An additional 1 dB is added to the radar test signal to ensure it is at or above the DFS Detection Threshold, accounting for equipment variation /errors.
- f) Observe the transmissions of the EUT at the end of the radar Burst on the Operating Channel for duration greater than 10 seconds. Measure and record the transmissions from the EUT during the observation time (Channel Move Time). Measure and record the Channel Move Time and Channel Closing Transmission Time if radar detection occurs. Figure 17 illustrates Channel Closing Transmission Time.
- g) When operating as a Master Device, monitor the EUT for more than 30 minutes following instant T₂ to verify that the EUT does not resume any transmissions on this Channel. Perform this test once and record the measurement result.
- h) In case the EUT is a U-NII device operating as a Client Device with In-Service Monitoring, perform steps a) to f).

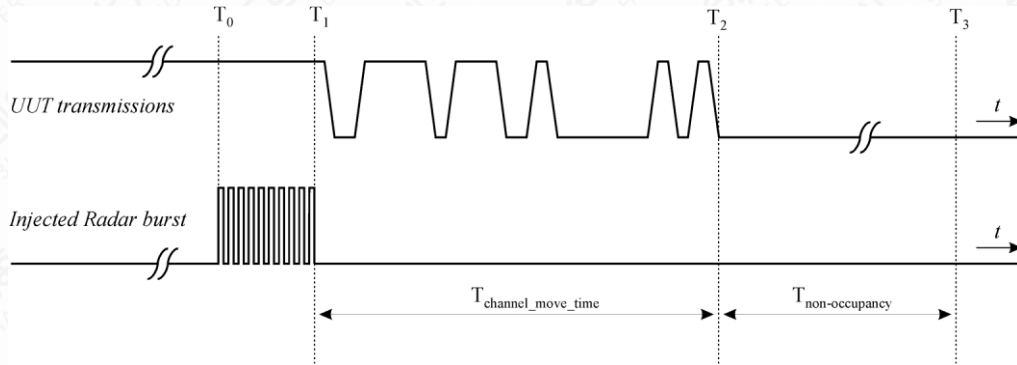

Pic 7-1: Channel Closing Transmission Time, Channel Move Time and Non-Occupancy Period

7.3.2 Limits

Channel Move Time	$\leq 10s$
Channel Closing Transmission Time	$\leq 200ms + 60ms$ (over remaining 10s period)
Non-Occupancy Period	$\geq 30min$

Note 1: Channel Move Time and the Channel Closing Transmission Time should be performed with Radar Type 0. The measurement timing begins at the end of the Radar Type 0 burst.

Note 2: The Channel Closing Transmission Time is comprised of 200 milliseconds starting at the beginning of the Channel Move Time plus any additional intermittent control signals required to facilitate Channel move (an aggregate of 60 milliseconds) during the remainder of the 10 second period. The aggregate duration of control signals will not count quiet periods in between transmissions.

Note 3: The Channel Closing Transmission Time is calculated by the computer.

Note 4: A port with a minimum antenna gain was selected for testing. For details, refer to the document "DFS Set-up Photo".

7.3.3 Test result of Channel Move Time and Channel Closing Transmission Time

TestMode	Frequency[MHz]	CCTT[ms]	Limit[ms]	CMT[ms]	Limit[ms]	Verdict
11AC80SISO	5290	200+16.9	200+60	1080	10000	PASS
11AC80SISO	5530	200+2.6	200+60	315.6	10000	PASS

Note:

$CCTT = 200ms + \text{Per Bin Time} * \text{Number of T2 to T3 ON Bins};$

$CMT = T3 - T1.$

*CCTT: Channel Closing Transmission Time,

*CMT: Channel Move Time,

*T0: Start of Radar signal Time,

*T1: Start of channel Move Time,

*T2: Start of channel Move Time + 200ms,

*T3: End of Channel Move Time.

Test Graphs

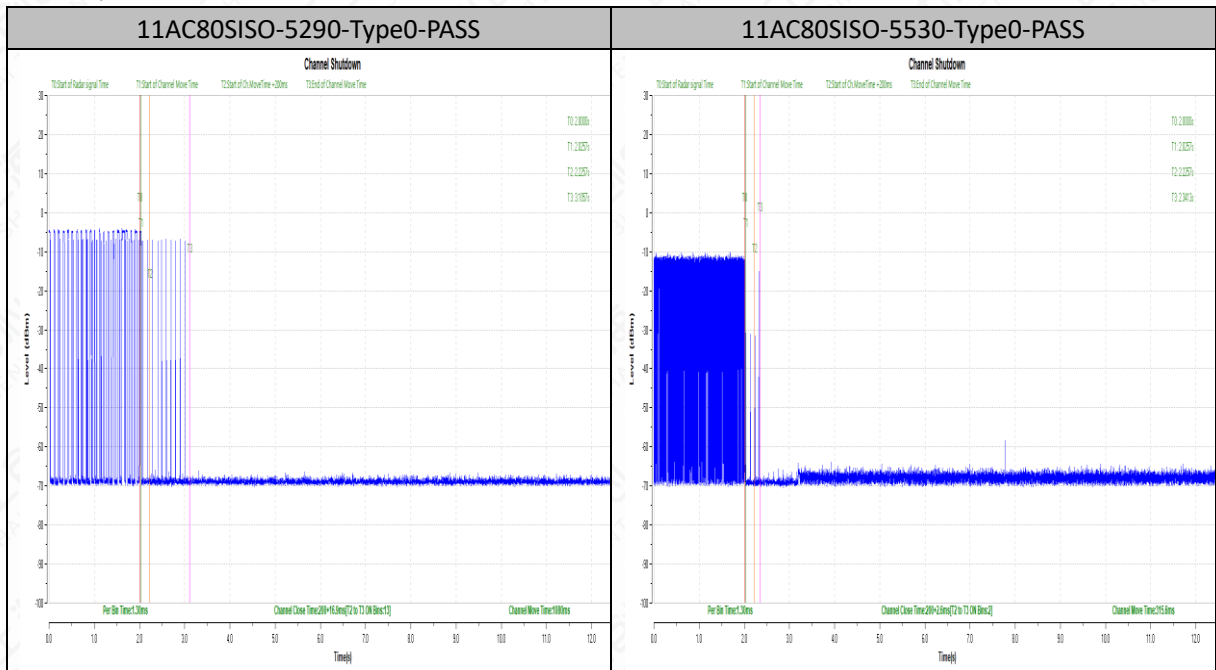

7.3.4 Test result of Non-Occupancy Period

TestMode	Frequency[MHz]	Result	Limit[s]	Verdict
11AC80SISO	5290	see test graph	≥1800	PASS
11AC80SISO	5530	see test graph	≥1800	PASS

Test Graphs

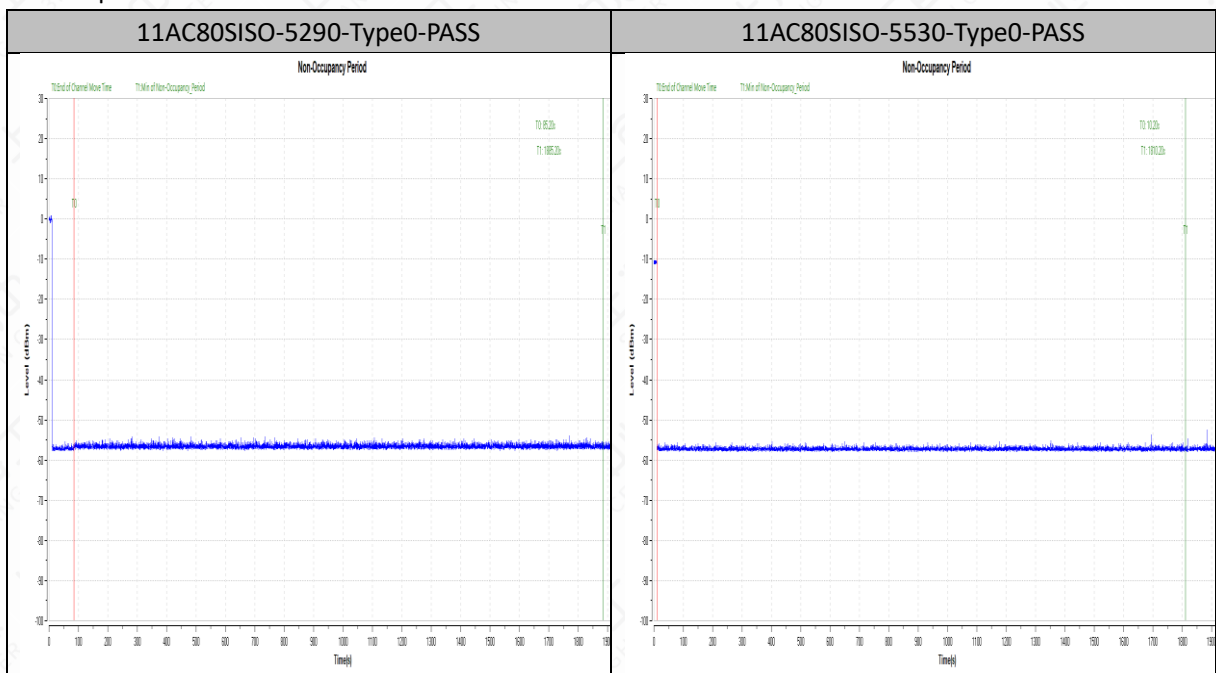

Annex A: Revised History

Version	Revised Content
V00	Initial

Annex B: Accreditation Certificate



Accredited Laboratory

A2LA has accredited

**INDUSTRIAL INTERNET INNOVATION CENTER
(SHANGHAI) CO., LTD.**
Shanghai, People's Republic of China

for technical competence in the field of

Electrical Testing

This laboratory is accredited in accordance with the recognized International Standard ISO/IEC 17025:2017 *General requirements for the competence of testing and calibration laboratories*. This accreditation demonstrates technical competence for a defined scope and the operation of a laboratory quality management system (refer to joint ISO-ILAC-IAF Communiqué dated April 2017).



Presented this 20th day of September 2023.



Mr. Trace McInturff, Vice President, Accreditation Services
For the Accreditation Council
Certificate Number 3682.01
Valid to February 28, 2025

For the tests to which this accreditation applies, please refer to the laboratory's Electrical Scope of Accreditation.

END OF REPORT