



TEST REPORT

No. I18D00207-SAR01

For

Client: Shanghai Sunmi Technology Co.,Ltd.

Production: Wireless data ordering system

Model Name: T7821

Brand Name: SUNMI

FCC ID: 2AH25M2

Hardware Version: 2DD021_V2.01

Software Version: M2_V1.8

Issued date: 2019-01-30

NOTE

1. The test results in this test report relate only to the devices specified in this report.
2. This report shall not be reproduced except in full without the written approval of East China Institute of Telecommunications.
3. KDB has not been approved by A2LA.
4. For the test results, the uncertainty of measurement is not taken into account when judging the compliance with specification, and the results of measurement or the average value of measurement results are taken as the criterion of the compliance with specification directly.

Test Laboratory:

East China Institute of Telecommunications

Add: 7-8F, G Area, No.668, Beijing East Road, Huangpu District, Shanghai, P. R. China

Tel: +86 21 63843300

FAX: +86 21 63843301

E-Mail: welcome@ecit.org.cn

Revision Version

Report Number	Revision	Date	Memo
I18D00207-SAR01	00	2019-01-30	Initial creation of test report

CONTENTS

NOTE.....	2
1. TEST LABORATORY	7
1.1. TESTING LOCATION	7
1.2. TESTING ENVIRONMENT	7
1.3. PROJECT DATA.....	7
1.4. SIGNATURE	7
2. STATEMENT OF COMPLIANCE	8
3. CLIENT INFORMATION	10
3.1. APPLICANT INFORMATION	10
3.2. MANUFACTURER INFORMATION	10
4. EQUIPMENT UNDER TEST (EUT) AND ANCILLARY EQUIPMENT (AE)	11
4.1. ABOUT EUT	11
4.2. INTERNAL IDENTIFICATION OF EUT USED DURING THE TEST.....	12
4.3. INTERNAL IDENTIFICATION OF AE USED DURING THE TEST	12
5. TEST METHODOLOGY	13
5.1. APPLICABLE LIMIT REGULATIONS	13
5.2. APPLICABLE MEASUREMENT STANDARDS	13
6. SPECIFIC ABSORPTION RATE (SAR).....	14
6.1. INTRODUCTION	14
6.2. SAR DEFINITION	14
7. TISSUE SIMULATING LIQUIDS	15
7.1. TARGETS FOR TISSUE SIMULATING LIQUID.....	15
7.2. DIELECTRIC PERFORMANCE	16
8. SYSTEM VERIFICATION	17
8.1. SYSTEM SETUP	17
8.2. SYSTEM VERIFICATION	18

9.	MEASUREMENT PROCEDURES	19
9.1.	TESTS TO BE PERFORMED	19
9.2.	GENERAL MEASUREMENT PROCEDURE.....	19
9.3.	WCDMA MEASUREMENT PROCEDURES FOR SAR	20
9.4.	BLUETOOTH & WIFI MEASUREMENT PROCEDURES FOR SAR.....	21
9.5.	POWER DRIFT	22
10.	CONDUCTED OUTPUT POWER	23
10.1.	GSM MEASUREMENT RESULT	30
10.2.	WCDMA MEASUREMENT RESULT	32
10.3.	LTE MEASUREMENT RESULT	33
10.4.	WIFI AND BT MEASUREMENT RESULT	42
10.5.	CDMA MEASUREMENT RESULT	45
11.	SIMULTANEOUS TX SAR CONSIDERATIONS.....	46
11.1.	INTRODUCTION	46
11.2.	TRANSMIT ANTENNA SEPARATION DISTANCES.....	46
11.3.	STANDALONE SAR TEST EXCLUSION CONSIDERATIONS	47
11.4.	SAR MEASUREMENT POSITIONS	47
12.	SAR TEST RESULT	48
13.	EVALUATION OF SIMULTANEOUS.....	57
14.	SAR MEASUREMENT VARIABILITY.....	59
15.	MEASUREMENT UNCERTAINTY	60
16.	MAIN TEST INSTRUMENT	62
ANNEX A.	HIGHEST SAR GRAPH RESULTS.....	63
ANNEX B.	SYSTEM VALIDATION RESULTS	74
ANNEX C.	SAR MEASUREMENT SETUP	79
ANNEX D.	POSITION OF THE WIRELESS DEVICE IN RELATION TO THE PHANTOM.....	88
ANNEX E.	EQUIVALENT MEDIA RECIPES.....	91

ANNEX F. SYSTEM VALIDATION	92
ANNEX G. PROBE AND DAE CALIBRATION CERTIFICATE.....	93
ANNEX H. ACCREDITATION CERTIFICATE	147

1. Test Laboratory

1.1. Testing Location

Company Name:	ECIT Shanghai, East China Institute of Telecommunications
Address:	7-8F, G Area, No. 668, Beijing East Road, Huangpu District, Shanghai, P. R. China
Postal Code:	200001
Telephone:	(+86)-021-63843300
Fax:	(+86)-021-63843301
FCC registration No:	958356

1.2. Testing Environment

Normal Temperature:	18-25°C
Relative Humidity:	25-75%
Ambient noise & Reflection:	< 0.012 W/kg

1.3. Project Data

Project Leader:	Chen Minfei
Testing Start Date:	2018-10-29
Testing End Date:	2019-01-30

1.4. Signature



Yan Hang
(Prepared this test report)



Fu Erliang
(Reviewed this test report)

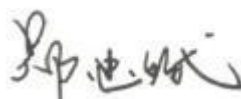

Zheng Zhongbin
(Approved this test report)

2. Statement of Compliance

The maximum results of Specific Absorption Rate (SAR) found during testing for **T7821** are as follows .

Table 2.1: Max. Reported SAR (1g)

Band	SAR 1g(W/Kg)	
	Body worn(5mm)	Hotspot(5mm)
GSM 850	1.139	1.139
GSM 1900	0.365	0.397
WCDMA Band2	0.603	0.603
WCDMA Band4	1.151	1.151
WCDMA Band5	0.649	0.649
CDMA BC0	0.727	0.727
CDMA BC1	1.144	1.144
LTE Band2	0.549	0.549
LTE Band4	1.363	1.363
LTE Band7	1.126	1.126
LTE Band 17	0.482	0.482
2.4G WiFi	0.176	0.176
5G WiFi	0.155	0.317

The SAR values found for the Mobile Phone are below the maximum recommended levels of 1.6 W/Kg as averaged over any 1g tissue according to the ANSI C95.1-1999.

For body worn operation, this device has been tested and meets FCC RF exposure guidelines when used with any accessory that contains no metal. Use of other accessories may not ensure compliance with FCC RF exposure guidelines.

Note: Original 5G and LTE band 17 test results are obtained from the **Shenzhen BALUN Co., Ltd.** Report and report No. is **BL-SZ18A0312-701**

Table 2.2: Simultaneous SAR

Simultaneous multi-band transmission									
Test Position		2G	3G	4G	2.4GHz		5GHz	SUM	
					BT	WiFi	WiFi	2.4GHz	5GHz
Hotspot &Body-worn 5 mm	Phantom Side	0.827	0.730	0.794	0.133	0.138	0.144	0.965	0.971
	Ground Side	1.139	1.151	1.363	0.133	0.161	0.155	1.524	1.518
Hotspot 5 mm	Left Side	0.970	0.478	0.387	0.133	0.117	0.317	1.103	1.287
	Right Side	0.712	0.469	0.343	0.133	0.0489	--	0.845	--
	Top Side	--	--	--	0.133	0.0944	0.183	0.133	0.183
	Bottom Side	0.577	0.623	0.654	0.133	--	--	0.787	--

According to the above table, the maximum sum of reported SAR values for GSM/WCDMA/LTE/CDMA and BT/WiFi is **1.524 W/kg** (1g).

3. Client Information

3.1. Applicant Information

Company Name: Shanghai Sunmi Technology Co.,Ltd.
Address: Room 505, KIC Plaza, No.388 Song Hu Road, Yang Pu District, Shanghai, China
Telephone: 86-18721763396
Postcode: 200433

3.2. Manufacturer Information

Company Name: Shanghai Sunmi Technology Co.,Ltd.
Address: Room 505, KIC Plaza, No.388 Song Hu Road, Yang Pu District, Shanghai, China
Telephone: 86-18721763396
Postcode: 200433

4. Equipment Under Test (EUT) and Ancillary Equipment (AE)

4.1. About EUT

Description:	Wireless data ordering system
Model name:	T7821
Operation Model(s):	GSM850/GSM900/GSM1800/GSM1900 WCDMA Band I/Band II/Band IV/Band V LTE 2/4/7/17/28;CDMA BC0/BC1 BT4.1,BLE;WiFi 802.11a,b,g,n GPS
Tx Frequency:	824.2-848.8MHz(GSM850) 1850.2-1909.8MHz (GSM1900) 1852.4-1907.6 MHz (WCDMA Band II) 1712.4-1752.6 MHz (WCDMA Band IV) 826.4-846.6MHz (WCDMA Band V) 1850.7 -1909.3 MHz (LTE Band 2) 1710.7 -1754.3 MHz (LTE Band 4) 2502.5 – 2567.5 MHz (LTE Band 7) 706.5 -713.5 MHz (LTE Band 17) 824.7-848.31MHz(CDMA BC0) 1851.25-1908.75MHz(CDMA BC1) 2412- 2462 MHz (WiFi) 5150~5250 MHz(U-NII-1) 5725~5850 MHz(U-NII-3) 2402 – 2480 MHz (BT)
Test device Production information:	Production unit
GPRS/EGPRS Class Mode:	B
GPRS/ EGPRS Multislot Class:	12
Device type:	Portable device
Antenna type:	Inner antenna
Accessories/Body-worn configurations:	N/A
Dimensions:	145x75x12mm
Hotspot Mode:	Support

4.2. Internal Identification of EUT used during the test

EUT ID*	SN or IMEI	HW Version	SW Version	Receive Date
N03	8868591030031081	2DD021_V2.01	M2_V1.8	2018-10-16
N10	869558040030527	2DD021_V2.01	M2_V1.8	2018-11-16

*EUT ID: is used to identify the test sample in the lab internally.

4.3. Internal Identification of AE used during the test

AE ID*	Description	Model	SN	Manufacturer
N/A	N/A	N/A	N/A	N/A

*AE ID: is used to identify the test sample in the lab internally.

5. TEST METHODOLOGY

5.1. Applicable Limit Regulations

ANSI C95.1–1999:IEEE Standard for Safety Levels with Respect to Human Exposure to Radio Frequency Electromagnetic Fields, 3 kHz to 300 GHz.

It specifies the maximum exposure limit of **1.6 W/kg** as averaged over any 1 gram of tissue for portable devices being used within 20 cm of the user in the uncontrolled environment.

5.2. Applicable Measurement Standards

IEEE 1528–2013: Recommended Practice for Determining the Peak Spatial-Average Specific Absorption Rate (SAR) in the Human Body Due to Wireless Communications Devices:

Experimental Techniques.

KDB648474 D04 Handset SAR v01r03:SAR Evaluation Considerations for Wireless Handsets.

KDB248227 D01 802 11 WiFi SAR v02r02: SAR measurement procedures for 802.112abg transmitters.

KDB447498 D01 General RF Exposure Guidance v06:Mobile and Portable Devices RF Exposure Procedures and Equipment Authorization Policies.

KDB865664 D01 SAR Measurement 100 MHz to 6 GHz v01r04:SAR Measurement Requirements for 100 MHz to 6 GHz

KDB865664 D02 RF Exposure Reporting v01r02:provides general reporting requirements as well as certain specific information required to support MPE and SAR compliance.

KDB941225 D01 3G SAR Procedures v03r01: 3G SAR Measurement Procedures.

KDB941225 D06 hotspot SAR v02r01:SAR Evaluation Procedures for Portable Devices with Wireless Router Capabilities.

NOTE: KDB is not in A2LA Scope List.

6. Specific Absorption Rate (SAR)

6.1. Introduction

SAR is related to the rate at which energy is absorbed per unit mass in an object exposed to a radio field. The SAR distribution in a biological body is complicated and is usually carried out by experimental techniques or numerical modeling. The standard recommends limits for two tiers of groups, occupational/controlled and general population/uncontrolled, based on a person's awareness and ability to exercise control over his or her exposure. In general, occupational/controlled exposure limits are higher than the limits for general population/uncontrolled.

6.2. SAR Definition

The SAR definition is the time derivative (rate) of the incremental energy (dW) absorbed by (dissipated in) an incremental mass (dm) contained in a volume element (dv) of a given density (ρ). The equation description is as below:

$$SAR = \frac{d}{dt} \left(\frac{dW}{dm} \right) = \frac{d}{dt} \left(\frac{dW}{\rho dv} \right)$$

SAR is expressed in units of Watts per kilogram (W/kg)

SAR measurement can be either related to the temperature elevation in tissue by

$$SAR = c \left(\frac{\delta T}{\delta t} \right)$$

Where: c is the specific heat capacity, δT is the temperature rise and δt is the exposure duration, or related to the electrical field in the tissue by

$$SAR = \frac{\sigma |E|^2}{\rho}$$

Where: σ is the conductivity of the tissue, ρ is the mass density of tissue and E is the RMS electrical field strength.

However for evaluating SAR of low power transmitter, electrical field measurement is typically applied.

7. Tissue Simulating Liquids

7.1. Targets for tissue simulating liquid

Table 7.1: Targets for tissue simulating liquid

Frequency(MHz)	Liquid Type	Conductivity(σ)	$\pm 5\%$ Range	Permittivity(ϵ)	$\pm 5\%$ Range
835	Head	0.90	0.86~0.95	41.5	39.4~43.6
835	Body	0.97	0.92~1.02	55.2	52.4~58.0
1800	Head	1.40	1.33~1.47	40.0	38.0~42.0
1800	Body	1.52	1.44~1.60	53.3	50.6~56.0
1900	Head	1.40	1.33~1.47	40.0	38.0~42.0
1900	Body	1.52	1.44~1.60	53.3	50.6~56.0
2450	Head	1.80	1.71~1.89	39.2	37.2~41.2
2450	Body	1.95	1.85~2.05	52.7	50.1~55.3
2600	Head	1.96	1.86~2.06	39.0	37.1~40.9
2600	Body	2.16	2.05~2.27	52.5	50.9~55.1
5200	Head	4.66	4.43~4.89	36.0	34.2~37.8
5200	Body	5.30	5.04~5.57	49.0	46.6~51.5
5800	Head	5.27	5.01~5.53	35.3	33.5~37.1
5800	Body	6.00	5.70~6.30	48.2	45.8~50.6

7.2. Dielectric Performance

Table 7.2: Dielectric Performance of Tissue Simulating Liquid

Measurement Value						
Liquid Temperature: 22.5 °C						
Type	Frequency	Permittivity ϵ	Drift (%)	Conductivity σ	Drift (%)	Test Date
Body	835 MHz	56.713	2.74%	0.996	2.68%	2018/10/29
Body	1800 MHz	53.936	1.19%	1.415	-6.91%	2018/12/29
Body	1900 MHz	52.061	-2.32%	1.551	2.04%	2018/11/15
Body	2450 MHz	53.364	1.26%	1.901	-2.51%	2018/11/16
Body	2600 MHz	52.513	0.02%	2.101	-2.73%	2019/01/30

8. System verification

8.1. System Setup

In the simplified setup for system evaluation, the DUT is replaced by a calibrated dipole and the power source is replaced by a continuous wave that comes from a signal generator. The calibrated dipole must be placed beneath the flat phantom section of the SAM twin phantom with the correct distance holder. The distance holder should touch the phantom surface with a light pressure at the reference marking and be oriented parallel to the phantom surface with a light pressure at the reference marking and be oriented parallel to the long side of the phantom. The equipment setup is shown below:

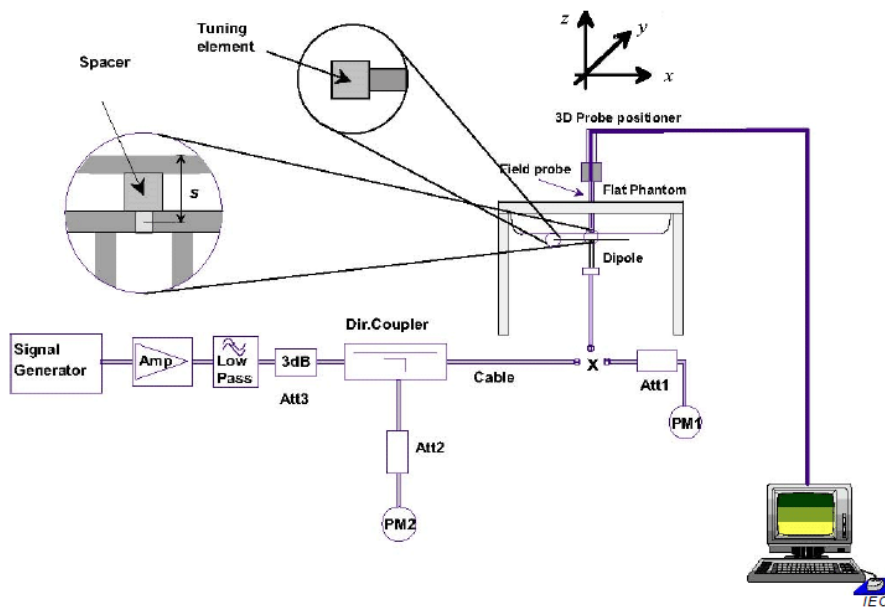

Picture 8.1 System Setup for System Evaluation



Picture 8.2 Photo of Dipole Setup

8.2. System Verification

SAR system verification is required to confirm measurement accuracy, according to the tissue dielectric media, probe calibration points and other system operating parameters required for measuring the SAR of test device. The system verification must be performed for each frequency band and within the valid range of each probe calibration point required for testing the device.

Table 8.1: System Verification of Body

Verification Results							
Input power level: 1W							
Frequency	Target value (W/kg)		Measured value (W/kg)		Deviation		Test date
	10 g Average	1 g Average	10 g Average	1 g Average	10 g Average	1 g Average	
835 MHz	6.40	9.75	6.64	9.88	3.75%	1.33%	2018/10/29
1750 MHz	19.9	37.4	19.8	37.44	-0.50%	0.11%	2018/12/29
1900 MHz	21.2	40.4	21.56	41.2	1.70%	1.98%	2018/11/15
2450 MHz	23.5	50.5	24.48	52.48	4.17%	3.92%	2018/11/16
2600 MHz	24.1	54.3	25.0	56.4	3.73%	3.87%	2019/01/30

9. Measurement Procedures

9.1. Tests to be performed

According to the SAR test standard, the recommended procedure for assessing the peak spatial-average SAR value consists of the following steps:

- (a) Power reference measurement
- (b) Area scan
- (c) Zoom scan
- (d) Power drift measurement

The SAR measurement procedures for each of test conditions are as follows:

- (a) Make EUT to transm it maximum output power
- (b) Measure conducted output power through RF cable
- (c) Place the EUT in the specific position of phantom as Appendix D demonstrates.
- (d) Measure SAR results for Middle channel or the highest power channel on each testing position.
- (e) Measure SAR results for other channels in worst SAR testing position if the reported SAR of highest power channel is larger than 0.8 W/kg
- (f) Record the SAR value

9.2. General Measurement Procedure

The area and zoom scan resolutions specified in the table below must be applied to the SAR measurements and fully documented in SAR reports to qualify for TCB approval. Probe boundary effect error compensation is required for measurements with the probe tip closer than half a probe tip diameter to the phantom surface. Both the probe tip diameter and sensor offset distance must satisfy measurement protocols; to ensure probe boundary effect errors are minimized and the higher fields closest to the phantom surface can be correctly measured and extrapolated to the phantom surface for computing 1-g SAR. Tolerances of the post-processing algorithms must be verified by the test laboratory for the scan resolutions used in the SAR measurements, according to the reference distribution functions specified in IEEE Std 1528-2013. The results should be documented as part of the system validation records and may be requested to support test results when all the measurement parameters in the following table are not satisfied.

		≤ 3 GHz	> 3 GHz
Maximum distance from closest measurement point (geometric center of probe sensors) to phantom surface		$5 \text{ mm} \pm 1 \text{ mm}$	$\frac{1}{2} \cdot \delta \cdot \ln(2) \text{ mm} \pm 0.5 \text{ mm}$
Maximum probe angle from probe axis to phantom surface normal at the measurement location		$30^\circ \pm 1^\circ$	$20^\circ \pm 1^\circ$
Maximum area scan spatial resolution: Δx_{Area} , Δy_{Area}		≤ 2 GHz: $\leq 15 \text{ mm}$ 2 – 3 GHz: $\leq 12 \text{ mm}$	3 – 4 GHz: $\leq 12 \text{ mm}$ 4 – 6 GHz: $\leq 10 \text{ mm}$
		When the x or y dimension of the test device, in the measurement plane orientation, is smaller than the above, the measurement resolution must be \leq the corresponding x or y dimension of the test device with at least one measurement point on the test device.	
Maximum zoom scan spatial resolution: Δx_{Zoom} , Δy_{Zoom}		≤ 2 GHz: $\leq 8 \text{ mm}$ 2 – 3 GHz: $\leq 5 \text{ mm}^*$	3 – 4 GHz: $\leq 5 \text{ mm}^*$ 4 – 6 GHz: $\leq 4 \text{ mm}^*$
Maximum zoom scan spatial resolution, normal to phantom surface	uniform grid: $\Delta z_{Zoom}(n)$	$\leq 5 \text{ mm}$	3 – 4 GHz: $\leq 4 \text{ mm}$ 4 – 5 GHz: $\leq 3 \text{ mm}$ 5 – 6 GHz: $\leq 2 \text{ mm}$
	graded grid	$\Delta z_{Zoom}(1)$: between 1 st two points closest to phantom surface	$\leq 4 \text{ mm}$
		$\Delta z_{Zoom}(n>1)$: between subsequent points	$\leq 1.5 \cdot \Delta z_{Zoom}(n-1) \text{ mm}$
Minimum zoom scan volume	x, y, z	$\geq 30 \text{ mm}$	3 – 4 GHz: $\geq 28 \text{ mm}$ 4 – 5 GHz: $\geq 25 \text{ mm}$ 5 – 6 GHz: $\geq 22 \text{ mm}$
Note: δ is the penetration depth of a plane-wave at normal incidence to the tissue medium; see IEEE Std 1528-2013 for details. * When zoom scan is required and the <i>reported</i> SAR from the <i>area scan based 1-g SAR estimation</i> procedures of KDB Publication 447498 is $\leq 1.4 \text{ W/kg}$, $\leq 8 \text{ mm}$, $\leq 7 \text{ mm}$ and $\leq 5 \text{ mm}$ zoom scan resolution may be applied, respectively, for 2 GHz to 3 GHz, 3 GHz to 4 GHz and 4 GHz to 6 GHz.			

9.3. WCDMA Measurement Procedures for SAR

The following procedures are applicable to WCDMA handsets operating under 3GPP Release99, Release 5 and Release 6. The default test configuration is to measure SAR with an established radio link between the DUT and a communication test set using a 12.2kbps RMC (reference measurement channel) configured in Test Loop Mode 1. SAR is selectively confirmed for other physical channel configurations (DPCCH & DPDCH_n), HSDPA and HSPA (HSUPA/HSDPA) modes according to output power, exposure conditions and device operating capabilities. Both uplink and downlink should be configured with the same RMC or AMR, when required. SAR for Release 5 HSDPA and Release 6 HSPA are measured using the applicable FRC (fixed reference channel) and E-DCH reference channel configurations. Maximum output power is verified according to applicable versions of 3GPP TS 34.121 and SAR must be measured according to these maximum output conditions. When Maximum Power Reduction (MPR) is not implemented

according to Cubic Metric (CM) requirements for Release 6 HSPA, the following procedures do not apply.

For Release 5 HSDPA Data Devices:

Sub-test	β_c	β_d	β_d (SF)	β_c / β_d	β_{hs}	CM/dB	MPR (dB)
1	2/15	15/15	64	2/15	4/15	1.5	0.5
2	12/15	15/15	64	12/15	24/25	2.0	1
3	15/15	8/15	64	15/8	30/15	2.0	1
4	15/15	4/15	64	15/4	30/15	2.0	1

For Release 6 HSUPA Data Devices

Sub-test	β_c	β_d	β_d (SF)	β_c / β_d	β_{hs}	β_{ec}	β_{ed}	β_{ed} (SF)	β_{ed} (codes)	CM (dB)	MPR (dB)	AG Index	E-TFCI
1	11/15	15/15	64	11/15	22/15	209/225	1039/225	4	1	2.0	1.0	20	75
2	6/15	15/15	64	6/15	12/15	12/15	12/15	4	1	3.0	2.0	12	67
3	15/15	9/15	64	15/9	30/15	30/15	$\beta_{ed1}:47/15$ $\beta_{ed2}:47/15$	4	2	3.0	2.0	15	92
4	2/15	15/15	64	2/15	4/15	4/15	56/75	4	1	2.0	1.0	17	71
5	15/15	15/15	64	15/15	24/15	30/15	134/15	4	1	2.0	1.0	21	81

9.4. Bluetooth & WiFi Measurement Procedures for SAR

Normal network operating configurations are not suitable for measuring the SAR of 802.11 transmitters in general. Unpredictable fluctuations in network traffic and antenna diversity conditions can introduce undesirable variations in SAR results. The SAR for these devices should be measured using chipset based test mode software to ensure that the results are consistent and reliable.

Chipset based test mode software is hardware dependent and generally varies among manufacturers. The device operating parameters established in a test mode for SAR measurements must be identical to those programmed in production units, including output power levels, amplifier gain settings and other RF performance tuning parameters. The test frequencies should correspond to actual channel frequencies defined for domestic use. SAR for devices with switched diversity should be measured with only one

antenna transmitting at a time during each SAR measurement, according to a fixed modulation and data rate. The same data pattern should be used for all measurements.

9.5. Power Drift

To control the output power stability during the SAR test, DASY4 system calculates the power drift by measuring the E-field at the same location at the beginning and at the end of the measurement for each test position. These drift values can be found in Section 13 labeled as: (Power Drift [dB]). This ensures that the power drift during one measurement is within 5%.

10. Conducted Output Power

Table 10.1: GPRS (GMSK Modulation)

GSM 850				
Channel		128	190	251
1 Txslots	Maximum Target Value (dBm)	33.5	33.5	33.5
2 Txslots	Maximum Target Value (dBm)	32.5	32.5	32.5
3 Txslots	Maximum Target Value (dBm)	30.5	30.5	30.5
4 Txslots	Maximum Target Value (dBm)	28.5	28.5	28.5
GSM 1900				
Channel		512	661	810
1 Txslots	Maximum Target Value (dBm)	30.5	30.5	30.5
2 Txslots	Maximum Target Value (dBm)	28.5	28.5	28.5
3 Txslots	Maximum Target Value (dBm)	26.5	26.5	26.5
4 Txslots	Maximum Target Value (dBm)	24.5	24.5	24.5

Table 10.2: EGPRS (8-PSK Modulation)

GSM 850				
Channel		128	190	251
1 Txslots	Maximum Target Value (dBm)	25.5	25.5	25.5
2 Txslots	Maximum Target Value (dBm)	25.0	25.0	25.0
3 Txslots	Maximum Target Value (dBm)	24.0	24.0	24.0
4 Txslots	Maximum Target Value (dBm)	23.0	23.0	23.0
GSM 1900				
Channel		512	661	810
1 Txslots	Maximum Target Value (dBm)	25.5	25.5	25.5
2 Txslots	Maximum Target Value (dBm)	24.5	24.5	24.5
3 Txslots	Maximum Target Value (dBm)	22.5	22.5	22.5
4 Txslots	Maximum Target Value (dBm)	20.5	20.5	20.5

Table 10.3: WCDMA

WCDMA Band II			
Channel	Channel 9262	Channel 9400	Channel 9538
Maximum Target Value (dBm)	24.0	24.0	24.0

WCDMA Band II HSDPA				
Channel		9262	9400	9538
1	Maximum Target Value (dBm)	23.0	23.0	23.0
2	Maximum Target Value (dBm)	23.0	23.0	23.0
3	Maximum Target Value (dBm)	22.5	22.5	22.5
4	Maximum Target Value (dBm)	22.5	22.5	22.5
WCDMA Band II HSUPA				
Channel		9262	9400	9538
1	Maximum Target Value (dBm)	22.5	22.5	22.5
2	Maximum Target Value (dBm)	22.0	22.0	22.0
3	Maximum Target Value (dBm)	22.0	22.0	22.0
4	Maximum Target Value (dBm)	22.5	22.5	22.5
5	Maximum Target Value (dBm)	22.5	22.5	22.5

Table 10.4: WCDMA

WCDMA Band IV			
Channel	1312	1413	1513
Maximum Target Value (dBm)	23.5	23.5	23.5

WCDMA Band IV HSDPA				
Channel		1312	1413	1513
1	Maximum Target Value (dBm)	23.0	23.0	23.0
2	Maximum Target Value (dBm)	23.0	23.0	23.0
3	Maximum Target Value (dBm)	22.5	22.5	22.5
4	Maximum Target Value (dBm)	22.5	22.5	22.5
WCDMA Band IV HSUPA				
Channel		1312	1413	1513
1	Maximum Target Value (dBm)	22.5	22.5	22.5
2	Maximum Target Value (dBm)	22.0	22.0	22.0
3	Maximum Target Value (dBm)	22.0	22.0	22.0
4	Maximum Target Value (dBm)	22.5	22.5	22.5
5	Maximum Target Value (dBm)	22.5	22.5	22.5

Table 10.5: WCDMA

WCDMA Band V			
Channel	4132	4183	4233
Maximum Target Value (dBm)	24.0	24.0	24.0

WCDMA Band V HSDPA				
Channel		4132	4183	4233
1	Maximum Target Value (dBm)	23.5	23.5	23.5
2	Maximum Target Value (dBm)	23.5	23.5	23.5
3	Maximum Target Value (dBm)	23.0	23.0	23.0
4	Maximum Target Value (dBm)	23.0	23.0	23.0

WCDMA Band V HSUPA				
Channel		4132	4183	4233
1	Maximum Target Value (dBm)	23.0	23.0	23.0
2	Maximum Target Value (dBm)	22.0	22.0	22.0
3	Maximum Target Value (dBm)	22.0	22.0	22.0
4	Maximum Target Value (dBm)	22.5	22.5	22.5
5	Maximum Target Value (dBm)	22.5	22.5	22.5

Table 10.6: LTE

LTE Band2			
RB Size	1	50%	100%
Maximum Target Value (dBm)	22.5	22.5	22.0
LTE Band4			
RB Size	1	50%	100%
Maximum Target Value (dBm)	22.5	22.5	22.0
LTE Band7			
RB Size	1	50%	100%
Maximum Target Value (dBm)	23.0	22.5	22.5

Table 10.7: WiFi

WiFi 802.11b 2.4G			
Channel	Channel 1	Channel 6	Channel 11
Maximum Target Value (dBm)	15.5	15.0	14.5
WiFi 802.11g 2.4G			
Channel	Channel 1	Channel 6	Channel 11
Maximum Target Value (dBm)	13.0	12.5	12.0
WiFi 802.11n 20M 2.4G			
Channel	Channel 1	Channel 6	Channel 11
Maximum Target Value (dBm)	12.0	11.5	11.0
WiFi 802.11n 40M 2.4G			
Channel	Channel 3	Channel 6	Channel 9
Maximum Target Value (dBm)	10.5	10.5	10.5

Table 10.8: Bluetooth

Bluetooth			
Channel	Channel 0	Channel 39	Channel 78
Maximum Target Value (dBm)	5.0	5.0	5.0

Table 10.9: BLE

Bluetooth			
Channel	Channel 0	Channel 19	Channel 39
Maximum Target Value (dBm)	-1.5	-1.5	-1.5

Table 10.10: CDMA

Band	CDMA2000 BC0			CDMA2000 BC1		
	1013	384	777	25	600	1175
Channel	1013	384	777	25	600	1175
Frequency (MHz)	824.7	836.52	848.31	1851.25	1880.00	1908.75
1xRTT RC1 SO55	24.5	24.5	24.5	24.0	24.0	24.0
1xRTT RC3 SO55	24.5	24.5	24.5	24.0	24.0	24.0
1xRTT RC3 SO32(+ F-SCH)	24.5	24.5	24.5	24.0	24.0	24.0
1xRTT RC3 SO32(+SCH)	24.5	24.5	24.5	24.0	24.0	24.0
1xEVDO RTAP 153.6Kbps	25.0	25.0	25.0	24.0	24.0	24.0
1xEVDO RETAP 4096Bits	24.5	24.5	24.5	24.0	24.0	24.0

10.1. GSM Measurement result

During the process of testing, the EUT was controlled via Agilent Digital Radio Communication tester (E5515C) to ensure the maximum power transmission and proper modulation. This result contains conducted output power for the EUT. In all cases, the measured peak output power should be greater and within 5% than EMI measurement.

Table 10.11: The conducted power measurement results for GPRS/EGPRS

GSM 850 GMSK	Measured Power (dBm)			calculation	Averaged Power (dBm)		
	128	190	251		128	190	251
1 Txslot	32.57	32.67	32.65	-9.03dB	23.54	23.64	23.62
2 Txslots	31.38	31.41	31.4	-6.02dB	25.36	25.39	25.38
3 Txslots	29.7	29.69	29.71	-4.26dB	25.44	25.43	25.45
4 Txslots	27.66	27.65	27.7	-3.01dB	24.65	24.64	24.69
GSM 1900 GMSK	Measured Power (dBm)			calculation	Averaged Power (dBm)		
	512	661	810		512	661	810
1 Txslot	29.51	29.6	29.55	-9.03dB	20.48	20.57	20.52
2 Txslots	27.31	27.33	27.32	-6.02dB	21.29	21.31	21.3
3 Txslots	25.49	25.52	25.44	-4.26dB	21.23	21.26	21.18
4 Txslots	23.89	24.01	24	-3.01dB	20.88	21	20.99

Table 10.12: The conducted power measurement results for E-GPRS

GSM 850 8-PSK	Measured Power (dBm)			calculation	Averaged Power (dBm)		
	128	190	251		128	190	251
1 Txslot	24.94	25.04	25.07	-9.03dB	15.91	16.01	16.04
2 Txslots	24.41	24.46	24.43	-6.02dB	18.39	18.44	18.41
3 Txslots	23.38	23.32	23.38	-4.26dB	19.12	19.06	19.12
4 Txslots	22.02	22.04	22.08	-3.01dB	19.01	19.03	19.07
GSM 1900 8-PSK	Measured Power (dBm)			calculation	Averaged Power (dBm)		
	512	661	810		512	661	810
1 Txslot	24.71	24.79	24.73	-9.03dB	15.68	15.76	15.7
2 Txslots	23.92	23.98	23.99	-6.02dB	17.9	17.96	17.97
3 Txslots	21.51	21.54	21.57	-4.26dB	17.25	17.28	17.31
4 Txslots	19.83	19.88	19.85	-3.01dB	16.82	16.87	16.84

NOTES:

1) Division Factors

To average the power, the division factor is as follows:

1TX-slot = 1 transmit time slot out of 8 time slots=> conducted power divided by (8/1) => -9.03dB

2TX-slots = 2 transmit time slots out of 8 time slots=> conducted power divided by (8/2) => -6.02dB

3TX-slots = 3 transmit time slots out of 8 time slots=> conducted power divided by (8/3) => -4.26dB

4TX-slots = 4 transmit time slots out of 8 time slots=> conducted power divided by (8/4) => -3.01dB

According to the conducted power as above, the body measurements are performed with 3Txslots for 850MHz ; 2Txslots for 1900MHz;

10.2. WCDMA Measurement result

Table 10.13: The conducted Power for WCDMA

Item	band	WCDMA BAND II result(dBm)		
	ARFCN	9262 (1852.4MHz)	9400 (1880.0MHz)	9538 (1907.6MHz)
WCDMA	\	23.58	23.6	23.51
HSDPA	1	22.86	22.87	22.77
	2	22.64	22.67	22.59
	3	22.31	22.37	22.3
	4	22.23	22.27	22.17
HSUPA	1	22.21	22.27	22.16
	2	21.26	21.21	21.2
	3	21.25	21.35	21.13
	4	22.06	22.05	22.04
	5	21.86	21.95	21.93
Item	band	WCDMA BAND V result(dBm)		
	ARFCN	Channel 4132 (826.4MHz)	Channel 4183 (836.6MHz)	Channel 4233 (846.6MHz)
WCDMA	\	23.45	23.52	23.41
HSDPA	1	22.7	22.78	22.69
	2	22.5	22.6	22.45
	3	22.23	22.29	22.2
	4	22.13	22.22	22.1
HSUPA	1	22.13	22.19	22.03
	2	21.1	21.2	21.04
	3	21.1	21.25	21.08
	4	22.03	22.02	21.96
	5	21.74	21.85	21.79
Item	band	WCDMA BAND IV result(dBm)		
	ARFCN	Channel 1312 (1712.4MHz)	Channel 1413 (1732.6MHz)	Channel 1513 (1752.6MHz)
WCDMA	\	23.28	23.42	23.06
HSDPA	1	22.53	22.68	22.34
	2	22.33	22.5	22.1
	3	22.06	22.19	21.85
	4	21.96	22.12	21.75
HSUPA	1	21.96	22.09	21.68
	2	20.93	21.1	20.69
	3	20.93	21.15	20.73
	4	21.86	21.92	21.61
	5	21.57	21.75	21.44

10.3. LTE Measurement result

Table 10.14: The conducted Power for LTE BAND 2/4/7/17

Band2						
Bandwidth	Mode	RB Size	RB Offset	Actual output power(dBm)		
				Channel 18625 1852.5MHz	Channel 18900 1880MHz	Channel 19175 1907.5MHz
5MHz	QPSK	1	0	21.7	21.98	21.95
		1	13	21.79	21.96	22.12
		1	24	21.84	21.87	22.12
		12	0	20.95	20.99	21.13
		12	6	20.98	21	21.19
		12	13	20.95	21.02	21.34
		25	0	20.94	21.01	21.19
	16QAM	1	0	20.88	20.33	20.44
		1	13	20.99	21.09	20.57
		1	24	20.98	20.93	20.61
		12	0	19.8	19.87	19.88
		12	6	19.83	19.88	20
		12	13	19.91	19.77	20.26
		25	0	19.8	19.89	20.06
Bandwidth	Mode	RB Size	RB Offset	Actual output power(dBm)		
				Channel 18650 1855MHz	Channel 18900 1880MHz	Channel 19150 1905MHz
10MHz	QPSK	1	0	21.87	21.91	22.27
		1	25	22.07	22.08	22.14
		1	49	21.78	21.81	22.15
		25	0	21.03	21.07	20.97
		25	13	21.06	21.17	21.14
		25	25	21.08	21.13	21.17
		50	0	20.92	21.14	21.11
	16QAM	1	0	20.83	20.92	21.05
		1	25	21.41	21.44	21.54
		1	49	20.71	21.08	20.83
		25	0	19.99	20.24	20.18
		25	13	20.12	20.28	20.22
		25	25	20	20.2	20.2
		50	0	20.06	20.2	20.09

Bandwidth	Mode	RB Size	RB Offset	Actual output power(dBm)		
				Channel 18675 1857.5MHz	Channel 18900 1880MHz	Channel 19125 1902.5MHz
15MHz	QPSK	1	0	21.98	21.94	22.21
		1	37	22.16	22.18	22.18
		1	74	21.92	21.96	22.24
		36	0	21.18	21.17	21.17
		36	19	21.21	21.31	21.23
		36	38	21.18	21.24	21.16
		75	0	21.17	21.19	21.2
	16QAM	1	0	20.76	20.74	20.69
		1	37	21.23	21.46	20.61
		1	74	20.63	20.98	21.38
		36	0	19.88	19.98	20.13
		36	19	20.01	20.13	20.2
		36	38	20.08	20.07	20.06
		75	0	19.97	20.01	20.07
Bandwidth	Mode	RB Size	RB Offset	Actual output power(dBm)		
				Channel 18700 1860MHz	Channel 18900 1880MHz	Channel 19100 1900MHz
20MHz	QPSK	1	0	21.92	21.96	22.12
		1	50	22.32	22.39	22.33
		1	99	21.83	21.86	22.2
		50	0	21.08	21.12	21.02
		50	25	21.21	21.23	21.21
		50	50	21.13	21.18	21.22
		100	0	21.17	21.29	21.26
	16QAM	1	0	20.88	20.97	21.1
		1	50	21.46	21.49	21.59
		1	99	20.76	21.13	20.88
		50	0	20.04	20.29	20.23
		50	25	20.17	20.33	20.27
		50	50	20.05	20.25	20.25
		100	0	20.11	20.25	20.14

Bandwidth	Mode	RB Size	RB Offset	Actual output power(dBm)		
				Channel 18615 1851.5MHz	Channel 18900 1880MHz	Channel 19185 1908.5MHz
3MHz	QPSK	1	0	21.34	21.41	21.54
		1	7	21.12	21.32	21.43
		1	14	21.06	21.54	21.57
		8	0	20.43	20.74	20.62
		8	4	20.49	20.76	20.68
		8	7	20.48	20.73	20.66
		15	0	20.44	20.6	20.63
	16QAM	1	0	21.03	20.59	21.07
		1	7	21.25	21.2	20.7
		1	14	21.24	20.61	20.79
		8	0	19.99	20.19	20.27
		8	4	20.02	20.22	20.36
		8	7	20.08	20.19	20.36
		15	0	20.01	20.13	20.14
Bandwidth	Mode	RB Size	RB Offset	Actual output power(dBm)		
				Channel 18607 1850.7MHz	Channel 18900 1880MHz	Channel 19193 1909.3MHz
1.4MHz	QPSK	1	0	22.09	22.12	22.21
		1	3	22.15	22.33	22.24
		1	5	21.98	22.27	22.15
		3	0	22.03	22.25	22.23
		3	1	21.98	22.29	22.32
		3	3	21.88	22.07	22.32
		6	0	20.91	21.08	21.29
	16QAM	1	0	20.91	21.32	20.79
		1	3	21.17	21.33	21.57
		1	5	21.17	21.25	21.39
		3	0	20.86	21.24	21.16
		3	1	20.8	20.95	21.35
		3	3	20.88	20.93	21.27
		6	0	20	19.9	20.27

Band4						
Bandwidth	Mode	RB Size	RB Offset	Actual output power(dBm)		
				Channel 19975 1712.5MHz	Channel 20175 1732.5MHz	Channel 20375 1752.5MHz
5MHz	QPSK	1	0	21.84	22.01	21.76
		1	13	21.77	22.05	21.85
		1	24	21.68	21.8	21.97
		12	0	20.93	21.08	20.81
		12	6	20.86	21.12	20.79
		12	13	20.88	21.2	20.98
		25	0	20.9	21.18	20.81
	16QAM	1	0	20.3	21.11	20.11
		1	13	20.93	21.17	20.73
		1	24	20.82	20.92	20.63
		12	0	20.01	19.98	20.06
		12	6	19.89	20.13	19.9
		12	13	19.79	20.11	19.72
		25	0	19.9	20.08	19.84
Bandwidth	Mode	RB Size	RB Offset	Actual output power(dBm)		
				Channel 20000 1715MHz	Channel 20175 1732.5MHz	Channel 20350 1750MHz
10MHz	QPSK	1	0	21.82	21.8	21.96
		1	25	21.91	22.19	21.87
		1	49	21.68	21.92	21.88
		25	0	20.95	21.07	21
		25	13	20.94	21.12	20.89
		25	25	20.86	21.03	20.7
		50	0	20.95	21.01	20.88
	16QAM	1	0	20.74	20.84	20.84
		1	25	21.29	21.47	20.73
		1	49	20.67	20.82	20.55
		25	0	19.95	20.13	20.08
		25	13	20.03	20.23	20.01
		25	25	19.98	20.23	20.01
		50	0	19.96	20.17	20.08

Bandwidth	Mode	RB Size	RB Offset	Actual output power(dBm)		
				Channel 20025 1717.5MHz	Channel 20175 1732.5MHz	Channel 20325 1747.5MHz
15MHz	QPSK	1	0	22.03	21.71	22.21
		1	38	22.19	22.19	22.36
		1	74	21.81	21.86	22
		36	0	21.03	21.26	21.05
		36	18	21.11	21.27	21.08
		36	39	21.02	21.2	20.93
		75	0	21.13	21.18	21.12
	16QAM	1	0	20.7	20.54	20.78
		1	38	20.44	21.32	21.17
		1	74	20.53	20.72	20.54
		36	0	19.98	20.24	19.98
		36	18	19.98	20.23	20.01
		36	39	19.94	20.17	19.76
		75	0	19.99	20.13	20.03
Bandwidth	Mode	RB Size	RB Offset	Actual output power(dBm)		
				Channel 20050 1720MHz	Channel 20175 1732.5MHz	Channel 20300 1745MHz
20MHz	QPSK	1	0	21.88	21.73	21.93
		1	50	22.25	22.37	22.13
		1	99	21.86	21.68	21.52
		50	0	20.86	21.03	21.01
		50	25	20.84	21.14	20.96
		50	50	20.82	21.03	20.86
		100	0	20.89	20.96	20.93
	16QAM	1	0	20.72	20.82	21
		1	50	20.85	21.47	21.38
		1	99	20.66	20.77	20.64
		50	0	20.16	20.18	20.18
		50	25	20.19	20.21	20.06
		50	50	20.06	20.15	19.96
		100	0	20.08	20.12	20.02

Bandwidth	Mode	RB Size	RB Offset	Actual output power(dBm)		
				Channel 19965 1711.5MHz	Channel 20175 1732.5MHz	Channel 20385 1753.5MHz
3MHz	QPSK	1	0	21.16	21.58	21.02
		1	8	21.29	21.44	21.11
		1	14	21.42	21.53	21.24
		8	0	20.53	20.7	20.32
		8	4	20.58	20.68	20.37
		8	7	20.53	20.62	20.22
		15	0	20.43	20.62	20.29
	16QAM	1	0	20.39	20.34	20.01
		1	8	20.31	21.15	20.18
		1	15	20.51	20.37	20.23
		8	0	19.75	20.23	19.95
		8	4	20.06	20.15	19.93
		8	7	20.05	20.22	19.78
		15	0	19.9	20.16	19.56
Bandwidth	Mode	RB Size	RB Offset	Actual output power(dBm)		
				Channel 19957 1710.7MHz	Channel 20175 1732.5MHz	Channel 20393 1754.3MHz
1.4MHz	QPSK	1	0	21.79	21.87	21.98
		1	2	21.86	22.07	21.92
		1	5	21.91	21.9	21.99
		3	0	21.95	22.18	21.94
		3	1	22.01	22.21	21.98
		3	2	21.95	22.21	21.83
		6	0	20.97	21.25	20.72
	16QAM	1	0	20.58	20.83	21.03
		1	2	20.74	20.99	21.06
		1	5	20.76	20.84	20.45
		3	0	20.88	20.71	20.84
		3	1	20.93	21.06	20.86
		3	2	21.05	21.2	20.91
		6	0	20.02	20.13	19.96

Band7						
Bandwidth	Mode	RB Size	RB Offset	Actual output power(dBm)		
				Channel 20775 2502.5MHz	Channel 21100 2535MHz	Channel 21425 2567.5MHz
5MHz	QPSK	1	0	22.38	22.32	22.31
		1	13	22.42	22.33	22.28
		1	24	22.32	22.35	22.09
		12	0	21.65	21.48	21.54
		12	6	21.6	21.46	21.54
		12	13	21.74	21.58	21.45
		25	0	21.68	21.6	21.5
	16QAM	1	0	21.13	20.73	21.47
		1	13	21.34	20.82	20.86
		1	24	21.15	20.98	21.09
		12	0	20.61	20.41	20.67
		12	6	20.45	20.34	20.38
		12	13	20.44	20.39	20.37
		25	0	20.63	20.59	20.54
Bandwidth	Mode	RB Size	RB Offset	Actual output power(dBm)		
				Channel 20800 2505MHz	Channel 21100 2535MHz	Channel 21400 2565MHz
10MHz	QPSK	1	0	22.36	22.3	22.52
		1	25	22.45	22.38	22.36
		1	49	22.38	22.39	22.14
		25	0	21.67	21.5	21.56
		25	13	21.62	21.45	21.51
		25	25	21.71	21.51	21.51
		50	0	21.65	21.54	21.59
	16QAM	1	0	21.76	21.23	21.04
		1	25	21.8	21.06	21.05
		1	49	21.44	21.71	21.16
		25	0	20.59	20.45	20.35
		25	13	20.71	20.52	20.41
		25	25	20.66	20.56	20.32
		50	0	20.61	20.51	20.4

Bandwidth	Mode	RB Size	RB Offset	Actual output power(dBm)		
				Channel 20825 2507.5MHz	Channel 21100 2535MHz	Channel 21375 2562.5MHz
15MHz	QPSK	1	0	22.34	22.38	22.25
		1	38	22.49	22.47	22.41
		1	74	21.58	21.43	21.55
		36	0	21.69	21.44	21.49
		36	18	21.61	21.49	21.5
		36	39	21.63	21.55	21.59
		75	0	21.85	21.67	21.48
	16QAM	1	0	21.33	21.63	21.04
		1	38	21.82	21.73	21.71
		1	74	20.48	20.45	20.53
		36	0	20.61	20.37	20.47
		36	18	20.65	20.42	20.5
		36	39	20.56	20.57	20.66
		75	0	22.34	22.38	22.25
Bandwidth	Mode	RB Size	RB Offset	Actual output power(dBm)		
				Channel 20850 2510MHz	Channel 21100 2535MHz	Channel 21350 2560MHz
20MHz	QPSK	1	0	22.33	22.19	22.04
		1	50	22.54	22.41	22.41
		1	99	22.32	22.1	22.08
		50	0	21.52	21.28	21.41
		50	25	21.76	21.64	21.61
		50	50	21.45	21.44	21.35
		100	0	21.49	21.43	21.38
	16QAM	1	0	21.32	21.61	21.35
		1	50	21.15	21.85	21.31
		1	99	20.7	21.75	21.79
		50	0	20.51	20.56	20.48
		50	25	20.59	20.5	20.52
		50	50	20.55	20.48	20.58
		100	0	20.74	20.55	20.5

Band17						
Bandwidth	Mode	RB Size	RB Offset	Actual output power(dBm)		
				Channel 23755 706.5 MHz	Channel 23790 710 MHz	Channel 23825 713.5MHz
5MHz	QPSK	1	0	22.55	22.49	22.24
		1	12	22.6	22.62	22.59
		1	24	22.57	22.64	22.38
		12	0	21.56	21.59	21.68
		12	6	21.64	21.69	21.7
		12	13	21.55	21.64	21.66
		25	0	21.67	21.58	21.64
	16QAM	1	0	21.02	20.98	21.15
		1	12	21.63	21.01	21.8
		1	24	21.66	21.22	21.33
		12	0	20.5	20.34	20.49
		12	6	20.59	20.74	20.64
		12	13	20.72	20.59	20.39
		25	0	20.83	20.61	20.59
Bandwidth	Mode	RB Size	RB Offset	Actual output power(dBm)		
				Channel 23780 709MHz	Channel 23790 710 MHz	Channel 23800 711 MHz
10MHz	QPSK	1	0	22.39	22.6	22.31
		1	25	22.66	22.55	22.59
		1	49	22.85	22.71	22.72
		25	0	21.62	21.58	21.54
		25	13	21.78	21.69	21.59
		25	25	21.69	21.65	21.69
		50	0	21.65	21.54	21.5
	16QAM	1	0	21.47	21	20.65
		1	25	21.88	21.13	21.24
		1	49	22.06	21.1	21
		25	0	20.6	20.47	20.51
		25	13	20.77	20.67	20.79
		25	25	20.78	20.56	20.78
		50	0	20.76	20.64	20.5

10.4. WiFi and BT Measurement result

Table 10.15: The conducted power for Bluetooth

GFSK			
Channel	Ch0 (2402 MHz)	Ch39 (2441MHz)	CH78 (2480MHz)
Conducted Output Power (dBm)	4.124	4.695	3.893
$\pi/4$ DQPSK			
Channel	Ch0 (2402 MHz)	Ch39 (2441MHz)	CH78 (2480MHz)
Conducted Output Power (dBm)	3.915	4.342	3.557
8DPSK			
Channel	Ch0 (2402 MHz)	Ch39 (2441MHz)	CH78 (2480MHz)
Conducted Output Power (dBm)	4.022	4.412	4.685

Table 10.16: The conducted power for BLE

GFSK			
Channel	Ch0 (2402 MHz)	Ch19 (2440MHz)	CH39 (2480MHz)
Conducted Output Power (dBm)	-2.131	-2.244	-2.958

NOTE: According to KDB447498 D01 BT standalone SAR are not required, because maximum average output power is less than 10mW.

When the standalone SAR test exclusion is applied to an antenna that transmits simultaneously with other antennas, the standalone SAR must be estimated according to the following to determine simultaneous transmission SAR test exclusion:

(max. power of channel, including tune-up tolerance, mW)/(min. test separation distance, mm) • [$\sqrt{f(\text{GHz})/x}$] W/kg for test separation distances ≤ 50 mm;
 where $x = 7.5$ for 1-g SAR, and $x = 18.75$ for 10-g SAR.

SAR body value of BT is 0.133 W/Kg for 1g.

The default power measurement procedures are:

a) Power must be measured at each transmit antenna port according to the DSSS and OFDM transmission configurations in each standalone and aggregated frequency band.

b) Power measurement is required for the transmission mode configuration with the

highest maximum output power specified for production units.

1) When the same highest maximum output power specification applies to multiple transmission modes, the largest channel bandwidth configuration with the lowest order modulation and lowest data rate is measured.

2) When the same highest maximum output power is specified for multiple largest channel bandwidth configurations with the same lowest order modulation or lowest order modulation and lowest data rate, power measurement is required for all equivalent 802.11 configurations with the same maximum output power.

c) For each transmission mode configuration, power must be measured for the highest and lowest channels; and at the mid-band channel(s) when there are at least 3 channels. For configurations with multiple mid-band channels, due to an even number of channels, both channels should be measured.

During WLAN SAR testing EUT is configured with the WLAN continuous TX tool, and the transmission duty factor was monitored on the spectrum analyzer with zero-span setting, the duty cycle is 100%.

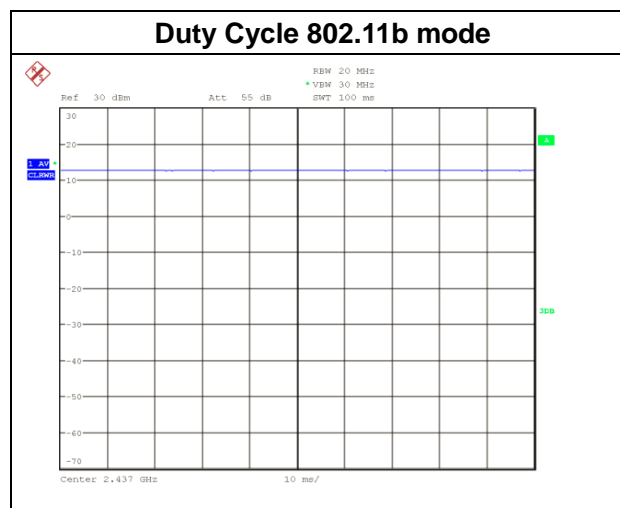

Table 10.17: The average conducted power for WiFi

Mode	Channel	Frequency	Average power(dBm)
802.11 b	1	2412 MHz	15.12
	6	2437 MHz	14.55
	11	2462 MHz	14.29
802.11 g	1	2412 MHz	12.44
	6	2437 MHz	12.03
	11	2462 MHz	11.31
802.11 n 20M	1	2412 MHz	11.72
	6	2437 MHz	10.94
	11	2462 MHz	10.29

802.11 n 40M	3	2422 MHZ	9.67
	6	2437 MHZ	9.78
	9	2452 MHZ	10.11

2.4 GHz 802.11g/n OFDM SAR Test Exclusion Requirements

When SAR measurement is required for 2.4 GHz 802.11g/n OFDM configurations, the measurement and test reduction procedures for OFDM are applied. SAR is not required for the following 2.4 GHz OFDM conditions.

- a) When KDB Publication 447498 D01 SAR test exclusion applies to the OFDM configuration.
- b) When the highest *reported* SAR for DSSS is adjusted by the ratio of OFDM to DSSS specified maximum output power and the adjusted SAR is ≤ 1.2 W/kg.

10.5. CDMA Measurement result

Table 10.18: The conducted Power for CDMA

Band	CDMA2000 BC0			CDMA2000 BC1		
Channel	1013	384	777	25	600	1175
Frequency (MHz)	824.7	836.52	848.31	1851.25	1880.00	1908.75
1xRTT RC1 SO55	24.1	23.92	24.03	23.24	23.31	23.13
1xRTT RC3 SO55	24.14	23.99	24.08	23.23	23.35	23.15
1xRTT RC3 SO32(+ F-SCH)	23.94	23.89	23.92	23.13	23.25	23.01
1xRTT RC3 SO32(+SCH)	24.11	23.82	24.11	23.27	23.28	23.11
1xEVDO RTAP 153.6Kbps	24.78	24.71	24.62	23.68	23.5	23.14
1xEVDO RETAP 4096Bits	24.34	24.38	24.45	23.55	23.52	23.13

11. Simultaneous TX SAR Considerations

11.1. Introduction

The following procedures adopted from “FCC SAR Considerations for Cell Phones with Multiple Transmitters” are applicable to handsets with built-in unlicensed transmitters such as 802.11 a/b/g and Bluetooth devices which may simultaneously transmit with the licensed transmitter.

For this device, the BT and WiFi can transmit simultaneous with other transmitters.

11.2. Transmit Antenna Separation Distances

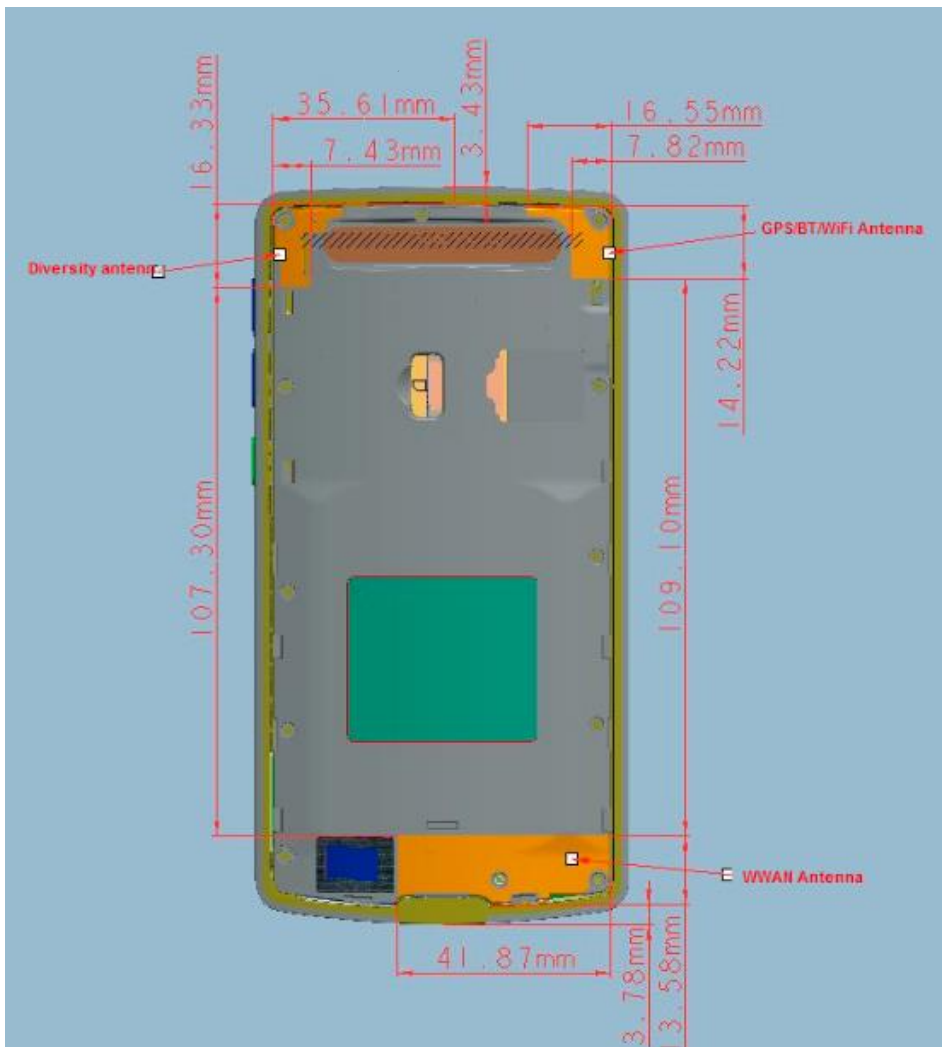

Picture 12.1 Antenna Locations

11.3. Standalone SAR Test Exclusion Considerations

Standalone 1-g head or body SAR evaluation by measurement or numerical simulation is not required when the corresponding SAR Exclusion Threshold condition, listed below, is satisfied.

The 1-g SAR test exclusion threshold for 100 MHz to 6 GHz at test separation distances \leq 50 mm are determined by:

$[(\text{max. power of channel, including tune-up tolerance, mW}) / (\text{min. test separation distance, mm})] \cdot$

$[\sqrt{f(\text{GHz})}] \leq 3.0$ for 1-g SAR, where

- $f(\text{GHz})$ is the RF channel transmit frequency in GHz
- Power and distance are rounded to the nearest mW and mm before calculation
- The result is rounded to one decimal place for comparison

According to the KDB447498 appendix A, the SAR test exclusion threshold for 2450MHz at 5mm test separation distances is 10mW.

$$\frac{(\text{max. power of channel, including tune-up tolerance, mW})}{(\text{min. test separation distance, mm})} * \sqrt{\text{Frequency (GHz)}} \leq 3.0$$

Based on the above equation, Bluetooth SAR was not required:

Evaluation=0.996 < 3.0

11.4. SAR Measurement Positions

According to the KDB941225 D06 Hot Spot SAR v01, the edges with less than 2.5 cm distance to the antennas need to be tested for SAR.

SAR Measurement Positions						
Antenna Mode	Phantom	Ground	Left	Right	Top	Bottom
WWAN	Yes	Yes	Yes	Yes	No	Yes
WLAN	Yes	Yes	No	Yes	Yes	No

12. SAR Test Result

Table 12.1: SAR Values for N03 (GSM 850 MHz Band-Body)

Frequency		Mode /Band	Service /Headset	Test Position	Spacing (mm)	Figure No.	Measured average power (dBm)	Maximum allowed Power (dBm)	Scaling factor	Measured SAR(1g) (W/kg)	Reported SAR(1g) (W/kg)	Power Drift (dB)
MHz	Ch.											
Hotspot & Body worn												
836.6	190	GPRS 3TS	Class12	Toward Phantom	5	/	29.69	30.5	1.205	0.686	0.827	-0.04
836.6	190	GPRS 3TS	Class12	Toward Ground	5	/	29.69	30.5	1.205	0.895	1.079	-0.13
824.4	128	GPRS 3TS	Class12	Toward Ground	5	/	29.7	30.5	1.202	0.945	1.136	0.16
848.8	251	GPRS 3TS	Class12	Toward Ground	5	/	29.71	30.5	1.199	0.842	1.010	-0.14
Hotspot												
836.6	190	GPRS 3TS	Class12	Toward Left	5	/	29.69	30.5	1.205	0.805	0.970	0.02
824.4	128	GPRS 3TS	Class12	Toward Left	5	/	29.7	30.5	1.202	0.771	0.927	0.05
848.8	251	GPRS 3TS	Class12	Toward Left	5	/	29.71	30.5	1.199	0.76	0.912	0.14
836.6	190	GPRS 3TS	Class12	Toward Right	5	/	29.69	30.5	1.205	0.591	0.712	-0.03
836.6	190	GPRS 3TS	Class12	Toward Bottom	5	/	29.69	30.5	1.205	0.479	0.577	-0.07
Repeated												
824.4	128	GPRS 3TS	Class12	Toward Ground	5	1	29.7	30.5	1.202	0.947	1.139	-0.04

Table 12.2: SAR Values for N03 (GSM 1900 MHz Band-Body)

Frequency		Mode /Band	Service /Headset	Test Position	Spacing (mm)	Figure No.	Measured average power (dBm)	Maximum allowed Power (dBm)	Scaling factor	Measured SAR(1g) (W/kg)	Reported SAR(1g) (W/kg)	Power Drift (dB)
MHz	Ch.											
Hotspot & Body worn												
1880	661	GPRS 2TS	Class12	Toward Phantom	5	/	27.33	28.5	1.309	0.233	0.305	0.05
1880	661	GPRS 2TS	Class12	Toward Ground	5	/	27.33	28.5	1.309	0.279	0.365	0.02
Hotspot												
1880	661	GPRS 2TS	Class12	Toward Left	5	/	27.33	28.5	1.309	0.111	0.145	-0.01
1880	661	GPRS 2TS	Class12	Toward Right	5	/	27.33	28.5	1.309	0.0554	0.073	0.03
1880	661	GPRS 2TS	Class12	Toward Bottom	5	2	27.33	28.5	1.309	0.303	0.397	0.12

Table 12.3: SAR Values for N03 (WCDMA Band II-Body)

Frequency		Mode /Band	Service /Headset	Test Position	Spacing (mm)	Figure No.	Measured average power (dBm)	Maximum allowed Power (dBm)	Scaling factor	Measured SAR(1g) (W/kg)	Reported SAR(1g) (W/kg)	Power Drift (dB)
MHz	Ch.											
Hotspot & Body worn												
1880	9400	Band II	12.2kbps RMC	Toward Phantom	5	/	23.6	24.0	1.096	0.34	0.373	0.09
1880	9400	Band II	12.2kbps RMC	Toward Ground	5	3	23.6	24.0	1.096	0.55	0.603	0.06
Hotspot												
1880	9400	Band II	12.2kbps RMC	Toward Left	5	/	23.6	24.0	1.096	0.187	0.205	-0.01
1880	9400	Band II	12.2kbps RMC	Toward Right	5	/	23.6	24.0	1.096	0.0985	0.108	-0.16
1880	9400	Band II	12.2kbps RMC	Toward Bottom	5	/	23.6	24.0	1.096	0.501	0.549	-0.07

Table 12.4: SAR Values for N03 (WCDMA Band IV-Body)

Frequency		Mode /Band	Service /Headset	Test Position	Spacing (mm)	Figure No.	Measured average power (dBm)	Maximum allowed Power (dBm)	Scaling factor	Measured SAR(1g) (W/kg)	Reported SAR(1g) (W/kg)	Power Drift (dB)
MHz	Ch.											
Hotspot & Body worn												
1732.6	1413	Band IV	12.2kbps RMC	Toward Phantom	5	/	23.42	23.5	1.019	0.695	0.708	-0.13
1732.6	1413	Band IV	12.2kbps RMC	Toward Ground	5	/	23.28	23.5	1.052	0.952	1.001	-0.12
1712.4	1312	Band IV	12.2kbps RMC	Toward Ground	5	4	23.06	23.5	1.107	1.04	1.151	-0.04
1752.6	1512	Band IV	12.2kbps RMC	Toward Ground	5	/	23.42	23.5	1.019	0.873	0.889	-0.16
Hotspot												
1732.6	1413	Band IV	12.2kbps RMC	Toward Left	5	/	23.42	23.5	1.019	0.469	0.478	-0.13
1732.6	1413	Band IV	12.2kbps RMC	Toward Right	5	/	23.42	23.5	1.019	0.078	0.079	-0.02
1732.6	1413	Band IV	12.2kbps RMC	Toward Bottom	5	/	23.42	23.5	1.019	0.612	0.623	0.09
Repeated												
1712.4	1312	Band IV	12.2kbps RMC	Toward Ground	5	/	23.06	23.5	1.107	1.03	1.140	-0.09

Table 12.5: SAR Values for N03 (WCDMA Band V-Body)

Frequency		Mode /Band	Service /Headset	Test Position	Spacing (mm)	Figure No.	Measured average power (dBm)	Maximum allowed Power (dBm)	Scaling factor	Measured SAR(1g) (W/kg)	Reported SAR(1g) (W/kg)	Power Drift (dB)
MHz	Ch.											
Hotspot & Body worn												
836.6	4183	Band V	12.2kbps RMC	Toward Phantom	5	/	23.52	24.0	1.117	0.377	0.421	0.06
836.6	4183	Band V	12.2kbps RMC	Toward Ground	5	5	23.52	24.0	1.117	0.581	0.649	0.18
Hotspot												
836.6	4183	Band V	12.2kbps RMC	Toward Left	5	/	23.52	24.0	1.117	0.366	0.409	0.16
836.6	4183	Band V	12.2kbps RMC	Toward Right	5	/	23.52	24.0	1.117	0.269	0.300	0.12
836.6	4183	Band V	12.2kbps RMC	Toward Bottom	5	/	23.52	24.0	1.117	0.25	0.279	0.04

Table 12.6: SAR Values for N03 (LTE Band 2-Body)

Frequency		Configuration	Test Position	Spacing (mm)	Figure No.	Measured average power (dBm)	Maximum allowed Power (dBm)	Scaling factor	Measured SAR(1g) (W/kg)	Reported SAR(1g) (W/kg)	Power Drift (dB)
MHz	Ch.										
Hotspot & Body worn											
1880	18900	QPSK_20MHz_1RB_50 offset Middle	Toward Phantom	5	/	22.39	22.5	1.026	0.406	0.416	0.11
1880	18900	QPSK_20MHz_1RB_50 offset Middle	Toward Ground	5	/	22.39	22.5	1.026	0.505	0.518	0.05
1880	18900	QPSK_20MHz_50RB_25 offset Middle	Toward Phantom	5	/	21.23	22.5	1.340	0.31	0.415	-0.12
1880	18900	QPSK_20MHz_50RB_25 offset Middle	Toward Ground	5	6	21.23	22.5	1.340	0.41	0.549	-0.01
Hotspot											
1880	18900	QPSK_20MHz_1RB_50 offset Middle	Toward Left	5	/	22.39	22.5	1.026	0.213	0.218	0.01
1880	18900	QPSK_20MHz_1RB_50 offset Middle	Toward Right	5	/	22.39	22.5	1.026	0.0944	0.097	-0.16
1880	18900	QPSK_20MHz_1RB_50 offset Middle	Toward Bottom	5	/	22.39	22.5	1.026	0.424	0.435	-0.11
1880	18900	QPSK_20MHz_50RB_25 offset Middle	Toward Left	5	/	21.23	22.5	1.340	0.177	0.237	0.03
1880	18900	QPSK_20MHz_50RB_25 offset Middle	Toward Right	5	/	21.23	22.5	1.340	0.0775	0.104	0.01
1880	18900	QPSK_20MHz_50RB_25 offset Middle	Toward Bottom	5	/	21.23	22.5	1.340	0.338	0.453	-0.16

Table 12.7: SAR Values for N03 (LTE Band 4-Body)

Frequency		Configuration	Test Position	Spacing (mm)	Figure No.	Measured average power (dBm)	Maximum allowed Power (dBm)	Scaling factor	Measured SAR(1g) (W/kg)	Reported SAR(1g) (W/kg)	Power Drift (dB)
MHz	Ch.										
Hotspot & Body worn											
1732.5	20175	QPSK_20MHz_1RB_50 offset Middle	Toward Phantom	5	/	22.37	22.5	1.030	0.573	0.590	0.01
1732.5	20175	QPSK_20MHz_1RB_50 offset Middle	Toward Ground	5	/	22.37	22.5	1.030	0.85	0.876	0.03
1720	20050	QPSK_20MHz_1RB_50 offset Low	Toward Ground	5	/	22.25	22.5	1.059	0.927	0.982	-0.12
1745	20300	QPSK_20MHz_1RB_50 offset High	Toward Ground	5	/	22.13	22.5	1.089	0.736	0.801	0.01
1732.5	20175	QPSK_20MHz_50RB_25 offset Middle	Toward Phantom	5	/	21.14	22.5	1.368	0.437	0.598	-0.16
1732.5	20175	QPSK_20MHz_50RB_25 offset Middle	Toward Ground	5	/	21.14	22.5	1.368	0.682	0.933	0.07
1720	20050	QPSK_20MHz_50RB_25 offset Low	Toward Ground	5	7	20.84	22.5	1.466	0.93	1.363	-0.17
1745	20300	QPSK_20MHz_50RB_25 offset High	Toward Ground	5	/	20.96	22.5	1.426	0.772	1.101	-0.12
1732.5	20175	QPSK_20MHz_100RB_0 offset Middle	Toward Ground	5	/	20.96	22.5	1.426	0.819	1.168	0.15
Hotspot											
1732.5	20175	QPSK_20MHz_1RB_50 offset Middle	Toward Left	5	/	22.37	22.5	1.030	0.354	0.365	-0.04
1732.5	20175	QPSK_20MHz_1RB_50 offset Middle	Toward Right	5	/	22.37	22.5	1.030	0.0849	0.087	0.13
1732.5	20175	QPSK_20MHz_1RB_50 offset Middle	Toward Bottom	5	/	22.37	22.5	1.030	0.576	0.594	0.07
1732.5	20175	QPSK_20MHz_50RB_25 offset Middle	Toward Left	5	/	21.14	22.5	1.368	0.283	0.387	-0.01
1732.5	20175	QPSK_20MHz_50RB_25 offset Middle	Toward Right	5	/	21.14	22.5	1.368	0.0668	0.091	-0.13
1732.5	20175	QPSK_20MHz_50RB_25 offset Middle	Toward Bottom	5	/	21.14	22.5	1.368	0.478	0.654	0.08
Repeated											
1720	20050	QPSK_20MHz_50RB_25 offset Low	Toward Ground	5	/	20.84	22.5	1.466	0.902	1.322	-0.13

Table 12.8: SAR Values for N10 (LTE Band 7-Body)

Frequency		Configuration	Test Position	Spacing (mm)	Figure No.	Measured average power (dBm)	Maximum allowed Power (dBm)	Scaling factor	Measured SAR(1g) (W/kg)	Reported SAR(1g) (W/kg)	Power Drift (dB)
MHz	Ch.										
Hotspot & Body worn											
2510	20850	QPSK_20MHz_1RB_50 offset Low	Toward Phantom	5	8	22.54	23.0	1.112	0.714	0.794	-0.11
2510	20850	QPSK_20MHz_1RB_50 offset Low	Toward Ground	5	/	22.54	23.0	1.112	0.405	0.450	0.13
2510	20850	QPSK_20MHz_50RB_25 offset Low	Toward Phantom	5	/	21.76	22.5	1.186	0.565	0.670	0.09
2510	20850	QPSK_20MHz_50RB_25 offset Low	Toward Ground	5	/	21.76	22.5	1.186	0.408	0.484	0.12
Hotspot											
2510	20850	QPSK_20MHz_1RB_50 offset Low	Toward Left	5	/	22.54	23.0	1.112	0.0863	0.096	-0.07
2510	20850	QPSK_20MHz_1RB_50 offset Low	Toward Right	5	/	22.54	23.0	1.112	<0.01	<0.01	0.18
2510	20850	QPSK_20MHz_1RB_50 offset Low	Toward Bottom	5	/	22.54	23.0	1.112	0.182	0.202	-0.01
2510	20850	QPSK_20MHz_50RB_25 offset Low	Toward Left	5	/	21.76	22.5	1.186	0.0869	0.103	0.02
2510	20850	QPSK_20MHz_50RB_25 offset Low	Toward Right	5	/	21.76	22.5	1.186	<0.01	<0.01	0.12
2510	20850	QPSK_20MHz_50RB_25 offset Low	Toward Bottom	5	/	21.76	22.5	1.186	0.218	0.258	0.08

Table 12.9: SAR Values for N03 (CDMA BC0 Band-Body)

Frequency		Mode /Band	Service /Headset	Test Position	Spacing (mm)	Figure No.	Measured average power (dBm)	Maximum allowed Power (dBm)	Scaling factor	Measured SAR(1g) (W/kg)	Reported SAR(1g) (W/kg)	Power Drift (dB)
MHz	Ch.											
Hotspot & Body worn												
836.52	384	CDMA BC0	1xEV-DO-0	Toward Phantom	5	/	24.71	25.0	1.069	0.336	0.359	0.07
836.52	384	CDMA BC0	1xEV-DO-0	Toward Ground	5	9	24.71	25.0	1.069	0.68	0.727	0.02
Hotspot												
836.52	384	CDMA BC0	1xEV-DO-0	Toward Left	5	/	24.71	25.0	1.069	0.34	0.363	0.10
836.52	384	CDMA BC0	1xEV-DO-0	Toward Right	5	/	24.71	25.0	1.069	0.439	0.469	0.19
836.52	384	CDMA BC0	1xEV-DO-0	Toward Bottom	5	/	24.71	25.0	1.069	0.176	0.188	0.14

Table 12.10: SAR Values for N03 (CDMA BC1 Band-Body)

Frequency		Mode /Band	Service /Headset	Test Position	Spacing (mm)	Figure No.	Measured average power (dBm)	Maximum allowed Power (dBm)	Scaling factor	Measured SAR(1g) (W/kg)	Reported SAR(1g) (W/kg)	Power Drift (dB)
MHz	Ch.											
Hotspot & Body worn												
1880	600	CDMA BC1	1xEV-DO-0	Toward Phantom	5	/	23.5	24.0	1.122	0.651	0.730	-0.04
1880	600	CDMA BC1	1xEV-DO-0	Toward Ground	5	10	23.5	24.0	1.122	1.02	1.144	-0.04
1851.25	25	CDMA BC1	1xEV-DO-0	Toward Ground	5	/	23.68	24.0	1.076	1.05	1.130	0.08
1908.75	1175	CDMA BC1	1xEV-DO-0	Toward Ground	5	/	23.14	24.0	1.219	0.933	1.137	0.14
Hotspot												
1880	600	CDMA BC1	1xEV-DO-0	Toward Left	5	/	23.5	24.0	1.122	0.34	0.381	0.11
1880	600	CDMA BC1	1xEV-DO-0	Toward Right	5	/	23.5	24.0	1.122	0.262	0.294	0.10
1880	600	CDMA BC1	1xEV-DO-0	Toward Bottom	5	/	23.5	24.0	1.122	0.496	0.557	0.19
Repeated												
1851.25	25	CDMA BC1	1xEV-DO-0	Toward Ground	5	/	23.68	24.0	1.076	1.04	1.120	0.13

Table 12.11: SAR Values for N03 (WiFi 802.11b - Body)

Frequency		Mode /Band	Service /Headset	Test Position	Spacing (mm)	Figure No.	Measured average power (dBm)	Maximum allowed Power (dBm)	Scaling factor	Measured SAR(1g) (W/kg)	Reported SAR(1g) (W/kg)	Power Drift (dB)
MHz	Ch.											
Hotspot & Body worn												
2412	1	WiFi 2450	802.11b	Toward Phantom	5	/	15.12	15.5	1.091	0.138	0.151	0.13
2412	1	WiFi 2450	802.11b	Toward Ground	5	11	15.12	15.5	1.091	0.161	0.176	0.19
Hotspot												
2412	1	WiFi 2450	802.11b	Toward Left	5	/	15.12	15.5	1.091	0.117	0.128	0.08
2412	1	WiFi 2450	802.11b	Toward Right	5	/	15.12	15.5	1.091	0.0489	0.053	0.12
2412	1	WiFi 2450	802.11b	Toward Top	5	/	15.12	15.5	1.091	0.0944	0.103	0.07
2412	1	WiFi 2450	802.11b	Toward Bottom	5	/	15.12	15.5	1.091	0.0258	0.028	0.07

13. Evaluation of Simultaneous

Table13.1 Simultaneous transmission SAR

Standalone SAR for 2G(W/Kg)				
Test Position		GSM	GSM	Highest
		850	1900	SAR
Body 5 mm	Phantom Side	0.827	0.305	0.827
	Ground Side	1.139	0.365	1.139
	Left Side	0.970	0.145	0.970
	Right Side	0.712	0.073	0.712
	Top Side	--	--	--
	Bottom Side	0.577	0.397	0.577

Standalone SAR for 3G(W/Kg)							
Test Position		WCDMA	WCDMA	WCDMA	BC0	BC1	Highest SAR
		Band II	Band IV	Band V			
Body 5 mm	Phantom Side	0.373	0.708	0.421	0.359	0.730	0.730
	Ground Side	0.603	1.151	0.649	0.727	1.144	1.151
	Left Side	0.205	0.478	0.409	0.363	0.381	0.478
	Right Side	0.108	0.079	0.300	0.469	0.294	0.469
	Top Side	--	--	--	--	--	--
	Bottom Side	0.549	0.623	0.279	0.188	0.557	0.623

Standalone SAR for 4G (W/Kg)						
Test Position		LTE Band 2	LTE Band 4	LTE Band7	LTE Band 17	Highest SAR
Body 5 mm	Phantom Side	0.416	0.598	0.794	0.295	0.794
	Ground Side	0.549	1.363	0.484	0.482	1.363
	Left Side	0.237	0.387	0.103	0.180	0.387
	Right Side	0.104	0.091	<0.01	0.343	0.343
	Top Side	--	--	--	--	--
	Bottom Side	0.453	0.654	0.258	0.179	0.654

Simultaneous multi-band transmission									
Test Position		2G	3G	4G	2.4GHz		5GHz	SUM	
					BT	WiFi	WiFi	2.4GHz	5GHz
Body 5 mm	Phantom Side	0.827	0.730	0.794	0.133	0.138	0.144	0.965	0.971
	Ground Side	1.139	1.151	1.363	0.133	0.161	0.155	1.524	1.518
	Left Side	0.970	0.478	0.387	0.133	0.117	0.317	1.103	1.287
	Right Side	0.712	0.469	0.343	0.133	0.0489	--	0.845	--
	Top Side	--	--	--	0.133	0.0944	0.183	0.133	0.183
	Bottom Side	0.577	0.623	0.654	0.133	--	--	0.787	--

According to the conducted power measurement result, we can draw the conclusion that: stand-alone SAR for WiFi should be performed. Then, simultaneous transmission SAR for WiFi/BT is considered with measurement results of GSM/WCDMA/LTE/CDMA and WiFi/BT. According to the above table, the sum of reported SAR values for GSM/WCDMA/LTE/CDMA and WiFi<1.6W/kg. So the simultaneous transmission SAR is not required for WiFi/BT transmitter.

14. SAR Measurement Variability

SAR measurement variability must be assessed for each frequency band, which is determined by the SAR probe calibration point and tissue-equivalent medium used for the device measurements. When both head and body tissue-equivalent media are required for SAR measurements in a frequency band, the variability measurement procedures should be applied to the tissue medium with the highest measured SAR, using the highest measured SAR configuration for that tissue-equivalent medium.

The following procedures are applied to determine if repeated measurements are required.

- 1) Repeated measurement is not required when the original highest measured SAR is < 0.80 W/kg; steps 2) through 4) do not apply.
- 2) When the original highest measured SAR is ≥ 0.80 W/kg, repeat that measurement once.
- 3) Perform a second repeated measurement only if the ratio of largest to smallest SAR for the original and first repeated measurements is > 1.20 or when the original or repeated measurement is ≥ 1.45 W/kg (~ 10% from the 1-g SAR limit).
- 4) Perform a third repeated measurement only if the original, first or second repeated measurement is ≥ 1.5 W/kg and the ratio of largest to smallest SAR for the original, first and second repeated measurements is > 1.20 .

Table 14.1: SAR Measurement Variability for Body Value (1g)

Frequency		Configuration	Test Position	Original SAR (W/kg)	First Repeated SAR (W/kg)	The Ratio
MHz	Ch.					
824.4	128	GPRS 3TS	Ground	0.945	0.947	1.002
1712.4	1312	Band IV	Ground	1.04	1.03	1.010
1851.25	25	CDMA BC1 1xEV-DO-0	Ground	1.05	1.04	1.010
1720	20050	QPSK_20MHz_50RB_25 offset Low	Ground	0.93	0.902	1.031

Note: According to the KDB 865664 D01 repeated measurement is not required when the original highest measured SAR is < 0.8 W/kg.

15. Measurement Uncertainty

Measurement uncertainty for 750 MHz to 3 GHz averaged over 1 gram						
Uncertainty Component	Uncertainty	Prob.	Div.	$C_{i(1g)}$	Std. Unc. (1-g)	V_i or V_{eff}
Measurement System						
Probe Calibration ($k=1$)	5.4	Normal	2	1	5.40	∞
Probe Isotropy	4.70	Rectangular	$\sqrt{3}$	0.7	1.90	∞
Modulation Response	2.40	Rectangular	$\sqrt{3}$	1	1.39	∞
Hemispherical Isotropy	2.60	Rectangular	$\sqrt{3}$	0.7	1.05	∞
Boundary Effect	1.00	Rectangular	$\sqrt{3}$	1	0.58	∞
Linearity	4.70	Rectangular	$\sqrt{3}$	1	2.71	∞
System Detection Limit	1.00	Rectangular	$\sqrt{3}$	1	0.58	∞
Readout Electronics	0.30	Normal	1	1	0.30	∞
Response Time	0.80	Rectangular	$\sqrt{3}$	1	0.46	∞
Integration Time	2.60	Rectangular	$\sqrt{3}$	1	1.50	∞
RF Ambient Noise	0.00	Rectangular	$\sqrt{3}$	1	0.00	∞
RF Ambient Reflections	0.00	Rectangular	$\sqrt{3}$	1	0.00	∞
Probe Positioner	0.40	Rectangular	$\sqrt{3}$	1	0.23	∞
Probe Positioning	2.90	Rectangular	$\sqrt{3}$	1	1.67	∞
Post-processing	1.00	Rectangular	$\sqrt{3}$	1	0.58	∞
Test sample Related						
Test sample Positioning	1.2	Normal	1	1	1.2	5
Device Holder Uncertainty	3.2	Normal	1	1	3.2	71
Power drift	5	Rectangular	$\sqrt{3}$	1	2.89	∞
Power Scaling	0	Rectangular	$\sqrt{3}$	1	0.00	∞
Phantom and Tissue Parameters						
Phantom Uncertainty	4	Rectangular	$\sqrt{3}$	1	2.31	∞
SAR correction	1.9	Rectangular	$\sqrt{3}$	1	1.10	∞
Liquid Conductivity (meas)	4.19	Rectangular	1	0.78	3.27	∞
Liquid Permittivity (meas)	4.4	Rectangular	1	0.26	1.14	∞
Temp. unc. - Conductivity	0.18	Rectangular	$\sqrt{3}$	0.78	0.08	∞
Temp. unc. - Permittivity	0.54	Rectangular	$\sqrt{3}$	0.23	0.07	∞
Combined Std. Uncertainty		RSS			9.39	
Expanded STD Uncertainty		$k=2$			18.77%	

System check uncertainty for 750 MHz to 3 GHz averaged over 1 gram						
Uncertainty Component	Uncertainty	Prob.	Div.	$C_{i(1g)}$	Std. Unc. (1-g)	V_i or V_{eff}
Measurement System						
Probe Calibration ($k=1$)	5.40	Normal	1	1	5.40	∞
Probe Isotropy	4.70	Rectangular	$\sqrt{3}$	0.7	1.90	∞
Modulation Response	2.40	Rectangular	$\sqrt{3}$	1	1.39	∞
Hemispherical Isotropy	2.60	Rectangular	$\sqrt{3}$	0.7	1.05	∞
Boundary Effect	1.00	Rectangular	$\sqrt{3}$	1	0.58	∞
Linearity	4.70	Rectangular	$\sqrt{3}$	1	2.71	∞
System Detection Limit	1.00	Rectangular	$\sqrt{3}$	1	0.58	∞
Readout Electronics	0.30	Normal	1	1	0.30	∞
Response Time	0.80	Rectangular	$\sqrt{3}$	1	0.46	∞
Integration Time	2.60	Rectangular	$\sqrt{3}$	1	1.50	∞
RF Ambient Noise	0.00	Rectangular	$\sqrt{3}$	1	0.00	∞
RF Ambient Reflections	0.00	Rectangular	$\sqrt{3}$	1	0.00	∞
Probe Positioner	0.40	Rectangular	$\sqrt{3}$	1	0.23	∞
Probe Positioning	2.90	Rectangular	$\sqrt{3}$	1	1.67	∞
Post-processing	1.00	Rectangular	$\sqrt{3}$	1	0.58	∞
Field source						
Deviation of the experimental source from numerical source	5.5	Normal	1	1	5.5	∞
Source to liquid distance	2	Rectangular	$\sqrt{3}$	1	1.15	∞
Power drift	5	Rectangular	$\sqrt{3}$	1	2.89	∞
Phantom and Tissue Parameters						
Phantom Uncertainty	4	Rectangular	$\sqrt{3}$	1	2.31	∞
SAR correction	1.9	Rectangular	$\sqrt{3}$	1	1.10	∞
Liquid Conductivity (meas)	4.19	Normal	1	0.78	3.27	∞
Liquid Permittivity (meas)	4.4	Normal	1	0.26	1.14	∞
Temp. unc. - Conductivity	0.18	Rectangular	$\sqrt{3}$	0.78	0.08	∞
Temp. unc. - Permittivity	0.54	Rectangular	$\sqrt{3}$	0.23	0.07	∞
Combined Std. Uncertainty		RSS			10.39	
Expanded STD Uncertainty		$k=2$			20.79%	

16. Main Test Instrument

Table 17.1: List of Main Instruments

No.	Name	Type	Serial Number	Calibration Date	Valid Period
01	Network analyzer	N5242A	MY51221755	Dec 17, 2018	1 year
02	Power meter	NRVD	102257	May 11, 2018	1 year
03	Power sensor	NRV-Z5	100241		
			100644		
04	Signal Generator	E4438C	MY49072044	May 11, 2018	1 Year
05	Amplifier	NTWPA-0086010F	12023024	No Calibration Requested	
06	Coupler	778D	MY4825551	May 11, 2018	1 year
07	BTS	E5515C	MY50266468	Dec 17, 2018	1 year
08	BTS	MT8820C	6201240338	May 11, 2018	1 year
09	E-field Probe	ES3DV3	3252	Sep 4,2018	1 year
09	DAE	SPEAG DAE4	1244	Dec 3,2018	1 year
				Dec 4,2017	1 year
10	Dipole Validation Kit	SPEAG D835V2	4d112	Oct 25, 2018	3 year
		SPEAG D1750V2	1044	Oct 31, 2018	3 year
		SPEAG D1900V2	5d151	Dec 6,2017	3 year
		SPEAG D2450V2	858	Oct 26,2018	3 year
		SPEAG D2600V2	1031	Nov. 1,2018	3 year

ANNEX A. Highest SAR GRAPH RESULTS

Fig.1 GSM850 GPRS 3TS Ground Mode Low 5mm Repeated

Date/Time: 2018/10/29

Electronics: DAE4 Sn1244

Medium parameters used (interpolated): $f = 824.2$ MHz; $\sigma = 0.988$ S/m; $\epsilon_r = 56.783$; $\rho = 1000$ kg/m³

Ambient Temperature: 22.5 °C Liquid Temperature: 22.5 °C

Communication System: GSM 850MHz GPRS 3TS (0); Frequency: 824.2 MHz;

Duty Cycle: 1:2.7

Probe: ES3DV3 - SN3252ConvF(6.34, 6.34, 6.34); Calibrated: 9/4/2018

GSM850 GPRS 3TS Ground Mode Low 5mm Repeated/Area Scan (51x101x1):

Measurement grid: dx=10 mm, dy=10 mm

Maximum value of SAR (Measurement) = 1.07 W/kg

GSM850 GPRS 3TS Ground Mode Low 5mm Repeated/Zoom Scan (7x7x7)/Cube 0:

Measurement grid: dx=5mm, dy=5mm, dz=5mm

Reference Value = 28.00 V/m; Power Drift = -0.04 dB

Peak SAR (extrapolated) = 1.36 W/kg

SAR(1 g) = 0.947 W/kg; SAR(10 g) = 0.684 W/kg

Maximum of SAR (measured) = 0.992 W/kg

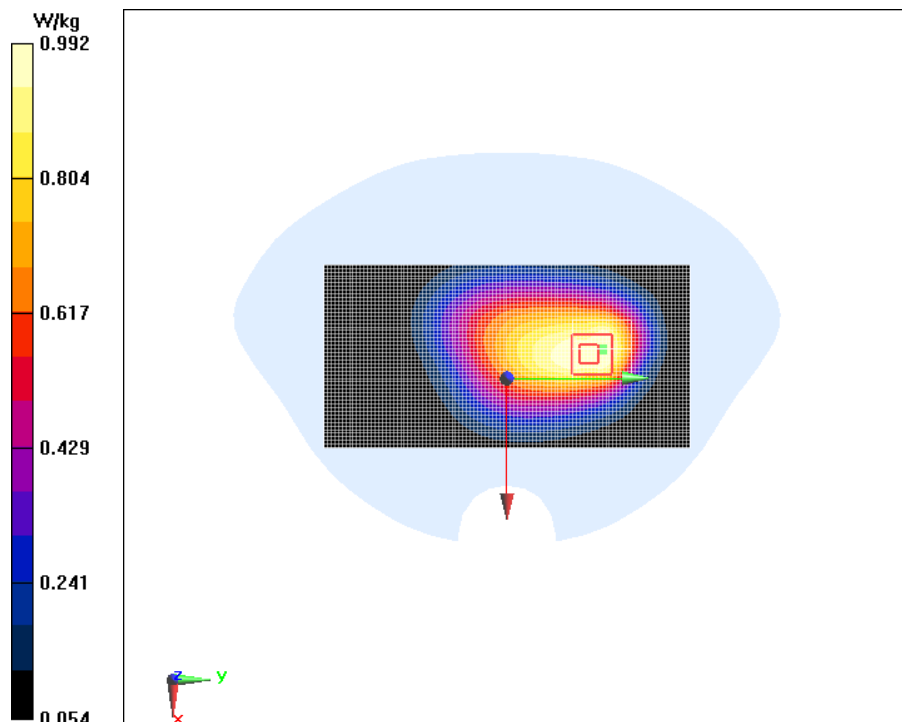

Fig.2 GSM1900 2TS Bottom Mode Middle 5mm

Date/Time: 2018/11/15

Electronics: DAE4 Sn1244

Medium parameters used: $f = 1880$ MHz; $\sigma = 1.528$ S/m; $\epsilon_r = 52.214$; $\rho = 1000$ kg/m³

Ambient Temperature: 22.5 °C Liquid Temperature: 22.5 °C

Communication System: GSM 1900MHz GPRS 2TS (0); Frequency: 1880 MHz;

Duty Cycle: 1:4

Probe: ES3DV3 - SN3252ConvF(4.77, 4.77, 4.77); Calibrated: 9/4/2018

GSM1900 2TS Bottom Mode Middle 5mm/Area Scan (31x61x1):

Measurement grid: dx=10 mm, dy=10 mm

Maximum value of SAR (Measurement) = 0.333 W/kg

GSM1900 2TS Bottom Mode Middle 5mm/Zoom Scan (7x7x7)/Cube 0:

Measurement grid: dx=5mm, dy=5mm, dz=5mm

Reference Value = 11.23 V/m; Power Drift = 0.12 dB

Peak SAR (extrapolated) = 0.510 W/kg

SAR(1 g) = 0.303 W/kg; SAR(10 g) = 0.168 W/kg

Maximum value of SAR (measured) = 0.340 W/kg

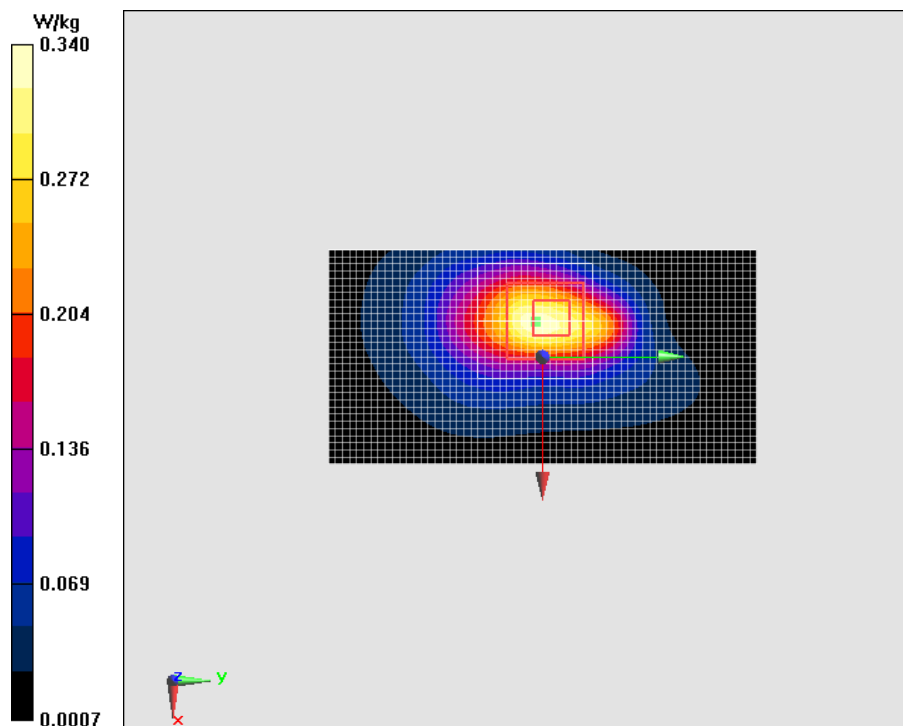

Fig.3 WCDMA Band 2 Ground Mode Middle 5mm

Date/Time: 2018/11/15

Electronics: DAE4 Sn1244

Medium parameters used: $f = 1880$ MHz; $\sigma = 1.528$ S/m; $\epsilon_r = 52.214$; $\rho = 1000$ kg/m³

Ambient Temperature: 22.5 °C Liquid Temperature: 22.5 °C

Communication System: WCDMA Professional Band II; Frequency: 1880 MHz;

Duty Cycle: 1:1

Probe: ES3DV3 - SN3252ConvF(4.77, 4.77, 4.77); Calibrated: 9/4/2018

WCDMA Band 2 Ground Mode Middle 5mm/Area Scan (51x101x1):

Measurement grid: dx=10 mm, dy=10 mm

Maximum value of SAR (Measurement) = 0.540 W/kg

WCDMA Band 2 Ground Mode Middle 5mm/Zoom Scan (7x7x7)/Cube 0:

Measurement grid: dx=5mm, dy=5mm, dz=5mm

Reference Value = 9.766 V/m; Power Drift = 0.06 dB

Peak SAR (extrapolated) = 1.12 W/kg

SAR(1 g) = 0.550 W/kg; SAR(10 g) = 0.326 W/kg

Maximum of SAR (measured) = 0.685 W/kg

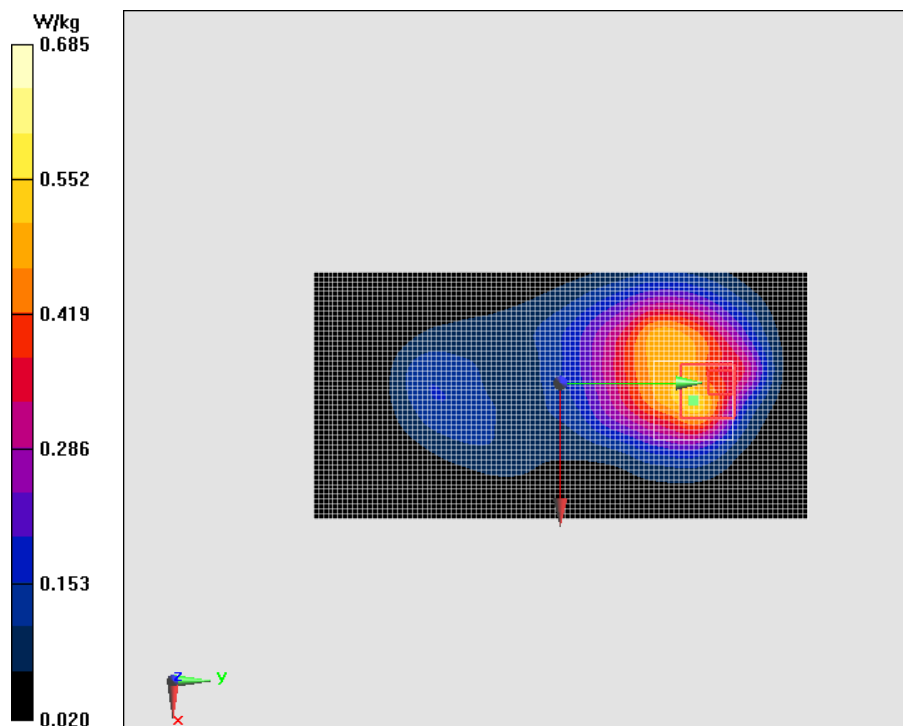

Fig.4 WCDMA Band 4 Ground Mode Low

Date/Time: 2018/12/29

Electronics: DAE4 Sn1244

Medium parameters used (interpolated): $f = 1712.4$ MHz; $\sigma = 1.315$ S/m; $\epsilon_r = 54.805$; $\rho = 1000$ kg/m³

Ambient Temperature: 22.5 °C Liquid Temperature: 22.5 °C

Communication System: WCDMA Professional 1800MHz; Frequency: 1712.4 MHz; Duty Cycle: 1:1

Probe: ES3DV3 - SN3252ConvF(4.99, 4.99, 4.99); Calibrated: 9/4/2018

WCDMA Band 4 Ground Mode Low/Area Scan (51x101x1):

Measurement grid: dx=10 mm, dy=10 mm

Maximum value of SAR (Measurement) = 1.15 W/kg

WCDMA Band 4 Ground Mode Low/Zoom Scan (7x7x7)/Cube 0:

Measurement grid: dx=5mm, dy=5mm, dz=5mm

Reference Value = 9.880 V/m; Power Drift = -0.04 dB

Peak SAR (extrapolated) = 1.76 W/kg

SAR(1 g) = 1.04 W/kg; SAR(10 g) = 0.623 W/kg

Maximum value of SAR (measured) = 1.10 W/kg

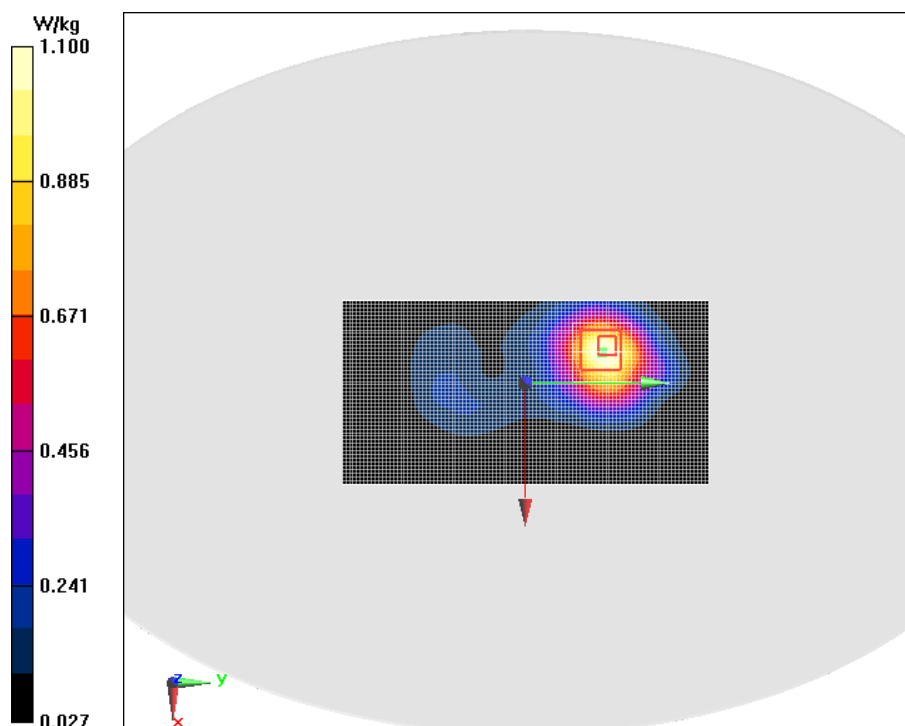

Fig.5 WCDMA Band 5 Ground Mode Middle 5mm

Date/Time: 2018/10/29

Electronics: DAE4 Sn1244

Medium parameters used: $f = 837 \text{ MHz}$; $\sigma = 0.999 \text{ S/m}$; $\epsilon_r = 56.705$; $\rho = 1000 \text{ kg/m}^3$

Ambient Temperature: $22.5 \text{ }^\circ\text{C}$ Liquid Temperature: $22.5 \text{ }^\circ\text{C}$

Communication System: WCDMA Professional Band V; Frequency: 836.6 MHz ;

Duty Cycle: 1:1

Probe: ES3DV3 - SN3252ConvF(6.34, 6.34, 6.34); Calibrated: 9/4/2018

WCDMA Band 5 Ground Mode Middle 5mm/Area Scan (51x101x1):

Measurement grid: $dx=10 \text{ mm}$, $dy=10 \text{ mm}$

Maximum value of SAR (Measurement) = 0.663 W/kg

WCDMA Band 5 Ground Mode Middle 5mm/Zoom Scan (7x7x7)/Cube 0:

Measurement grid: $dx=5\text{mm}$, $dy=5\text{mm}$, $dz=5\text{mm}$

Reference Value = 22.33 V/m ; Power Drift = 0.18 dB

Peak SAR (extrapolated) = 0.777 W/kg

SAR(1 g) = 0.581 W/kg ; SAR(10 g) = 0.405 W/kg

Maximum of SAR (measured) = 0.609 W/kg

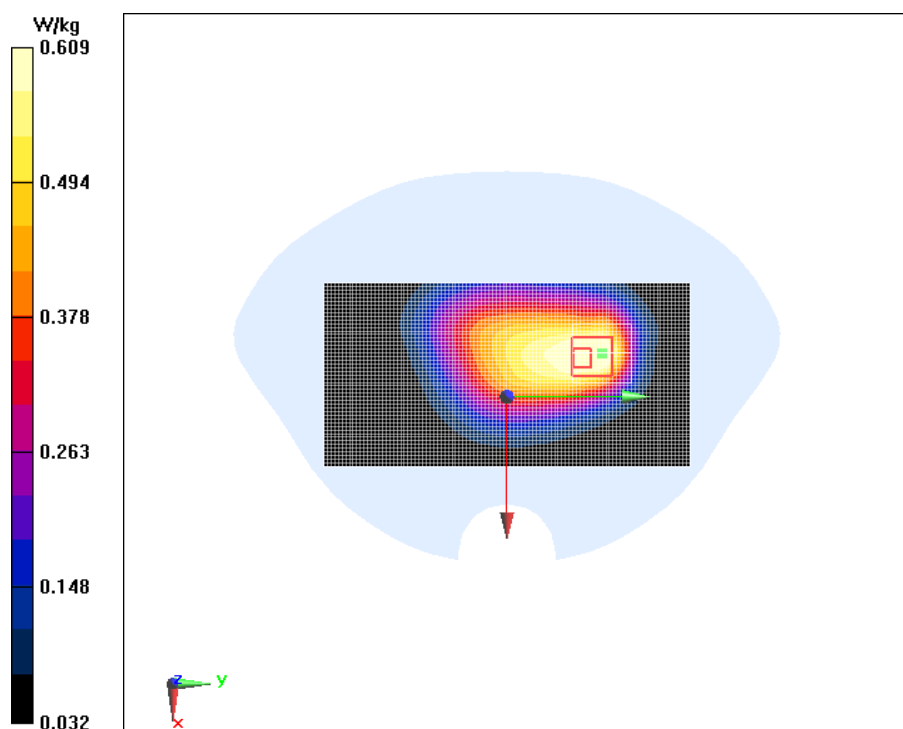

Fig.6 LTE2 20MHz 50RB 25 offset Ground Mode Middle 5mm

Date/Time: 2018/11/15

Electronics: DAE4 Sn1244

Medium parameters used: $f = 1880$ MHz; $\sigma = 1.528$ S/m; $\epsilon_r = 52.214$; $\rho = 1000$ kg/m³

Ambient Temperature: 22.5 °C Liquid Temperature: 22.5 °C

Communication System: LTE Band 2 Professional 1900MHz; Frequency: 1880 MHz; Duty Cycle: 1:1

Probe: ES3DV3 - SN3252ConvF(4.77, 4.77, 4.77); Calibrated: 9/4/2018

LTE2 20MHz 50RB 25 offset Ground Mode Middle 5mm/Area Scan (51x101x1):

Measurement grid: dx=10 mm, dy=10 mm

Maximum value of SAR (Measurement) = 0.428 W/kg

LTE2 20MHz 50RB 25 offset Ground Mode Middle 5mm/Zoom Scan

(7x7x7)/Cube 0:

Measurement grid: dx=5mm, dy=5mm, dz=5mm

Reference Value = 7.995 V/m; Power Drift = -0.01 dB

Peak SAR (extrapolated) = 0.847 W/kg

SAR(1 g) = 0.410 W/kg; SAR(10 g) = 0.235 W/kg

Maximum of SAR (measured) = 0.504 W/kg

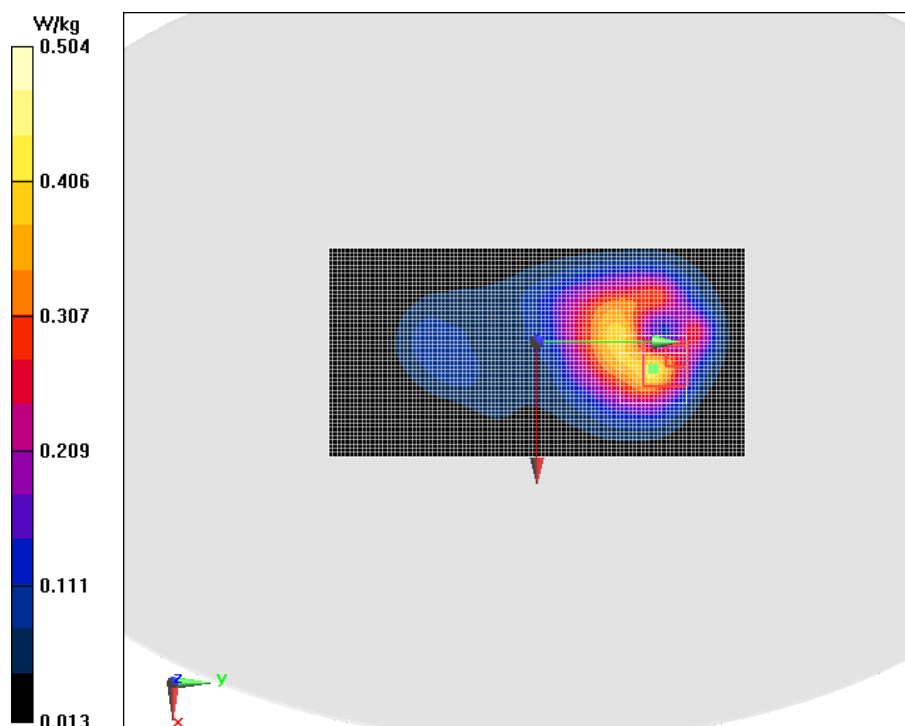

Fig.7 LTE4 20MHz 50RB 25 offset Ground Mode Low 5mm

Date/Time: 2018/12/29

Electronics: DAE4 Sn1244

Medium parameters used: $f = 1720$ MHz; $\sigma = 1.323$ S/m; $\epsilon_r = 54.785$; $\rho = 1000$ kg/m³

Ambient Temperature: 22.5 °C Liquid Temperature: 22.5 °C

Communication System: LTE Band 4 Professional 1800MHz; Frequency: 1720 MHz; Duty Cycle: 1:1

Probe: ES3DV3 - SN3252ConvF(4.99, 4.99, 4.99); Calibrated: 9/4/2018

LTE4 20MHz 50RB 25 offset Ground Mode Low 5mm/Area Scan (51x101x1):

Measurement grid: dx=10 mm, dy=10 mm

Maximum value of SAR (Measurement) = 1.09 W/kg

LTE4 20MHz 50RB 25 offset Ground Mode Low 5mm/Zoom Scan (7x7x7)/Cube 0:

Measurement grid: dx=5mm, dy=5mm, dz=5mm

Reference Value = 9.657 V/m; Power Drift = -0.17 dB

Peak SAR (extrapolated) = 1.65 W/kg

SAR(1 g) = 0.930 W/kg; SAR(10 g) = 0.543 W/kg

Maximum of SAR (measured) = 0.985 W/kg

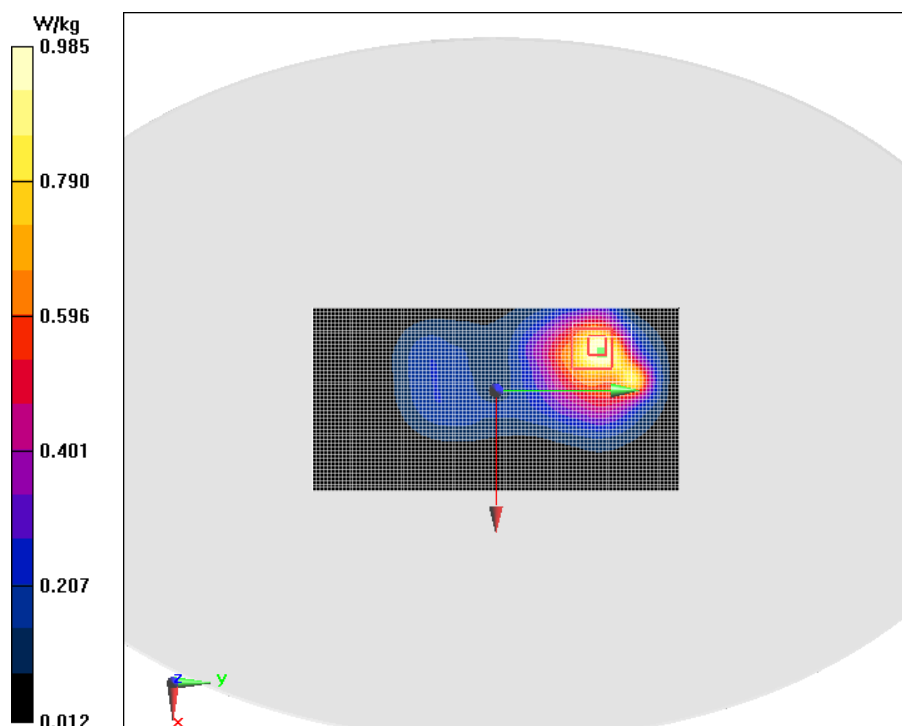

Fig.8 LTE7 20MHz 1RB 50 offset Phantom Mode Low 5mm

Date/Time: 2019/1/30

Electronics: DAE4 Sn1244

Medium parameters used: $f = 2510$ MHz; $\sigma = 1.998$ S/m; $\epsilon_r = 54.622$; $\rho = 1000$ kg/m³

Ambient Temperature: 22.5 °C Liquid Temperature: 22.5 °C

Communication System: LTE Band 7 Professional 2600MHz; Frequency: 2510 MHz; Duty Cycle: 1:1

Probe: ES3DV3 - SN3252ConvF(4.41, 4.41, 4.41); Calibrated: 9/4/2018

LTE7 20MHz 1RB 50 offset Phantom Mode Low 5mm/Area Scan (51x101x1):

Measurement grid: dx=10 mm, dy=10 mm

Maximum value of SAR (Measurement) = 0.747 W/kg

LTE7 20MHz 1RB 50 offset Phantom Mode Low 5mm/Zoom Scan (7x7x7)/Cube 0:

Measurement grid: dx=5mm, dy=5mm, dz=5mm

Reference Value = 10.70 V/m; Power Drift = -0.11 dB

Peak SAR (extrapolated) = 1.46 W/kg

SAR(1 g) = 0.714 W/kg; SAR(10 g) = 0.361 W/kg

Maximum value of SAR (measured) = 0.813 W/kg

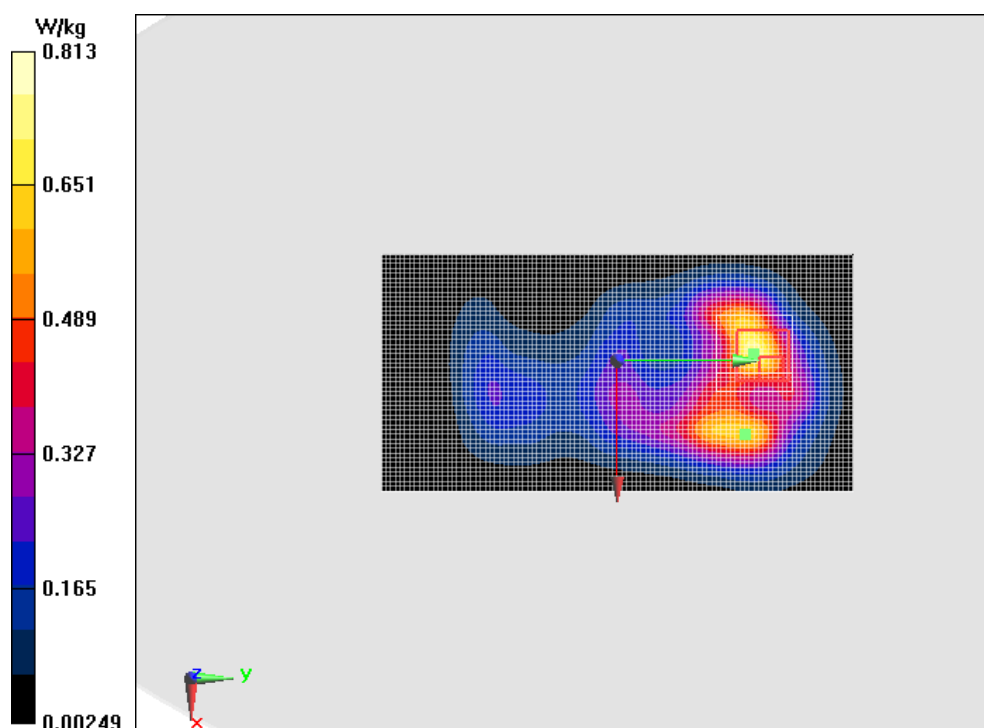

Fig.9 CDMA BC0 EVDO 0 Ground Mode Middle 5mm

Date/Time: 2018/10/29

Electronics: DAE4 Sn1244

Medium parameters used: $f = 837 \text{ MHz}$; $\sigma = 0.999 \text{ S/m}$; $\epsilon_r = 56.705$; $\rho = 1000 \text{ kg/m}^3$

Ambient Temperature: $22.5 \text{ }^\circ\text{C}$ Liquid Temperature: $22.5 \text{ }^\circ\text{C}$

Communication System: CDMA 835MHz 850MHz; Frequency: 836.52 MHz ; Duty Cycle: 1:1

Probe: ES3DV3 - SN3252ConvF(6.34, 6.34, 6.34); Calibrated: 9/4/2018

CDMA BC0 EVDO 0 Ground Mode Middle 5mm/Area Scan (51x101x1):

Measurement grid: $dx=10 \text{ mm}$, $dy=10 \text{ mm}$

Maximum value of SAR (Measurement) = 0.778 W/kg

CDMA BC0 EVDO 0 Ground Mode Middle 5mm/Zoom Scan (7x7x7)/Cube 0:

Measurement grid: $dx=5\text{mm}$, $dy=5\text{mm}$, $dz=5\text{mm}$

Reference Value = 23.53 V/m ; Power Drift = 0.02 dB

Peak SAR (extrapolated) = 0.941 W/kg

SAR(1 g) = 0.680 W/kg ; SAR(10 g) = 0.484 W/kg

Maximum of SAR (measured) = 0.720 W/kg

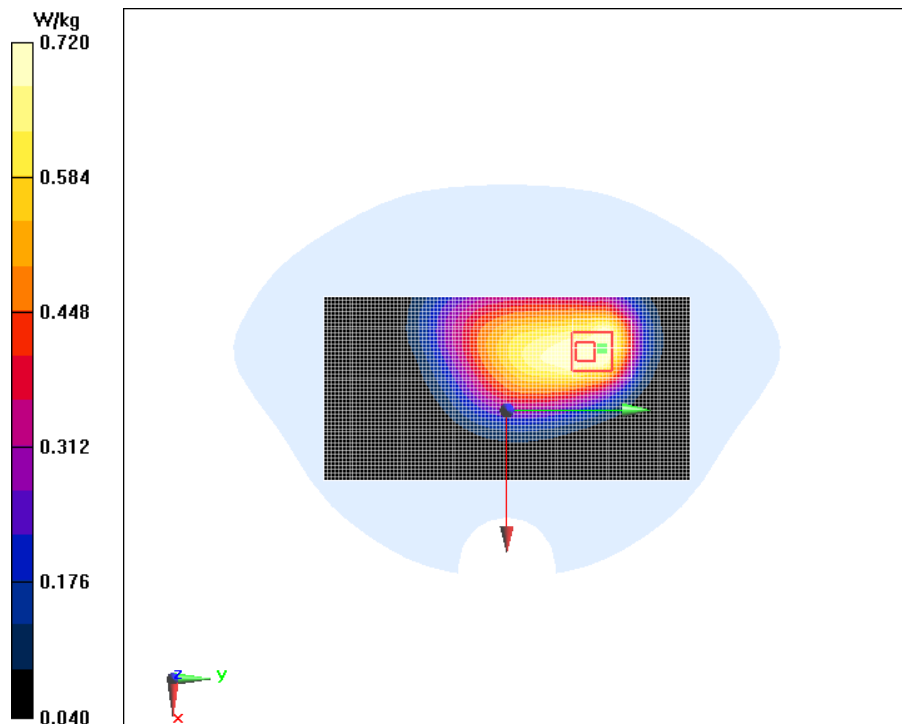

Fig.10 CDMA BC1 EVDO 0 Ground Mode Middle 5mm

Date/Time: 2018/11/15

Electronics: DAE4 Sn1244

Medium parameters used: $f = 1880 \text{ MHz}$; $\sigma = 1.528 \text{ S/m}$; $\epsilon_r = 52.214$; $\rho = 1000 \text{ kg/m}^3$

Ambient Temperature: $22.5 \text{ }^\circ\text{C}$ Liquid Temperature: $22.5 \text{ }^\circ\text{C}$

Communication System: CDMA 1900MHz 1900MHz; Frequency: 1880 MHz ; Duty Cycle: 1:1

Probe: ES3DV3 - SN3252ConvF(4.77, 4.77, 4.77); Calibrated: 9/4/2018

CDMA BC1 EVDO 0 Ground Mode Middle 5mm/Area Scan (51x101x1):

Measurement grid: $dx=10 \text{ mm}$, $dy=10 \text{ mm}$

Maximum value of SAR (Measurement) = 0.781 W/kg

CDMA BC1 EVDO 0 Ground Mode Middle 5mm/Zoom Scan (7x7x7)/Cube 0:

Measurement grid: $dx=5\text{mm}$, $dy=5\text{mm}$, $dz=5\text{mm}$

Reference Value = 10.97 V/m ; Power Drift = -0.04 dB

Peak SAR (extrapolated) = 1.87 W/kg

SAR(1 g) = 1.02 W/kg ; SAR(10 g) = 0.557 W/kg

Maximum of SAR (measured) = 1.04 W/kg

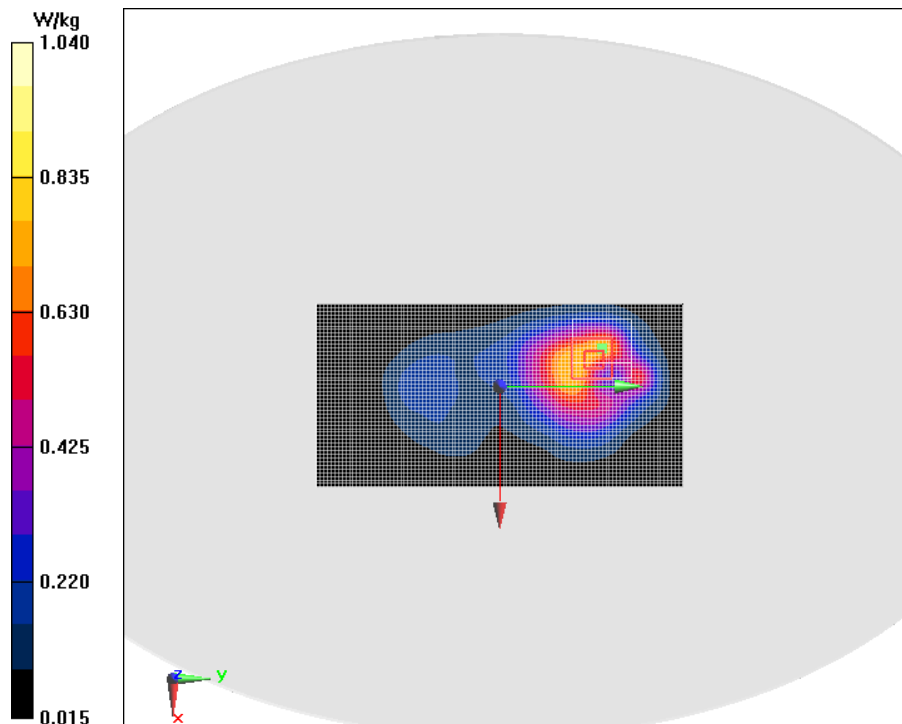

Fig.11 802.11b Ground Mode Low 5mm 16dbm

Date/Time: 2018/11/16

Electronics: DAE4 Sn1244

Medium parameters used: $f = 2412$ MHz; $\sigma = 1.879$ S/m; $\epsilon_r = 53.772$; $\rho = 1000$ kg/m³

Ambient Temperature: 22.5 °C Liquid Temperature: 22.5 °C

Communication System: Wifi 2450 2450MHz; Frequency: 2412 MHz; Duty Cycle: 1:1

Probe: ES3DV3 - SN3252ConvF(4.41, 4.41, 4.41); Calibrated: 9/4/2018

802.11b Ground Mode Low 5mm 16dbm/Area Scan (51x101x1):

Measurement grid: dx=10 mm, dy=10 mm

Maximum value of SAR (Measurement) = 0.180 W/kg

802.11b Ground Mode Low 5mm 16dbm/Zoom Scan (7x7x7)/Cube 0:

Measurement grid: dx=5mm, dy=5mm, dz=5mm

Reference Value = 5.905 V/m; Power Drift = 0.19 dB

Peak SAR (extrapolated) = 0.317 W/kg

SAR(1 g) = 0.161 W/kg; SAR(10 g) = 0.090 W/kg

Maximum value of SAR (measured) = 0.173 W/kg

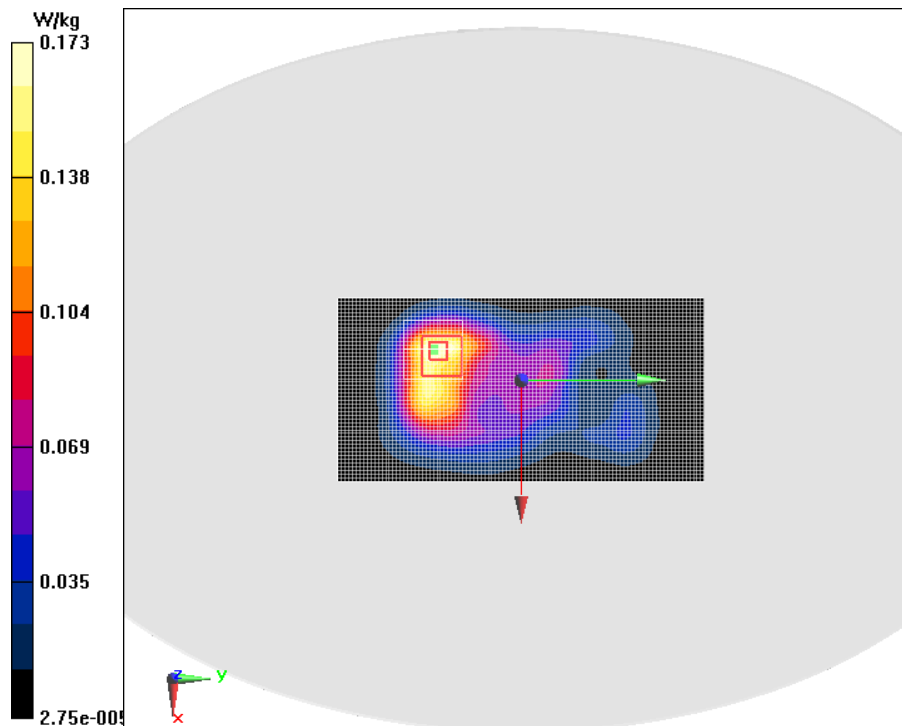

ANNEX B. SYSTEM VALIDATION RESULTS

Body 835MHz

Date/Time: 2018/10/29

Electronics: DAE4 Sn1244

Medium parameters used: $f = 835 \text{ MHz}$; $\sigma = 0.996 \text{ S/m}$; $\epsilon_r = 56.713$; $\rho = 1000 \text{ kg/m}^3$

Ambient Temperature: $22.5 \text{ }^\circ\text{C}$ Liquid Temperature: $22.5 \text{ }^\circ\text{C}$

Communication System: CW 835MHz; Frequency: 835 MHz; Duty Cycle: 1:1

Probe: ES3DV3 - SN3252ConvF(6.14, 6.14, 6.14); Calibrated: 8/31/2017

System Validation/Area Scan (61x131x1):

Measurement grid: $dx=10 \text{ mm}$, $dy=10 \text{ mm}$

Maximum value of SAR (Measurement) = 2.55 W/kg

System Validation/Zoom Scan (7x7x7)/Cube 0:

Measurement grid: $dx=5\text{mm}$, $dy=5\text{mm}$, $dz=5\text{mm}$

Reference Value = 49.91 V/m ; Power Drift = 0.15 dB

Peak SAR (extrapolated) = 3.58 W/kg

SAR(1 g) = 2.47 W/kg ; SAR(10 g) = 1.66 W/kg

Maximum value of SAR (measured) = 2.70 W/kg

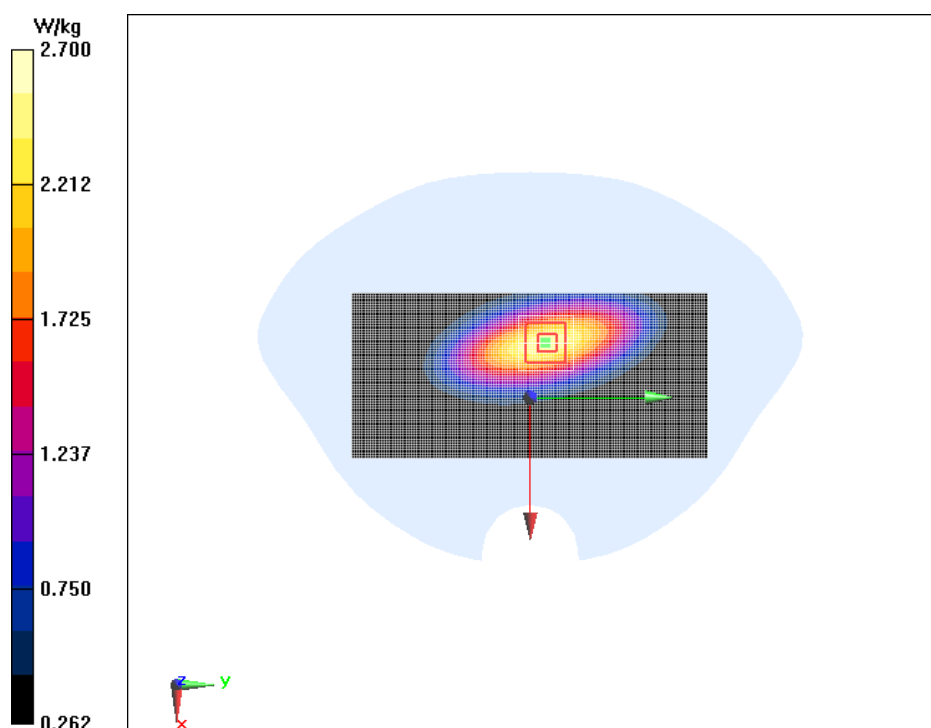

Body 1750MHz

Date/Time: 2018/12/29

Electronics: DAE4 Sn1244

Medium parameters used: $f = 1750 \text{ MHz}$; $\sigma = 1.415 \text{ S/m}$; $\epsilon_r = 53.936$; $\rho = 1000 \text{ kg/m}^3$

Ambient Temperature: $22.5 \text{ }^\circ\text{C}$ Liquid Temperature: $22.5 \text{ }^\circ\text{C}$

Communication System: CW 1800MHz; Frequency: 1750 MHz; Duty Cycle: 1:1

Probe: ES3DV3 - SN3252ConvF(4.99, 4.99, 4.99); Calibrated: 9/4/2018

System check Validation/Area Scan (61x61x1):

Measurement grid: $dx=10 \text{ mm}$, $dy=10 \text{ mm}$

Maximum value of SAR (Measurement) = 10.5 W/kg

System check Validation/Zoom Scan (7x7x7) (7x7x7)/Cube 0:

Measurement grid: $dx=5\text{mm}$, $dy=5\text{mm}$, $dz=5\text{mm}$

Reference Value = 85.61 V/m ; Power Drift = -0.02 dB

Peak SAR (extrapolated) = 16.3 W/kg

SAR(1 g) = 9.36 W/kg ; SAR(10 g) = 4.95 W/kg

Maximum value of SAR (measured) = 10.3 W/kg

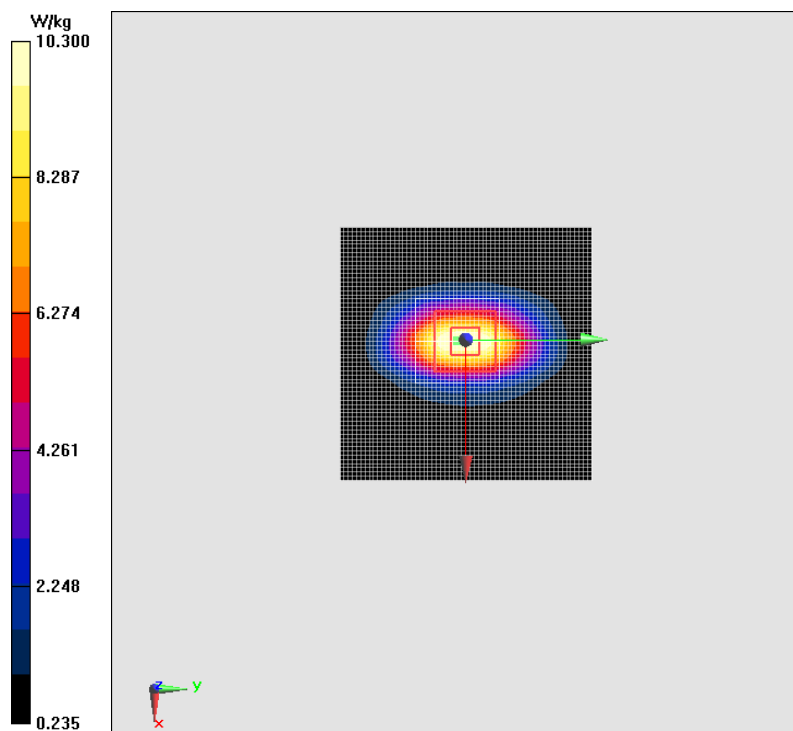

Body 1900MHz

Date/Time: 2018/11/15

Electronics: DAE4 Sn1244

Medium parameters used: $f = 1900 \text{ MHz}$; $\sigma = 1.553 \text{ S/m}$; $\epsilon_r = 52.061$; $\rho = 1000 \text{ kg/m}^3$

Ambient Temperature: $22.5 \text{ }^\circ\text{C}$ Liquid Temperature: $22.5 \text{ }^\circ\text{C}$

Communication System: CW 1900MHz; Frequency: 1900 MHz; Duty Cycle: 1:1

Probe: ES3DV3 - SN3252ConvF(4.95, 4.95, 4.95); Calibrated: 9/4/2018

System check Validation/Area Scan (61x61x1):

Measurement grid: $dx=10 \text{ mm}$, $dy=10 \text{ mm}$

Maximum value of SAR (Measurement) = 13.0 W/kg

System check Validation/Zoom Scan (7x7x7) (7x7x7)/Cube 0:

Measurement grid: $dx=5\text{mm}$, $dy=5\text{mm}$, $dz=5\text{mm}$

Reference Value = 88.64 V/m ; Power Drift = -0.16 dB

Peak SAR (extrapolated) = 21.1 W/kg

SAR(1 g) = 10.3 W/kg ; SAR(10 g) = 5.39 W/kg

Maximum value of SAR (measured) = 12.3 W/kg

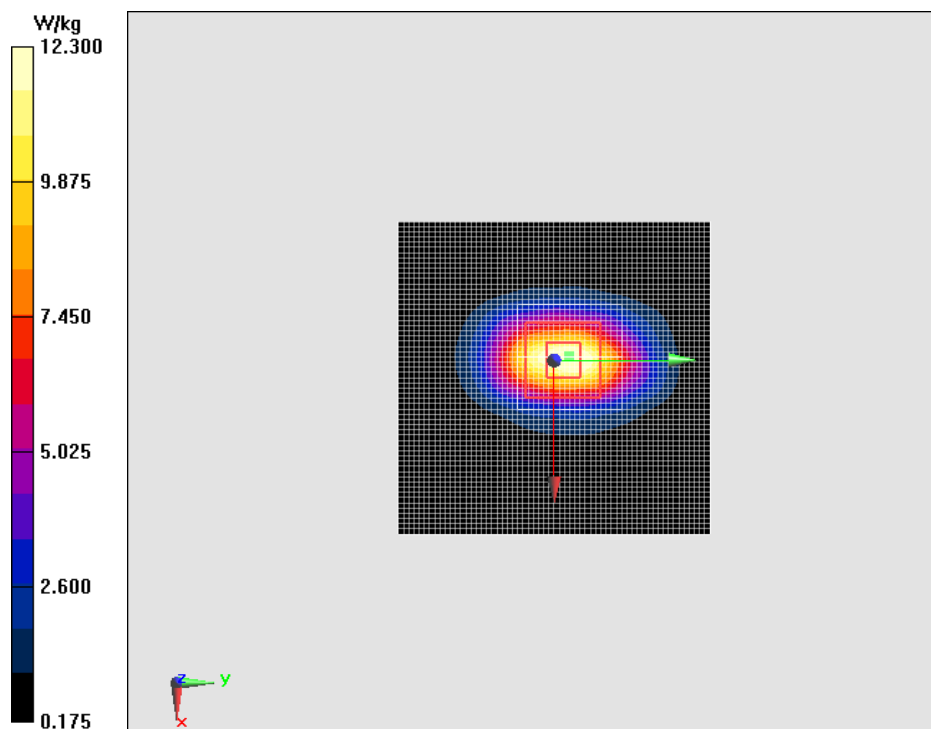

Body 2450MHz

Date/Time: 2018/11/16

Electronics: DAE4 Sn1244

Medium parameters used: $f = 2450 \text{ MHz}$; $\sigma = 1.901 \text{ S/m}$; $\epsilon_r = 53.364$; $\rho = 1000 \text{ kg/m}^3$

Ambient Temperature: $22.5 \text{ }^\circ\text{C}$ Liquid Temperature: $22.5 \text{ }^\circ\text{C}$

Communication System: CW 2450MHz; Frequency: 2450 MHz; Duty Cycle: 1:1

Probe: ES3DV3 - SN3252ConvF(4.41, 4.41, 4.41); Calibrated: 9/4/2018

System Validation/Area Scan (91x71x1):

Measurement grid: $dx=10 \text{ mm}$, $dy=10 \text{ mm}$

Maximum value of SAR (Measurement) = 16.2 W/kg

System Validation/Zoom Scan (7x7x7) (7x7x7)/Cube 0:

Measurement grid: $dx=5\text{mm}$, $dy=5\text{mm}$, $dz=5\text{mm}$

Reference Value = 87.16 V/m ; Power Drift = 0.15 dB

Peak SAR (extrapolated) = 28.5 W/kg

SAR(1 g) = 13.2 W/kg ; SAR(10 g) = 6.12 W/kg

Maximum value of SAR (measured) = 14.8 W/kg

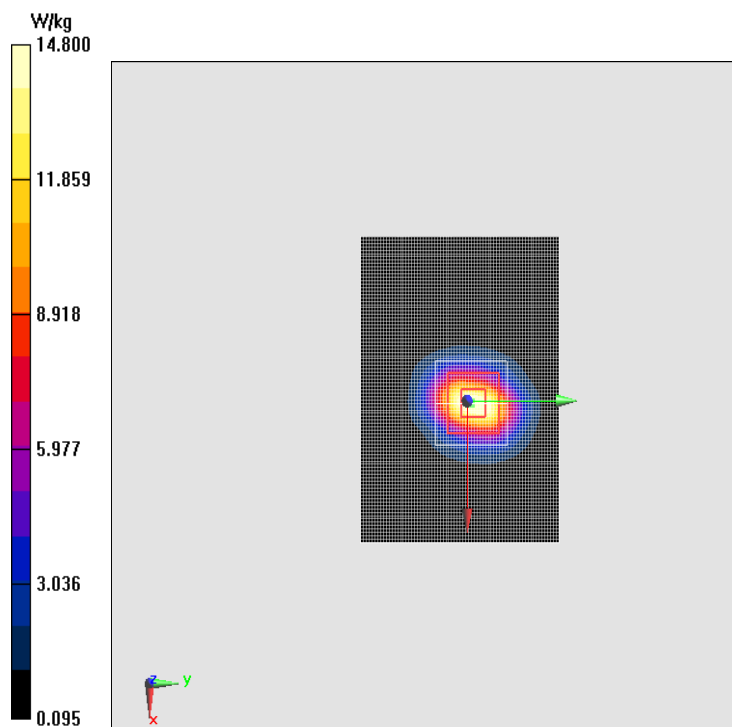

Body 2600MHz

Date/Time: 2019/1/30

Electronics: DAE4 Sn1244

Medium parameters used: $f = 2600$ MHz; $\sigma = 2.101$ S/m; $\epsilon_r = 52.513$; $\rho = 1000$ kg/m³

Ambient Temperature: 22.5 °C Liquid Temperature: 22.5 °C

Communication System: CW 2600MHz; Frequency: 2600 MHz; Duty Cycle: 1:1

Probe: ES3DV3 - SN3252ConvF(4.41, 4.41, 4.41); Calibrated: 9/4/2018

Body 2600MHz/Area Scan (81x81x1):

Measurement grid: dx=10 mm, dy=10 mm

Maximum value of SAR (Measurement) = 16.3 W/kg

Body 2600MHz/Zoom Scan (7x7x7)/Cube 0:

Measurement grid: dx=5mm, dy=5mm, dz=5mm

Reference Value = 91.25 V/m; Power Drift = -0.08 dB

Peak SAR (extrapolated) = 30.2 W/kg

SAR(1 g) = 14.1 W/kg; SAR(10 g) = 6.25 W/kg

Maximum value of SAR (measured) = 16.5 W/kg

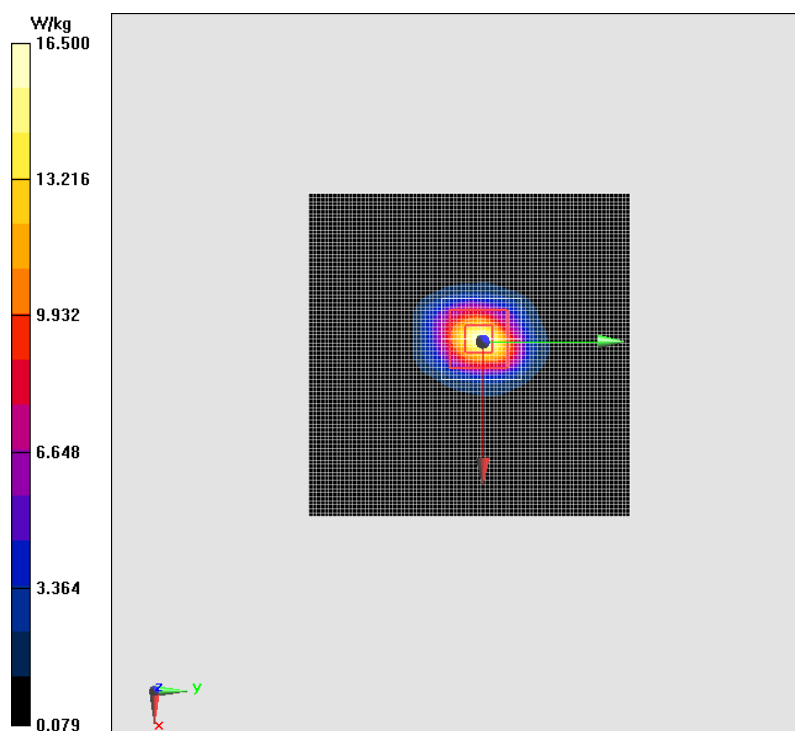

ANNEX C. SAR Measurement Setup

C.1. Measurement Set-up

The DASY5 system for performing compliance tests is illustrated above graphically. This system consists of the following items:

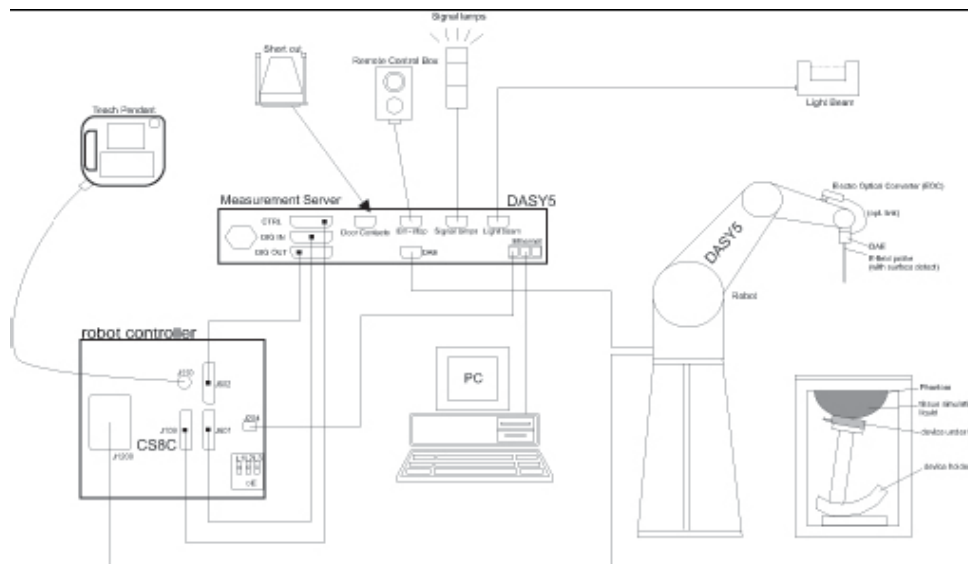

Picture C.1 SAR Lab Test Measurement Set-up

- A standard high precision 6-axis robot (Stäubli TX=RX family) with controller, teach pendant and software. An arm extension for accommodating the data acquisition electronics (DAE).
- An isotropic field probe optimized and calibrated for the targeted measurement.
- A data acquisition electronics (DAE) which performs the signal amplification, signal multiplexing, AD-conversion, offset measurements, mechanical surface detection, collision detection, etc. The unit is battery powered with standard or rechargeable batteries. The signal is optically transmitted to the EOC.
- The Electro-optical converter (EOC) performs the conversion from optical to electrical signals for the digital communication to the DAE. To use optical surface detection, a special version of the EOC is required. The EOC signal is transmitted to the measurement server.
- The function of the measurement server is to perform the time critical tasks such as signal filtering, control of the robot operation and fast movement interrupts.
- The Light Beam used is for probe alignment. This improves the (absolute) accuracy of the probe positioning.
- A computer running WinXP and the DASY5 software.

- Remote control and teach pendant as well as additional circuitry for robot safety such as
- warning lamps, etc.
- The phantom, the device holder and other accessories according to the targeted measurement.

C.2. DASY5 E-field Probe System

The SAR measurements were conducted with the dosimetric probe designed in the classical triangular configuration and optimized for dosimetric evaluation. The probe is constructed using the thick film technique; with printed resistive lines on ceramic substrates. The probe is equipped with an optical multifiber line ending at the front of the probe tip. It is connected to the EOC box on the robot arm and provides an automatic detection of the phantom surface. Half of the fibers are connected to a pulsed infrared transmitter, the other half to a synchronized receiver. As the probe approaches the surface, the reflection from the surface produces a coupling from the transmitting to the receiving fibers. This reflection increases first during the approach, reaches maximum and then decreases. If the probe is flatly touching the surface, the coupling is zero. The distance of the coupling maximum to the surface is independent of the surface reflectivity and largely independent of the surface to probe angle. The DASY5 software reads the reflection during a software approach and looks for the maximum using 2nd order curve fitting. The approach is stopped at reaching the maximum.

Probe Specifications:

Model:	ES3DV3,EX3DV4
Frequency	10MHz — 6GHz(EX3DV4)
Range:	10MHz — 4GHz(ES3DV3)
Calibration:	In head and body simulating tissue at Frequencies from 835 up to 5800MHz
Linearity:	± 0.2 dB(30 MHz to 4 GHz) for ES3DV3 ± 0.2 dB(30 MHz to 6 GHz) for EX3DV4
Dynamic Range:	10 mW/kg — 100W/kg
Probe Length:	330 mm
Probe Tip	
Length:	20 mm
Body Diameter:	12 mm
Tip Diameter:	2.5 mm (3.9 mm for ES3DV3)
Tip-Center:	1 mm (2.0mm for ES3DV3)
Application:	SAR Dosimetry Testing Compliance tests of mobile phones Dosimetry in strong gradient fields



Picture7-2 Near-field Probe



Picture 7-3 E-field Probe

C.3. E-field Probe Calibration

Each E-Probe/Probe Amplifier combination has unique calibration parameters. A TEM cell calibration procedure is conducted to determine the proper amplifier settings to enter in the probe parameters. The amplifier settings are determined for a given frequency by

subjecting the probe to a known E-field density (1 mW/cm²) using an RF Signal generator, TEM cell, and RF Power Meter.

The free space E-field from amplified probe outputs is determined in a test chamber. This calibration can be performed in a TEM cell if the frequency is below 1 GHz and in a waveguide or other methodologies above 1 GHz for free space. For the free space calibration, the probe is placed in the volumetric center of the cavity and at the proper orientation with the field. The probe is then rotated 360 degrees until the three channels show the maximum reading. The power density readings equate to 1 mW/cm²:

E-field temperature correlation calibration is performed in a flat phantom filled with the appropriate simulated brain tissue. The E-field in the medium correlates with the temperature rise in the dielectric medium. For temperature correlation calibration a RF transparent thermistor-based temperature probe is used in conjunction with the E-field probe.

$$SAR = C \frac{\Delta T}{\Delta t}$$

Where:

Δt = Exposure time (30 seconds),

C = Heat capacity of tissue (brain or muscle),

ΔT = Temperature increase due to RF exposure.

$$SAR = \frac{|E|^2 \cdot \sigma}{\rho}$$

Where:

σ = Simulated tissue conductivity,

ρ = Tissue density (kg/m³).

C.4. Other Test Equipment

C.4.1. Data Acquisition Electronics(DAE)

The data acquisition electronics consist of a highly sensitive electrometer-grade preamplifier with auto-zeroing, a channel and gain-switching multiplexer, a fast 16 bit AD-converter and a command decoder with a control logic unit. Transmission to the measurement server is accomplished through an optical downlink for data and status information, as well as an optical uplink for commands and the clock.

The mechanical probe mounting device includes two different sensor systems for frontal and sideways probe contacts. They are used for mechanical surface detection and probe

collision detection.

The input impedance of the DAE is 200 MOhm; the inputs are symmetrical and floating.

Common mode rejection is above 80 dB.



PictureC.4: DAE

C.4.2. Robot

The SPEAG DASY system uses the high precision robots (DASY5: RX90L) type from Stäubli SA (France). For the 6-axis controller system, the robot controller version from Stäubli is used. The Stäubli robot series have many features that are important for our application:

- High precision (repeatability 0.02mm)
- High reliability (industrial design)
- Low maintenance costs (virtually maintenance free due to direct drive gears; no belt drives)
- Jerk-free straight movements (brushless synchron motors; no stepper motors)
- Low ELF interference (motor control fields shielded via the closed metallic construction shields)



Picture C.5 DASY 5

C.4.3. Measurement Server

The Measurement server is based on a PC/104 CPU board with CPU (DASY5: 400 MHz, Intel Celeron), chipdisk (DASY5: 128MB), RAM (DASY5: 128MB). The necessary circuits for communication with the DAE electronic box, as well as the 16 bit AD converter system for optical detection and digital I/O interface are contained on the DASY I/O board, which

is directly connected to the PC/104 bus of the CPU board.

The measurement server performs all real-time data evaluation of field measurements and surface detection, controls robot movements and handles safety operation. The PC operating system cannot interfere with these time critical processes. All connections are supervised by a watchdog, and disconnection of any of the cables to the measurement server will automatically disarm the robot and disable all program-controlled robot movements. Furthermore, the measurement server is equipped with an expansion port which is reserved for future applications. Please note that this expansion port does not have a standardized pinout, and therefore only devices provided by SPEAG can be connected. Devices from any other supplier could seriously damage the measurement server.



Picture C.6 Server for DASY 5

C.4.4. Device Holder for Phantom

The SAR in the phantom is approximately inversely proportional to the square of the distance between the source and the liquid surface. For a source at 5mm distance, a positioning uncertainty of $\pm 0.5\text{mm}$ would produce a SAR uncertainty of $\pm 20\%$. Accurate device positioning is therefore crucial for accurate and repeatable measurements. The positions in which the devices must be measured are defined by the standards.

The DASY device holder is designed to cope with the different positions given in the standard. It has two scales for device rotation (with respect to the body axis) and device inclination (with respect to the line between the ear reference points). The rotation centers for both scales is the ear reference point (ERP).

Thus the device needs no repositioning when changing the angles.

The DASY device holder is constructed of low-loss POM material having the following dielectric parameters: relative permittivity $\epsilon = 3$ and loss tangent $\delta = 0.02$. The amount of dielectric material has been reduced in the closest vicinity of the device, since measurements have suggested that the influence of the clamp on the test results could thus be lowered.

<Laptop Extension Kit>

The extension is lightweight and made of POM, acrylic glass and foam. It fits easily on the upper part of the Mounting Device in place of the phone positioner. The extension is fully compatible with the Twin-SAM and ELI phantoms.



Picture C.7: Device Holder

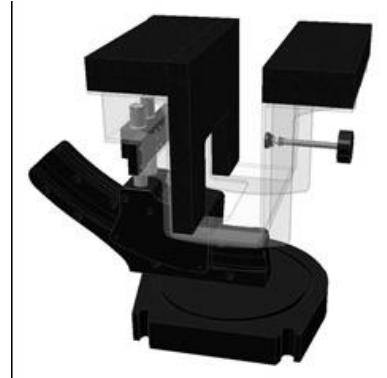

Picture C.8: Laptop Extension Kit

C.4.5. Phantom

The SAM Twin Phantom V4.0 is constructed of a fiberglass shell integrated in a table. The shape of the shell is based on data from an anatomical study designed to represent the 90th percentile of the population. The phantom enables the dissymmetric evaluation of SAR for both left and right handed handset usage, as well as body-worn usage using the flat phantom region. Reference markings on the Phantom allow the complete setup of all predefined phantom positions and measurement grids by manually teaching three points in the robot. The shell phantom has a 2mm shell thickness (except the ear region where shell thickness increases to 6 mm).

Shell Thickness: 2 ± 0.2 mm

Filling Volume: Approx. 25 liters

Dimensions: 810 x 1000 x 500 mm (H x L x W)

Available: Special



Picture C.9: SAM Twin Phantom

ANNEX D. Position of the wireless device in relation to the phantom

D.1. Body-worn device

A typical example of a body-worn device is a mobile phone, wireless enabled PDA or other battery operated wireless device with the ability to transmit while mounted on a person's body using a carry accessory approved by the wireless device manufacturer.

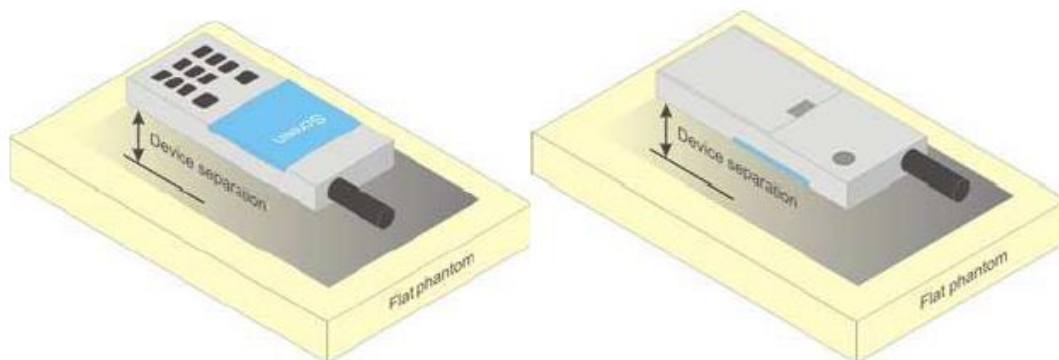

Picture D.4 Test positions for body-worn devices

D.2. Desktop device

A typical example of a desktop device is a wireless enabled desktop computer placed on a table or desk when used.

The DUT shall be positioned at the distance and in the orientation to the phantom that corresponds to the intended use as specified by the manufacturer in the user instructions. For devices that employ an external antenna with variable positions, tests shall be performed for all antenna positions specified. Picture 8.5 show positions for desktop device SAR tests. If the intended use is not specified, the device shall be tested directly against the flat phantom.

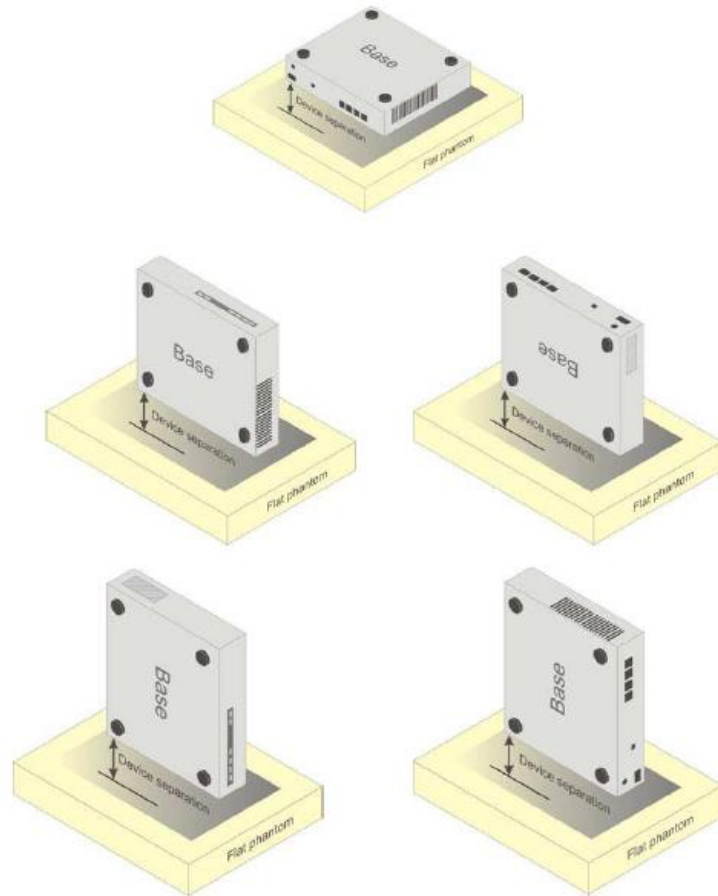

Picture D.5 Test positions for desktop devices

D.3. DUT Setup Photos



Picture D.6 DSY5 system Set-up

Note:

The photos of test sample and test positions show in additional document.

ANNEX E. Equivalent Media Recipes

The liquid used for the frequency range of 800-3000 MHz consisted of water, sugar, salt, preventol, glycol monobutyl and Cellulose. The liquid has been previously proven to be suited for worst-case. The Table E.1 shows the detail solution. It's satisfying the latest tissue dielectric parameters requirements proposed by the IEEE 1528 and IEC 62209.

Table E.1: Composition of the Tissue Equivalent Matter

Frequency (MHz)	835 Head	835 Body	1900 Head	1900 Body	2450 Head	2450 Body
Ingredients (% by weight)						
Water	41.45	52.5	55.242	69.91	58.79	72.60
Sugar	56.0	45.0	\	\	\	\
Salt	1.45	1.4	0.306	0.13	0.06	0.18
Preventol	0.1	0.1	\	\	\	\
Cellulose	1.0	1.0	\	\	\	\
Glycol Monobutyl	\	\	44.452	29.96	41.15	27.22
Dielectric Parameters Target Value	$\epsilon=41.5$ $\sigma=0.90$	$\epsilon=55.2$ $\sigma=0.97$	$\epsilon=40.0$ $\sigma=1.40$	$\epsilon=53.3$ $\sigma=1.52$	$\epsilon=39.2$ $\sigma=1.80$	$\epsilon=52.7$ $\sigma=1.95$

ANNEX F. System Validation

The SAR system must be validated against its performance specifications before it is deployed. When SAR probes, system components or software are changed, upgraded or recalibrated, these must be validated with the SAR system(s) that operates with such components.

Table F.1: System Validation Part 1

System No.	Probe SN.	Liquid name	Validation date	Frequency point	Permittivity ϵ	Conductivity σ (S/m)
1	3252	Body 835MHz	2018/10/29	835 MHz	56.713	0.996
2	3252	Body 1750MHz	2018/12/29	1800 MHz	53.936	1.415
3	3252	Body 1900MHz	2018/11/15	1900 MHz	52.061	1.551
4	3252	Body 2450MHz	2018/11/16	2450 MHz	53.364	1.901
5	3252	Body 2600MHz	2019/01/30	2600 MHz	52.513	2.101

Table F.2: System Validation Part 2

CW Validation	Sensitivity	PASS	PASS
	Probe linearity	PASS	PASS
	Probe Isotropy	PASS	PASS
Mod Validation	MOD.type	GMSK	GMSK
	MOD.type	OFDM	OFDM
	Duty factor	PASS	PASS
	PAR	PASS	PASS

ANNEX G. Probe and DAE Calibration Certificate

In Collaboration with
s p e a g
CALIBRATION LABORATORY

中国认可
国际互认
校准
CALIBRATION
CNAS L0570

Add: No.51 Xueyuan Road, Haidian District, Beijing, 100191, China
 Tel: +86-10-62304633-2218 Fax: +86-10-62304633-2209
 E-mail: cttl@chinattl.com Http://www.chinattl.cn

Client : **ECIT** Certificate No: **Z17-97266**

CALIBRATION CERTIFICATE

Object: **DAE4 - SN: 1244**

Calibration Procedure(s): **FF-Z11-002-01
Calibration Procedure for the Data Acquisition Electronics (DAEx)**

Calibration date: **December 04, 2017**

This calibration Certificate documents the traceability to national standards, which realize the physical units of measurements(SI). The measurements and the uncertainties with confidence probability are given on the following pages and are part of the certificate.

All calibrations have been conducted in the closed laboratory facility: environment temperature(22±3)°C and humidity<70%.

Calibration Equipment used (M&TE critical for calibration)

Primary Standards	ID #	Cal Date(Calibrated by, Certificate No.)	Scheduled Calibration
Process Calibrator 753	1971018	27-Jun-17 (CTTL, No.J17X05859)	June-18

	Name	Function	Signature
Calibrated by:	Yu Zongying	SAR Test Engineer	
Reviewed by:	Lin Hao	SAR Test Engineer	
Approved by:	Qi Dianyuan	SAR Project Leader	

Issued: December 05, 2017

This calibration certificate shall not be reproduced except in full without written approval of the laboratory.

Certificate No: Z17-97266
Page 1 of 3



Add: No.51 Xueyuan Road, Haidian District, Beijing, 100191, China
Tel: +86-10-62304633-2218 Fax: +86-10-62304633-2209
E-mail: cttl@chinattl.com Http://www.chinattl.cn

Glossary:

DAE data acquisition electronics
Connector angle information used in DASY system to align probe sensor X to the robot coordinate system.

Methods Applied and Interpretation of Parameters:

- *DC Voltage Measurement:* Calibration Factor assessed for use in DASY system by comparison with a calibrated instrument traceable to national standards. The figure given corresponds to the full scale range of the voltmeter in the respective range.
- *Connector angle:* The angle of the connector is assessed measuring the angle mechanically by a tool inserted. Uncertainty is not required.
- The report provide only calibration results for DAE, it does not contain other performance test results.



Add: No.51 Xueyuan Road, Haidian District, Beijing, 100191, China
 Tel: +86-10-62304633-2218 Fax: +86-10-62304633-2209
 E-mail: cttl@chinattl.com Http://www.chinattl.cn

DC Voltage Measurement

A/D - Converter Resolution nominal

High Range: 1LSB = 6.1 μ V, full range = -100...+300 mV

Low Range: 1LSB = 61nV, full range = -1...+3mV

DASY measurement parameters: Auto Zero Time: 3 sec; Measuring time: 3 sec

Calibration Factors	X	Y	Z
High Range	403.862 \pm 0.15% (k=2)	403.603 \pm 0.15% (k=2)	404.516 \pm 0.15% (k=2)
Low Range	3.95366 \pm 0.7% (k=2)	3.96972 \pm 0.7% (k=2)	3.97929 \pm 0.7% (k=2)

Connector Angle

Connector Angle to be used in DASY system	22.5° \pm 1°
---	----------------



Add: No.51 Xueyuan Road, Haidian District, Beijing, 100191, China
 Tel: +86-10-62304633-2218 Fax: +86-10-62304633-2209
 E-mail: cttl@chinattl.com Http://www.chinattl.cn



中国认可
 国际互认
 校准
 CALIBRATION
 CNAS L0570

Client : ECIT

Certificate No: Z17-97266

CALIBRATION CERTIFICATE

Object: DAE4 - SN: 1244

Calibration Procedure(s): FF-Z11-002-01
 Calibration Procedure for the Data Acquisition Electronics (DAEx)

Calibration date: December 04, 2017

This calibration Certificate documents the traceability to national standards, which realize the physical units of measurements(SI). The measurements and the uncertainties with confidence probability are given on the following pages and are part of the certificate.

All calibrations have been conducted in the closed laboratory facility: environment temperature(22±3)°C and humidity<70%.

Calibration Equipment used (M&TE critical for calibration)

Primary Standards	ID #	Cal Date(Calibrated by, Certificate No.)	Scheduled Calibration
Process Calibrator 753	1971018	27-Jun-17 (CTTL, No.J17X05859)	June-18

	Name	Function	Signature
Calibrated by:	Yu Zongying	SAR Test Engineer	
Reviewed by:	Lin Hao	SAR Test Engineer	
Approved by:	Qi Dianyuan	SAR Project Leader	

Issued: December 05, 2017

This calibration certificate shall not be reproduced except in full without written approval of the laboratory.



Add: No.51 Xueyuan Road, Haidian District, Beijing, 100191, China
Tel: +86-10-62304633-2218 Fax: +86-10-62304633-2209
E-mail: cttl@chinattl.com Http://www.chinattl.cn

Glossary:

DAE data acquisition electronics
Connector angle information used in DASY system to align probe sensor X to the robot coordinate system.

Methods Applied and Interpretation of Parameters:

- *DC Voltage Measurement:* Calibration Factor assessed for use in DASY system by comparison with a calibrated instrument traceable to national standards. The figure given corresponds to the full scale range of the voltmeter in the respective range.
- *Connector angle:* The angle of the connector is assessed measuring the angle mechanically by a tool inserted. Uncertainty is not required.
- The report provide only calibration results for DAE, it does not contain other performance test results.



Add: No.51 Xueyuan Road, Haidian District, Beijing, 100191, China
 Tel: +86-10-62304633-2218 Fax: +86-10-62304633-2209
 E-mail: cttl@chinattl.com Http://www.chinattl.cn

DC Voltage Measurement

A/D - Converter Resolution nominal

High Range: 1LSB = 6.1 μ V, full range = -100...+300 mV

Low Range: 1LSB = 61nV, full range = -1...+3mV

DASY measurement parameters: Auto Zero Time: 3 sec; Measuring time: 3 sec

Calibration Factors	X	Y	Z
High Range	403.862 \pm 0.15% (k=2)	403.603 \pm 0.15% (k=2)	404.516 \pm 0.15% (k=2)
Low Range	3.95366 \pm 0.7% (k=2)	3.96972 \pm 0.7% (k=2)	3.97929 \pm 0.7% (k=2)

Connector Angle

Connector Angle to be used in DASY system	22.5° \pm 1°
---	----------------



Add: No.51 Xueyuan Road, Haidian District, Beijing, 100191, China
 Tel: +86-10-62304633-2512 Fax: +86-10-62304633-2504
 E-mail: cttl@chinattl.com [Http://www.chinattl.cn](http://www.chinattl.cn)



中国认可
 国际互认
 校准
 CALIBRATION
 CNAS L0570

 Client : **ECIT**

 Certificate No: **Z18-60529**

CALIBRATION CERTIFICATE

Object: **DAE4 - SN: 1244**
 Calibration Procedure(s): **FF-Z11-002-01
 Calibration Procedure for the Data Acquisition Electronics (DAEx)**
 Calibration date: **December 03, 2018**

This calibration Certificate documents the traceability to national standards, which realize the physical units of measurements(SI). The measurements and the uncertainties with confidence probability are given on the following pages and are part of the certificate.

All calibrations have been conducted in the closed laboratory facility: environment temperature(22±3)°C and humidity<70%.

Calibration Equipment used (M&TE critical for calibration)

Primary Standards	ID #	Cal Date(Calibrated by, Certificate No.)	Scheduled Calibration
Process Calibrator 753	1971018	20-Jun-18 (CTTL, No.J18X05034)	June-19

	Name	Function	Signature
Calibrated by:	Yu Zongying	SAR Test Engineer	
Reviewed by:	Lin Hao	SAR Test Engineer	
Approved by:	Qi Dianyuan	SAR Project Leader	

Issued: December 05, 2018

This calibration certificate shall not be reproduced except in full without written approval of the laboratory.



Add: No.51 Xueyuan Road, Haidian District, Beijing, 100191, China
Tel: +86-10-62304633-2512 Fax: +86-10-62304633-2504
E-mail: cttl@chinattl.com Http://www.chinattl.cn

Glossary:

DAE data acquisition electronics
Connector angle information used in DASY system to align probe sensor X to the robot coordinate system.

Methods Applied and Interpretation of Parameters:

- *DC Voltage Measurement:* Calibration Factor assessed for use in DASY system by comparison with a calibrated instrument traceable to national standards. The figure given corresponds to the full scale range of the voltmeter in the respective range.
- *Connector angle:* The angle of the connector is assessed measuring the angle mechanically by a tool inserted. Uncertainty is not required.
- The report provide only calibration results for DAE, it does not contain other performance test results.



Add: No.51 Xueyuan Road, Haidian District, Beijing, 100191, China
Tel: +86-10-62304633-2512 Fax: +86-10-62304633-2504
E-mail: cttl@chinattl.com Http://www.chinattl.cn

DC Voltage Measurement

A/D - Converter Resolution nominal

High Range: 1LSB = 6.1 μ V, full range = -100...+300 mV

Low Range: 1LSB = 61nV, full range = -1.....+3mV

DASY measurement parameters: Auto Zero Time: 3 sec; Measuring time: 3 sec

Calibration Factors	X	Y	Z
High Range	403.818 \pm 0.15% (k=2)	403.555 \pm 0.15% (k=2)	404.470 \pm 0.15% (k=2)
Low Range	3.95395 \pm 0.7% (k=2)	3.97087 \pm 0.7% (k=2)	3.97994 \pm 0.7% (k=2)

Connector Angle

Connector Angle to be used in DASY system	22.5° \pm 1°
---	----------------



Add: No.51 Xueyuan Road, Haidian District, Beijing, 100191, China
 Tel: +86-10-62304633-2512 Fax: +86-10-62304633-2504
 E-mail: ctll@chinattl.com Http://www.chinattl.cn



中国认可
 国际互认
 校准
 CALIBRATION
 CNAS L0570

 Client **ECIT**

 Certificate No: **Z18-60343**

CALIBRATION CERTIFICATE

Object: **ES3DV3 - SN:3252**

Calibration Procedure(s): **FF-Z11-004-01
 Calibration Procedures for Dosimetric E-field Probes**

Calibration date: **September 04, 2018**

This calibration Certificate documents the traceability to national standards, which realize the physical units of measurements(SI). The measurements and the uncertainties with confidence probability are given on the following pages and are part of the certificate.

All calibrations have been conducted in the closed laboratory facility: environment temperature(22±3)°C and humidity<70%.

Calibration Equipment used (M&TE critical for calibration)

Primary Standards	ID #	Cal Date(Calibrated by, Certificate No.)	Scheduled Calibration
Power Meter NRP2	101919	20-Jun-18 (CTTL, No.J18X05032)	Jun-19
Power sensor NRP-Z91	101547	20-Jun-18 (CTTL, No.J18X05032)	Jun-19
Power sensor NRP-Z91	101548	20-Jun-18 (CTTL, No.J18X05032)	Jun-19
Reference10dBAttenuator	18N50W-10dB	09-Feb-18(CTTL, No.J18X01133)	Feb-20
Reference20dBAttenuator	18N50W-20dB	09-Feb-18(CTTL, No.J18X01132)	Feb-20
Reference Probe EX3DV4	SN 3846	25-Jan-18(SPEAG,No.EX3-3846_Jan18)	Jan-19
DAE4	SN 777	15-Dec-17(SPEAG, No.DAE4-777_Dec17)	Dec -18
Secondary Standards	ID #	Cal Date(Calibrated by, Certificate No.)	Scheduled Calibration
SignalGeneratorMG3700A	6201052605	21-Jun-18 (CTTL, No.J18X05033)	Jun-19
Network Analyzer E5071C	MY46110673	14-Jan-18 (CTTL, No.J18X00561)	Jan -19

	Name	Function	Signature
Calibrated by:	Yu Zongying	SAR Test Engineer	
Reviewed by:	Lin Hao	SAR Test Engineer	
Approved by:	Qi Dianyuan	SAR Project Leader	

Issued: September 06, 2018

This calibration certificate shall not be reproduced except in full without written approval of the laboratory.



Add: No.51 Xueyuan Road, Haidian District, Beijing, 100191, China
 Tel: +86-10-62304633-2512 Fax: +86-10-62304633-2504
 E-mail: cttl@chinattl.com [Http://www.chinattl.cn](http://www.chinattl.cn)

Glossary:

TSL	tissue simulating liquid
NORM _{x,y,z}	sensitivity in free space
ConvF	sensitivity in TSL / NORM _{x,y,z}
DCP	diode compression point
CF	crest factor (1/duty_cycle) of the RF signal
A,B,C,D	modulation dependent linearization parameters
Polarization Φ	Φ rotation around probe axis
Polarization θ	θ rotation around an axis that is in the plane normal to probe axis (at measurement center), i $\theta=0$ is normal to probe axis
Connector Angle	information used in DASY system to align probe sensor X to the robot coordinate system

Calibration is Performed According to the Following Standards:

- a) IEEE Std 1528-2013, "IEEE Recommended Practice for Determining the Peak Spatial-Averaged Specific Absorption Rate (SAR) in the Human Head from Wireless Communications Devices: Measurement Techniques", June 2013
- b) IEC 62209-1, "Measurement procedure for the assessment of Specific Absorption Rate (SAR) from hand-held and body-mounted devices used next to the ear (frequency range of 300 MHz to 6 GHz)", July 2016
- c) IEC 62209-2, "Procedure to determine the Specific Absorption Rate (SAR) for wireless communication devices used in close proximity to the human body (frequency range of 30 MHz to 6 GHz)", March 2010
- d) KDB 865664, "SAR Measurement Requirements for 100 MHz to 6 GHz"

Methods Applied and Interpretation of Parameters:

- NORM_{x,y,z}: Assessed for E-field polarization $\theta=0$ ($f \leq 900\text{MHz}$ in TEM-cell; $f > 1800\text{MHz}$: waveguide). NORM_{x,y,z} are only intermediate values, i.e., the uncertainties of NORM_{x,y,z} does not effect the E^2 -field uncertainty inside TSL (see below ConvF).
- NORM(f)_{x,y,z} = NORM_{x,y,z}* frequency_response (see Frequency Response Chart). This linearization is implemented in DASY4 software versions later than 4.2. The uncertainty of the frequency response is included in the stated uncertainty of ConvF.
- DCP_{x,y,z}: DCP are numerical linearization parameters assessed based on the data of power sweep (no uncertainty required). DCP does not depend on frequency nor media.
- PAR: PAR is the Peak to Average Ratio that is not calibrated but determined based on the signal characteristics.
- A_{x,y,z}; B_{x,y,z}; C_{x,y,z}; VR_{x,y,z}: A,B,C are numerical linearization parameters assessed based on the data of power sweep for specific modulation signal. The parameters do not depend on frequency nor media. VR is the maximum calibration range expressed in RMS voltage across the diode.
- ConvF and Boundary Effect Parameters: Assessed in flat phantom using E-field (or Temperature Transfer Standard for $f \leq 800\text{MHz}$) and inside waveguide using analytical field distributions based on power measurements for $f > 800\text{MHz}$. The same setups are used for assessment of the parameters applied for boundary compensation (alpha, depth) of which typical uncertainty valued are given. These parameters are used in DASY4 software to improve probe accuracy close to the boundary. The sensitivity in TSL corresponds to NORM_{x,y,z}* ConvF whereby the uncertainty corresponds to that given for ConvF. A frequency dependent ConvF is used in DASY version 4.4 and higher which allows extending the validity from $\pm 50\text{MHz}$ to $\pm 100\text{MHz}$.
- Spherical isotropy (3D deviation from isotropy): in a field of low gradients realized using a flat phantom exposed by a patch antenna.
- Sensor Offset: The sensor offset corresponds to the offset of virtual measurement center from the probe tip (on probe axis). No tolerance required.
- Connector Angle: The angle is assessed using the information gained by determining the NORM_x (no uncertainty required).