



# **FCC RADIO TEST REPORT-BLE FCC ID:2AGR3-GLBMOB55**

**Product :** Smartphone

**Trade Name :** GLOBE, MULTITECH

**Model Name :** GLB-MOB55

**Serial Model :** GCP-5050, MT-MOB5050, MT-CP55

**Report No. :** NTEK-2015NT11022996F3

## **Prepared for**

SGM Representaciones S.A.S

Av Suba No 115-58 Centro Ilarco Oficina 703 Bogota Colombia

## **Prepared by**

Shenzhen NTEK Testing Technology Co., Ltd.

1/F, Building E, Fenda Science Park, Sanwei Community, Xixiang Street  
Bao'an District, Shenzhen P.R. China

Tel.: +86-0755-61156588 Fax.: +86-0755-61156599

Website: [www.ntek.org.cn](http://www.ntek.org.cn)

## TEST RESULT CERTIFICATION

**Applicant's name** ..... SGM Representaciones S.A.S

Address ..... Av Suba No 115-58 Centro Ilarco Oficina 703 Bogota Colombia

**Manufacturer's Name**... Haier International(HK)Limited

Address ..... 505,Block B2, KeXing Science Park, KeYuan Road, Nanshan, Shenzhen, China

### Product description

Product name ..... Smartphone

Model and/or type reference ..... GLB-MOB55

Serial Model ..... GCP-5050, MT-MOB5050, MT-CP55

**Standards** ..... FCC Part15.247: 01 Oct. 2015

Test procedure ..... ANSI C63.10-2013 and KDB 558074: June 5, 2014

This device described above has been tested by NTEK, and the test results show that the equipment under test (EUT) is in compliance with the FCC requirements. And it is applicable only to the tested sample identified in the report.

This report shall not be reproduced except in full, without the written approval of NTEK, this document may be altered or revised by NTEK, personnel only, and shall be noted in the revision of the document.

**Date of Test** .....

Date (s) of performance of tests .....: 02 Nov. 2015 ~24 Nov. 2015

Date of Issue.....: 24 Nov. 2015

Test Result.....: **Pass**

Testing Engineer : Eileen Liu.  
(Eileen Liu)

Technical Manager : Brown Lu  
(Brown Lu)

Authorized Signatory : Sam. Chen  
(Sam Chen)

**Table of Contents**

	<b>Page</b>
<b>1 . SUMMARY OF TEST RESULTS</b>	<b>5</b>
1.1 TEST FACILITY	6
1.2 MEASUREMENT UNCERTAINTY	6
<b>2 . GENERAL INFORMATION</b>	<b>7</b>
2.1 GENERAL DESCRIPTION OF EUT	7
2.2 DESCRIPTION OF TEST MODES	9
2.3 BLOCK DIGRAM SHOWING THE CONFIGURATION OF SYSTEM TESTED	10
2.4 DESCRIPTION OF SUPPORT UNITS(CONDUCTED MODE)	11
2.5 EQUIPMENTS LIST FOR ALL TEST ITEMS	12
<b>3 . EMC EMISSION TEST</b>	<b>13</b>
3.1 CONDUCTED EMISSION MEASUREMENT	13
3.1.1 POWER LINE CONDUCTED EMISSION LIMITS	13
3.1.2 TEST PROCEDURE	14
3.1.3 DEVIATION FROM TEST STANDARD	14
3.1.4 TEST SETUP	14
3.1.5 EUT OPERATING CONDITIONS	14
3.1.6 TEST RESULTS	15
3.2 RADIATED EMISSION MEASUREMENT	23
3.2.1 RADIATED EMISSION LIMITS	23
3.2.2 TEST PROCEDURE	24
3.2.3 DEVIATION FROM TEST STANDARD	24
3.2.4 TEST SETUP	25
3.2.5 EUT OPERATING CONDITIONS	26
3.2.6 TEST RESULTS (BETWEEN 9KHZ – 30 MHZ)	27
3.2.7 TEST RESULTS (BETWEEN 30MHZ – 1GHZ)	28
3.2.8 TEST RESULTS (ABOVE 1000 MHZ)	30
<b>4 . POWER SPECTRAL DENSITY TEST</b>	<b>32</b>
4.1 APPLIED PROCEDURES / LIMIT	32
4.1.1 TEST PROCEDURE	32
4.1.2 DEVIATION FROM STANDARD	32
4.1.3 TEST SETUP	32
4.1.4 EUT OPERATION CONDITIONS	32
4.1.5 TEST RESULTS	33
<b>5 . BANDWIDTH TEST</b>	<b>35</b>
5.1 APPLIED PROCEDURES / LIMIT	35
5.1.1 TEST PROCEDURE	35

**Table of Contents**

	<b>Page</b>
<b>TEST SETUP</b>	<b>35</b>
<b>5.1.2 EUT OPERATION CONDITIONS</b>	<b>35</b>
<b>5.1.3 TEST RESULTS</b>	<b>36</b>
<b>6 . PEAK OUTPUT POWER TEST</b>	<b>38</b>
<b>6.1 APPLIED PROCEDURES / LIMIT</b>	<b>38</b>
<b>6.1.1 TEST PROCEDURE</b>	<b>38</b>
<b>6.1.2 DEVIATION FROM STANDARD</b>	<b>38</b>
<b>6.1.3 TEST SETUP</b>	<b>38</b>
<b>6.1.4 EUT OPERATION CONDITIONS</b>	<b>38</b>
<b>6.1.5 TEST RESULTS</b>	<b>39</b>
<b>7 . 100 KHZ BANDWIDTH OF FREQUENCY BAND EDGE</b>	<b>40</b>
<b>7.1 DEVIATION FROM STANDARD</b>	<b>40</b>
<b>7.2 TEST SETUP</b>	<b>40</b>
<b>7.3 EUT OPERATION CONDITIONS</b>	<b>40</b>
<b>7.4 TEST RESULTS</b>	<b>41</b>
<b>8 . ANTENNA REQUIREMENT</b>	<b>43</b>
<b>8.1 STANDARD REQUIREMENT</b>	<b>43</b>
<b>8.2 EUT ANTENNA</b>	<b>43</b>
<b>9 . EUT TEST PHOTO</b>	<b>44</b>
<b>APPENDIX-PHOTOGRAPHS OF EUT CONSTRUCTIONAL DETAILS</b>	

### 1. SUMMARY OF TEST RESULTS

Test procedures according to the technical standards:

FCC Part15 (15.247) , Subpart C			
Standard Section	Test Item	Judgment	Remark
15.207	Conducted Emission	PASS	
15.247 (a)(2)	6dB Bandwidth	PASS	
15.247 (b)	Peak Output Power	PASS	
15.247 (c)	Radiated Spurious Emission	PASS	
15.247 (d)	Power Spectral Density	PASS	
15.205	Band Edge Emission	PASS	
15.203	Antenna Requirement	PASS	

**NOTE:**

(1) "N/A" denotes test is not applicable in this Test Report

### 1.1 TEST FACILITY

NTEK Testing Technology Co., Ltd

Add.:1/F, Building E, Fenda Science Park, Sanwei Community, Xixiang Street, Bao'an District, Shenzhen P.R. China.

FCC Registration No.:238937; IC Registration No.:9270A-1

CNAS Registration No.:L5516

### 1.2 MEASUREMENT UNCERTAINTY

The reported uncertainty of measurement  $y \pm U$ , where expanded uncertainty  $U$  is based on a standard uncertainty multiplied by a coverage factor of  $k=2$ , providing a level of confidence of approximately **95 %**.

No.	Item	Uncertainty
1	Conducted Emission Test	$\pm 1.38\text{dB}$
2	RF power,conducted	$\pm 0.16\text{dB}$
3	Spurious emissions,conducted	$\pm 0.21\text{dB}$
4	All emissions,radiated(<1G)	$\pm 4.68\text{dB}$
5	All emissions,radiated(>1G)	$\pm 4.89\text{dB}$
6	Temperature	$\pm 0.5^{\circ}\text{C}$
7	Humidity	$\pm 2\%$

## 2. GENERAL INFORMATION

### 2.1 GENERAL DESCRIPTION OF EUT

Equipment	Smartphone	
Trade Name	GLOBE, MULTITECH	
Model Name	GLB-MOB55	
Serial Model	GCP-5050, MT-MOB5050, MT-CP55	
Model Difference	All the model are the same circuit and RF module, except the model name and colour.	
Product Description	The EUT is a Smartphone	
	Operation Frequency:	2402~2480MHz
	Modulation Type:	GFSK
	Number Of Channel	40CH
	Antenna Designation:	Please see Note 3.
	Antenna Gain (dBi)	1.0dBi
	Based on the application, features, or specification exhibited in User's Manual, the EUT is considered as an ITE/Computing Device. More details of EUT technical specification, please refer to the User's Manual.	
Channel List	Please refer to the Note 2.	
Ratings	DC 3.8V	
Adapter	Model:JT105-050100 Input: AC100-240V~, 50/60Hz Output: 5.0V---, 1A	
Battery	DC 3.8V,2500mAh	
Connecting I/O Port(s)	Please refer to the User's Manual	

Note:

1. For a more detailed features description, please refer to the manufacturer's specifications or the User's Manual.

2.

Channel	Frequency (MHz)
00	2402
01	2404
.....	.....
.....	.....
...	...
.....	.....
38	2478
39	2480

3.

Table for Filed Antenna

Ant	Brand	Model Name	Antenna Type	Connector	Gain (dBi)	NOTE
A	N/A	N/A	FPCB Antenna	N/A	1.0	BT Antenna



**2.2 DESCRIPTION OF TEST MODES**

To investigate the maximum EMI emission characteristics generates from EUT, the test system was pre-scanning tested base on the consideration of following EUT operation mode or test configuration mode which possible have effect on EMI emission level. Each of these EUT operation mode(s) or test configuration mode(s) mentioned above was evaluated respectively.

Pretest Mode	Description
Mode 1	CH00
Mode 2	CH19
Mode 3	CH39
Mode 4	Link Mode

For Conducted Emission	
Final Test Mode	Description
Mode 4	Link Mode

For Radiated Emission	
Final Test Mode	Description
Mode 1	CH00
Mode 2	CH19
Mode 3	CH39
Mode 4	Link Mode

Note:

(1) The measurements are performed at the highest, middle, lowest available channels.

### 2.3 BLOCK DIGRAM SHOWING THE CONFIGURATION OF SYSTEM TESTED

#### Conducted Emission Test 1

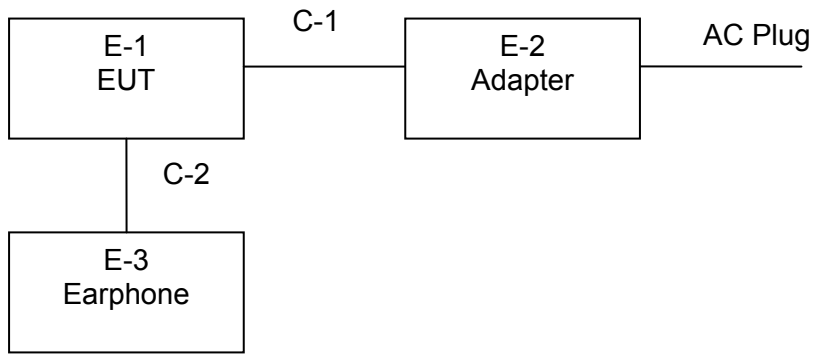

#### Conducted Emission Test 2

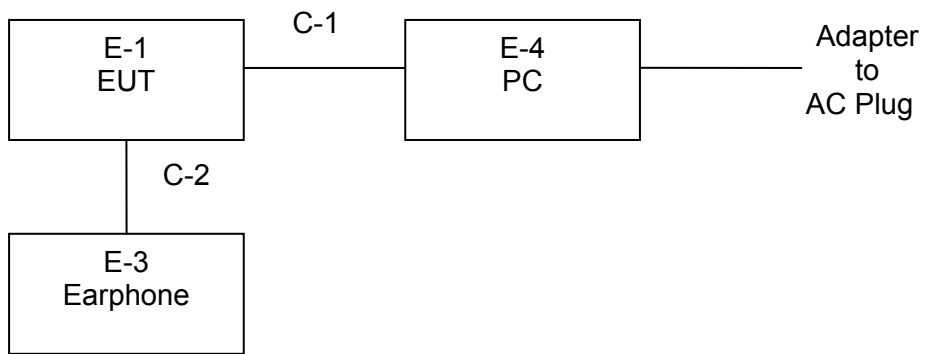

#### Radiated Spurious Emission Test

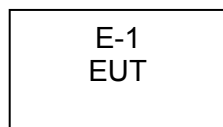

**2.4 DESCRIPTION OF SUPPORT UNITS(CONDUCTED MODE)**

The EUT has been tested as an independent unit together with other necessary accessories or support units. The following support units or accessories were used to form a representative test configuration during the tests.

Item	Equipment	Brand	Model/Type No.	Series No.	Note
E-1	Smartphone	GLOBE, MULTITECH	SM708	N/A	EUT
E-2	ADAPTER	N/A	SM708	N/A	
E-3	Earphone	N/A	2688	N/A	
E-4	PC	lenovo	Y43p	N/A	

Item	Shielded Type	Ferrite Core	Length	Note
C-1	NO	NO	1.2m	
C-2	NO	NO	1.0m	

Note:

- (1) The support equipment was authorized by Declaration of Confirmation.
- (2) For detachable type I/O cable should be specified the length in cm in 『Length』 column.

## 2.5 EQUIPMENTS LIST FOR ALL TEST ITEMS

### Radiation Test equipment

Item	Kind of Equipment	Manufacturer	Type No.	Serial No.	Last calibration	Calibrated until	Calibration period
1	Spectrum Analyzer	Agilent	E4407B	MY45108040	2015.07.06	2016.07.05	1 year
2	Test Receiver	R&S	ESPI	101318	2015.06.07	2016.06.06	1 year
3	Bilog Antenna	TESEQ	CBL6111D	31216	2015.07.06	2016.07.05	1 year
4	50Ω Coaxial Switch	Anritsu	MP59B	6200264416	2015.06.07	2016.06.06	1 year
5	Spectrum Analyzer	ADVANTEST	R3132	150900201	2015.06.07	2016.06.06	1 year
6	Horn Antenna	EM	EM-AH-10180	2011071402	2015.07.06	2016.07.05	1 year
7	Horn Ant	Schwarzbeck	BBHA 9170	9170-181	2015.07.06	2016.07.05	1 year
8	Amplifier	EM	EM-30180	060538	2014.12.22	2015.12.21	1 year
9	Loop Antenna	ARA	PLA-1030/B	1029	2015.06.08	2016.06.07	1 year
10	Power Meter	R&S	NRVS	100696	2015.07.06	2016.07.05	1 year
11	Power Sensor	R&S	URV5-Z4	0395.1619.05	2015.07.06	2016.07.05	1 year

### Conduction Test equipment

Item	Kind of Equipment	Manufacturer	Type No.	Serial No.	Last calibration	Calibrated until	Calibration period
1	Test Receiver	R&S	ESCI	101160	2015.06.06	2016.06.05	1 year
2	LISN	R&S	ENV216	101313	2015.08.24	2016.08.23	1 year
3	LISN	EMCO	3816/2	00042990	2015.08.24	2016.08.23	1 year
4	50Ω Coaxial Switch	Anritsu	MP59B	6200264417	2015.06.07	2016.06.06	1 year
5	Passive Voltage Probe	R&S	ESH2-Z3	100196	2015.06.07	2016.06.06	1 year
6	Absorbing clamp	R&S	MOS-21	100423	2015.06.08	2016.06.07	1 year

1	Attenuation	MCE	24-10-34	BN9258	2015.06.08	2016.06.07	1 year
---	-------------	-----	----------	--------	------------	------------	--------

### 3. EMC EMISSION TEST

#### 3.1 CONDUCTED EMISSION MEASUREMENT

##### 3.1.1 POWER LINE CONDUCTED EMISSION Limits (Frequency Range 150KHz-30MHz)

FREQUENCY (MHz)	Class A (dBuV)		Class B (dBuV)		Standard
	Quasi-peak	Average	Quasi-peak	Average	
0.15 -0.5	79.00	66.00	66 - 56 *	56 - 46 *	CISPR
0.50 -5.0	73.00	60.00	56.00	46.00	CISPR
5.0 -30.0	73.00	60.00	60.00	50.00	CISPR

0.15 -0.5	79.00	66.00	66 - 56 *	56 - 46 *	FCC
0.50 -5.0	73.00	60.00	56.00	46.00	FCC
5.0 -30.0	73.00	60.00	60.00	50.00	FCC

Note:

- (1) The tighter limit applies at the band edges.
- (2) The limit of " \* " marked band means the limitation decreases linearly with the logarithm of the frequency in the range.

The following table is the setting of the receiver

Receiver Parameters	Setting
Attenuation	10 dB
Start Frequency	0.15 MHz
Stop Frequency	30 MHz
IF Bandwidth	9 kHz

### 3.1.2 TEST PROCEDURE

- a. The EUT was placed 0.8 meters from the horizontal ground plane with EUT being connected to the power mains through a line impedance stabilization network (LISN). All other support equipments powered from additional LISN(s). The LISN provide 50 Ohm/ 50uH of coupling impedance for the measuring instrument.
- b. Interconnecting cables that hang closer than 40 cm to the ground plane shall be folded back and forth in the center forming a bundle 30 to 40 cm long.
- c. I/O cables that are not connected to a peripheral shall be bundled in the center. The end of the cable may be terminated, if required, using the correct terminating impedance. The overall length shall not exceed 1 m.
- d. LISN at least 80 cm from nearest part of EUT chassis.
- e. For the actual test configuration, please refer to the related Item –EUT Test Photos.

### 3.1.3 DEVIATION FROM TEST STANDARD

No deviation

### 3.1.4 TEST SETUP

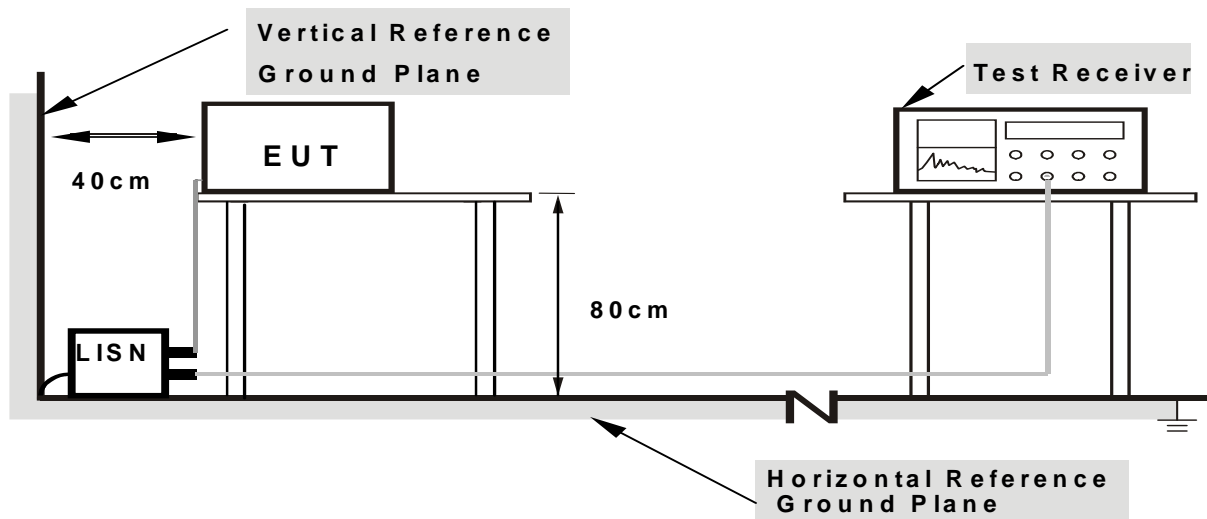

**Note: 1. Support units were connected to second LISN.**

**2. Both of LISNs (AMN) are 80 cm from EUT and at least 80 cm from other units and other metal planes**

### 3.1.5 EUT OPERATING CONDITIONS

The EUT was configured for testing in a typical fashion (as a customer would normally use it). The EUT has been programmed to continuously transmit during test. This operating condition was tested and used to collect the included data.

### 3.1.6 TEST RESULTS

EUT :	Smartphone	Model Name. :	GLB-MOB55
Temperature :	26 °C	Relative Humidity :	56%
Pressure :	1010hPa	Phase :	L
Test Voltage :	DC 5.0V form Adapter AC 120V/60Hz	Test Mode :	Mode 4

Frequency (MHz)	Reading Level (dBμV)	Correct Factor (dB)	Measure-ment (dBμV)	Limits (dBμV)	Margin (dB)	Remark
0.1700	43.50	9.47	52.97	64.96	-11.99	QP
0.1700	29.97	9.47	39.44	54.96	-15.52	AVG
0.4620	42.42	9.40	51.82	56.66	-4.84	QP
0.4620	29.60	9.40	39.00	46.66	-7.66	AVG
0.6460	41.12	9.56	50.68	56.00	-5.32	QP
0.6460	26.24	9.56	35.80	46.00	-10.20	AVG
1.2940	41.21	9.57	50.78	56.00	-5.22	QP
1.2940	27.83	9.57	37.40	46.00	-8.60	AVG
1.9899	39.59	9.57	49.16	56.00	-6.84	QP
1.9899	25.47	9.57	35.04	46.00	-10.96	AVG
4.0696	37.85	9.66	47.51	56.00	-8.49	QP
4.0696	23.67	9.66	33.33	46.00	-12.67	AVG

Remark:

1. All readings are Quasi-Peak and Average values.
2. Factor = Insertion Loss + Cable Loss.

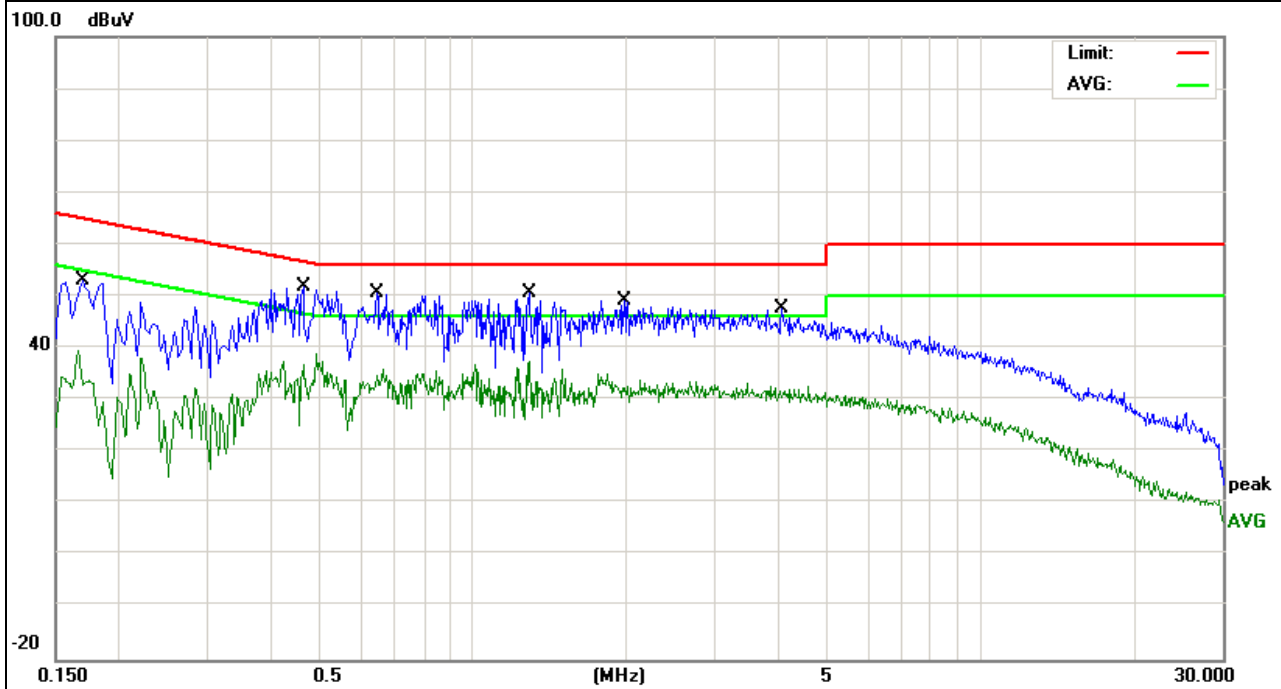

EUT :	Smartphone	Model Name. :	GLB-MOB55
Temperature :	26 °C	Relative Humidity :	56%
Pressure :	1010hPa	Phase :	N
Test Voltage :	DC 5.0V form Adapter AC 120V/60Hz	Test Mode :	Mode 4

Frequency (MHz)	Meter Reading (dBμV)	Factor (dB)	Emission Level (dBμV)	Limits (dBμV)	Margin (dB)	Remark
0.1779	43.50	9.47	52.97	64.58	-11.61	QP
0.1779	30.58	9.47	40.05	54.58	-14.53	AVG
0.4060	40.34	9.18	49.52	57.73	-8.21	QP
0.4060	30.35	9.18	39.53	47.73	-8.20	AVG
0.5299	40.57	9.55	50.12	56.00	-5.88	QP
0.5299	27.31	9.55	36.86	46.00	-9.14	AVG
0.8138	38.31	9.57	47.88	56.00	-8.12	QP
0.8138	24.69	9.57	34.26	46.00	-11.74	AVG
1.7980	37.20	9.57	46.77	56.00	-9.23	QP
1.7980	23.38	9.57	32.95	46.00	-13.05	AVG
3.7099	34.49	9.64	44.13	56.00	-11.87	QP
3.7099	22.29	9.64	31.93	46.00	-14.07	

Remark:  
 1. All readings are Quasi-Peak and Average values.  
 2. Factor = Insertion Loss + Cable Loss.

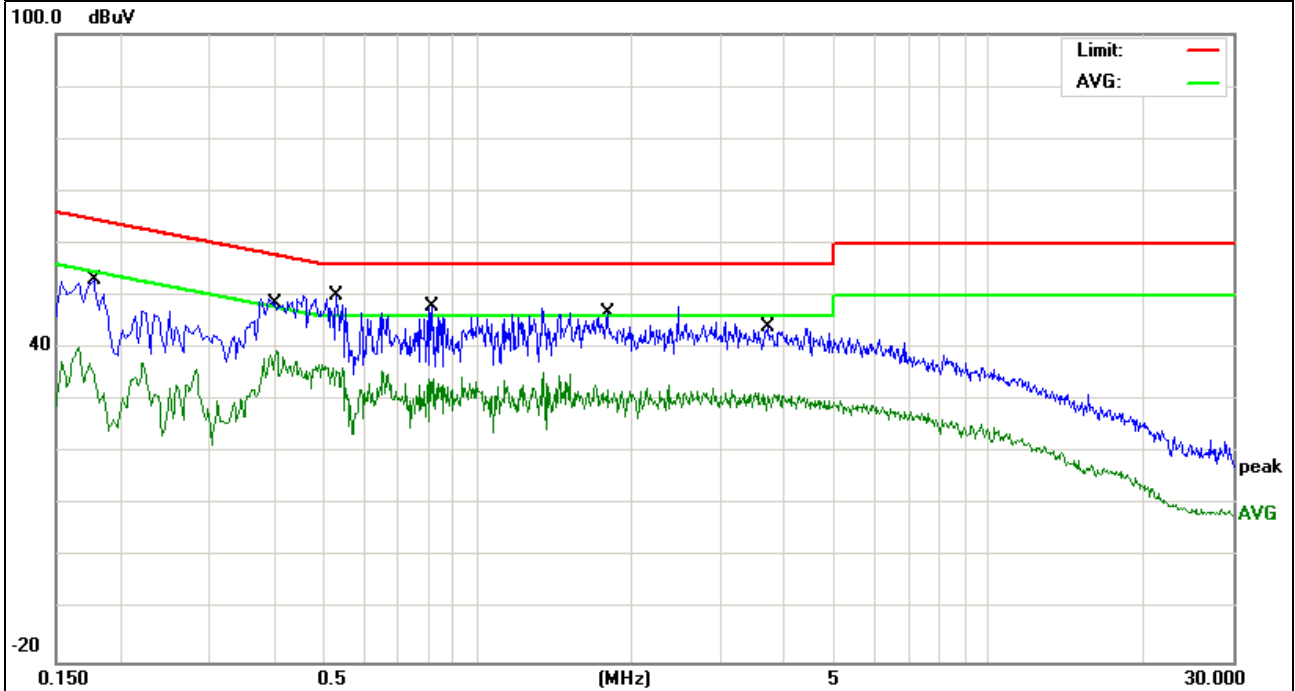



EUT :	Smartphone	Model Name :	SM708
Temperature :	26 °C	Relative Humidity :	54%
Pressure :	1010hPa	Phase :	L
Test Voltage :	DC 5.0V from adapter AC 240V/60Hz	Test Mode :	Mode 4

Frequency (MHz)	Reading Level (dBμV)	Correct Factor (dB)	Measure-ment (dBμV)	Limits (dBμV)	Margin (dB)	Remark
0.2379	44.18	9.50	53.68	62.17	-8.49	QP
0.2379	34.22	9.50	43.72	52.17	-8.45	AVG
0.3497	42.28	9.37	51.65	58.97	-7.32	QP
0.3497	30.67	9.37	40.04	48.97	-8.93	AVG
0.4979	41.07	9.54	50.61	56.03	-5.42	QP
0.4979	30.70	9.54	40.24	46.03	-5.79	AVG
0.7980	42.19	9.57	51.76	56.00	-4.24	QP
0.7980	30.60	9.57	40.17	46.00	-5.83	AVG
1.2940	41.76	9.57	51.33	56.00	-4.67	QP
1.2940	32.13	9.57	41.70	46.00	-4.30	AVG
3.3900	40.41	9.64	50.05	56.00	-5.95	QP
3.3900	29.34	9.64	38.98	46.00	-7.02	AVG

Remark:

1. All readings are Quasi-Peak and Average values.
2. Factor = Insertion Loss + Cable Loss.

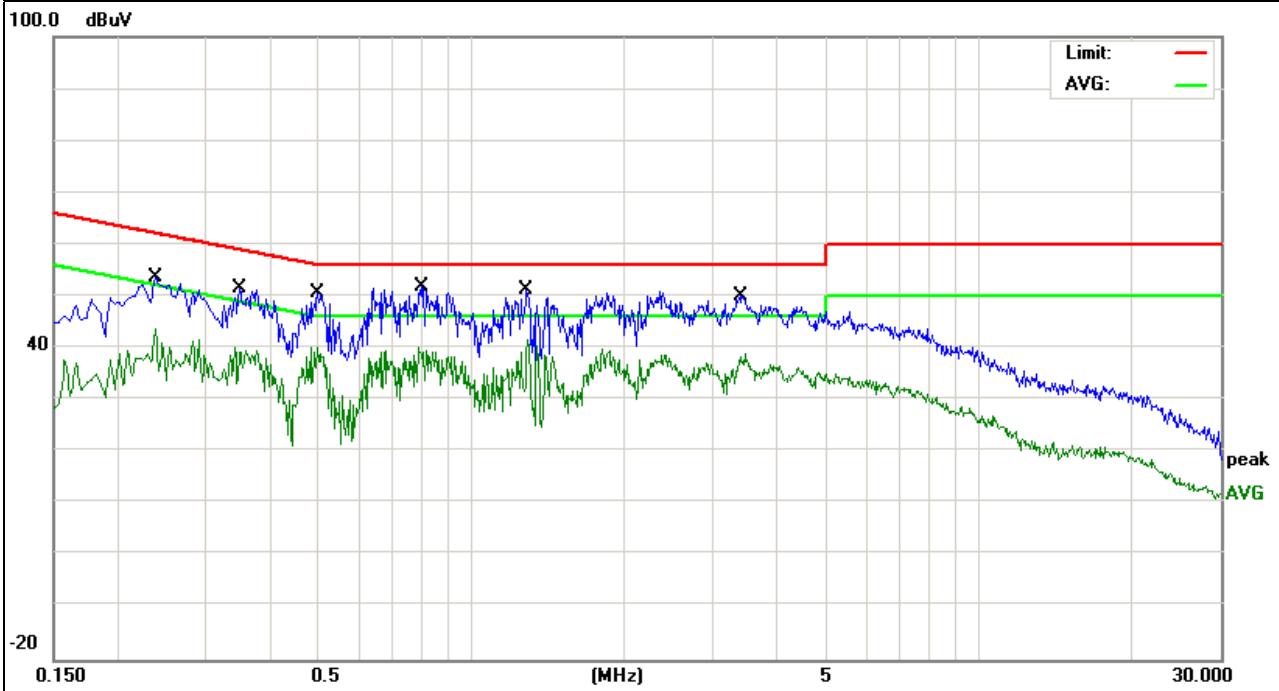

EUT :	Smartphone	Model Name :	SM708
Temperature :	26 °C	Relative Humidity :	54%
Pressure :	1010hPa	Phase :	N
Test Voltage :	DC 5.0V from adapter AC 240V/60Hz	Test Mode :	Mode 4

Frequency (MHz)	Reading Level (dBμV)	Correct Factor (dB)	Measure-ment (dBμV)	Limits (dBμV)	Margin (dB)	Remark
0.2300	41.33	9.49	50.82	62.45	-11.63	QP
0.2300	31.33	9.49	40.82	52.45	-11.63	AVG
0.3940	42.72	9.18	51.90	57.98	-6.08	QP
0.3940	31.42	9.18	40.60	47.98	-7.38	AVG
0.5060	43.03	9.55	52.58	56.00	-3.42	QP
0.5060	30.97	9.55	40.52	46.00	-5.48	AVG
0.8418	40.32	9.57	49.89	56.00	-6.11	QP
0.8418	30.12	9.57	39.69	46.00	-6.31	AVG
1.3460	39.36	9.57	48.93	56.00	-7.07	QP
1.3460	32.23	9.57	41.80	46.00	-4.20	AVG
3.3700	39.80	9.64	49.44	56.00	-6.56	QP
3.3700	28.79	9.64	38.43	46.00	-7.57	AVG

Remark:

1. All readings are Quasi-Peak and Average values.
2. Factor = Insertion Loss + Cable Loss.

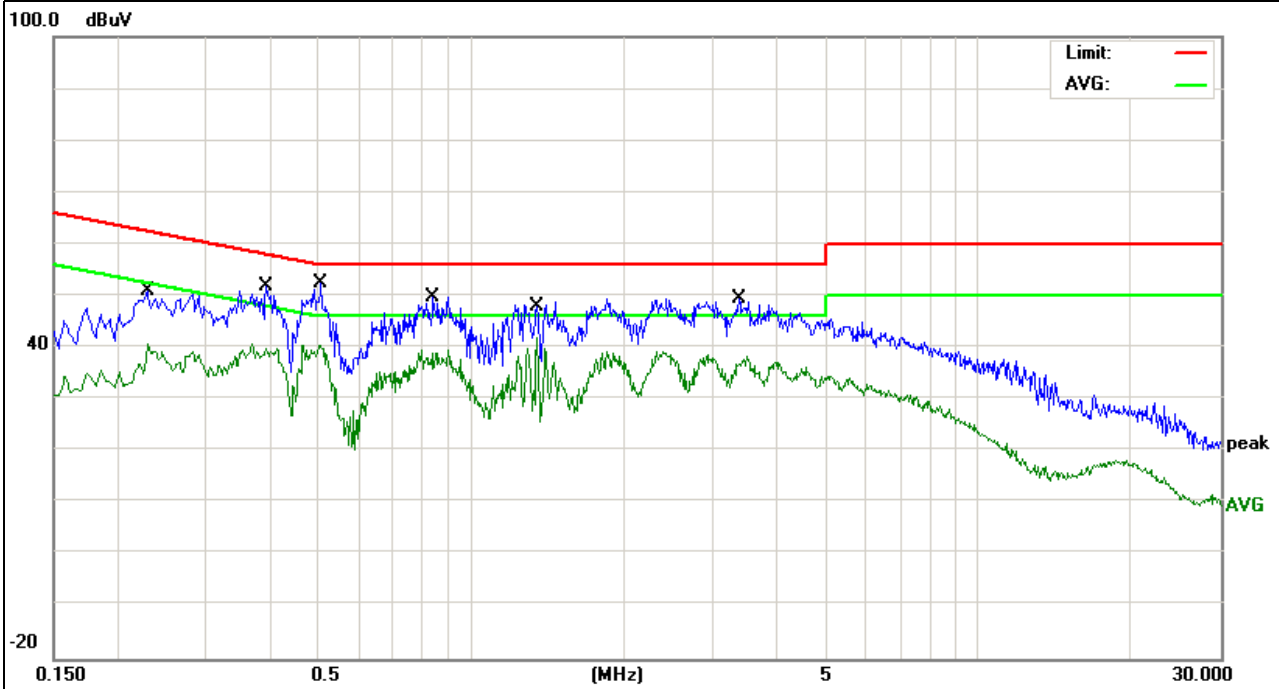

EUT :	Smartphone	Model Name. :	GLB-MOB55
Temperature :	26 °C	Relative Humidity :	56%
Pressure :	1010hPa	Phase :	L
Test Voltage :	DC 5.0V form PC AC 120V/60Hz	Test Mode :	Mode 4

Frequency (MHz)	Meter Reading (dBμV)	Factor (dB)	Emission Level (dBμV)	Limits (dBμV)	Margin (dB)	Remark
0.1500	39.88	9.49	49.37	65.99	-16.62	QP
0.1500	22.37	9.49	31.86	55.99	-24.13	AVG
0.2300	33.53	9.49	43.02	62.45	-19.43	QP
0.2300	22.07	9.49	31.56	52.45	-20.89	AVG
0.3500	28.03	9.36	37.39	58.96	-21.57	QP
0.3500	15.76	9.36	25.12	48.96	-23.84	AVG
0.4740	31.18	9.45	40.63	56.44	-15.81	QP
0.4740	15.82	9.45	25.27	46.44	-21.17	AVG
0.5700	29.13	9.56	38.69	56.00	-17.31	QP
0.5700	14.81	9.56	24.37	46.00	-21.63	AVG
4.1059	27.49	9.66	37.15	56.00	-18.85	QP
4.1059	18.35	9.66	28.01	46.00	-17.99	AVG

Remark:  
 1. All readings are Quasi-Peak and Average values.  
 2. Factor = Insertion Loss + Cable Loss.

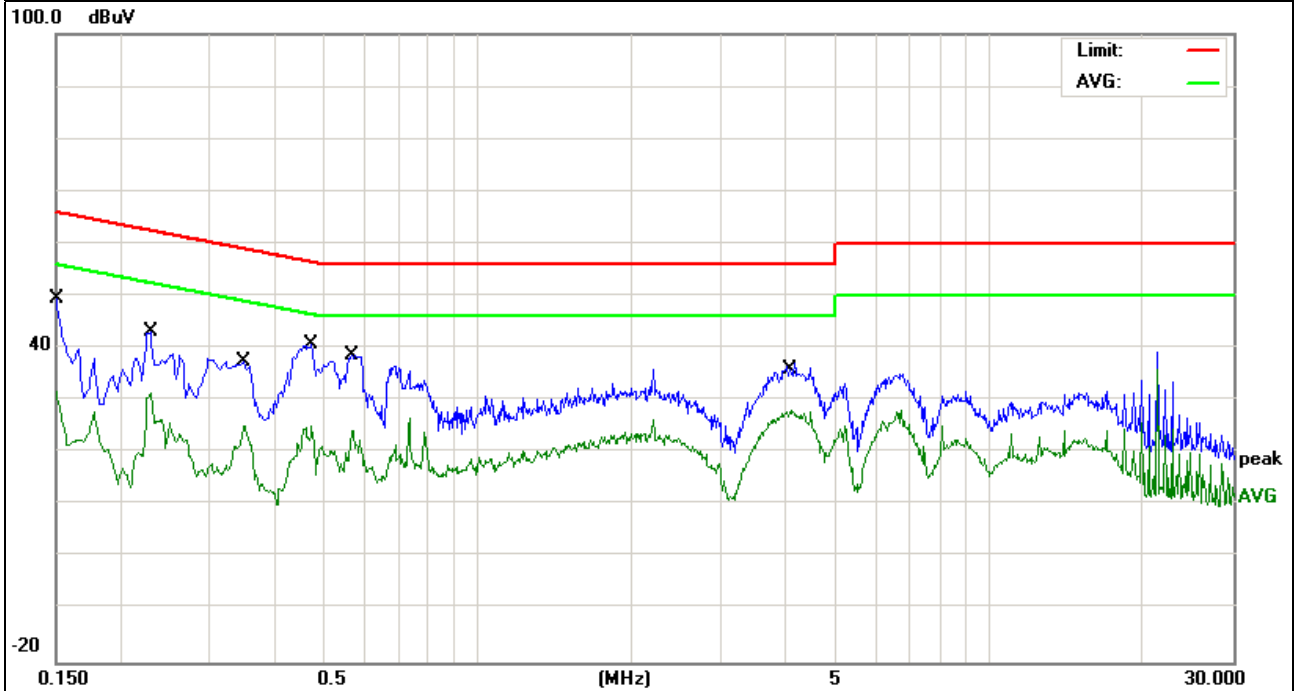

EUT :	Smartphone	Model Name. :	GLB-MOB55
Temperature :	26 °C	Relative Humidity :	56%
Pressure :	1010hPa	Phase :	N
Test Voltage :	DC 5.0V form PC AC 120V/60Hz	Test Mode :	Mode 4

Frequency (MHz)	Meter Reading (dBμV)	Factor (dB)	Emission Level (dBμV)	Limits (dBμV)	Margin (dB)	Remark
0.1660	33.48	9.48	42.96	65.15	-22.19	QP
0.1660	21.75	9.48	31.23	55.15	-23.92	AVG
0.2260	32.68	9.48	42.16	62.59	-20.43	QP
0.2260	22.13	9.48	31.61	52.59	-20.98	AVG
0.4620	31.34	9.40	40.74	56.66	-15.92	QP
0.4620	15.35	9.40	24.75	46.66	-21.91	AVG
0.5899	29.50	9.56	39.06	56.00	-16.94	QP
0.5899	15.99	9.56	25.55	46.00	-20.45	AVG
0.7380	25.78	9.57	35.35	56.00	-20.65	QP
0.7380	16.21	9.57	25.78	46.00	-20.22	AVG
4.0020	26.51	9.66	36.17	56.00	-19.83	QP
4.0020	18.53	9.66	28.19	46.00	-17.81	AVG

Remark:

1. All readings are Quasi-Peak and Average values.
2. Factor = Insertion Loss + Cable Loss.

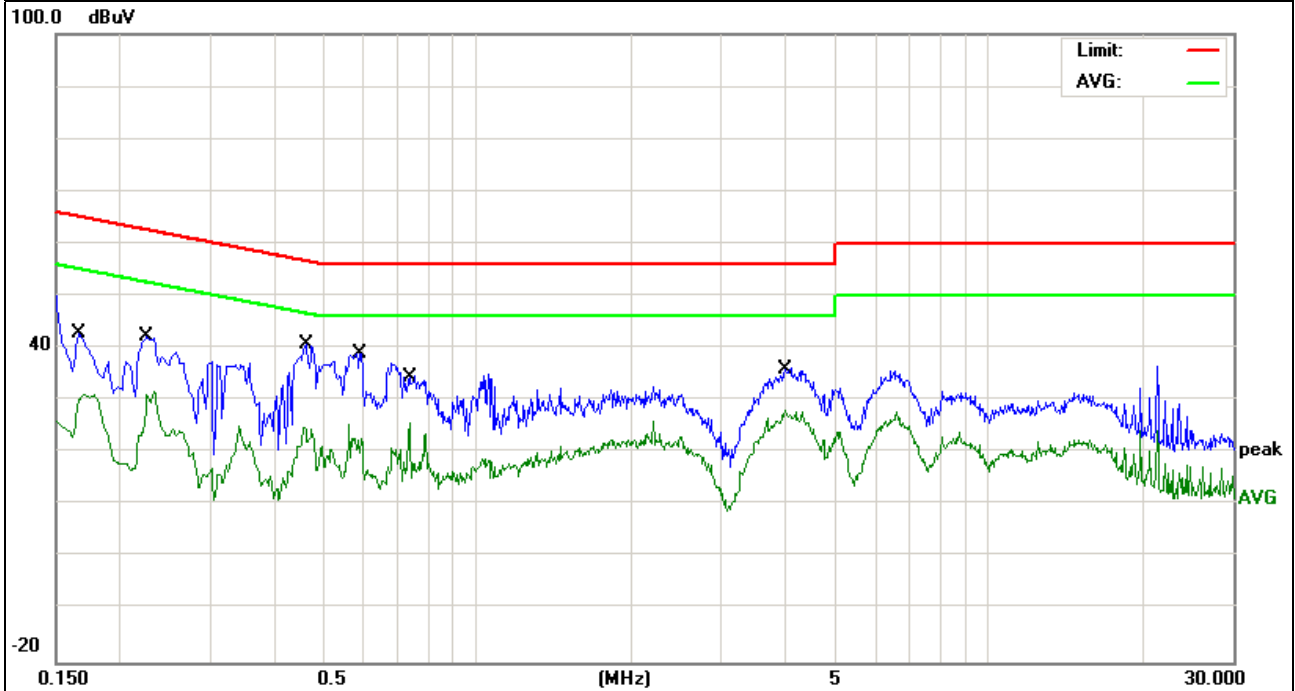

EUT :	Smartphone	Model Name :	SM708
Temperature :	26 °C	Relative Humidity :	54%
Pressure :	1010hPa	Phase :	L
Test Voltage :	DC 5.0V from PC AC 240V/60Hz	Test Mode :	Mode 4

Frequency (MHz)	Reading Level (dBμV)	Correct Factor (dB)	Measure-ment (dBμV)	Limits (dBμV)	Margin (dB)	Remark
0.2420	32.56	9.50	42.06	62.02	-19.96	QP
0.2420	19.28	9.50	28.78	52.02	-23.24	AVG
0.3420	30.53	9.40	39.93	59.15	-19.22	QP
0.3420	19.92	9.40	29.32	49.15	-19.83	AVG
0.5299	36.22	9.55	45.77	56.00	-10.23	QP
0.5299	19.69	9.55	29.24	46.00	-16.76	AVG
0.7140	32.65	9.57	42.22	56.00	-13.78	QP
0.7140	18.63	9.57	28.20	46.00	-17.80	AVG
4.2379	28.10	9.66	37.76	56.00	-18.24	QP
4.2379	18.79	9.66	28.45	46.00	-17.55	AVG
21.3580	27.28	9.98	37.26	60.00	-22.74	QP
21.3580	16.73	9.98	26.71	50.00	-23.29	AVG

Remark:

1. All readings are Quasi-Peak and Average values.
2. Factor = Insertion Loss + Cable Loss.

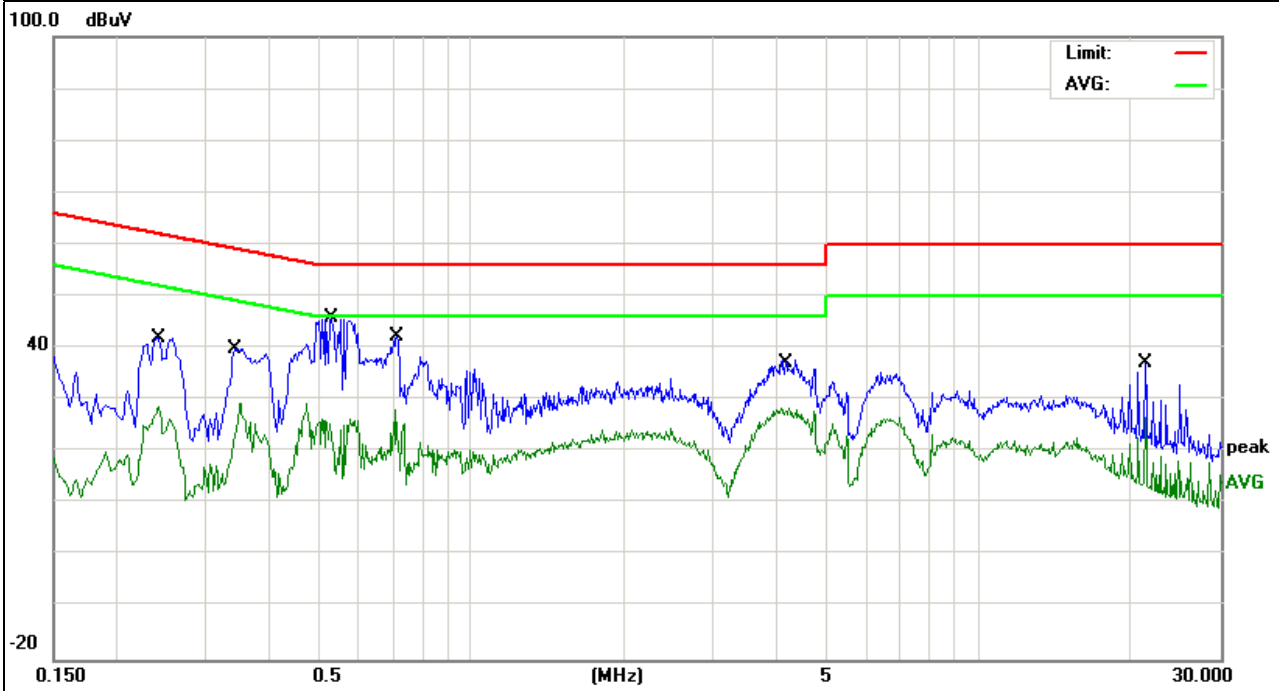

EUT :	Smartphone	Model Name :	SM708
Temperature :	26 °C	Relative Humidity :	54%
Pressure :	1010hPa	Phase :	N
Test Voltage :	DC 5.0V from PC AC 240V/60Hz	Test Mode :	Mode 4

Frequency (MHz)	Reading Level (dBμV)	Correct Factor (dB)	Measure-ment (dBμV)	Limits (dBμV)	Margin (dB)	Remark
0.2300	32.60	9.49	42.09	62.45	-20.36	QP
0.2300	19.57	9.49	29.06	52.45	-23.39	AVG
0.3500	30.96	9.36	40.32	58.96	-18.64	QP
0.3500	19.66	9.36	29.02	48.96	-19.94	AVG
0.5140	36.89	9.55	46.44	56.00	-9.56	QP
0.5140	20.19	9.55	29.74	46.00	-16.26	AVG
1.0020	29.67	9.56	39.23	56.00	-16.77	QP
1.0020	11.61	9.56	21.17	46.00	-24.83	AVG
4.0539	27.03	9.66	36.69	56.00	-19.31	QP
4.0539	19.34	9.66	29.00	46.00	-17.00	AVG
21.3660	29.90	9.98	39.88	60.00	-20.12	QP
21.3660	27.27	9.98	37.25	50.00	-12.75	AVG

Remark:

1. All readings are Quasi-Peak and Average values.
2. Factor = Insertion Loss + Cable Loss.

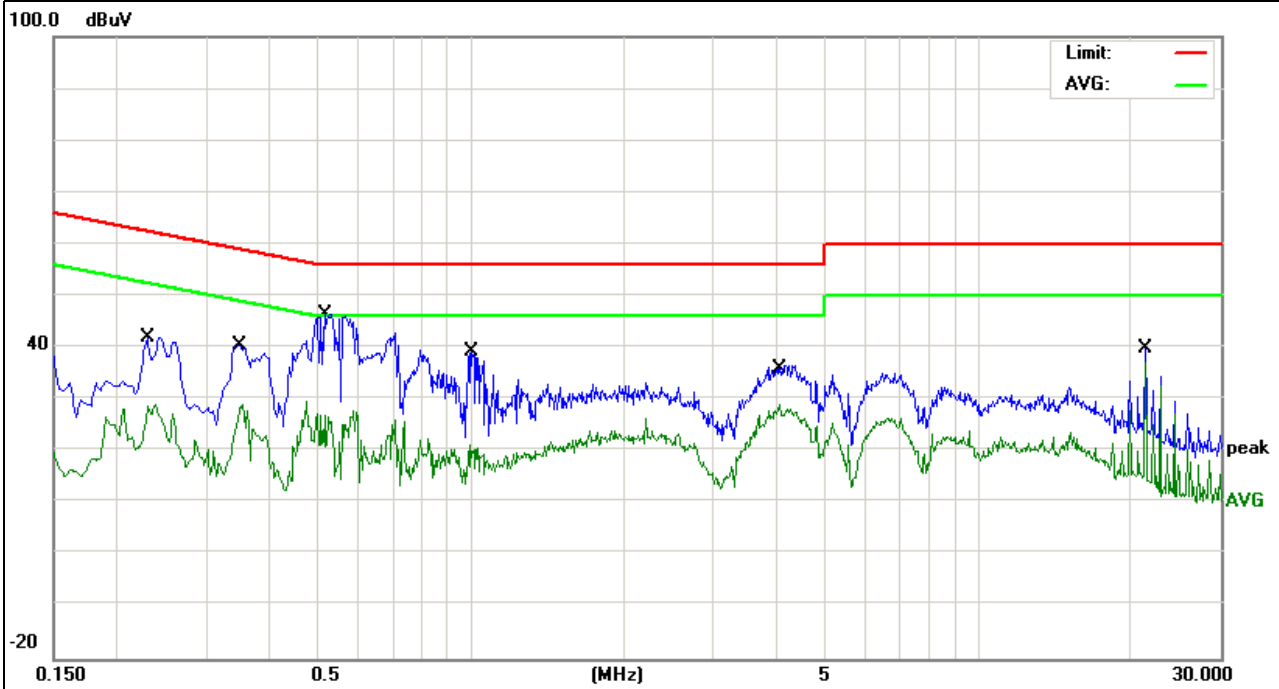

### 3.2 RADIATED EMISSION MEASUREMENT

#### 3.2.1 RADIATED EMISSION LIMITS (Frequency Range 9kHz-1000MHz)

20dBc in any 100 kHz bandwidth outside the operating frequency band. In case the emission fall within the restricted band specified on 15.205(a), then the 15.209(a) limit in the table below has to be followed.

Frequencies (MHz)	Field Strength (microrvolts/meter)	Measurement Distance (meters)
0.009~0.490	2400/F(KHz)	300
0.490~1.705	24000/F(KHz)	30
1.705~30.0	30	30
30~88	100	3
88~216	150	3
216~960	200	3
Above 960	500	3

#### LIMITS OF RADIATED EMISSION MEASUREMENT (Above 1000MHz)

FREQUENCY (MHz)	Class B (dBuV/m) (at 3M)	
	PEAK	AVERAGE
Above 1000	74	54

Notes:

- (1) The limit for radiated test was performed according to FCC PART 15C.
- (2) The tighter limit applies at the band edges.
- (3) Emission level (dBuV/m)=20log Emission level (uV/m).

Spectrum Parameter	Setting
Attenuation	Auto
Start Frequency	1000 MHz
Stop Frequency	10th carrier harmonic
RB / VB (emission in restricted band)	1 MHz / 1 MHz for Peak, 1 MHz / 10Hz for Average

Receiver Parameter	Setting
Attenuation	Auto
Start ~ Stop Frequency	9kHz~150kHz / RB 200Hz for QP
Start ~ Stop Frequency	150kHz~30MHz / RB 9kHz for QP
Start ~ Stop Frequency	30MHz~1000MHz / RB 120kHz for QP

**3.2.2 TEST PROCEDURE**

- a. The measuring distance of at 3 m shall be used for measurements at frequency up to 1GHz. For frequencies above 1GHz, any suitable measuring distance may be used.
- b. The EUT was placed on the top of a rotating table 0.8 m for below 1GHz and 1.5m for above 1GHz the ground at a 3 meter open area test site. The table was rotated 360 degrees to determine the position of the highest radiation.
- c. The height of the equipment or of the substitution antenna shall be 0.8 m for below 1GHz and 1.5m for above 1GHz; the height of the test antenna shall vary between 1 m to 4 m. Both horizontal and vertical polarizations of the antenna are set to make the measurement.
- d. The initial step in collecting conducted emission data is a spectrum analyzer peak detector mode pre-scanning the measurement frequency range. Significant peaks are then marked and then Quasi Peak detector mode re-measured.
- e. If the Peak Mode measured value compliance with and lower than Quasi Peak Mode Limit, the EUT shall be deemed to meet QP Limits and then no additional QP Mode measurement performed.
- f. For the actual test configuration, please refer to the related Item –EUT Test Photos.

Note:

Both horizontal and vertical antenna polarities were tested and performed pretest to three orthogonal axis. The worst case emissions were reported

During the radiated emission test, the Spectrum Analyzer was set with the following configurations:

Frequency Band (MHz)	Function	Resolution bandwidth	Video Bandwidth
30 to 1000	QP	120 kHz	300 kHz
Above 1000	Peak	1 MHz	1 MHz
	Peak	1 MHz	10 Hz

**3.2.3 DEVIATION FROM TEST STANDARD**

No deviation



### 3.2.4 TEST SETUP

#### (A) Radiated Emission Test-Up Frequency Below 30MHz

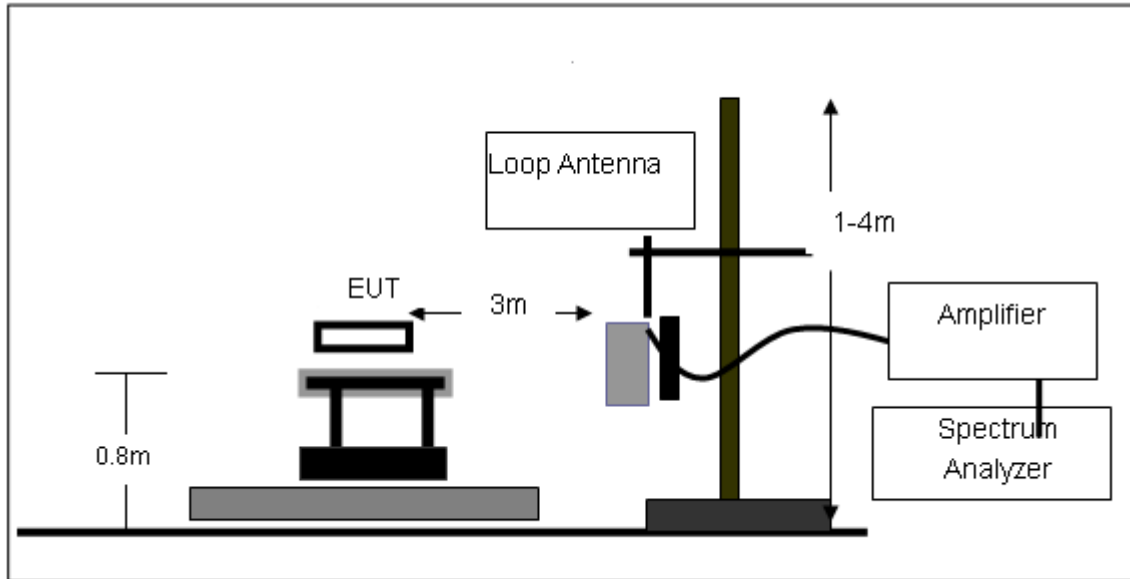

#### (B) Radiated Emission Test-Up Frequency 30MHz~1GHz

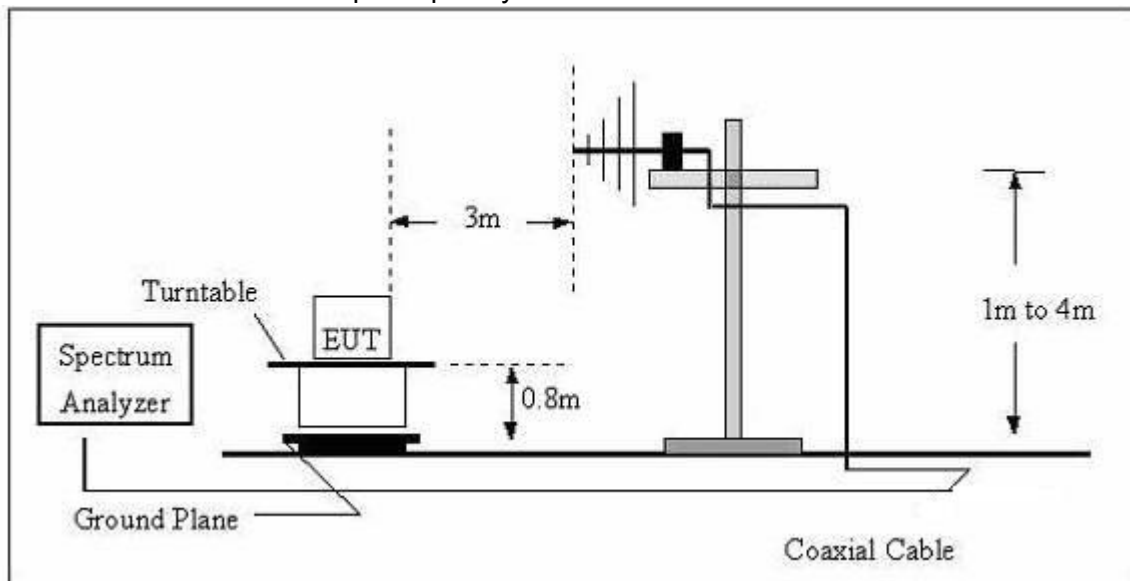

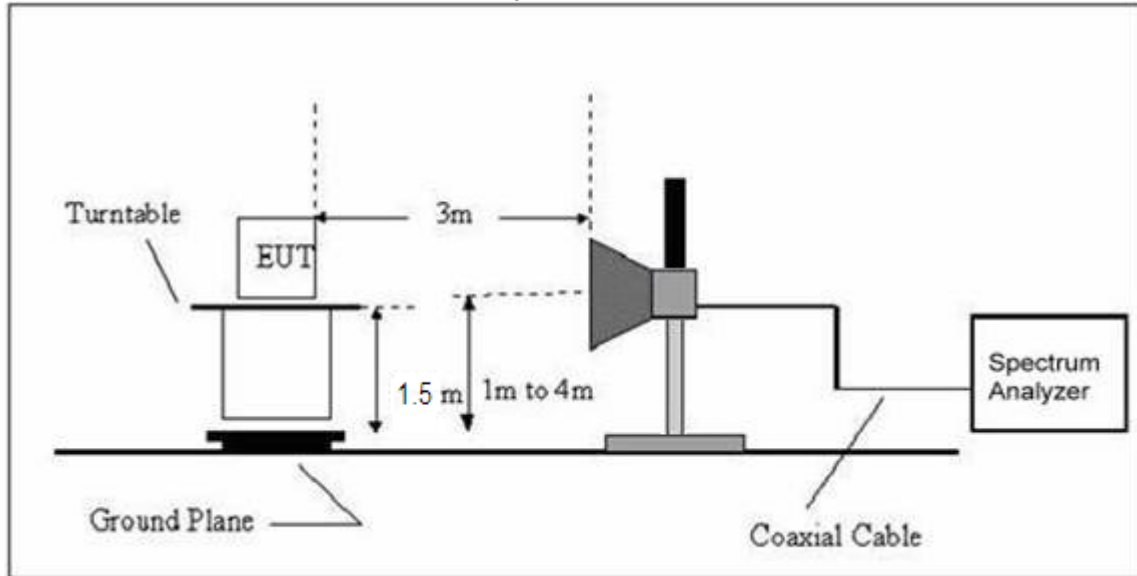
**(C) Radiated Emission Test-Up Frequency Above 1GHz****3.2.5 EUT OPERATING CONDITIONS**

The EUT tested system was configured as the statements of 2.4 Unless otherwise a special operating condition is specified in the follows during the testing.

**3.2.6 TEST RESULTS (BETWEEN 9KHZ – 30 MHZ)**

EUT:	Smartphone	Model Name. :	GLB-MOB55
Temperature:	20 °C	Relative Humidity:	48%
Pressure:	1010 hPa	Test Voltage :	DC 3.8V
Test Mode :	TX	Polarization :	--

Freq. (MHz)	Reading (dBuV/m)	Limit (dBuV/m)	Margin (dB)	State P/F
--	--	--	--	N/A
--	--	--	--	N/A

**NOTE:**

The amplitude of spurious emissions which are attenuated by more than 20dB below the permissible value has no need to be reported.

Distance extrapolation factor =  $40 \log (\text{specific distance}/\text{test distance})(\text{dB})$ ;

Limit line = specific limits(dBuv) + distance extrapolation factor.

### 3.2.7 TEST RESULTS (BETWEEN 30MHZ – 1GHZ)

EUT :	Smartphone	Model Name :	GLB-MOB55
Temperature :	20 °C	Relative Humidity :	48%
Pressure:	1010 hPa	Test Voltage :	DC 3.8V
Test Mode :	TX-High CH		

Polar (H/V)	Frequency	Meter Reading	Factor	Emission Level	Limits	Margin	Remark
	(MHz)	(dBuV)	(dB)	(dBuV/m)	(dBuV/m)	(dB)	
V	30.5306	7.98	19.38	27.36	40.00	-12.64	QP
V	35.8746	6.16	17.00	23.16	40.00	-16.84	QP
V	44.2751	8.57	12.38	20.95	40.00	-19.05	QP
V	99.5281	14.50	10.30	24.80	43.50	-18.70	QP
V	162.0414	11.33	11.56	22.89	43.50	-20.61	QP
V	202.8103	11.28	11.53	22.81	43.50	-20.69	QP

**Remark:**

Absolute Level= ReadingLevel+ Factor, Margin= Absolute Level - Limit

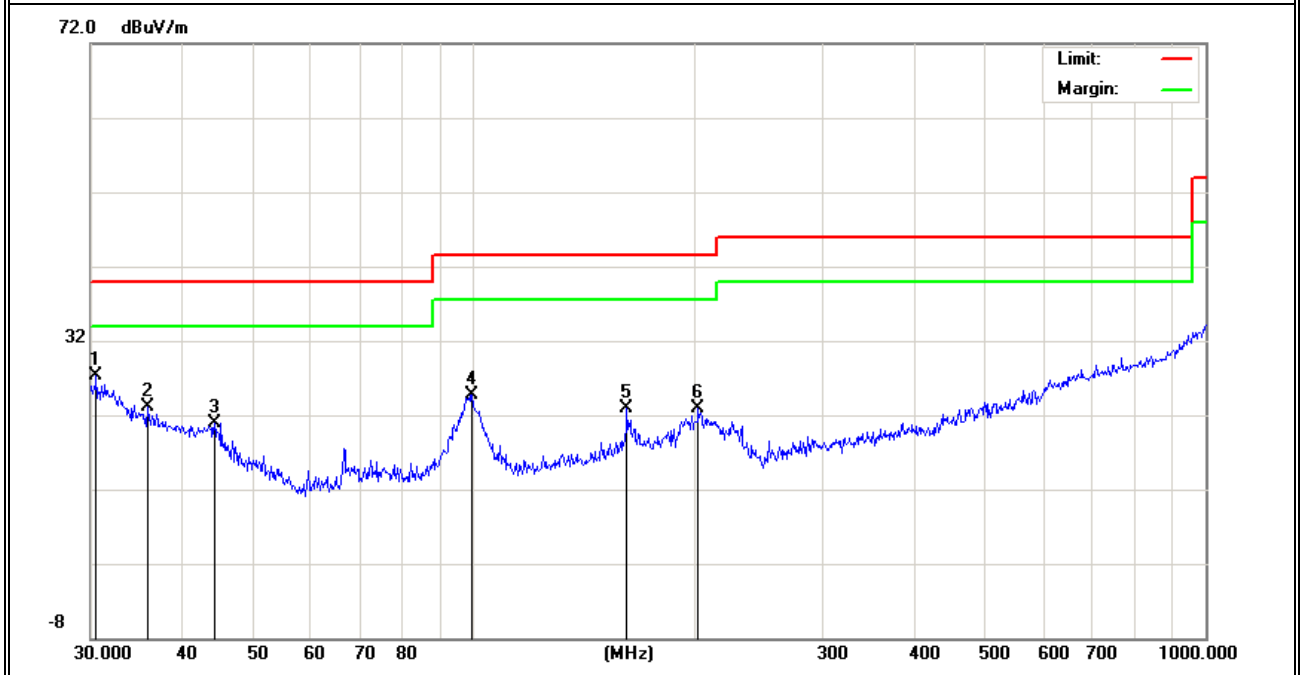

Polar (H/V)	Frequency	Meter Reading	Factor	Emission Level	Limits	Margin	Remark
	(MHz)	(dBuV)	(dB)	(dBuV/m)	(dBuV/m)	(dB)	
H	32.1795	5.67	18.73	24.40	40.00	-15.60	peak
H	36.8953	5.55	16.41	21.96	40.00	-18.04	peak
H	98.8326	10.81	10.37	21.18	43.50	-22.32	peak
H	197.2001	9.48	11.45	20.93	43.50	-22.57	peak
H	618.5369	6.64	19.88	26.52	46.00	-19.48	peak
H	842.1296	7.56	23.30	30.86	46.00	-15.14	peak

**Remark:**

Absolute Level= ReadingLevel+ Factor, Margin= Absolute Level - Limit

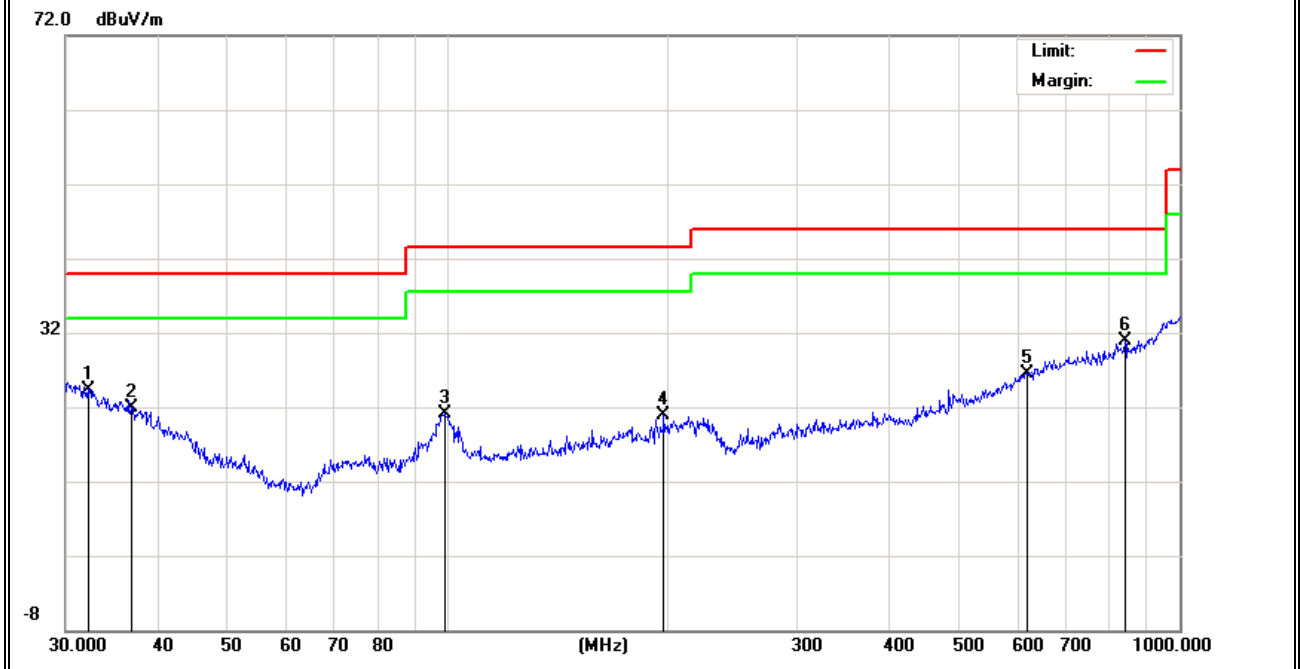

### 3.2.8 TEST RESULTS (ABOVE 1000 MHZ)

EUT :	Smartphone	Model Name :	GLB-MOB55
Temperature :	20 °C	Relative Humidity :	48%
Pressure:	1010 hPa	Test Voltage :	DC 3.8V
Test Mode :	TX		

Frequency (MHz)	Reading (dBµV)	Factor (dB)	Corrected Amplitude (dBµV/m)	Limit (dBµV/m)	Margin (dB)	Remark	Polar (H/V)
Low Channel (2402 MHz)-Above 1G							
4804.154	61.25	-3.64	57.61	74.00	-16.39	Pk	Vertical
4804.154	40.87	-3.64	37.23	54.00	-16.77	AV	Vertical
7206.263	62.53	-0.95	61.58	74.00	-12.42	Pk	Vertical
7206.263	40.17	-0.95	39.22	54.00	-14.78	AV	Vertical
4804.347	64.59	-3.64	60.95	74.00	-13.05	Pk	Horizontal
4804.347	41.37	-3.64	37.73	54.00	-16.27	AV	Horizontal
7206.221	59.68	-0.95	58.73	74.00	-15.27	Pk	Horizontal
7206.221	40.15	-0.95	39.20	54.00	-14.80	AV	Horizontal
Mid Channel (2440 MHz)-Above 1G							
4880.199	60.35	-3.68	56.67	74.00	-17.33	Pk	Vertical
4880.199	41.96	-3.68	38.28	54.00	-15.72	AV	Vertical
7320.162	60.02	-0.82	59.20	74.00	-14.80	Pk	Vertical
7320.162	42.33	-0.82	41.51	54.00	-12.49	AV	Vertical
4880.258	64.15	-3.68	60.47	74.00	-13.53	Pk	Horizontal
4880.258	40.98	-3.68	37.30	54.00	-16.70	AV	Horizontal
7320.369	61.53	-0.82	60.71	74.00	-13.29	Pk	Horizontal
7320.369	44.47	-0.82	43.65	54.00	-10.35	AV	Horizontal
High Channel (2480MHz)- Above 1G							
4960.202	62.59	-3.59	59.00	74.00	-15.00	Pk	Vertical
4960.202	42.14	-3.59	38.55	54.00	-15.45	AV	Vertical
7440.135	61.02	-0.68	60.34	74.00	-13.66	Pk	Vertical
7440.135	46.66	-0.68	45.98	54.00	-8.02	AV	Vertical
4960.391	61.32	-3.59	57.73	74.00	-16.27	Pk	Horizontal
4960.391	40.09	-3.59	36.50	54.00	-17.50	AV	Horizontal
7440.248	60.93	-0.68	60.25	74.00	-13.75	Pk	Horizontal
7440.248	40.45	-0.68	39.77	54.00	-14.23	AV	Horizontal

**Remark:**

Absolute Level= ReadingLevel+ Factor, Margin= Absolute Level - Limit

Radiated band edge:

Frequency (MHz)	Meter Reading (dB $\mu$ V)	Factor (dB)	Emission Level (dB $\mu$ V/m)	Limits (dB $\mu$ V/m)	Margin (dB)	Detector Type	Comment
2390	59.61	-13.06	46.55	74	-27.45	peak	Vertical
2390	58.75	-13.06	45.69	74	-28.31	peak	Horizontal
2483.5	60.32	-12.78	47.54	74	-26.46	peak	Vertical
2483.5	59.84	-12.78	47.06	74	-26.94	peak	Horizontal

Note: Absolute Level= ReadingLevel+ Factor, Margin= Absolute Level - Limit

#### 4. POWER SPECTRAL DENSITY TEST

##### 4.1 APPLIED PROCEDURES / LIMIT

FCC Part15 (15.247) , Subpart C				
Section	Test Item	Limit	Frequency Range (MHz)	Result
15.247	Power Spectral Density	8 dBm (in any 3KHz)	2400-2483.5	PASS

##### 4.1.1 TEST PROCEDURE

1. Set analyzer center frequency to DTS channel center frequency.
2. Set the span to 1.5 times the DTS channel bandwidth.
3. 3 kHz ≤ Set the RBW ≤ 100 kHz.
4. Set the VBW ≥ 3 x RBW.
5. Detector = peak.
6. Sweep time = auto couple.
7. Trace mode = max hold.
8. Allow trace to fully stabilize.
9. Use the peak marker function to determine the maximum amplitude level within the RBW.
10. If measured value exceeds limit, reduce RBW (no less than 3 kHz) and repeat.

##### 4.1.2 DEVIATION FROM STANDARD

No deviation.

##### 4.1.3 TEST SETUP

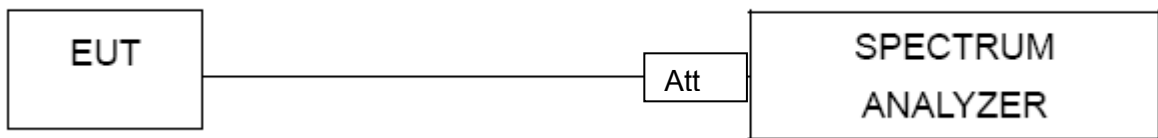

##### 4.1.4 EUT OPERATION CONDITIONS

The EUT tested system was configured as the statements of 2.1 Unless otherwise a special operating condition is specified in the follows during the testing.



### 4.1.5 TEST RESULTS

EUT :	Smartphone	Model Name :	GLB-MOB55
Temperature :	25 °C	Relative Humidity :	56%
Pressure :	1015 hPa	Test Voltage :	DC 3.8V
Test Mode :	TX Mode /CH00, CH19, CH39		

Frequency	Power Density (dBm/3KHz)	Limit (dBm/3KHz)	Result
2402 MHz	-21.54	8	PASS
2440 MHz	-21.29	8	PASS
2480 MHz	-21.99	8	PASS

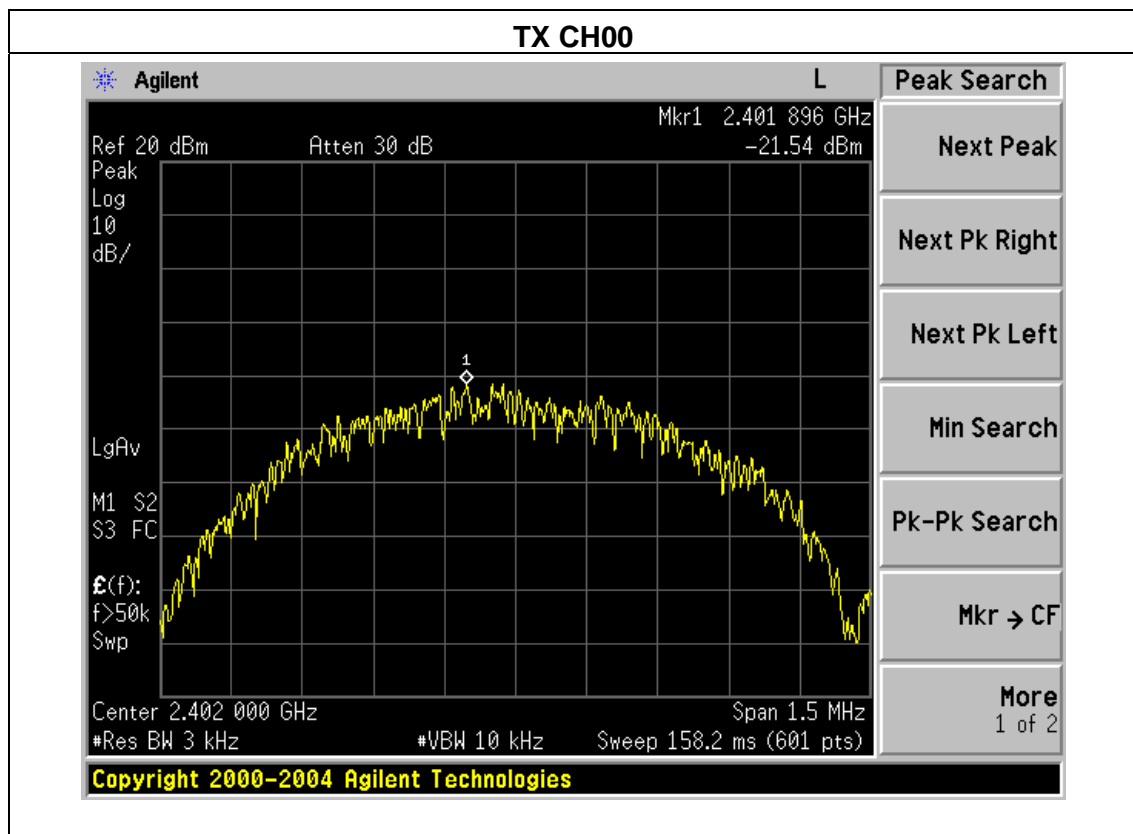

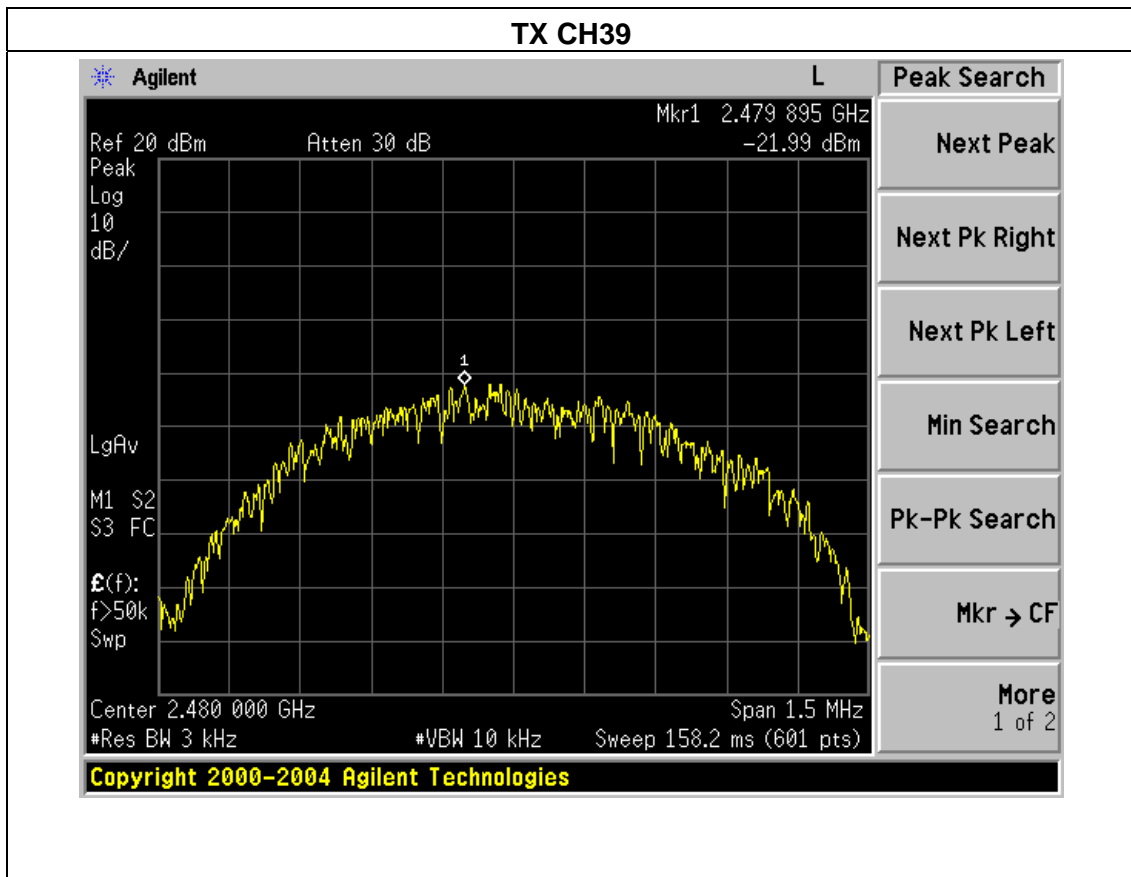
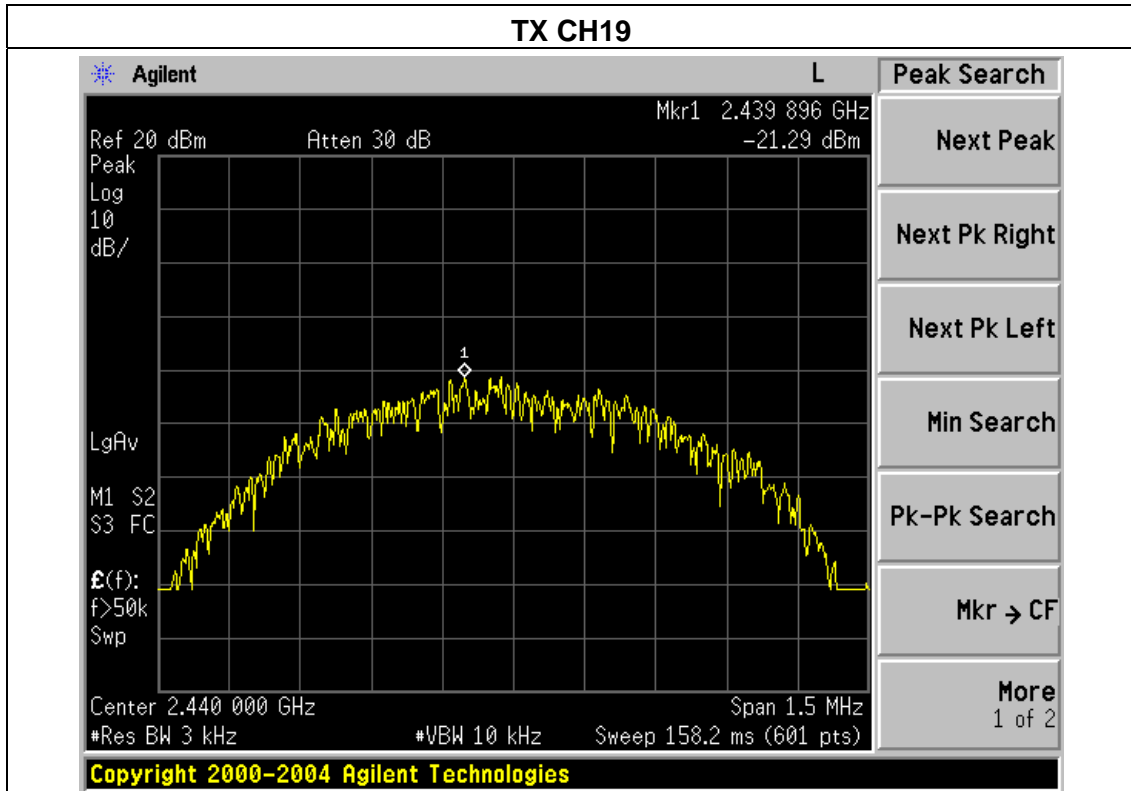

**5. BANDWIDTH TEST**

**5.1 APPLIED PROCEDURES / LIMIT**

FCC Part15 (15.247) , Subpart C				
Section	Test Item	Limit	Frequency Range (MHz)	Result
15.247(a)(2)	Bandwidth	$\geq 500\text{KHz}$ (6dB bandwidth)	2400-2483.5	PASS

**5.1.1 TEST PROCEDURE**

1. Set RBW = 100 kHz.
2. Set the video bandwidth (VBW)  $\geq 3 \times$  RBW.
3. Detector = Peak.
4. Trace mode = max hold.
5. Sweep = auto couple.
6. Allow the trace to stabilize.
7. Measure the maximum width of the emission that is constrained by the frequencies associated with the two outermost amplitude points (upper and lower) that are attenuated by 6 dB relative to the maximum level measured in the fundamental emission.

**TEST SETUP**

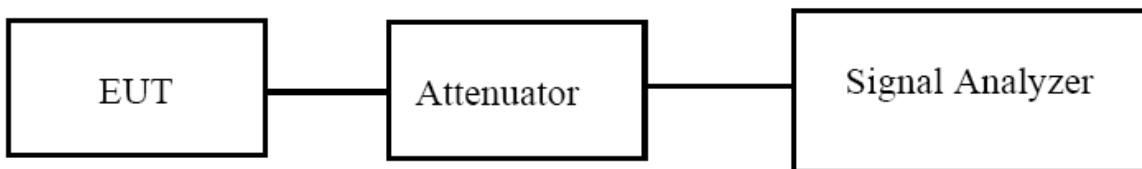

**5.1.2 EUT OPERATION CONDITIONS**

The EUT tested system was configured as the statements of 2.4 Unless otherwise a special operating condition is specified in the follows during the testing.

### 5.1.3 TEST RESULTS

EUT :	Smartphone	Model Name :	GLB-MOB55
Temperature :	25 °C	Relative Humidity :	56%
Pressure :	1012 hPa	Test Voltage :	DC 3.8V
Test Mode :	TX Mode /CH00, CH19, CH39		

Channel	Frequency (MHz)	6dB bandwidth (kHz)	Limit (kHz)	Result
Low	2402	670.719	500	Pass
Middle	2440	671.020	500	Pass
High	2480	669.905	500	Pass

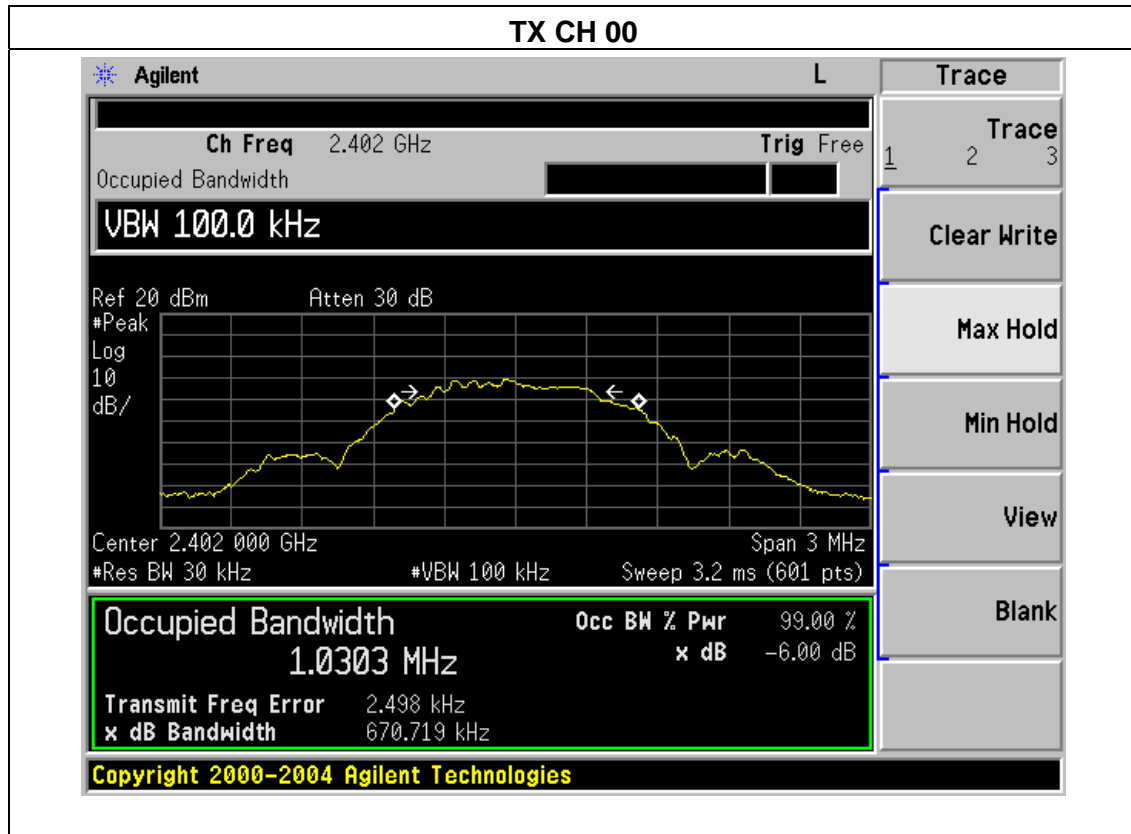

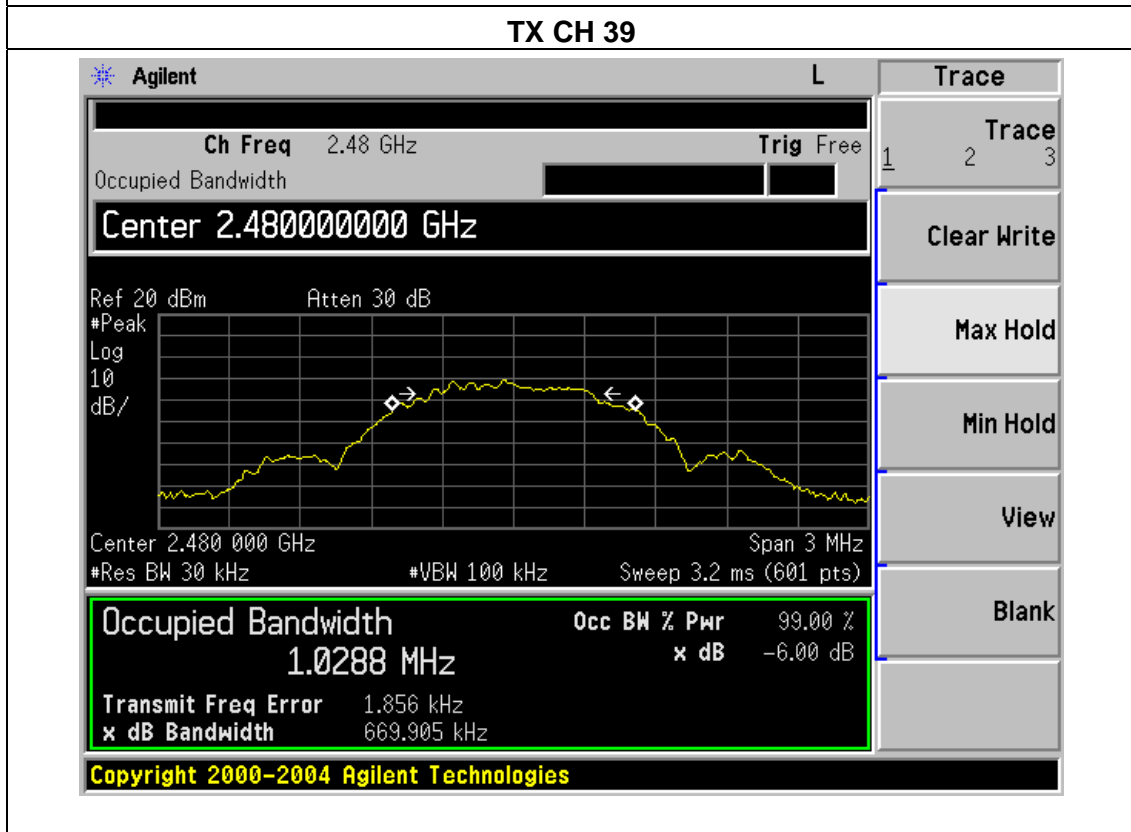
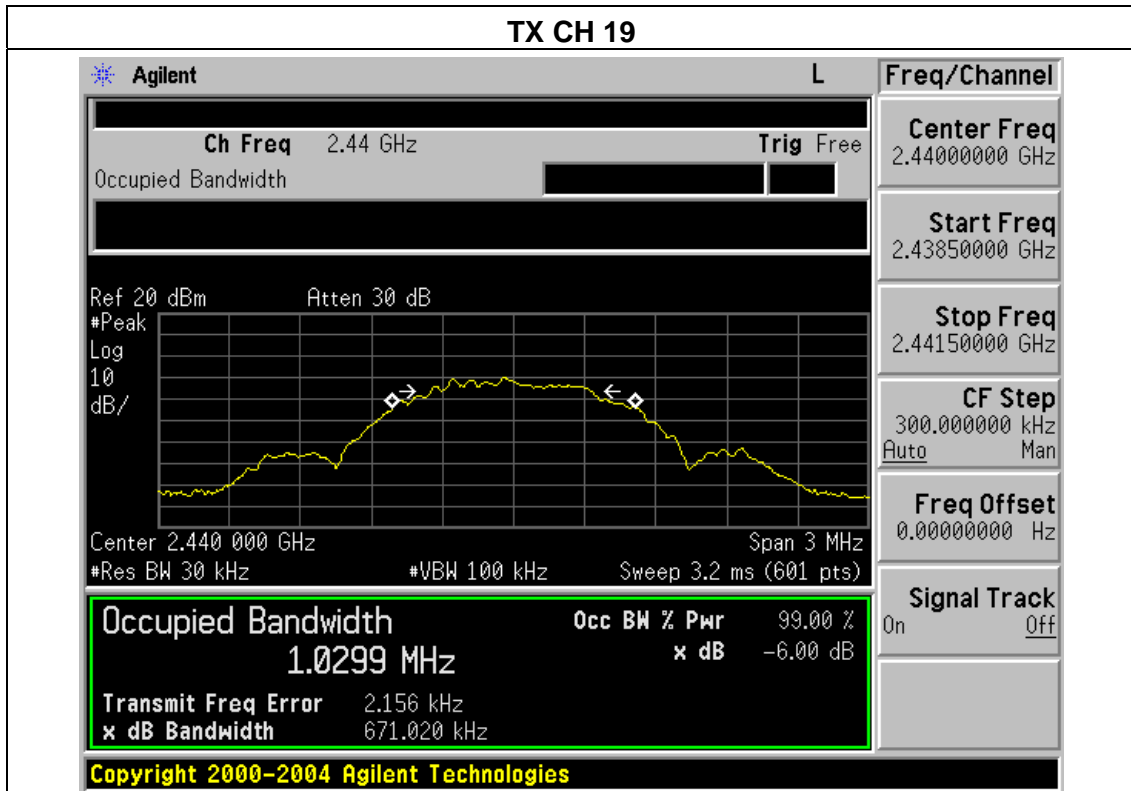

**6. PEAK OUTPUT POWER TEST**

**6.1 APPLIED PROCEDURES / LIMIT**

FCC Part15 (15.247) , Subpart C				
Section	Test Item	Limit	Frequency Range (MHz)	Result
15.247(b)(3)	Peak Output Power	1 watt or 30dBm	2400-2483.5	PASS

**6.1.1 TEST PROCEDURE**

- a. The EUT was directly connected to the Power meter

**6.1.2 DEVIATION FROM STANDARD**

No deviation.

**6.1.3 TEST SETUP**



**6.1.4 EUT OPERATION CONDITIONS**

The EUT tested system was configured as the statements of 2.4 Unless otherwise a special operating condition is specified in the follows during the testing.

**6.1.5 TEST RESULTS**

EUT :	Smartphone	Model Name :	GLB-MOB55
Temperature :	25 °C	Relative Humidity :	60%
Pressure :	1012 hPa	Test Voltage :	DC 3.8V
Test Mode :	TX Mode		

Test Channe	Frequency	Maximum Conducted Output Power(PK)	LIMIT
	(MHz)	(dBm)	dBm
CH00	2402	-4.41	30
CH19	2440	-4.64	30
CH39	2480	-4.13	30

**7. 100 KHZ BANDWIDTH OF FREQUENCY BAND EDGE**

**APPLICABLE STANDARD**

In any 100 kHz bandwidth outside the frequency band in which the spread spectrum or digitally modulated intentional radiator is operating, the radio frequency power that is produced by the intentional radiator shall be at least 20 dB below that in the 100 kHz bandwidth within the band that contains the highest level of the desired power, based on either an RF conducted or a radiated measurement, provided the transmitter demonstrates compliance with the peak conducted power limits. If the transmitter complies with the conducted power limits based on the use of RMS averaging over a time interval, as permitted under paragraph (b)(3) of this section, the attenuation required under this paragraph shall be 30 dB instead of 20 dB. Attenuation below the general limits specified in §15.209(a) is not required. In addition, radiated emissions which fall in the restricted bands, as defined in §15.205(a), must also comply with the radiated emission limits specified in §15.209(a) (see §15.205(c)).

**TEST PROCEDURE**

- a) Check the calibration of the measuring instrument using either an internal calibrator or a known signal from an external generator.
- b) Position the EUT without connection to measurement instrument. Turn on the EUT and connect its antenna terminal to measurement instrument via a low loss cable. Then set it to any one measured frequency within its operating range, and make sure the instrument is operated in its linear range.
- c) Set RBW to 100 kHz and VBW of spectrum analyzer to 300 kHz with a convenient frequency span including 100 kHz bandwidth from band edge.
- d) Measure the highest amplitude appearing on spectral display and set it as a reference level. Plot the graph with marking the highest point and edge frequency.
- e) Repeat above procedures until all measured frequencies were complete.

**7.1 DEVIATION FROM STANDARD**

No deviation.

**7.2 TEST SETUP**

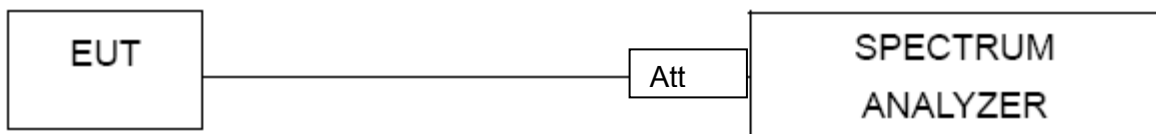

**7.3 EUT OPERATION CONDITIONS**

The EUT tested system was configured as the statements of 2.4 Unless otherwise a special operating condition is specified in the follows during the testing.



**7.4 TEST RESULTS**

EUT :	Smartphone	Model Name :	GLB-MOB55
Temperature :	25 °C	Relative Humidity :	56%
Pressure :	1012 hPa	Test Voltage :	DC 3.8V

Frequency Band	Delta Peak to band emission (dBc)	> Limit (dBc)	Result
Left-band	54.65	20	Pass
Right-band	54.80	20	Pass

Left Side

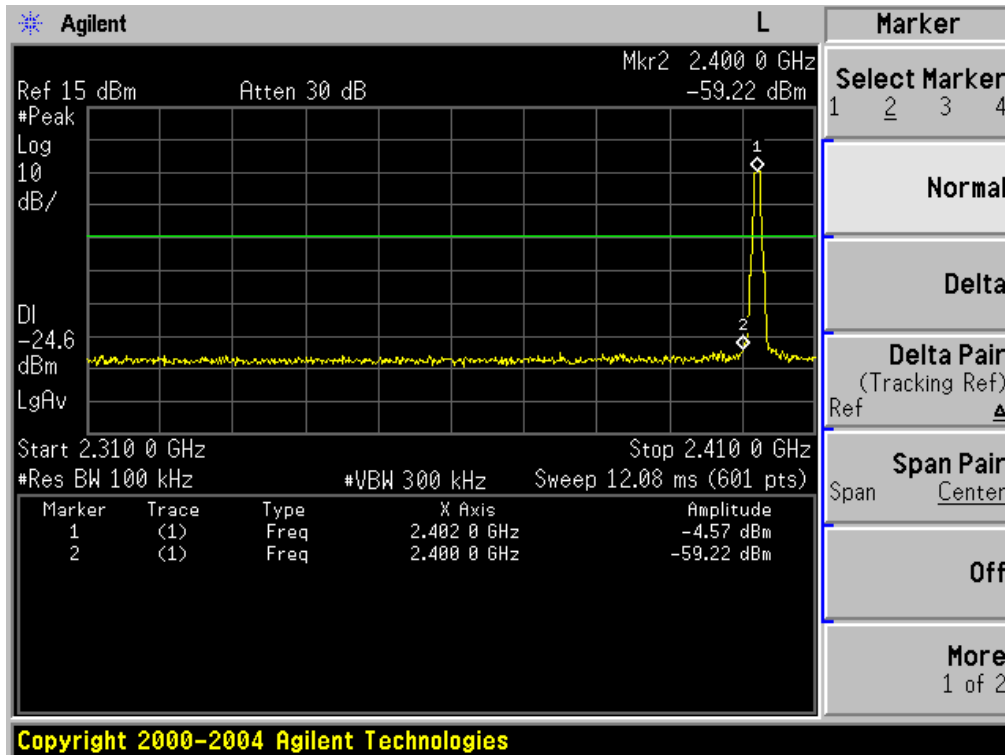

Right Side

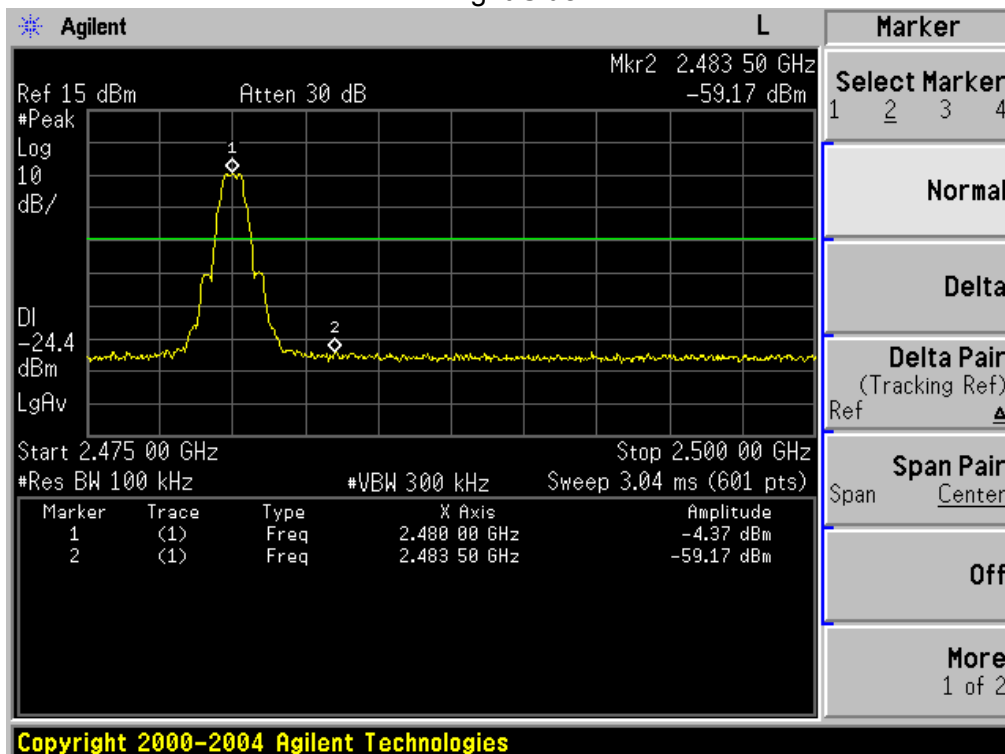

## **8. ANTENNA REQUIREMENT**

### **8.1 STANDARD REQUIREMENT**

15.203 requirement: For intentional device, according to 15.203: an intentional radiator shall be designed to ensure that no antenna other than that furnished by the responsible party shall be used with the device.

### **8.2 EUT ANTENNA**

The EUT antenna is permanent attached antenna. It comply with the standard requirement.

**9. EUT TEST PHOTO**

**Radiated Measurement Photos**

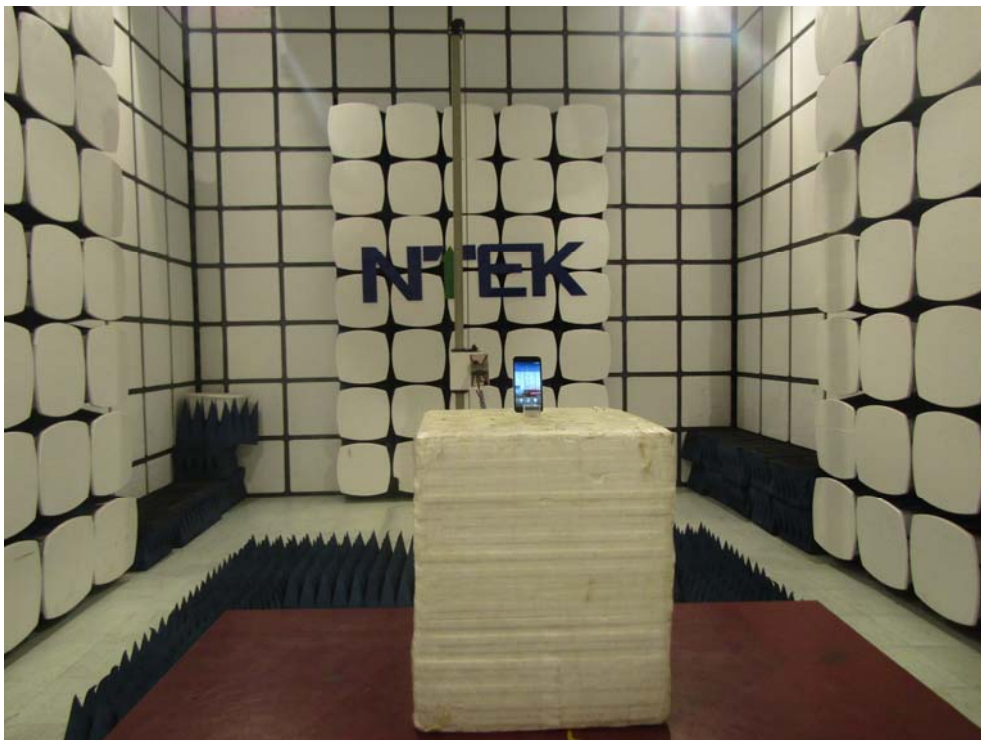
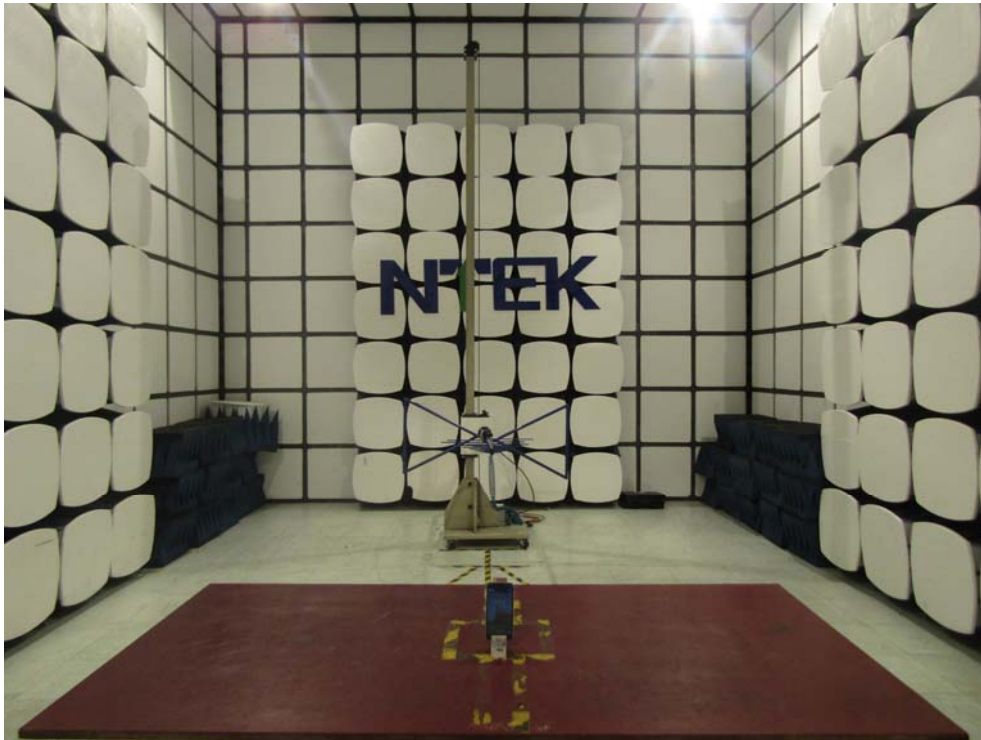

**Conducted Measurement Photos**

