

Nemko-CCL, Inc.
1940 West Alexander Street
Salt Lake City, UT 84119
801-972-6146

Test Report

Certification

Test Of: iTOVi Tracker

FCC ID: 2AGL3-TOV20021

Test Specifications:

FCC PART 15, Subpart C

Test Report Serial No: 298117-3.4

Applicant:
iTOVi LLC
660 S 2350 N
Lehi, UT 84043
U.S.A

Date of Test: November 16, 2015

Report Issue Date: November 19, 2015

Accredited Testing Laboratory By:



NVLAP Lab Code 100272-0

CERTIFICATION OF ENGINEERING REPORT

This report has been prepared by Nemko-CCL, Inc. to document compliance of the device described below with the requirements of Federal Communications Commission (FCC) Part 15, Subpart C. This report may be reproduced in full, partial reproduction may only be made with the written consent of the laboratory. The results in this report apply only to the sample tested.

- Applicant: iTOVi LLC
- Manufacturer: iTOVi LLC
- Brand Name: iTOVi
- Model Number: iTOVi Tracker
- FCC ID: 2AGL3-TOV20021

On this 19th day of November 2015, I, individually and for Nemko-CCL, Inc., certify that the statements made in this engineering report are true, complete, and correct to the best of my knowledge, and are made in good faith.

Although NVLAP has recognized that the Nemko-CCL, Inc. EMC testing facilities are in good standing, this report must not be used to claim product certification, approval, or endorsement by NVLAP, NIST, or any agency of the federal government.

Nemko-CCL, Inc.



Tested by: Norman P. Hansen
Test Technician

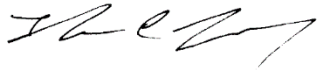

Reviewed by: Thomas C. Jackson
Certification Manager

TABLE OF CONTENTS

	PAGE
<u>SECTION 1.0 CLIENT INFORMATION</u>	5
<u>SECTION 2.0 EQUIPMENT UNDER TEST (EUT)</u>	6
<u>SECTION 3.0 TEST SPECIFICATION, METHODS & PROCEDURES</u>	8
<u>SECTION 4.0 OPERATION OF EUT DURING TESTING</u>	14
<u>SECTION 5.0 SUMMARY OF TEST RESULTS</u>	15
<u>SECTION 6.0 MEASUREMENTS AND RESULTS</u>	16
<u>APPENDIX 1 TEST PROCEDURES AND TEST EQUIPMENT</u>	34
<u>APPENDIX 2 PHOTOGRAPHS</u>	38

Revision History		
Revision	Description	Date
1	Original Report Release	November 19, 2015
2	Completed the spurious emission table	January 22, 2016
3	Correction of Manufacturer name Add conducted power statement	February 18, 2016
4	Page 36 statement added for 1.5m table height above 1GHz	February 19, 2016

SECTION 1.0 CLIENT INFORMATION

1.1 Applicant:

Company Name: iTOVi LLC
660 W 2350 N
Lehi, UT 84043
U.S.A

Contact Name: Mike Wadman
Title: Partner

1.2 Manufacturer:

Company Name: iTOVi LLC
660 W 2350 N
Lehi, UT 84043
U.S.A

Contact Name: Mike Wadman
Title: Partner

SECTION 2.0 EQUIPMENT UNDER TEST (EUT)**2.1 Identification of EUT:**

Brand Name:	iTOVi
Model Number:	iTOVi Tracker
Serial Number:	None
Hardware Version:	1.7
Dimensions:	7.5 cm x 3.2 cm 3.0 cm
Country of Manufacture:	U.S.A

2.2 Description of EUT:

The iTOVi Tracker is an ohmmeter measurement tool used to take resistance measurements of the skin. A mini USB port is provided for charging the battery. A HNFL050100UU 5 VDC power supply is used to recharge the battery. The iTOVi Tracker has a Bluetooth LE transceiver for communication that uses 40 channels from 2402 MHz to 2480 MHz, spaced 2 MHz apart. The Bluetooth LE transceiver uses a Johanson Technology 2450AT18A100E chip antenna with a maximum gain of 0.5 dB.

This report covers the circuitry of the devices subject to FCC Part 15, Subpart C. The circuitry of the device subject to FCC Subpart B was found to be compliant and is covered in Nemko-CCL, Inc. report 298117-2.

2.3 EUT and Support Equipment:

The FCC ID numbers for all the EUT and support equipment used during the test are listed below:

Brand Name Model Number Serial Number	FCC ID Number or Compliance	Description	Name of Interface Ports / Interface Cables
BN: iTOVi MN: iTOVi Tracker SN: None	2AGL3- TOV20021	Personal measurement device	See Section 2.4

2.4 Interface Ports on EUT:

Name of Ports	No. of Ports Fitted to EUT	Cable Descriptions/Length
Mini USB	1	Mini USB to USB A cable with manufacturer installed ferrite/46 cm

2.5 Modification Incorporated/Special Accessories on EUT:

There were no modifications or special accessories required to comply with the specification.

SECTION 3.0 TEST SPECIFICATION, METHODS & PROCEDURES

3.1 Test Specification:

Title: FCC PART 15, Subpart C (47 CFR 15)
15.203, 15.207, and 15.247

Limits and methods of measurement of radio interference characteristics of radio frequency devices.

Purpose of Test: The tests were performed to demonstrate initial compliance.

3.2 Methods & Procedures:

3.2.1 §15.203 Antenna Requirement

An intentional radiator shall be designed to ensure that no antenna other than that furnished by the responsible party shall be used with the device. The use of a permanently attached antenna or of an antenna that uses a unique coupling to the intentional radiator shall be considered sufficient to comply with the provisions of this Section. The manufacturer may design the unit so that a broken antenna can be replaced by the user, but the use of a standard antenna jack or electrical connector is prohibited. This requirement does not apply to carrier current devices or to devices operated under the provisions of Sections 15.211, 15.213, 15.217, 15.219, or 15.221. Further, this requirement does not apply to intentional radiators that must be professionally installed, such as perimeter protection systems and some field disturbance sensors, or to other intentional radiators which, in accordance with Section 15.31(d), must be measured at the installation site. However, the installer shall be responsible for ensuring that the proper antenna is employed so that the limits in this Part are not exceeded.

3.2.2 §15.207 Conducted Limits

(a) Except for Class A digital devices, for equipment that is designed to be connected to the public utility (AC) power line, the radio frequency voltage that is conducted back onto the AC power line on any frequency or frequencies within the band 150 kHz to 30 MHz shall not exceed the limits in the following table, as measured using a 50 μ H/50 ohms line impedance stabilization network (LISN). Compliance with the provisions of this paragraph shall be based on the measurement of the radio frequency voltage between each power line and ground at the power terminal. The lower limit applies at the band edges.

Frequency of Emission (MHz)	Conducted Limit (dB μ V)	
	Quasi-peak	Average
0.15 – 0.5*	66 to 56*	56 to 46*
0.5 – 5	56	46
5 - 30	60	50

*Decreases with the logarithm of the frequency.

3.2.3 §15.247 Operation within the bands 902 – 928 MHz, 2400 – 2483.5 MHz, and 5725 – 5850 MHz

(a) Operation under the provisions of this Section is limited to frequency hopping and digitally modulated intentional radiators that comply with the following provisions:

(1) Frequency hopping systems shall have hopping channel carrier frequencies separated by a minimum of 25 kHz or the 20 dB bandwidth of the hopping channel, whichever is greater. Alternatively, frequency hopping systems operating in the 2400 – 2483.5 MHz band may have hopping channel carrier frequencies that are separated by 25 kHz or two-thirds of the 20 dB bandwidth of the hopping channel, whichever is greater, provided the systems operate with an output power no greater than 125 mW. The system shall hop to channel frequencies that are selected at the system hopping rate from a pseudorandomly ordered list of hopping frequencies. Each frequency must be used equally on the average by each transmitter. The system receivers shall have input bandwidths that match the hopping channel bandwidths of their corresponding transmitters and shall shift frequencies in synchronization with the transmitted signals.

(i) For frequency hopping systems operating in the 902-928 MHz band: if the 20 dB bandwidth of the hopping channel is less than 250 kHz, the system shall use at least 50 hopping frequencies and the average time of occupancy on any frequency shall not be greater than 0.4 seconds within a 20 second period; if the 20 dB bandwidth of the hopping channel is 250 kHz or greater, the system shall use at least 25 hopping frequencies and the average time of occupancy on any frequency shall not be greater than 0.4 seconds within a 10 second period. The maximum allowed 20 dB bandwidth of the hopping channel is 500 kHz.

(ii) Frequency hopping systems operating in the 5725-5850 MHz band shall use at least 75 hopping frequencies. The maximum 20 dB bandwidth of the hopping channel is 1 MHz. The average time of occupancy on any frequency shall not be greater than 0.4 seconds within a 30 second period.

(iii) Frequency hopping systems in the 2400-2483.5 MHz band shall use at least 15 non-overlapping channels. The average time of occupancy on any channel shall not be greater than 0.4 seconds within a period of 0.4 seconds multiplied by the number of hopping channels employed. Frequency hopping systems may avoid or suppress transmissions on a particular hopping frequency provided that a minimum of 15 non-overlapping channels are used.

(2) Systems using digital modulation techniques may operate in the 902 - 928 MHz, 2400 - 2483.5 MHz, and 5725 - 5850 MHz bands. The minimum 6 dB bandwidth shall be at least 500 kHz.

(b) The maximum peak output power of the intentional radiator shall not exceed the following:

(1) For frequency hopping systems operating in the 2400-2483.5 MHz band employing at least 75 non-overlapping hopping channels, and all frequency hopping systems in the 5725-5850 MHz band: 1 watt. For all other frequency hopping systems in the 2400-2483.5 MHz band: 0.125 watts.

(2) For frequency hopping systems operating in the 902-928 MHz band: 1 watt for systems employing at least 50 hopping channels; and, 0.25 watts for systems employing less than 50 hopping channels, but at least 25 hopping channels, as permitted under paragraph (a)(1)(i) of this section.

(3) For systems using digital modulation in the 902-928 MHz, 2400-2483.5 MHz, and 5725 – 5850 MHz bands: 1 watt. As an alternative to a peak power measurement, compliance with the Conducted Output Power is defined as the total transmit power delivered to all antennas and antenna elements averaged across all symbols in the signaling alphabet when the transmitter is operating at its maximum power control level. Power must be summed across all antennas and antenna elements. The average must not include any time intervals during which the transmitter is off or is transmitting at a reduced power level. If multiple modes of operation are possible (e.g., alternative modulation methods), the maximum conducted output power is the highest total transmit power occurring in any mode.

(4) The conducted output power limit specified in paragraph (b) of this section is based on the use of antennas with directional gains that do not exceed 6 dBi. Except as shown in paragraph (c) of this section, if transmitting antennas of directional gain greater than 6 dBi are used, the conducted power from the intentional radiator shall be reduced below the stated values in paragraphs (b)(1), (b)(2), and (b)(3) of this section, as appropriate, by the amount in dB that the directional gain of the antenna exceeds 6 dBi.

(c) Operation with directional antenna gains greater than 6 dBi.

(1) Fixed point-to-point operation:

(i) Systems operating in the 2400-2483.5 MHz band that are used exclusively for fixed, point-to-point operations may employ transmitting antennas with directional gain greater than 6 dBi provided the maximum peak output power of the intentional radiator is reduced by 1 dB for every 3 dB that the directional gain of the antenna exceeds 6 dBi.

(ii) Systems operating in the 5725-5850 MHz band that are used exclusively for fixed, point-to-point operations may employ transmitting antennas with directional gain greater than 6 dBi without any corresponding reduction in transmitter peak output power.

(iii) Fixed, point-to-point operation, as used in paragraphs (b)(4)(i) and (b)(4)(ii) of this section, excludes the use of point-to-multipoint systems, omnidirectional applications, and multiple co-located intentional radiators transmitting the same information. The operator of the spread spectrum or digitally modulated intentional radiator or, if the equipment is professionally installed, the installer is responsible for ensuring that the system is used exclusively for fixed, point-to-point operations. The instruction manual furnished with the intentional radiator shall contain language in the installation instructions informing the operator and the installer of this responsibility.

(2) In addition to the provisions in paragraphs (b)(1), (b)(3), (b)(4) and (c)(1)(i) of this section, transmitters operating in the 2400-2483.5 MHz band that emit multiple directional beams, simultaneously or sequentially, for the purpose of directing signals to individual receivers or to groups of receivers provided the emissions comply with the following:

(i) Different information must be transmitted to each receiver.

(ii) If the transmitter employs an antenna system that emits multiple directional beams but does not emit multiple directional beams simultaneously, the total output power conducted to the array or arrays that comprise the device, i.e., the sum of the power supplied to all antennas, antenna elements, staves, etc. and summed across all carriers or frequency channels, shall not exceed the limit specified in paragraph (b)(1) or (b)(3) of this section, as applicable. However, the total conducted output power shall be reduced by 1 dB below the specified limits for each 3 dB that the directional gain of the antenna /antenna array exceeds 6 dBi. The directional antenna gain shall be computed as follows:

(A) The directional gain shall be calculated as the sum of $10 \log$ (number of array elements or staves) plus the directional gain of the element or stave having the highest gain.

(B) A lower value for the directional gain than that calculated in paragraph (c)(2)(ii)(A) of this section will be accepted if sufficient evidence is presented, e.g., due to shading of the array or coherence loss in the beamforming.

(iii) If a transmitter employs an antenna that operates simultaneously on multiple directional beams using the same or different frequency channels, the power supplied to each emission beam is subject to the power limit specified in paragraph (c)(2)(ii) of this section. If transmitted beams overlap, the power shall

be reduced to ensure that their aggregate power does not exceed the limit specified in paragraph (c)(2)(ii) of this section. In addition, the aggregate power transmitted simultaneously on all beams shall not exceed the limit specified in paragraph (c)(2)(ii) of this section by more than 8 dB.

(iv) Transmitters that emit a single directional beam shall operate under the provisions of paragraph (c)(1) of this section.

(d) In any 100 kHz bandwidth outside the frequency band in which the spread spectrum or digitally modulated intentional radiator is operating, the radio frequency power that is produced by the intentional radiator shall be at least 20 dB below that in the 100 kHz bandwidth within the band that contains the highest level of the desired power, based on either an RF conducted or a radiated measurement, provided the transmitter demonstrates compliance with the peak conducted power limits. If the transmitter complies with the conducted power limits based on the use of RMS averaging over a time interval, as permitted under paragraph (b)(3) of this section, the attenuation required under this paragraph shall be 30 dB instead of 20 dB. Attenuation below the general limits specified in Section 15.209(a) is not required. In addition, radiated emissions which fall in the restricted bands, as defined in Section 15.205(a), must also comply with the radiated emission limits specified in Section 15.209(a) (see Section 15.205(c)).

(e) For digitally modulated systems, the power spectral density conducted from the intentional radiator to the antenna shall not be greater than 8 dBm in any 3 kHz band during any time interval of continuous transmission. This power spectral density shall be determined in accordance with the provisions of paragraph (b) of this section. The same method of determining the conducted output power shall be used to determine the power spectral density.

(f) For the purposes of this section, hybrid systems are those that employ a combination of both frequency hopping and digital modulation techniques. The frequency hopping operation of the hybrid system, with the direct sequence or digital modulation operation turned off, shall have an average time of occupancy on any frequency not to exceed 0.4 seconds within a time period in seconds equal to the number of hopping frequencies employed multiplied by 0.4. The digital modulation operation of the hybrid system, with the frequency hopping turned off, shall comply with the power density requirements of paragraph (d) of this section.

(g) Frequency hopping spread spectrum systems are not required to employ all available hopping channels during each transmission. However, the system, consisting of both the transmitter and the receiver, must be designed to comply with all of the regulations in this section should the transmitter be presented with a continuous data (or information) stream. In addition, a system employing short transmission bursts must comply with the definition of a frequency hopping system and must distribute its transmissions over the minimum number of hopping channels specified in this section.

(h) The incorporation of intelligence within a frequency hopping spread spectrum system that permits the system to recognize other users within the spectrum band so that it individually and independently chooses and adapts its hopsets to avoid hopping on occupied channels is permitted. The coordination of frequency hopping systems in any other manner for the express

purpose of avoiding the simultaneous occupancy of individual hopping frequencies by multiple transmitters is not permitted.

(i) Systems operating under the provisions of this section shall be operated in a manner that ensures that the public is not exposed to radio frequency energy levels in excess of the Commission's guidelines. See § 1.1307(b)(1) of this Chapter.

Note: Spread spectrum systems are sharing these bands on a noninterference basis with systems supporting critical Government requirements that have been allocated the usage of these bands, secondary only to ISM equipment operated under the provisions of Part 18 of this Chapter. Many of these Government systems are airborne radiolocation systems that emit a high EIRP which can cause interference to other users. Also, investigations of the effect of spread spectrum interference to U. S. Government operations in the 902-928 MHz band may require a future decrease in the power limits allowed for spread spectrum operation.

3.3 Test Procedure

The testing was performed according to the procedures in ANSI C63.10:2013. Testing was performed at the Nemko-CCL, Inc. Wanship open area test site #2, located at 29145 Old Lincoln Highway, Wanship, UT. This site has been registered with the FCC, and was renewed January 22, 2015 (90504). This registration is valid for three years.

Nemko-CCL, Inc. is accredited by National Voluntary Laboratory Accreditation Program (NVLAP); NVLAP Lab Code: 100272-0, which is effective until September 30, 2016.

SECTION 4.0 OPERATION OF EUT DURING TESTING

4.1 Operating Environment:

Power Supply: 120 VAC 60 Hz to Charger or 3.7 VDC from 401215 lithium polymer battery

4.2 Operating Modes:

The EUT was tested on 3 orthogonal axes and while in a constant transmit mode at the upper, middle, or lower channels. The maximum data rate showed the worst-case emission and was used in testing. The EUT was tested as a stand-alone device and when connected to the AC mains charging the battery. The worst-case emissions were seen with the EUT placed flat on the table as a stand-alone device. A fully charged battery was used in testing.

4.3 EUT Exercise Software:

iTOVi 0003 was used to exercise the EUT.

SECTION 5.0 SUMMARY OF TEST RESULTS**5.1 FCC Part 15, Subpart C**

The iTOVi Tracker transceiver was subjected to each of the tests shown in the summary table below.

5.1.1 Summary of Tests:

Section	Environmental Phenomena	Frequency Range (MHz)	Result
15.203	Antenna Requirements	Structural requirement	Complied
15.207	Conducted Disturbance at Mains Ports	0.15 to 30	Complied
15.247(a)	Bandwidth Requirement	2400 – 2483.5	Complied
15.247(b)	Peak Output Power	2400 – 2483.5	Complied
15.247(c)	Spurious Emissions	0.009 - 25000	Complied
15.247(d)	Peak Power Spectral Density	2400 – 2483.5	Complied
15.247(e)	Reserved Paragraph	N/A	Not Applicable
15.247(f)	Hybrid System Requirements	2400 – 2483.5	Not Applicable
15.247(g)	Frequency Hopping Channel Usage	2400 – 2438.5	Not Applicable
15.247(h)	Frequency Hopping Intelligence	2400 – 2483.5	Not Applicable

5.2 Result

In the configuration tested, the transceiver complied with the requirements of the specification.

SECTION 6.0 MEASUREMENTS AND RESULTS**6.1 General Comments:**

This section contains the test results only. Details of the test methods used and a list of the test equipment used during the measurements can be found in Appendix 1 of this report.

6.2 Test Results**6.2.1 §15.203 Antenna Requirements**

The EUT uses a Johanson Technology 2450AT18A100E chip antenna that is soldered to the PCB and is not user replaceable.

RESULT

The EUT complied with the specification.

6.2.2 §15.207 Conducted Disturbance at the AC Mains Ports

Frequency (MHz)	AC Mains Lead	Detector	Measured Level (dB μ V)	Limit (dB μ V)	Margin (dB)
0.19	Hot Lead	Peak (Note 1)	49.2	54.1	-4.9
0.22	Hot Lead	Peak (Note 1)	45.1	52.9	-7.8
0.27	Hot Lead	Peak (Note 1)	39.9	51.2	-11.3
0.35	Hot Lead	Peak (Note 1)	39.3	48.9	-9.6
0.53	Hot Lead	Peak (Note 1)	33.1	46.0	-12.9
2.11	Hot Lead	Peak (Note 1)	31.8	46.0	-14.2
0.19	Neutral Lead	Peak (Note 1)	44.7	54.1	-9.4
0.36	Neutral Lead	Peak (Note 1)	40.8	48.7	-7.9
0.52	Neutral Lead	Peak (Note 1)	32.2	46.0	-13.8
0.63	Neutral Lead	Peak (Note 1)	32.7	46.0	-13.3
1.16	Neutral Lead	Peak (Note 1)	32.5	46.0	-13.5
2.11	Neutral Lead	Peak (Note 1)	31.4	46.0	-14.6

Frequency (MHz)	AC Mains Lead	Detector	Measured Level (dB μ V)	Limit (dB μ V)	Margin (dB)
Note 1: The reference detector used for the measurements was Quasi-Peak or Peak and the data was compared to the average limit; therefore, the EUT was deemed to meet both the average and quasi-peak limits.					
Note 2: The reference detector used for the measurements was quasi-peak and average and the data was compared to the respective limits.					

RESULT

In the configuration tested, the EUT complied with the specification by 4.9 dB.

6.2.3 §15.247(a)(2) Emission Bandwidth

Frequency (MHz)	Emission 6dB Bandwidth (kHz)
2402	686
2442	682
2480	662

RESULT

In the configuration tested, the 6 dB bandwidth was greater than 500 kHz; therefore, the EUT complied with the requirements of the specification (see spectrum analyzer plots below).

Lower Channel Bandwidth

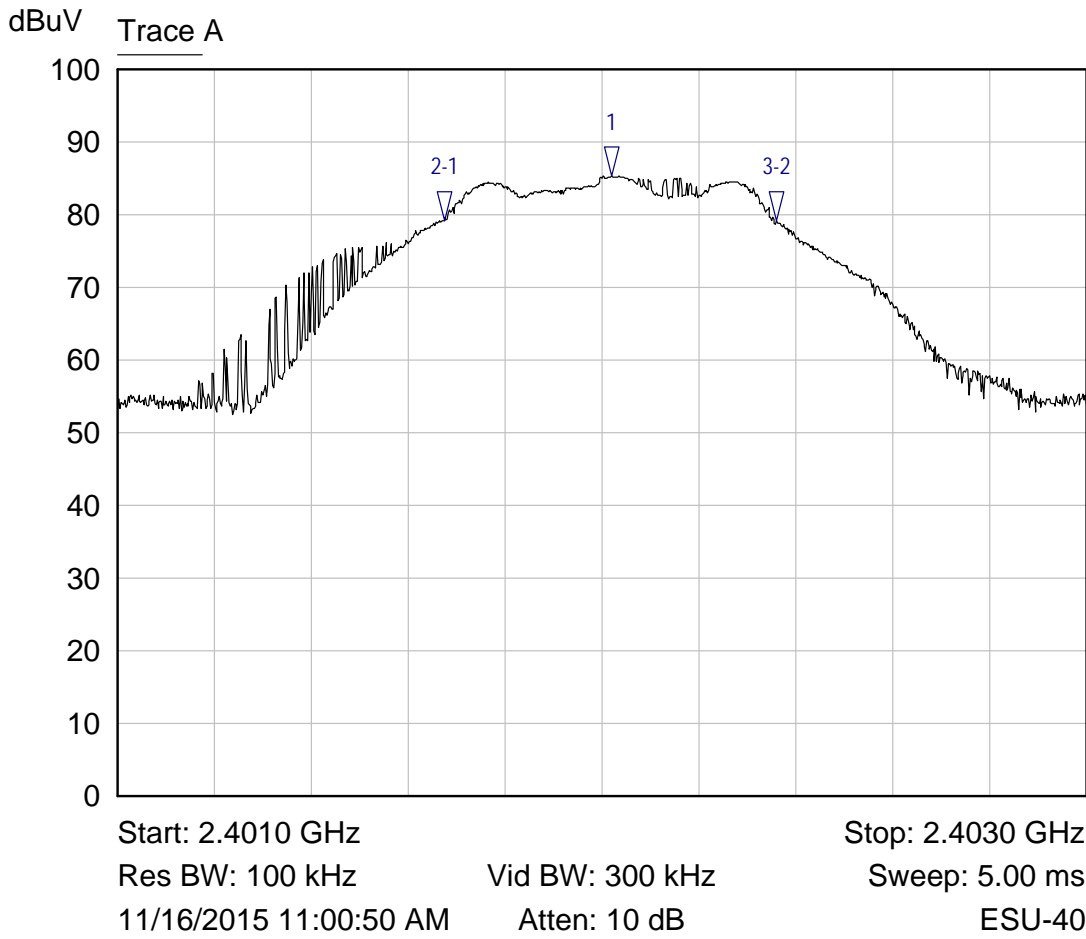

Mkr	Trace	X-Axis	Value	Notes
1 ▾	Trace A	2.4020 GHz	85.27 dBuV	
2-1 ▾	Trace A	-346.0000 kHz	-6.18 dB	
3-2 ▾	Trace A	686.0000 kHz	0.01 dB	

Middle Channel Bandwidth

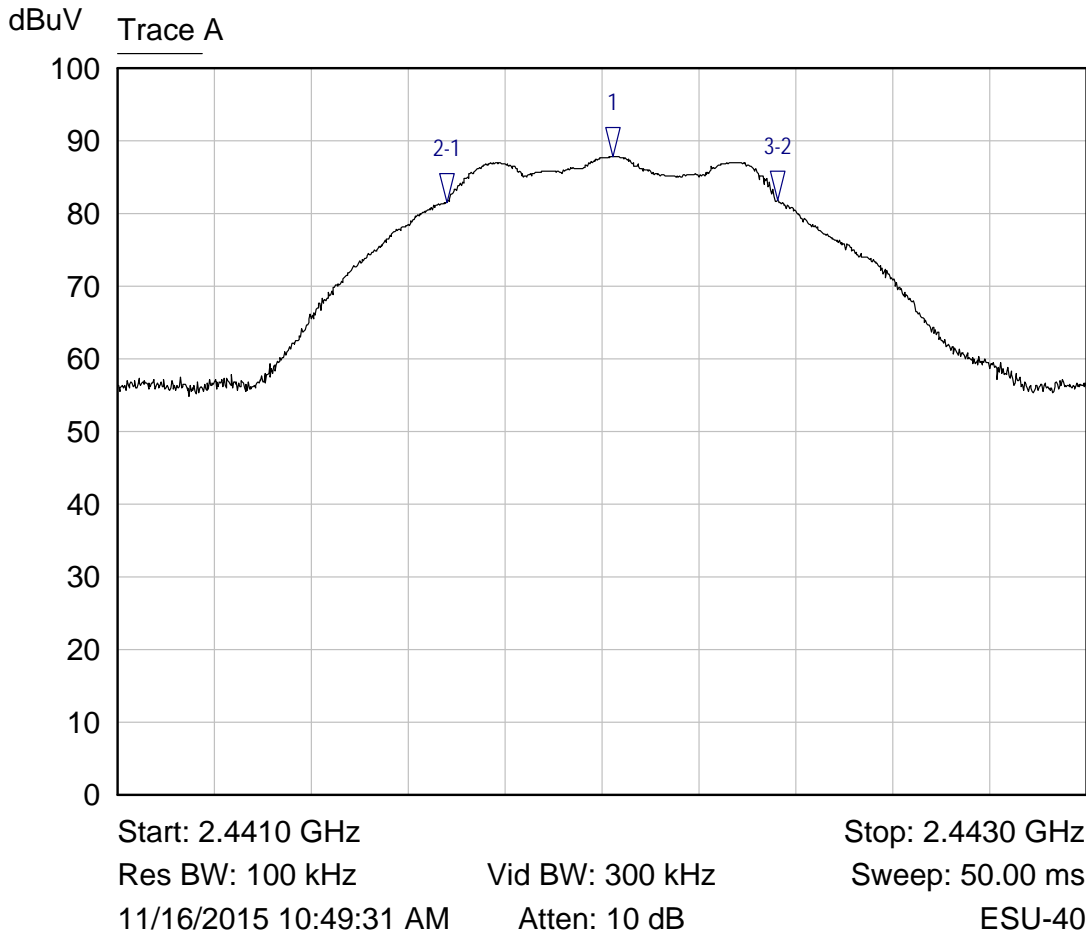

Mkr	Trace	X-Axis	Value	Notes
1 ▽	Trace A	2.4420 GHz	87.80 dBuV	
2-1 ▽	Trace A	-342.0000 kHz	-6.34 dB	
3-2 ▽	Trace A	682.0000 kHz	0.32 dB	

Upper Channel Bandwidth

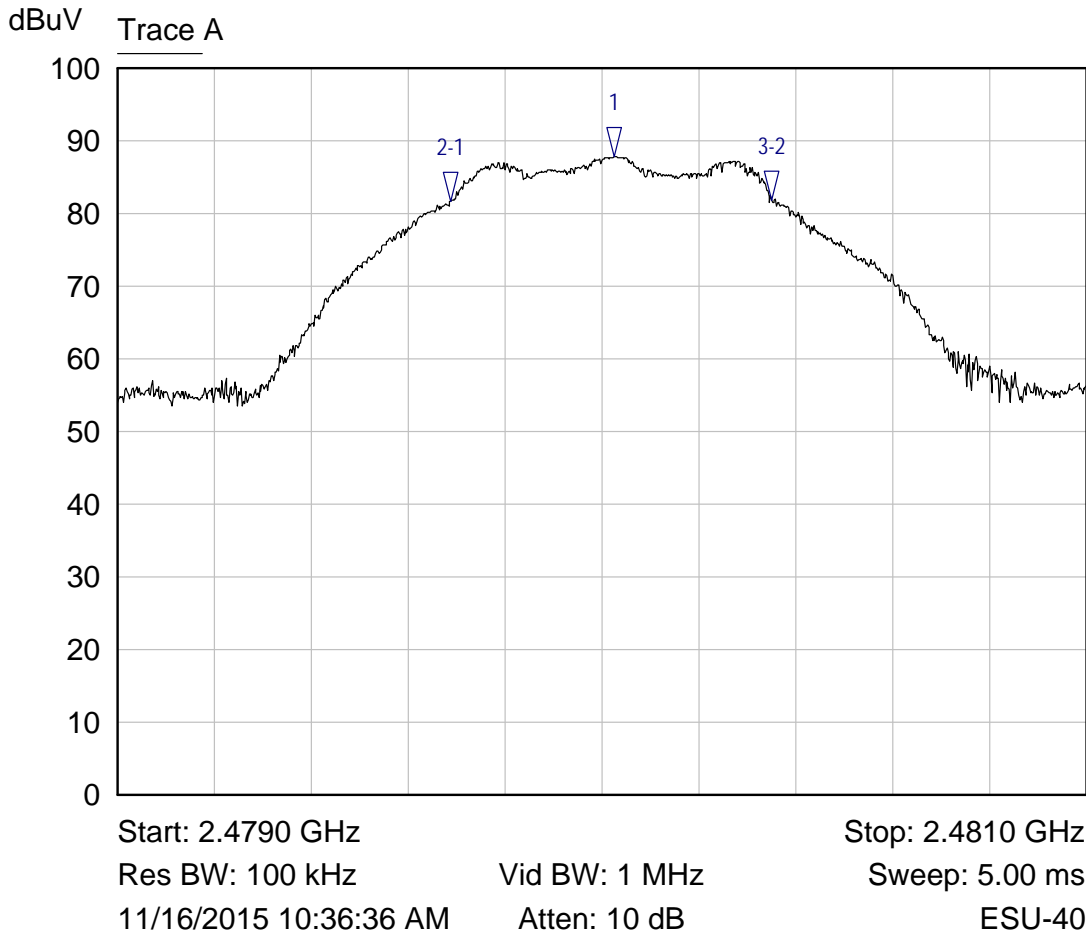

Mkr	Trace	X-Axis	Value	Notes
1 ▽	Trace A	2.4800 GHz	87.78 dBuV	
2-1 ▽	Trace A	-336.0000 kHz	-6.14 dB	
3-2 ▽	Trace A	662.0000 kHz	0.19 dB	

6.2.4 §15.247(b)(3) Peak Output Power

The FCC allows a maximum conducted power of 30 dBm to a 6 dBi antenna which is an EIRP limit of 36 dBm. The EUT uses a chip antenna with no provision for making a conducted measurement of the power so radiated methods were used. The radiated field strength measurements were converted to EIRP in dBm and compared to the limit of 36.0 dBm. The results are shown below.

Frequency (MHz)	Measured Field Strength at 3 meters (dB μ V/m)	EIRP (dBm)	EIRP Limit (dBm)
2402	85.8	-9.43	36.0
2442	88.3	-6.93	36.0
2480	88.5	-6.73	36.0

Calculated conducted output power -6.73 dBm EIRP – Antenna gain 0.5 dBi from Section 2.2 = -7.23 dBm.

RESULT

In the configuration tested, the peak EIRP was less than 36 dBm; therefore, the EUT complied with the requirements of the specification (see spectrum analyzer plots below).

Lower Channel

dBuV Trace A

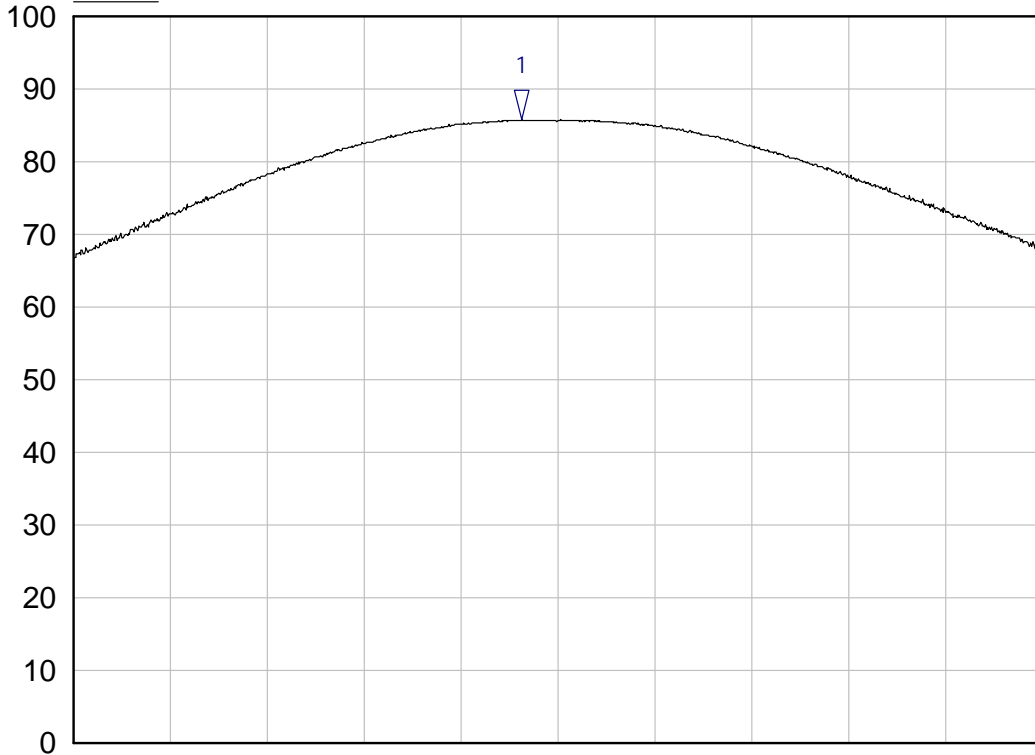

Start: 2.3975 GHz

Stop: 2.4065 GHz

Res BW: 3 MHz

Vid BW: 10 MHz

Sweep: 5.00 ms

11/16/2015 10:59:36 AM

Atten: 10 dB

ESU-40

Mkr	Trace	X-Axis	Value	Notes
1 ▽	Trace A	2.4017 GHz	85.75 dBuV	

Middle Channel

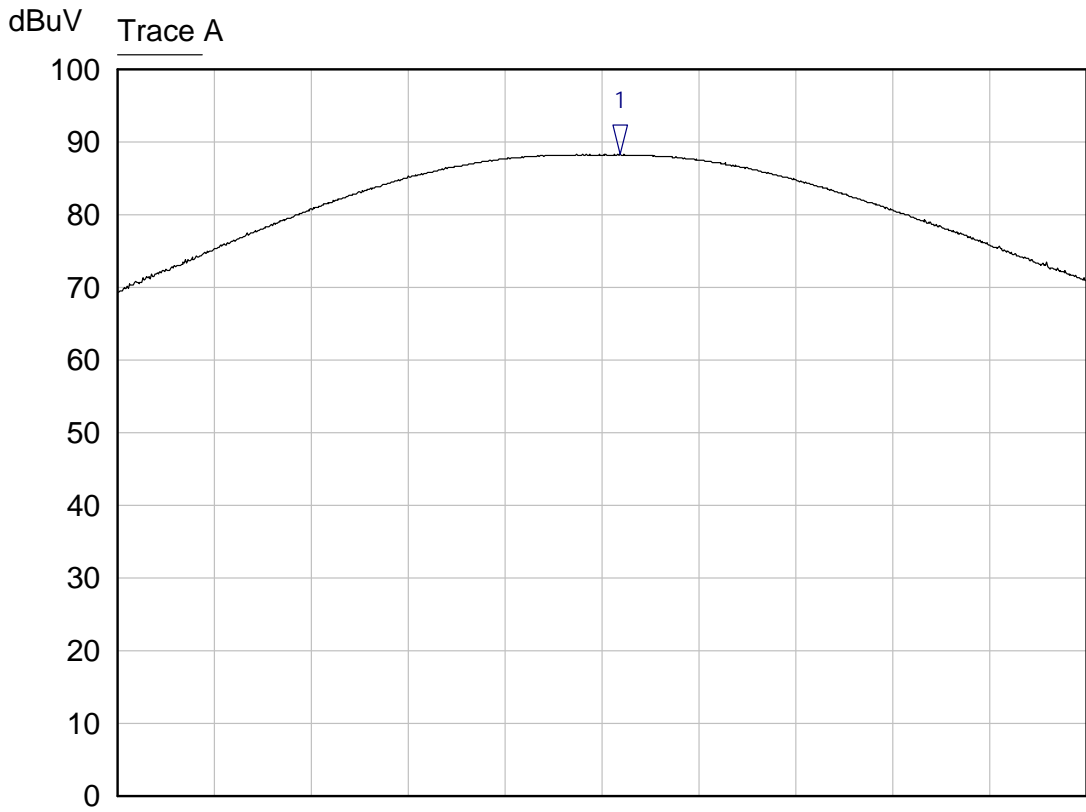

Start: 2.4375 GHz

Stop: 2.4465 GHz

Res BW: 3 MHz

Vid BW: 10 MHz

Sweep: 50.00 ms

11/16/2015 10:48:52 AM

Atten: 10 dB

ESU-40

Mkr	Trace	X-Axis	Value	Notes
1 ▽	Trace A	2.4422 GHz	88.28 dBuV	

Upper Channel

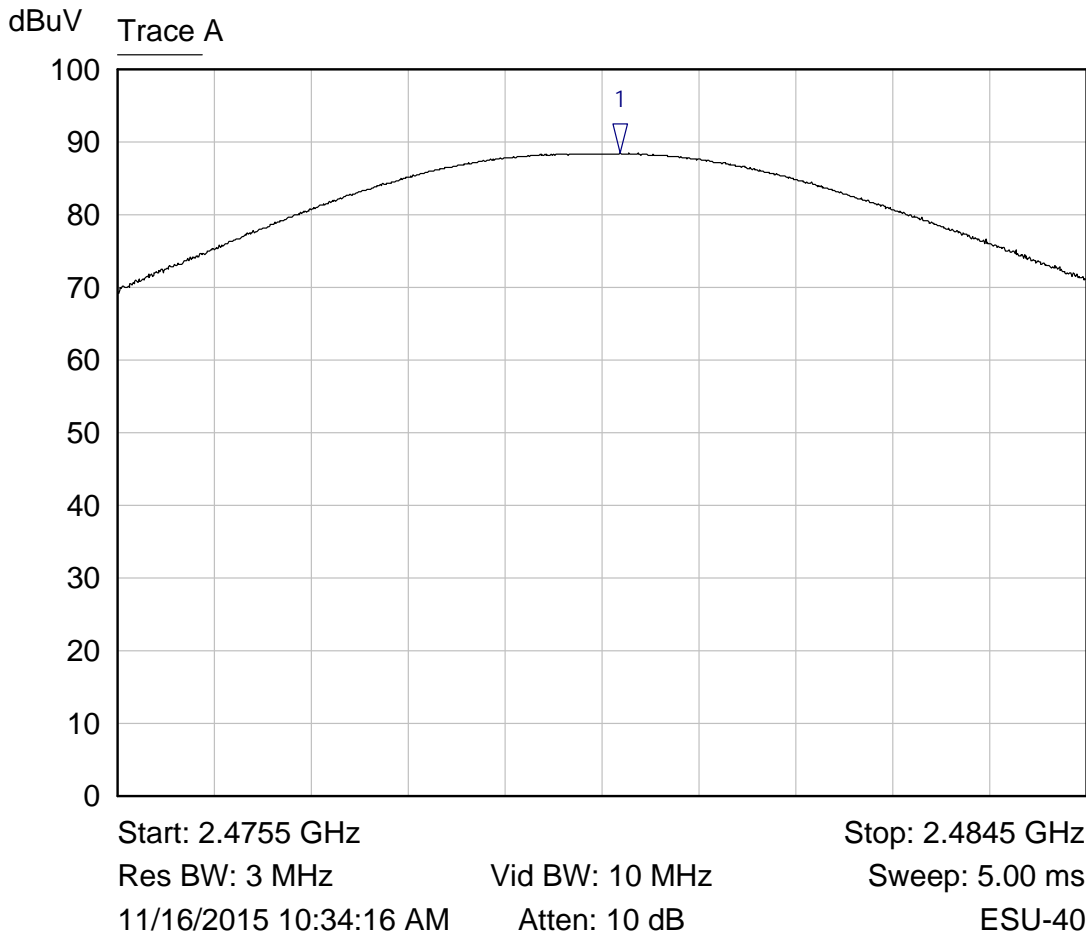

Mkr	Trace	X-Axis	Value	Notes
1 ▽	Trace A	2.4802 GHz	88.48 dBuV	

6.2.5 §15.247(c) Spurious Emissions

The frequency range from the lowest frequency generated or used in the device to the tenth harmonic of the highest fundamental emission was investigated to measure any emissions. The following tables show measurements of the emissions found in testing. The tables show the worst-case emission measured from the EUT. For frequencies above 12.5 GHz, a measurement distance of 1 meter was used. The noise floor was a minimum of 6 dB below the limit. Emissions outside the restricted bands of §15.205 must be attenuated 20 dB below the fundamental emission when measured using a 100 kHz RBW. The emissions in the restricted bands must meet the limits specified in §15.209. Tabular data for each of the spurious emissions is shown below for each of the units. Plots of the band edges are also shown. Note that all emissions seen, were compared to the tighter limits of §15.209 and were found compliant.

RESULT

All emissions met the limits specified in §15.209; therefore, the EUT complies with the specification.

Transmitting at the Lowest Frequency (2.402 GHz)

Frequency (MHz)	Detection Mode	Antenna Polarity	Receiver Reading (dBμV)	Correction Factor (dB)	Field Strength (dBμV/m)	Limit (dBμV/m)	Margin (dB)
4804.0	Peak	Vertical	18.5	39.0	57.5	74.0	-16.5
4804.0	Average	Vertical	12.4	39.0	51.4	54.0	-2.6
4804.0	Peak	Horizontal	19.4	39.0	58.4	74.0	-15.6
4804.0	Average	Horizontal	13.5	39.0	52.5	54.0	-1.5
7206.0	Peak	Vertical	3.2	43.4	46.6	74.0	-27.4
7206.0	Average	Vertical	-5.5	43.4	37.9	54.0	-16.1
7206.0	Peak	Horizontal	8.8	43.4	52.2	74.0	-21.8
7206.0	Average	Horizontal	2.2	43.4	45.6	54.0	-8.4
9608.0	Peak	Vertical	1.8	46.7	48.5	74.0	-25.5
9608.0	Average	Vertical	-9.8	46.7	36.9	54.0	-17.1
9608.0	Peak	Horizontal	2.5	46.7	49.2	74.0	-24.8
9608.0	Average	Horizontal	-9.8	46.7	36.9	54.0	-17.1
12010.0	Peak	Vertical	1.0	49.0	50.0	74.0	-24.0
12010.0	Average	Vertical	-10.7	49.0	38.3	54.0	-15.7
12010.0	Peak	Horizontal	-0.5	49.0	48.5	74.0	-25.5
12010.0	Average	Horizontal	-11.3	49.0	37.7	54.0	-16.3

Transmitting at the Middle Frequency (2.442 GHz)

Frequency (MHz)	Detection Mode	Antenna Polarity	Receiver Reading (dB μ V)	Correction Factor (dB)	Field Strength (dB μ V/m)	Limit (dB μ V/m)	Margin (dB)
4884.0	Peak	Vertical	18.4	39.2	57.6	74.0	-16.4
4884.0	Average	Vertical	12.4	39.2	51.6	54.0	-2.4
4884.0	Peak	Horizontal	16.7	39.2	55.9	74.0	-18.1
4884.0	Average	Horizontal	10.6	39.2	49.8	54.0	-4.2
7326.0	Peak	Vertical	10.0	43.7	53.7	74.0	-20.3
7326.0	Average	Vertical	-0.4	43.7	43.3	54.0	-10.7
7326.0	Peak	Horizontal	12.0	43.7	55.7	74.0	-18.3
7326.0	Average	Horizontal	1.6	43.7	45.3	54.0	-8.7
9768.0	Peak	Vertical	2.8	46.8	49.6	74.0	-24.4
9768.0	Average	Vertical	-9.7	46.8	37.1	54.0	-16.9
9768.0	Peak	Horizontal	1.9	46.8	48.7	74.0	-25.3
9768.0	Average	Horizontal	-9.8	46.8	37.0	54.0	-17.0
12210.0	Peak	Vertical	0.9	49.1	50.0	74.0	-24.0
12210.0	Average	Vertical	-10.7	49.1	38.4	54.0	-15.6
12210.0	Peak	Horizontal	0.3	49.1	49.4	74.0	-24.6
12210.0	Average	Horizontal	-11.0	49.1	38.1	54.0	-15.9

Transmitting at the Highest Frequency (2.480 GHz)

Frequency (MHz)	Detection Mode	Antenna Polarity	Receiver Reading (dB μ V)	Correction Factor (dB)	Field Strength (dB μ V/m)	Limit (dB μ V/m)	Margin (dB)
4960.0	Peak	Vertical	20.1	39.4	59.5	74.0	-14.5
4960.0	Average	Vertical	14.0	39.4	53.4	54.0	-0.6
4960.0	Peak	Horizontal	19.0	39.4	58.4	74.0	-15.6
4960.0	Average	Horizontal	13.1	39.4	52.5	54.0	-1.5
7440.0	Peak	Vertical	6.3	44.1	50.4	74.0	-23.6
7440.0	Average	Vertical	-1.7	44.1	42.4	54.0	-11.6
7440.0	Peak	Horizontal	15.7	44.1	59.8	74.0	-14.2
7440.0	Average	Horizontal	2.9	44.1	47.0	54.0	-7.0
9920.0	Peak	Vertical	2.6	46.9	49.5	74.0	-24.5
9920.0	Average	Vertical	-10.5	46.9	36.4	54.0	-17.6

Frequency (MHz)	Detection Mode	Antenna Polarity	Receiver Reading (dB μ V)	Correction Factor (dB)	Field Strength (dB μ V/m)	Limit (dB μ V/m)	Margin (dB)
9920.0	Peak	Horizontal	2.8	46.9	49.7	74.0	-24.3
9920.0	Average	Horizontal	-10.2	46.9	36.7	54.0	-17.3
12400.0	Peak	Vertical	1.0	49.1	50.0	74.0	-24.0
12400.0	Average	Vertical	-10.9	49.1	38.4	54.0	-15.6
12400.0	Peak	Horizontal	1.2	49.1	49.4	74.0	-24.6
12400.0	Average	Horizontal	-10.8	49.1	38.1	54.0	-15.9

No other emissions were seen in the restricted bands. Noise floor was greater than 6 dB below the limit. At frequencies above 12.5 GHz, a 1 meter measurement distance was used.

Lower Band Edge

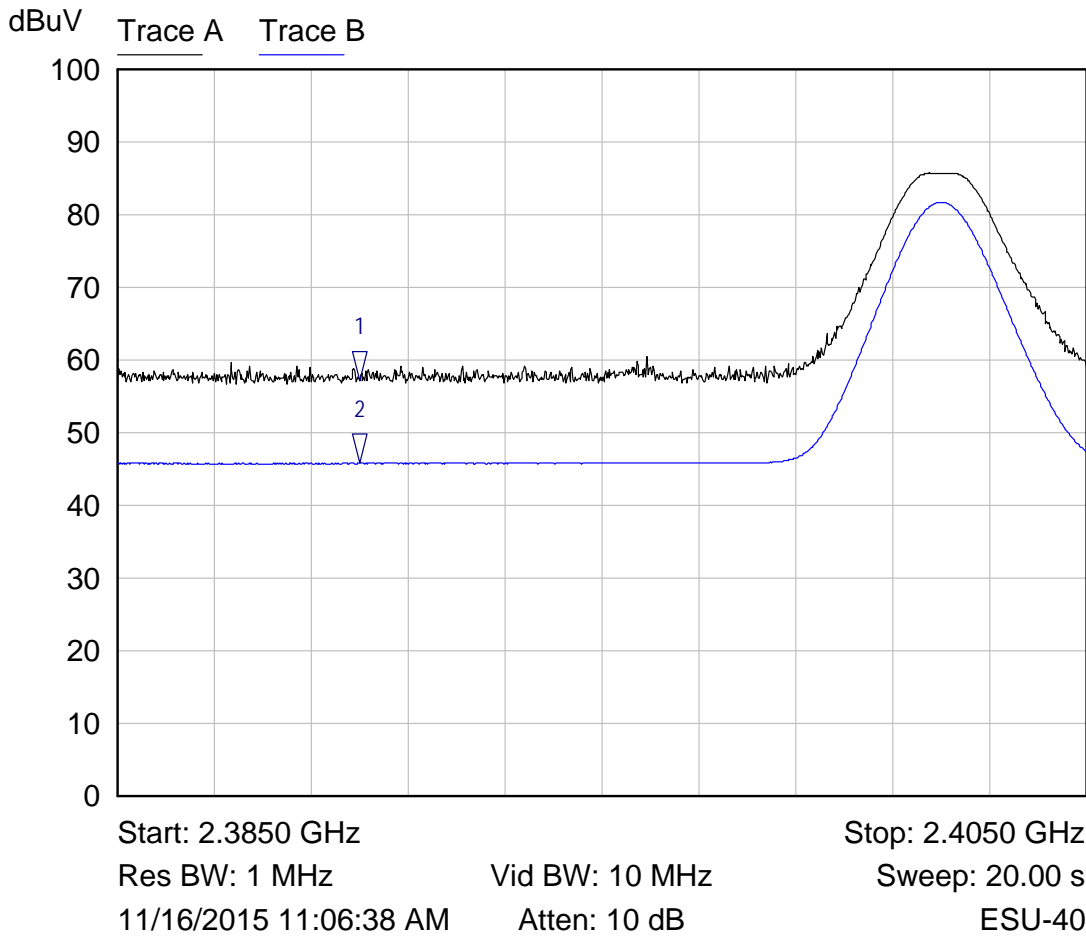

Mkr	Trace	X-Axis	Value	Notes
1 ▽	Trace A	2.3900 GHz	57.22 dBuV	
2 ▽	Trace B	2.3900 GHz	45.75 dBuV	

Upper Band Edge

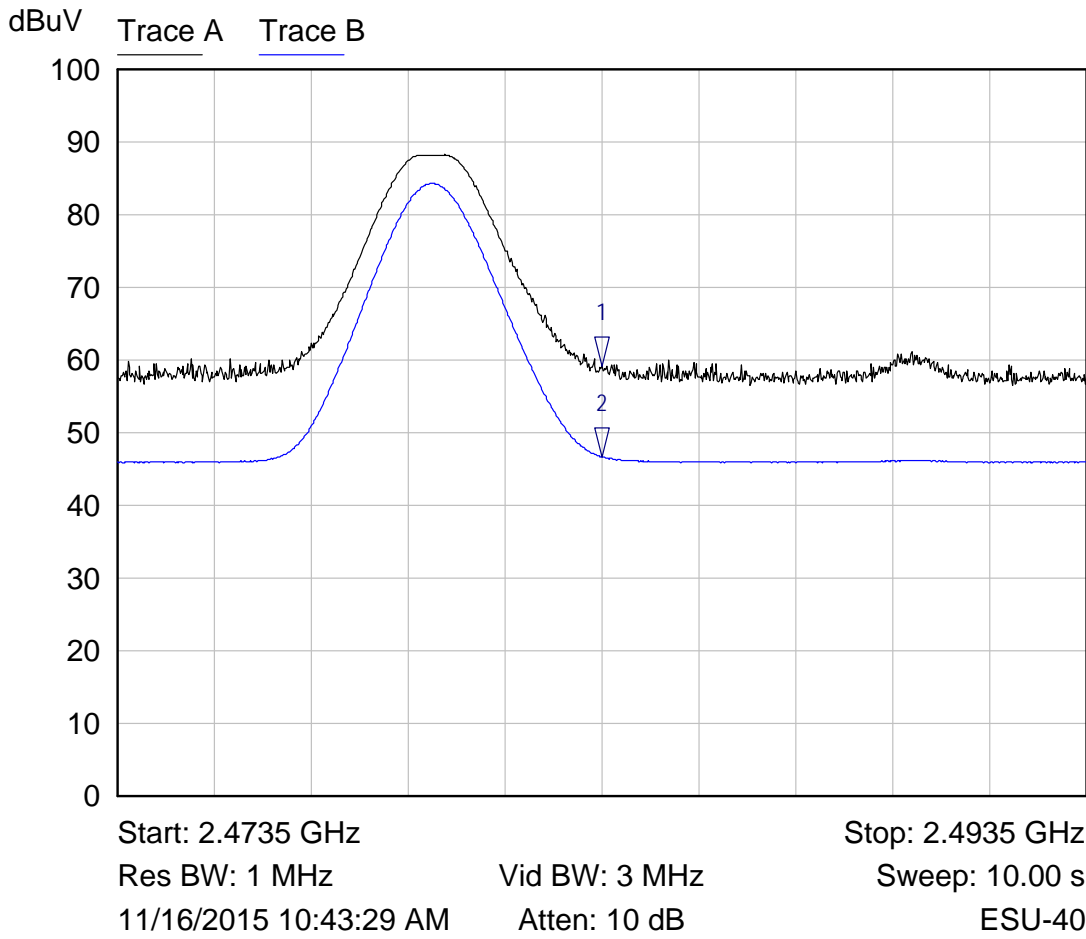

Mkr	Trace	X-Axis	Value	Notes
1 ▾	Trace A	2.4835 GHz	59.22 dBuV	
2 ▾	Trace B	2.4835 GHz	46.71 dBuV	

7.2.6 §15.247(d) Peak Power Spectral Density

The FCC allows a maximum conducted 3 kHz power spectral density of 8 dBm to a 6 dBi antenna which is an EIRP limit of 14 dBm. The radiated field strength measurements were converted to EIRP in dBm and compared to the limit of 14.0 dBm. The results are shown below.

Frequency (MHz)	Measured Field Strength at 3 meters (dB μ V/m)	3 kHz Power Spectral Density EIRP (dBm)	3 kHz Power Spectral Density EIRP Limit (dBm)
2402	71.5	-23.73	14.0
2442	76.9	-18.33	14.0
2480	77.5	-17.73	14.0

RESULT

The maximum peak power spectral density was less than the limit of 14.0 dBm; therefore, the EUT complies with the specification.

Lowest Channel

dBuV Trace A

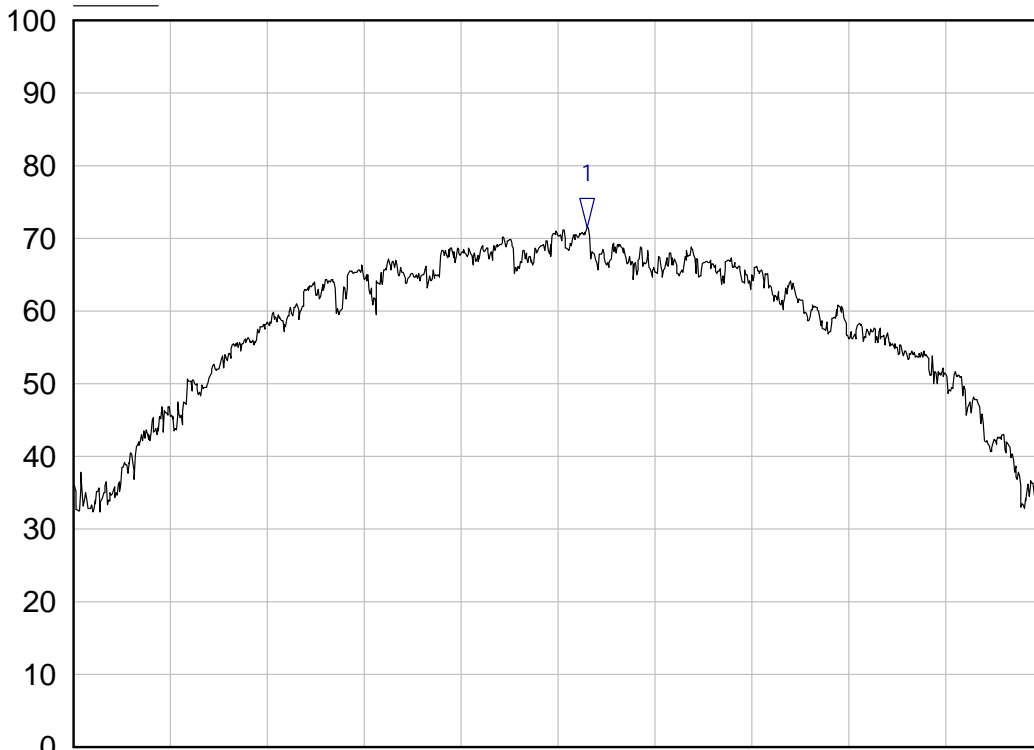

Start: 2.4013 GHz Stop: 2.4028 GHz
 Res BW: 3 kHz Vid BW: 10 kHz Sweep: 170.00 ms
 11/16/2015 11:01:55 AM Atten: 10 dB ESU-40

Mkr	Trace	X-Axis	Value	Notes
1 ▽	Trace A	2.4020 GHz	71.53 dBuV	

Upper Channel

dBuV Trace A

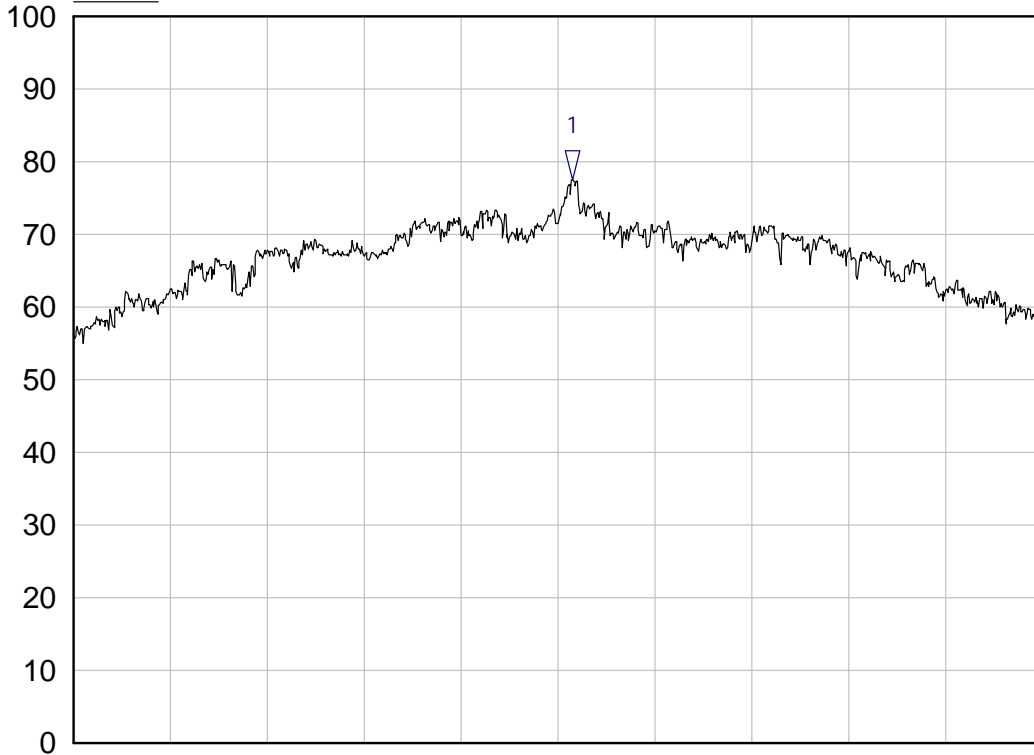

Start: 2.4795 GHz

Stop: 2.4805 GHz

Res BW: 3 kHz

Vid BW: 30 kHz

Sweep: 115.00 ms

11/16/2015 10:38:59 AM

Atten: 10 dB

ESU-40

Mkr	Trace	X-Axis	Value	Notes
1 ▽	Trace A	2.4800 GHz	77.49 dBuV	

APPENDIX 1 TEST PROCEDURES AND TEST EQUIPMENT**A1.1 §15.207 Conducted Disturbance at the AC Mains**

The conducted disturbance at mains ports from the EUT was measured using a spectrum analyzer with a quasi-peak adapter for peak, quasi-peak and average readings. The quasi-peak adapter uses a bandwidth of 9 kHz, with the spectrum analyzer's resolution bandwidth set at 100 kHz, for readings in the 150 kHz to 30 MHz frequency ranges.

The conducted disturbance at mains ports measurements are performed in a screen room using a (50 Ω /50 μ H) Line Impedance Stabilization Network (LISN).

Where mains flexible power cords are longer than 1 m, the excess cable is folded back and forth as far as possible so as to form a bundle not exceeding 0.4 m in length.

Where the EUT is a collection of equipment with each device having its own power cord, the point of connection for the LISN is determined from the following rules:

- (a) Each power cord, which is terminated in a mains supply plug, shall be tested separately.
- (b) Power cords, which are not specified by the manufacturer to be connected via a host unit, shall be tested separately.
- (c) Power cords which are specified by the manufacturer to be connected via a host unit or other power supplying equipment shall be connected to that host unit and the power cords of that host unit connected to the LISN and tested.
- (d) Where a special connection is specified, the necessary hardware to effect the connection is supplied by the manufacturer for the testing purpose.
- (e) When testing equipment with multiple mains cords, those cords not under test are connected to an artificial mains network (AMN) different than the AMN used for the mains cord under test.

For AC mains port testing, desktop EUT are placed on a non-conducting table at least 0.8 meters from the metallic floor and placed 40 cm from the vertical coupling plane (copper plating in the wall behind EUT table). Floor standing equipment is placed directly on the earth grounded floor.

Type of Equipment	Manufacturer	Model Number	Barcode Number	Date of Last Calibration	Due Date of Calibration
Spectrum Analyzer	Hewlett Packard	8566B	644	03/23/2015	03/23/2016
Quasi-Peak Detector	Hewlett Packard	85650A	1130	03/16/2015	03/16/2016
LISN	Nemko	LISN-COMM-50	1424	02/25/2015	02/25/2016
Conductance Cable Wanship Site #2	Nemko	Cable J	840	12/23/2014	12/23/2015
Transient Limiter	Hewlett Packard	11947A	768	12/23/2014	12/23/2015

An independent calibration laboratory or Nemko-CCL, Inc. personnel calibrates all the equipment listed above at intervals defined in ANSI C63.4:2003 Section 4.4 following outlined calibration procedures. All measurement instrumentation is traceable to the National Institute of Standards and Technology (NIST). Supporting documentation relative to tractability is on file and is available for examination upon request.

Conducted Emissions Test Setup

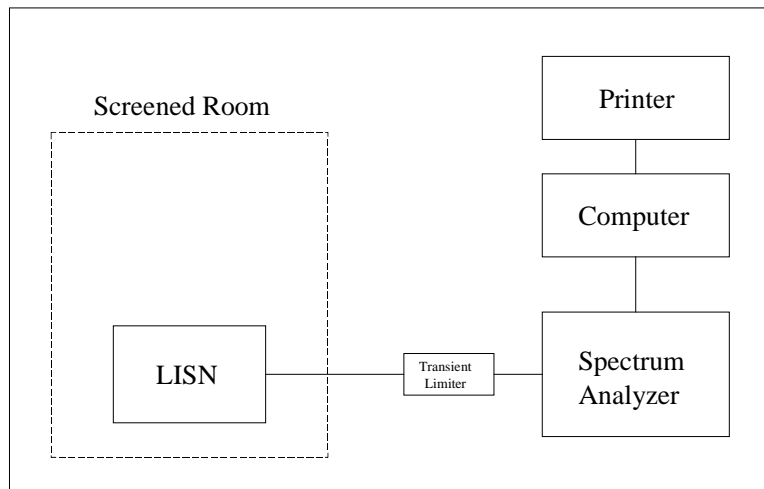

A1.2 Radiated Emissions

The radiated emissions from the intentional radiator were measured using a spectrum analyzer with a quasi-peak adapter for peak and quasi-peak readings.

A loop antenna was used to measure emissions below 30 MHz. Emission readings more than 20 dB below the limit at any frequency may not be listed in the reported data. For frequencies between 9 kHz and 30 MHz, or the lowest frequency generated or used in the device greater than 9 kHz, and less than 30 MHz, the spectrum analyzer resolution bandwidth was set to 9 kHz and the video bandwidth was set to 30 kHz. For average measurements, the spectrum analyzer average detector was used.

For frequencies above 30 MHz, an amplifier and preamplifier were used to increase the sensitivity of the measuring instrumentation. The quasi-peak adapter uses a bandwidth of 120 kHz, with the spectrum analyzer's resolution bandwidth set at 1 MHz, for readings in the 30 to 1000 MHz frequency ranges. For peak emissions above 1000 MHz the spectrum analyzer's resolution bandwidth was set to 1 MHz and the video bandwidth was set to 3 MHz. For average measurements above 1000 MHz the spectrum analyzer's resolution bandwidth was set to 1 MHz and the average detector of the analyzer was used.

A biconilog antenna was used to measure the frequency range of 30 to 1000 MHz and a Double Ridge Guide Horn antenna was used to measure the frequency range of 1 GHz to 18 GHz, and a Pyramidal Horn antenna was used to measure the frequency range of 18 GHz to 25 GHz, at a distance of 3 meters and/or 1 meter from the EUT. The readings obtained by the antenna are correlated to the levels obtained with a tuned dipole antenna by adding antenna factors.

The configuration of the EUT was varied to find the maximum radiated emission. The EUT was connected to the peripherals listed in Section 2.3 via the interconnecting cables listed in Section 2.4. A technician manually manipulated these interconnecting cables to obtain worst-case radiated disturbance. The EUT was rotated 360 degrees, and the antenna height was varied from 1 to 4 meters to find the maximum radiated emission. Where there were multiple interface ports all of the same type, cables are either placed on all of the ports or cables added to these ports until the emissions do not increase by more than 2 dB.

Desktop EUT are measured on a non-conducting table 0.8 meters above the ground plane. Emissions above 1GHz are made with the table height set at 1.5m. The table is placed on a turntable, which is level with the ground plane. For equipment normally placed on floors, the equipment shall be placed directly on the turntable.

For radiated emission testing at 30 MHz or above that is performed at distances closer than the specified distance, an inverse proportionality factor of 20 dB per decade is used to normalize the measured data for determining compliance.

Type of Equipment	Manufacturer	Model Number	Barcode Number	Date of Last Calibration	Due Date of Calibration
Spectrum Analyzer/Receiver	Rohde & Schwarz	ESU40	1229	04/07/2015	04/07/2016
Spectrum Analyzer	Hewlett Packard	8566B	644	03/23/2015	03/23/2016
Quasi-Peak Detector	Hewlett Packard	85650A	1130	03/16/2015	03/16/2016
Loop Antenna	EMCO	6502	176	03/17/2015	03/17/2017
Biconilog Antenna	EMCO	3142	713	10/22/2014	10/22/2016
Double Ridged Guide Antenna	EMCO	3115	735	03/17/2015	03/17/2017
Pyramidal Standard Gain Horn	EMC Test System	3160-09	1052	04/10/2009	ICO
High Frequency Amplifier	Miteq	AFS4-00101800-35-10P-4	1179	06/29/2015	06/29/2016
20' High Frequency Cable	Microcoax	UFB197C-1-3120-000000	1297	12/23/2014	12/23/2015
3 Meter Radiated Emissions Cable Wanship Site #2	Microcoax	UFB205A-0-4700-000000	1295	12/23/2014	12/23/2015
Pre/Power-Amplifier	Hewlett Packard	8447F	762	09/18/2015	09/18/2016
6 dB Attenuator	Hewlett Packard	8491A	1103	12/23/2014	12/23/2015

An independent calibration laboratory or Nemko-CCL, Inc. personnel calibrates all the equipment listed above at intervals defined in ANSI C63.4:2003 Section 4.4 following outlined calibration procedures. All measurement instrumentation is traceable to the National Institute of Standards and Technology (NIST). Supporting documentation relative to tractability is on file and is available for examination upon request.

Radiated Emissions Test Setup

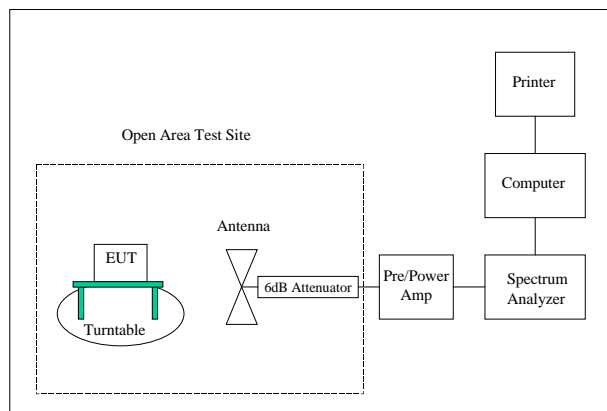

APPENDIX 2 PHOTOGRAPHS

Photograph 1 – Front View Radiated Emission Setup – With Charger



Photograph 2 – Back View Radiated Emission Setup – With Charger



Photograph 3 – View Radiated Emission Configuration – Battery Power, Flat



Photograph 4 – View Radiated Emission Configuration – Battery Power, On Edge



Photograph 5 – View Radiated Emission Configuration – Battery Power, Vertical



Photograph 6 – Front View Conducted Emission Worst Case Configuration



Photograph 7 – Back View Conducted Emission Worst Case Configuration



Photograph 8 – Front View of the EUT



Photograph 9 – View of the Mini USB Port



Photograph 10 – View of the LED Side



Photograph 11 – View of the Top Side of the Contact PCB

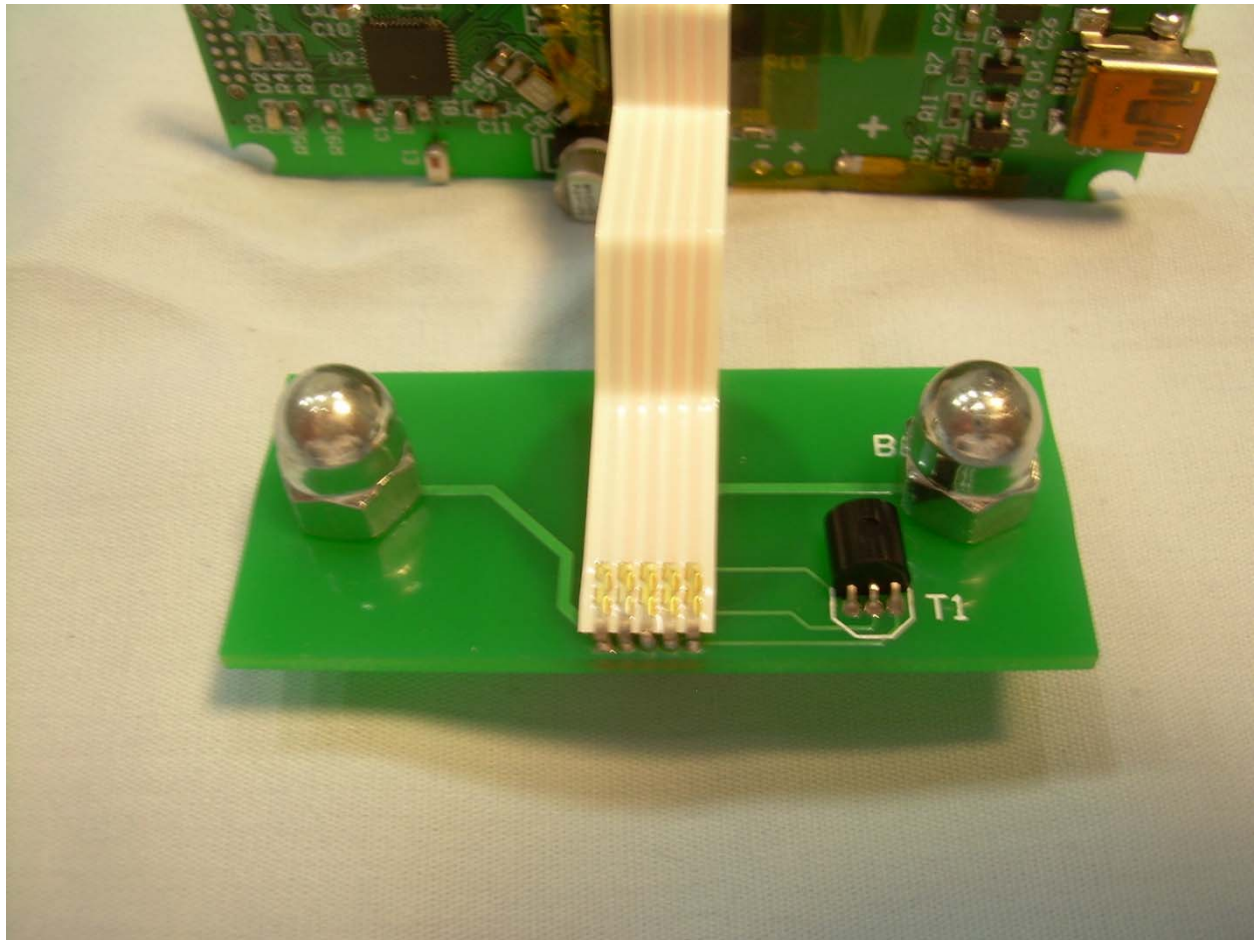

Photograph 12 – View of the Bottom Side of the Contact PCB

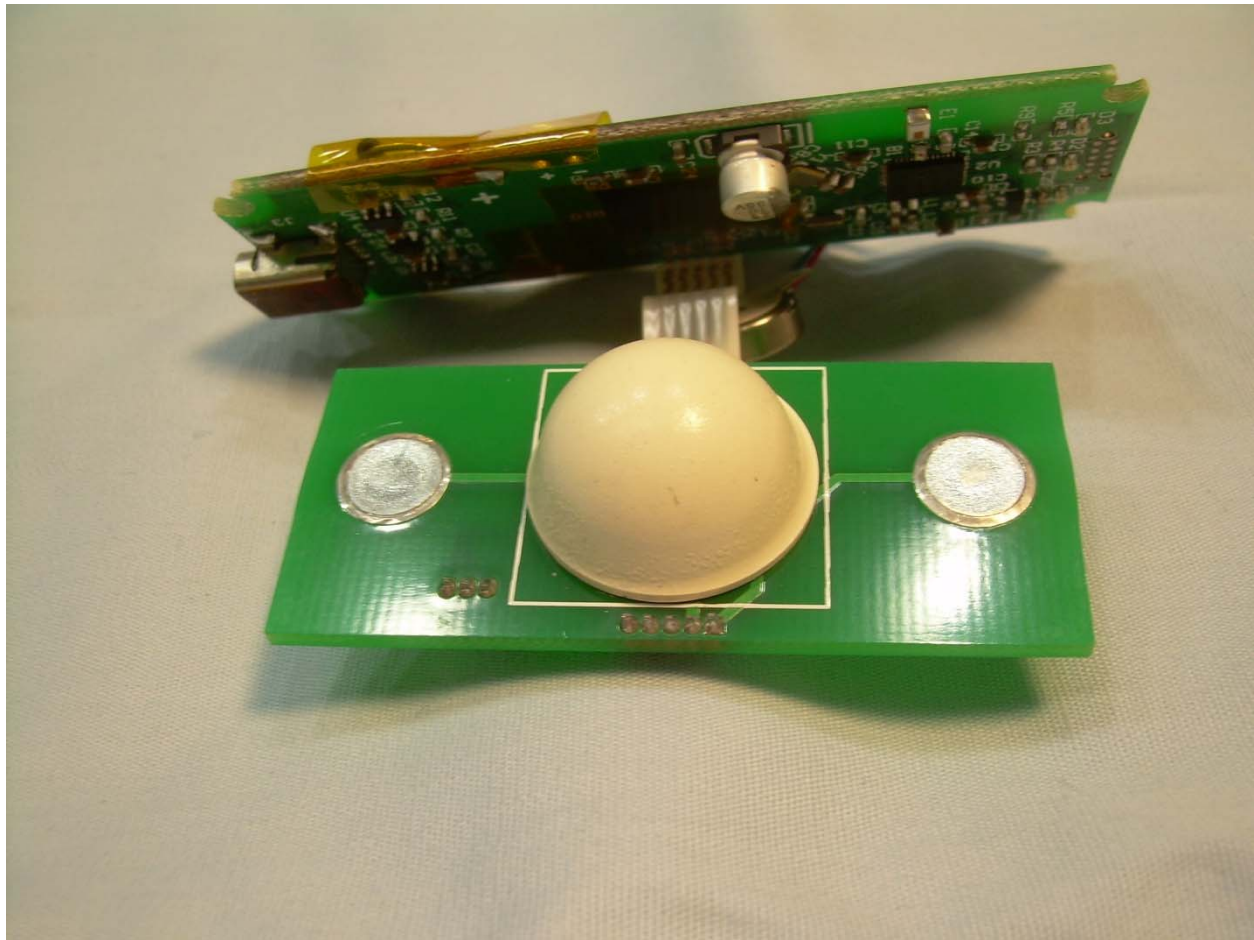

Photograph 13 – View of the Top Side of the Main PCB

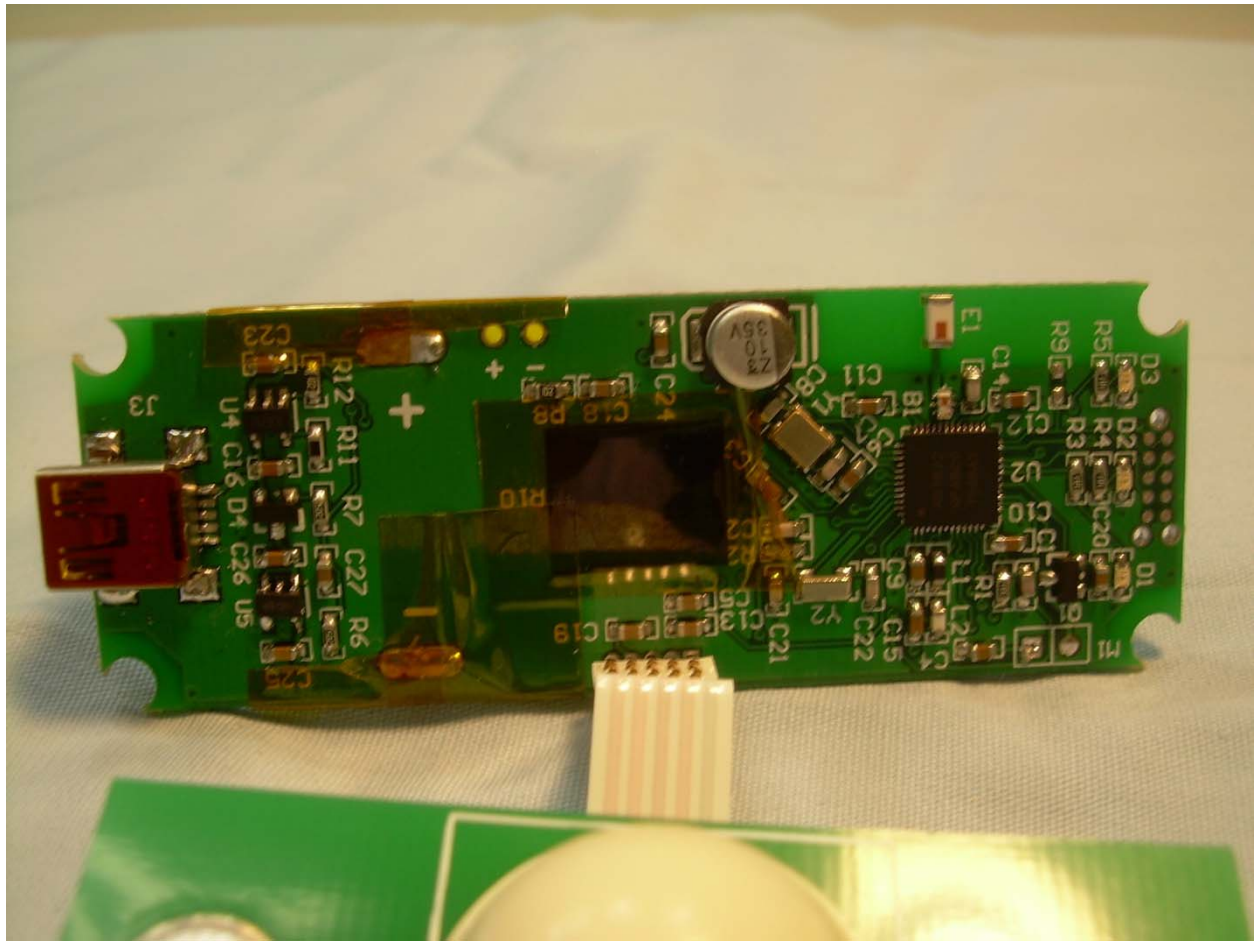

Photograph 14 – View of the Battery Side of the Main PCB

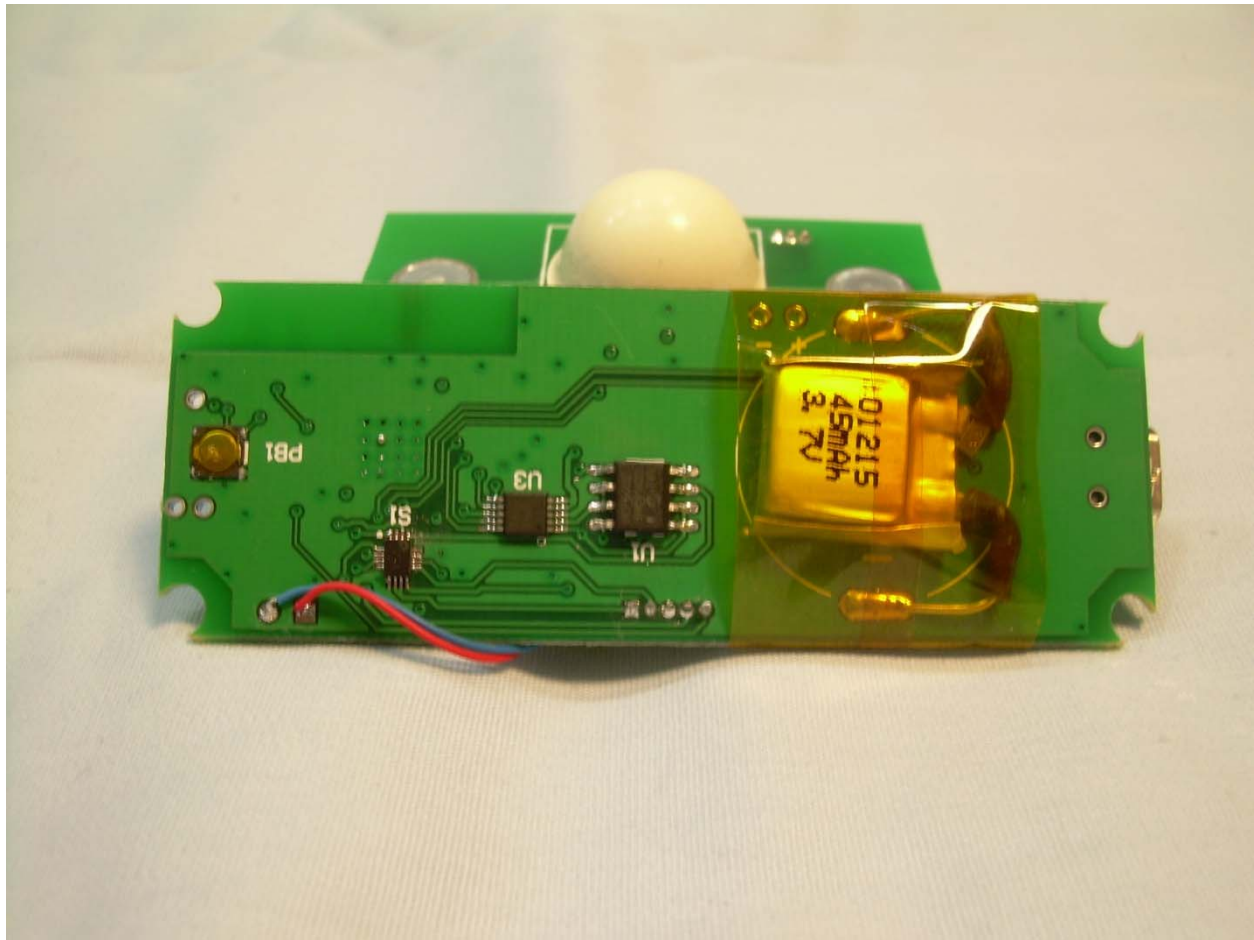

Photograph 15 – View of the AC Adapter and Cable

