

AUTOMATE®



Push PRO Programming Guide

MT02-0101-xxx013_v1.0_04092024

Programming Guide

Battery Management

P1 Locations

Wall Mounting

User Guide

Installer

Factory Reset

Safety



Warning: Important safety instructions to be read before installation and use.

Incorrect use can lead to serious injury and will void manufacturer's liability and warranty. It is important for the safety of persons to follow the enclosed instructions.

- Before using the device, read the instruction manual carefully to understand its proper use and maintenance.
- Do not expose to water, moisture, humid and damp environments or extreme temperatures

- Persons (including children) with reduced physical, sensory or mental capabilities, or lack of experience and knowledge, should not be allowed to use this product.
- Use of modification outside the scope of this instruction manual will void warranty.
- Installation and programming to be performed by a suitably qualified installer.
- For use with motorized shading devices.
- Frequently inspect for improper operation.
- Do not use if repair or adjustment is necessary.
- Keep clear when in operation.
- Save these instructions for future reference.

Specifications

Operating Temperature	14°F to 113°F (-10°C to 45°C)
Battery Type	1000mAh Li-Ion
Ratings	5V DC 500mA
Radio Frequency	433.92 MHz
Transmitting Power	10 milliwatt
RF Modulation	FSK
IP Rating	40
Transmission Distance	up to 328 ft* (up to 100m*)

* depending on environment

FCC ID: 2AGGZ003B9ACA57

IC: 21769-003B9ACA57

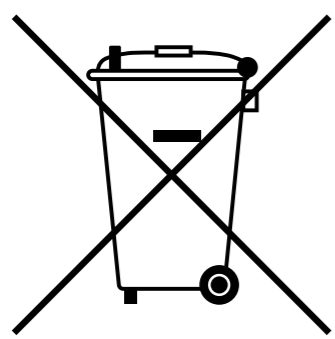

Do not dispose of
in general waste



FCC & ICES Statement

This device complies with part 15 of the FCC Rules.

Operation is subject to the following two conditions: (1) This device may not cause harmful interference, and (2) this device must accept any interference received, including interference that may cause undesired operation.

Caution:

Changes or modifications to this unit not expressly approved by the party responsible for compliance could void the user's authority to operate the equipment. This device contains licence-exempt transmitter(s)/receiver(s) that comply with Innovation, Science and Economic Development Canada's licence-exempt RSS(s). Operation is subject to the following two conditions: (1) This device may not cause interference. (2) This device must accept any interference, including interference that may cause undesired operation of the device.

L'émetteur/récepteur exempt de licence contenu dans le présent appareil est conforme aux CNR d'Innovation, Sciences et Développement économique Canada applicables aux appareils radio exempts de licence.

L'exploitation est autorisée aux deux conditions suivantes : 1) L'appareil ne doit pas produire de brouillage; 2) L'appareil doit accepter tout brouillage radioélectrique subi, même si le brouillage est susceptible d'en compromettre le fonctionnement.

NOTE:

This equipment has been tested and found to comply with the limits for a Class B digital device, pursuant to part 15 of the FCC Rules. These limits are designed to provide reasonable protection against harmful interference in a residential installation. This equipment generates, uses and can radiate radio frequency energy and, if not installed and used in accordance with the instructions, may cause harmful interference to radio communications. However, there is no guarantee that interference will not occur in a particular installation.

If this equipment does cause harmful interference to radio or television reception, which can be determined by turning the equipment off and on, the user is encouraged to try to correct the interference by one or more of the following measures:

- Reorient or relocate the receiving antenna.
- Increase the separation between the equipment and receiver.
- Connect the equipment into an outlet on a circuit different from that to which the receiver is connected.
- Consult the dealer or an experienced radio/TV technician for help.
- To view E-Label information on the remote:
 1. Enter to Main Menu by pressing the "**Menu**" button 
 2. Scroll down and press "**About**"
 3. E-Lab PageFor more information on regulatory markings and warning statements, press "**Regulatory Information**" tab.

-

System Assembly

Please refer to separate Rollease Acmeda System Assembly Manual for full assembly instructions relevant to the hardware system being used.

Motor Battery Management

Battery Motors

Prevent discharging the battery completely for extended periods, recharge as soon as the battery is discharged.

Charging notes

Charge your motor for 6-8hours, depending on the motor model, as per motor instructions.



Note: During operation, if battery is low, the motor will beep 10 times to prompt the user it needs charging.

Recycling: Properly recycle the Li-ion battery at the end of its life to minimize environmental impact.

Motor P1 Locations

Please refer to your motor programming manual for P1 button functionality.

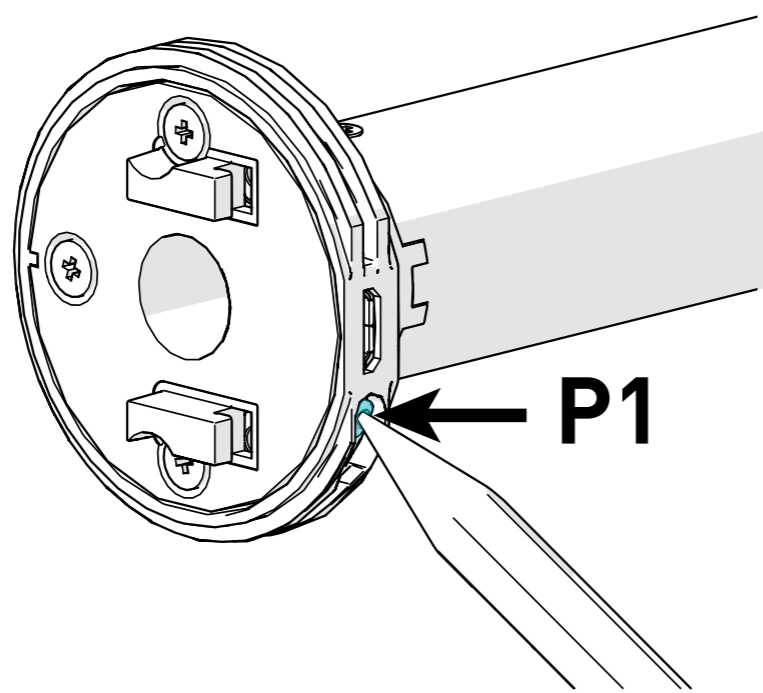

Internal Tubular

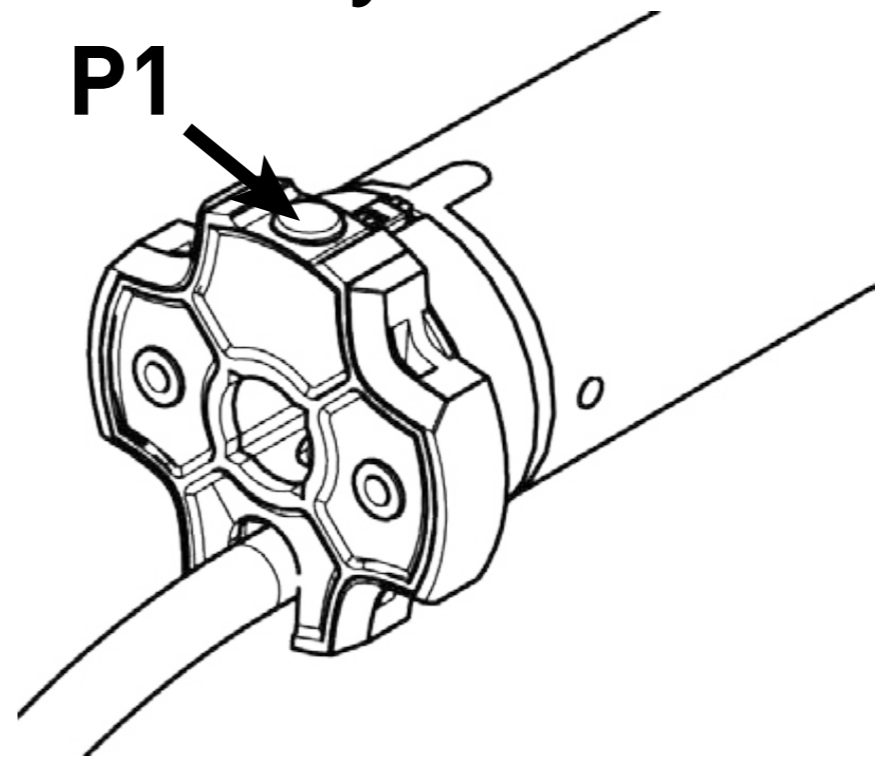

Large Tubular

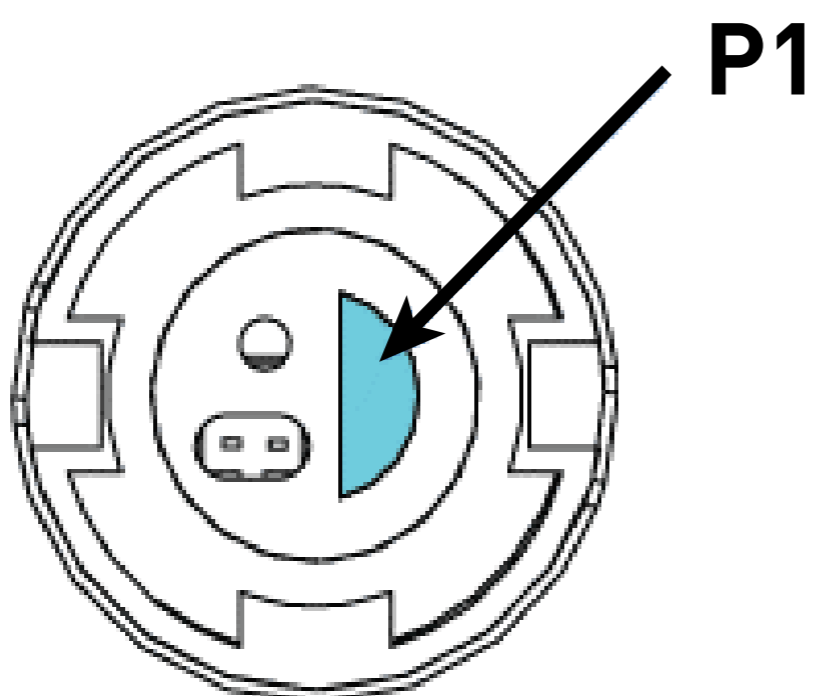

0.6 Cord Lift

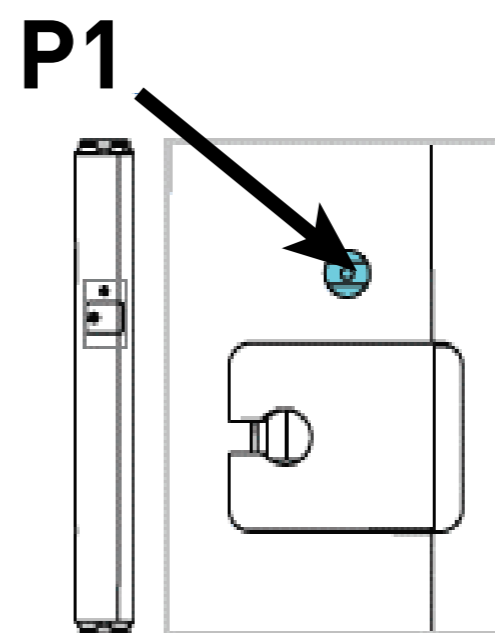

0.8 Cord Lift

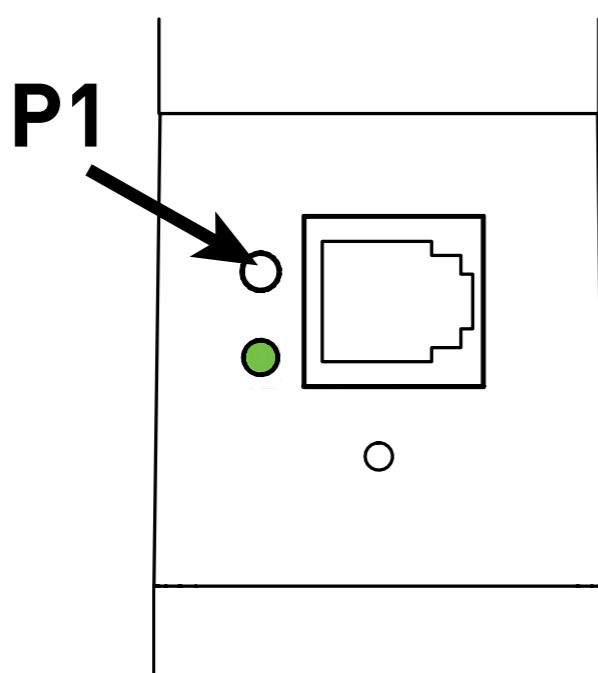

Curtain

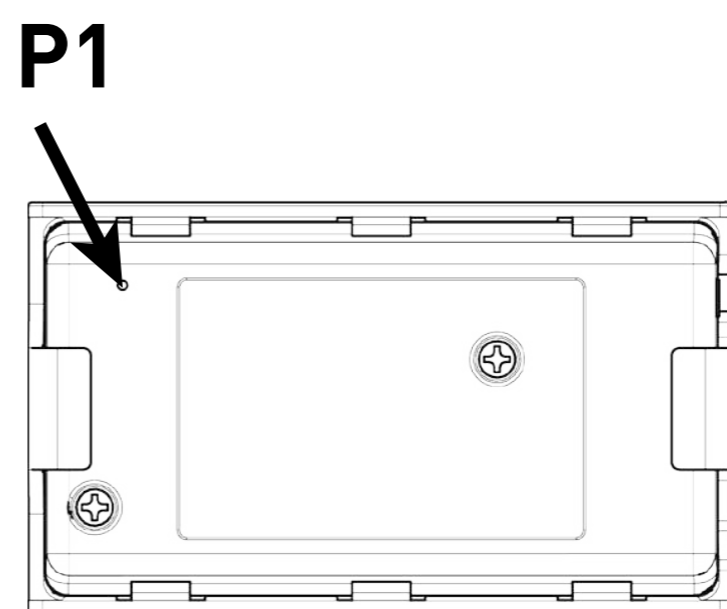

Tilt Motor

Wall Mounting

Use supplied fasteners and anchors to attach the base to wall.

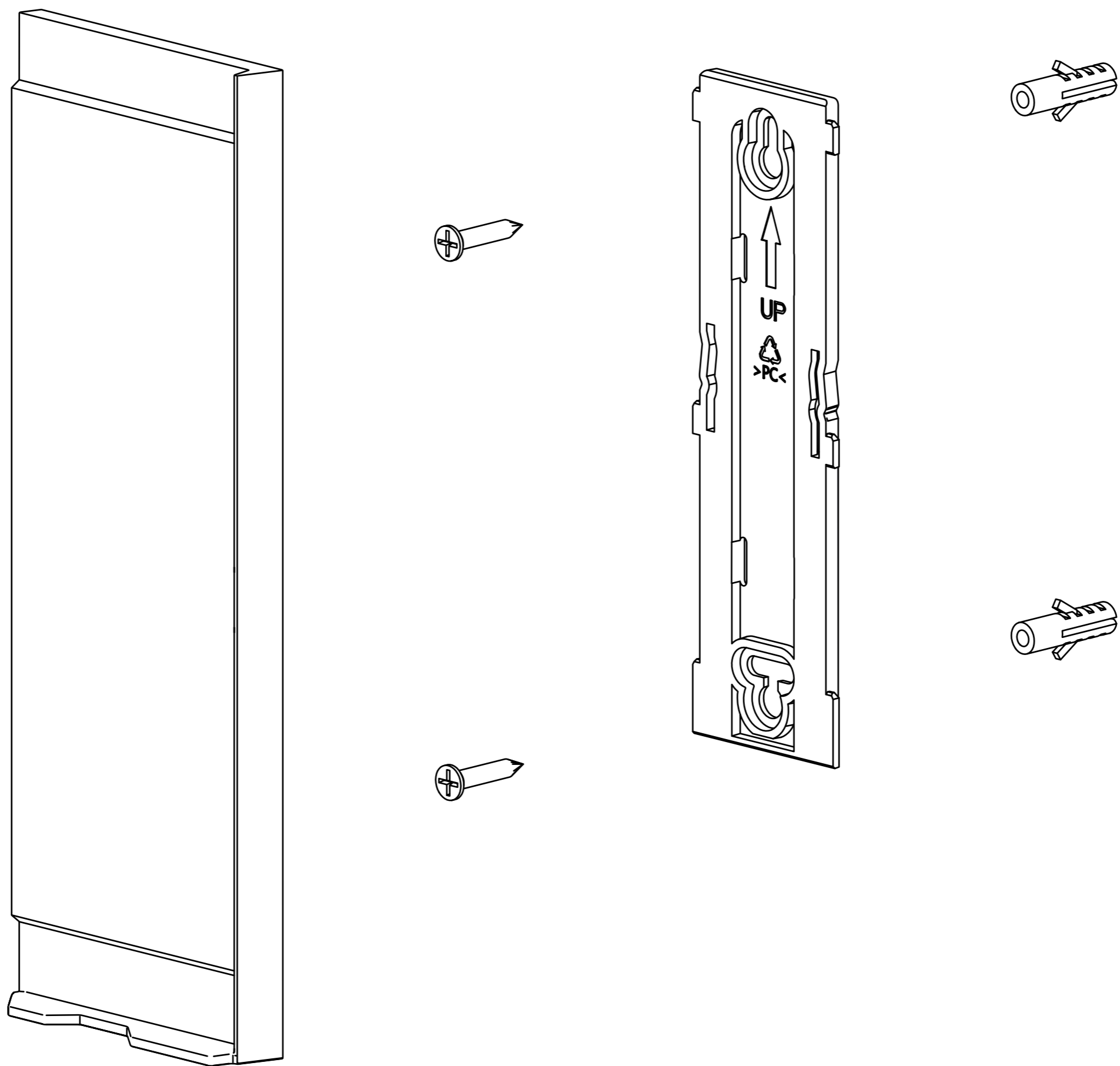

Charging The Remote

Your PUSH PRO remote comes with an internal battery that might need to be charged before you use it for the first time.

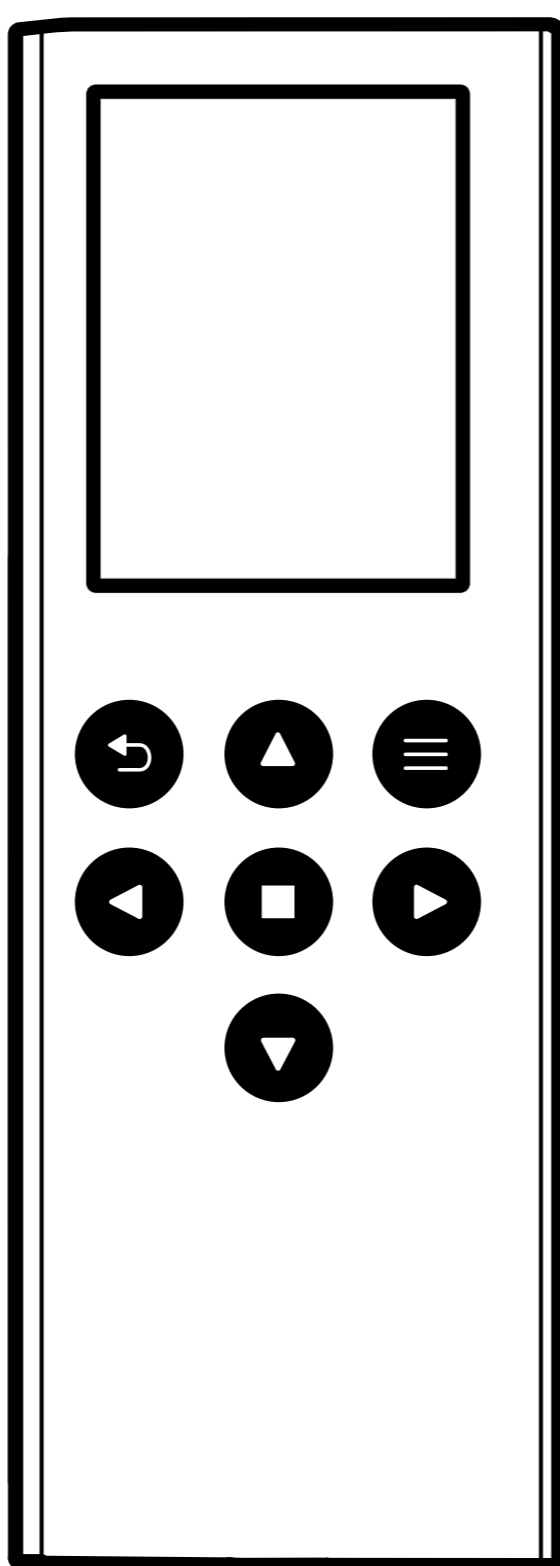

To charge your remote, connect a compatible USB-C cable (not included) to the remote's USB-C charging port. Plug the other end of the cable into a computer USB port and a USB wall adapter (5V 500mA, not included). A lightning bolt icon should appear, indicating that the remote is charging.

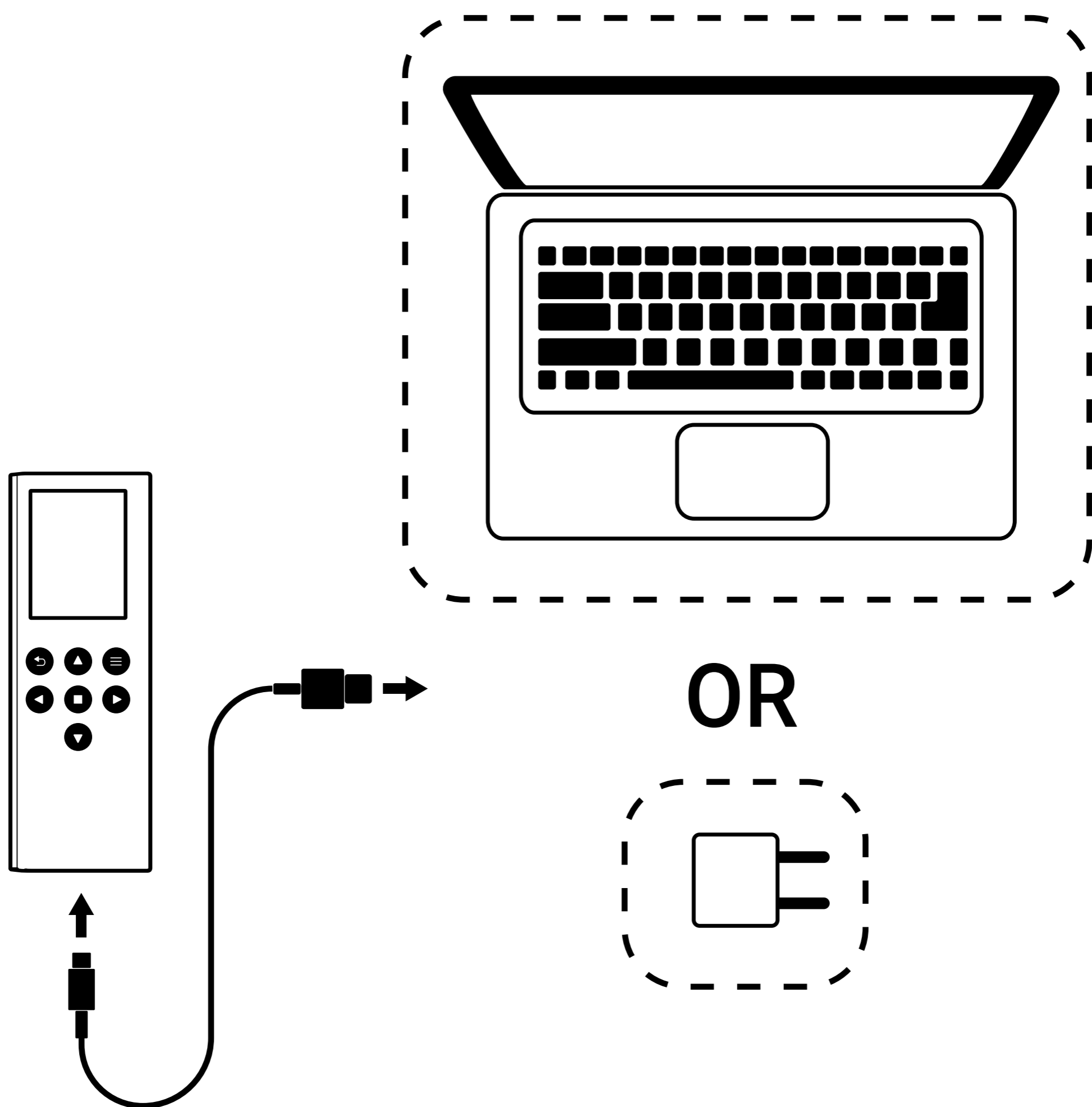

First Use

It is recommended to charge the remote fully before using it for the first time

Battery is Full



Battery is Low



Battery must be recharged

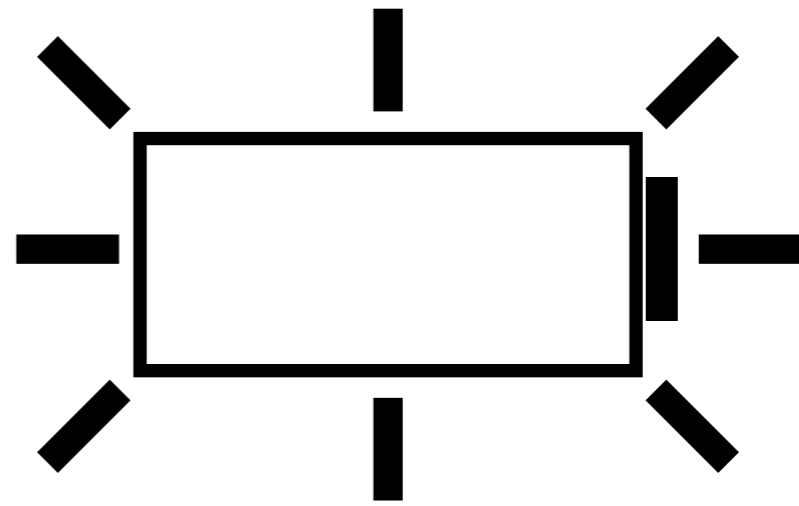

Battery is Charging

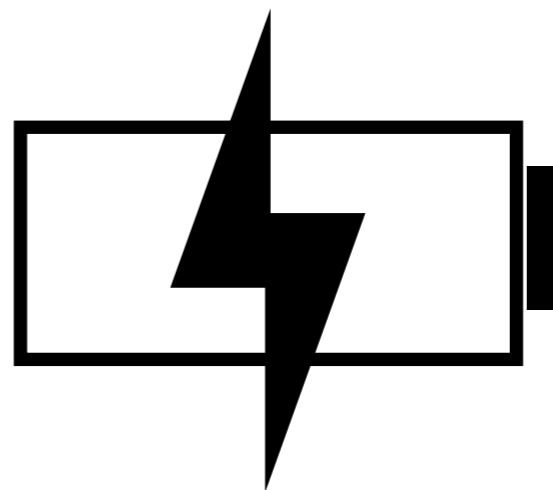

Button Overview

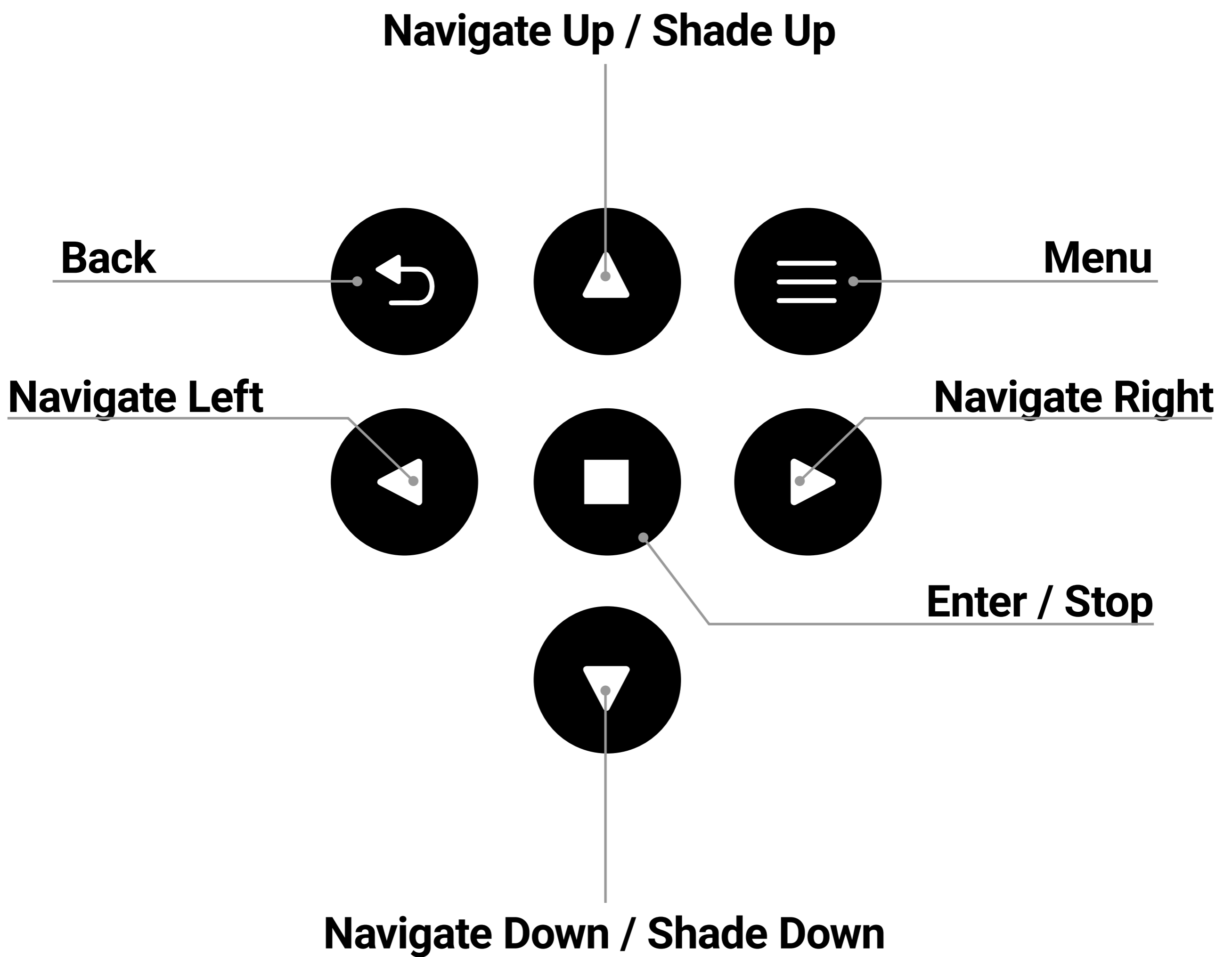

Turning On the Remote

The PUSH PRO remote is designed for continuous operation and does not feature a physical power button. Press any button to activate the remote.

The screen will turn on and you will be greeted by the welcome screen.

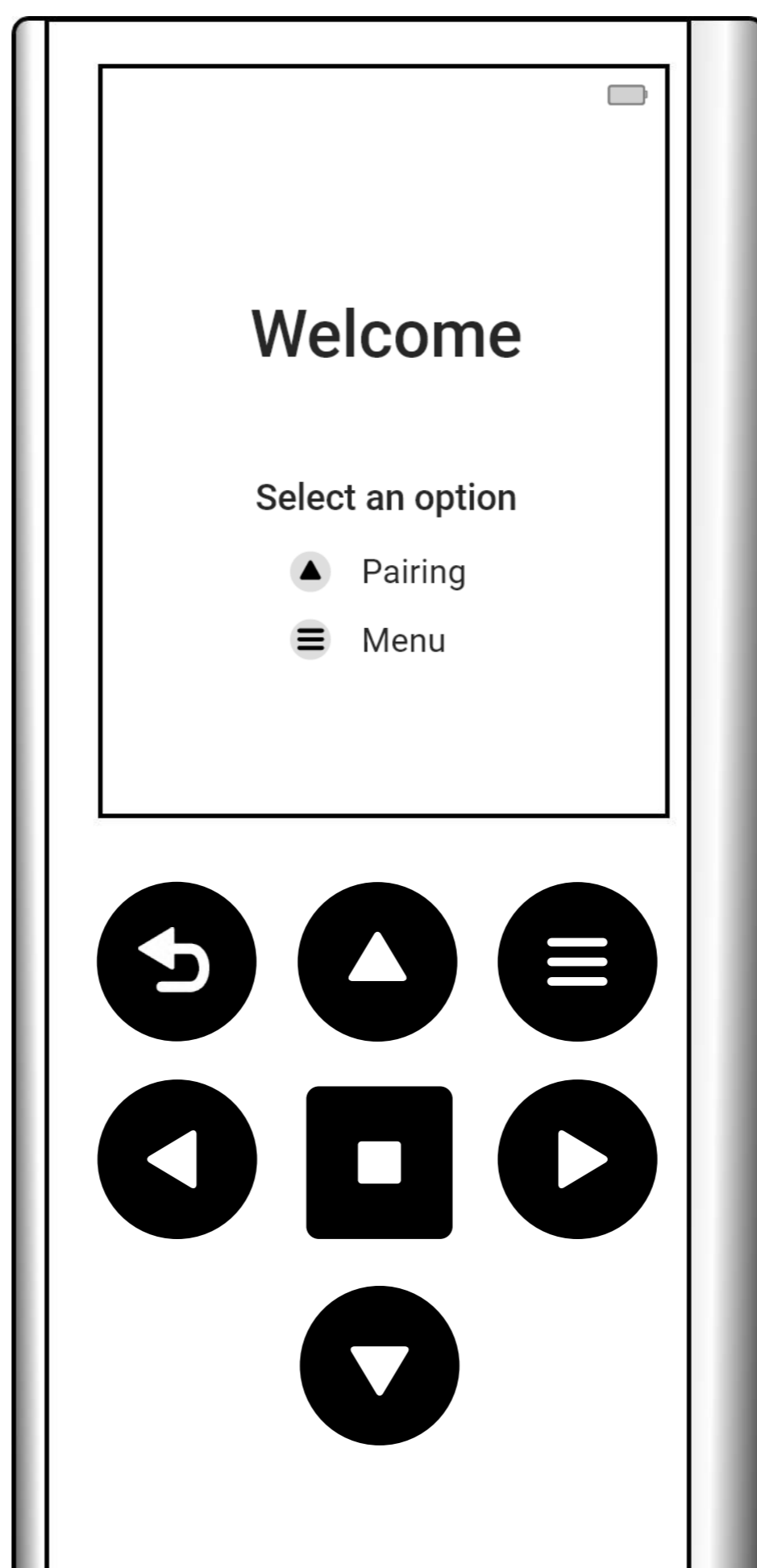

Smart-Wake

This feature allows the display to automatically activate when the remote is picked up.

After pairing your first shade, Smart-Wake will be enabled automatically. Smart-Wake can be disabled in [Remote Settings](#).



Using your Remote

The PUSH Pro remote features easy to use, tactile buttons.

To navigate menus and control the remote, use Up, Down, Left, or Right buttons.

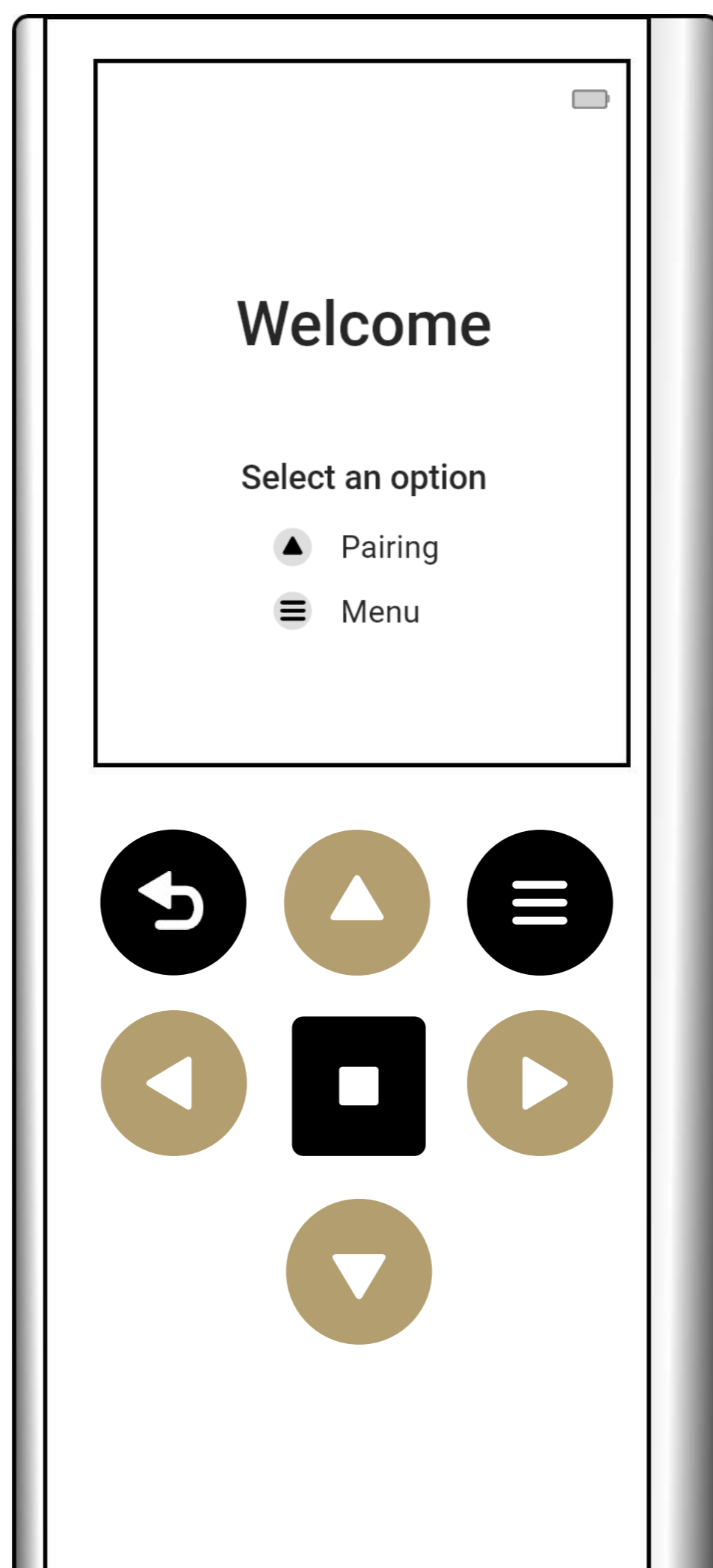

To select an option, press the Enter button.

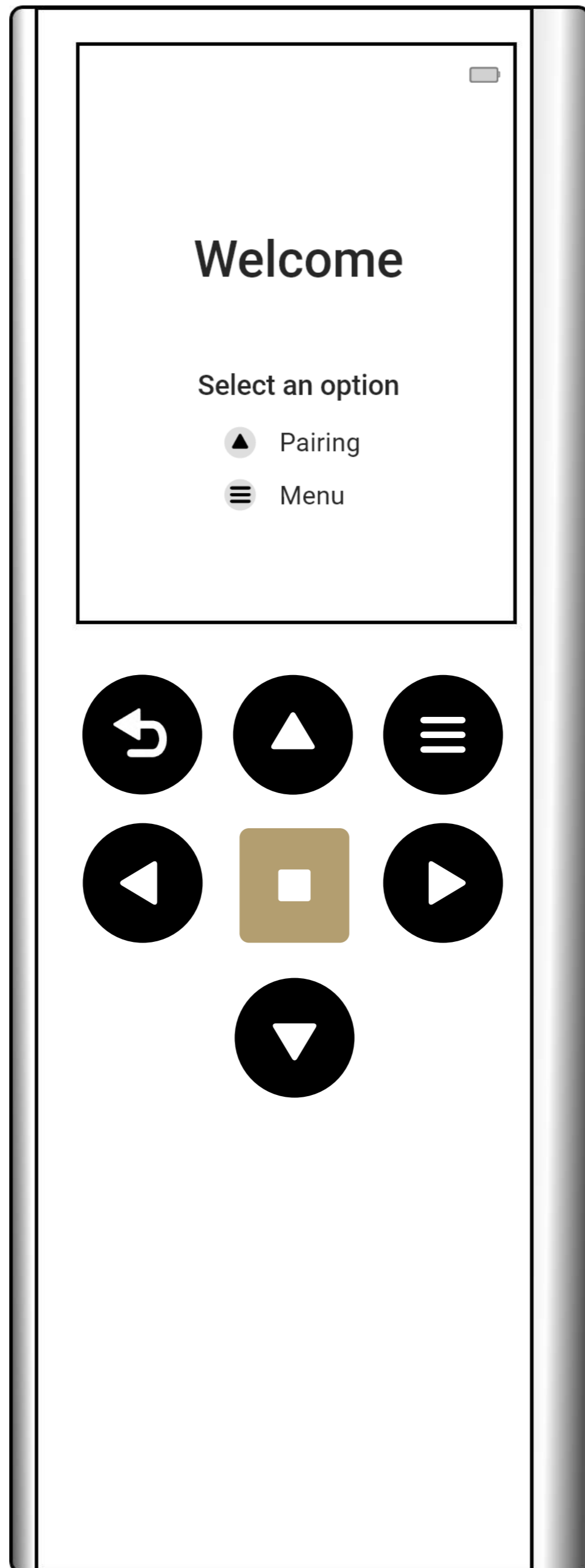

Access Control

The Push PRO remote features access control to advanced settings. This is intended for experienced users or installers. This option is available in the [Remote Settings](#) menu -> Unlock Remote.

Below is a list of functions available once the remote is unlocked.

- Deleting Shades
- Adjusting Limits
- Motion Control
- Toggle Roller/Tilt
- Toggle Fabric Tensioning
- Toggle Impact Detection
- Change Type
- Installer Mode

The remote will remain unlocked until manually locked, typically after you have finished setting up your motorized shades.

Pairing a New Shade

The PUSH PRO remote can store up to 30 different shades. Your remote can communicate with your paired shade using ARC or a combination of ARC and Bluetooth. For more information, please consult your motor manual. Press the menu button on the remote. Navigate to “Shades”, and press the Enter button.

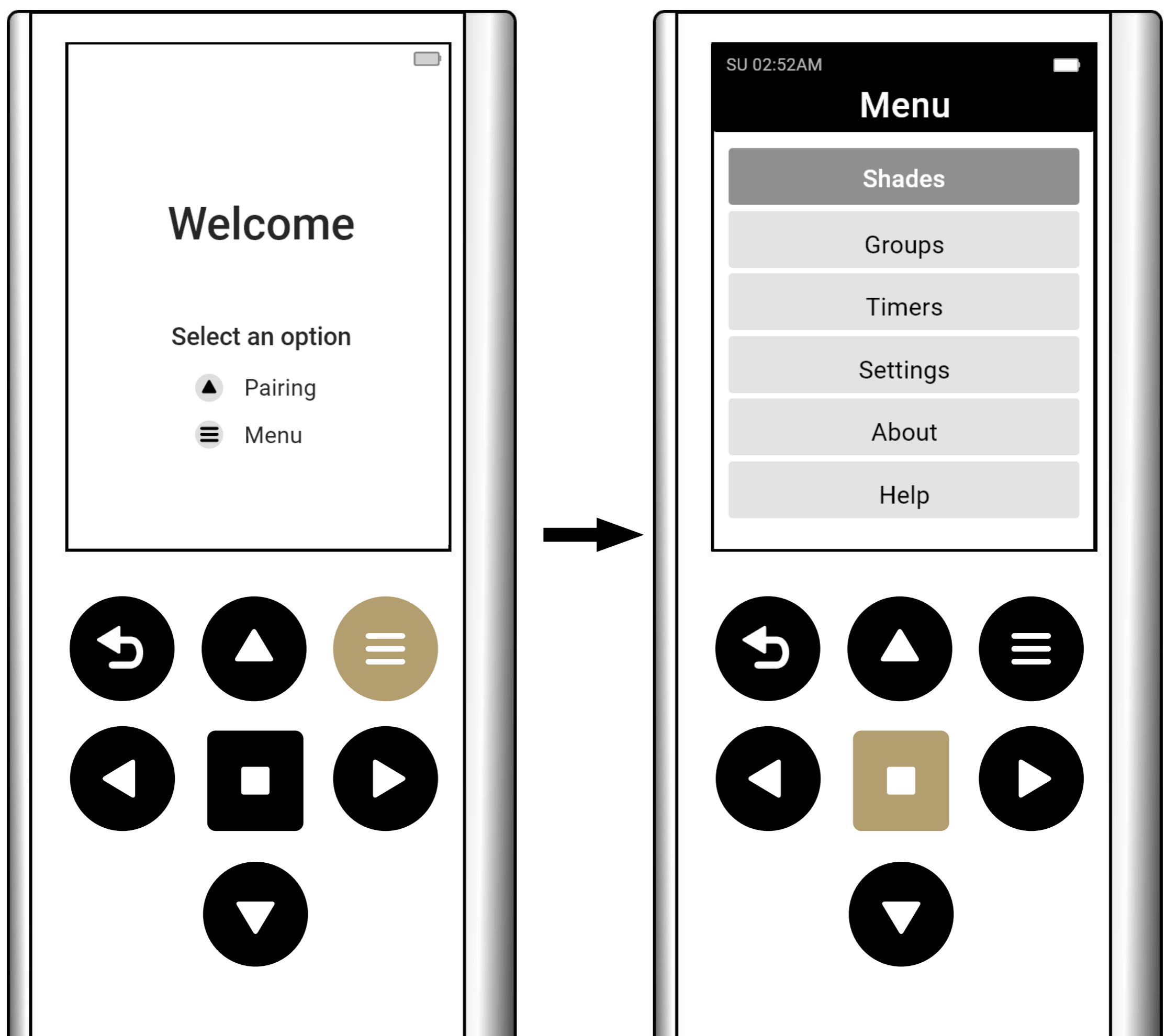

Select Pair New Shade, then press the Enter button.

Follow the on-screen instructions to pair your new shade.

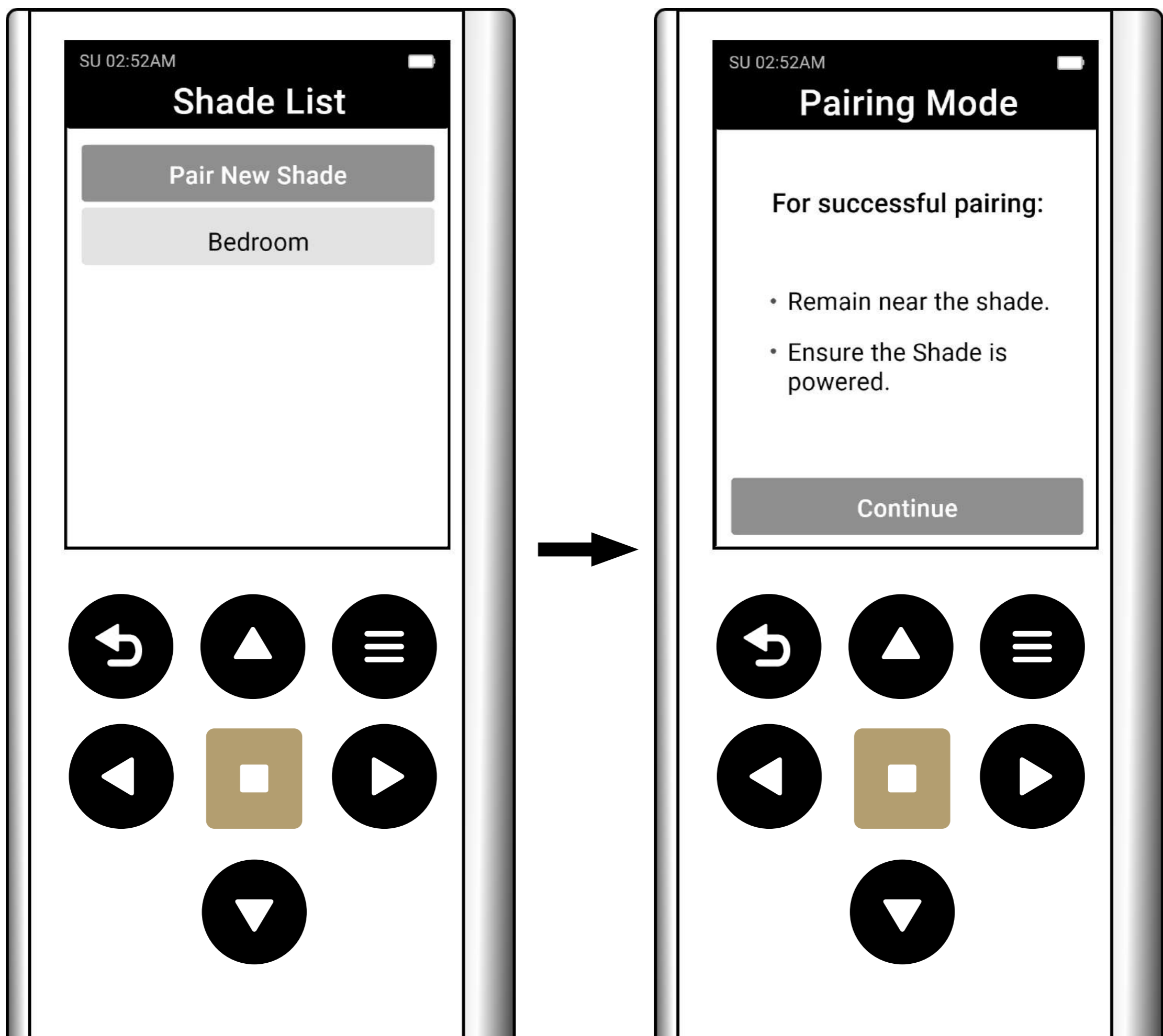

Note: Pairing a new shade will also guide you through the following setup steps.

1. Pair a new Shade
2. Name your Shade
3. Check/Change the shade's direction
4. Set upper and lower limits
5. Create a group or add to an existing group

Shade Settings

Shade settings allow you to modify certain parameters for your shade pairs.

Press the Menu button on the remote and select “Shades,” then select the name of the Shade you want to modify.

- Edit Name - Modify the Shade Name
- Show - Show or Hide the Shade from the main screen
- Battery Level Check - Check the battery level of your shade
- Set Fav. Position - Set a favorite position of your shade
- Toggle Charging LED - Toggle the charging LED light on/off (if applicable)
- Set Upper Limit (unlocked mode only) - Set the shade's upper limit
- Set Lower limit (Unlocked mode only) - Set the shade's lower limit

Shade Settings

- Motion Control (Unlocked mode, Li-ion only) - Adjust speed and soft stop settings
- Toggle Tilt/Roller Mode (Unlocked mode, Li-ion only) - Toggle between tilt or roller mode (if applicable)
- Set Tensioning Mode (Unlocked mode, AC/DC only) - Toggle fabric tensioning on/off
- Toggle Impact Det. (unlocked mode, AC/DC only) – Toggle impact detection on/off
- Change Type (Unlocked mode only) – change the type of paired motor
- Delete Shade (Unlocked mode only) – Delete Shade from remote

Set Favorite Position

The favorite position feature lets you assign a preferred level setting for each of your shades.

Press the Menu button on the remote select “Shades,” then press the Enter button.

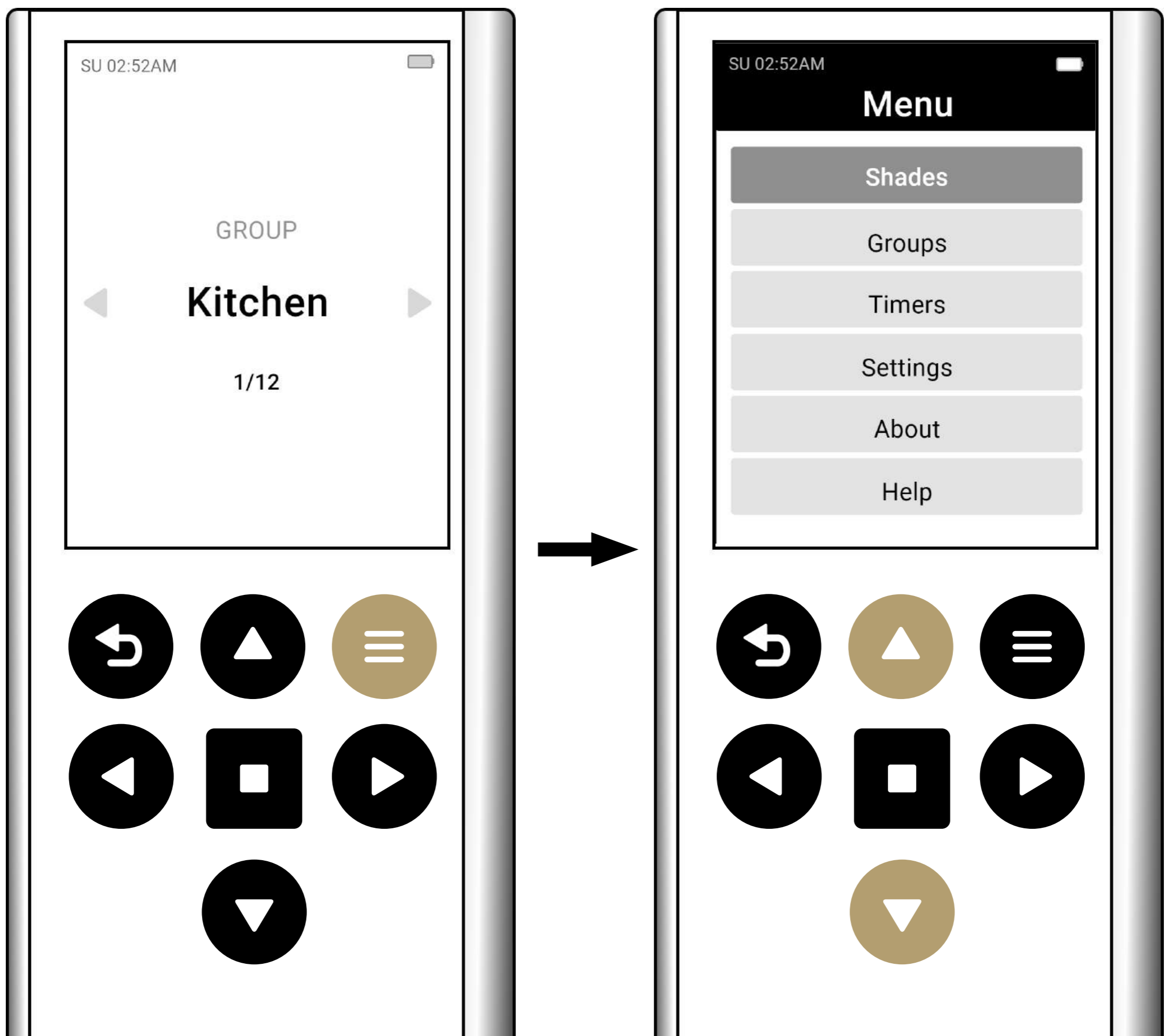

Select the name of the shade you wish to configure.

If you have a favorite position set, select the Clear Fav. Position to clear the setting first. Then select Set Fav. Position.

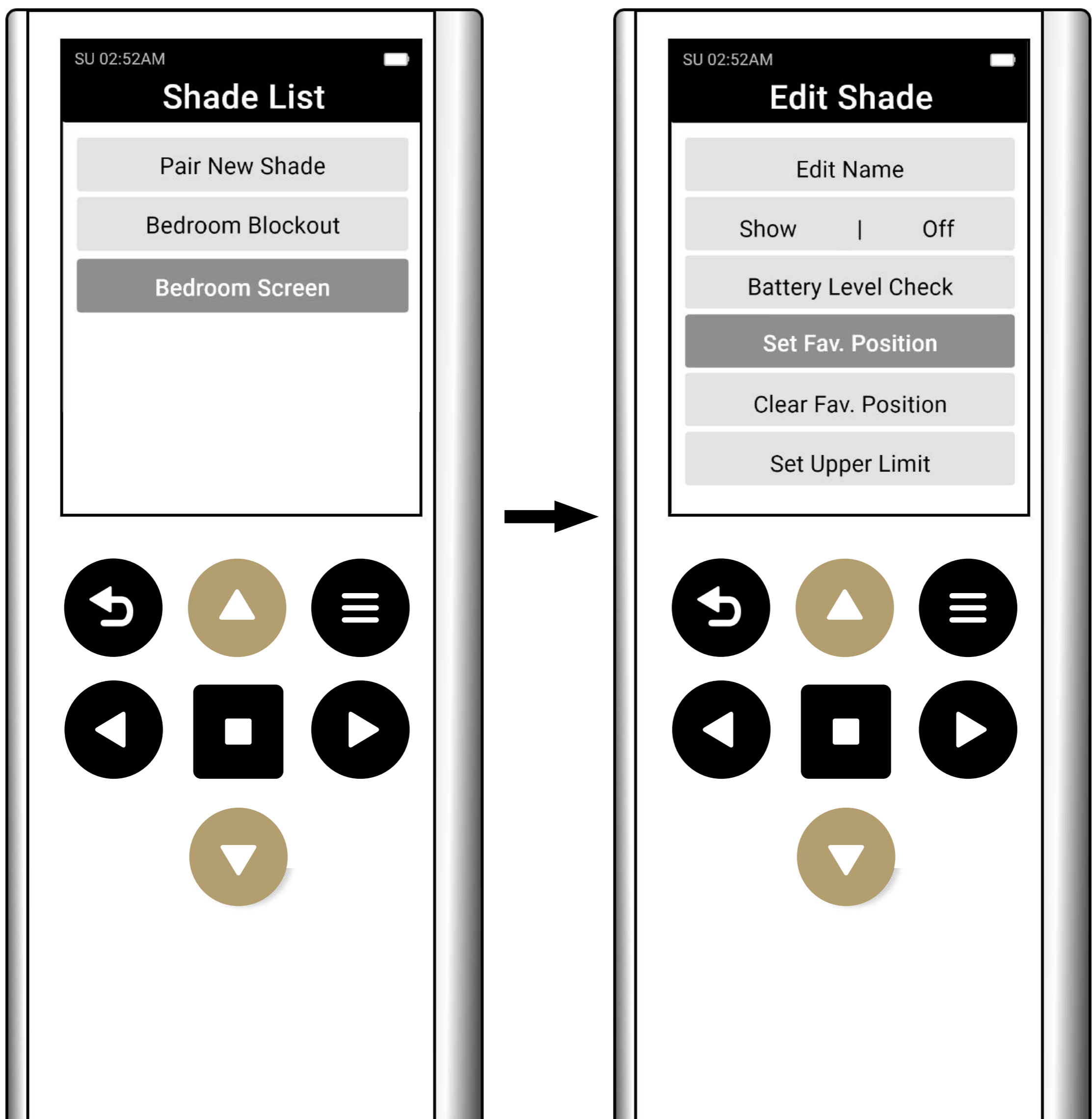

Follow the on-screen instructions.



Adjusting Shade Limits

Ensure your remote is in an [unlocked state](#).

Press the Menu button on the remote. Select “Shades,” then press Enter.



Select the name of the shade you want to adjust then press Enter.

Select Set Upper Limit or Set Lower Limit and follow the on screen instructions.

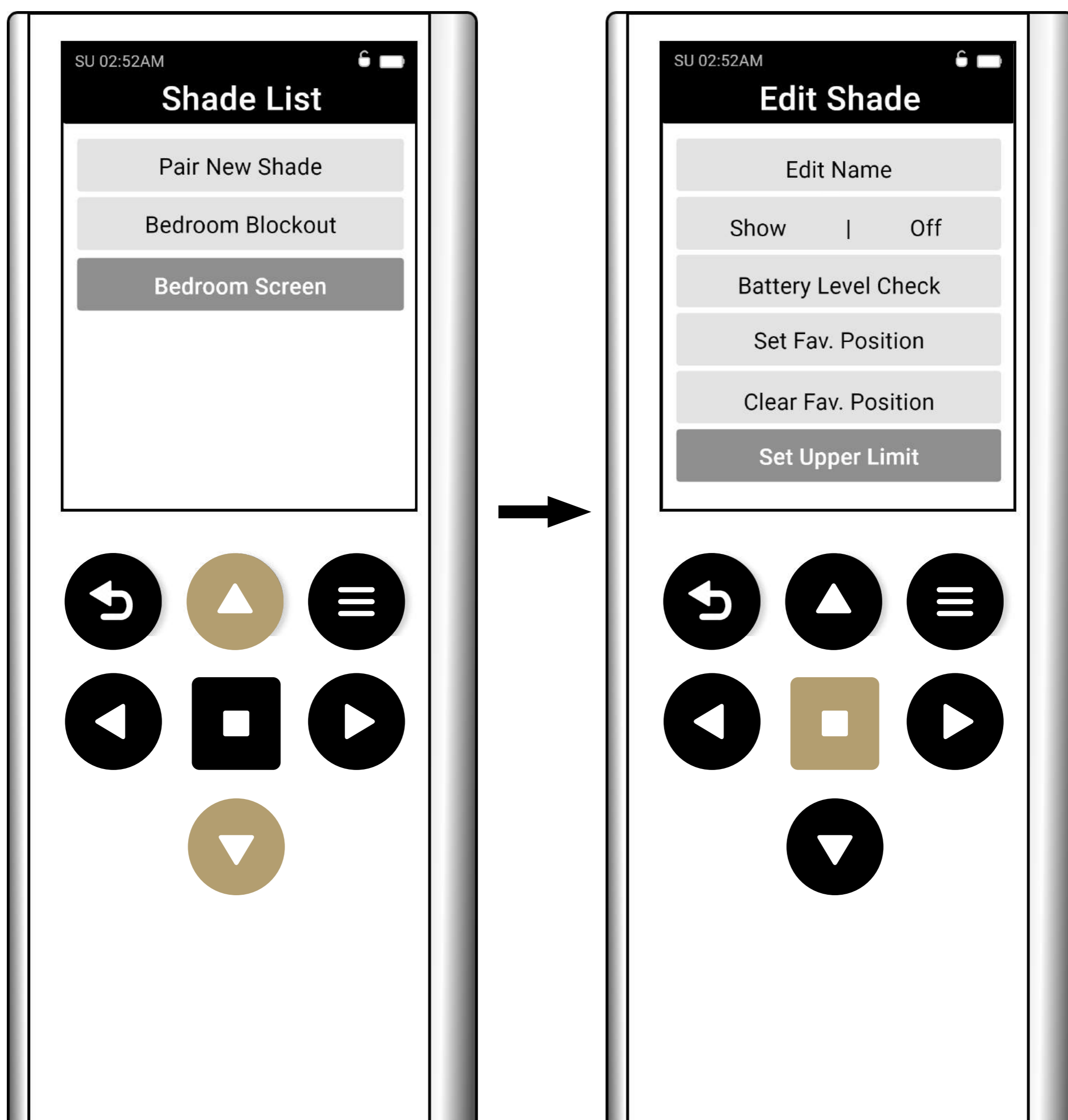

Renaming your Shades

Press the Menu button on the remote. Select “Shades,” then press the Enter button.

Select the name of the Shade you want to adjust and press the Enter button.

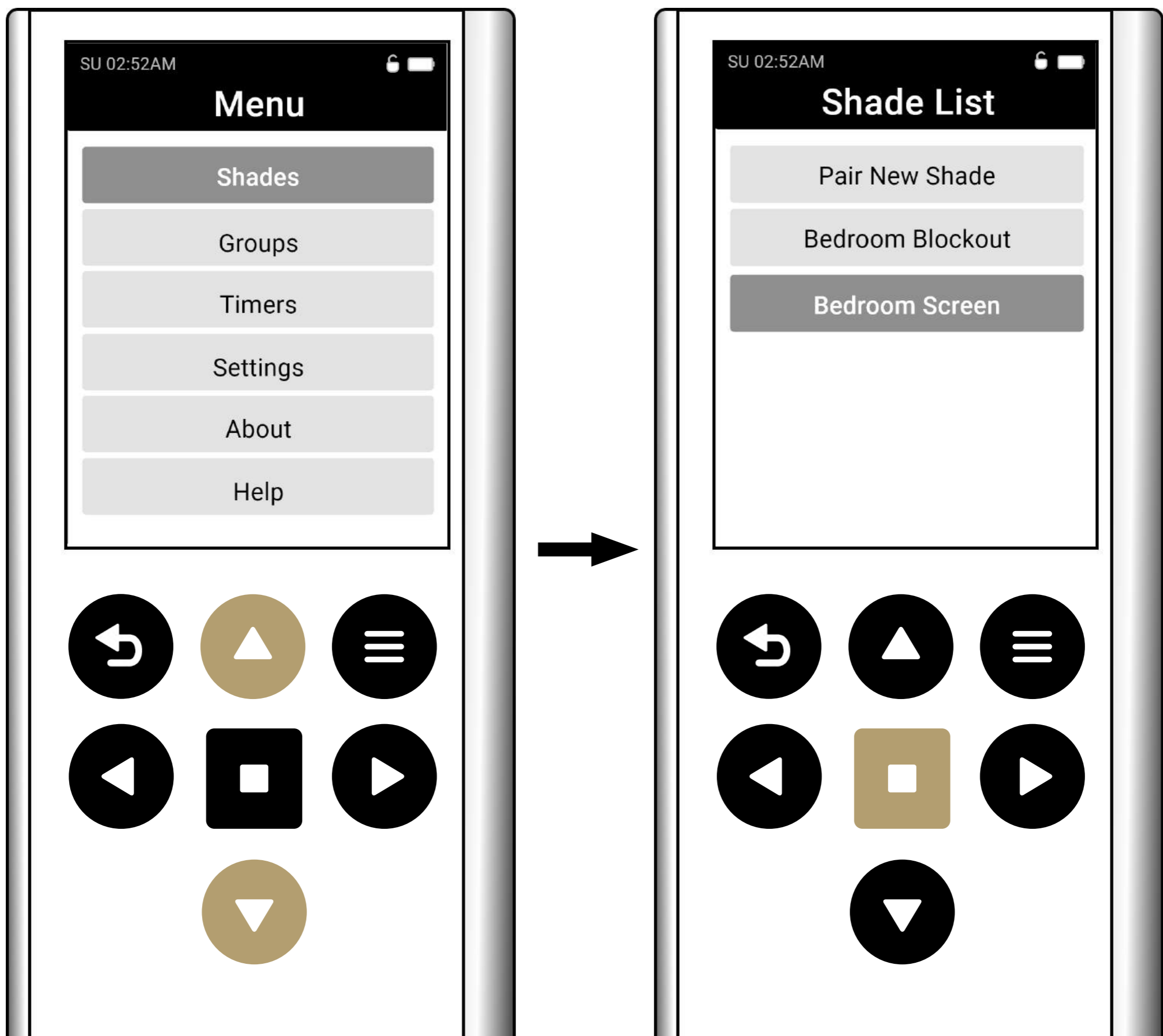

Select Edit name and follow the on-screen information.

Left/Right   - Moves cursor position

Up/Down   - Cycle Characters

Back Button  - Delete character

Stop Button  - OK

Menu Button  - Change case

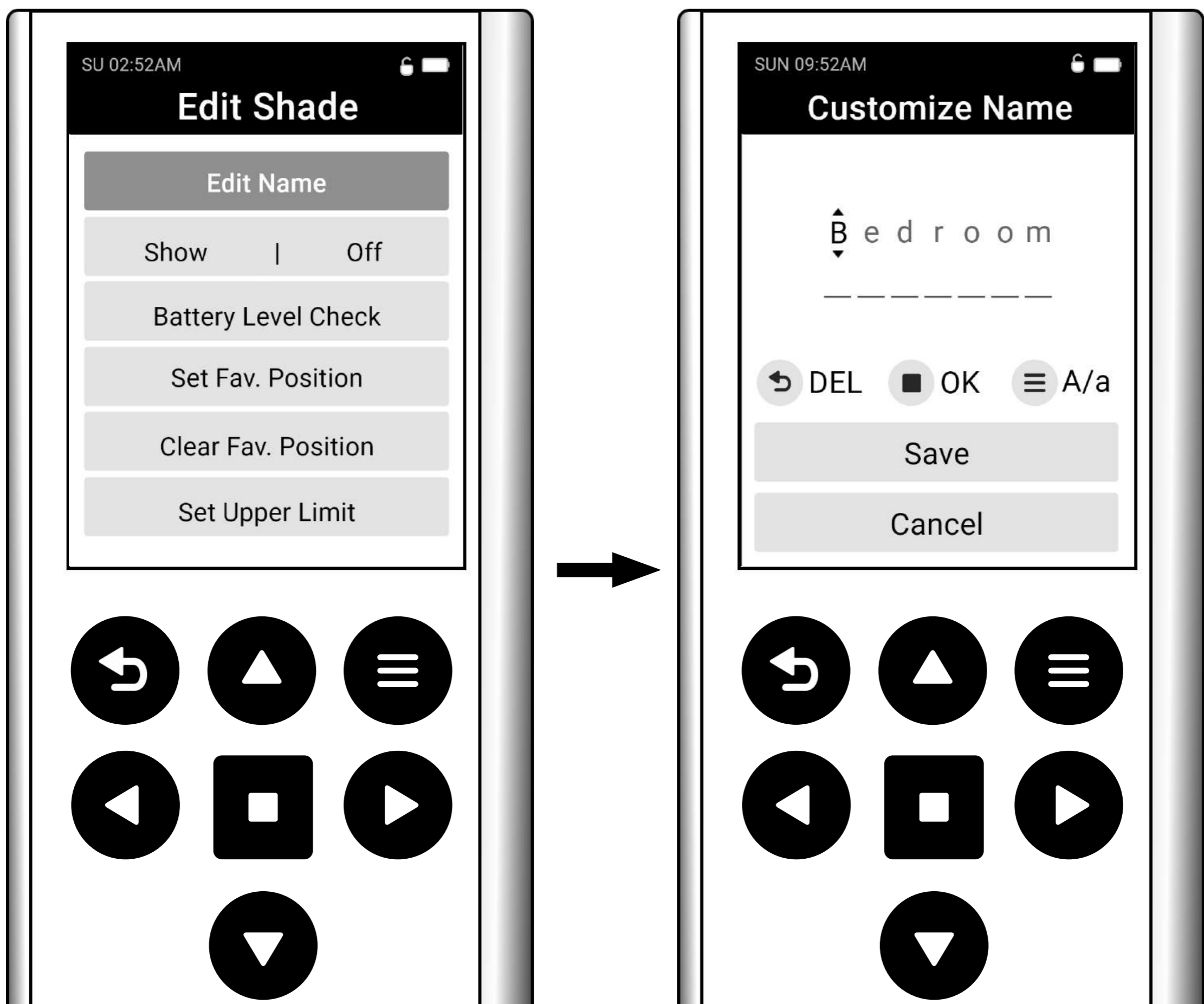

Groups

Groups are logical collections of shades, where multiple shades can belong to multiple groups. These groups can be organized by room or assigned custom group names according to your preference.'

Press the menu button on the remote. Select "Groups," then press the Enter button.

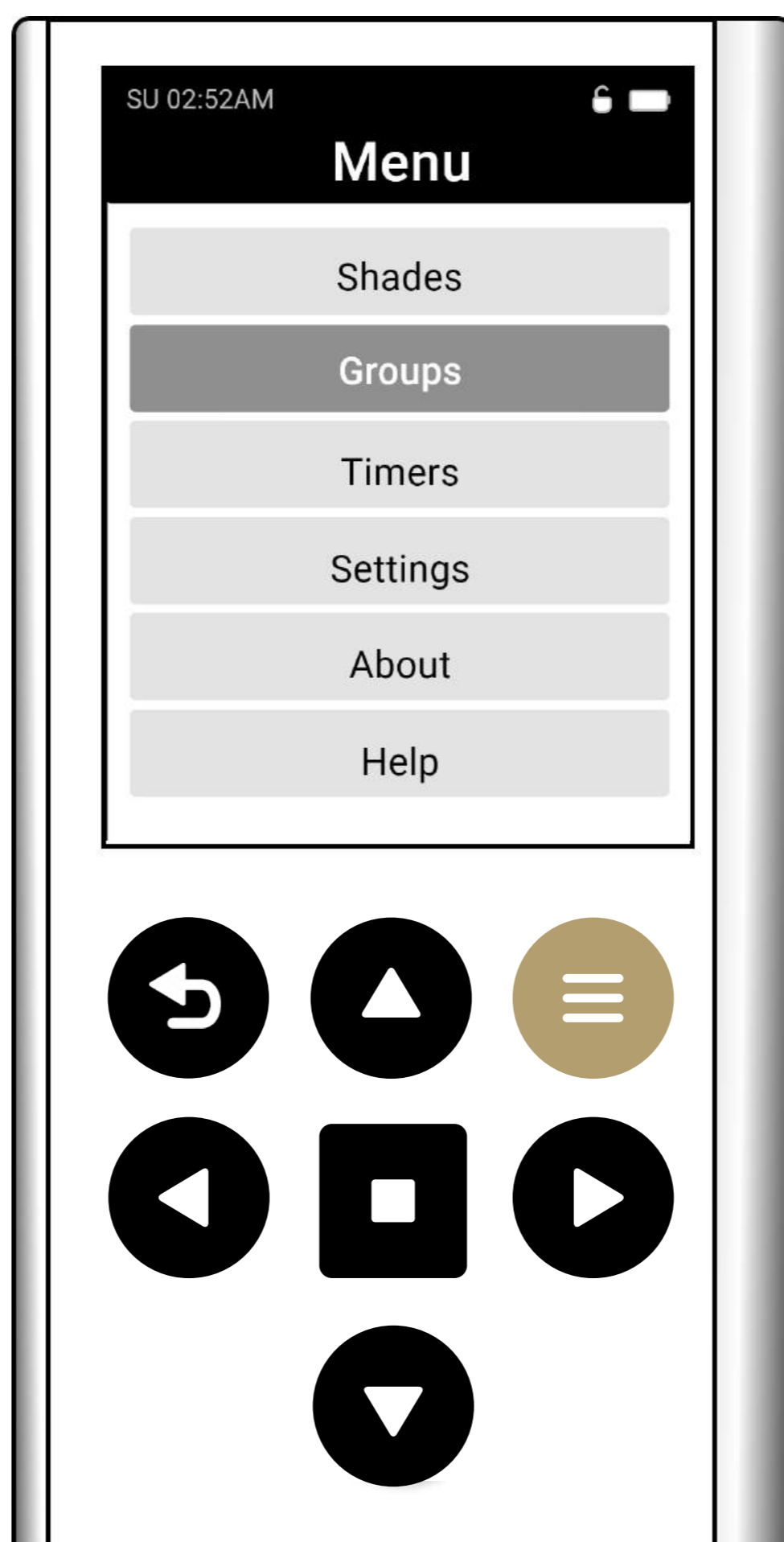

Adding a New Group

Select the Add Group option and press the Enter button. If you have already created a Group previously, the Add Group option will be at the bottom of the list.



Naming a Group

To create a personalized group name, choose the Custom option. The name can include up to 15 alphanumeric characters.

Left/Right ◀ ▶ - Moves cursor position

Up/Down ▲ ▼ - Cycle Characters

Back Button ↶ - Delete character

Stop Button ■ - OK

Menu Button ≡ - Change case

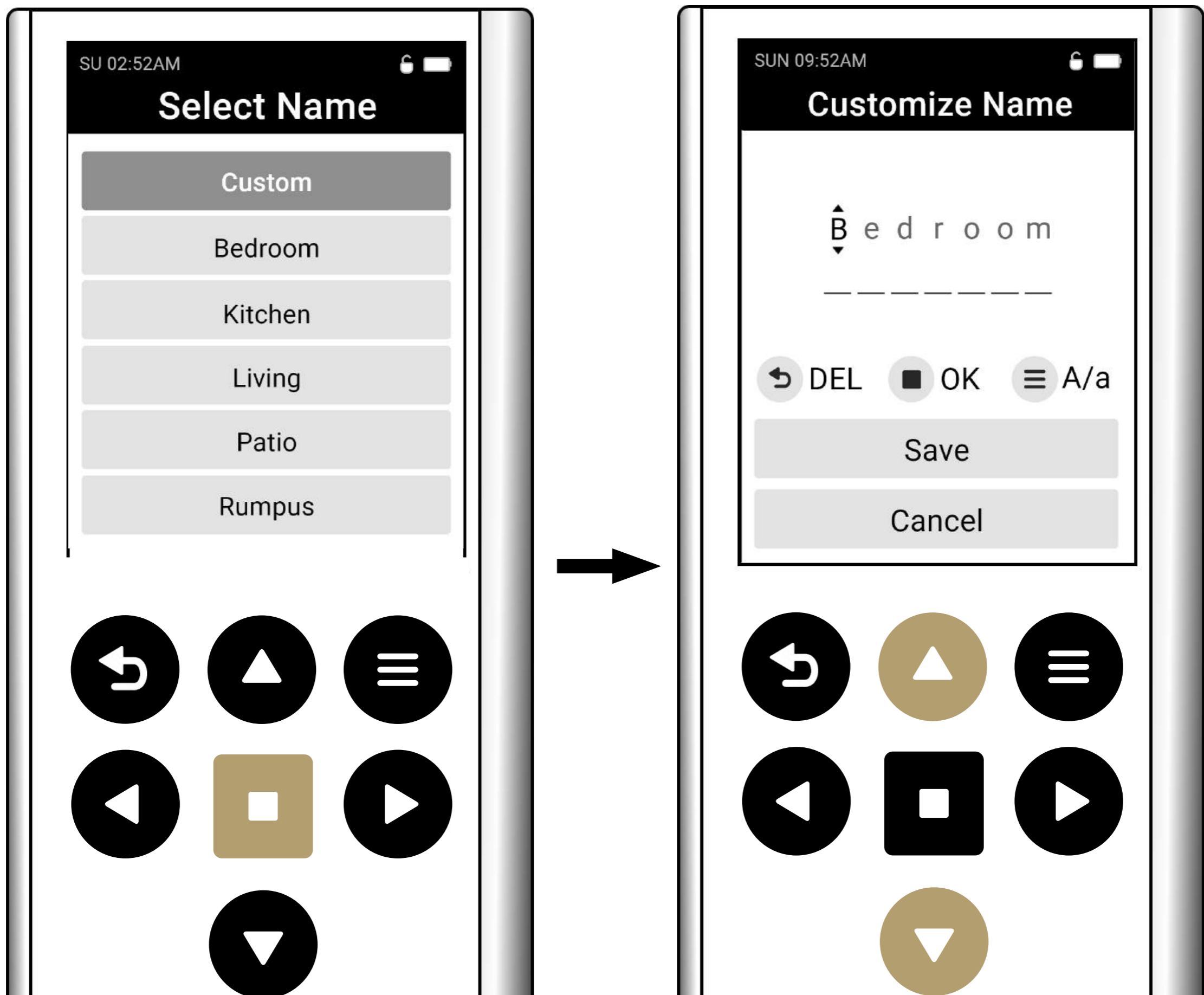

To select a predefined group name, choose from the list and press Enter. You'll also have the option to edit the name at this point. Click Save to proceed.

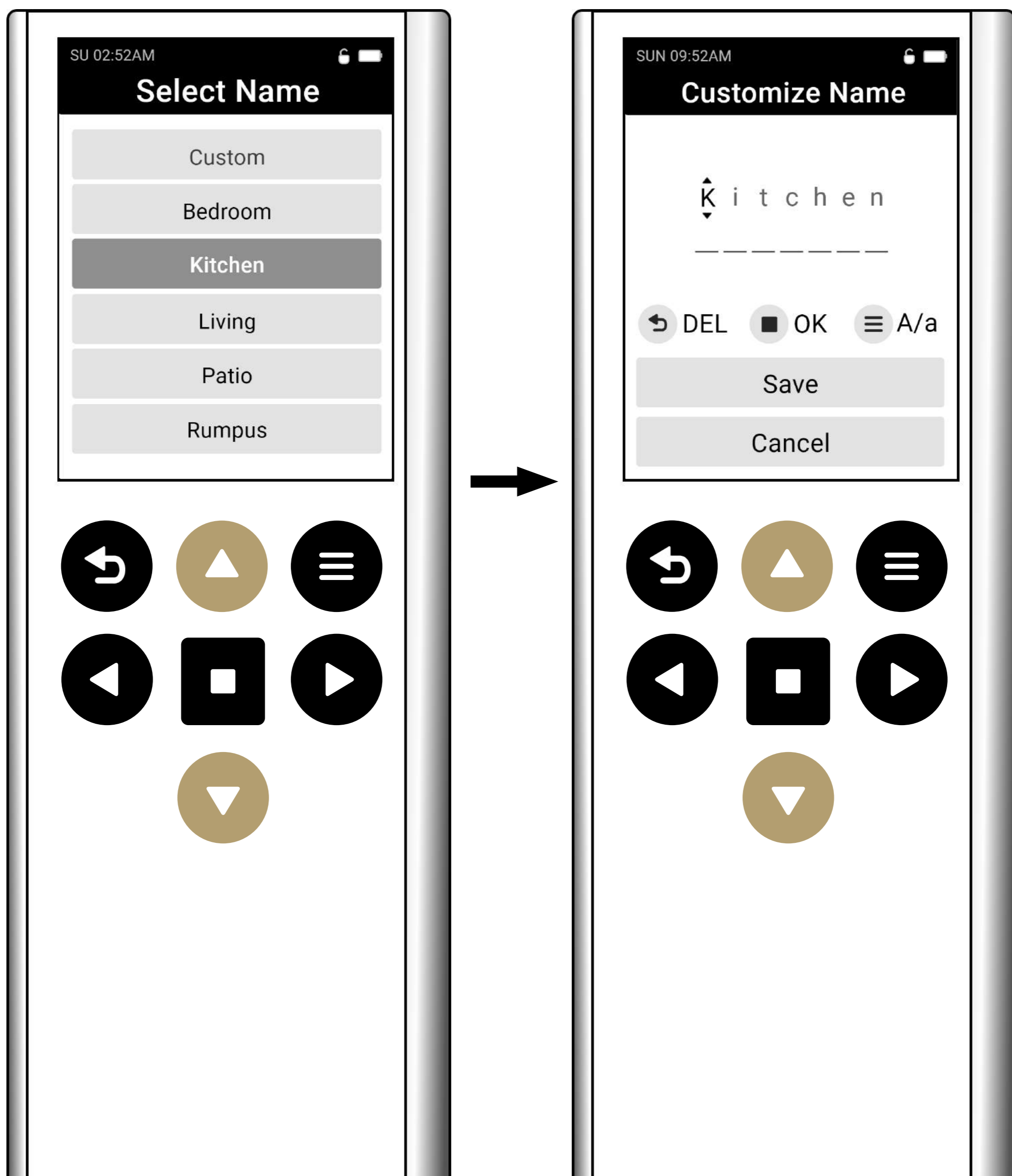

Assigning Shades to a Group

Your shades will be listed on screen. Select each shade you want to include in the group by highlighting it and pressing the Enter button.

A bullet will appear next to each shade assigned to the group.



Settings are saved automatically.
Press the Back button to go back to the previous screen once you're done.
Groups are shown before Shades on the home screen.

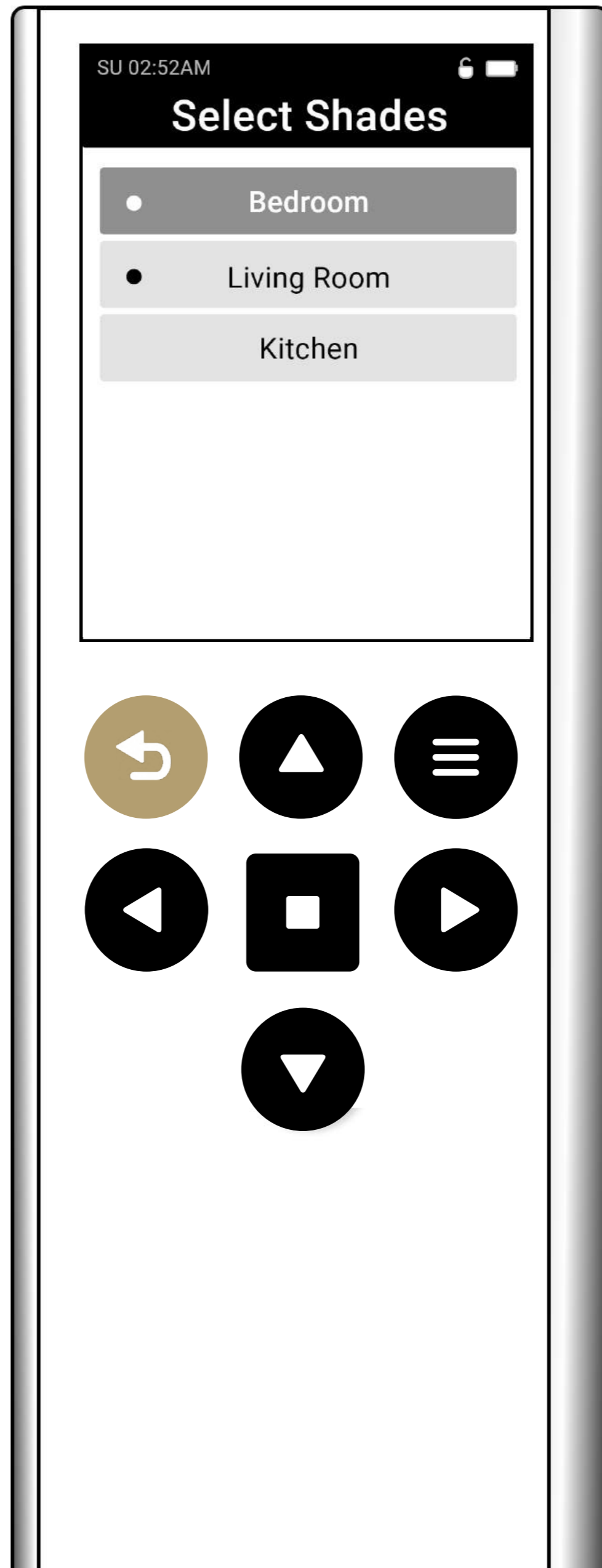

Customizing Shade/Group Visibility

You can customize the visibility of your shades and groups on the main screen. To show or hide a shade and/or group, go to the Shade or Group settings menu by pressing the Menu button on the remote.

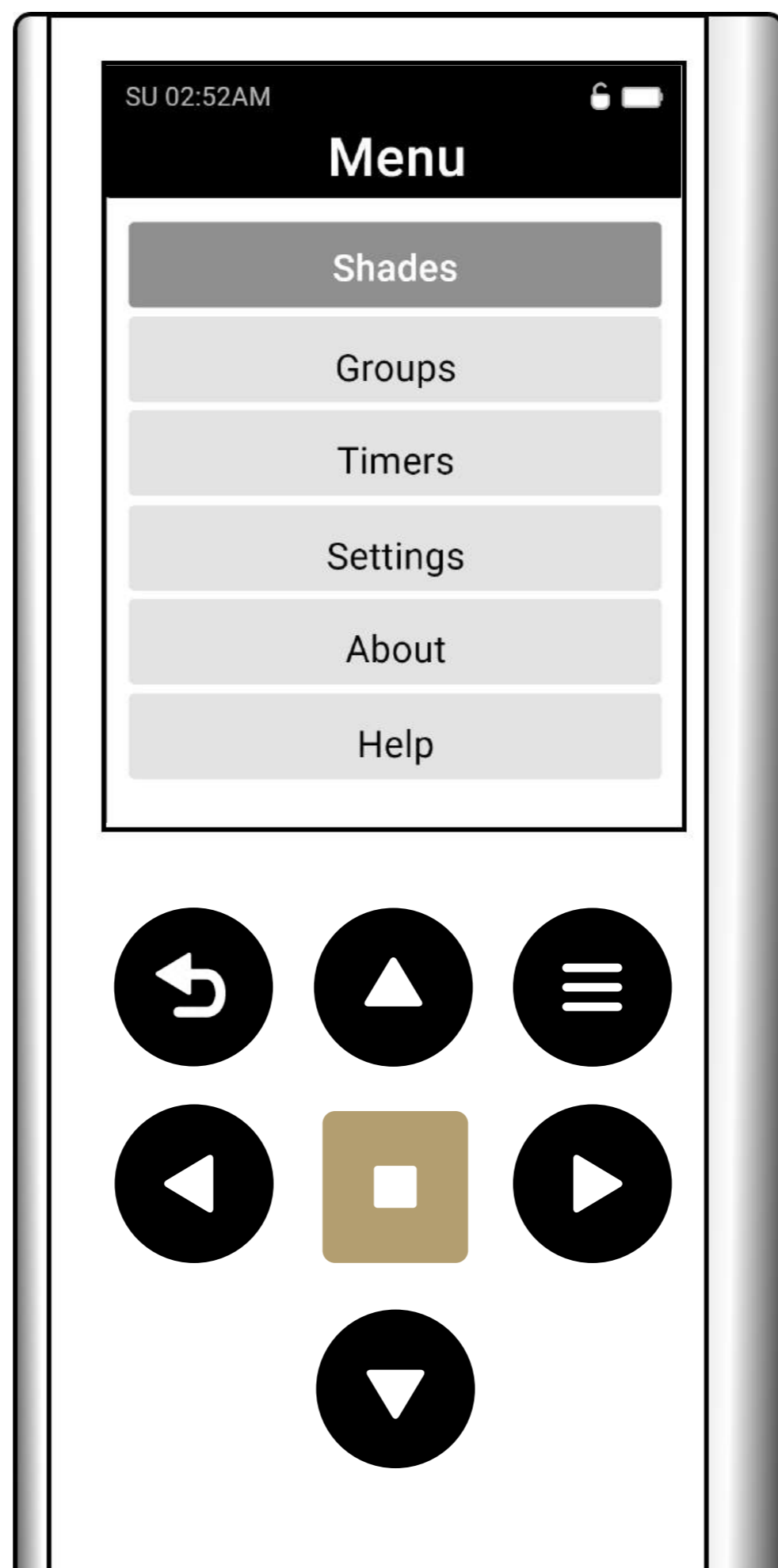

Select either “Shades” or “Groups” then press the Enter button. Select the shade or group you wish to customize.

Show - Yes (visible on home screen)

Show - No (hidden from home screen)

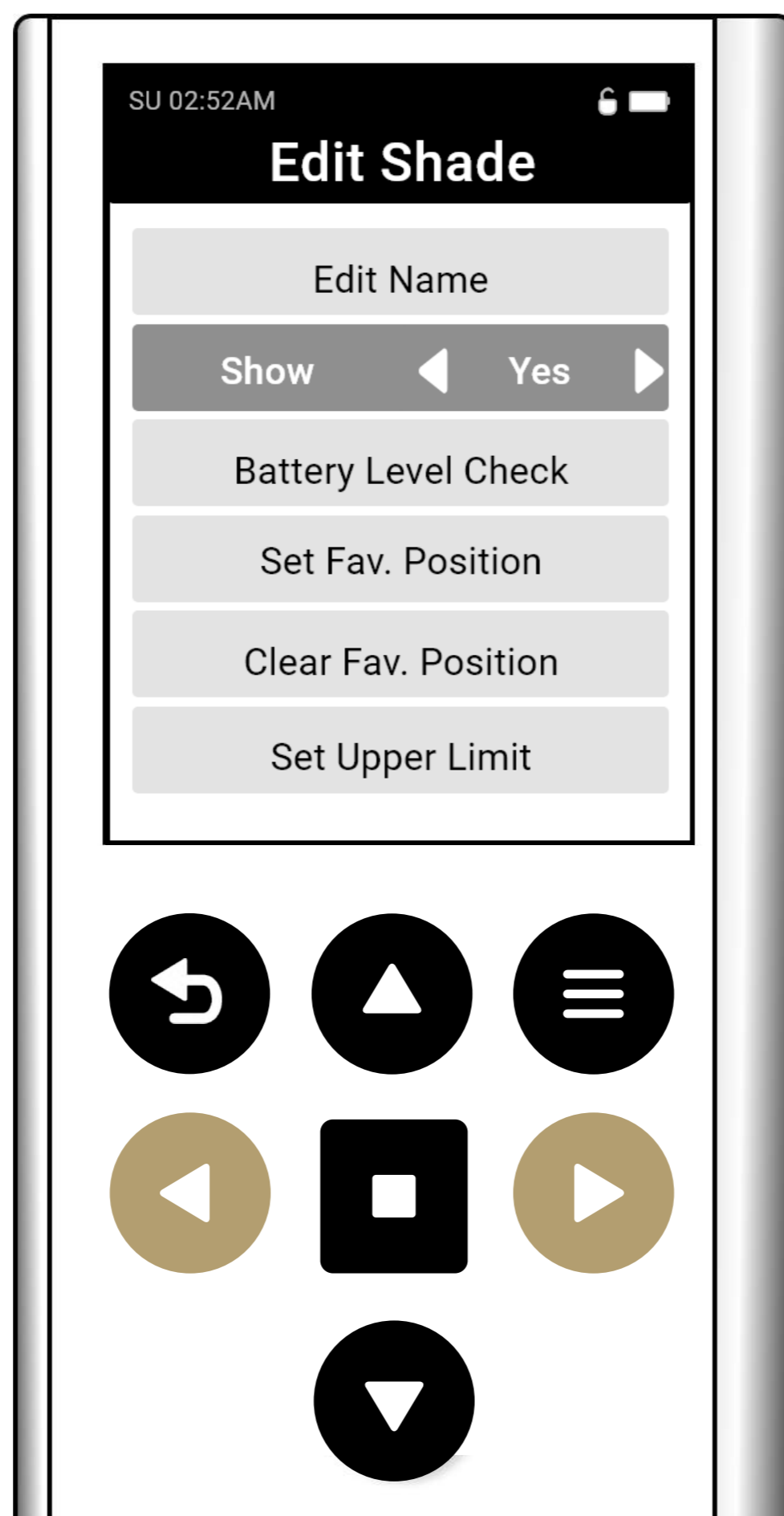

Navigation and Controlling Shades

Your Groups and/or Shades will appear by default on the main screen. Your Groups will be shown before Shades. To cycle through available Groups and Shades, use the Left and Right buttons.



To adjust the height of your shade, press the Up or Down navigation buttons.



To stop your shade at your preferred height, press the Stop button.



Level-Setting Mode

This feature allows you to control your shade or group by percentage. Double-click the Stop button to activate the shade Level-Setting mode. Then, use the Up and Down buttons to adjust the desired shade percentage.

100% refers to the shade being fully closed.

To exit the Level-Setting mode, double click the stop button again or press the back button.



x2

Favorite Position

This allows you to control your shade and/or groups, moving them to their preset Favorite position.

On the main screen, press and hold the Stop button for 5 seconds to adjust your shade to its favorite position. If you're using this in a group, you'll need to individually configure the favorite position for each shade in the group. Any shades without a favorite position set will remain inactive.

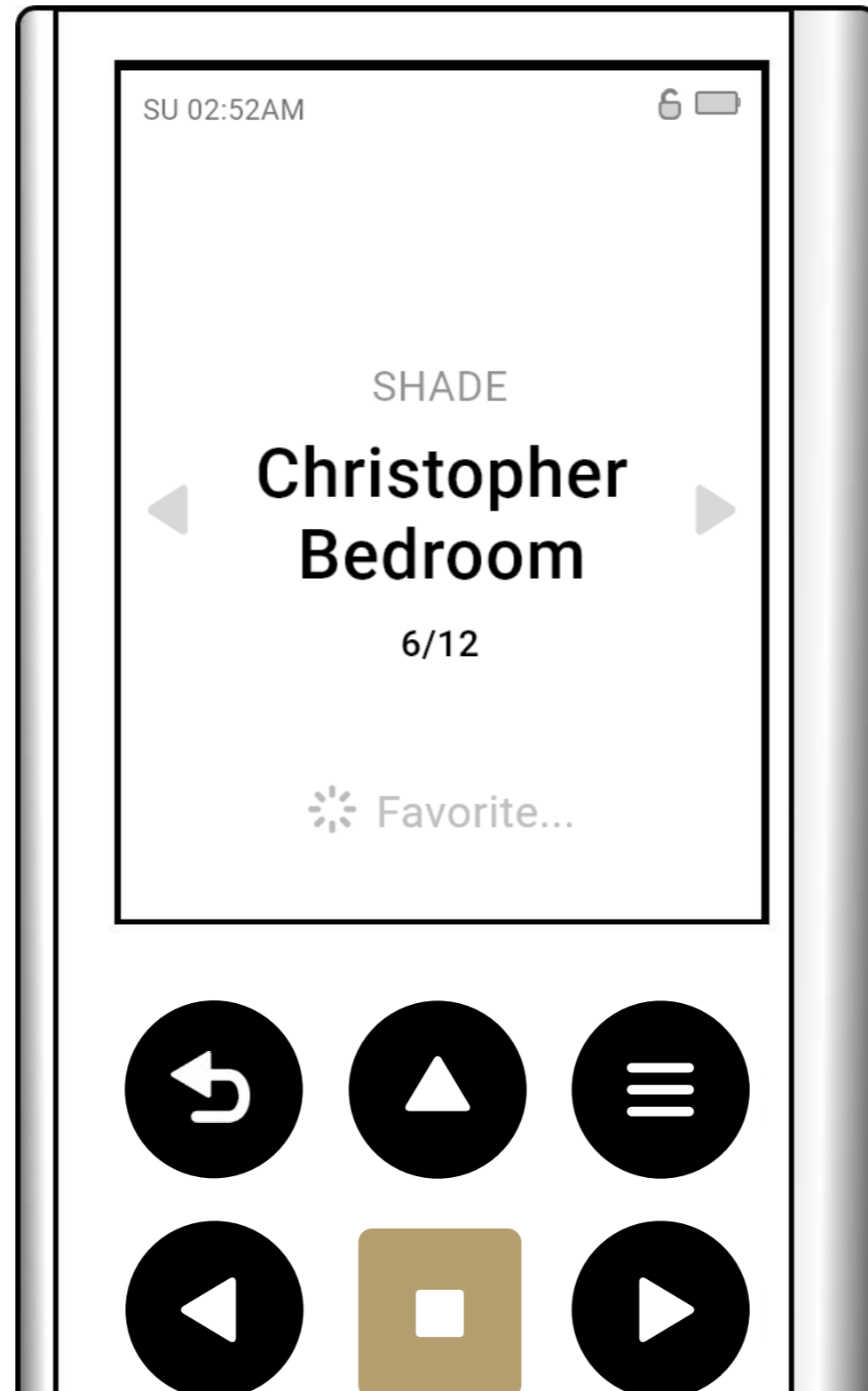

Timers Automation

The Timer function allows you to set automatic behaviors for your shades and groups, such as opening, closing, or moving to your favorite position.

Press the Menu button on the remote. Select “Timers,” then press the Enter button.

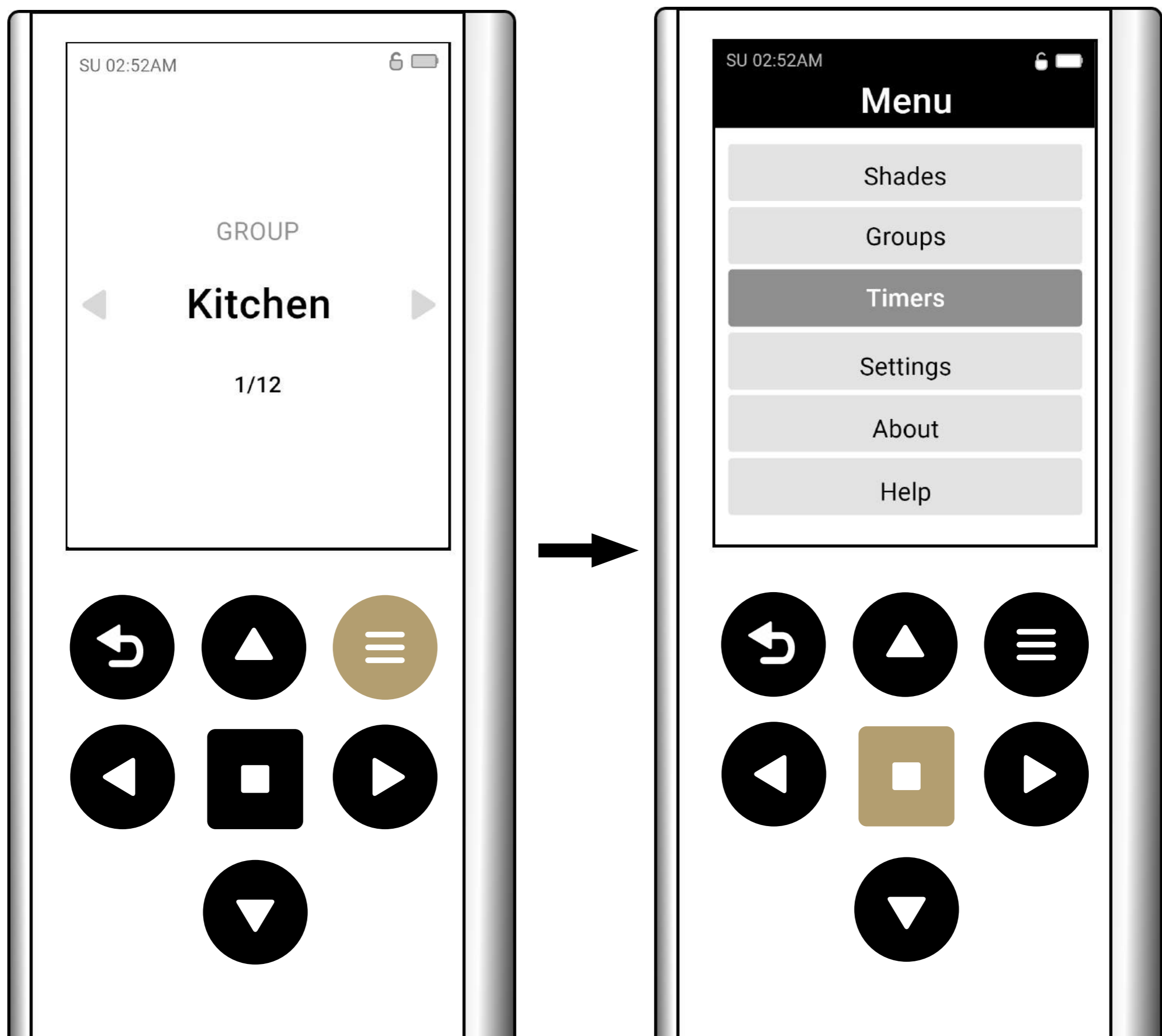

Select Add Timer and adjust the on-screen settings to your preference.

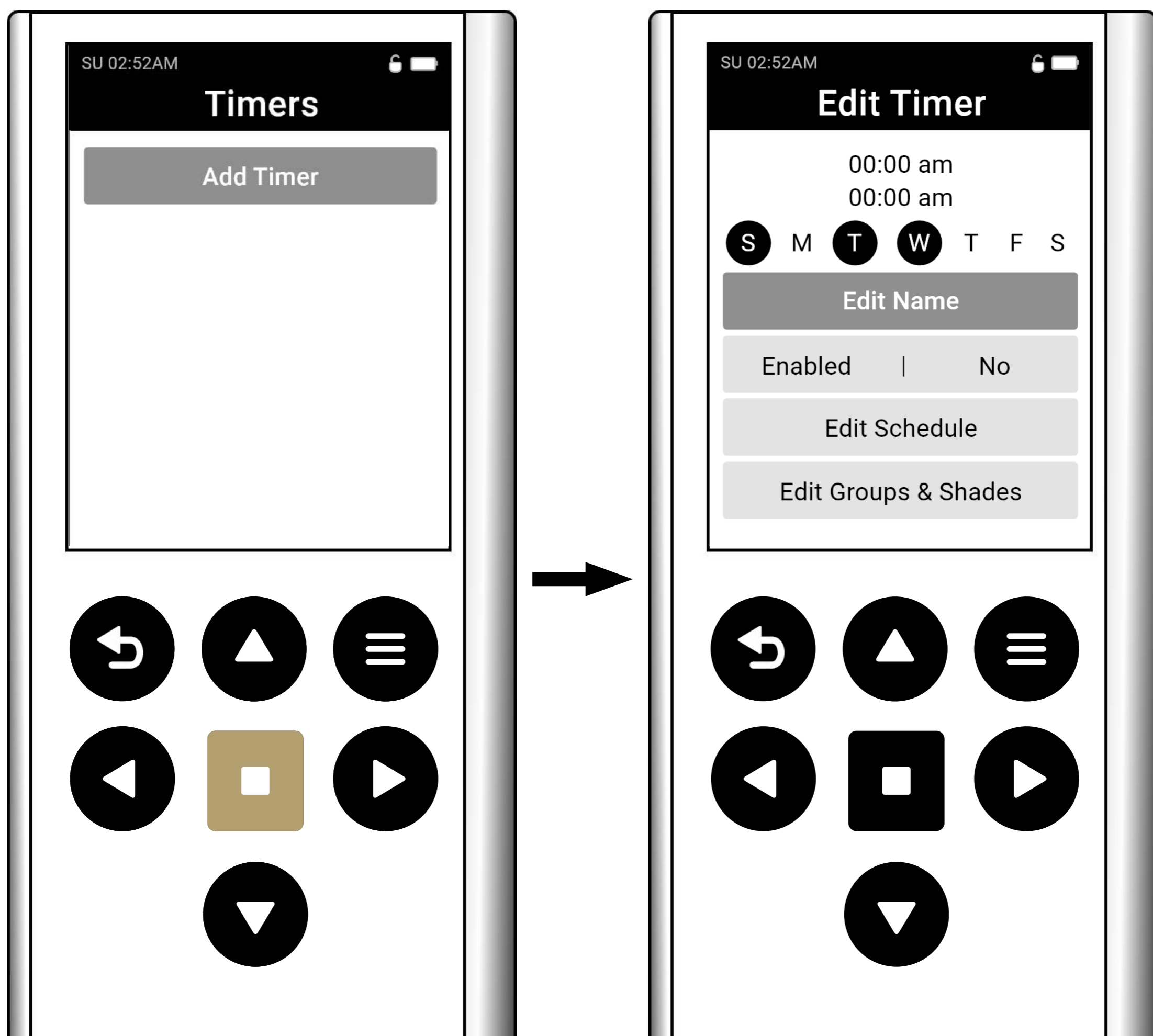

Edit Name - Modify the name of the Timer

Enabled (Yes/No) - Enable or disable the Timer

Edit Schedule - Choose the day(s) you want the timer to operate.

Edit Groups & Shades - Choose the Groups & Shades included in the Timer.

Edit Behavior 1 – Modify behavior (favorite, open/close/open %)

Edit Time 1 – Set activation time

Edit Behavior 2 - Modify behavior (favorite, open/close/open %)

Edit Time 2 - Set activation time

Note: Each Timer can have up to 2 behaviours and times. For example, a morning routine might include your shades opening in the morning and closing before the midday sun.

Remote Settings

You can customize a variety of settings on your remote control.

Press the Menu button on the remote. Select “Remote,” then press the Enter button.

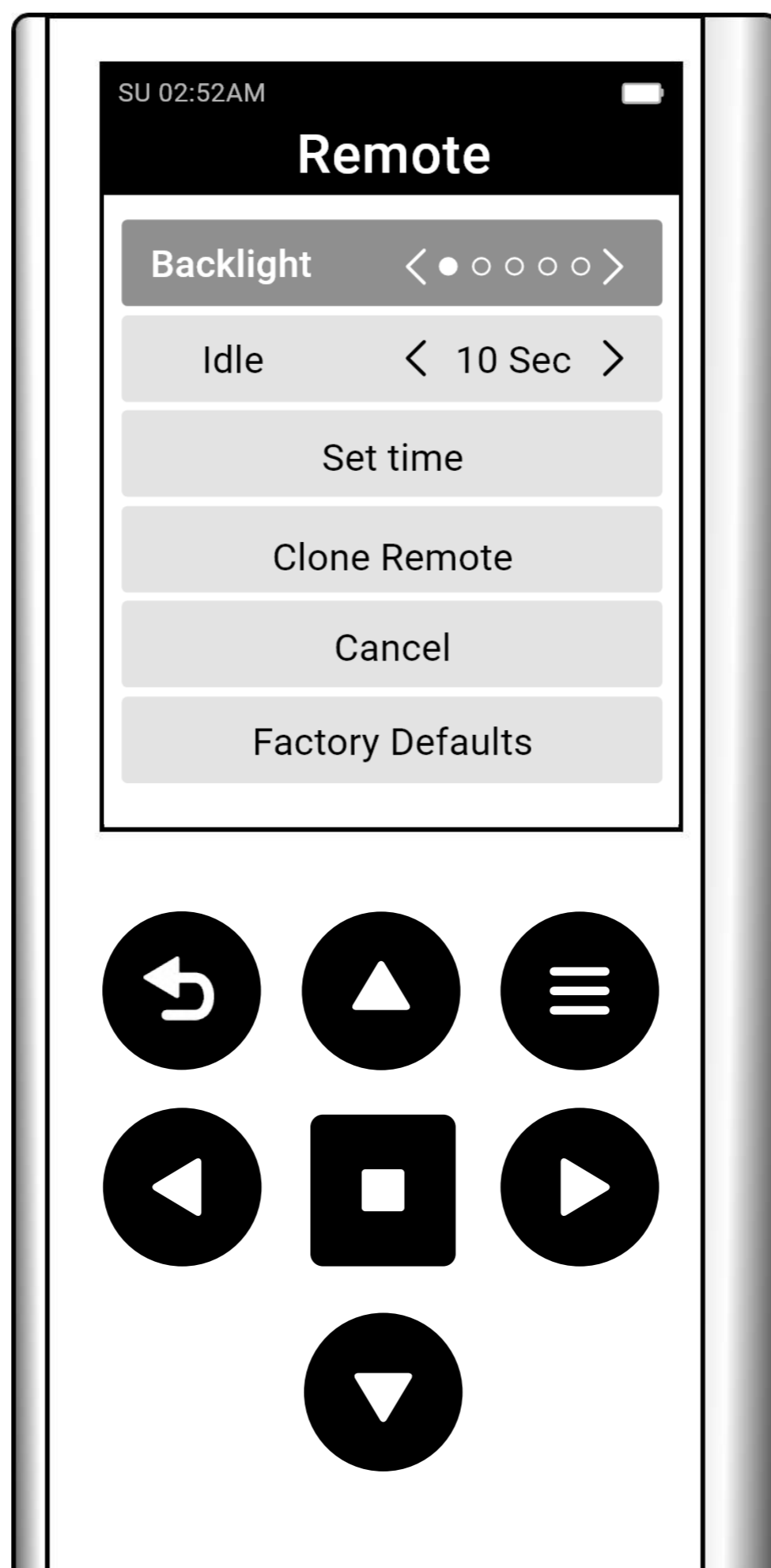

- Backlight – Choose between 5 levels of brightness
- Idle – Set the idle time for the remote display to sleep
- Theme – Choose between light or dark themes
- Set Time – Set the time for the remote
- Smart Wake – Toggle Smart Wake enabled/disabled
- Update – Used for updating the remote's firmware
- Unlock Remote – Unlock the remote to gain access to advanced settings
- Installer Mode (Unlocked Mode only) – Mode to bypass normal step-by-step instructions. Intended for advanced users.
-
- Factory Defaults (Unlocked Mode only) – Reset the remote to factory default settings. Please note all settings and shades will be erased.

Installer Mode

Installer mode enables you to pair and adjust various settings, bypassing the usual step-by-step on screen instructions.

Press the Menu button and select Settings by pressing the Enter button.

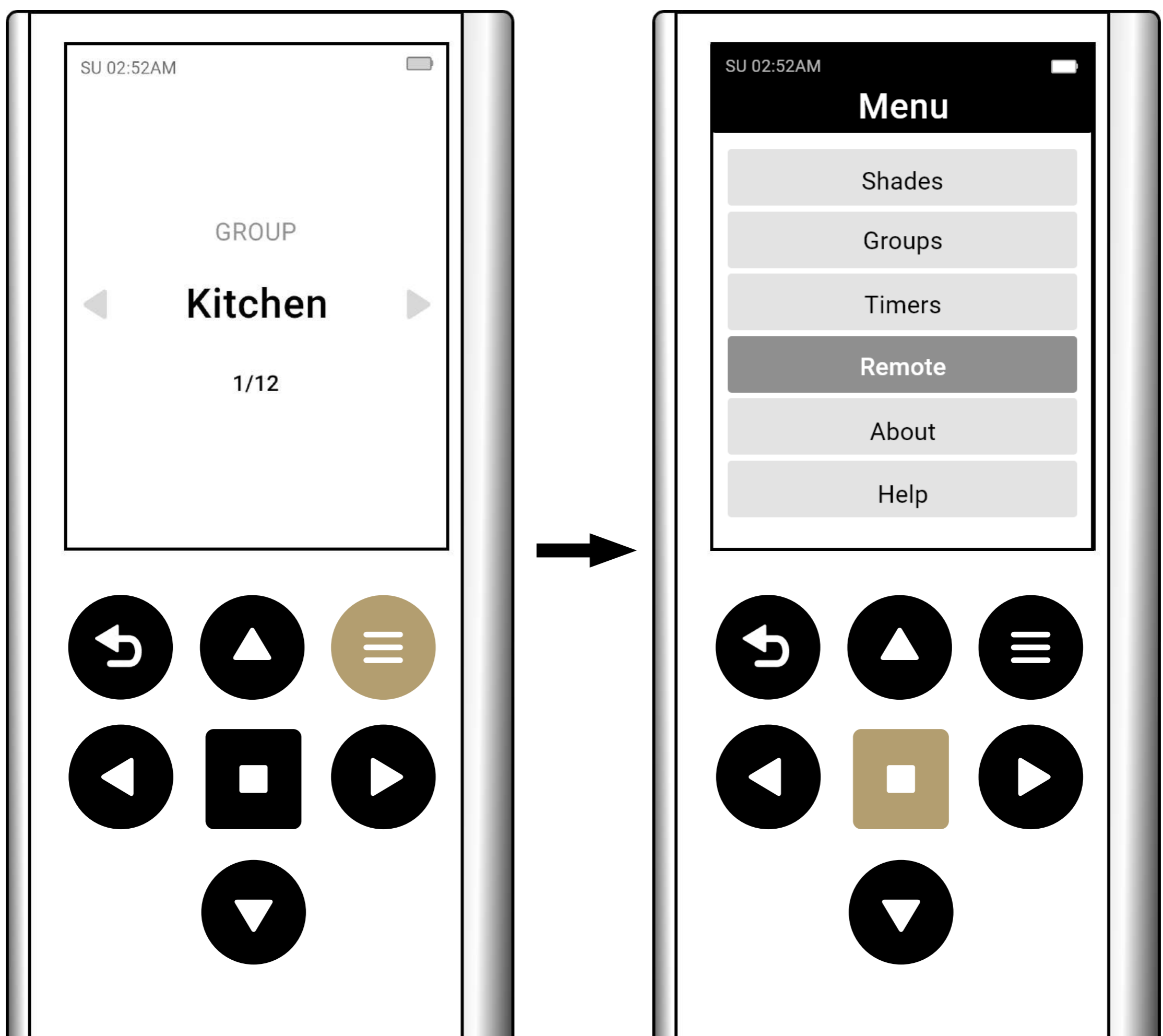

On the Remote Settings screen, Select Installer Mode.

To exit Installer Mode, press the Back button.

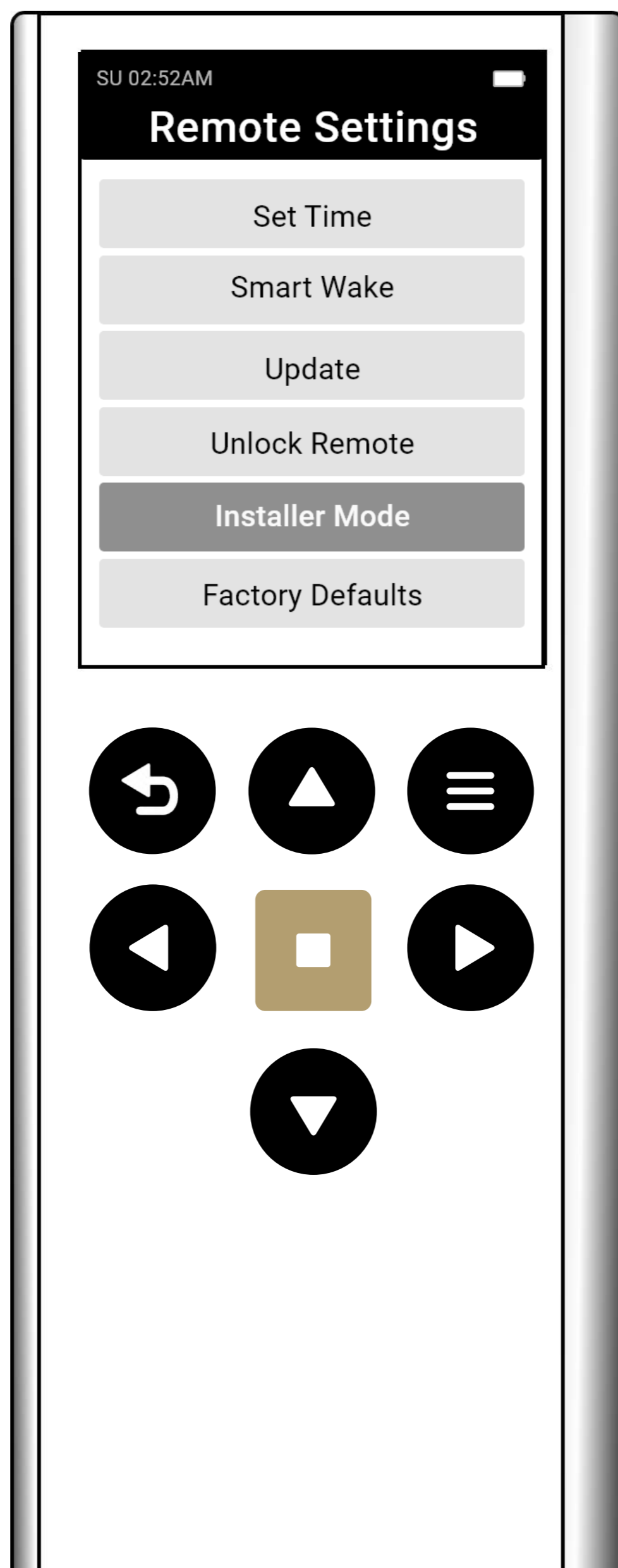

In Installer mode, the menu button is replaced by the P2 button, which is typically used for programming and setup. Here's a general outline of what the P2 button is used for.

1. Programming Limits: Setting the upper and lower limits for the blinds.

2. Pairing and Unpairing Shades: Associating the remote with specific motorized blinds or removing the association.

3. Shade Settings: Adjusting various settings for your shades.

Pairing

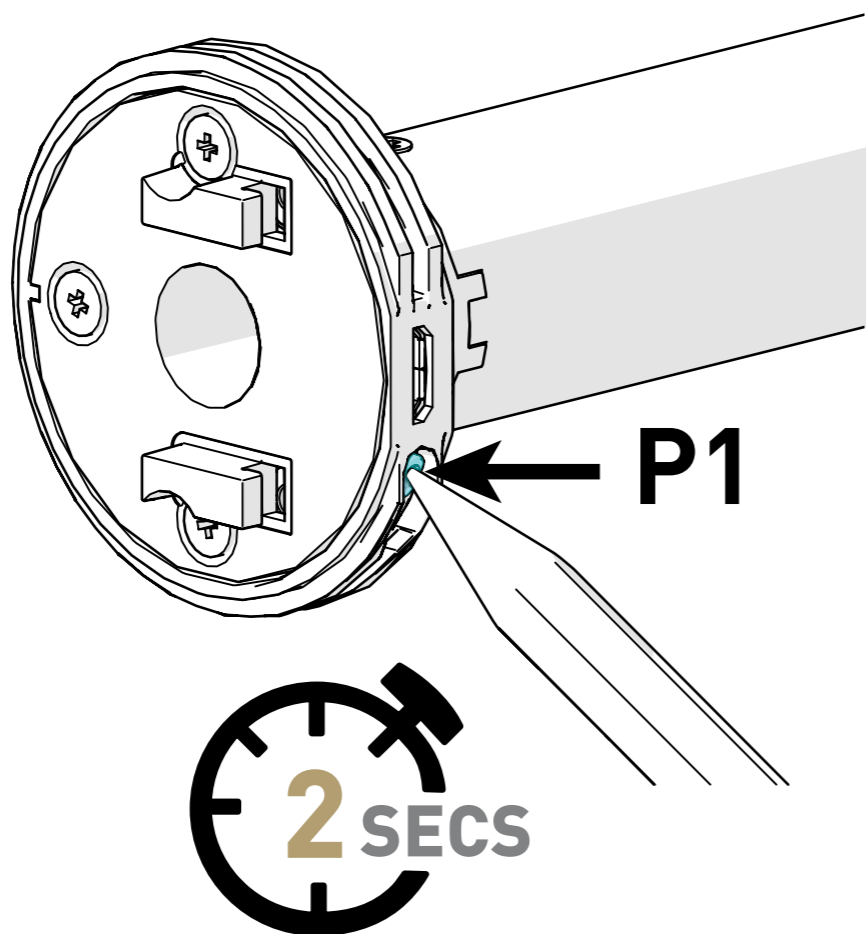

* Internal Tubular Motor pictured.
Refer to "P1 Locations" for specific devices.

Press the P1 button on the motor for 2 Seconds until the motor responds as below.

Using the left and right buttons, navigate to an empty channel marked as "#/30"

MOTOR RESPONSE

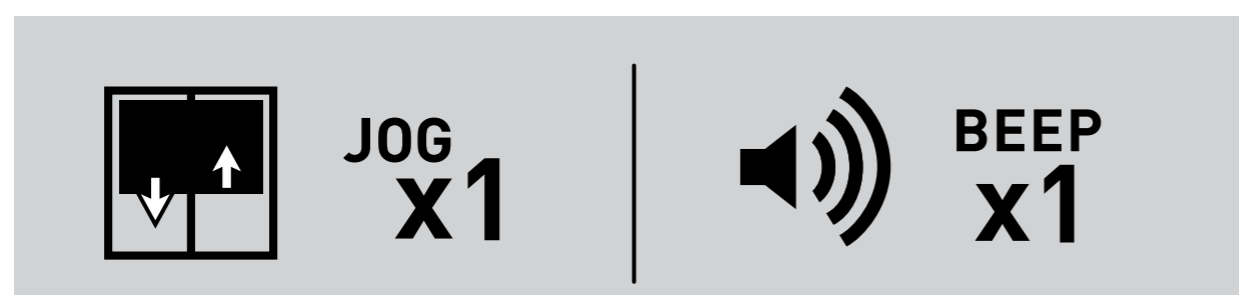

Within 4 secs hold the stop button on the remote for 3 secs. The motor will respond with Jog and Beep.

MOTOR RESPONSE

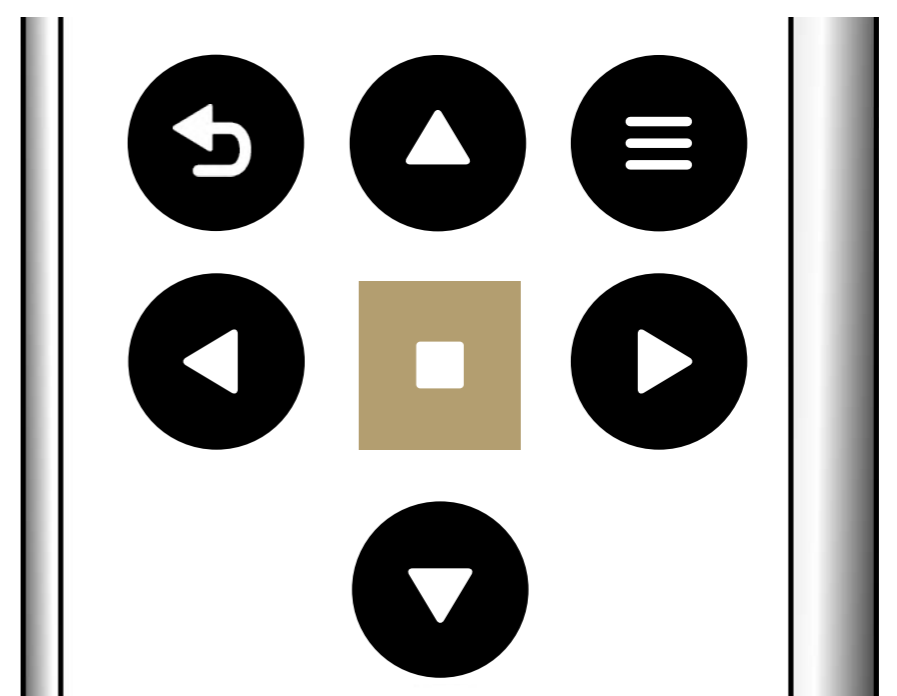
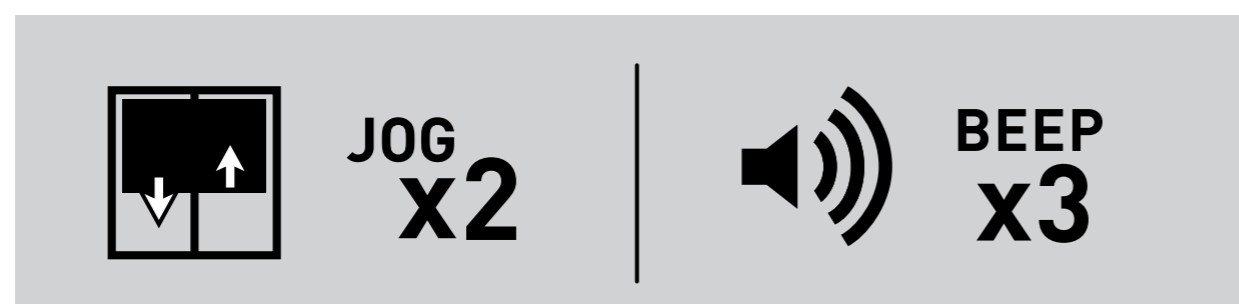

The remote will assign the pairing as "SH##", where ## represents the channel number.

Check Direction

Press Up or Down to check the motor direction.

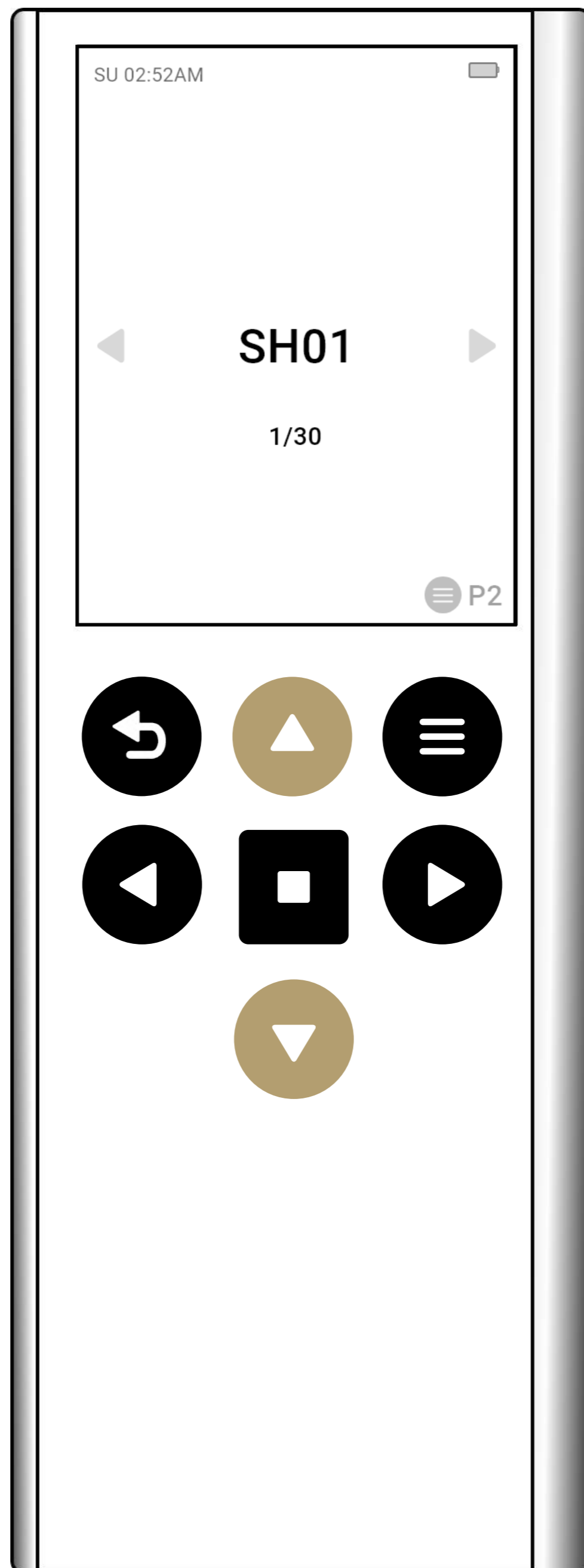

Change Direction

If the shade direction needs to be reversed; press and hold the Up & Down arrow together for 5 seconds until the motor jogs.

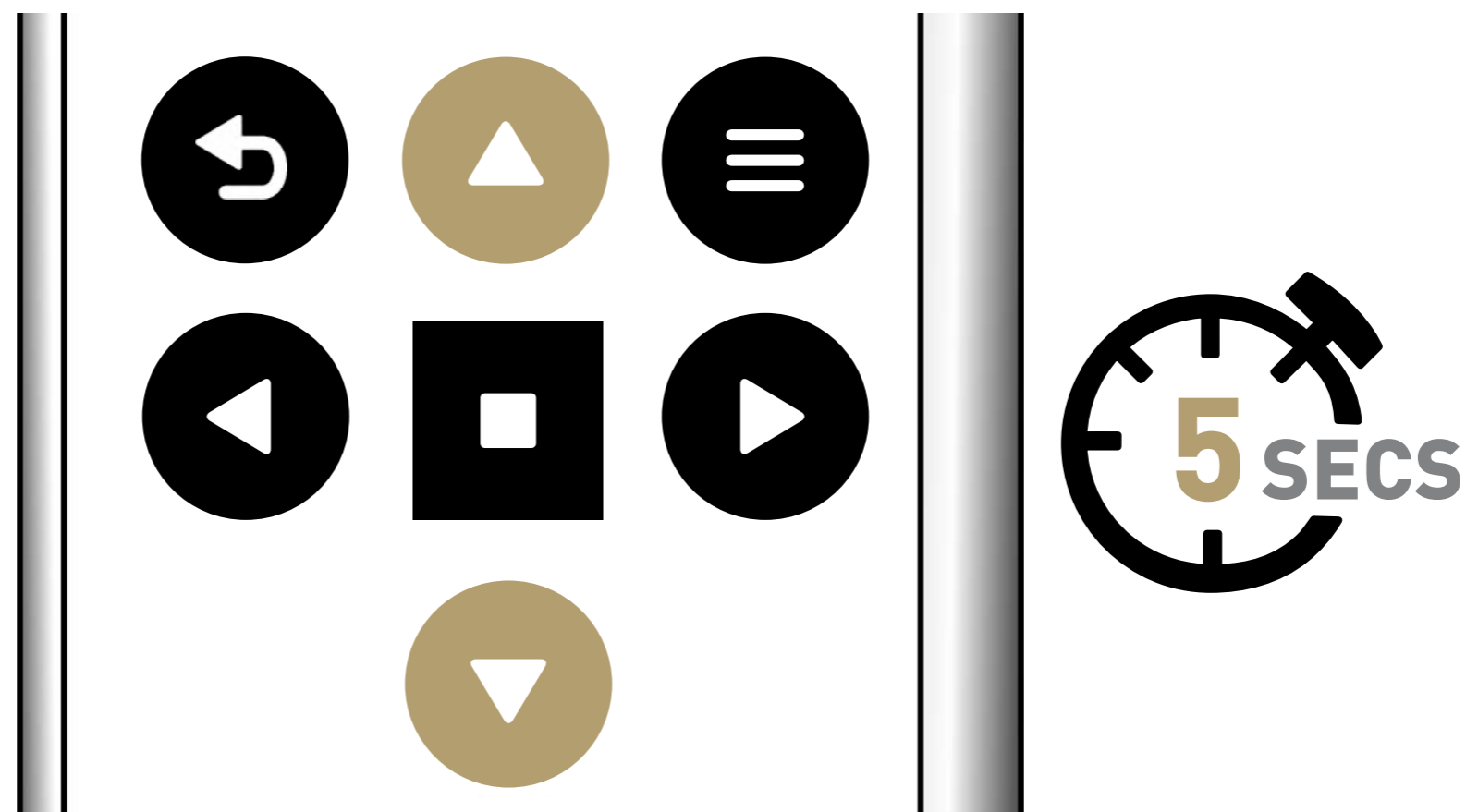

MOTOR RESPONSE

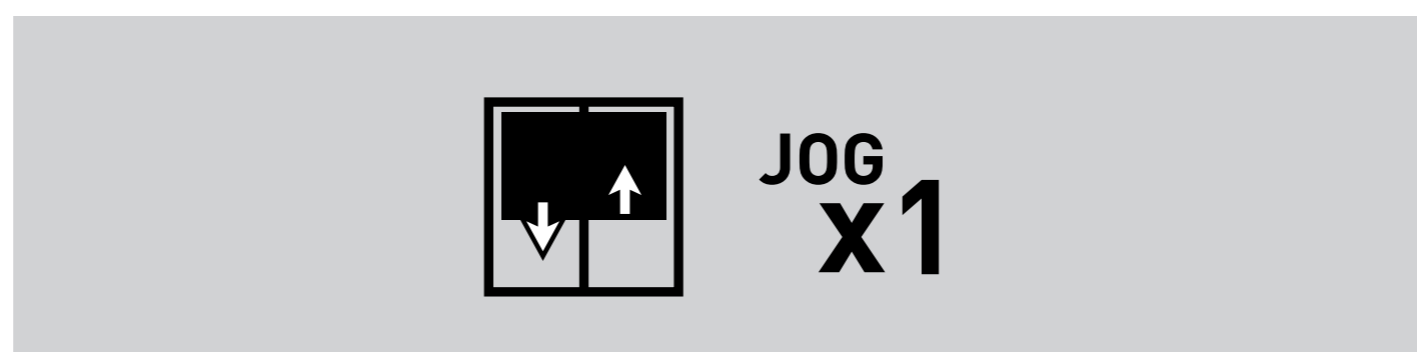

Reversing motor direction using this method is only possible during initial set-up.

Set Top Limit

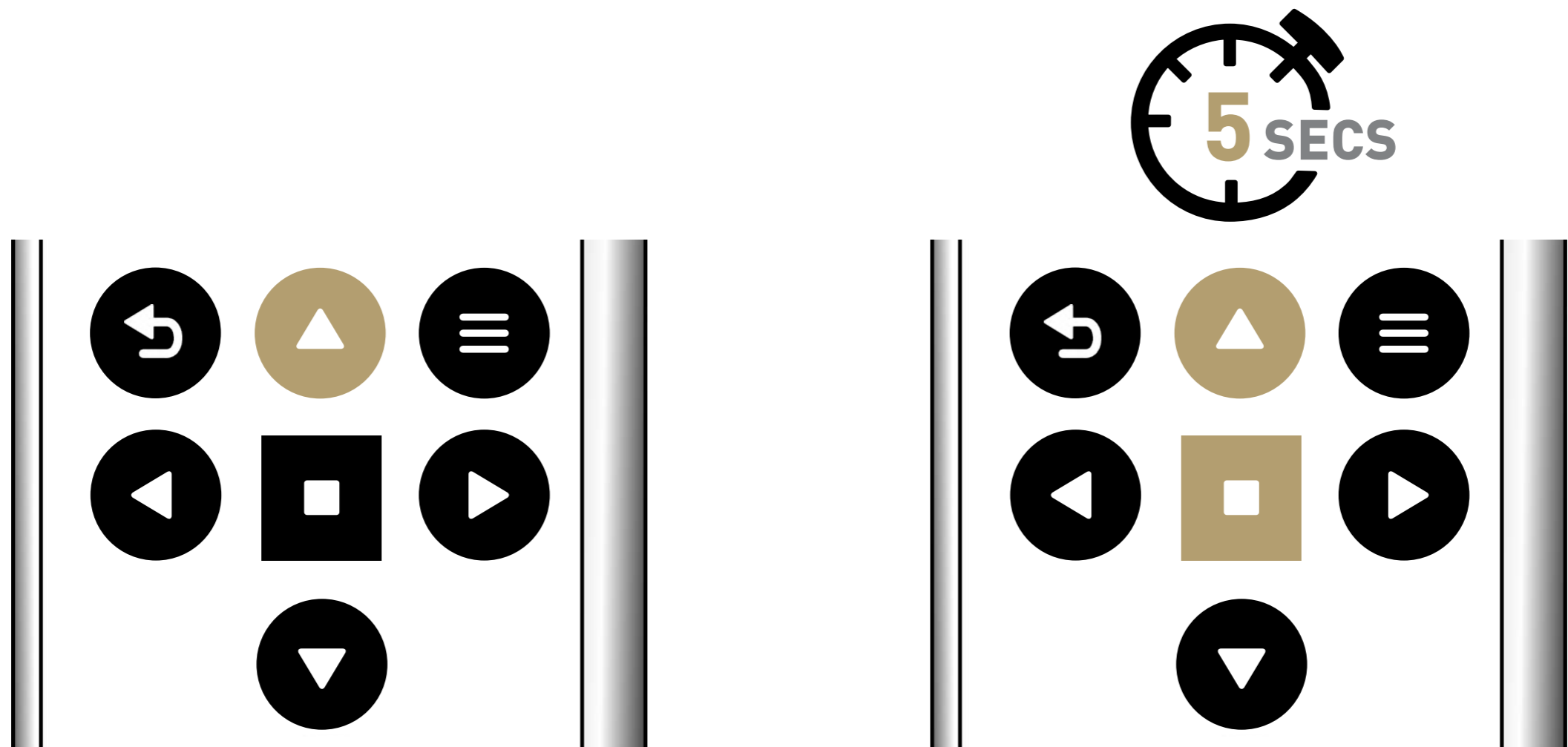

Move shade to desired top limit by pressing the Up arrow repeatedly. Then press and hold Up & Stop together for 5 seconds to save limit.

Tap the arrow several times or hold Down if needed; press arrow to stop.

MOTOR RESPONSE

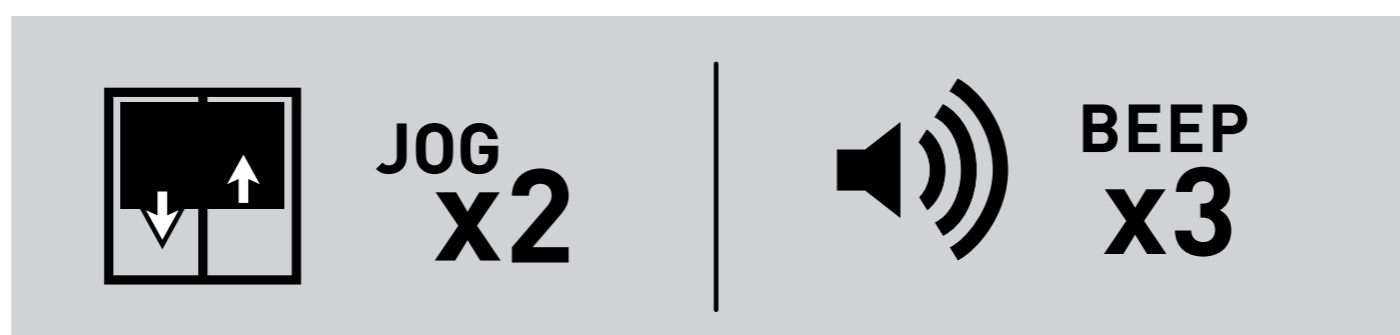

Set Bottom Limit

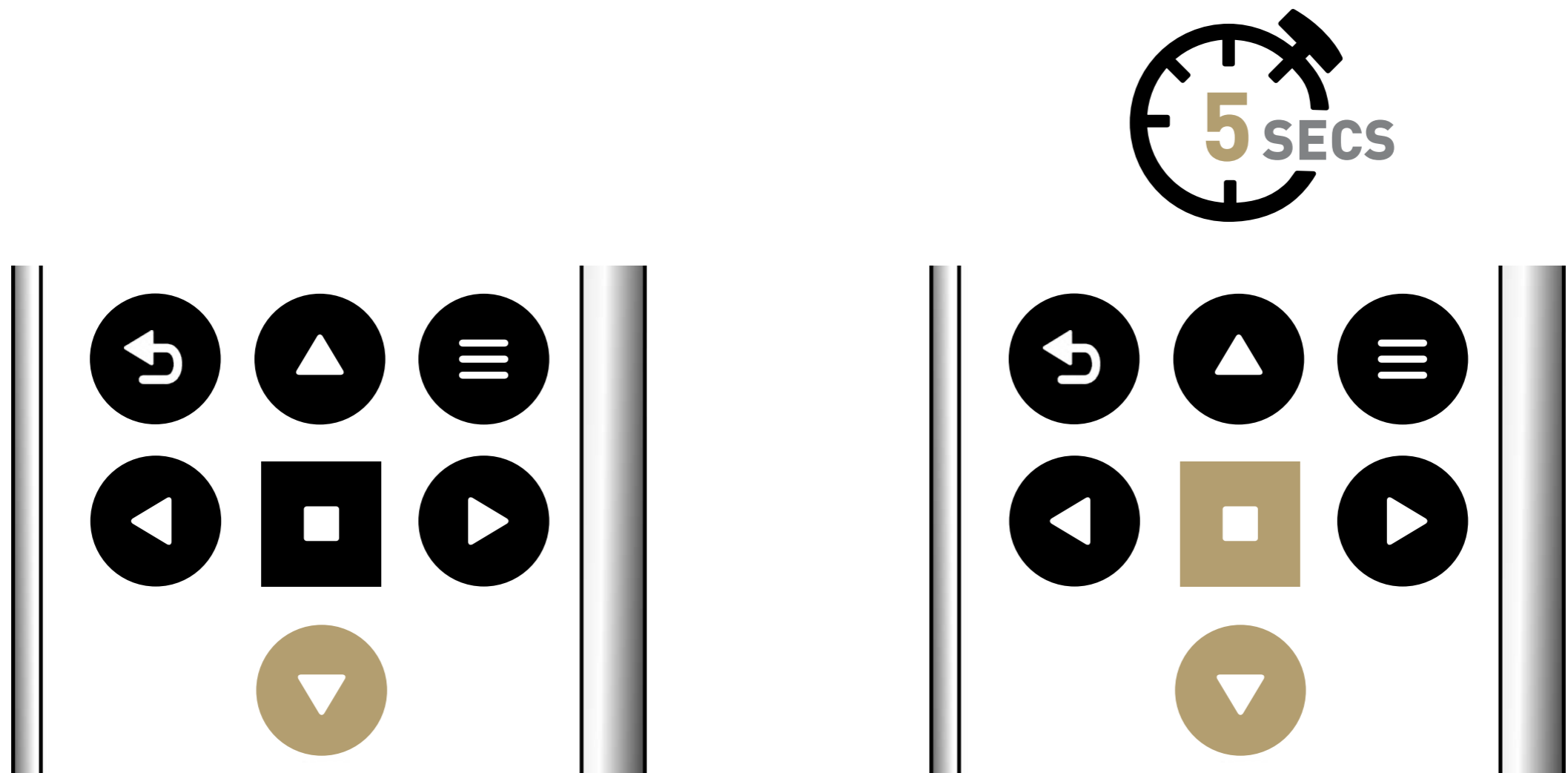

Move shade to desired bottom limit by pressing the Down arrow repeatedly.

Then press and hold Down & Stop together for 5 seconds to save limit.

Tap the arrow several times or hold Down if needed; press arrow to stop.

MOTOR RESPONSE

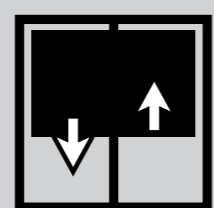

JOG
X2



BEEP
X3

Setting Favorite Position

Move Shade to desired position

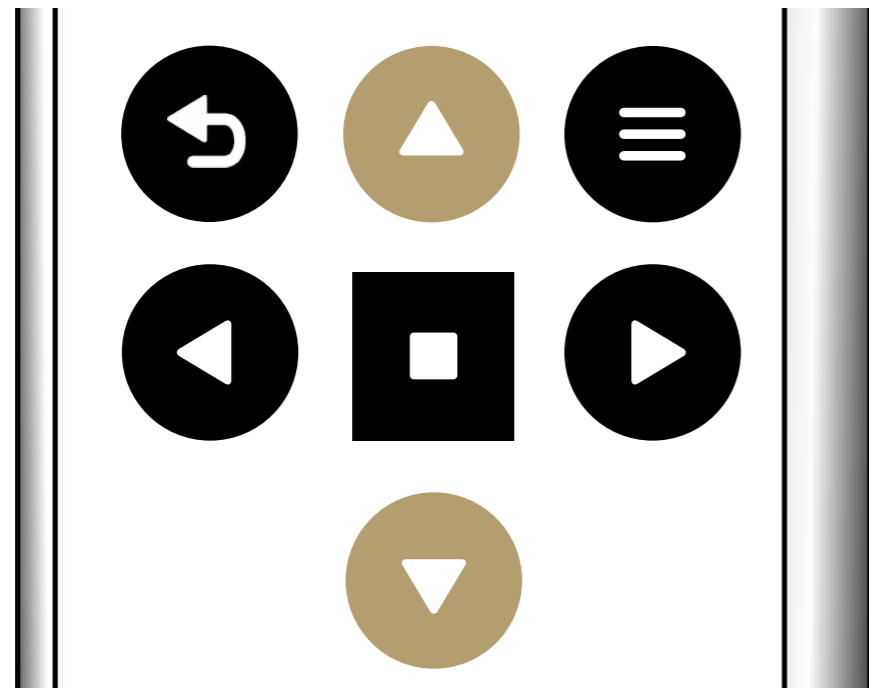

Press P2 on remote

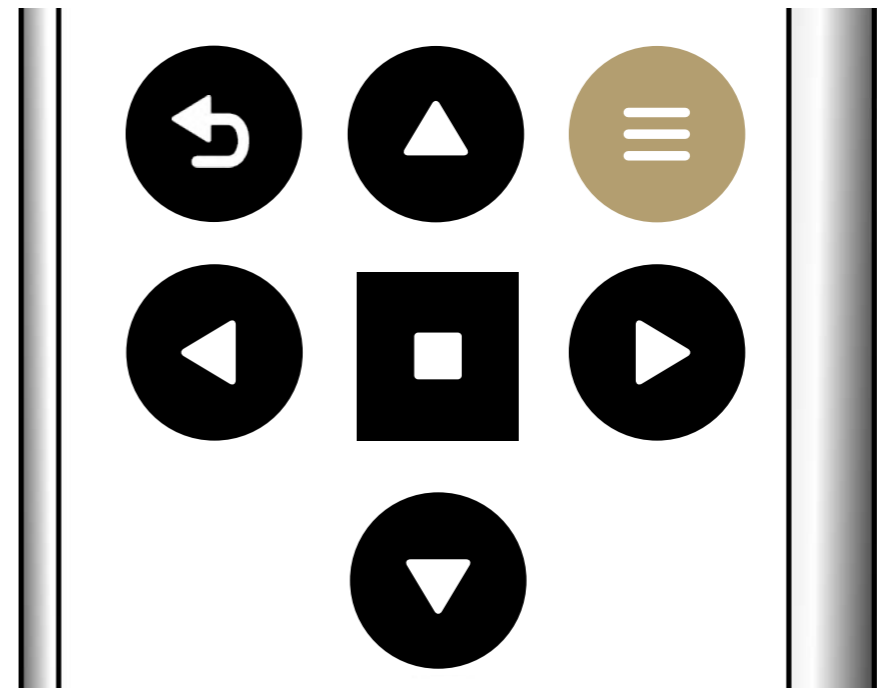

Press STOP on remote

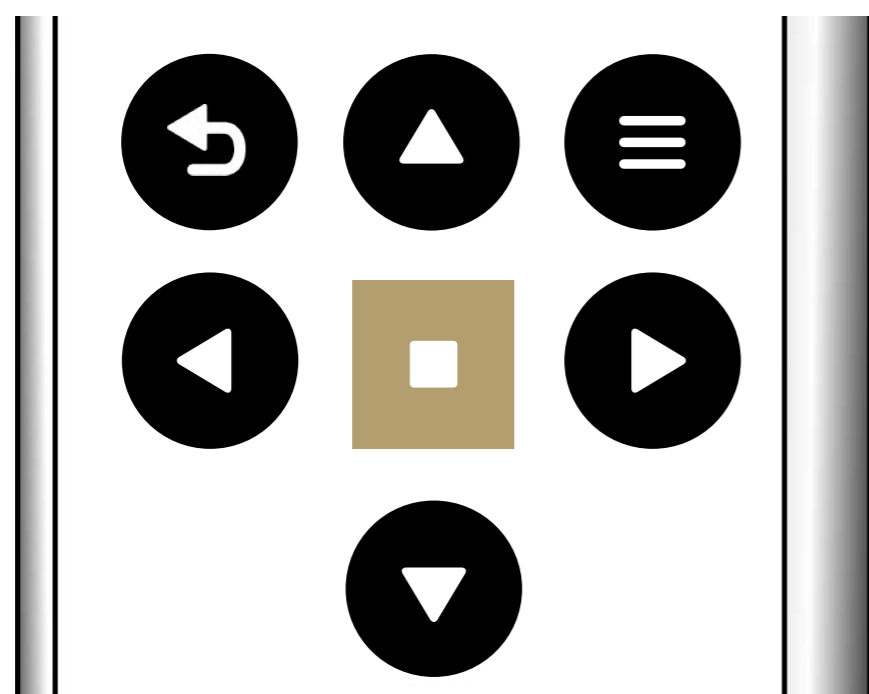

Press STOP on remote again

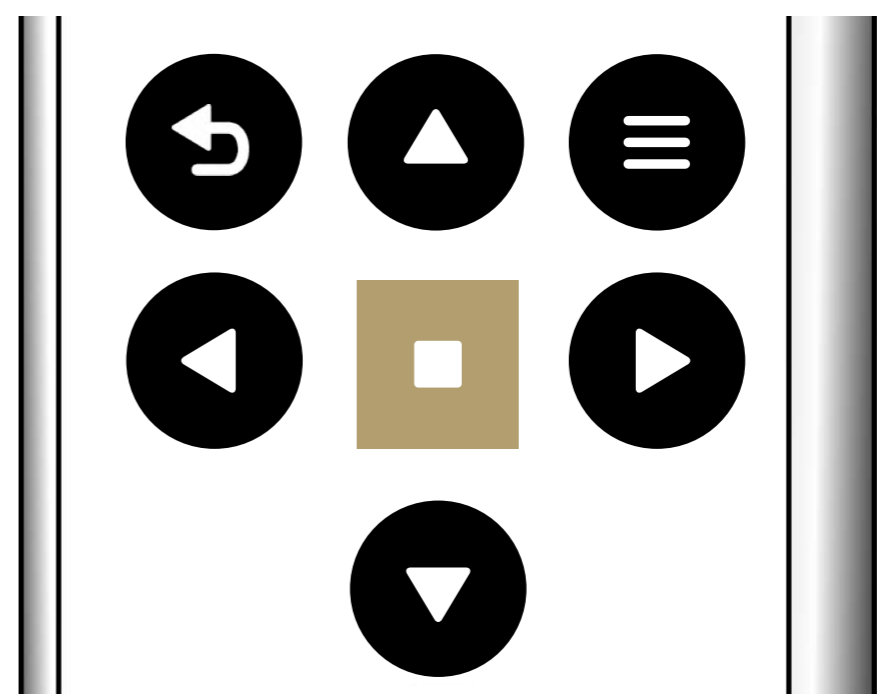

Deleting Favorite Position

Press P2 on remote

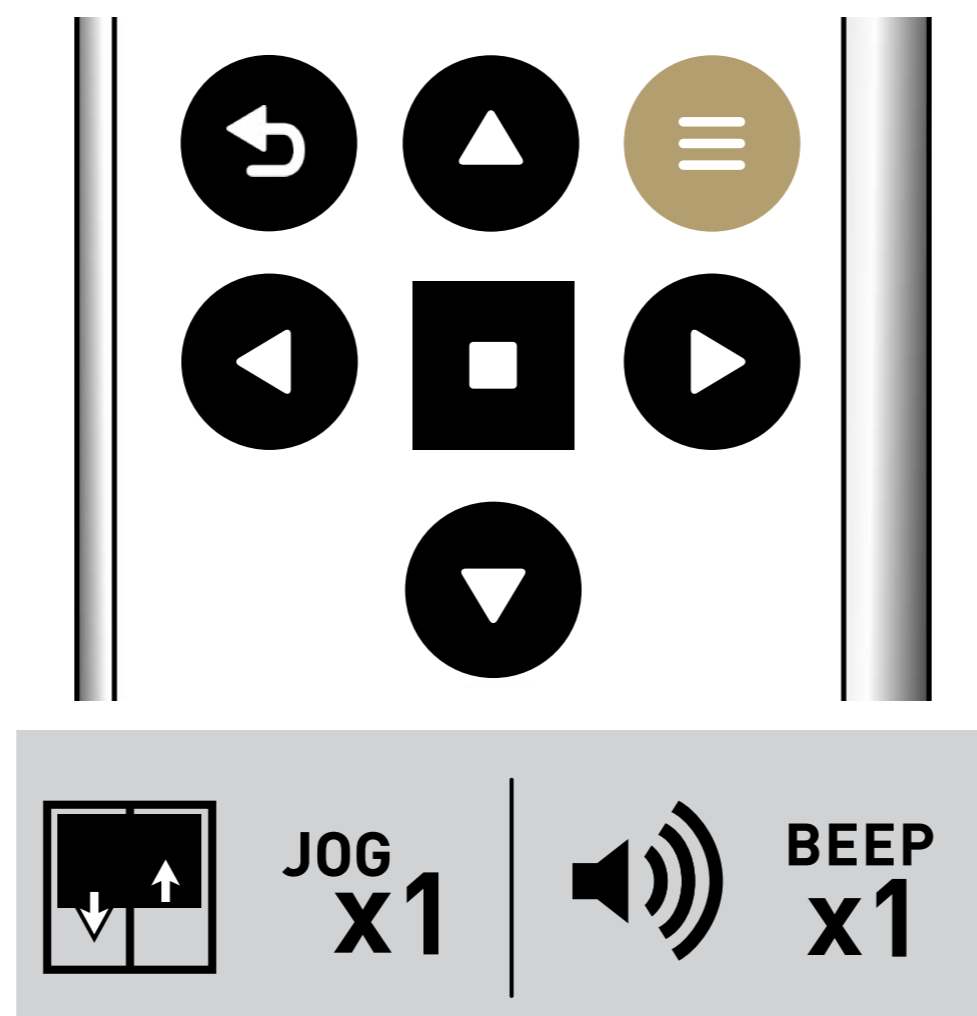

Press STOP on remote

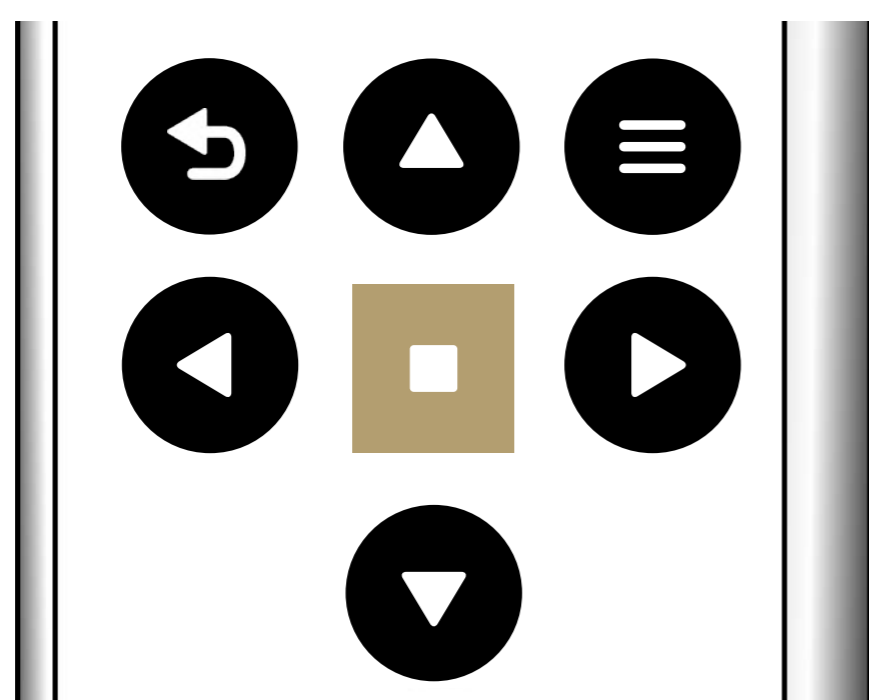

Press STOP on remote again

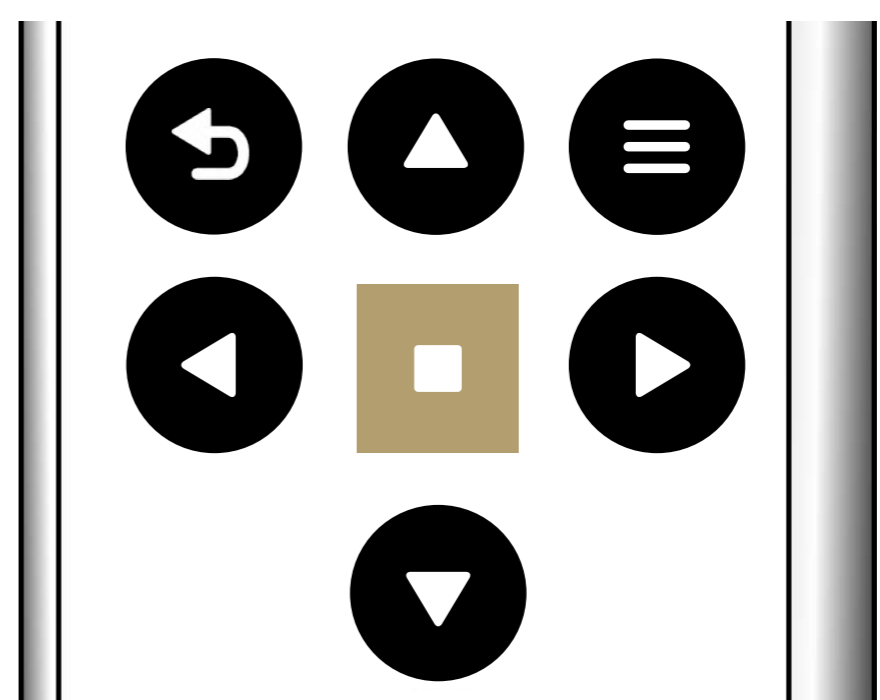

Adjusting Motor Speed



Press P2 on remote



To increase speed

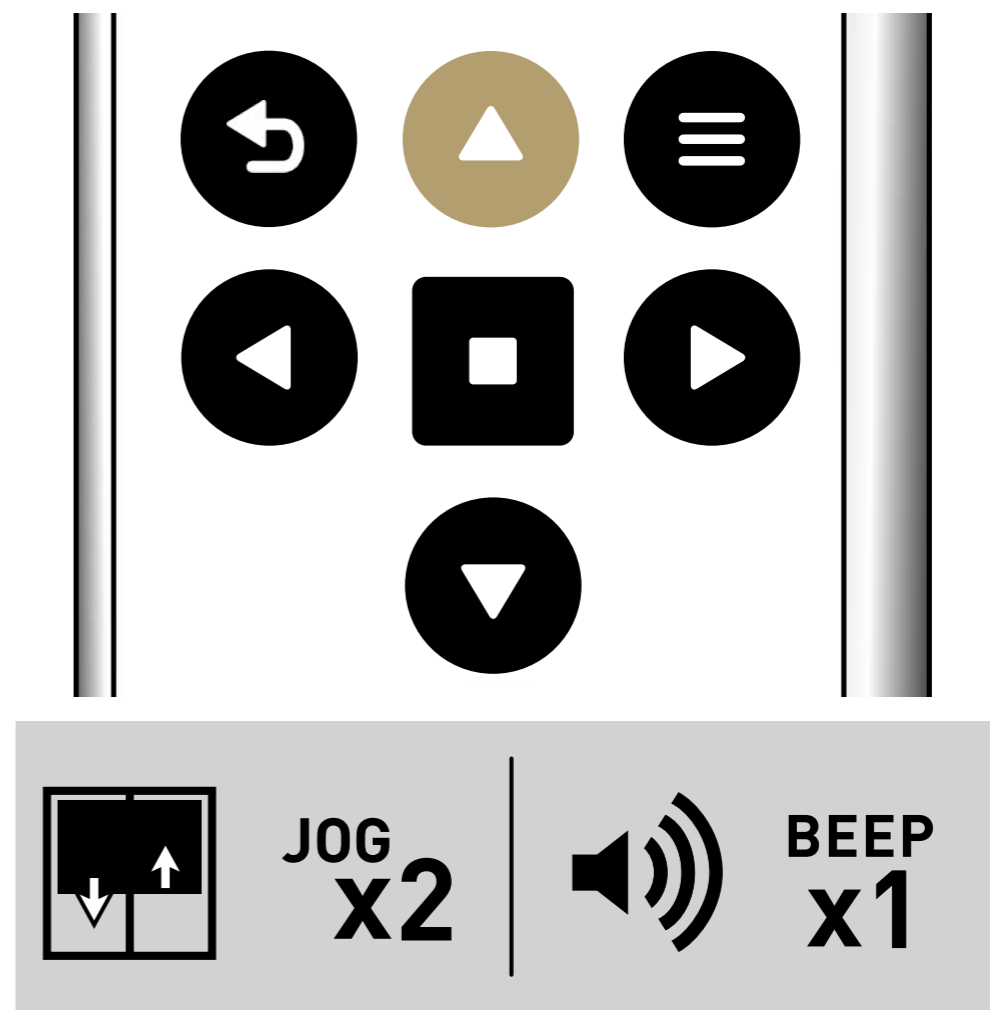
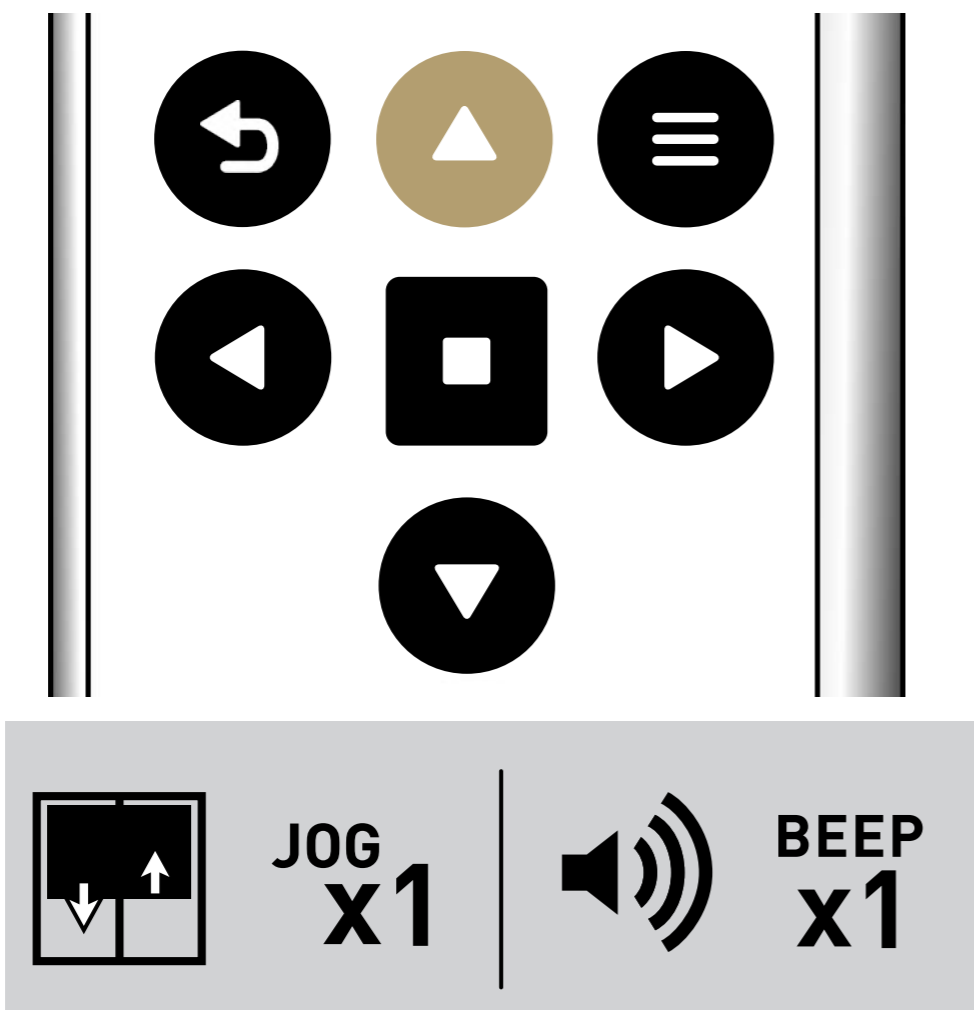

To decrease speed

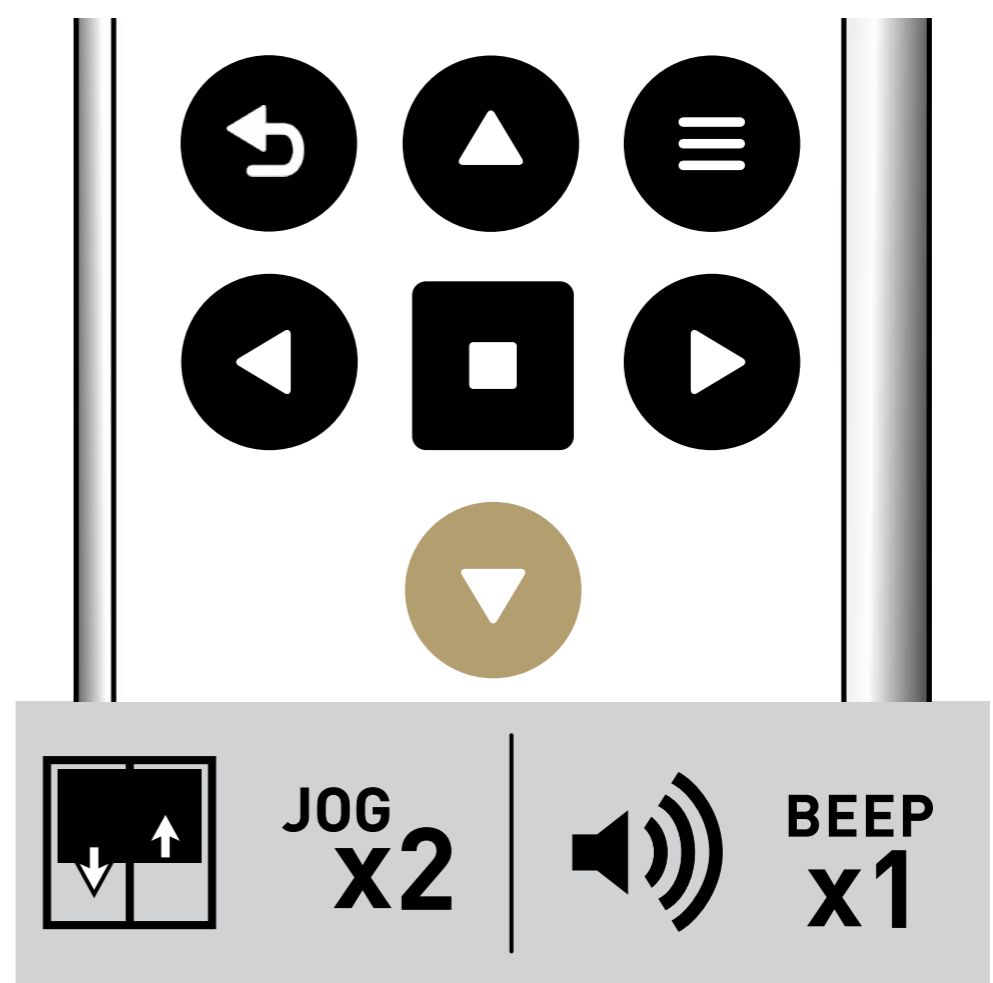
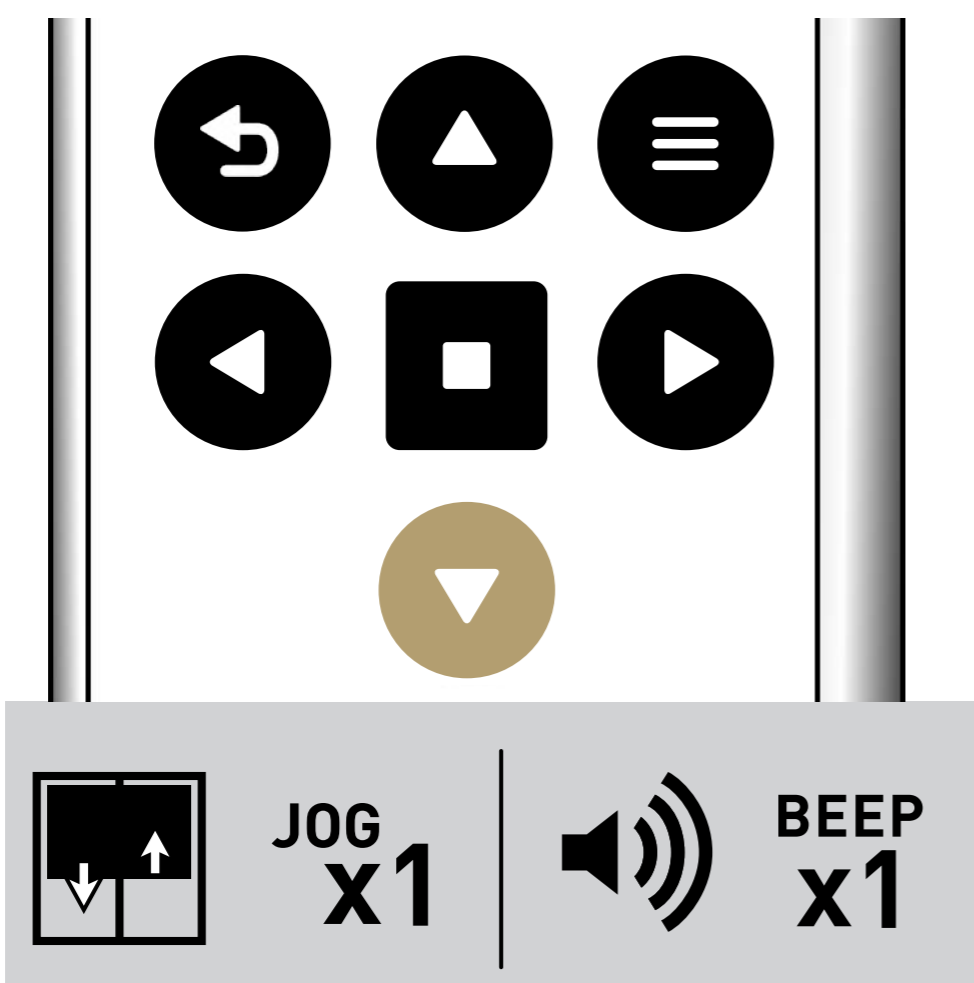

Enable Soft Stop

To enable, ensure that the motor is at its maximum speed, and then press P2, followed by Up, and Up. Your motor will follow the jog and beep feedback as shown below.



Disable Soft Stop

To disable, ensure that the motor is at its minimum speed, and then press P2, followed by Down, and Down. Your motor will follow the jog and beep feedback as shown below.

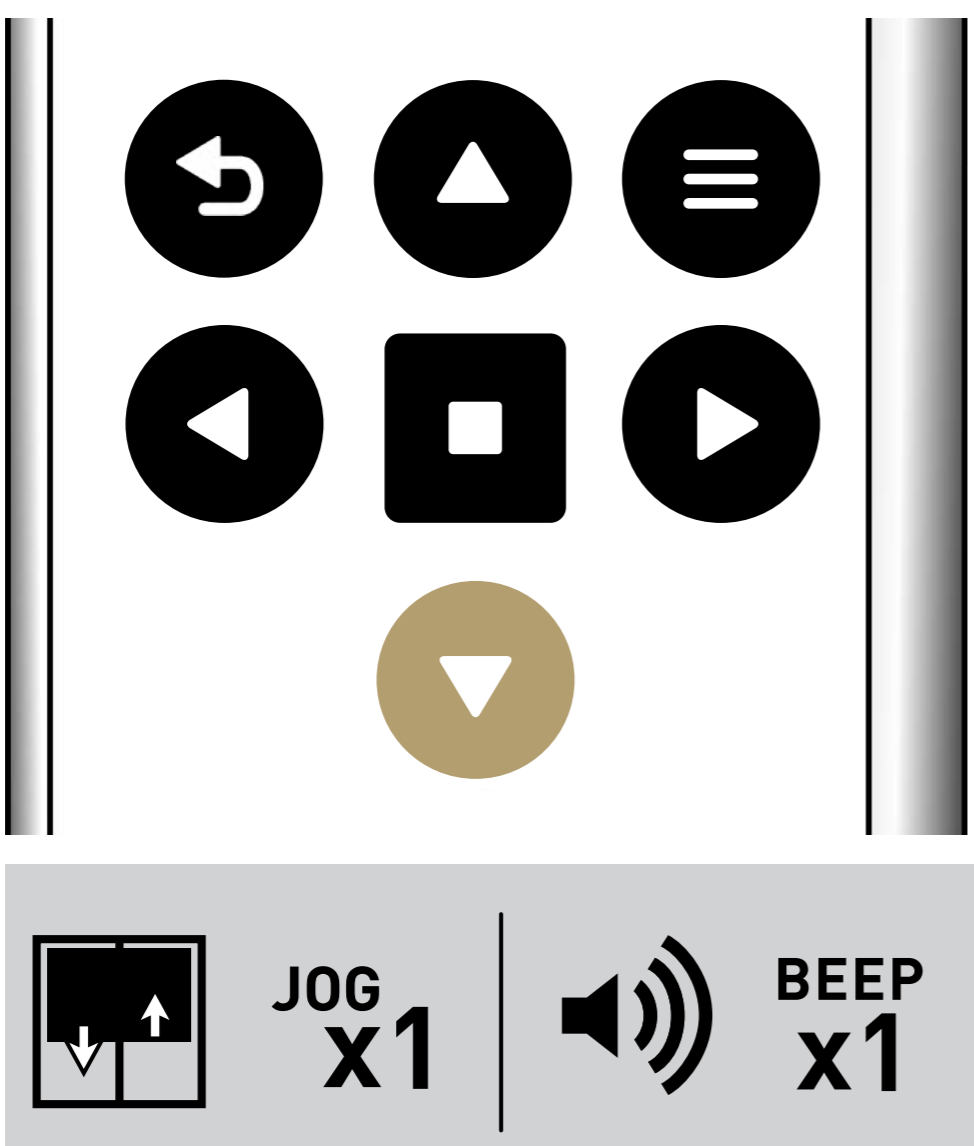

Copying Channels

REMOTE P2 LOCATIONS

Select the channel you want to transfer then press the P2 button on the new remote within 4 seconds.

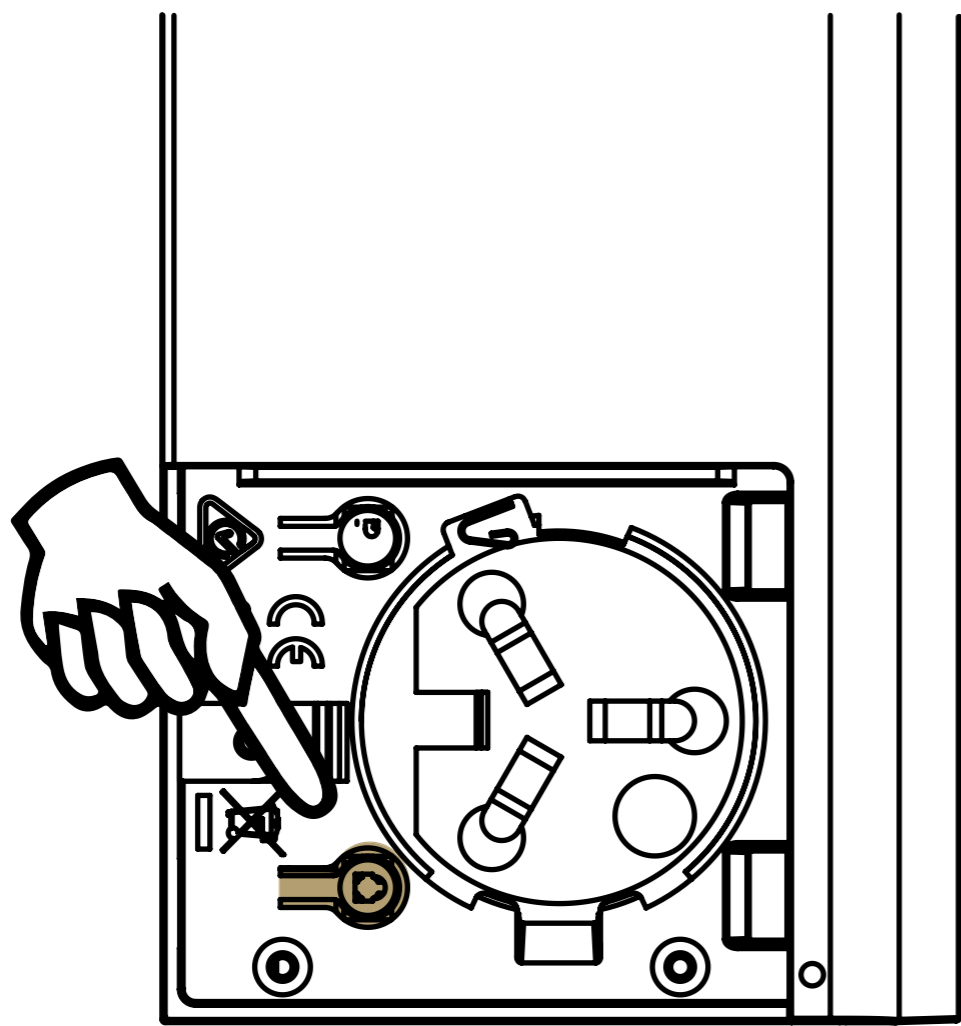

Push 1 & 5

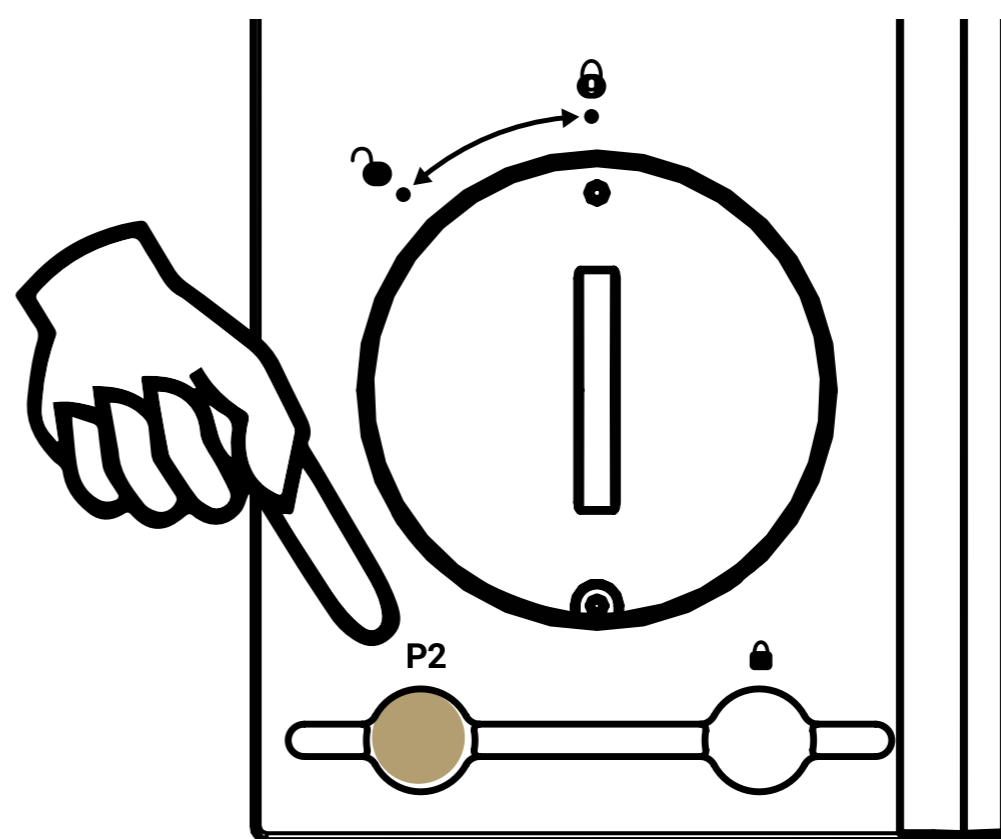

Push 15

Copying Channels

EXISTING REMOTE

Select the channel you want to transfer.

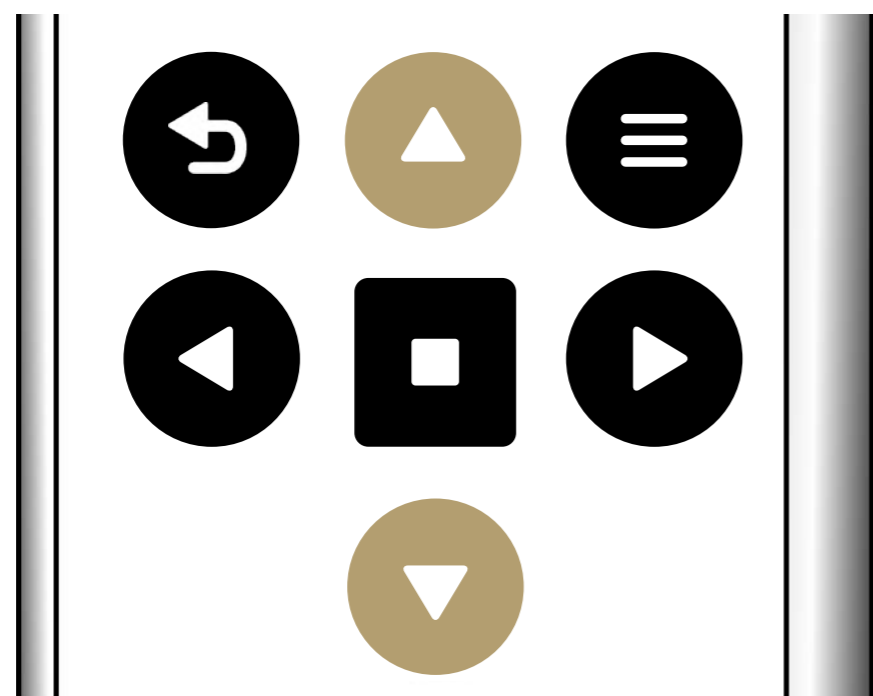

Press P2 on remote

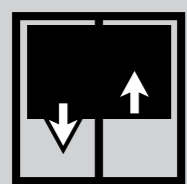
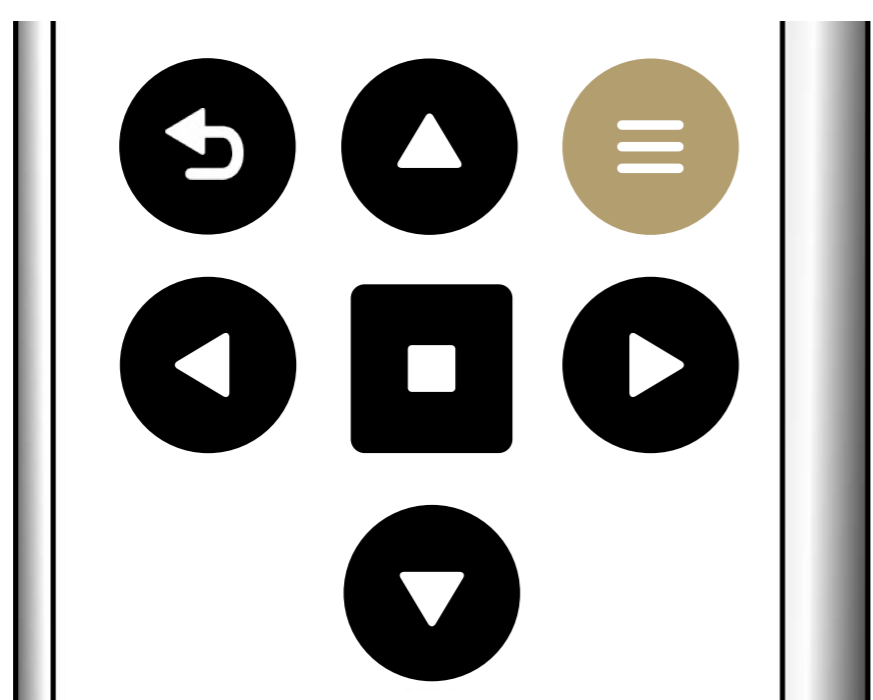

JOG
X1



BEEP
X1

Press P2 on remote again

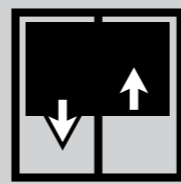
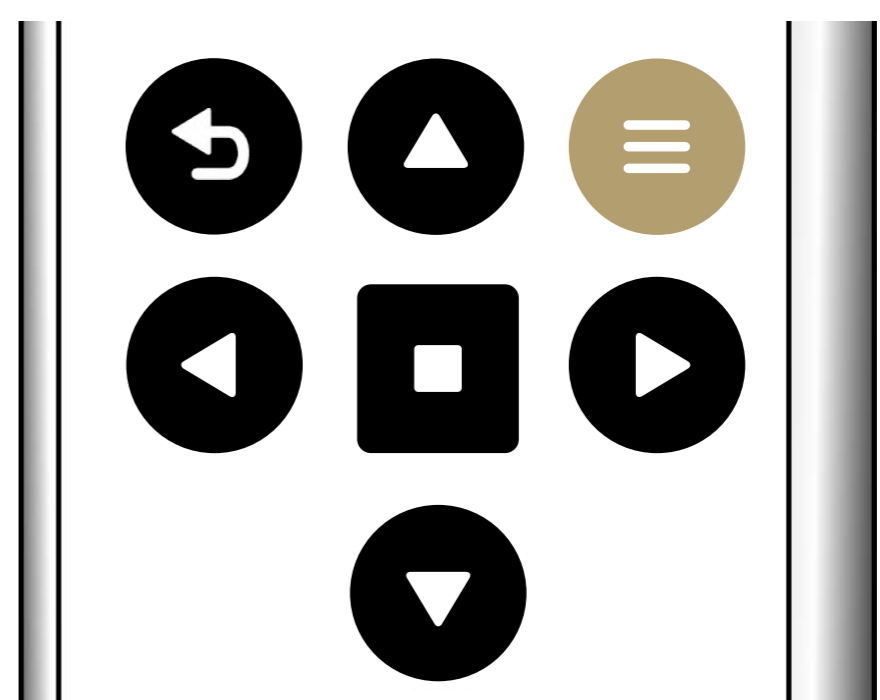

JOG
X1



BEEP
X1

Copying Channels

NEW REMOTE

Select the channel you wish to program then press the P2 button on the new remote within 4 seconds to save the copied channel.

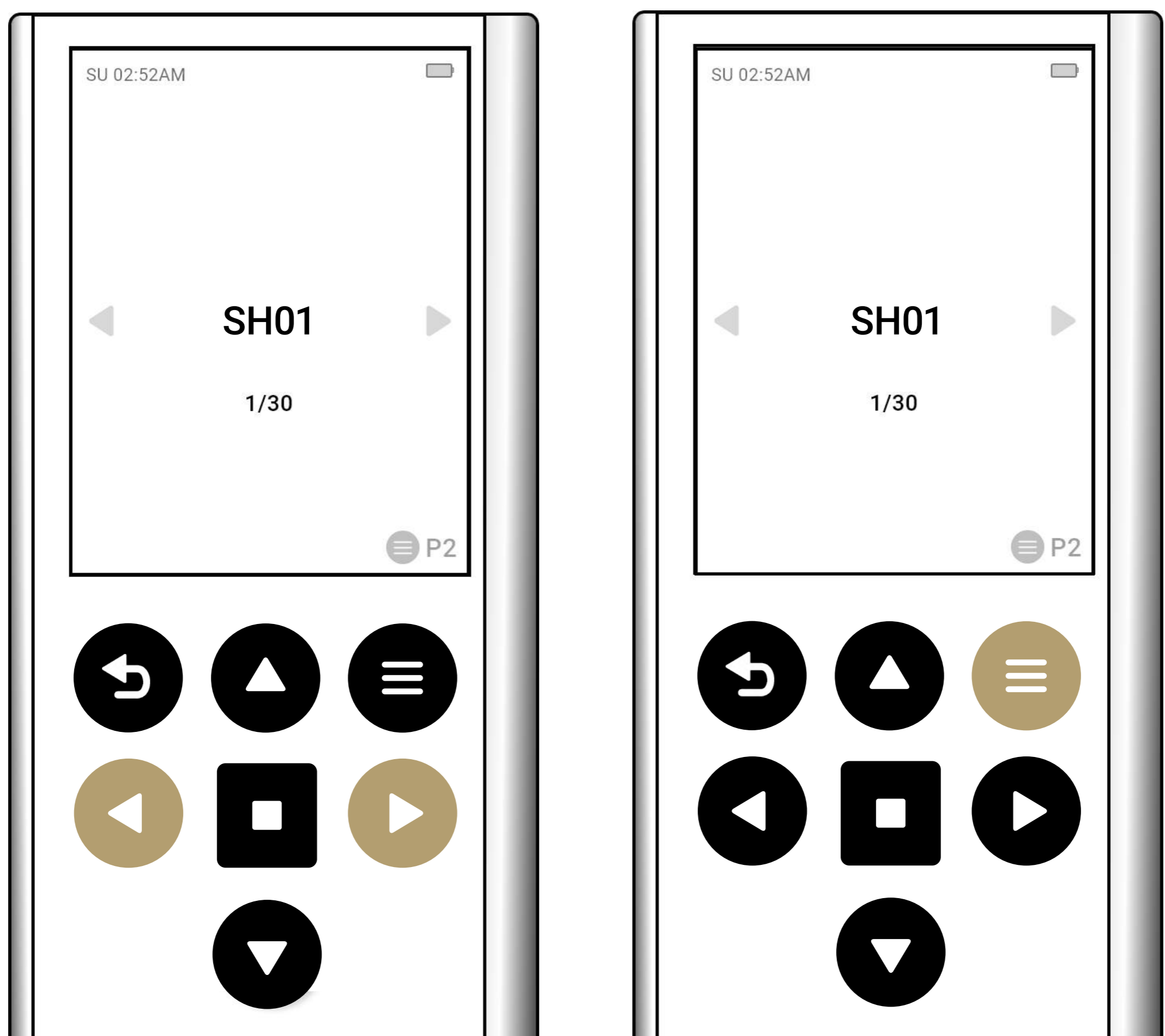

Factory Reset

MOTOR RESET PROCEDURE

To reset all settings in the motor press and hold the P1 Button for 14 seconds, you should see 4 independent jogs followed by 4x Beeps at the end.

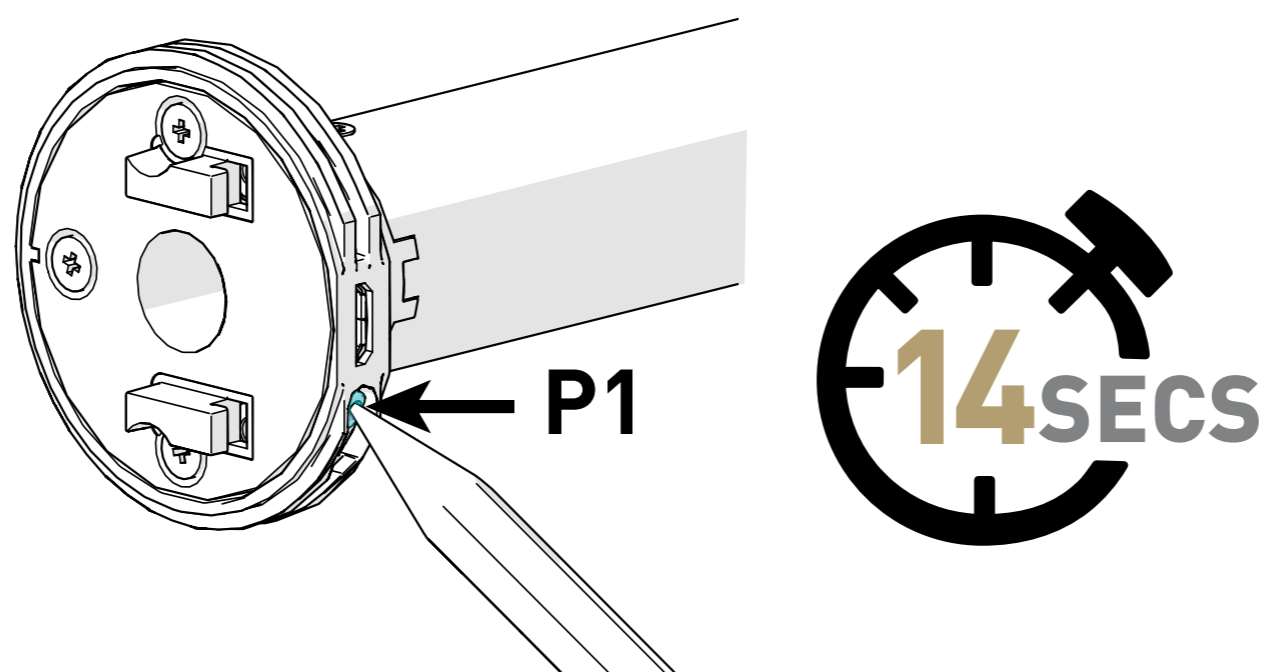

(Internal Tubular pictured above.
Refer to “P1 Locations” for specific devices.)

MOTOR RESPONSE

