



Shenzhen CTA Testing Technology Co., Ltd.
 Room 106, Building 1, Yibaolai Industrial Park, Qiaotou Community,
 Fuhai Street, Bao'an District, Shenzhen, China

FCC PART 15 SUBPART CTEST REPORT

FCC PART 15.247

Report Reference No.....: CTA24072303501

FCC ID : 2AG7C-A880

Compiled by
 (position+printed name+signature)..: File administrators Jinghua Xiao

Jinghua Xiao

Supervised by
 (position+printed name+signature)..: Test Engineer Lushan Kong

Lushan Kong

Approved by
 (position+printed name+signature)..: Manager Eric Wang



Wang

Date of issue.....: Aug. 27, 2024

Representative Laboratory Name. : Shenzhen CTA Testing Technology Co., Ltd.

Address.....: Room 106, Building 1, Yibaolai Industrial Park, Qiaotou Community, Fuhai Street, Bao' an District, Shenzhen, China

Applicant's name.....: Hangzhou Meari Technology Co., Ltd.

Address.....: Building 4, Huiding Intelligent Innovation Center, No. 825, Ruquan Road, Changhe Street, Binjiang District, Hangzhou, Zhejiang, China

Test specification..... :

Standard.....: **FCC Part 15.247**

Shenzhen CTA Testing Technology Co., Ltd. All rights reserved.

This publication may be reproduced in whole or in part for non-commercial purposes as long as the Shenzhen CTA Testing Technology Co., Ltd. is acknowledged as copyright owner and source of the material. Shenzhen CTA Testing Technology Co., Ltd. takes no responsibility for and will not assume liability for damages resulting from the reader's interpretation of the reproduced material due to its placement and context.

Test item description.....: CAMERA WIFI Module

Trade Mark.....: N/A

Manufacturer.....: Hangzhou Meari Technology Co., Ltd.

Model/Type reference.....: A880

Listed Models: Speed 22Q, Speed 22F, OP1, OP1T, OP1Q, OP1F, Speed 24Q, Speed 24F, Mini 9Q, Mini 9T, Mini 12Q, Mini 12T, Mini 8T, Mini 8Q, Mini 16T, Mini 16Q, M1T, M1Q, IN1T, IN1Q, M4T, M4Q, P2T, P2F, P2Q, P4F, P4Q, DOME1, DOME1T, PETCAM1F, PETCAM1

Modulation Type.....: GFSK

Operation Frequency.....: From 2402MHz to 2480MHz

Hardware Version: A880 Ver 1.2

Software Version.....: N/A

Rating.....: DC 3.3V

Result.....: **PASS**

Shenzhen CTA Testing Technology Co., Ltd.

Room 106, Building 1, Yibaolai Industrial Park, Qiaotou Community, Fuhai Street, Bao'an District, Shenzhen, China
 Tel:+86-755 2322 5875 E-mail:cta@cta-test.cn Web:http://www.cta-test.cn

TEST REPORT

Test Report No. :	CTA24072303501	Aug. 27, 2024
		Date of issue

Equipment under Test : CAMERA WIFI Module

Model /Type : A880

Listed model : Speed 22Q, Speed 22F, OP1, OP1T, OP1Q, OP1F, Speed 24Q, Speed 24F, Mini 9Q, Mini 9T, Mini 12Q, Mini 12T, Mini 8T, Mini 8Q, Mini 16T, Mini 16Q, M1T, M1Q, IN1T, IN1Q, M4T, M4Q, P2T, P2F, P2Q, P4F, P4Q, DOME1, DOME1T, PETCAM1F, PETCAM1

Applicant : **Hangzhou Meari Technology Co., Ltd.**

Address : Building 4, Huiding Intelligent Innovation Center, No. 825,Ruquan Road, Changhe Street, Binjiang District, Hangzhou, Zhejiang, China

Manufacturer : **Hangzhou Meari Technology Co., Ltd.**

Address : 4F of Building 1 and 2-4F of Building 2, No. 91 Chutian Road, Xixing Street, Binjiang District, Hangzhou, Zhejiang, China

Test Result:	PASS
---------------------	-------------

The test report merely corresponds to the test sample.

It is not permitted to copy extracts of these test result without the written permission of the test laboratory.

Contents

1. TEST STANDARDS	4
2. SUMMARY	5
2.1. General Remarks	5
2.2. Product Description	5
2.3. Equipment Under Test	7
2.4. Short description of the Equipment under Test (EUT)	7
2.5. EUT operation mode	7
2.6. Block Diagram of Test Setup	8
2.7. EUT Exercise Software	8
2.8. Special Accessories	8
2.9. External I/O Cable	8
2.10. Related Submittal(s) / Grant (s)	8
2.11. Modifications	8
3. TEST ENVIRONMENT	9
3.1. Address of the test laboratory	9
3.2. Test Facility	9
3.3. Environmental conditions	9
3.4. Statement of the measurement uncertainty	9
3.5. Test Description	10
3.6. Equipments Used during the Test	11
4. TEST CONDITIONS AND RESULTS	12
4.1. AC Power Conducted Emission	12
4.2. Radiated Emission	14
4.3. On Time and Duty Cycle	19
4.4. Maximum Peak Output Power	20
4.5. Power Spectral Density	21
4.6. 99% and 6dB Bandwidth	22
4.7. Conducted Spurious Emissions and Band Edge Compliance of RF Emission	23
4.8. Antenna Requirement	25
5. TEST SETUP PHOTOS OF THE EUT	26
6. EXTERNAL AND INTERNAL PHOTOS OF THE EUT	28

1. TEST STANDARDS

The tests were performed according to following standards:

[FCC Rules Part 15.247](#): Frequency Hopping, Direct Spread Spectrum and Hybrid Systems that are in operation within the bands of 902-928 MHz, 2400-2483.5 MHz, and 5725-5850 MHz.

[ANSI C63.10-2020](#): American National Standard for Testing Unlicensed Wireless Devices

[KDB 558074 D01 DTS Meas Guidance v05r02](#): Guidance for Performing Compliance Measurements on Digital Transmission Systems (DTS) Operating Under §15.247.

2. SUMMARY

2.1. General Remarks

Date of receipt of test sample	:	Jul. 16, 2024
Testing commenced on	:	Jul. 16, 2024
Testing concluded on	:	Aug. 26, 2024

2.2. Product Description

Product Name	CAMERA WIFI Module
Trade Mark	N/A
Model/Type reference	A880
List Models	Speed 22Q, Speed 22F, OP1, OP1T, OP1Q, OP1F, Speed 24Q, Speed 24F, Mini 9Q, Mini 9T, Mini 12Q, Mini 12T, Mini 8T, Mini 8Q, Mini 16T, Mini 16Q, M1T, M1Q, IN1T, IN1Q, M4T, M4Q, P2T, P2F, P2Q, P4F, P4Q, DOME1, DOME1T, PETCAM1F, PETCAM1
Model Declaration	PCB board, structure and internal of these model(s) are the same, Only the model name different , So no additional models were tested.
Power supply:	DC 3.3V
Sample ID	CTA240723035-1# & CTA240723035-2#
Bluetooth	
Operation frequency	2402-2480MHz
Channel Number	40 channels for Bluetooth (DTS)
Channel Spacing	2MHz for Bluetooth (DTS)
Modulation Type	GFSK for Bluetooth (DTS)
WIFI(2.4G Band)	
Frequency Range	2412MHz ~ 2462MHz
Channel Spacing	5MHz
Channel Number	11Channel for IEEE 802.11b/g/n/ax(HT20) 7 Channel for IEEE 802.11n/ax (HT40)
Modulation Type	IEEE 802.11b: DSSS(CCK,DQPSK,DBPSK) IEEE 802.11g: OFDM(64QAM, 16QAM, QPSK, BPSK) IEEE 802.11n HT20: OFDM (64QAM, 16QAM, QPSK,BPSK) IEEE 802.11n HT40: OFDM (64QAM, 16QAM, QPSK,BPSK) IEEE 802.11ax HE20: OFDMA (64QAM, 16QAM, QPSK,BPSK) IEEE 802.11ax HE40: OFDMA (64QAM, 16QAM, QPSK,BPSK)
WIFI(5.2G/5.3G/5.7G Band)	
Frequency Range	5150MHz ~ 5250MHz, 5250MHz ~ 5350MHz, 5500MHz ~ 5700MHz
Channel Number	4 Channels for 20MHz bandwidth(5180-5240MHz) 4 Channels for 20MHz bandwidth(5260-5320MHz) 8 Channels for 20MHz bandwidth(5500-5700MHz) 2 channels for 40MHz bandwidth(5190~5230MHz) 2 channels for 40MHz bandwidth(5270~5310MHz) 4 Channels for 40MHz bandwidth(5510-5670MHz)
Modulation Type	IEEE 802.11a: OFDM (64QAM, 16QAM, QPSK, BPSK) IEEE 802.11n HT20: OFDM (64QAM, 16QAM, QPSK, BPSK)

Shenzhen CTA Testing Technology Co., Ltd.

Room 106, Building 1, Yibaolai Industrial Park, Qiaotou Community, Fuhai Street, Bao'an District, Shenzhen, China
Tel:+86-755 2322 5875 E-mail:cta@cta-test.cn Web:http://www.cta-test.cn

	IEEE 802.11n HT40: OFDM (64QAM, 16QAM, QPSK, BPSK) IEEE 802.11ac VHT20: OFDM (256QAM,64QAM, 16QAM, QPSK, BPSK) IEEE 802.11ac VHT40: OFDM (256QAM,64QAM, 16QAM, QPSK, BPSK) IEEE 802.11ax HE20: OFDMA (1024QAM, 256QAM, 64QAM, 16QAM, QPSK, BPSK) IEEE 802.11ax HE40: OFDMA (1024QAM, 256QAM, 64QAM, 16QAM, QPSK, BPSK)
WIFI (5.8G Band)	
Frequency Range	5745MHz ~ 5825MHz
Channel Number	5 channels for 20MHz bandwidth(5745-5825MHz) 2 channels for 40MHz bandwidth(5755~5795MHz)
Modulation Type	IEEE 802.11a: OFDM (64QAM, 16QAM, QPSK, BPSK) IEEE 802.11n HT20: OFDM (64QAM, 16QAM, QPSK, BPSK) IEEE 802.11n HT40: OFDM (64QAM, 16QAM, QPSK, BPSK) IEEE 802.11ac VHT20: OFDM (256QAM,64QAM, 16QAM, QPSK, BPSK) IEEE 802.11ac VHT40: OFDM (256QAM,64QAM, 16QAM, QPSK, BPSK) IEEE 802.11ax HE20: OFDMA (1024QAM, 256QAM, 64QAM, 16QAM, QPSK, BPSK) IEEE 802.11ax HE40: OFDMA (1024QAM, 256QAM, 64QAM, 16QAM, QPSK, BPSK)
Antenna Description	Omni Antenna, 2.91dBi(Max.) for 2.4G Band and 3.81dBi(Max.) for 5G Band; FPC Antenna, 4.66dBi(Max.) for 2.4G Band and 2.96dBi(Max.) for 5G Band

2.3. Equipment Under Test

Power supply system utilised

Power supply voltage	:	<input type="radio"/> 230V/ 50 Hz	<input type="radio"/> 120V/60Hz
		<input type="radio"/> 12 V DC	<input type="radio"/> 24 V DC
		<input checked="" type="radio"/> Other (specified in blank below)	

DC 3.3V

2.4. Short description of the Equipment under Test (EUT)

This is a CAMERA WIFI Module.

For more details, refer to the user's manual of the EUT.

2.5. EUT operation mode

The Applicant provides communication tools software to control the EUT for staying in continuous transmitting (Duty Cycle more than 98%) and receiving mode for testing. There are 40 channels provided to the EUT.

Channel 00/19/39 was selected to test.

Mode of Operations	Frequency Range (MHz)	Data Rate (Mbps)
(BLE)	2402	1
	2440	1
	2480	1
For Conducted Emission		
Test Mode		TX Mode
For Radiated Emission		
Test Mode		TX Mode

Channel	Frequency(MHz)	Channel	Frequency(MHz)
0	2402	20	2442
1	2404	21	2444
2	2406	22	2446
--	--	--	--
--	--	--	--
18	2438	38	2478
19	2440	39	2480

The EUT has been tested under operating condition.

This test was performed with EUT in X, Y, Z position and the worst case was found when EUT in X position.

AC conducted emission pre-test at both at AC 120V/60Hz and AC 240V/50Hz modes, recorded worst case(AC 120V/60Hz).

Worst-case mode and channel used for 150 KHz-30 MHz power line conducted emissions was the mode and channel with the highest output power, which was determined to be BT LE mode (MCH).

Worst-case mode and channel used for 9 KHz-1000 MHz radiated emissions was the mode and channel with the highest output power, that was determined to be BT LE mode(MCH).

2.6. Block Diagram of Test Setup

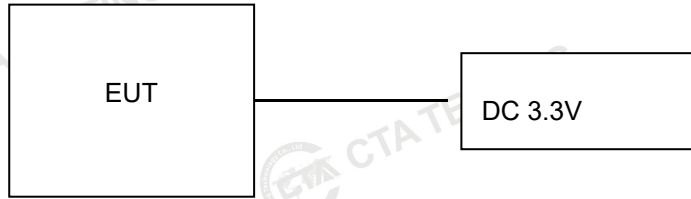

2.7. EUT Exercise Software

The system was configured for testing in a continuous transmits condition and change test channels by software (IPOP order) provided by application.

Power Parameters:

Test Software Version	IPOP order		
Frequency	2402MHz	2440MHz	2480MHz
Bluetooth	Default	Default	Default

2.8. Special Accessories

Manufacturer	Description	Model	Serial Number	Certificate
SHENZHEN TIANYIN ELECTRONICS CO.,LTD.	Adapter	TPA-46B050100UU	--	IC

2.9. External I/O Cable

I/O Port Description	Quantity	Cable
DC IN Port	1	Non-Shielded, 1.0m
SD Card Port	1	N/A

2.10. Related Submittal(s) / Grant (s)

This submittal(s) (test report) is intended for FCC ID: **2AG7C-A880** filing to comply with Section 247 of the FCC Part 15, Subpart C Rules.

2.11. Modifications

No modifications were implemented to meet testing criteria.

3. TEST ENVIRONMENT

3.1. Address of the test laboratory

Shenzhen CTA Testing Technology Co., Ltd.

Room 106, Building 1, Yibaolai Industrial Park, Qiaotou Community, Fuhai Street, Bao'an District, Shenzhen, China.

3.2. Test Facility

The test facility is recognized, certified, or accredited by the following organizations:

FCC-Registration No.: 517856 Designation Number: CN1318

Shenzhen CTA Testing Technology Co., Ltd. has been listed on the US Federal Communications Commission list of test facilities recognized to perform electromagnetic emissions measurements.

A2LA-Lab Cert. No.: 6534.01

Shenzhen CTA Testing Technology Co., Ltd. has been listed by American Association for Laboratory Accreditation to perform electromagnetic emission measurement.

The 3m-Semi anechoic test site fulfils CISPR 16-1-4 according to ANSI C63.10 and CISPR 16-1-4:2010.

3.3. Environmental conditions

During the measurement the environmental conditions were within the listed ranges:

Temperature:	15-35 ° C
Humidity:	30-60 %
Atmospheric pressure:	950-1050mbar

3.4. Statement of the measurement uncertainty

The data and results referenced in this document are true and accurate. The reader is cautioned that there may be errors within the calibration limits of the equipment and facilities. The measurement uncertainty was calculated for all measurements listed in this test report acc. to CISPR 16 - 4 „Specification for radio disturbance and immunity measuring apparatus and methods – Part 4: Uncertainty in EMC Measurements“ and is documented in the Shenzhen CTA Testing Technology Co., Ltd. quality system acc. to DIN EN ISO/IEC 17025. Furthermore, component and process variability of devices similar to that tested may result in additional deviation. The manufacturer has the sole responsibility of continued compliance of the device.

Hereafter the best measurement capability for Shenzhen CTA laboratory is reported:

Test	Range	Measurement Uncertainty	Notes
Radiated Emission	9KHz~30MHz	3.02 dB	(1)
Radiated Emission	30~1000MHz	4.06 dB	(1)
Radiated Emission	1~18GHz	5.14 dB	(1)
Radiated Emission	18-40GHz	5.38 dB	(1)
Conducted Disturbance	0.15~30MHz	2.14 dB	(1)
Output Peak power	30MHz~18GHz	0.55 dB	(1)
Power spectral density	/	0.57 dB	(1)
Spectrum bandwidth	/	1.1%	(1)
Radiated spurious emission (30MHz-1GHz)	30~1000MHz	4.10 dB	(1)
Radiated spurious emission (1GHz-18GHz)	1~18GHz	4.32 dB	(1)
Radiated spurious emission (18GHz-40GHz)	18-40GHz	5.54 dB	(1)

This uncertainty represents an expanded uncertainty expressed at approximately the 95% confidence level using a coverage factor of k=2.

3.5. Test Description

Applied Standard:FCC 15.247				
FCC Rules	Description of Test	Test Sample	Result	Remark
/	On Time and Duty Cycle	CTA240723035-1#	Compliant	Appendix A
§15.247(b)	Maximum Conducted Output Power	CTA240723035-1#	Compliant	Appendix A
§15.247(e)	Power Spectral Density	CTA240723035-1#	Compliant	Appendix A
§15.247(a)(2)	6dB Bandwidth	CTA240723035-1#	Compliant	Appendix A
§2.1047	99% Occupied Bandwidth	CTA240723035-1#	Compliant	Appendix A
§15.209, §15.247(d)	Conducted Spurious Emissions and Band Edges Test	CTA240723035-1#	Compliant	Appendix A
§15.209, §15.247(d)	Radiated Spurious Emissions	CTA240723035-1# CTA240723035-2#	Compliant	Note 1
§15.205	Emissions at Restricted Band	CTA240723035-1#	Compliant	Appendix A
§15.207(a)	AC Conducted Emissions	CTA240723035-2#	Compliant	Note 1
§15.203 §15.247(c)	Antenna Requirements	CTA240723035-1#	Compliant	Note 1
§15.247(i) §2.1091	RF Exposure	/	Compliant	Note 2

Remark:

1. The measurement uncertainty is not included in the test result.
2. NA = Not Applicable; NP = Not Performed
3. Note 1 – Test results inside test report;
4. Note 2 – Test results in other test report (MPE Report).
5. We tested all test mode and recorded worst case in report

3.6. Equipments Used during the Test

Test Equipment	Manufacturer	Model No.	Serial No.	Calibration Date	Calibration Due Date
LISN	R&S	ENV216	CTA-308	2024/08/01	2025/07/31
LISN	R&S	ENV216	CTA-314	2024/08/01	2025/07/31
EMI Test Receiver	R&S	ESPI	CTA-307	2024/08/01	2025/07/31
EMI Test Receiver	R&S	ESCI	CTA-306	2024/08/01	2025/07/31
Spectrum Analyzer	Agilent	N9020A	CTA-301	2024/08/01	2025/07/31
Spectrum Analyzer	R&S	FSP	CTA-337	2024/08/01	2025/07/31
Vector Signa generator	Agilent	N5182A	CTA-305	2024/08/01	2025/07/31
Analog Signal Generator	R&S	SML03	CTA-304	2024/08/01	2025/07/31
WIDEBAND RADIO COMMUNICATION TESTER	CMW500	R&S	CTA-302	2024/08/01	2025/07/31
Temperature and humidity meter	Chigo	ZG-7020	CTA-326	2024/08/01	2025/07/31
Ultra-Broadband Antenna	Schwarzbeck	VULB9163	CTA-310	2023/10/17	2024/10/16
Horn Antenna	Schwarzbeck	BBHA 9120D	CTA-309	2023/10/13	2024/10/12
Loop Antenna	Zhinan	ZN30900C	CTA-311	2023/10/17	2024/10/16
Horn Antenna	Beijing Hangwei Dayang	OBH100400	CTA-336	2024/08/06	2025/08/05
Amplifier	Schwarzbeck	BBV 9745	CTA-312	2024/08/01	2025/07/31
Amplifier	Taiwan chengyi	EMC051845B	CTA-313	2024/08/01	2025/07/31
Directional coupler	NARDA	4226-10	CTA-303	2024/08/01	2025/07/31
High-Pass Filter	XingBo	XBLBQ-GTA18	CTA-402	2024/08/01	2025/07/31
High-Pass Filter	XingBo	XBLBQ-GTA27	CTA-403	2024/08/01	2025/07/31
Automated filter bank	Tonscend	JS0806-F	CTA-404	2024/08/01	2025/07/31
Power Sensor	Agilent	U2021XA	CTA-405	2024/08/01	2025/07/31
Amplifier	Schwarzbeck	BBV9719	CTA-406	2024/08/01	2025/07/31
EMI Test Software	Tonscend	JS32-CE	5.0.0.2	/	/
EMI Test Software	Tonscend	JS32-RE	5.0.0.1	/	/
RF Test Software	Tonscend	JS1120-1	3.1.65	/	/
RF Test Software	Tonscend	JS1120-3	3.1.46	/	/

Note: 1. The Cal.Interval was one year.

4. TEST CONDITIONS AND RESULTS

4.1. AC Power Conducted Emission

TEST CONFIGURATION

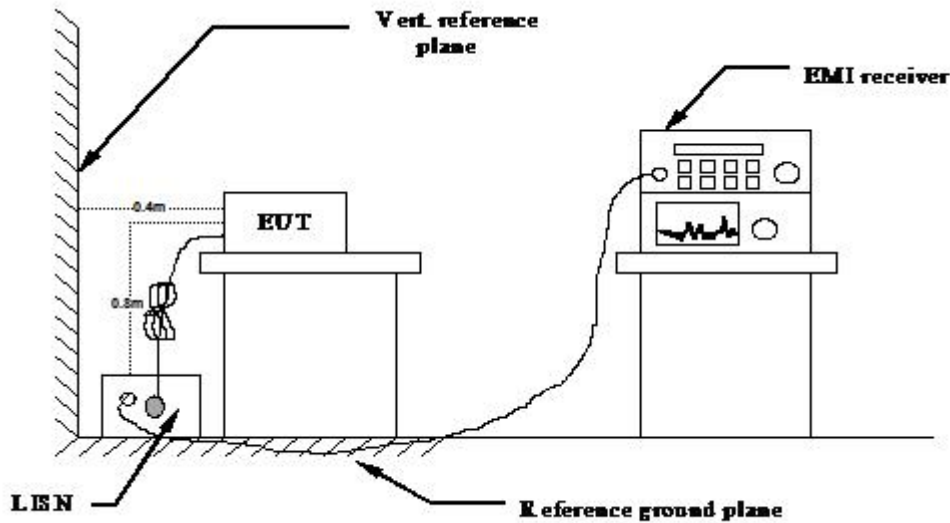

TEST PROCEDURE

- 1 The equipment was set up as per the test configuration to simulate typical actual usage per the user's manual. The EUT is a tabletop system, a wooden table with a height of 0.8 meters is used and is placed on the ground plane as per ANSI C63.10-2020.
- 2 Support equipment, if needed, was placed as per ANSI C63.10-2020
- 3 All I/O cables were positioned to simulate typical actual usage as per ANSI C63.10-2020
- 4 The EUT received DC 5.0V power, the adapter received AC120V/60Hz or AC 240V/50Hz power through a Line Impedance Stabilization Network (LISN) which supplied power source and was grounded to the ground plane.
- 5 All support equipments received AC power from a second LISN, if any.
- 6 The EUT test program was started. Emissions were measured on each current carrying line of the EUT using a spectrum Analyzer / Receiver connected to the LISN powering the EUT. The LISN has two monitoring points: Line 1 (Hot Side) and Line 2 (Neutral Side). Two scans were taken: one with Line 1 connected to Analyzer / Receiver and Line 2 connected to a 50 ohm load; the second scan had Line 1 connected to a 50 ohm load and Line 2 connected to the Analyzer / Receiver.
- 7 Analyzer / Receiver scanned from 150 KHz to 30MHz for emissions in each of the test modes.
- 8 During the above scans, the emissions were maximized by cable manipulation.

AC Power Conducted Emission Limit

For intentional device, according to §15.207(a) AC Power Conducted Emission Limits is as following:

Frequency range (MHz)	Limit (dBuV)	
	Quasi-peak	Average
0.15-0.5	66 to 56*	56 to 46*
0.5-5	56	46
5-30	60	50

* Decreases with the logarithm of the frequency.

DISTURBANCE Calculation

The AC mains conducted disturbance is calculated by adding the 10dB Pulse Limiter and Cable Factor and Duty Cycle Correction Factor (if any) from the measured reading. The basic equation with a sample calculation is as follows:

$$CD \text{ (dBuV)} = RA \text{ (dBuV)} + PL \text{ (dB)} + CL \text{ (dB)}$$

Where CD = Conducted Disturbance	CL = Cable Attenuation Factor (Cable Loss)
RA = Reading Amplitude	PL = 10 dB Pulse Limiter Factor

Shenzhen CTA Testing Technology Co., Ltd.

Room 106, Building 1, Yibaolai Industrial Park, Qiaotou Community, Fuhai Street, Bao'an District, Shenzhen, China
 Tel:+86-755 2322 5875 E-mail:cta@cta-test.cn Web:http://www.cta-test.cn

TEST RESULTS

Remark: We measured Conducted Emission at GFSK mode from 150 KHz to 30MHz in AC120V and the worst case was recorded.

Temperature	25°C	Humidity	60%
Test Engineer	Lushan Kong	Configurations	BT

Power supply:	AC 120V/60Hz	Polarization	L
---------------	--------------	--------------	---

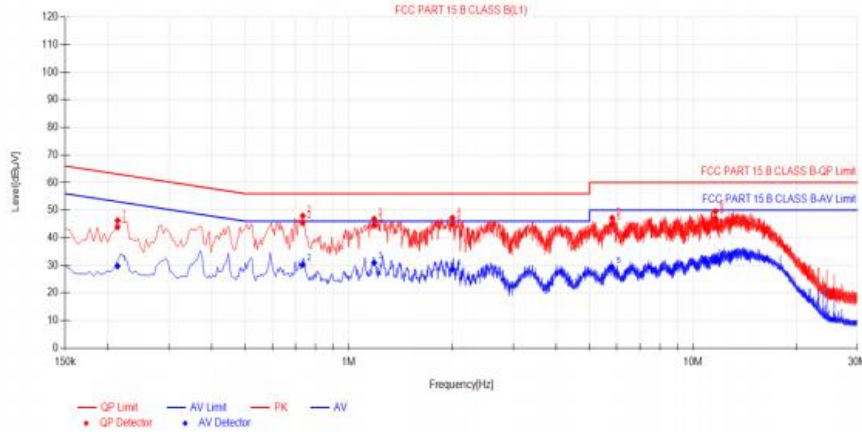

Suspected List									
NO.	Freq. [MHz]	Reading [dBµV]	Level [dBµV]	Factor [dB]	Limit [dBµV]	Margin [dB]	Detector	Type	Verdict
1	0.213	35.75	46.25	10.50	63.09	16.84	PK	L1	PASS
2	0.735	37.47	47.97	10.50	56.00	8.03	PK	L1	PASS
3	1.185	36.34	46.84	10.50	56.00	9.16	PK	L1	PASS
4	1.9995	36.73	47.23	10.50	56.00	8.77	PK	L1	PASS
5	5.8155	36.70	47.20	10.50	60.00	12.80	PK	L1	PASS
6	11.616	39.05	49.55	10.50	60.00	10.45	PK	L1	PASS

Power supply:	AC 120V/60Hz	Polarization	N
---------------	--------------	--------------	---

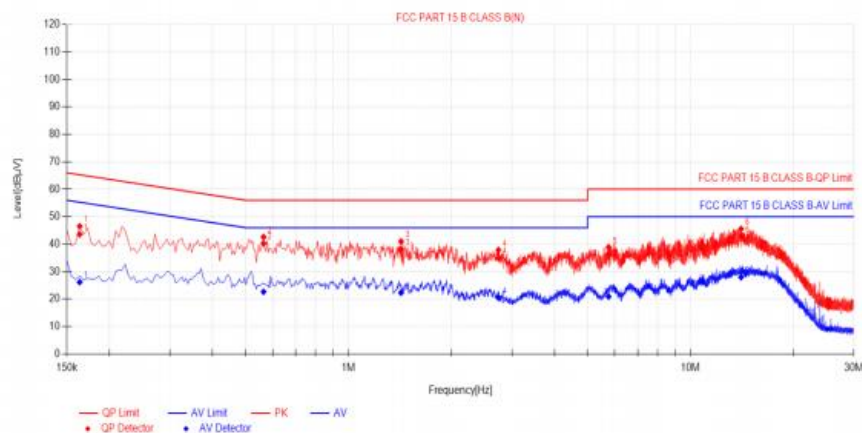

Suspected List									
NO.	Freq. [MHz]	Reading [dBµV]	Level [dBµV]	Factor [dB]	Limit [dBµV]	Margin [dB]	Detector	Type	Verdict
1	0.1635	36.02	46.52	10.50	65.28	18.76	PK	N	PASS
2	0.564	32.12	42.62	10.50	56.00	13.38	PK	N	PASS
3	1.4235	30.51	41.01	10.50	56.00	14.99	PK	N	PASS
4	2.742	27.37	37.87	10.50	56.00	18.13	PK	N	PASS
5	5.757	28.41	38.91	10.50	60.00	21.09	PK	N	PASS
6	14.0505	35.07	45.57	10.50	60.00	14.43	PK	N	PASS

NOTE: All the modes have been tested and recorded worst mode in the report (FPC Antenna).

4.2. Radiated Emission

TEST CONFIGURATION

Frequency range 9 KHz – 30MHz

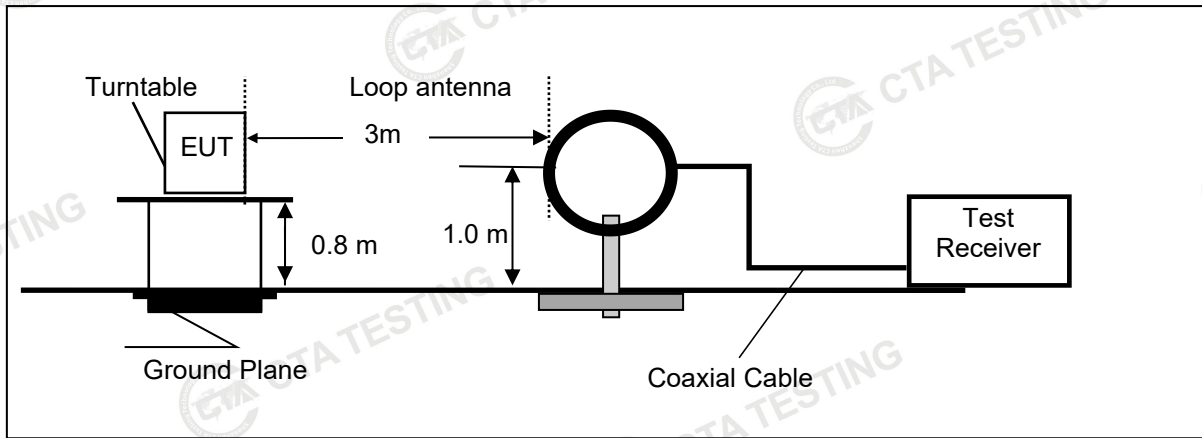

Frequency range 30MHz – 1000MHz

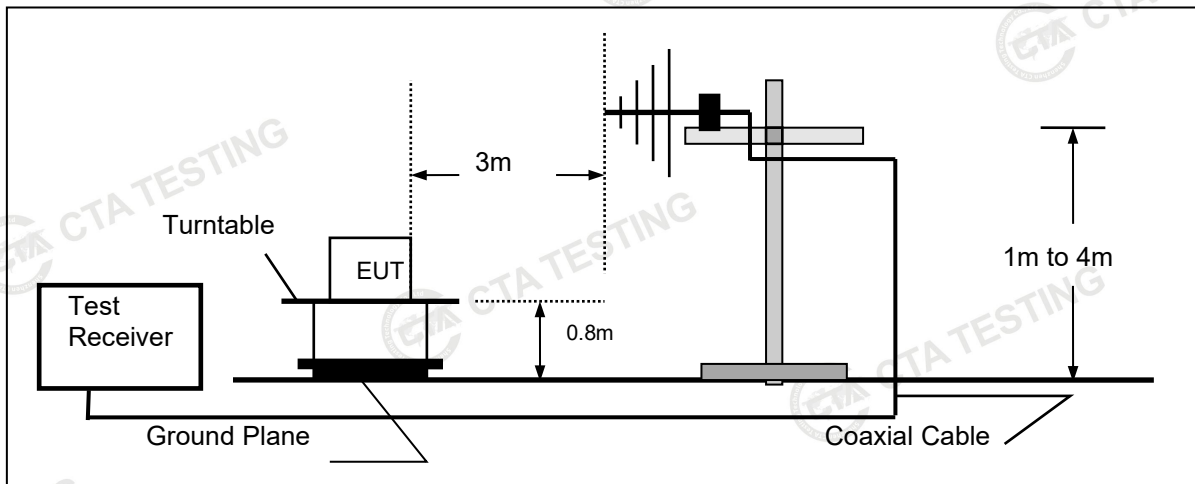

Frequency range above 1GHz-25GHz

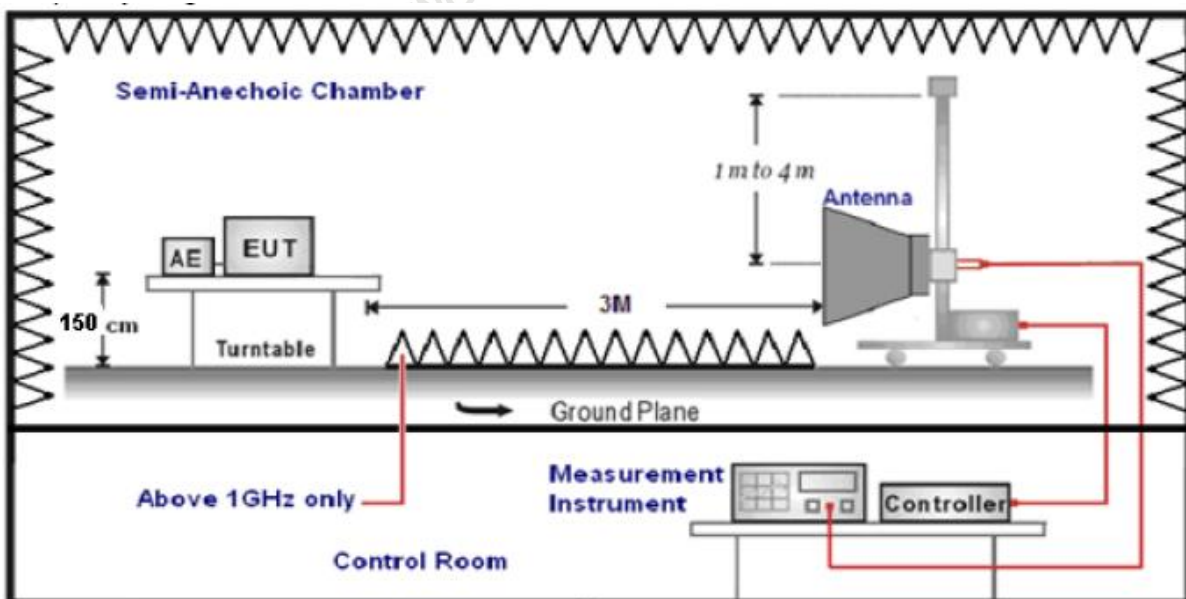

TEST PROCEDURE

1. The EUT was placed on a turn table which is 0.8m above ground plane when testing frequency range 9 KHz –1GHz;the EUT was placed on a turn table which is 1.5m above ground plane when testing frequency range 1GHz – 25GHz.
2. Maximum procedure was performed by raising the receiving antenna from 1m to 4m and rotating the turn table from 0°C to 360°C to acquire the highest emissions from EUT.
3. And also, each emission was to be maximized by changing the polarization of receiving antenna both horizontal and vertical.
4. Repeat above procedures until all frequency measurements have been completed.
5. Radiated emission test frequency band from 30MHz to 25GHz.
6. The distance between test antenna and EUT as following table states:

Test Frequency range	Test Antenna Type	Test Distance
9KHz-30MHz	Active Loop Antenna	3
30MHz-1GHz	Ultra-Broadband Antenna	3
1GHz-18GHz	Double Ridged Horn Antenna	3
18GHz-25GHz	Horn Antenna	1

7. Setting test receiver/spectrum as following table states:

Test Frequency range	Test Receiver/Spectrum Setting	Detector
9KHz-150KHz	RBW=200Hz/VBW=3KHz, Sweep time=Auto	QP
150KHz-30MHz	RBW=9KHz/VBW=100KHz, Sweep time=Auto	QP
30MHz-1GHz	RBW=120KHz/VBW=1000KHz, Sweep time=Auto	QP
1GHz-40GHz	Peak Value: RBW=1MHz/VBW=3MHz, Sweep time=Auto Average Value: RBW=1MHz/VBW=10Hz, Sweep time=Auto	Peak

Field Strength Calculation

The field strength is calculated by adding the Antenna Factor and Cable Factor and subtracting the Amplifier Gain and Duty Cycle Correction Factor(if any) from the measured reading. The basic equation with a sample calculation is as follows:

FS = RA + AF + CL - AG

Where FS = Field Strength	CL = Cable Attenuation Factor (Cable Loss)
RA = Reading Amplitude	AG = Amplifier Gain
AF = Antenna Factor	

Transd=AF +CL-AG

RADIATION LIMIT

For intentional device, according to § 15.209(a), the general requirement of field strength of radiated emission from intentional radiators at a distance of 3 meters shall not exceed the following table. According to § 15.247(d), in any 100kHz bandwidth outside the frequency band in which the EUT is operating, the radio frequency power that is produced by the intentional radiator shall be at least 20dB below that in the 100kHz bandwidth within the band that contains the highest level of desired power.

The pre-test have done for the EUT in three axes and found the worst emission at position shown in test setup photos.

Frequency (MHz)	Distance (Meters)	Radiated (dB μ V/m)	Radiated (μ V/m)
0.009-0.49	3	$20\log(2400/F(\text{KHz}))+40\log(300/3)$	2400/F(KHz)
0.49-1.705	3	$20\log(24000/F(\text{KHz}))+40\log(30/3)$	24000/F(KHz)
1.705-30	3	$20\log(30)+40\log(30/3)$	30
30-88	3	40.0	100
88-216	3	43.5	150
216-960	3	46.0	200
Above 960	3	54.0	500

TEST RESULTS

Remark: We measured Radiated Emission at GFSK mode from 9KHz to 25GHz in AC120V and the worst case was recorded.

Temperature	25°C	Humidity	55%
Test Engineer	Lushan Kong	Configurations	BT

For 9 KHz~30MHz

Freq. (MHz)	Level (dB μ V)	Over Limit (dB)	Over Limit (dB μ V)	Remark
-	-	-	-	See Note

Note:

The amplitude of spurious emissions which are attenuated by more than 20 dB below the permissible value has no need to be reported.

Distance extrapolation factor = $40 \log(\text{specific distance} / \text{test distance})$ (dB);

Limit line = specific limits (dB μ V) + distance extrapolation factor.

For 30MHz to 1000MHz

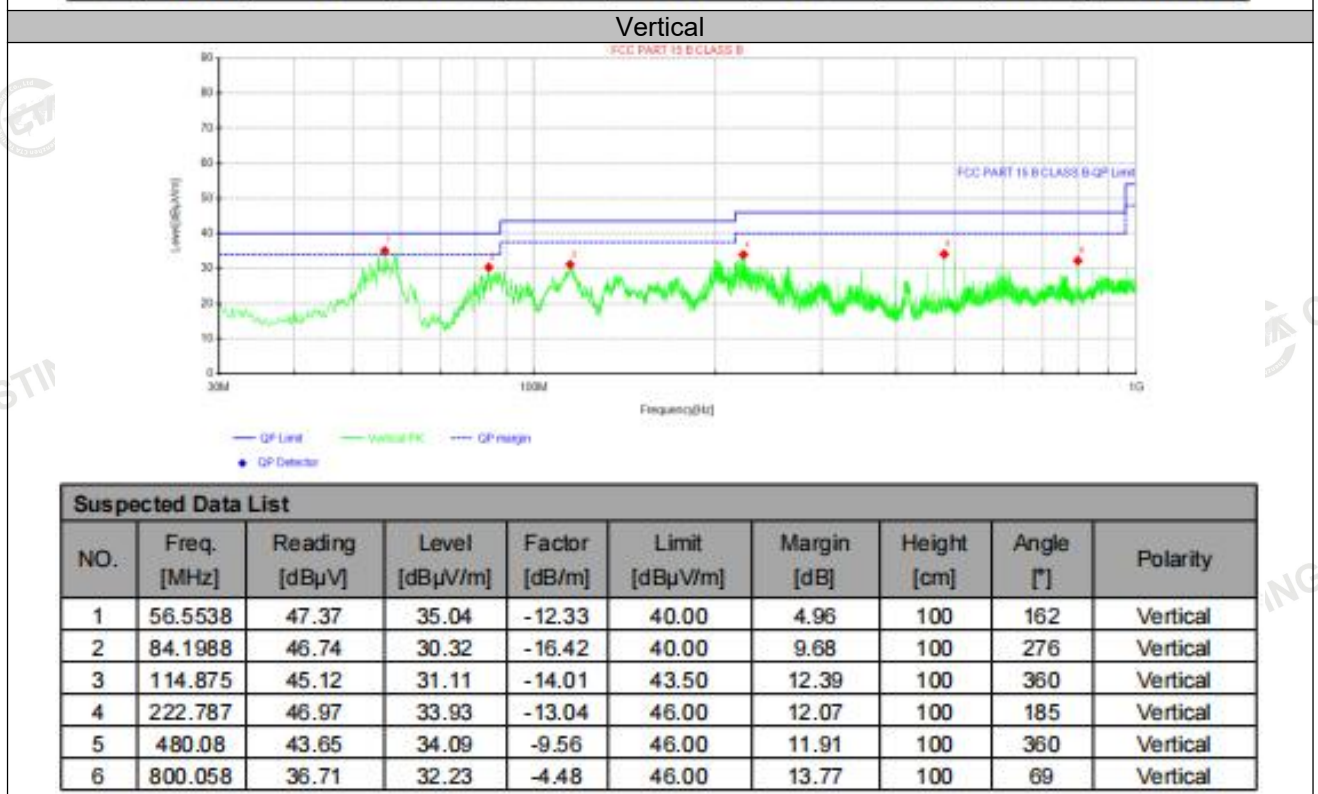
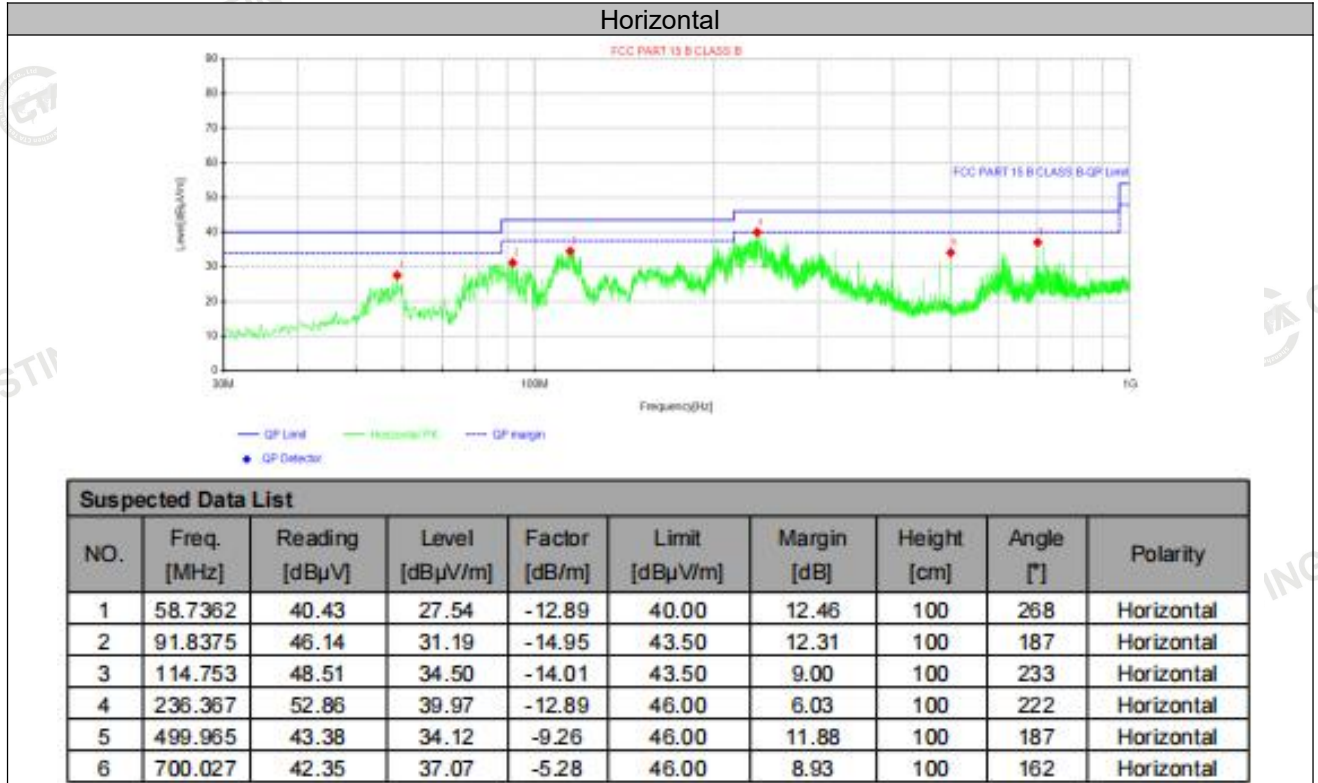

NOTE: All the modes have been tested and recorded worst mode in the report (FPC Antenna).

For Greater than 1GHz

BT LE

Channel 0 / 2402 MHz

Freq. MHz	Reading dBuV	Ant. Fac. dB/m	Pre. Fac. dB	Cab. Loss dB	Measured dBuV/m	Limit dBuV/m	Margin dB	Remark	Pol.
4804.00	50.59	32.44	30.25	7.95	60.73	74.00	-13.27	Peak	Horizontal
4804.00	36.69	32.44	30.25	7.95	46.83	54.00	-7.17	Average	Horizontal
4804.00	54.06	32.44	30.25	7.95	64.20	74.00	-9.80	Peak	Vertical
4804.00	35.77	32.44	30.25	7.95	45.91	54.00	-8.09	Average	Vertical

Channel 19 / 2440 MHz

Freq. MHz	Reading dBuV	Ant. Fac. dB/m	Pre. Fac. dB	Cab. Loss dB	Measured dBuV/m	Limit dBuV/m	Margin dB	Remark	Pol.
4880.00	49.15	32.52	30.31	8.12	59.48	74.00	-14.52	Peak	Horizontal
4880.00	37.99	32.52	30.31	8.12	48.32	54.00	-5.68	Average	Horizontal
4880.00	51.86	32.52	30.31	8.12	62.19	74.00	-11.81	Peak	Vertical
4880.00	36.21	32.52	30.31	8.12	46.54	54.00	-7.46	Average	Vertical

Channel 39 / 2480 MHz

Freq. MHz	Reading dBuV	Ant. Fac. dB/m	Pre. Fac. dB	Cab. Loss dB	Measured dBuV/m	Limit dBuV/m	Margin dB	Remark	Pol.
4960.00	50.19	32.68	30.27	7.88	60.48	74.00	-13.52	Peak	Horizontal
4960.00	36.21	32.68	30.27	7.88	46.50	54.00	-7.50	Average	Horizontal
4960.00	48.55	32.68	30.27	7.88	58.84	74.00	-15.16	Peak	Vertical
4960.00	30.94	32.68	30.27	7.88	41.23	54.00	-12.77	Average	Vertical

REMARKS:

1. Emission level (dBuV/m) =Raw Value (dBuV)+Correction Factor (dB/m)
2. Correction Factor (dB/m) = Antenna Factor (dB/m)+Cable Factor (dB)-Pre-amplifier Factor
3. Margin value = Limit value- Emission level.
4. The other emission levels were very low against the limit.
5. Measured used 2.4GHz band filter to avoid power amplifier overload.

NOTE: All the modes have been tested and recorded worst mode in the report (FPC Antenna).

4.3. On Time and Duty Cycle

LIMIT

None; for reporting purpose only.

TEST PROCEDURE

1. Set the center frequency of the spectrum analyzer to the transmitting frequency;
2. Set the span=0MHz, RBW=8MHz, VBW=50MHz, Sweep time=5ms;
3. Detector = peak;
4. Trace mode = Single hold.

TEST CONFIGURATION

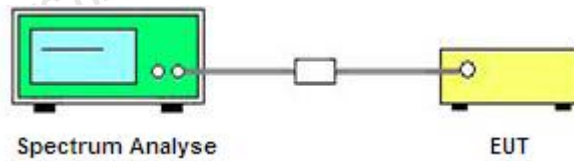

TEST RESULTS

For reporting purpose only.

Please refer to Appendix A.7.

4.4. Maximum Peak Output Power

TEST CONFIGURATION

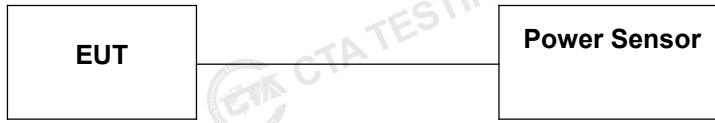

TEST PROCEDURE

According to KDB 558074 D01 15.247 Measurement Guidance v05r02 Section 8.3.1 Maximum peak conducted output power, 8.3.1.3 The maximum peak conducted output power may be measured using a broadband peak RF power meter. The power meter shall have a video bandwidth that is greater than or equal to the DTS bandwidth and shall utilize a fast-responding diode detector.

LIMIT

The Maximum Peak Output Power Measurement is 30dBm.

TEST RESULTS

For reporting purpose only.

Please refer to Appendix A.3.

4.5. Power Spectral Density

TEST CONFIGURATION



TEST PROCEDURE

1. Use this procedure when the maximum peak conducted output power in the fundamental emission is used to demonstrate compliance.
2. Set the RBW = 3 kHz.
3. Set the VBW = 10 KHz.
4. Set the span to 1.5 times the DTS channel bandwidth.
5. Detector = peak.
6. Sweep time = auto couple.
7. Trace mode = max hold.
8. Allow trace to fully stabilize.
9. Use the peak marker function to determine the maximum power level.
10. If measured value exceeds limit, reduce RBW (no less than 3 kHz) and repeat.
11. The resulting peak PSD level must be 8 dBm.

LIMIT

For digitally modulated systems, the power spectral density conducted from the intentional radiator to the antenna shall not be greater than 8 dBm in any 3 kHz band during any time interval of continuous transmission.

TEST RESULTS

For reporting purpose only.

Please refer to Appendix A.4.

4.6. 99% and 6dB Bandwidth

TEST CONFIGURATION

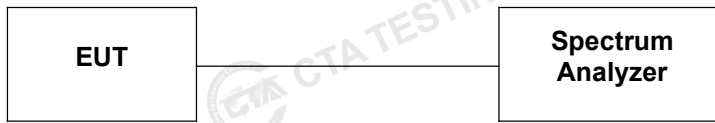

TEST PROCEDURE

The transmitter output was connected to the spectrum analyzer through an attenuator. The bandwidth of the fundamental frequency was measured by spectrum analyzer with RBW=100 KHz and VBW=300KHz.

The 6dB bandwidth is defined as the total spectrum the power of which is higher than peak power minus 6dB. According to KDB 558074 D01 DTS Meas Guidance v05r02 for one of the following procedures may be used to determine the modulated DTS device signal bandwidth.

1. Set RBW = 100 kHz.
2. Set the video bandwidth (VBW) ≥ 3 RBW.
3. Detector = Peak.
4. Trace mode = max hold.
5. Sweep = auto couple.
6. Allow the trace to stabilize.
7. Measure the maximum width of the emission that is constrained by the frequencies associated with the two outermost amplitude points (upper and lower frequencies) that are attenuated by 6 dB relative to the maximum level measured in the fundamental emission.

LIMIT

For digital modulation systems, the minimum 6 dB bandwidth shall be at least 500 kHz

TEST RESULTS

For reporting purpose only.

Please refer to Appendix A.1.

Please refer to Appendix A.2.

4.7. Conducted Spurious Emissions and Band Edge Compliance of RF Emission

TEST REQUIREMENT

In any 100 kHz bandwidth outside the frequency band in which the spread spectrum or digitally modulated device is operating, the RF power that is produced shall be at least 20 dB below that in the 100 kHz bandwidth within the band that contains the highest level of the desired power, based on either an RF conducted or a radiated measurement, provided that the transmitter demonstrates compliance with the peak conducted power limits. If the transmitter complies with the conducted power limits based on the use of root-mean-square averaging over a time interval, as permitted under Section 5.4(4), the attenuation required shall be 30 dB instead of 20dB. Attenuation below the general field strength limits specified in RSS-Gen Issue 4 is not required. Attenuation below the general limits specified in §15.209(a) is not required. In addition, radiated emissions which fall in the restricted bands, as defined in §15.205(a), must also comply with the radiated emission limits specified in §15.209(a) (see §15.205(c)).

TEST CONFIGURATION

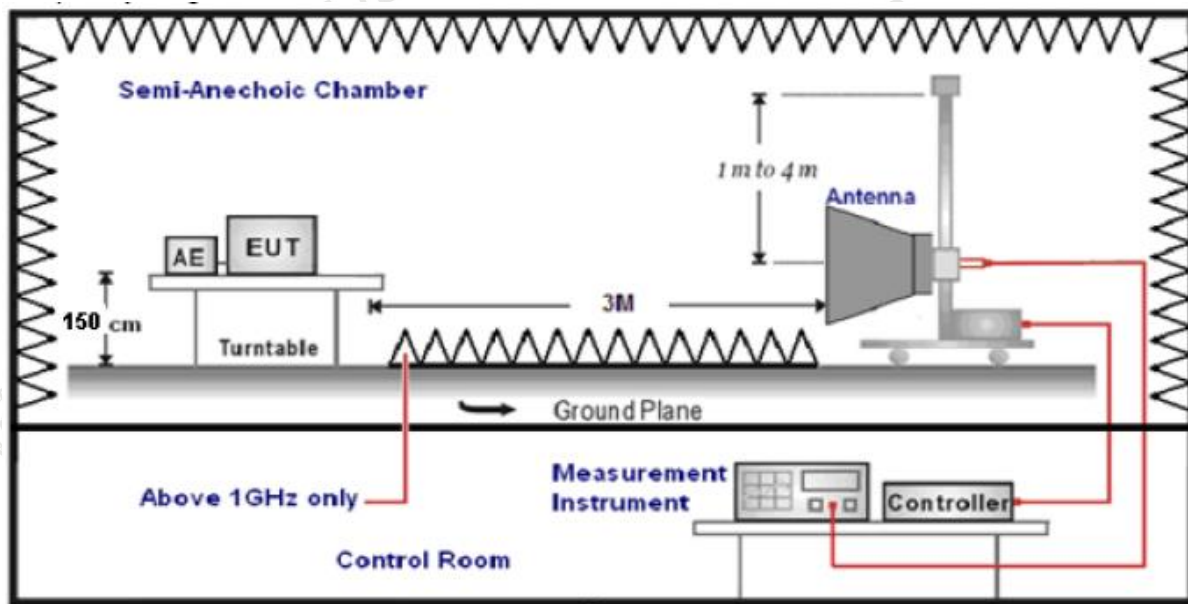

TEST PROCEDURE

- 1.The EUT was placed on a turn table which is 1.5m above ground plane.
- 2.Maximum procedure was performed by raising the receiving antenna from 1m to 4m and rotating the turn table from 0° to 360° to acquire the highest emissions from EUT.
- 3.And also, each emission was to be maximized by changing the polarization of receiving antenna both horizontal and vertical.
- 4.Repeat above procedures until all frequency measurements have been completed..
- 5.The distance between test antenna and EUT was 3 meter:
- 6.Setting test receiver/spectrum as following table states:

Test Frequency range	Test Receiver/Spectrum Setting	Detector
1GHz-40GHz	Peak Value: RBW=1MHz/VBW=3MHz, Sweep time=Auto Average Value: RBW=1MHz/VBW=10Hz, Sweep time=Auto	Peak

LIMIT

Below -20dB of the highest emission level in operating band.
Radiated emissions which fall in the restricted bands, as defined in § 15.205(a), must also comply with the radiated emission limits specified in § 15.209(a)

NOTE: All the modes have been tested and recorded worst mode in the report (FPC Antenna)

TEST RESULTS

4.7.1 For Conducted at Restricted Band Measurement

For reporting purpose only.

Please refer to Appendix A.8.

4.7.2 For Conducted Bandedge Measurement

For reporting purpose only.

Please refer to Appendix A.5.

4.7.3 For Conducted Spurious Emissions Measurement

For reporting purpose only.

Please refer to Appendix A.6.

4.8. Antenna Requirement

Standard Applicable

For intentional device, according to FCC 47 CFR Section 15.203, an intentional radiator shall be designed to ensure that no antenna other than that furnished by the responsible party shall be used with the device.

And according to FCC 47 CFR Section 15.247 (c), if transmitting antennas of directional gain greater than 6dBi are used, the power shall be reduced by the amount in dB that the directional gain of the antenna exceeds 6dBi.

Test Result

The antenna used for this product is Omni&FPC Antenna and that no antenna other than that furnished by the responsible party shall be used with the device, the maximum peak gain of the transmit antenna is only 2.91dBi&4.66dBi.

Reference to the **External photos**.

5. TEST SETUP PHOTOS OF THE EUT

Photo of Radiated Emissions Measurement



Fig. 1

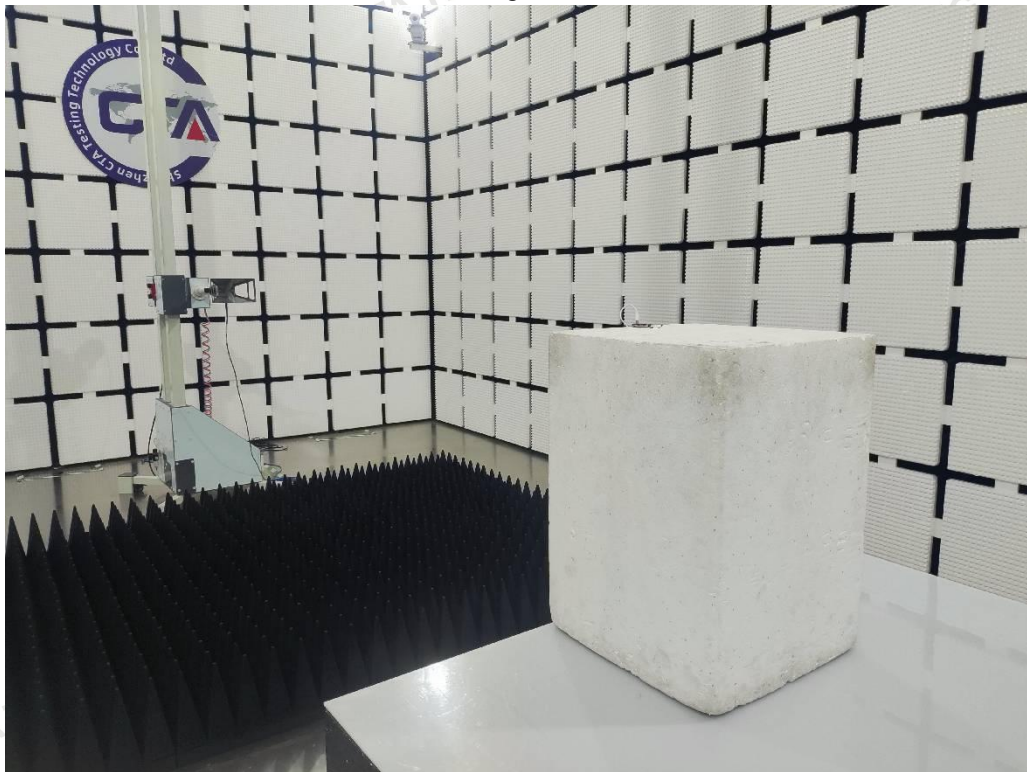

Fig. 2

Photo of Conducted Emission Measurement



Fig. 3

6. EXTERNAL AND INTERNAL PHOTOS OF THE EUT

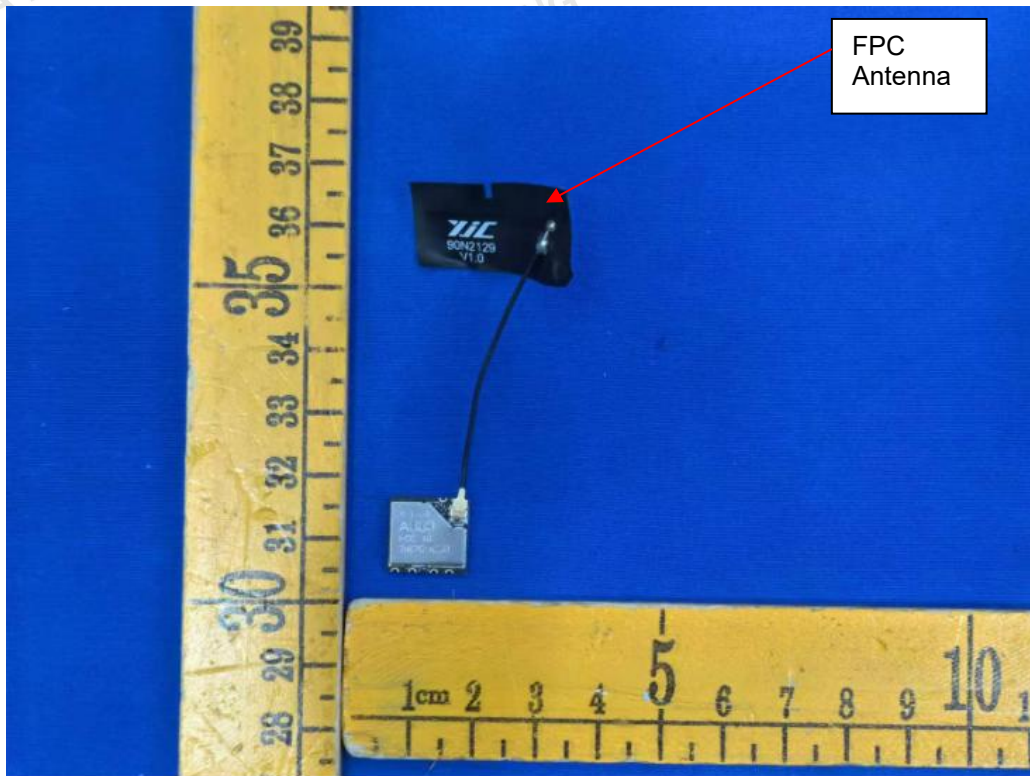

Fig. 1

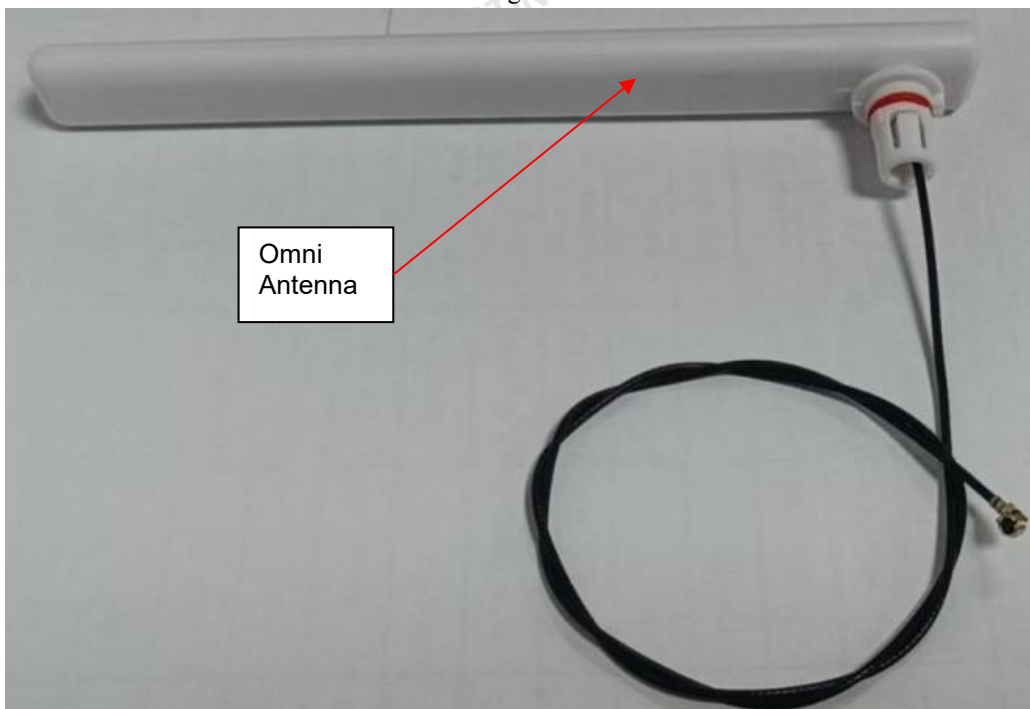

Fig. 2

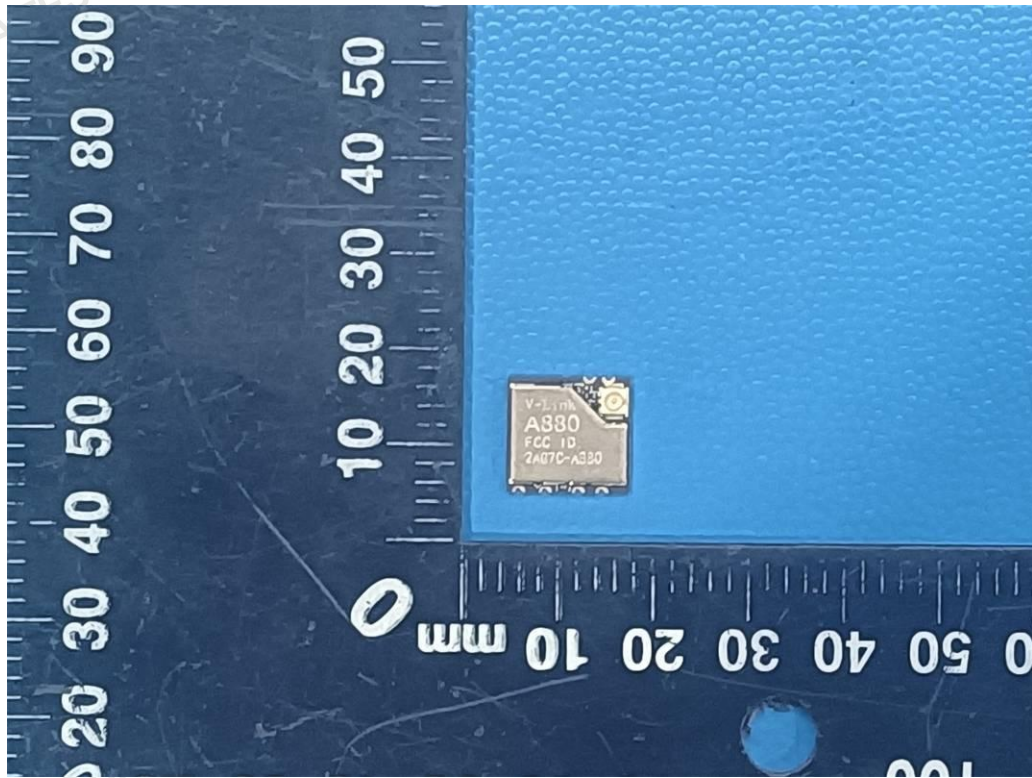

Fig. 3

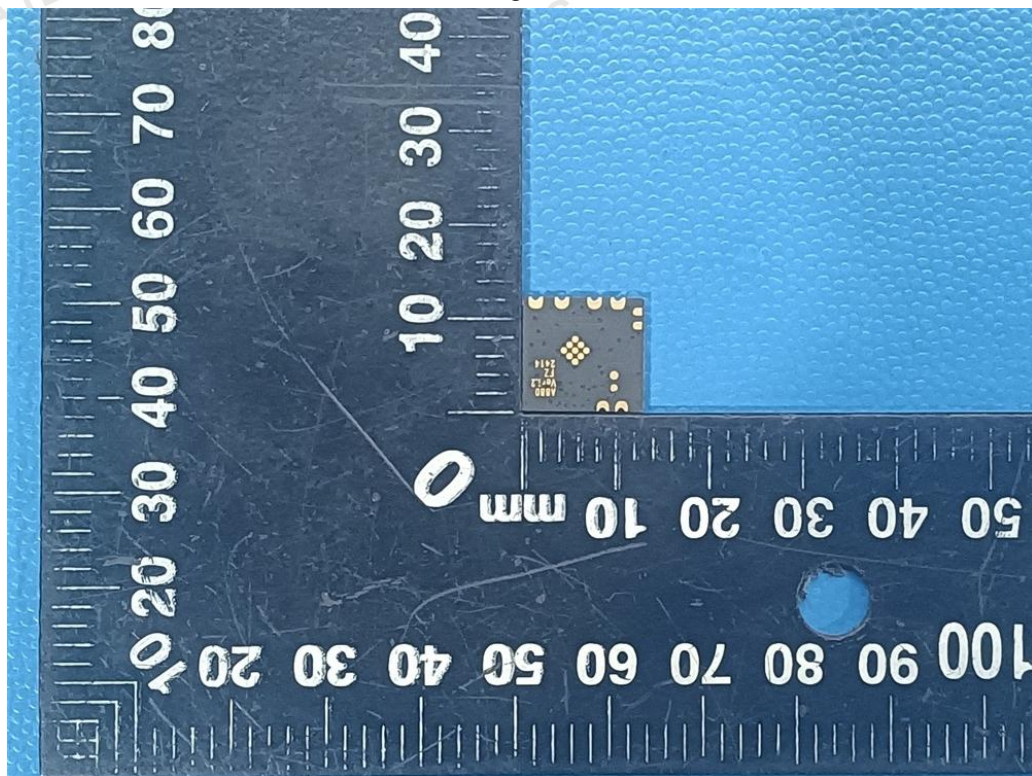

Fig. 4

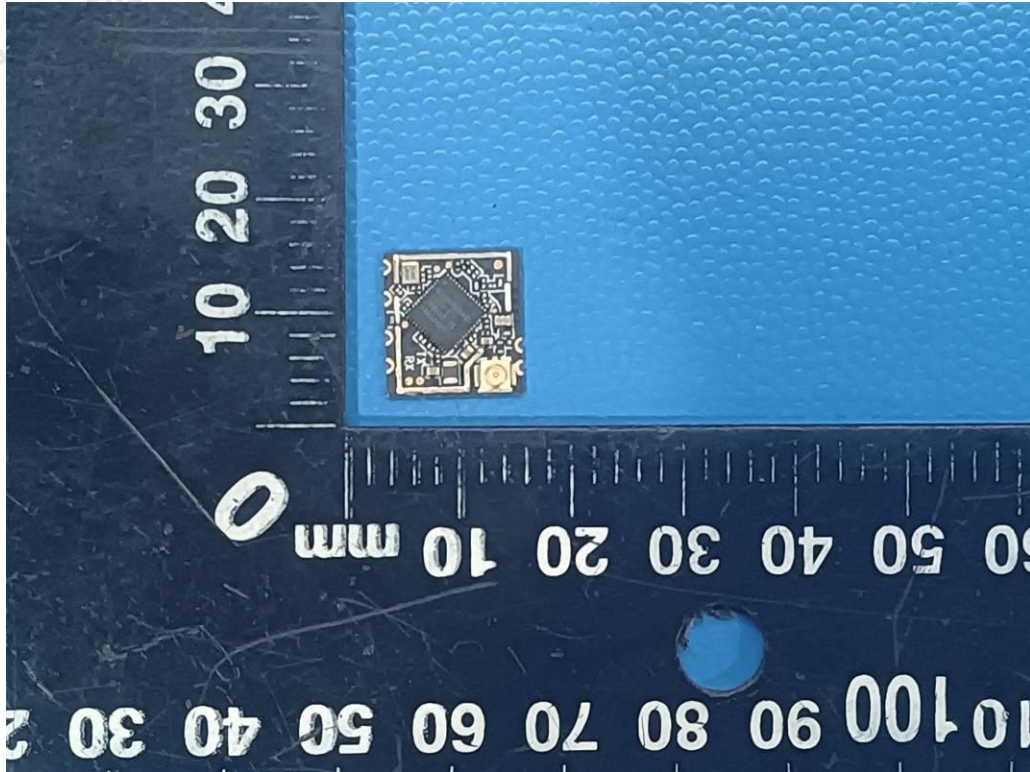

Fig. 5

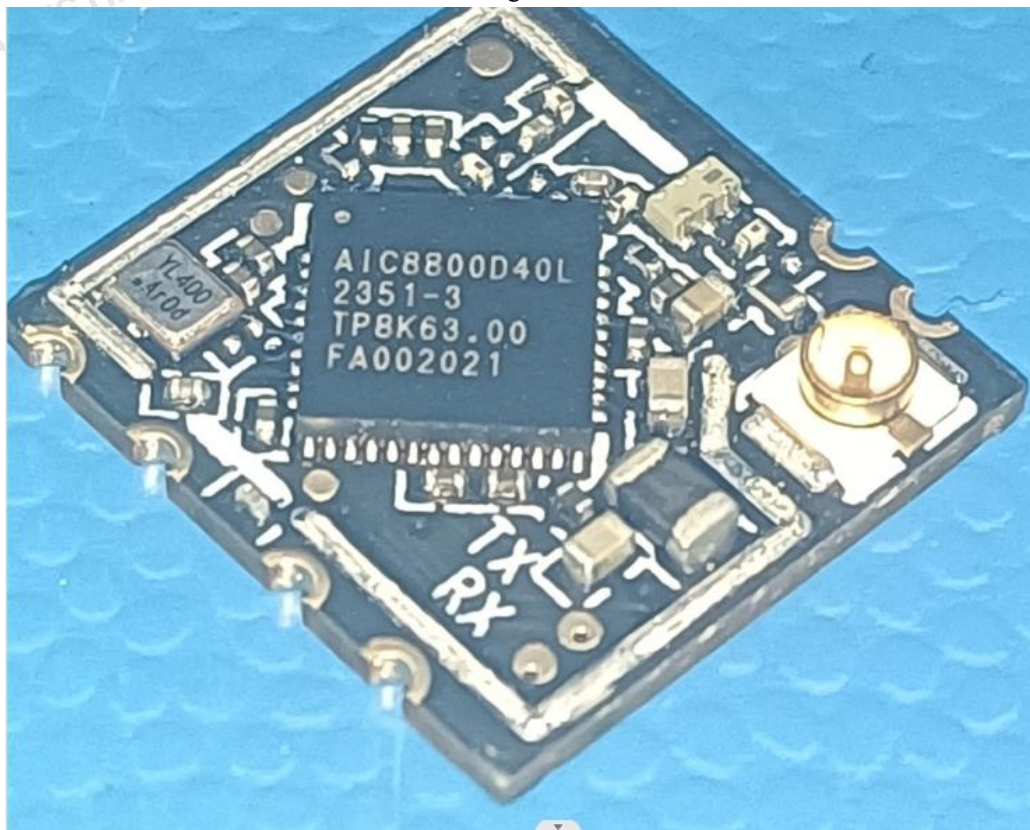

Fig. 6

.....End of Report.....