



## **FCC REPORT**

**Applicant:** BroadSign International LLC

**Address of Applicant:** 453 N Lindbergh Blvd, 2nd Floor, St-Louis, Missouri, United States, 63141

**Equipment Under Test (EUT)**

Product Name: BroadSign Xpress Pro

Model No.: XpressPro

**FCC ID:** 2AF84-XPRESSPRO

**Applicable standards:** FCC CFR Title 47 Part 15 Subpart C Section 15.249:2014

**Date of sample receipt:** November 04,2015

**Date of Test:** November 05-12,2015

**Date of report issued:** November 13,2015

**Test Result :** PASS \*

\* In the configuration tested, the EUT complied with the standards specified above.

Authorized Signature:

**Robinson Lo**

**Laboratory Manager**

This report details the results of the testing carried out on one sample. The results contained in this test report do not relate to other samples of the same product and does not permit the use of the GTS product certification mark. The manufacturer should ensure that all products in series production are in conformity with the product sample detailed in this report.

This report may only be reproduced and distributed in full. If the product in this report is used in any configuration other than that detailed in the report, the manufacturer must ensure the new system complies with all relevant standards. Any mention of GTS or testing done by GTS in connection with, distribution or use of the product described in this report must be approved by GTS in writing.

This document cannot be reproduced except in full, without prior written approval of the Company. Any unauthorized alteration, forgery or falsification of the content or appearance of this document is unlawful and offenders may be prosecuted to the fullest extent of the law. Unless otherwise stated the results shown in this test report refer only to the sample(s) tested and such sample(s) are retained for 90 days only.

## 2 Version

| Version No. | Date             | Description |
|-------------|------------------|-------------|
| 00          | November 13,2015 | Original    |
|             |                  |             |
|             |                  |             |
|             |                  |             |
|             |                  |             |

**Prepared By:** Sam. Gao **Date:** November 13,2015  
**Project Engineer**

**Check By:** hank. yan **Date:** November 13,2015  
**Reviewer**

## 3 Contents

|   | Page |
|---|------|
| 1 COVER PAGE.....   | 1    |
| 2 VERSION.....  | 2    |
| 3 CONTENTS.....   | 3    |
| 4 TEST SUMMARY.....   | 4    |
| 4.1 MEASUREMENT UNCERTAINTY.....                            | 4    |
| 5 GENERAL INFORMATION.....                                  | 5    |
| 5.1 CLIENT INFORMATION.....                                 | 5    |
| 5.2 GENERAL DESCRIPTION OF EUT.....                         | 5    |
| 5.3 TEST MODE.....  | 7    |
| 5.4 DESCRIPTION OF SUPPORT UNITS.....                       | 7    |
| 5.5 TEST FACILITY.....                                      | 7    |
| 5.6 TEST LOCATION.....                                      | 7    |
| 5.7 DESCRIPTION OF SUPPORT UNITS.....                       | 7    |
| 5.8 OTHER INFORMATION REQUESTED BY THE CUSTOMER.....        | 7    |
| 6 TEST INSTRUMENTS LIST.....                                | 8    |
| 7 TEST RESULTS AND MEASUREMENT DATA.....                    | 9    |
| 7.1 ANTENNA REQUIREMENT.....                                | 9    |
| 7.2 CONDUCTED EMISSIONS.....                                | 10   |
| 7.3 RADIATED EMISSION METHOD.....                           | 13   |
| 7.3.1 <i>Field Strength of The Fundamental Signal</i> ..... | 15   |
| 7.3.2 <i>Spurious emissions</i> .....                       | 16   |
| 7.3.3 <i>Bandedge emissions</i> .....                       | 20   |
| 7.4 20dB OCCUPY BANDWIDTH.....                              | 21   |
| 8 TEST SETUP PHOTO.....                                     | 23   |
| 9 EUT CONSTRUCTIONAL DETAILS.....                           | 24   |

## 4 Test Summary

| Test Item                                | Section in CFR 47     | Result |
|--|-----------------------|--------|
| Antenna requirement                      | 15.203                | Pass   |
| AC Power Line Conducted Emission         | 15.207                | Pass   |
| Field strength of the fundamental signal | 15.249 (a)            | Pass   |
| Spurious emissions                       | 15.249 (a) (d)/15.209 | Pass   |
| Band edge                                | 15.249 (d)/15.205     | Pass   |
| 20dB Occupied Bandwidth                  | 15.215 (c)            | Pass   |

*Pass: The EUT complies with the essential requirements in the standard.*

*Remark: Test according to ANSI C63.10 2013 and ANSI C63.4: 2014*

### 4.1 Measurement Uncertainty

| Test Item                        | Frequency Range | Measurement Uncertainty | Notes |
|----------------------------------|-----------------|-------------------------|-------|
| Radiated Emission                | 9kHz ~ 30MHz    | ± 4.34dB                | (1)   |
| Radiated Emission                | 30MHz ~ 1000MHz | ± 4.24dB                | (1)   |
| Radiated Emission                | 1GHz ~ 26.5GHz  | ± 4.68dB                | (1)   |
| AC Power Line Conducted Emission | 0.15MHz ~ 30MHz | ± 3.45dB                | (1)   |

Note (1): The measurement uncertainty is for coverage factor of k=2 and a level of confidence of 95%.

## 5 General Information

### 5.1 Client Information

|                                   |  |
|-----------------------------------|--|
| Applicant:                        | BroadSign International LLC  |
| Address of Applicant:             | 453 N Lindbergh Blvd, 2nd Floor, St-Louis, Missouri, United States, 63141              |
| Manufacturer/ Factory:            | Shenzhen Sunchip Technology Co., Ltd.  |
| Address of Manufacturer/ Factory: | Room 818-831, Building B1, Mingyou Purchasing Center, Bao'an District, Shenzhen, China |

### 5.2 General Description of EUT

|                      |  |
|----------------------|--|
| Product Name:        | BroadSign Xpress Pro   |
| Model No.:           | XpressPro  |
| Operation Frequency: | 2402MHz~2480MHz  |
| Channel numbers:     | 40   |
| Channel separation:  | 2MHz   |
| Modulation type:     | GFSK   |
| Antenna Type:        | Integral antenna   |
| Antenna gain:        | 2.0dBi (declare by Applicant)  |
| Power supply:        | Adapter :<br>Model: XY-AP0503000<br>AC:100-240V, 50/60Hz, 1.0Max<br>DC: 5V, 3.0A |

| Operation Frequency each of channel |           |         |           |         |           |         |           |
|-------------------------------------|-----------|---------|-----------|---------|-----------|---------|-----------|
| Channel                             | Frequency | Channel | Frequency | Channel | Frequency | Channel | Frequency |
| 1                                   | 2402MHz   | 11      | 2422MHz   | 21      | 2442MHz   | 31      | 2462MHz   |
| 2                                   | 2404MHz   | 12      | 2424MHz   | 22      | 2444MHz   | 32      | 2464MHz   |
| ⋮                                   | ⋮         | ⋮       | ⋮         | ⋮       | ⋮         | ⋮       | ⋮         |
| 9                                   | 2418MHz   | 19      | 2438MHz   | 29      | 2458MHz   | 39      | 2478MHz   |
| 10                                  | 2420MHz   | 20      | 2440MHz   | 30      | 2460MHz   | 40      | 2480MHz   |

Note:

In section 15.31(m), regards to the operating frequency range over 10 MHz, the Lowest frequency, the middle frequency, and the highest frequency of channel were selected to perform the test, and the selected channel see below:

| Channel             | Frequency |
|---------------------|-----------|
| The lowest channel  | 2402MHz   |
| The middle channel  | 2440MHz   |
| The Highest channel | 2480MHz   |

### 5.3 Test mode

|   |  |
|---|--|
| Transmitting mode   | Keep the EUT in continuously transmitting mode |
| <p><i>Remark: During the test, the test voltage was tuned from 85% to 115% of the nominal rated supply voltage, and found that the worst case was under the nominal rated supply condition. So the report just shows that condition's data.</i></p> |  |

#### Per-test mode.

We have verified the construction and function in typical operation, The EUT was placed on three different polar directions; i.e. X axis, Y axis, Z axis. which was shown in this test report and defined as follows:

| Axis                   | X     | Y     | Z     |
|------------------------|-------|-------|-------|
| Field Strength(dBuV/m) | 86.94 | 91.06 | 87.68 |

### 5.4 Description of Support Units

| Manufacturer | Description | Model        | Serial Number  | FCC ID/DoC |
|--------------|-------------|--------------|----------------|------------|
| PHILIPS      | LCD TV      | 19PFL3120/T3 | AU1A1212002906 | DoC        |
| DELL         | KEYBOARD    | SK-8115      | N/A            | DoC        |
| DELL         | MOUSE       | MOC5UO       | N/A            | DoC        |

### 5.5 Test Facility

The test facility is recognized, certified, or accredited by the following organizations:

- **FCC —Registration No.: 600491**

Global United Technology Services Co., Ltd., Shenzhen EMC Laboratory has been registered and fully described in a report filed with the (FCC) Federal Communications Commission. The acceptance letter from the FCC is maintained in files. Registration 600491, June 28, 2013.

- **Industry Canada (IC) —Registration No.: 9079A-2**

The 3m Semi-anechoic chamber of Global United Technology Services Co., Ltd. has been registered by Certification and Engineering Bureau of Industry Canada for radio equipment testing with Registration No.: 9079A-2, June 26, 2013.

### 5.6 Test Location

All tests were performed at:

Global United Technology Services Co., Ltd.

Address: Room 301-309, 3th Floor, Block A, Huafeng Jinyuan Business Building, No. 300 Laodong Industrial Zone, Xixiang Road, Baoan District, Shenzhen, China

Tel: 0755-27798480

Fax: 0755-27798960

### 5.7 Description of Support Units

None.

### 5.8 Other Information Requested by the Customer

None.

## 6 Test Instruments list

| Radiated Emission: |                               |                                |                             |               |                     |                         |
|--------------------|-------------------------------|--------------------------------|-----------------------------|---------------|---------------------|-------------------------|
| Item               | Test Equipment                | Manufacturer                   | Model No.                   | Inventory No. | Cal.Date (mm-dd-yy) | Cal.Due date (mm-dd-yy) |
| 1                  | 3m Semi- Anechoic Chamber     | ZhongYu Electron               | 9.2(L)*6.2(W)* 6.4(H)       | GTS250        | Mar. 28 2015        | Mar. 27 2016            |
| 2                  | Control Room                  | ZhongYu Electron               | 6.2(L)*2.5(W)* 2.4(H)       | GTS251        | N/A                 | N/A                     |
| 3                  | Spectrum Analyzer             | Agilent                        | E4440A                      | GTS533        | Jun 30 2015         | Jun 29 2016             |
| 4                  | EMI Test Receiver             | Rohde & Schwarz                | ESU26                       | GTS203        | Jun 30 2015         | Jun 29 2016             |
| 5                  | BiConiLog Antenna             | SCHWARZBECK<br>MESS-ELEKTRONIK | VULB9163                    | GTS214        | Jun 30 2015         | Jun 29 2016             |
| 6                  | Double -ridged waveguide horn | SCHWARZBECK<br>MESS-ELEKTRONIK | 9120D-829                   | GTS208        | June 26 2015        | June 25 2016            |
| 7                  | Horn Antenna                  | ETS-LINDGREN                   | 3160                        | GTS217        | Mar. 27 2015        | Mar. 26 2016            |
| 8                  | EMI Test Software             | AUDIX                          | E3                          | N/A           | N/A                 | N/A                     |
| 9                  | Coaxial Cable                 | GTS                            | N/A                         | GTS213        | Mar. 28 2015        | Mar. 27 2016            |
| 10                 | Coaxial Cable                 | GTS                            | N/A                         | GTS211        | Mar. 28 2015        | Mar. 27 2016            |
| 11                 | Coaxial cable                 | GTS                            | N/A                         | GTS210        | Mar. 28 2015        | Mar. 27 2016            |
| 12                 | Coaxial Cable                 | GTS                            | N/A                         | GTS212        | Mar. 28 2015        | Mar. 27 2016            |
| 13                 | Amplifier(100kHz-3GHz)        | HP                             | 8347A                       | GTS204        | Jun. 30, 2015       | Jun 29 2016             |
| 14                 | Amplifier(2GHz-20GHz)         | HP                             | 8349B                       | GTS206        | Jun. 30, 2015       | Jun 29 2016             |
| 15                 | Amplifier (18-26GHz)          | Rohde & Schwarz                | AFS33-18002<br>650-30-8P-44 | GTS218        | June 26 2015        | June 25 2016            |
| 16                 | Band filter                   | Amindeon                       | 82346                       | GTS219        | Mar. 28 2015        | Mar. 27 2016            |

| Conducted Emission: |                   |                                |                      |               |                     |                         |
|---------------------|-------------------|--------------------------------|----------------------|---------------|---------------------|-------------------------|
| Item                | Test Equipment    | Manufacturer                   | Model No.            | Inventory No. | Cal.Date (mm-dd-yy) | Cal.Due date (mm-dd-yy) |
| 1                   | Shielding Room    | ZhongYu Electron               | 7.0(L)x3.0(W)x3.0(H) | GTS264        | Jun. 30 2015        | Jun. 29 2016            |
| 2                   | EMI Test Receiver | Rohde & Schwarz                | ESCS30               | GTS223        | Jun. 30 2015        | Jun. 29 2016            |
| 3                   | 10dB Pulse Limita | Rohde & Schwarz                | N/A                  | GTS224        | Jun. 30 2015        | Jun. 29 2016            |
| 4                   | Coaxial Switch    | ANRITSU CORP                   | MP59B                | GTS225        | Jun. 30 2015        | Jun. 29 2016            |
| 5                   | LISN              | SCHWARZBECK<br>MESS-ELEKTRONIK | NSLK 8127            | GTS226        | Jun. 30 2015        | Jun. 29 2016            |
| 6                   | Coaxial Cable     | GTS                            | N/A                  | GTS227        | Jun. 30 2015        | Jun. 29 2016            |
| 7                   | EMI Test Software | AUDIX                          | E3                   | N/A           | N/A                 | N/A                     |

| General used equipment: |                |              |           |               |                     |                         |
|-------------------------|----------------|--------------|-----------|---------------|---------------------|-------------------------|
| Item                    | Test Equipment | Manufacturer | Model No. | Inventory No. | Cal.Date (mm-dd-yy) | Cal.Due date (mm-dd-yy) |
| 1                       | Barometer      | ChangChun    | DYM3      | GTS257        | July 07 2015        | July 06 2016            |



## 7 Test results and Measurement Data

### 7.1 Antenna requirement

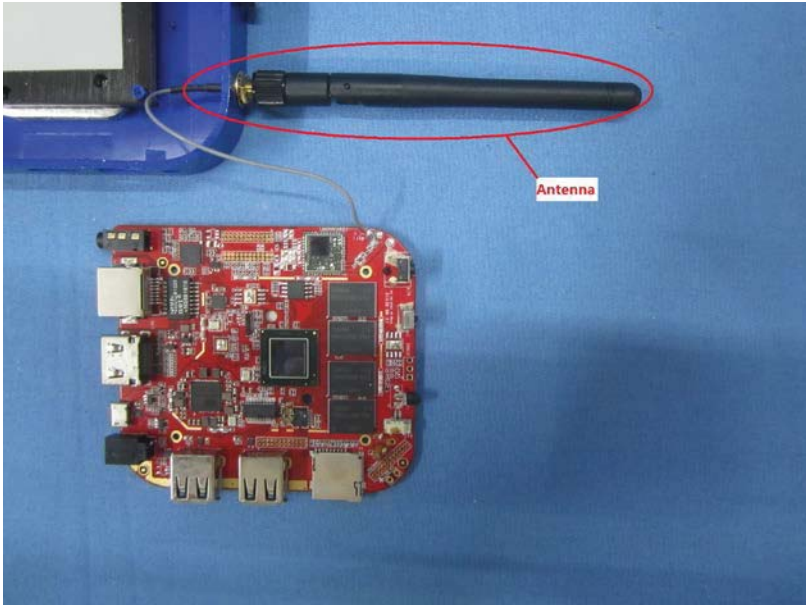
|  |                             |
|--|-----------------------------|
| <b>Standard requirement:</b>   | FCC Part15 C Section 15.203 |
| <b>15.203 requirement:</b><br>An intentional radiator shall be designed to ensure that no antenna other than that furnished by the responsible party shall be used with the device. The use of a permanently attached antenna or of an antenna that uses a unique coupling to the intentional radiator, the manufacturer may design the unit so that a broken antenna can be replaced by the user, but the use of a standard antenna jack or electrical connector is prohibited. |                             |
| <b>EUT Antenna:</b>  |                             |
| <p><i>The antenna is integral antenna, the best case gain of the antenna is 2dBi</i></p>    |                             |

## 7.2 Conducted Emissions

| Test Requirement:     | FCC Part15 C Section 15.207  |                       |              |  |            |         |          |           |           |       |    |    |      |    |    |
|-----------------------|--|-----------------------|--------------|--|------------|---------|----------|-----------|-----------|-------|----|----|------|----|----|
| Test Method:          | ANSI C63.10:2013   |                       |              |  |            |         |          |           |           |       |    |    |      |    |    |
| Test Frequency Range: | 150KHz to 30MHz  |                       |              |  |            |         |          |           |           |       |    |    |      |    |    |
| Class / Severity:     | Class B  |                       |              |  |            |         |          |           |           |       |    |    |      |    |    |
| Receiver setup:       | RBW=9KHz, VBW=30KHz, Sweep time=auto   |                       |              |  |            |         |          |           |           |       |    |    |      |    |    |
| Limit:                | <table border="1"> <thead> <tr> <th rowspan="2">Frequency range (MHz)</th> <th colspan="2">Limit (dBuV)</th> </tr> <tr> <th>Quasi-peak</th> <th>Average</th> </tr> </thead> <tbody> <tr> <td>0.15-0.5</td> <td>66 to 56*</td> <td>56 to 46*</td> </tr> <tr> <td>0.5-5</td> <td>56</td> <td>46</td> </tr> <tr> <td>5-30</td> <td>60</td> <td>50</td> </tr> </tbody> </table> <p>* Decreases with the logarithm of the frequency.</p>  | Frequency range (MHz) | Limit (dBuV) |  | Quasi-peak | Average | 0.15-0.5 | 66 to 56* | 56 to 46* | 0.5-5 | 56 | 46 | 5-30 | 60 | 50 |
| Frequency range (MHz) | Limit (dBuV)   |                       |              |  |            |         |          |           |           |       |    |    |      |    |    |
|                       | Quasi-peak   | Average               |              |  |            |         |          |           |           |       |    |    |      |    |    |
| 0.15-0.5              | 66 to 56*  | 56 to 46*             |              |  |            |         |          |           |           |       |    |    |      |    |    |
| 0.5-5                 | 56   | 46                    |              |  |            |         |          |           |           |       |    |    |      |    |    |
| 5-30                  | 60   | 50                    |              |  |            |         |          |           |           |       |    |    |      |    |    |
| Test setup:           | <p>Remark<br/> E.U.T: Equipment Under Test<br/> LISN: Line Impedance Stabilization Network<br/> Test table height=0.8m</p>   |                       |              |  |            |         |          |           |           |       |    |    |      |    |    |
| Test procedure:       | <ol style="list-style-type: none"> <li>1. The E.U.T and simulators are connected to the main power through a line impedance stabilization network (L.I.S.N.). This provides a 50ohm/50uH coupling impedance for the measuring equipment.</li> <li>2. The peripheral devices are also connected to the main power through a LISN that provides a 50ohm/50uH coupling impedance with 50ohm termination. (Please refer to the block diagram of the test setup and photographs).</li> <li>3. Both sides of A.C. line are checked for maximum conducted interference. In order to find the maximum emission, the relative positions of equipment and all of the interface cables must be changed according to ANSI C63.10:2013 on conducted measurement.</li> </ol> |                       |              |  |            |         |          |           |           |       |    |    |      |    |    |
| Test Instruments:     | Refer to section 6.0 for details   |                       |              |  |            |         |          |           |           |       |    |    |      |    |    |
| Test mode:            | Refer to section 5.3 for details   |                       |              |  |            |         |          |           |           |       |    |    |      |    |    |
| Test results:         | Pass   |                       |              |  |            |         |          |           |           |       |    |    |      |    |    |

### Measurement data:

Line:

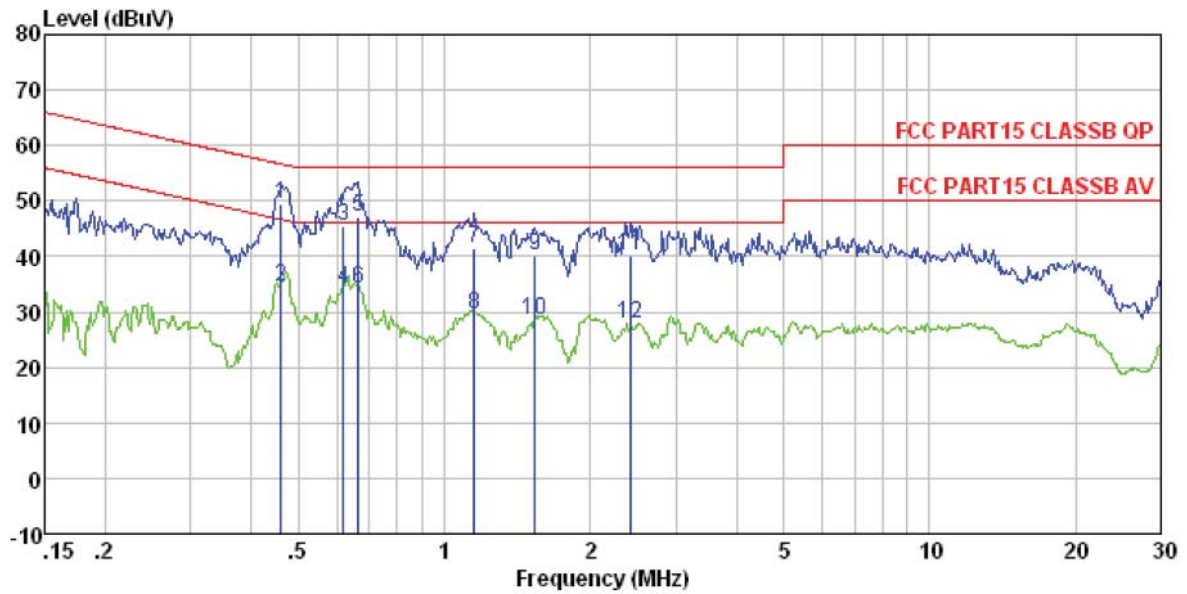

Condition : FCC PART15 CLASSB QP LISN-2013 LINE  
 Job No. : 1924RF  
 Test mode : Bluetooth4.0 mode  
 Test Engineer: Rong

|    | Read Freq | LISN Level | Cable Factor | Cable Loss | Level | Limit Line | Over Limit | Remark  |
|----|-----------|------------|--------------|------------|-------|------------|------------|---------|
|    | MHz       | dBuV       | dB           | dB         | dBuV  | dBuV       | dB         |         |
| 1  | 0.461     | 49.07      | 0.12         | 0.11       | 49.30 | 56.67      | -7.37      | QP      |
| 2  | 0.461     | 34.27      | 0.12         | 0.11       | 34.50 | 46.67      | -12.17     | Average |
| 3  | 0.621     | 45.21      | 0.13         | 0.12       | 45.46 | 56.00      | -10.54     | QP      |
| 4  | 0.621     | 33.86      | 0.13         | 0.12       | 34.11 | 46.00      | -11.89     | Average |
| 5  | 0.665     | 46.71      | 0.14         | 0.13       | 46.98 | 56.00      | -9.02      | QP      |
| 6  | 0.665     | 33.86      | 0.14         | 0.13       | 34.13 | 46.00      | -11.87     | Average |
| 7  | 1.153     | 41.19      | 0.13         | 0.13       | 41.45 | 56.00      | -14.55     | QP      |
| 8  | 1.153     | 29.28      | 0.13         | 0.13       | 29.54 | 46.00      | -16.46     | Average |
| 9  | 1.535     | 40.02      | 0.12         | 0.14       | 40.28 | 56.00      | -15.72     | QP      |
| 10 | 1.535     | 28.20      | 0.12         | 0.14       | 28.46 | 46.00      | -17.54     | Average |
| 11 | 2.422     | 39.86      | 0.13         | 0.15       | 40.14 | 56.00      | -15.86     | QP      |
| 12 | 2.422     | 27.47      | 0.13         | 0.15       | 27.75 | 46.00      | -18.25     | Average |

**Neutral:**

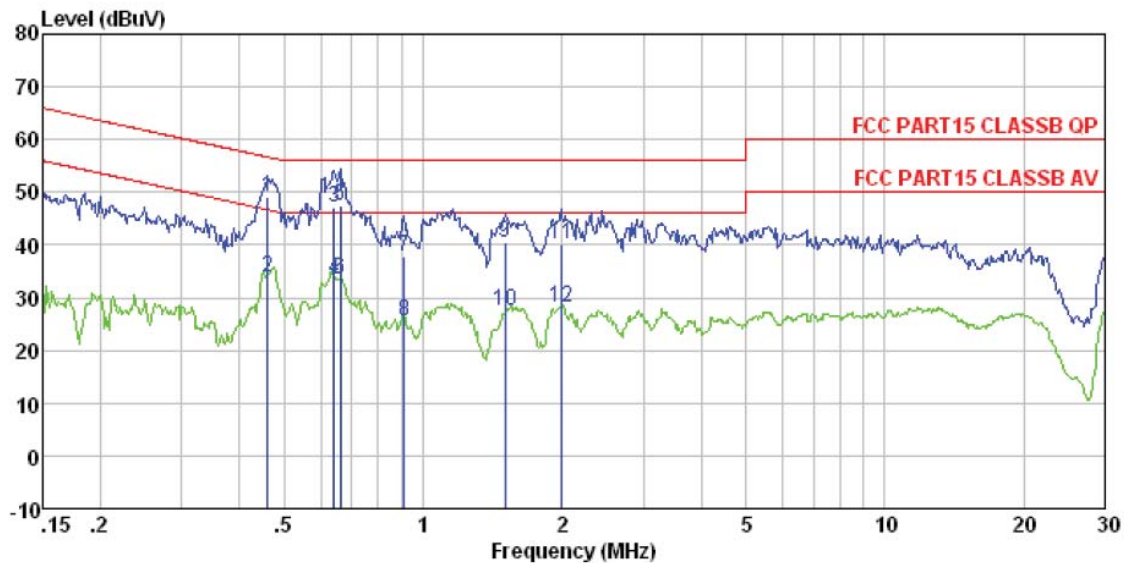

Condition : FCC PART15 CLASSB QP LISN-2013 NEUTRAL  
 Job No. : 1924RF  
 Test mode : Bluetooth4.0 mode  
 Test Engineer: Rong

|    | Read Freq | Read Level | LISN Factor | Cable Loss | Level | Limit Line | Over Limit | Remark  |
|----|-----------|------------|-------------|------------|-------|------------|------------|---------|
|    | MHz       | dBuV       | dB          | dB         | dBuV  | dBuV       | dB         |         |
| 1  | 0.461     | 49.01      | 0.06        | 0.11       | 49.18 | 56.67      | -7.49      | QP      |
| 2  | 0.461     | 33.68      | 0.06        | 0.11       | 33.85 | 46.67      | -12.82     | Average |
| 3  | 0.641     | 46.92      | 0.07        | 0.13       | 47.12 | 56.00      | -8.88      | QP      |
| 4  | 0.641     | 33.25      | 0.07        | 0.13       | 33.45 | 46.00      | -12.55     | Average |
| 5  | 0.661     | 47.36      | 0.07        | 0.13       | 47.56 | 56.00      | -8.44      | QP      |
| 6  | 0.661     | 33.17      | 0.07        | 0.13       | 33.37 | 46.00      | -12.63     | Average |
| 7  | 0.909     | 37.47      | 0.07        | 0.13       | 37.67 | 56.00      | -18.33     | QP      |
| 8  | 0.909     | 25.23      | 0.07        | 0.13       | 25.43 | 46.00      | -20.57     | Average |
| 9  | 1.503     | 40.19      | 0.09        | 0.14       | 40.42 | 56.00      | -15.58     | QP      |
| 10 | 1.503     | 27.30      | 0.09        | 0.14       | 27.53 | 46.00      | -18.47     | Average |
| 11 | 1.991     | 40.04      | 0.09        | 0.15       | 40.28 | 56.00      | -15.72     | QP      |
| 12 | 1.991     | 28.07      | 0.09        | 0.15       | 28.31 | 46.00      | -17.69     | Average |

**Notes:**

1. An initial pre-scan was performed on the line and neutral lines with peak detector.
2. Quasi-Peak and Average measurement were performed at the frequencies with maximized peak emission.
3. Final Level = Receiver Read level + LISN Factor + Cable Loss
4. *If the average limit is met when using a quasi-peak detector receiver, the EUT shall be deemed to meet both limits and measurement with the average detector receiver is unnecessary.*

## 7.3 Radiated Emission Method

|  |  |                    |        |                  |                  |
|--|--|--------------------|--------|------------------|------------------|
| Test Requirement:                                    | FCC Part15 C Section 15.209  |                    |        |                  |                  |
| Test Method:   | ANSI C63.10:2013   |                    |        |                  |                  |
| Test Frequency Range:                                | 30MHz to 25GHz   |                    |        |                  |                  |
| Test site:   | Measurement Distance: 3m   |                    |        |                  |                  |
| Receiver setup:                                      | Frequency  | Detector           | RBW    | VBW              | Remark           |
|  | 30MHz-1GHz   | Quasi-peak         | 120KHz | 300KHz           | Quasi-peak Value |
|  | Above 1GHz   | Peak               | 1MHz   | 3MHz             | Peak Value       |
|  |  | Peak               | 1MHz   | 10Hz             | Average Value    |
| Limit:<br>(Field strength of the fundamental signal) | Frequency  | Limit (dBuV/m @3m) |        | Remark           |                  |
|  | 2400MHz-2483.5MHz  | 94.00              |        | Average Value    |                  |
| Limit:<br>(Spurious Emissions)                       | Frequency  | Limit (dBuV/m @3m) |        | Remark           |                  |
|  | 30MHz-88MHz  | 40.00              |        | Quasi-peak Value |                  |
|  | 88MHz-216MHz   | 43.50              |        | Quasi-peak Value |                  |
|  | 216MHz-960MHz  | 46.00              |        | Quasi-peak Value |                  |
|  | 960MHz-1GHz  | 54.00              |        | Quasi-peak Value |                  |
|  | Above 1GHz   | 54.00              |        | Average Value    |                  |
| 74.00  |  | Peak Value         |        |                  |                  |
| Limit:<br>(band edge)                                | Emissions radiated outside of the specified frequency bands, except for harmonics, shall be attenuated by at least 50 dB below the level of the fundamental or to the general radiated emission limits in Section 15.209, whichever is the lesser attenuation. |                    |        |                  |                  |
| Test setup:  | <p>Below 1GHz</p> <p>Above 1GHz</p>  |                    |        |                  |                  |

|                          |  |
|--------------------------|--|
|                          | <p>The diagram illustrates the test setup. An EUT (Equipment Under Test) is placed on a Turn Table. The Turn Table is positioned 3 meters away from an Antenna Tower. The Antenna Tower has a Horn Antenna mounted on it. The antenna height is varied from 1 meter to 4 meters above the ground. The Turn Table is 1.5 meters high, and the antenna is 1 meter high. A Spectrum Analyzer is connected to the Antenna Tower via an Amplifier.</p>  |
| <p>Test Procedure:</p>   | <ol style="list-style-type: none"> <li>1. The EUT was placed on the top of a rotating table (0.8m for below 1GHz and 1.5 meters for above 1GHz) above the ground at a 3 meter camber. The table was rotated 360 degrees to determine the position of the highest radiation.</li> <li>2. The EUT was set 3 meters away from the interference-receiving antenna, which was mounted on the top of a variable-height antenna tower.</li> <li>3. The antenna height is varied from one meter to four meters above the ground to determine the maximum value of the field strength. Both horizontal and vertical polarizations of the antenna are set to make the measurement.</li> <li>4. For each suspected emission, the EUT was arranged to its worst case and then the antenna was tuned to heights from 1 meter to 4 meters and the rota table was turned from 0 degrees to 360 degrees to find the maximum reading.</li> <li>5. The test-receiver system was set to Peak Detect Function and Specified Bandwidth with Maximum Hold Mode.</li> <li>6. If the emission level of the EUT in peak mode was 10dB lower than the limit specified, then testing could be stopped and the peak values of the EUT would be reported. Otherwise the emissions that did not have 10dB margin would be re-tested one by one using peak, quasi-peak or average method as specified and then reported in a data sheet.</li> </ol> |
| <p>Test Instruments:</p> | <p>Refer to section 6.0 for details</p>  |
| <p>Test mode:</p>        | <p>Refer to section 5.3 for details</p>  |
| <p>Test results:</p>     | <p>Pass</p>  |

**Measurement data:**



### 7.3.1 Field Strength of The Fundamental Signal

**Peak value:**

| Frequency (MHz) | Read Level (dBuV) | Antenna Factor (dB/m) | Cable Loss (dB) | Preamp Factor (dB) | Level (dBuV/m) | Limit Line (dBuV/m) | Over Limit (dB) | polarization |
|-----------------|-------------------|-----------------------|-----------------|--------------------|----------------|---------------------|-----------------|--------------|
| 2402.00         | 87.19             | 27.58                 | 5.39            | 30.18              | 89.98          | 114.00              | -24.02          | Vertical     |
| 2402.00         | 85.44             | 27.58                 | 5.39            | 30.18              | 88.23          | 114.00              | -25.77          | Horizontal   |
| 2440.00         | 85.95             | 27.55                 | 5.43            | 30.06              | 88.87          | 114.00              | -25.13          | Vertical     |
| 2440.00         | 84.55             | 27.55                 | 5.43            | 30.06              | 87.47          | 114.00              | -26.53          | Horizontal   |
| 2480.00         | 88.00             | 27.52                 | 5.47            | 29.93              | 91.06          | 114.00              | -22.94          | Vertical     |
| 2480.00         | 85.50             | 27.52                 | 5.47            | 29.93              | 88.56          | 114.00              | -25.44          | Horizontal   |

**Average value:**

| Frequency (MHz) | Read Level (dBuV) | Antenna Factor (dB/m) | Cable Loss (dB) | Preamp Factor (dB) | Level (dBuV/m) | Limit Line (dBuV/m) | Over Limit (dB) | polarization |
|-----------------|-------------------|-----------------------|-----------------|--------------------|----------------|---------------------|-----------------|--------------|
| 2402.00         | 77.05             | 27.58                 | 5.39            | 30.18              | 79.84          | 94.00               | -14.16          | Vertical     |
| 2402.00         | 75.20             | 27.58                 | 5.39            | 30.18              | 77.99          | 94.00               | -16.01          | Horizontal   |
| 2440.00         | 75.55             | 27.55                 | 5.43            | 30.06              | 78.47          | 94.00               | -15.53          | Vertical     |
| 2440.00         | 72.84             | 27.55                 | 5.43            | 30.06              | 75.76          | 94.00               | -18.24          | Horizontal   |
| 2480.00         | 77.77             | 27.52                 | 5.47            | 29.93              | 80.83          | 94.00               | -13.17          | Vertical     |
| 2480.00         | 75.32             | 27.52                 | 5.47            | 29.93              | 78.38          | 94.00               | -15.62          | Horizontal   |

Remark: RBW 3MHz, VBW 10MHz , peak detector for PK value, RBW 3MHz, VBW 10MHz AV detector for AV value

## 7.3.2 Spurious emissions

### ■ Below 1GHz

| Frequency (MHz) | Read Level (dBuV) | Antenna Factor (dB/m) | Cable Loss (dB) | Preamp Factor (dB) | Level (dBuV/m) | Limit Line (dBuV/m) | Over Limit (dB) | polarization |
|-----------------|-------------------|-----------------------|-----------------|--------------------|----------------|---------------------|-----------------|--------------|
| 37.42           | 38.25             | 14.92                 | 0.64            | 30.06              | 23.75          | 40.00               | -16.25          | Vertical     |
| 57.59           | 34.94             | 14.85                 | 0.84            | 29.94              | 20.69          | 40.00               | -19.31          | Vertical     |
| 124.57          | 48.80             | 11.80                 | 1.40            | 29.54              | 32.46          | 43.50               | -11.04          | Vertical     |
| 251.18          | 37.17             | 14.07                 | 2.13            | 29.65              | 23.72          | 46.00               | -22.28          | Vertical     |
| 366.82          | 43.84             | 16.48                 | 2.70            | 29.65              | 33.37          | 46.00               | -12.63          | Vertical     |
| 670.49          | 35.27             | 20.71                 | 3.98            | 29.23              | 30.73          | 46.00               | -15.27          | Vertical     |
| 38.89           | 29.16             | 15.30                 | 0.65            | 30.05              | 15.06          | 40.00               | -24.94          | Horizontal   |
| 80.93           | 36.46             | 10.84                 | 1.04            | 29.79              | 18.55          | 40.00               | -21.45          | Horizontal   |
| 163.76          | 40.89             | 10.77                 | 1.65            | 29.34              | 23.97          | 43.50               | -19.53          | Horizontal   |
| 295.15          | 41.24             | 14.95                 | 2.34            | 29.97              | 28.56          | 46.00               | -17.44          | Horizontal   |
| 513.63          | 42.93             | 18.89                 | 3.36            | 29.30              | 35.88          | 46.00               | -10.12          | Horizontal   |
| 854.03          | 40.33             | 22.64                 | 4.68            | 29.14              | 38.51          | 46.00               | -7.49           | Horizontal   |



■ Above 1GHz

|               |                |
|---------------|----------------|
| Test channel: | Lowest channel |
|---------------|----------------|

**Peak value:**

| Frequency (MHz) | Read Level (dBuV) | Antenna Factor (dB/m) | Cable Loss (dB) | Preamp Factor (dB) | Level (dBuV/m) | Limit Line (dBuV/m) | Over Limit (dB) | polarization |
|-----------------|-------------------|-----------------------|-----------------|--------------------|----------------|---------------------|-----------------|--------------|
| 4804.00         | 35.34             | 31.78                 | 8.60            | 32.09              | 43.63          | 74.00               | -30.37          | Vertical     |
| 7206.00         | 30.52             | 36.15                 | 11.65           | 32.00              | 46.32          | 74.00               | -27.68          | Vertical     |
| 9608.00         | 30.31             | 37.95                 | 14.14           | 31.62              | 50.78          | 74.00               | -23.22          | Vertical     |
| 12010.00        | *                 |                       |                 |                    |                | 74.00               |                 | Vertical     |
| 14412.00        | *                 |                       |                 |                    |                | 74.00               |                 | Vertical     |
| 4804.00         | 39.22             | 31.78                 | 8.60            | 32.09              | 47.51          | 74.00               | -26.49          | Horizontal   |
| 7206.00         | 32.11             | 36.15                 | 11.65           | 32.00              | 47.91          | 74.00               | -26.09          | Horizontal   |
| 9608.00         | 29.54             | 37.95                 | 14.14           | 31.62              | 50.01          | 74.00               | -23.99          | Horizontal   |
| 12010.00        | *                 |                       |                 |                    |                | 74.00               |                 | Horizontal   |
| 14412.00        | *                 |                       |                 |                    |                | 74.00               |                 | Horizontal   |

**Average value:**

| Frequency (MHz) | Read Level (dBuV) | Antenna Factor (dB/m) | Cable Loss (dB) | Preamp Factor (dB) | Level (dBuV/m) | Limit Line (dBuV/m) | Over Limit (dB) | polarization |
|-----------------|-------------------|-----------------------|-----------------|--------------------|----------------|---------------------|-----------------|--------------|
| 4804.00         | 24.52             | 31.78                 | 8.60            | 32.09              | 32.81          | 54.00               | -21.19          | Vertical     |
| 7206.00         | 19.43             | 36.15                 | 11.65           | 32.00              | 35.23          | 54.00               | -18.77          | Vertical     |
| 9608.00         | 18.63             | 37.95                 | 14.14           | 31.62              | 39.10          | 54.00               | -14.90          | Vertical     |
| 12010.00        | *                 |                       |                 |                    |                | 54.00               |                 | Vertical     |
| 14412.00        | *                 |                       |                 |                    |                | 54.00               |                 | Vertical     |
| 4804.00         | 28.53             | 31.78                 | 8.60            | 32.09              | 36.82          | 54.00               | -17.18          | Horizontal   |
| 7206.00         | 21.48             | 36.15                 | 11.65           | 32.00              | 37.28          | 54.00               | -16.72          | Horizontal   |
| 9608.00         | 18.20             | 37.95                 | 14.14           | 31.62              | 38.67          | 54.00               | -15.33          | Horizontal   |
| 12010.00        | *                 |                       |                 |                    |                | 54.00               |                 | Horizontal   |
| 14412.00        | *                 |                       |                 |                    |                | 54.00               |                 | Horizontal   |

**Remark:**

1. Final Level = Receiver Read level + Antenna Factor + Cable Loss – Preamplifier Factor
2. “\*”, means this data is the too weak instrument of signal is unable to test.

|               |        |
|---------------|--------|
| Test channel: | Middle |
|---------------|--------|

**Peak value:**

| Frequency (MHz) | Read Level (dBuV) | Antenna Factor (dB/m) | Cable Loss (dB) | Preamp Factor (dB) | Level (dBuV/m) | Limit Line (dBuV/m) | Over Limit (dB) | polarization |
|-----------------|-------------------|-----------------------|-----------------|--------------------|----------------|---------------------|-----------------|--------------|
| 4884.00         | 35.33             | 31.85                 | 8.67            | 32.12              | 43.73          | 74.00               | -30.27          | Vertical     |
| 7326.00         | 30.52             | 36.37                 | 11.72           | 31.89              | 46.72          | 74.00               | -27.28          | Vertical     |
| 9768.00         | 30.30             | 38.35                 | 14.25           | 31.62              | 51.28          | 74.00               | -22.72          | Vertical     |
| 12210.00        | *                 |                       |                 |                    |                | 74.00               |                 | Vertical     |
| 14652.00        | *                 |                       |                 |                    |                | 74.00               |                 | Vertical     |
| 4884.00         | 39.22             | 31.85                 | 8.67            | 32.12              | 47.62          | 74.00               | -26.38          | Horizontal   |
| 7326.00         | 32.10             | 36.37                 | 11.72           | 31.89              | 48.30          | 74.00               | -25.70          | Horizontal   |
| 9768.00         | 29.54             | 38.35                 | 14.25           | 31.62              | 50.52          | 74.00               | -23.48          | Horizontal   |
| 12210.00        | *                 |                       |                 |                    |                | 74.00               |                 | Horizontal   |
| 14652.00        | *                 |                       |                 |                    |                | 74.00               |                 | Horizontal   |

**Average value:**

| Frequency (MHz) | Read Level (dBuV) | Antenna Factor (dB/m) | Cable Loss (dB) | Preamp Factor (dB) | Level (dBuV/m) | Limit Line (dBuV/m) | Over Limit (dB) | polarization |
|-----------------|-------------------|-----------------------|-----------------|--------------------|----------------|---------------------|-----------------|--------------|
| 4884.00         | 24.52             | 31.85                 | 8.67            | 32.12              | 32.92          | 54.00               | -21.08          | Vertical     |
| 7326.00         | 19.43             | 36.37                 | 11.72           | 31.89              | 35.63          | 54.00               | -18.37          | Vertical     |
| 9768.00         | 18.63             | 38.35                 | 14.25           | 31.62              | 39.61          | 54.00               | -14.39          | Vertical     |
| 12210.00        | *                 |                       |                 |                    |                | 54.00               |                 | Vertical     |
| 14652.00        | *                 |                       |                 |                    |                | 54.00               |                 | Vertical     |
| 4884.00         | 28.53             | 31.85                 | 8.67            | 32.12              | 36.93          | 54.00               | -17.07          | Horizontal   |
| 7326.00         | 21.48             | 36.37                 | 11.72           | 31.89              | 37.68          | 54.00               | -16.32          | Horizontal   |
| 9768.00         | 18.20             | 38.35                 | 14.25           | 31.62              | 39.18          | 54.00               | -14.82          | Horizontal   |
| 12210.00        | *                 |                       |                 |                    |                | 54.00               |                 | Horizontal   |
| 14652.00        | *                 |                       |                 |                    |                | 54.00               |                 | Horizontal   |

**Remark:**

1. Final Level = Receiver Read level + Antenna Factor + Cable Loss – Pre-amplifier Factor
2. “\*”, means this data is the too weak instrument of signal is unable to test.

|               |         |
|---------------|---------|
| Test channel: | Highest |
|---------------|---------|

**Peak value:**

| Frequency (MHz) | Read Level (dBuV) | Antenna Factor (dB/m) | Cable Loss (dB) | Preamp Factor (dB) | Level (dBuV/m) | Limit Line (dBuV/m) | Over Limit (dB) | polarization |
|-----------------|-------------------|-----------------------|-----------------|--------------------|----------------|---------------------|-----------------|--------------|
| 4960.00         | 35.08             | 31.93                 | 8.73            | 32.16              | 43.58          | 74.00               | -30.42          | Vertical     |
| 7440.00         | 30.35             | 36.59                 | 11.79           | 31.78              | 46.95          | 74.00               | -27.05          | Vertical     |
| 9920.00         | 30.15             | 38.81                 | 14.38           | 31.88              | 51.46          | 74.00               | -22.54          | Vertical     |
| 12400.00        | *                 |                       |                 |                    |                | 74.00               |                 | Vertical     |
| 14880.00        | *                 |                       |                 |                    |                | 74.00               |                 | Vertical     |
| 4960.00         | 38.91             | 31.93                 | 8.73            | 32.16              | 47.41          | 74.00               | -26.59          | Horizontal   |
| 7440.00         | 31.91             | 36.59                 | 11.79           | 31.78              | 48.51          | 74.00               | -25.49          | Horizontal   |
| 9920.00         | 29.37             | 38.81                 | 14.38           | 31.88              | 50.68          | 74.00               | -23.32          | Horizontal   |
| 12400.00        | *                 |                       |                 |                    |                | 74.00               |                 | Horizontal   |
| 14880.00        | *                 |                       |                 |                    |                | 74.00               |                 | Horizontal   |

**Average value:**

| Frequency (MHz) | Read Level (dBuV) | Antenna Factor (dB/m) | Cable Loss (dB) | Preamp Factor (dB) | Level (dBuV/m) | Limit Line (dBuV/m) | Over Limit (dB) | polarization |
|-----------------|-------------------|-----------------------|-----------------|--------------------|----------------|---------------------|-----------------|--------------|
| 4960.00         | 24.33             | 31.93                 | 8.73            | 32.16              | 32.83          | 54.00               | -21.17          | Vertical     |
| 7440.00         | 19.30             | 36.59                 | 11.79           | 31.78              | 35.90          | 54.00               | -18.10          | Vertical     |
| 9920.00         | 18.52             | 38.81                 | 14.38           | 31.88              | 39.83          | 54.00               | -14.17          | Vertical     |
| 12400.00        | *                 |                       |                 |                    |                | 54.00               |                 | Vertical     |
| 14880.00        | *                 |                       |                 |                    |                | 54.00               |                 | Vertical     |
| 4960.00         | 28.31             | 31.93                 | 8.73            | 32.16              | 36.81          | 54.00               | -17.19          | Horizontal   |
| 7440.00         | 21.33             | 36.59                 | 11.79           | 31.78              | 37.93          | 54.00               | -16.07          | Horizontal   |
| 9920.00         | 18.06             | 38.81                 | 14.38           | 31.88              | 39.37          | 54.00               | -14.63          | Horizontal   |
| 12400.00        | *                 |                       |                 |                    |                | 54.00               |                 | Horizontal   |
| 14880.00        | *                 |                       |                 |                    |                | 54.00               |                 | Horizontal   |

*Remark:*

1. *Final Level = Receiver Read level + Antenna Factor + Cable Loss – Pre-amplifier Factor*
2. *“\*”, means this data is the too weak instrument of signal is unable to test.*
3. *The emission levels of other frequencies are very lower than the limit and not show in test report.*

### 7.3.3 Bandedge emissions

All of the restriction bands were tested, and only the data of worst case was exhibited.

|               |                |
|---------------|----------------|
| Test channel: | Lowest channel |
|---------------|----------------|

**Peak value:**

| Frequency (MHz) | Read Level (dBuV) | Antenna Factor (dB/m) | Cable Loss (dB) | Preamp Factor (dB) | Level (dBuV/m) | Limit Line (dBuV/m) | Over Limit (dB) | Polarization |
|-----------------|-------------------|-----------------------|-----------------|--------------------|----------------|---------------------|-----------------|--------------|
| 2390.00         | 37.51             | 27.59                 | 5.38            | 30.18              | 40.30          | 74.00               | -33.70          | Horizontal   |
| 2400.00         | 53.54             | 27.58                 | 5.39            | 30.18              | 56.33          | 74.00               | -17.67          | Horizontal   |
| 2390.00         | 37.55             | 27.59                 | 5.38            | 30.18              | 40.34          | 74.00               | -33.66          | Vertical     |
| 2400.00         | 55.00             | 27.58                 | 5.39            | 30.18              | 57.79          | 74.00               | -16.21          | Vertical     |

**Average value:**

| Frequency (MHz) | Read Level (dBuV) | Antenna Factor (dB/m) | Cable Loss (dB) | Preamp Factor (dB) | Level (dBuV/m) | Limit Line (dBuV/m) | Over Limit (dB) | Polarization |
|-----------------|-------------------|-----------------------|-----------------|--------------------|----------------|---------------------|-----------------|--------------|
| 2390.00         | 29.28             | 27.59                 | 5.38            | 30.18              | 32.07          | 54.00               | -21.93          | Horizontal   |
| 2400.00         | 40.20             | 27.58                 | 5.39            | 30.18              | 42.99          | 54.00               | -11.02          | Horizontal   |
| 2390.00         | 28.84             | 27.59                 | 5.38            | 30.18              | 31.63          | 54.00               | -22.37          | Vertical     |
| 2400.00         | 41.33             | 27.58                 | 5.39            | 30.18              | 44.12          | 54.00               | -9.88           | Vertical     |

|               |                 |
|---------------|-----------------|
| Test channel: | Highest channel |
|---------------|-----------------|

**Peak value:**

| Frequency (MHz) | Read Level (dBuV) | Antenna Factor (dB/m) | Cable Loss (dB) | Preamp Factor (dB) | Level (dBuV/m) | Limit Line (dBuV/m) | Over Limit (dB) | Polarization |
|-----------------|-------------------|-----------------------|-----------------|--------------------|----------------|---------------------|-----------------|--------------|
| 2483.50         | 38.98             | 27.53                 | 5.47            | 29.93              | 42.05          | 74.00               | -31.95          | Horizontal   |
| 2500.00         | 39.17             | 27.55                 | 5.49            | 29.93              | 42.28          | 74.00               | -31.72          | Horizontal   |
| 2483.50         | 38.93             | 27.53                 | 5.47            | 29.93              | 42.00          | 74.00               | -32.00          | Vertical     |
| 2500.00         | 39.66             | 27.55                 | 5.49            | 29.93              | 42.77          | 74.00               | -31.23          | Vertical     |

**Average value:**

| Frequency (MHz) | Read Level (dBuV) | Antenna Factor (dB/m) | Cable Loss (dB) | Preamp Factor (dB) | Level (dBuV/m) | Limit Line (dBuV/m) | Over Limit (dB) | Polarization |
|-----------------|-------------------|-----------------------|-----------------|--------------------|----------------|---------------------|-----------------|--------------|
| 2483.50         | 32.04             | 27.53                 | 5.47            | 29.93              | 35.11          | 54.00               | -18.89          | Horizontal   |
| 2500.00         | 30.81             | 27.55                 | 5.49            | 29.93              | 33.92          | 54.00               | -20.08          | Horizontal   |
| 2483.50         | 32.81             | 27.53                 | 5.47            | 29.93              | 35.88          | 54.00               | -18.12          | Vertical     |
| 2500.00         | 30.28             | 27.55                 | 5.49            | 29.93              | 33.39          | 54.00               | -20.61          | Vertical     |

Remark:

1. Final Level = Receiver Read level + Antenna Factor + Cable Loss – Pre-amplifier Factor

## 7.4 20dB Occupy Bandwidth

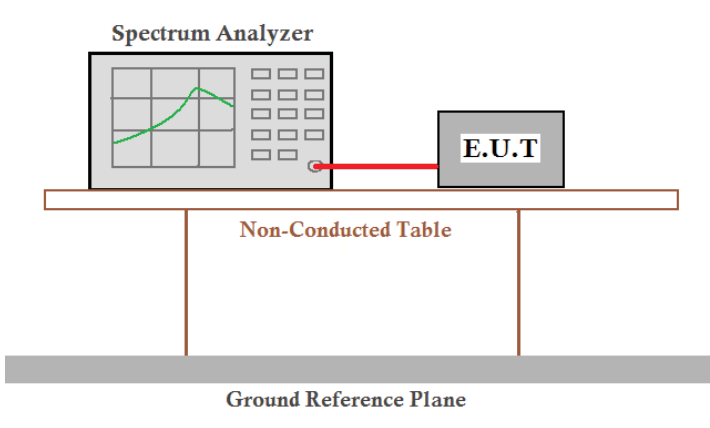
|                   |   |
|-------------------|---|
| Test Requirement: | FCC Part15 C Section 15.249/15.215  |
| Test Method:      | ANSI C63.10:2013  |
| Limit:            | Operation Frequency range 2400MHz~2483.5MHz   |
| Test setup:       |  <p>The diagram shows a Spectrum Analyzer and an E.U.T. (Equipment Under Test) connected by a red cable. They are positioned on a table labeled 'Non-Conducted Table'. Below the table is a 'Ground Reference Plane'.</p> |
| Test Instruments: | Refer to section 6.0 for details  |
| Test mode:        | Refer to section 5.3 for details  |
| Test results:     | Pass  |

### Measurement Data

| Test channel | 20dB bandwidth(MHz) | Result |
|--------------|---------------------|--------|
| Lowest       | 1.234               | Pass   |
| Middle       | 1.233               | Pass   |
| Highest      | 1.236               | Pass   |

Test plot as follows:

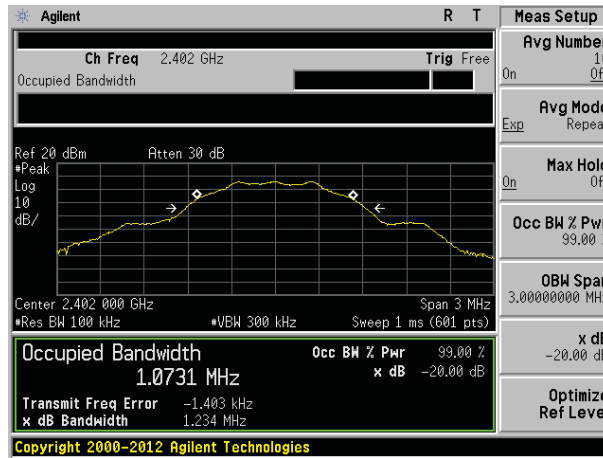

Lowest channel

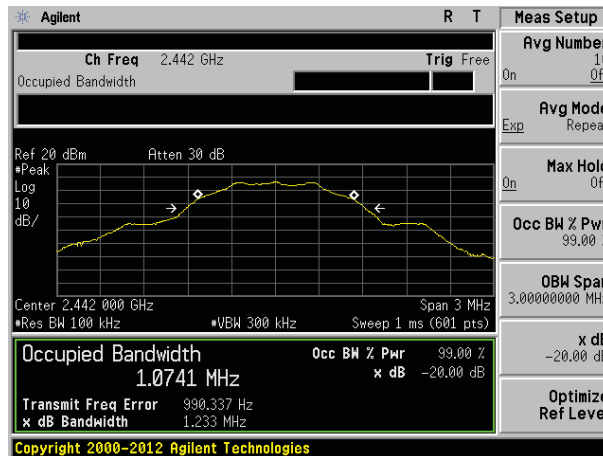

Middle channel

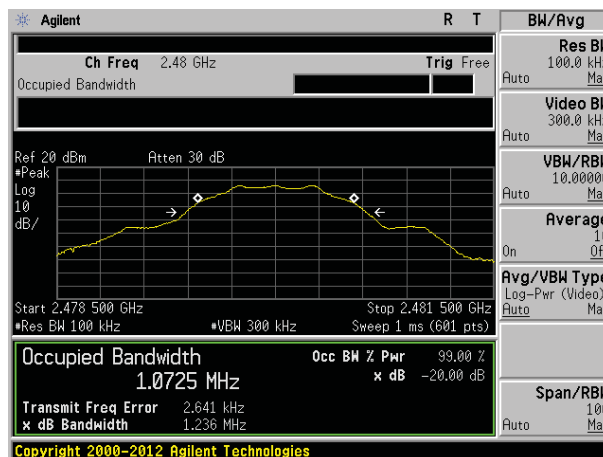

Highest channel

## 8 Test Setup Photo

### Radiated Emission

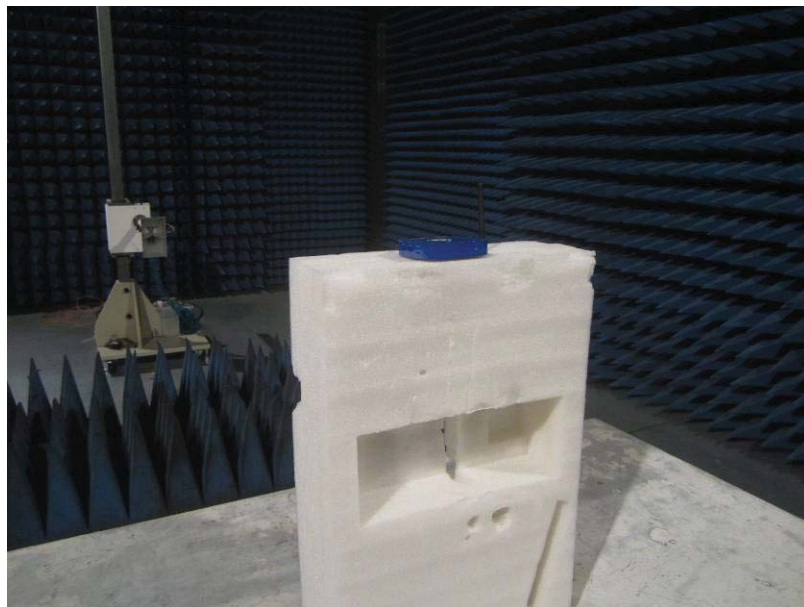

## Conducted Emission



## 9 EUT Constructional Details

Reference to the test report No. GTSE15100192401

----- End -----