



RADIO TEST REPORT

FCC ID : 2AEUPBHAFL021
Equipment : Floodlight Cam Wired Plus
Brand Name : Ring
Model Name : 5AT3T2
Applicant : Ring LLC
1523 26th St Santa Monica, CA 90404 USA
Manufacturer : Ring LLC
1523 26th St Santa Monica, CA 90404 USA
Standard : 47 CFR FCC Part 15.247

The product was received on Dec. 23, 2020, and testing was started from Dec. 23, 2020 and completed on Feb. 18, 2021. We, Sporton International Inc. Hsinchu Laboratory, would like to declare that the tested sample has been evaluated in accordance with the procedures given in ANSI C63.10-2013 and shown compliance with the applicable technical standards.

The test results in this report apply exclusively to the tested model / sample. Without written approval of Sporton International Inc. Hsinchu Laboratory, the test report shall not be reproduced except in full.

Approved by: Sam Chen

Sporton International Inc. Hsinchu Laboratory

No.8, Ln. 724, Bo'ai St., Zhubei City, Hsinchu County 302010, Taiwan (R.O.C.)



Table of Contents

History of this test report.....3

Summary of Test Result.....4

1 General Description5

1.1 Information.....5

1.2 Applicable Standards7

1.3 Testing Location Information.....7

1.4 Measurement Uncertainty7

2 Test Configuration of EUT8

2.1 Test Channel Mode8

2.2 The Worst Case Measurement Configuration.....8

2.3 EUT Operation during Test9

2.4 Accessories9

2.5 Support Equipment.....10

2.6 Test Setup Diagram11

3 Test Result13

3.1 AC Power-line Conducted Emissions13

4 Transmitter Test Result15

4.1 DTS Bandwidth15

4.2 Maximum Conducted Output Power16

4.3 Power Spectral Density19

4.4 Emissions in Non-restricted Frequency Bands21

4.5 Emissions in Restricted Frequency Bands.....22

5 Test Equipment and Calibration Data26

Appendix A. Test Results of AC Power-line Conducted Emissions

Appendix B. Test Results of DTS Bandwidth

Appendix C. Test Results of Maximum Conducted Output Power

Appendix D. Test Results of Power Spectral Density

Appendix E. Test Results of Emissions in Non-restricted Frequency Bands

Appendix F. Test Results of Emissions in Restricted Frequency Bands

Appendix G. Test Photos

Photographs of EUT v01



History of this test report

Report No.	Version	Description	Issued Date
FR0D3022AC	01	Initial issue of report	Mar. 30, 2021



Summary of Test Result

Report Clause	Ref Std. Clause	Test Items	Result (PASS/FAIL)	Remark
1.1.2	15.203	Antenna Requirement	PASS	-
3.1	15.207	AC Power-line Conducted Emissions	PASS	-
4.1	15.247(a)	DTS Bandwidth	PASS	-
4.2	15.247(b)	Maximum Conducted Output Power	PASS	-
4.3	15.247(e)	Power Spectral Density	PASS	-
4.4	15.247(d)	Emissions in Non-restricted Frequency Bands	PASS	-
4.5	15.247(d)	Emissions in Restricted Frequency Bands	PASS	-

Declaration of Conformity:

The test results with all measurement uncertainty excluded are presented in accordance with the regulation limits or requirements declared by manufacturers.

Comments and Explanations:

The declared of product specification for EUT presented in the report are provided by the manufacturer, and the manufacturer takes all the responsibilities for the accuracy of product specification.

Reviewed by: Sam Chen

Report Producer: Viola Huang



1 General Description

1.1 Information

1.1.1 RF General Information

Frequency Range	Lora Mode	Ch. Frequency (MHz)	Channel Number
902 MHz – 928 MHz	LoRa-500kHz	902.5-926.5	1-31 [31]

Band	Lora Mode	BWch (MHz)	Nant
902-928MHz	LoRa (500kHz)	0.5	1

Note:

- ♦ 900M is the 900MHz band (902 MHz – 928 MHz)
- ♦ LoRa-500kHz uses as a DTS
- ♦ LoRa-500kHz uses Chirp Spread Spectrum (CSS) modulation
BWch is the nominal channel bandwidth.

1.1.2 Antenna Information

Ant.	Port	Brand	Model Name	Antenna Type	Connector	Gain (dBi)
1	1	INPAQ	WA-P-LALA-02-003	PCB Antenna	I-PEX	Note1
2	1	INPAQ	WA-P-LALA-02-003	PCB Antenna	I-PEX	
3	1	INPAQ	WA-P-LORA-03-001	PCB Antenna	I-PEX	

Note1:

Ant.	Gain (dBi)						
	WLAN 2.4GHz	Bluetooth	LoRa				
			863MHz	870MHz	902MHz	915MHz	928MHz
1	1.69	-	-	-	-	-	-
2	-	3.64	-	-	-	-	-
3	-	-	0.58	1.07	1.74	1.34	0.90

Note2: The above information was declared by manufacturer.

For 2.4GHz function:

For IEEE 802.11b/g/n (1TX/1RX):

Only Port 1 can be used as transmitting/receiving antenna.

For Bluetooth function (1TX/1RX):

Only Port 1 can be used as transmitting/receiving antenna.

For LoRa function (1TX/1RX):

Only Port 1 can be used as transmitting/receiving antenna.



1.1.3 Mode Test Duty Cycle

Mode	DC	DCF(dB)	T(s)	VBW(Hz) ≥ 1/T
LoRa (500kHz)	0.991	0.04	n/a (DC>=0.98)	n/a (DC>=0.98)

Note:

- ◆ DC is Duty Cycle.
- ◆ DCF is Duty Cycle Factor.

1.1.4 EUT Operational Condition

EUT Power Type	From host system		
Function	<input checked="" type="checkbox"/> Point-to-multipoint	<input type="checkbox"/>	Point-to-point
Test Software Version	PuTTY 0.73 、 J-link RRT Viewer V6.60e		

Note: The above information was declared by manufacturer.



1.2 Applicable Standards

According to the specifications of the manufacturer, the EUT must comply with the requirements of the following standards:

- ♦ 47 CFR FCC Part 15
- ♦ ANSI C63.10-2013

The following reference test guidance is not within the scope of accreditation of TAF.

- ♦ FCC KDB 558074 D01 v05r02
- ♦ FCC KDB 414788 D01 v01r01

1.3 Testing Location Information

Testing Location Information	
Test Lab. : Sporton International Inc. Hsinchu Laboratory	
Hsinchu (TAF: 3787)	ADD: No.8, Ln. 724, Bo'ai St., Zhubei City, Hsinchu County 302010, Taiwan (R.O.C.) TEL: 886-3-656-9065 FAX: 886-3-656-9085 Test site Designation No. TW0006 with FCC. Test site registered number IC 4086D with Industry Canada.

Test Condition	Test Site No.	Test Engineer	Test Environment (°C / %)	Test Date
RF Conducted	TH02-CB	Benson Su	20.7~22.6 / 55~60	Jan. 21, 2021
Radiated below 1GHz	03CH01-CB	Eason Chen	20.4~21.4 / 55~57	Dec. 23, 2020~Jan. 27, 2021
	03CH04-CB		22.6~23.6 / 55~57	
Radiated above 1GHz	03CH04-CB	Eason Chen	22.6~23.6 / 55~57	Dec. 23, 2020~Jan. 27, 2021
AC Conduction	CO02-CB	Peter Wu	20~21 / 59~63	Feb. 18, 2021

1.4 Measurement Uncertainty

ISO/IEC 17025 requires that an estimate of the measurement uncertainties associated with the emissions test results be included in the report. The measurement uncertainties given below are based on a 95% confidence level (based on a coverage factor (k=2))

Test Items	Uncertainty	Remark
Conducted Emission (150kHz ~ 30MHz)	2.0 dB	Confidence levels of 95%
Radiated Emission (9kHz ~ 30MHz)	3.8 dB	Confidence levels of 95%
Radiated Emission (30MHz ~ 1,000MHz)	5.6 dB	Confidence levels of 95%
Radiated Emission (1GHz ~ 18GHz)	5.0 dB	Confidence levels of 95%
Radiated Emission (18GHz ~ 40GHz)	4.9 dB	Confidence levels of 95%
Conducted Emission	2.8 dB	Confidence levels of 95%
Output Power Measurement	1.4 dB	Confidence levels of 95%
Power Density Measurement	2.8 dB	Confidence levels of 95%
Bandwidth Measurement	0.4%	Confidence levels of 95%



2 Test Configuration of EUT

2.1 Test Channel Mode

Mode	Power Setting
LoRa (500kHz)	-
902.5MHz	14
914.5MHz	14
926.5MHz	14

2.2 The Worst Case Measurement Configuration

The Worst Case Mode for Following Conformance Tests	
Tests Item	AC power-line conducted emissions
Condition	AC power-line conducted measurement for line and neutral
Operating Mode	CTX
1	EUT_2.4GHz
2	EUT_Bluetooth
3	EUT_LoRa

For operating mode 1 is the worst case and it was record in this test report.

The Worst Case Mode for Following Conformance Tests	
Tests Item	DTS Bandwidth Maximum Conducted Output Power Power Spectral Density Emissions in Non-restricted Frequency Bands
Test Condition	Conducted measurement at transmit chains
Operating Mode	EUT



The Worst Case Mode for Following Conformance Tests	
Tests Item	Emissions in Restricted Frequency Bands
Test Condition	Radiated measurement If EUT consist of multiple antenna assembly (multiple antenna are used in EUT regardless of spatial multiplexing MIMO configuration), the radiated test should be performed with highest antenna gain of each antenna type.
Operating Mode < 1GHz	CTX
	For 2.4GHz The EUT was performed at X axis, Y axis and Z axis position for emissions in restricted frequency bands above 1GHz, and the worst case was found at Z axis.
	For Bluetooth The EUT was performed at X axis, Y axis and Z axis position for emissions in restricted frequency bands above 1GHz, and the worst case was found at Y axis.
	For LoRa The EUT was performed at X axis, Y axis and Z axis position for emissions in restricted frequency bands above 1GHz, and the worst case was found at X axis. So the measurement will follow this same test configuration.
1	EUT_2.4GHz in Z axis
2	EUT_Bluetooth in Y axis
3	EUT_LoRa in X axis
For operating mode 1 is the worst case and it was record in this test report.	

Operating Mode > 1GHz	CTX
	The EUT was performed at X axis, Y axis and Z axis position and the worst case was found at X axis. So the measurement will follow this same test configuration.
1	EUT_LoRa in X axis

The Worst Case Mode for Following Conformance Tests	
Tests Item	Simultaneous Transmission Analysis - Co-location RF Exposure Evaluation
Operating Mode	
1	WLAN 2.4GHz + Bluetooth + LoRa
Refer to Sporton Test Report No.: FA0D3022 for Co-location RF Exposure Evaluation.	

2.3 EUT Operation during Test

The EUT was programmed to be in continuously transmitting mode.

2.4 Accessories

N/A



2.5 Support Equipment

For AC Conduction and Radiated: N/A

For RF Conducted:

Support Equipment				
No.	Equipment	Brand Name	Model Name	FCC ID
A	NB	DELL	E4300	N/A
B	Test Fixture	Foxconn	E221612	N/A
C	Test Fixture	Foxconn	E248779	N/A

2.6 Test Setup Diagram

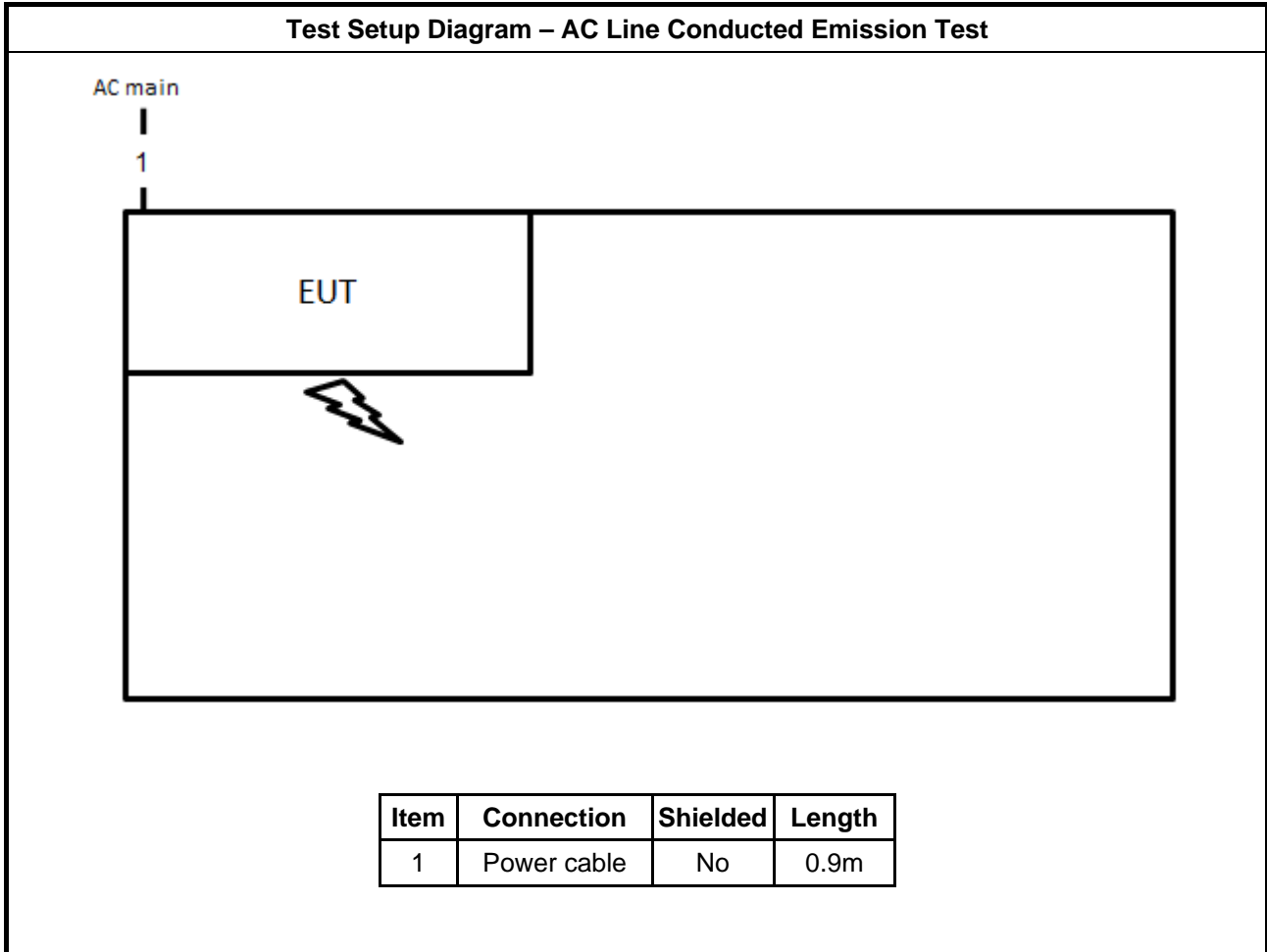



Test Setup Diagram - Radiated Test

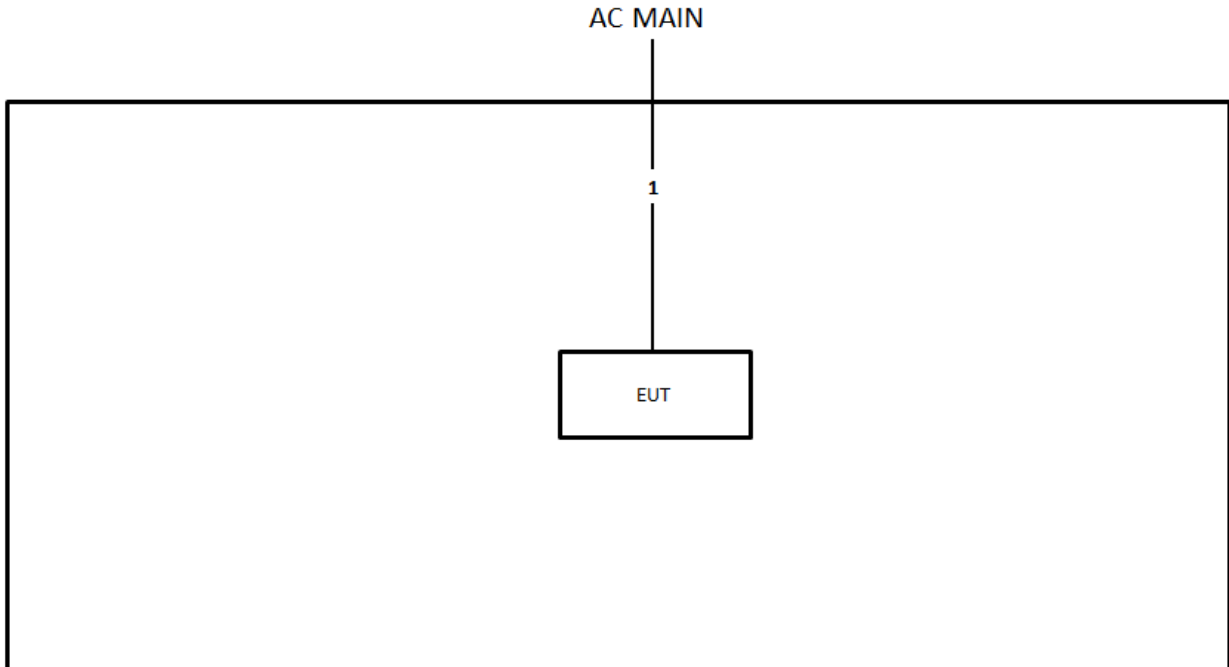

Item	Connection	Shielded	Length
1	Power cable	No	0.9m



3 Test Result

3.1 AC Power-line Conducted Emissions

3.1.1 AC Power-line Conducted Emissions Limit

AC Power-line Conducted Emissions Limit		
Frequency Emission (MHz)	Quasi-Peak	Average
0.15-0.5	66 - 56 *	56 - 46 *
0.5-5	56	46
5-30	60	50

Note 1: * Decreases with the logarithm of the frequency.

3.1.2 Measuring Instruments

Refer a test equipment and calibration data table in this test report.

3.1.3 Test Procedures

Test Method
▪ Refer as ANSI C63.10-2013 , clause 6.2 for AC power-line conducted emissions.

3.1.4 Test Setup

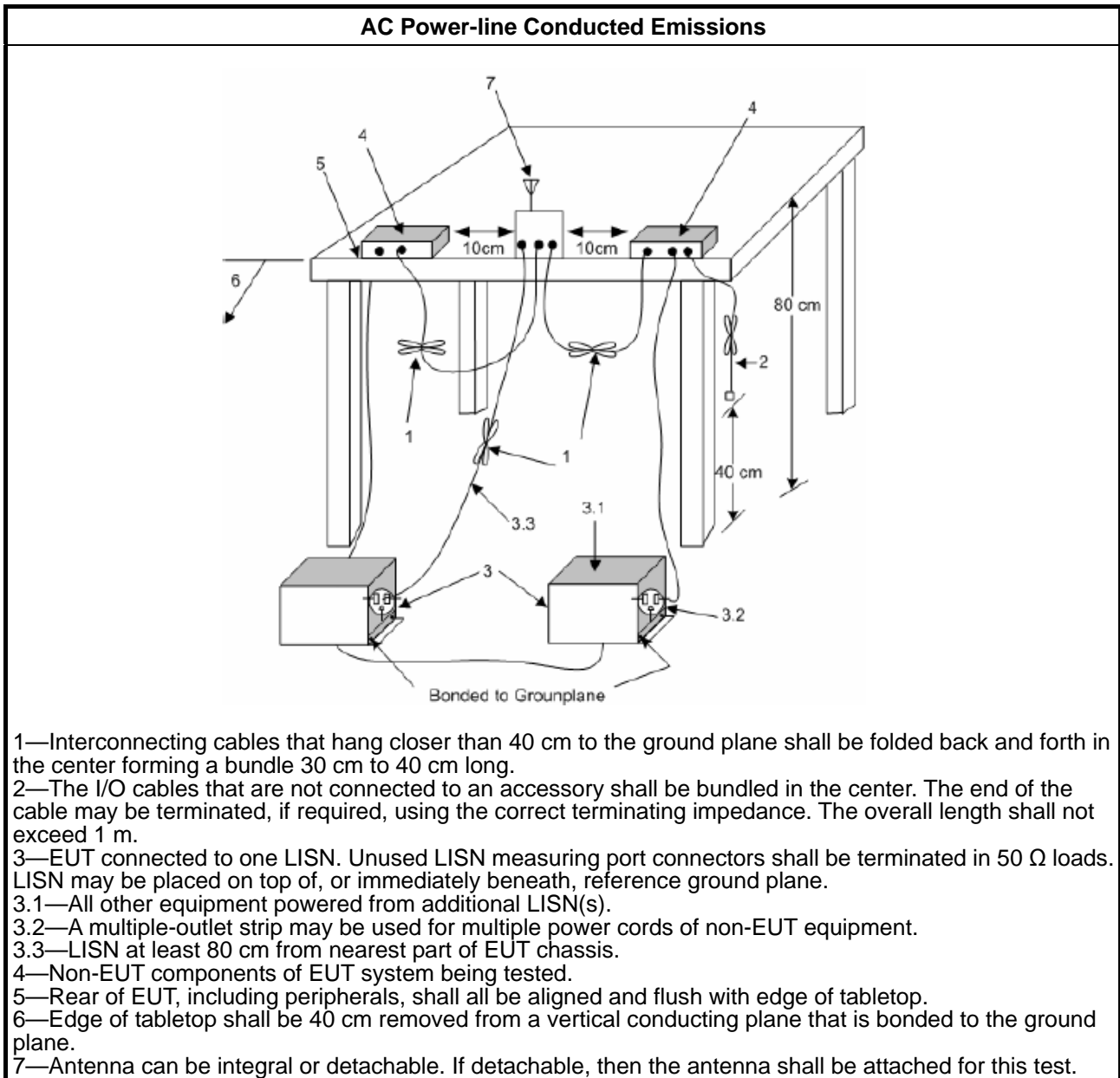

3.1.5 Measurement Results Calculation

The measured Level is calculated using:

- a. Corrected Reading: LISN Factor (LISN) + Attenuator (AT/AUX) + Cable Loss (CL) + Read Level (Raw) = Level
- b. Margin = -Limit + Level

3.1.6 Test Result of AC Power-line Conducted Emissions

Refer as Appendix A

4 Transmitter Test Result

4.1 DTS Bandwidth

4.1.1 6dB Bandwidth Limit

6dB Bandwidth Limit
Systems using digital modulation techniques:
<ul style="list-style-type: none"> ▪ 6 dB bandwidth \geq 500 kHz.

4.1.2 Measuring Instruments

Refer a test equipment and calibration data table in this test report.

4.1.3 Test Procedures

Test Method
<ul style="list-style-type: none"> ▪ For the emission bandwidth shall be measured using one of the options below:
<input checked="" type="checkbox"/> Refer as FCC KDB 558074, clause 8.2 & C63.10 clause 11.8.1 Option 1 for 6 dB bandwidth measurement.
<input type="checkbox"/> Refer as FCC KDB 558074, clause 8.2 & C63.10 clause 11.8.2 Option 2 for 6 dB bandwidth measurement.
<input type="checkbox"/> Refer as ANSI C63.10, clause 6.9.1 for occupied bandwidth testing.

4.1.4 Test Setup

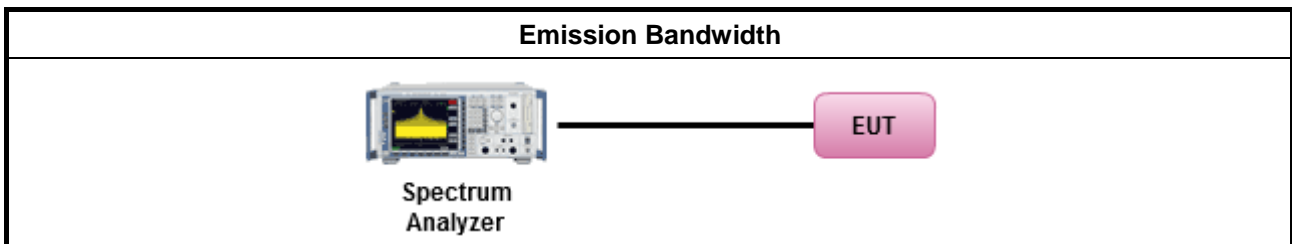

4.1.5 Test Result of Emission Bandwidth

Refer as Appendix B



4.2 Maximum Conducted Output Power

4.2.1 Maximum Conducted Output Power Limit

Maximum Conducted Output Power Limit	
	<ul style="list-style-type: none"> ▪ If $G_{TX} \leq 6$ dBi, then $P_{Out} \leq 30$ dBm (1 W)
	<ul style="list-style-type: none"> ▪ Point-to-multipoint systems (P2M): If $G_{TX} > 6$ dBi, then $P_{Out} = 30 - (G_{TX} - 6)$ dBm
	<ul style="list-style-type: none"> ▪ Point-to-point systems (P2P): If $G_{TX} > 6$ dBi, then $P_{Out} = 30 - (G_{TX} - 6)/3$ dBm
	<ul style="list-style-type: none"> ▪ Smart antenna system (SAS):
	<ul style="list-style-type: none"> - Single beam: If $G_{TX} > 6$ dBi, then $P_{Out} = 30 - (G_{TX} - 6)/3$ dBm
	<ul style="list-style-type: none"> - Overlap beam: If $G_{TX} > 6$ dBi, then $P_{Out} = 30 - (G_{TX} - 6)/3$ dBm
	<ul style="list-style-type: none"> - Aggregate power on all beams: If $G_{TX} > 6$ dBi, then $P_{Out} = 30 - (G_{TX} - 6)/3 + 8$ dB dBm
<p>P_{Out} = maximum peak conducted output power or maximum conducted output power in dBm, G_{TX} = the maximum transmitting antenna directional gain in dBi.</p>	

4.2.2 Measuring Instruments

Refer a test equipment and calibration data table in this test report.



4.2.3 Test Procedures

Test Method	
<ul style="list-style-type: none"> ▪ Maximum Peak Conducted Output Power 	
	<input type="checkbox"/> Refer as FCC KDB 558074, clause 8.3.1.1 & C63.10 clause 11.9.1.1 (RBW ≥ EBW method).
	<input type="checkbox"/> Refer as FCC KDB 558074, clause 8.3.1.3 & C63.10 clause 11.9.1.3 (peak power meter).
<ul style="list-style-type: none"> ▪ Maximum Conducted Output Power 	
[duty cycle ≥ 98% or external video / power trigger]	
	<input type="checkbox"/> Refer as FCC KDB 558074, clause 8.3.2.2 & C63.10 clause 11.9.2.2.2 Method AVGSA-1.
	<input type="checkbox"/> Refer as FCC KDB 558074, clause 8.3.2.2 & C63.10 clause 11.9.2.2.3 Method AVGSA-1A. (alternative)
duty cycle < 98% and average over on/off periods with duty factor	
	<input type="checkbox"/> Refer as FCC KDB 558074, clause 8.3.2.2 & C63.10 clause 11.9.2.2.4 Method AVGSA-2.
	<input type="checkbox"/> Refer as FCC KDB 558074, clause 8.3.2.2 & C63.10 clause 11.9.2.2.5 Method AVGSA-2A (alternative)
	<input type="checkbox"/> Refer as FCC KDB 558074, clause 8.3.2.2 & C63.10 clause 11.9.2.2.6 Method AVGSA-3
	<input type="checkbox"/> Refer as FCC KDB 558074, clause 8.3.2.2 & C63.10 clause 11.9.2.2.7 Method AVGSA-3A (alternative)
Measurement using a power meter (PM)	
	<input type="checkbox"/> Refer as FCC KDB 558074, clause 8.3.2.3 & C63.10 clause 11.9.2.3.1 Method AVGPM (using an RF average power meter).
	<input checked="" type="checkbox"/> Refer as FCC KDB 558074, clause 8.3.2.3 & C63.10 clause 11.9.2.3.2 Method AVGPM-G (using an gate RF average power meter).
<ul style="list-style-type: none"> ▪ For conducted measurement. 	
	<ul style="list-style-type: none"> ▪ If the EUT supports multiple transmit chains using options given below: Refer as FCC KDB 662911, In-band power measurements. Using the measure-and-sum approach, measured all transmit ports individually. Sum the power (in linear power units e.g., mW) of all ports for each individual sample and save them.
	<ul style="list-style-type: none"> ▪ If multiple transmit chains, EIRP calculation could be following as methods: $P_{total} = P_1 + P_2 + \dots + P_n$ (calculated in linear unit [mW] and transfer to log unit [dBm]) $EIRP_{total} = P_{total} + DG$

4.2.4 Test Setup

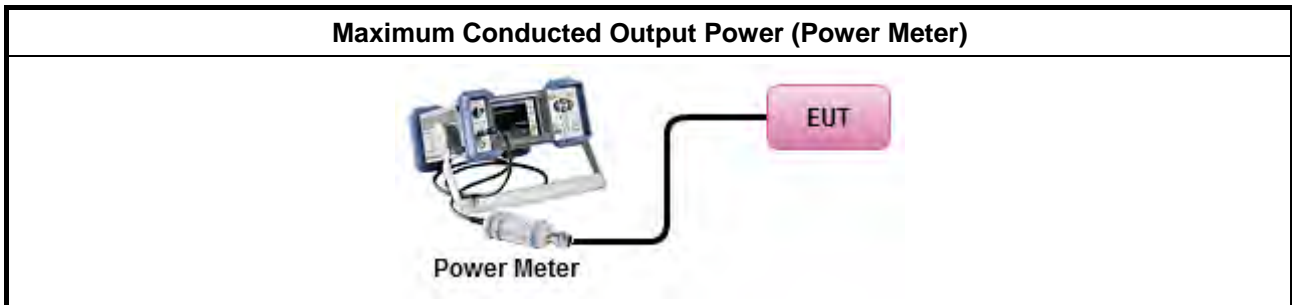

4.2.5 Test Result of Maximum Conducted Output Power

Refer as Appendix C



4.3 Power Spectral Density

4.3.1 Power Spectral Density Limit

Power Spectral Density Limit
<ul style="list-style-type: none"> Power Spectral Density (PSD) ≤ 8 dBm/3kHz

4.3.2 Measuring Instruments

Refer a test equipment and calibration data table in this test report.

4.3.3 Test Procedures

Test Method			
<ul style="list-style-type: none"> Peak power spectral density procedures that the same method as used to determine the conducted output power. If maximum peak conducted output power was measured to demonstrate compliance to the output power limit, then the peak PSD procedure below (Method PKPSD) shall be used. If maximum conducted output power was measured to demonstrate compliance to the output power limit, then one of the average PSD procedures shall be used, as applicable based on the following criteria (the peak PSD procedure is also an acceptable option). 			
<input checked="" type="checkbox"/> Refer as FCC KDB 558074, clause 8.4 & C63.10 clause 11.10 Method Max. PSD.			
<ul style="list-style-type: none"> For conducted measurement. <ul style="list-style-type: none"> If The EUT supports multiple transmit chains using options given below: <table border="1"> <tbody> <tr> <td> <input type="checkbox"/> Option 1: Measure and sum the spectra across the outputs. Refer as FCC KDB 662911, In-band power spectral density (PSD). Sample all transmit ports simultaneously using a spectrum analyzer for each transmit port. Where the trace bin-by-bin of each transmit port summing can be performed. (i.e., in the first spectral bin of output 1 is summed with that in the first spectral bin of output 2 and that from the first spectral bin of output 3, and so on up to the NTX output to obtain the value for the first frequency bin of the summed spectrum.). Add up the amplitude (power) values for the different transmit chains and use this as the new data trace. </td> </tr> <tr> <td> <input type="checkbox"/> Option 2: Measure and sum spectral maxima across the outputs. With this technique, spectra are measured at each output of the device at the required resolution bandwidth. The maximum value (peak) of each spectrum is determined. These maximum values are then summed mathematically in linear power units across the outputs. These operations shall be performed separately over frequency spans that have different out-of-band or spurious emission limits, </td> </tr> <tr> <td> <input type="checkbox"/> Option 3: Measure and add 10 log(N) dB, where N is the number of transmit chains. Refer as FCC KDB 662911, In-band power spectral density (PSD). Performed at each transmit chains and each transmit chains shall be compared with the limit have been reduced with 10 log(N). Or each transmit chains shall be add 10 log(N) to compared with the limit. </td> </tr> </tbody> </table> 	<input type="checkbox"/> Option 1: Measure and sum the spectra across the outputs. Refer as FCC KDB 662911, In-band power spectral density (PSD). Sample all transmit ports simultaneously using a spectrum analyzer for each transmit port. Where the trace bin-by-bin of each transmit port summing can be performed. (i.e., in the first spectral bin of output 1 is summed with that in the first spectral bin of output 2 and that from the first spectral bin of output 3, and so on up to the NTX output to obtain the value for the first frequency bin of the summed spectrum.). Add up the amplitude (power) values for the different transmit chains and use this as the new data trace.	<input type="checkbox"/> Option 2: Measure and sum spectral maxima across the outputs. With this technique, spectra are measured at each output of the device at the required resolution bandwidth. The maximum value (peak) of each spectrum is determined. These maximum values are then summed mathematically in linear power units across the outputs. These operations shall be performed separately over frequency spans that have different out-of-band or spurious emission limits,	<input type="checkbox"/> Option 3: Measure and add 10 log(N) dB, where N is the number of transmit chains. Refer as FCC KDB 662911, In-band power spectral density (PSD). Performed at each transmit chains and each transmit chains shall be compared with the limit have been reduced with 10 log(N). Or each transmit chains shall be add 10 log(N) to compared with the limit.
<input type="checkbox"/> Option 1: Measure and sum the spectra across the outputs. Refer as FCC KDB 662911, In-band power spectral density (PSD). Sample all transmit ports simultaneously using a spectrum analyzer for each transmit port. Where the trace bin-by-bin of each transmit port summing can be performed. (i.e., in the first spectral bin of output 1 is summed with that in the first spectral bin of output 2 and that from the first spectral bin of output 3, and so on up to the NTX output to obtain the value for the first frequency bin of the summed spectrum.). Add up the amplitude (power) values for the different transmit chains and use this as the new data trace.			
<input type="checkbox"/> Option 2: Measure and sum spectral maxima across the outputs. With this technique, spectra are measured at each output of the device at the required resolution bandwidth. The maximum value (peak) of each spectrum is determined. These maximum values are then summed mathematically in linear power units across the outputs. These operations shall be performed separately over frequency spans that have different out-of-band or spurious emission limits,			
<input type="checkbox"/> Option 3: Measure and add 10 log(N) dB, where N is the number of transmit chains. Refer as FCC KDB 662911, In-band power spectral density (PSD). Performed at each transmit chains and each transmit chains shall be compared with the limit have been reduced with 10 log(N). Or each transmit chains shall be add 10 log(N) to compared with the limit.			

4.3.4 Test Setup

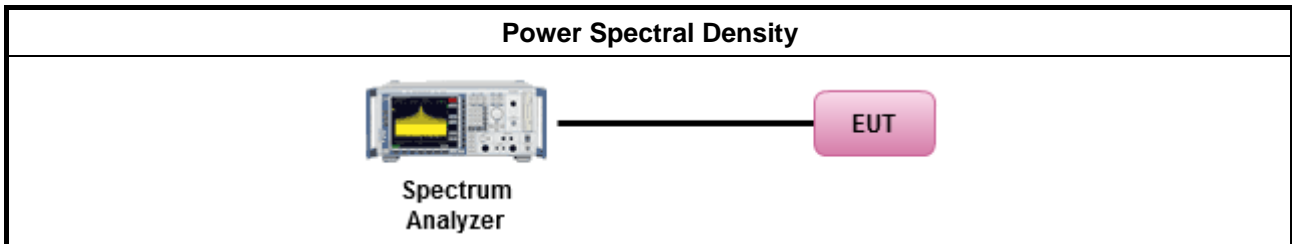

4.3.5 Test Result of Power Spectral Density

Refer as Appendix D

4.4 Emissions in Non-restricted Frequency Bands

4.4.1 Emissions in Non-restricted Frequency Bands Limit

Un-restricted Band Emissions Limit	
RF output power procedure	Limit (dB)
Peak output power procedure	20
Average output power procedure	30

Note 1: If the peak output power procedure is used to measure the fundamental emission power to demonstrate compliance to requirements, then the peak conducted output power measured within any 100 kHz outside the authorized frequency band shall be attenuated by at least 20 dB relative to the maximum measured in-band peak PSD level.

Note 2: If the average output power procedure is used to measure the fundamental emission power to demonstrate compliance to requirements, then the power in any 100 kHz outside of the authorized frequency band shall be attenuated by at least 30 dB relative to the maximum measured in-band average PSD level.

4.4.2 Measuring Instruments

Refer a test equipment and calibration data table in this test report.

4.4.3 Test Procedures

Test Method
<ul style="list-style-type: none"> Refer as FCC KDB 558074, clause 8.5 for unwanted emissions into non-restricted bands.

4.4.4 Test Setup

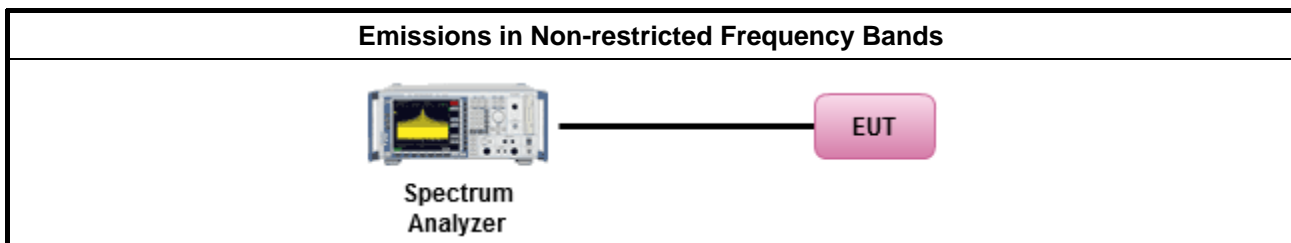

4.4.5 Test Result of Emissions in Non-restricted Frequency Bands

Refer as Appendix E



4.5 Emissions in Restricted Frequency Bands

4.5.1 Emissions in Restricted Frequency Bands Limit

Restricted Band Emissions Limit			
Frequency Range (MHz)	Field Strength (uV/m)	Field Strength (dBuV/m)	Measure Distance (m)
0.009~0.490	2400/F(kHz)	48.5 - 13.8	300
0.490~1.705	24000/F(kHz)	33.8 - 23	30
1.705~30.0	30	29	30
30~88	100	40	3
88~216	150	43.5	3
216~960	200	46	3
Above 960	500	54	3

Note 1: Test distance for frequencies at or above 30 MHz, measurements may be performed at a distance other than the limit distance provided they are not performed in the near field and the emissions to be measured can be detected by the measurement equipment. When performing measurements at a distance other than that specified, the results shall be extrapolated to the specified distance using an extrapolation factor of 20 dB/decade (inverse of linear distance for field-strength measurements, inverse of linear distance-squared for power-density measurements).

Note 2: Test distance for frequencies at below 30 MHz, measurements may be performed at a distance closer than the EUT limit distance; however, an attempt should be made to avoid making measurements in the near field. When performing measurements below 30 MHz at a closer distance than the limit distance, the results shall be extrapolated to the specified distance by either making measurements at a minimum of two or more distances on at least one radial to determine the proper extrapolation factor or by using the square of an inverse linear distance extrapolation factor (40 dB / decade). The test report shall specify the extrapolation method used to determine compliance of the EUT.

Note 3: Using the distance of 1m during the test for above 18 GHz, and the test value to correct for the distance factor at 3m.

4.5.2 Measuring Instruments

Refer a test equipment and calibration data table in this test report.



4.5.3 Test Procedures

Test Method	
<ul style="list-style-type: none"> ▪ The average emission levels shall be measured in [duty cycle \geq 98 or duty factor]. 	
<ul style="list-style-type: none"> ▪ Refer as ANSI C63.10, clause 6.10.3 band-edge testing shall be performed at the lowest frequency channel and highest frequency channel within the allowed operating band. 	
<ul style="list-style-type: none"> ▪ For the transmitter unwanted emissions shall be measured using following options below: 	
	<ul style="list-style-type: none"> ▪ Refer as FCC KDB 558074, clause 8.6 for unwanted emissions into restricted bands.
	<input type="checkbox"/> Refer as FCC KDB 558074, clause 8.6 & C63.10 clause 11.12.2.5.1(trace averaging for duty cycle \geq 98%).
	<input type="checkbox"/> Refer as FCC KDB 558074, clause 8.6 & C63.10 clause 11.12.2.5.2(trace averaging + duty factor).
	<input checked="" type="checkbox"/> Refer as FCC KDB 558074, clause 8.6 & C63.10 clause 11.12.2.5.3(Reduced VBW \geq 1/T).
	<input type="checkbox"/> Refer as ANSI C63.10, clause 11.12.2.5.3 (Reduced VBW). VBW \geq 1/T, where T is pulse time.
	<input type="checkbox"/> Refer as ANSI C63.10, clause 7.5 average value of pulsed emissions.
	<input checked="" type="checkbox"/> Refer as FCC KDB 558074, clause 8.6 & C63.10 clause 11.12.2.4 measurement procedure peak limit.
<ul style="list-style-type: none"> ▪ For the transmitter band-edge emissions shall be measured using following options below: 	
	<ul style="list-style-type: none"> ▪ Refer as FCC KDB 558074 clause 8.7 & C63.10 clause 11.13.1, When the performing peak or average radiated measurements, emissions within 2 MHz of the authorized band edge may be measured using the marker-delta method described below.
	<ul style="list-style-type: none"> ▪ Refer as FCC KDB 558074, clause 8.7 (ANSI C63.10, clause 6.10.6) for marker-delta method for band-edge measurements.
	<ul style="list-style-type: none"> ▪ Refer as FCC KDB 558074, clause 8.7 for narrower resolution bandwidth (100kHz) using the band power and summing the spectral levels (i.e., 1 MHz).
	<ul style="list-style-type: none"> ▪ For conducted unwanted emissions into restricted bands (absolute emission limits). Devices with multiple transmit chains using options given below: (1) Measure and sum the spectra across the outputs or (2) Measure and add 10 log(N) dB
	<ul style="list-style-type: none"> ▪ For FCC KDB 662911 The methodology described here may overestimate array gain, thereby resulting in apparent failures to satisfy the out-of-band limits even if the device is actually compliant. In such cases, compliance may be demonstrated by performing radiated tests around the frequencies at which the apparent failures occurred.

4.5.4 Test Setup

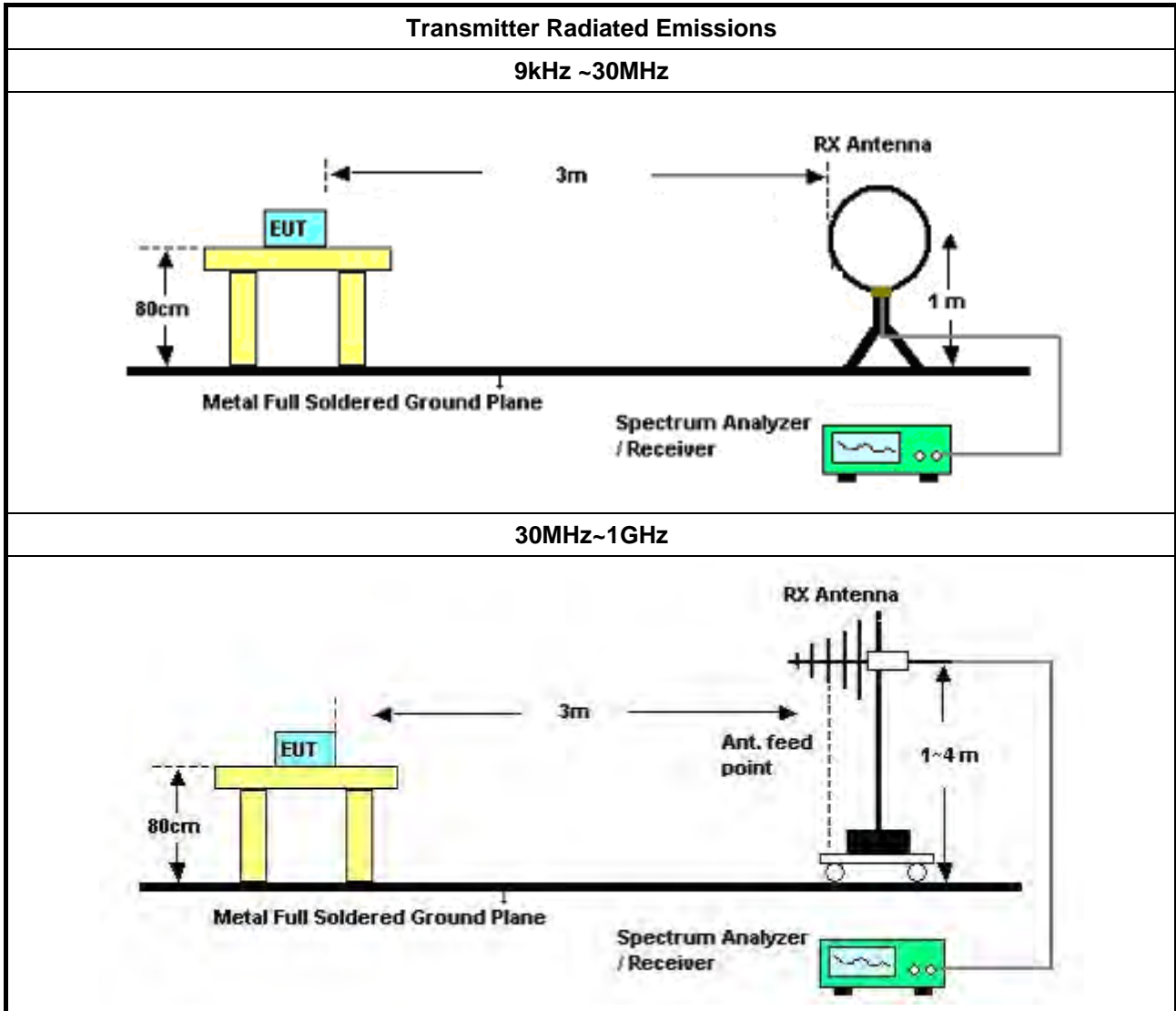

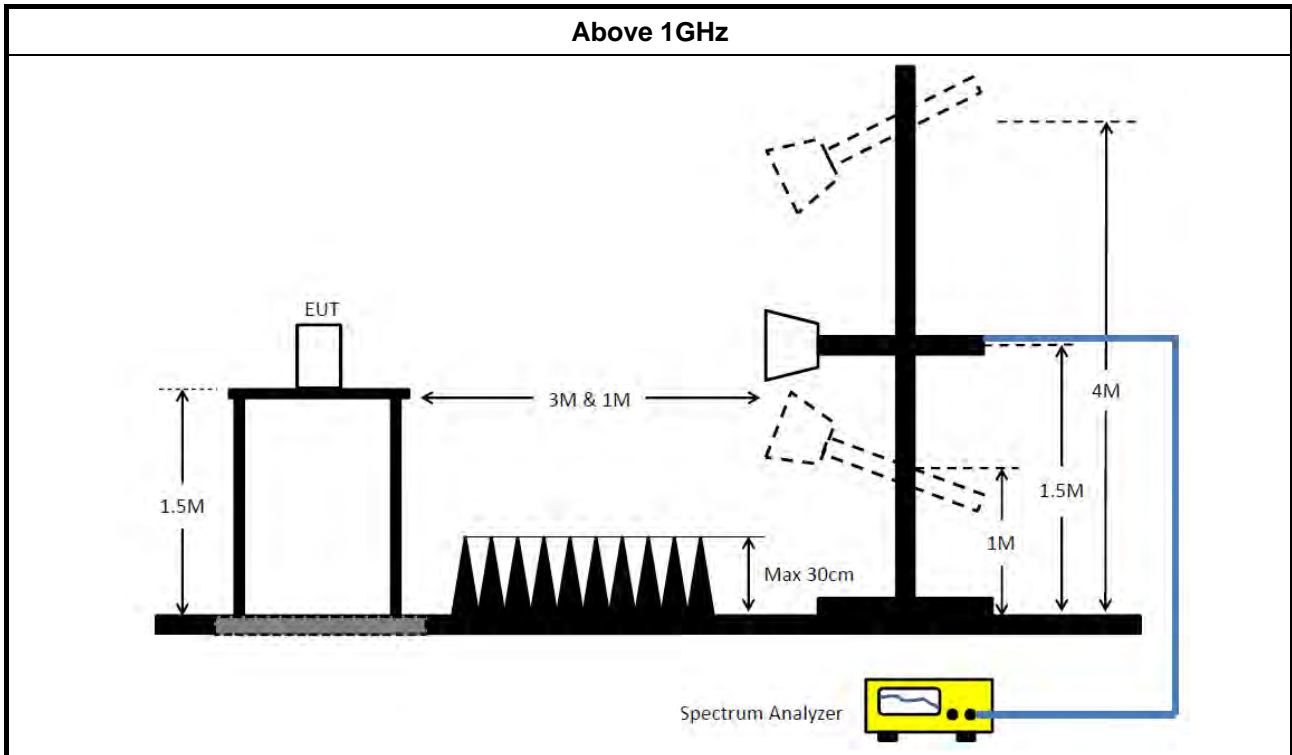

4.5.5 Measurement Results Calculation

The measured Level is calculated using:

Corrected Reading: Antenna Factor + Cable Loss + Read Level - Preamp Factor (if applicable) = Level.

4.5.6 Transmitter Radiated Unwanted Emissions (Below 30MHz)

All amplitude of spurious emissions that are attenuated by more than 20 dB below the permissible value has no need to be reported.

4.5.7 Transmitter Radiated Unwanted Emissions

Refer as Appendix F



5 Test Equipment and Calibration Data

Instrument	Brand	Model No.	Serial No.	Characteristics	Calibration Date	Calibration Due Date	Remark
LISN	Schwarzbeck	NSLK 8127	8127650	9kHz ~ 30MHz	Dec. 04, 2020	Dec. 03, 2021	Conduction (CO02-CB)
LISN	Schwarzbeck	NSLK 8127	8127478	9kHz ~ 30MHz	Nov. 20, 2020	Nov. 19, 2021	Conduction (CO02-CB)
EMI Receiver	Agilent	N9038A	MY52260140	9kHz ~ 8.4GHz	Mar. 10, 2020	Mar. 09, 2021	Conduction (CO02-CB)
COND Cable	Woken	Cable	2	0.15MHz ~ 30MHz	Oct. 20, 2020	Oct. 19, 2021	Conduction (CO02-CB)
Software	SPORTON	SENSE	V5.10	-	N.C.R.	N.C.R.	Conduction (CO02-CB)
Pulse Limiter	Schwarzbeck	VTSD 9561F-N	00378	9kHz ~ 30MHz	Mar. 19, 2020	Mar. 18, 2021	Conduction (CO02-CB)
Loop Antenna	Teseq	HLA 6120	24155	9kHz - 30 MHz	Apr. 13, 2020	Apr. 12, 2021	Radiation (03CH01-CB)
3m Semi Anechoic Chamber NSA	TDK	SAC-3M	03CH01-CB	30 MHz ~ 1 GHz	Jan. 28, 2020	Jan. 27, 2021	Radiation (03CH01-CB)
3m Semi Anechoic Chamber NSA	TDK	SAC-3M	03CH01-CB	30 MHz ~ 1 GHz	Jan. 26, 2021	Jan. 25, 2022	Radiation (03CH01-CB)
BILOG ANTENNA with 6dB Attenuator	TESEQ & EMCI	CBL6112D N-6-06	37880 & AT-N0609	20MHz ~ 2GHz	Feb. 28, 2020	Feb. 27, 2021	Radiation (03CH01-CB)
Preamplifier	EMCI	EMC330N	980332	20MHz ~ 3GHz	Jul. 03, 2020	Jun. 02, 2021	Radiation (03CH01-CB)
Spectrum Analyzer	R&S	FSP40	100056	9kHz ~ 40GHz	Apr. 16, 2020	Apr. 15, 2021	Radiation (03CH01-CB)
EMI Test Receiver	R&S	ESCS	826547/017	9kHz ~ 2.75GHz	May 13, 2020	May 12, 2021	Radiation (03CH01-CB)
RF Cable-low	Woken	RG402	Low Cable-16+17	30 MHz ~ 1 GHz	Oct. 05, 2020	Oct. 04, 2021	Radiation (03CH01-CB)
Test Software	SPORTON	SENSE	V5.10	-	N.C.R.	N.C.R.	Radiation (03CH01-CB)
Loop Antenna	Teseq	HLA 6120	24155	9kHz - 30 MHz	Apr. 13, 2020	Apr. 12, 2021	Radiation (03CH04-CB)
3m Semi Anechoic Chamber NSA	TDK	SAC-3M	03CH04-CB	30 MHz ~ 1 GHz	Aug. 09, 2020	Aug. 08, 2021	Radiation (03CH04-CB)
3m Semi Anechoic Chamber VSWR	TDK	SAC-3M	03CH04-CB	1GHz ~18GHz 3m	Feb. 26, 2020	Feb. 25, 2021	Radiation (03CH04-CB)
BILOG ANTENNA with 6 dB attenuator	Schaffner & EMCI	CBL6112B & N-6-06	22021&AT-N06 07	30MHz ~ 1GHz	Oct. 11, 2020	Oct. 10, 2021	Radiation (03CH04-CB)



Instrument	Brand	Model No.	Serial No.	Characteristics	Calibration Date	Calibration Due Date	Remark
Horn Antenna	ETS·Lindgren	3115	00143147	750MHz~18GHz	Oct. 23, 2020	Oct. 22, 2021	Radiation (03CH04-CB)
Horn Antenna	Schwarzbeck	BBHA 9170	BBHA9170252	15GHz ~ 40GHz	Jul. 21, 2020	Jul. 20, 2021	Radiation (03CH04-CB)
Pre-Amplifier	Agilent	310N	187291	0.1MHz ~ 1GHz	Dec. 17, 2020	Dec. 16, 2021	Radiation (03CH04-CB)
Pre-Amplifier	Agilent	83017A	MY53270063	0.5GHz~26.5GHz	Jul. 14, 2020	Jul. 13, 2021	Radiation (03CH04-CB)
Signal Analyzer	R&S	FSV40	101904	9kHz ~ 40GHz	Mar 12, 2020	Mar 11, 2021	Radiation (03CH04-CB)
EMI Test Receiver	R&S	ESCS	826547/017	9kHz ~ 2.75GHz	May 13, 2020	May 12, 2021	Radiation (03CH04-CB)
RF Cable-low	Woken	RG402	Low Cable-03+67	30MHz – 1GHz	Nov. 05, 2020	Nov. 04, 2021	Radiation (03CH04-CB)
RF Cable-high	Woken	RG402	High Cable-21	1GHz - 18GHz	Oct. 05, 2020	Oct. 04, 2021	Radiation (03CH04-CB)
RF Cable-high	Woken	RG402	High Cable-21+67	1GHz - 18GHz	Nov. 05, 2020	Nov. 04, 2021	Radiation (03CH04-CB)
RF Cable-high	Woken	RG402	High Cable-40G#1	18GHz ~ 40 GHz	Jul. 16, 2020	Jul. 15, 2021	Radiation (03CH04-CB)
RF Cable-high	Woken	RG402	High Cable-40G#2	18GHz ~ 40 GHz	Jul. 16, 2020	Jul. 15, 2021	Radiation (03CH04-CB)
Test Software	SPORTON	SENSE	V5.10	-	N.C.R.	N.C.R.	Radiation (03CH04-CB)
Spectrum analyzer	R&S	FSV40	101027	9kHz~40GHz	Jul. 27, 2020	Jul. 26, 2021	Conducted (TH02-CB)
Power Sensor	Anritsu	MA2411B	1126203	300MHz~40GHz	Sep. 17, 2020	Sep. 16, 2021	Conducted (TH02-CB)
Power Meter	Anritsu	ML2495A	1210004	300MHz~40GHz	Sep. 17, 2020	Sep. 16, 2021	Conducted (TH02-CB)
RF Cable-high	Woken	RG402	High Cable-01	1 GHz – 18 GHz	Oct. 05, 2020	Oct. 04, 2021	Conducted (TH02-CB)
RF Cable-high	Woken	RG402	High Cable-02	1 GHz – 18 GHz	Oct. 05, 2020	Oct. 04, 2021	Conducted (TH02-CB)
RF Cable-high	Woken	RG402	High Cable-03	1 GHz – 18 GHz	Oct. 05, 2020	Oct. 04, 2021	Conducted (TH02-CB)
RF Cable-high	Woken	RG402	High Cable-04	1 GHz – 18 GHz	Oct. 05, 2020	Oct. 04, 2021	Conducted (TH02-CB)
RF Cable-high	Woken	RG402	High Cable-05	1 GHz – 18 GHz	Oct. 05, 2020	Oct. 04, 2021	Conducted (TH02-CB)
Test Software	SPORTON	SENSE	V5.10	-	N.C.R.	N.C.R.	Conducted (TH02-CB)

Note: Calibration Interval of instruments listed above is one year.

N.C.R. means Non-Calibration required.



Summary

Mode	Result	Type	Freq (Hz)	Level (dBuV)	Limit (dBuV)	Margin (dB)	Condition
Mode 1	Pass	QP	505.5k	47.53	56.00	-8.47	Line

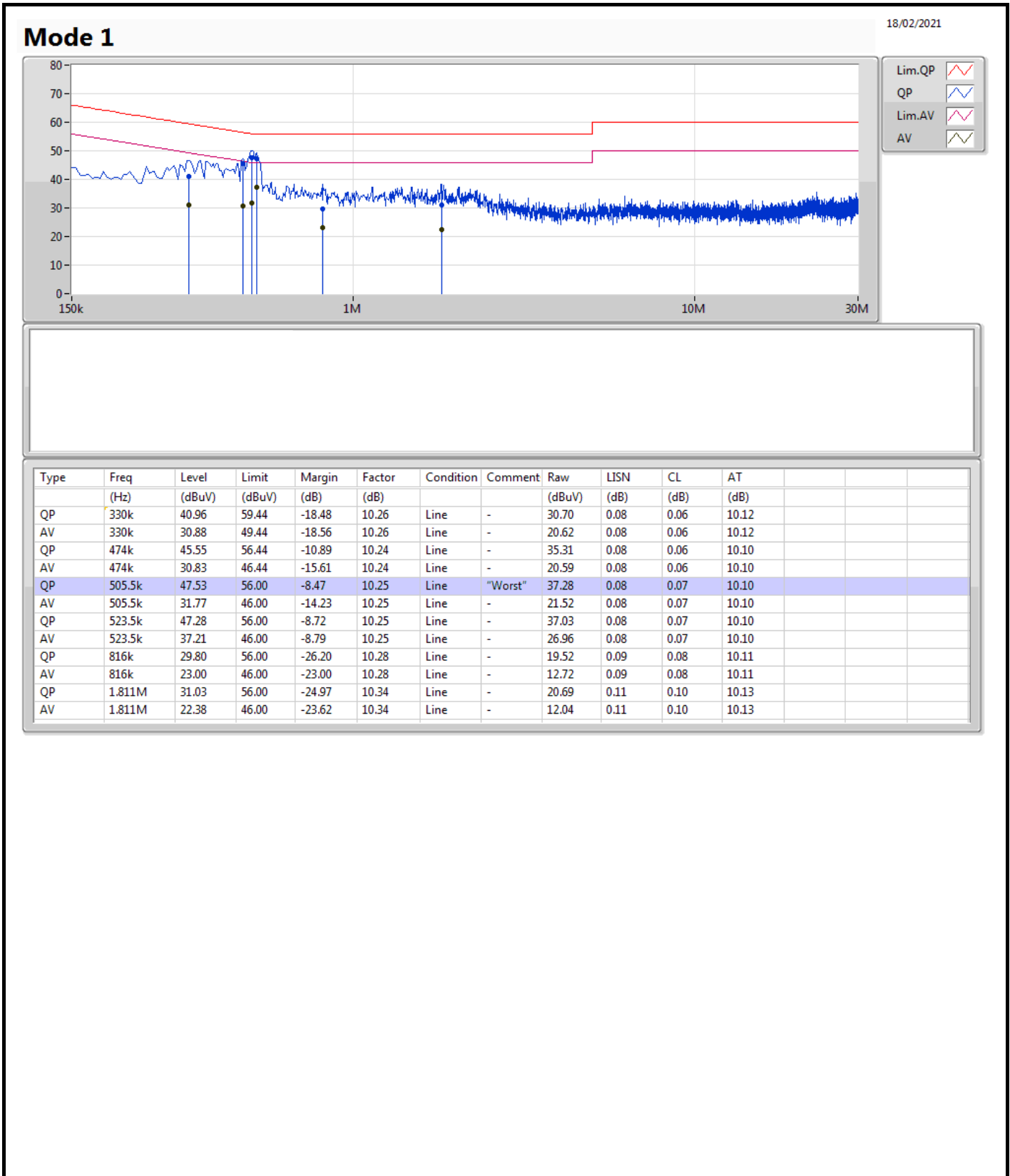

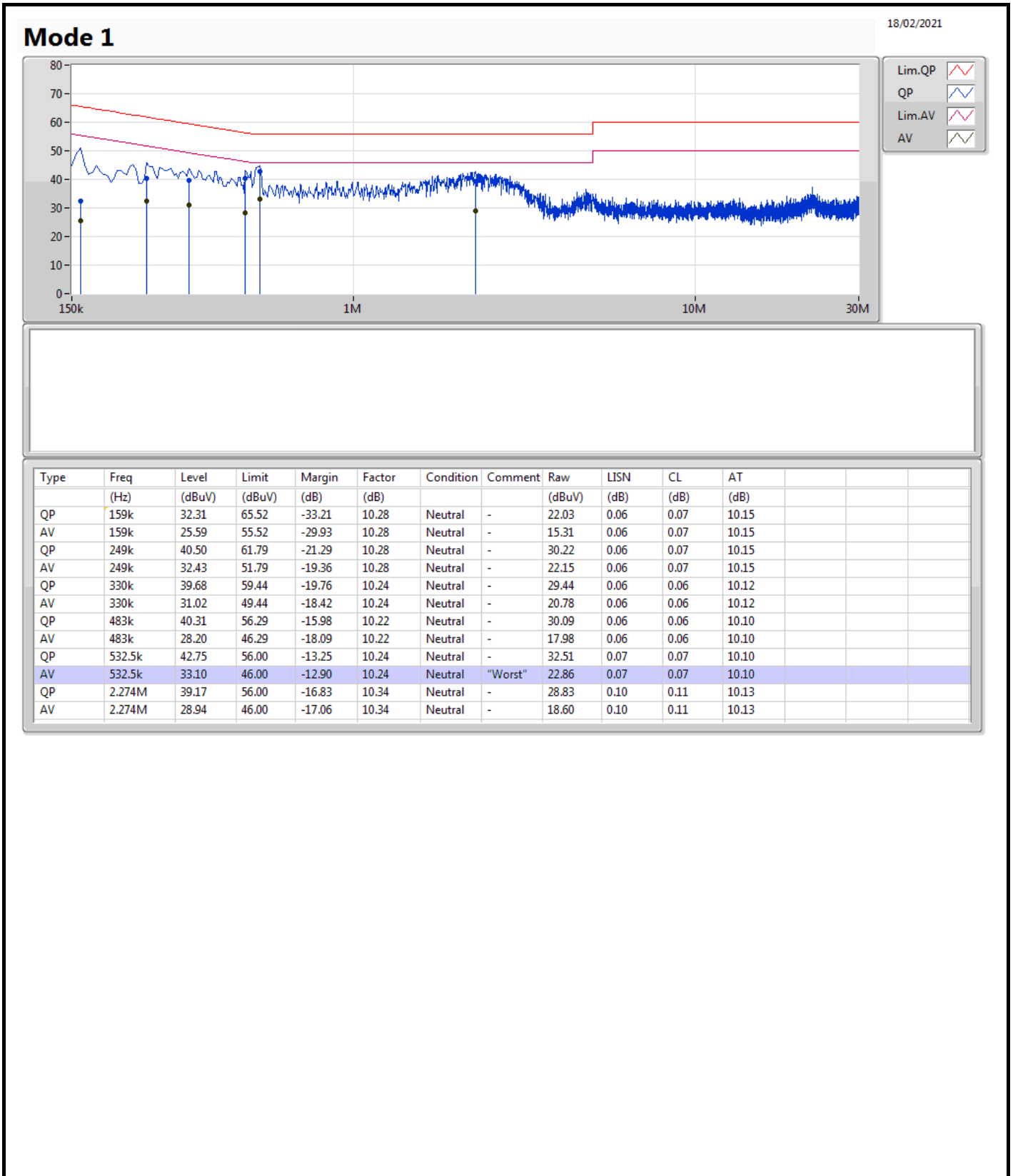



Summary

Mode	Max-N dB (Hz)	Max-OBW (Hz)	ITU-Code	Min-N dB (Hz)	Min-OBW (Hz)
902-928MHz	-	-	-	-	-
LoRa (500kHz)	623.75k	508.496k	508KF1D	615.625k	504.748k

Max-N dB = Maximum 6dB down bandwidth; **Max-OBW** = Maximum 99% occupied bandwidth;
Min-N dB = Minimum 6dB down bandwidth; **Min-OBW** = Minimum 99% occupied bandwidth;

Result

Mode	Result	Limit (Hz)	Port 1-N dB (Hz)	Port 1-OBW (Hz)
LoRa (500kHz)	-	-	-	-
902.5MHz	Pass	500k	615.625k	504.748k
914.5MHz	Pass	500k	620.625k	508.496k
926.5MHz	Pass	500k	623.75k	505.372k

Port X-N dB = Port X 6dB down bandwidth; **Port X-OBW** = Port X 99% occupied bandwidth;

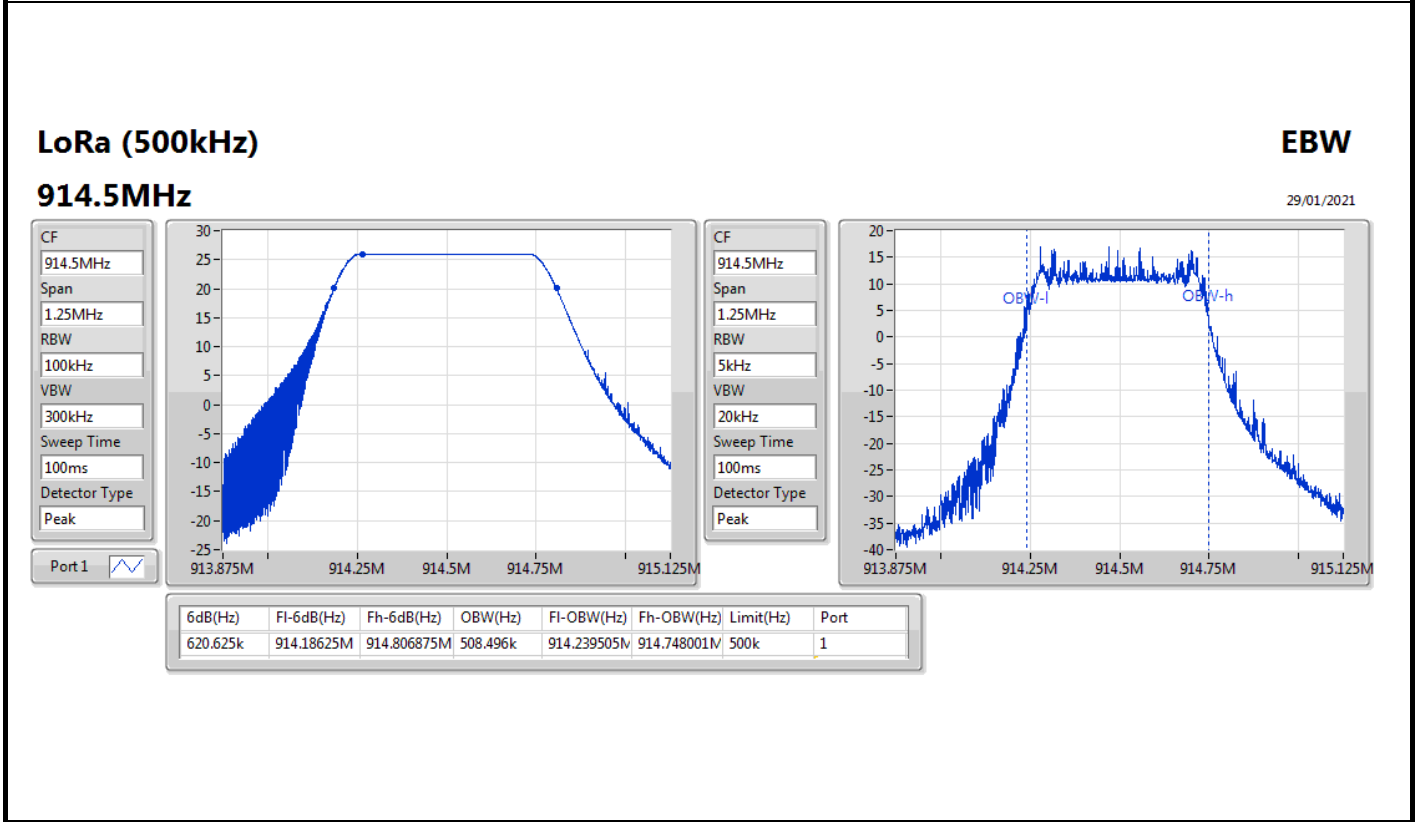
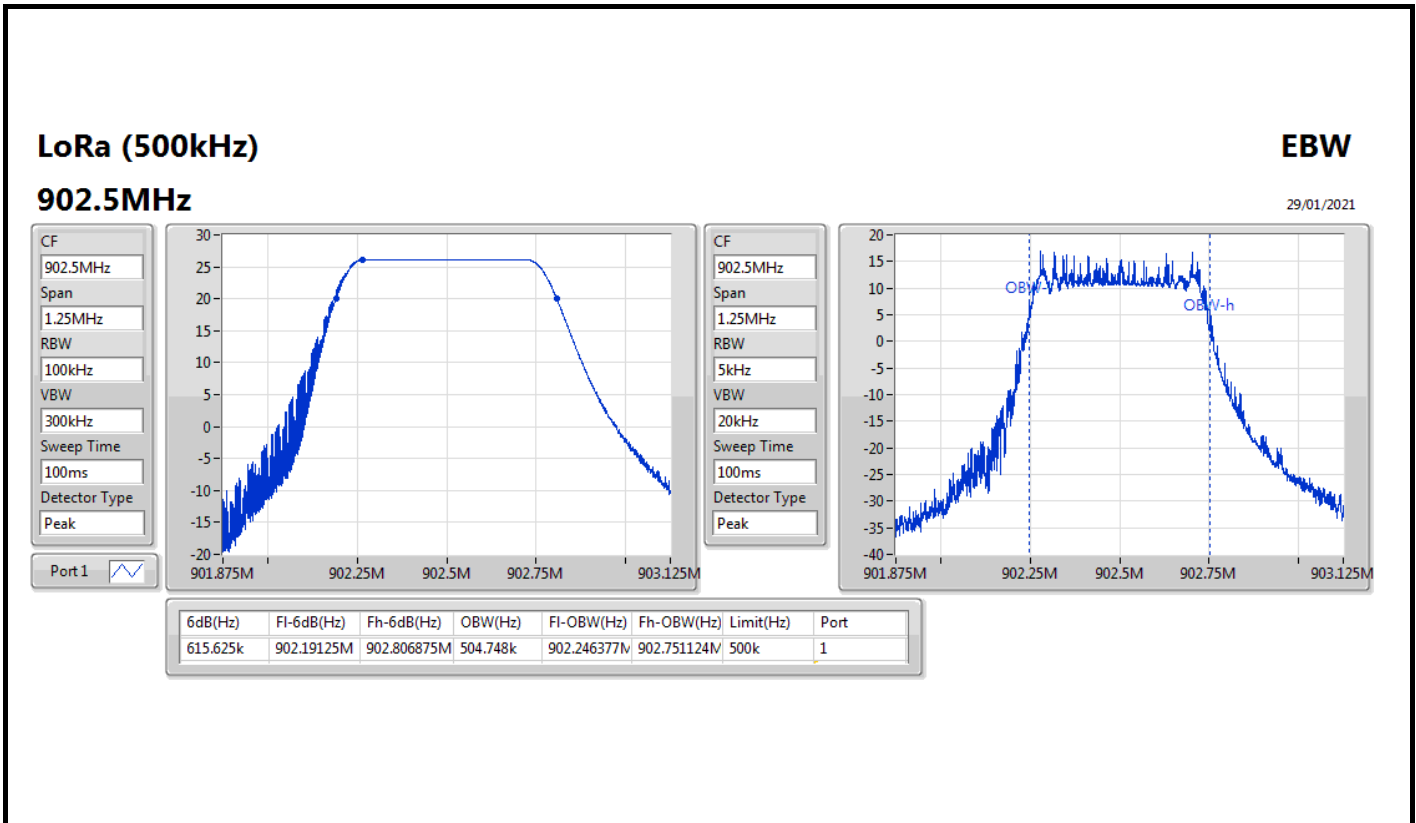

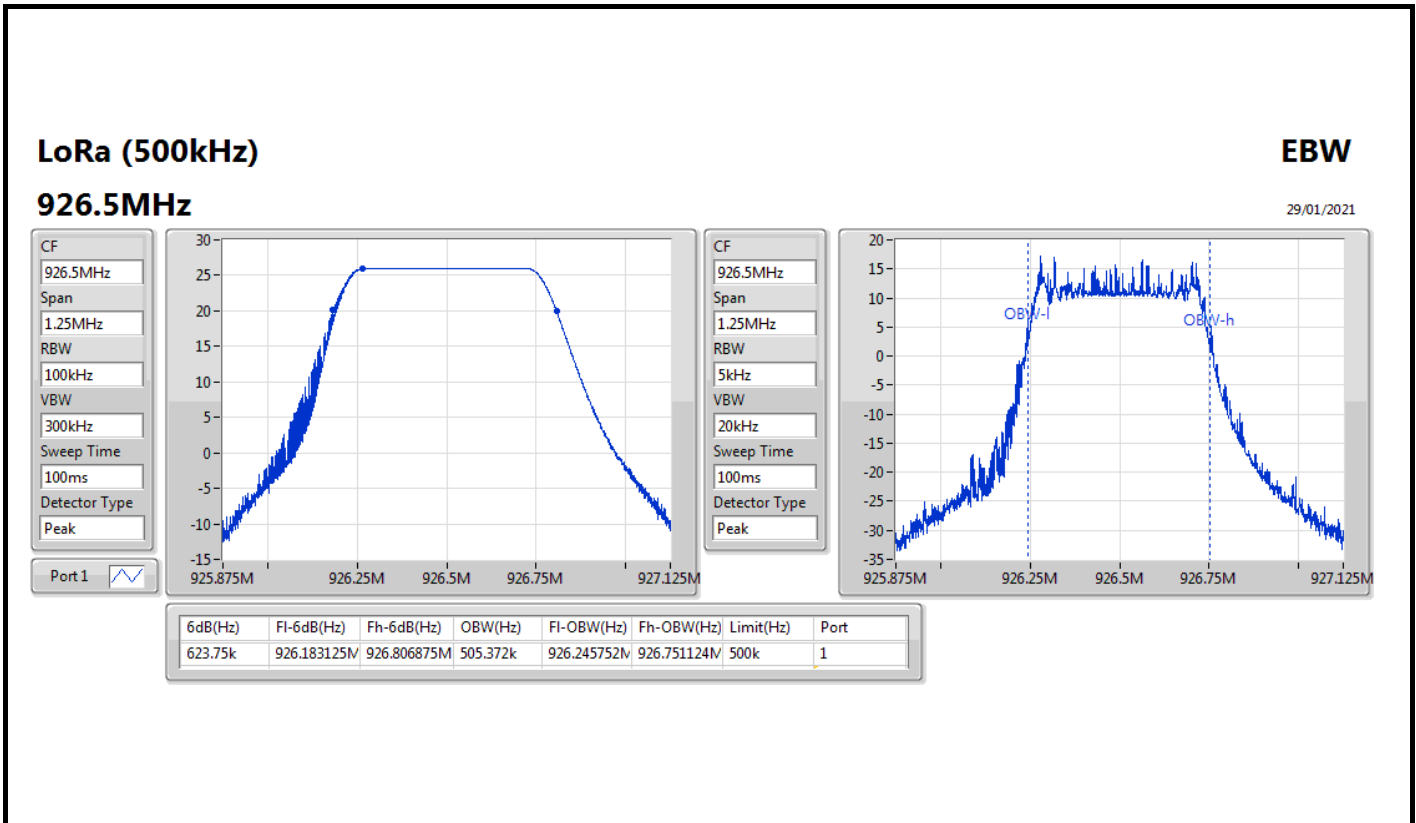



Summary

Mode	Power (dBm)	Power (W)
902-928MHz	-	-
LoRa (500kHz)	25.49	0.35400



Result

Mode	Result	Gain (dBi)	Power (dBm)	Power Limit (dBm)
LoRa (500kHz)	-	-	-	-
902.5MHz	Pass	1.74	25.49	30.00
914.5MHz	Pass	1.74	25.45	30.00
926.5MHz	Pass	1.74	25.38	30.00

DG = Directional Gain; **Port X** = Port X output power



Summary

Mode	PD (dBm/RBW)
902-928MHz	-
LoRa (500kHz)	7.27

RBW=3 kHz.



Result

Mode	Result	Gain (dBi)	PD (dBm/RBW)	PD Limit (dBm/RBW)
LoRa (500kHz)	-	-	-	-
902.5MHz	Pass	1.74	7.27	8.00
914.5MHz	Pass	1.74	6.73	8.00
926.5MHz	Pass	1.74	6.98	8.00

DG = Directional Gain; RBW=3 kHz;

PD = trace bin-by-bin of each transmits port summing can be performed maximum power density; Port X = Port X power density;

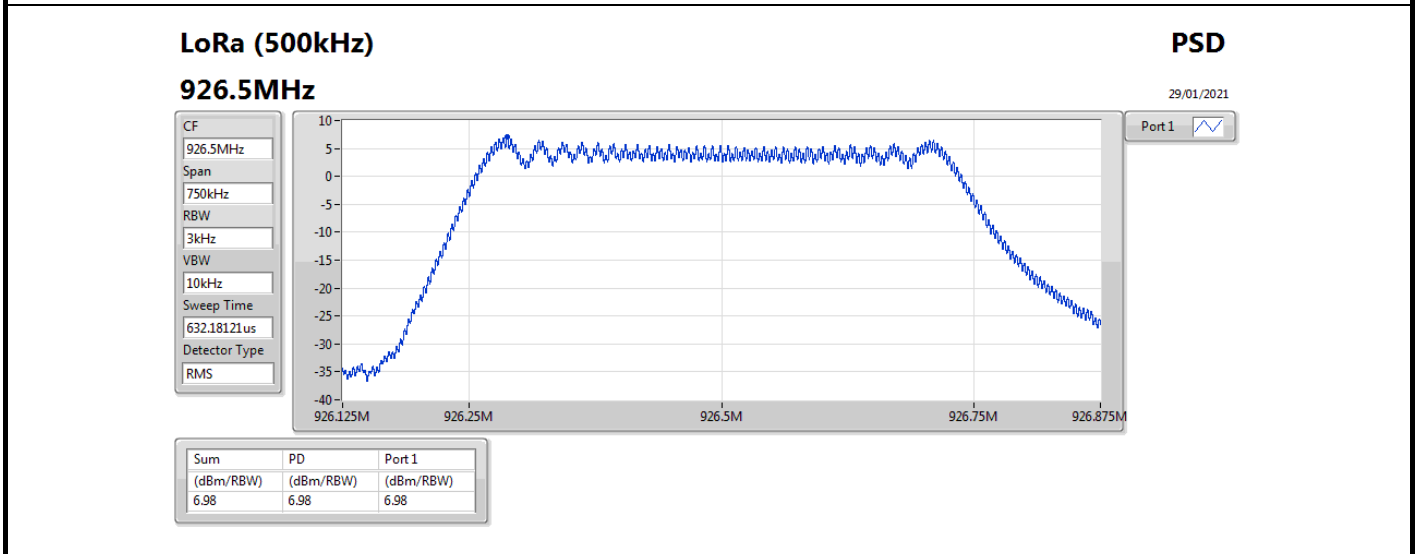
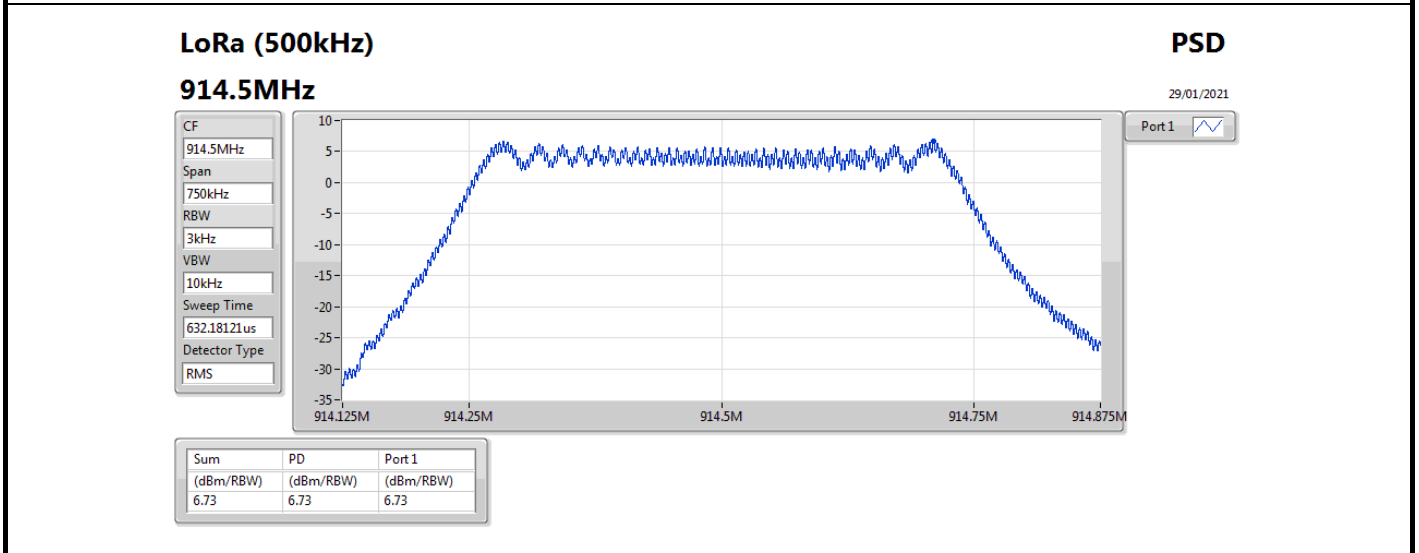
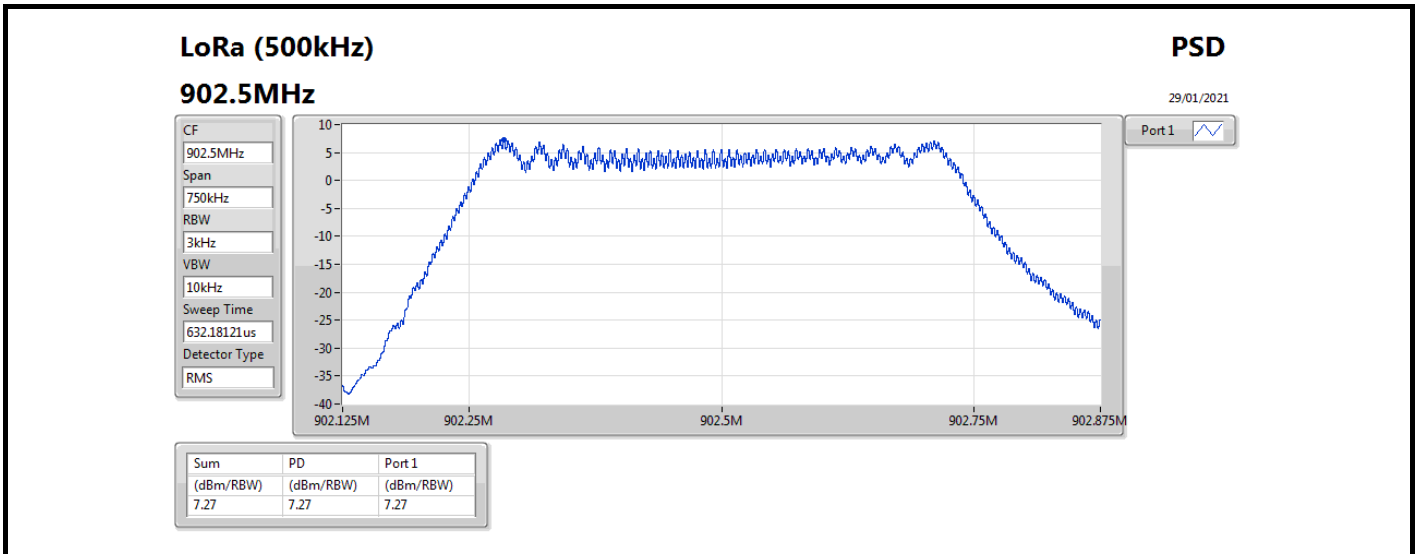



Summary

Mode	Result	Ref (Hz)	Ref (dBm)	Limit (dBm)	Freq (Hz)	Level (dBm)	Freq (Hz)	Level (dBm)	Freq (Hz)	Level (dBm)	Freq (Hz)	Level (dBm)	Freq (Hz)	Level (dBm)	Port
902-928MHz	-	-	-	-	-	-	-	-	-	-	-	-	-	-	-
LoRa (500kHz)	Pass	902.26M	26.02	-3.98	870.5M	-46.73	902M	-11.79	902M	-10.59	934.64M	-45.43	1.80455G	-40.62	1



Result

Mode	Result	Ref (Hz)	Ref (dBm)	Limit (dBm)	Freq (Hz)	Level (dBm)	Freq (Hz)	Level (dBm)	Freq (Hz)	Level (dBm)	Freq (Hz)	Level (dBm)	Freq (Hz)	Level (dBm)	Port
LoRa (500kHz)	-	-	-	-	-	-	-	-	-	-	-	-	-	-	-
902.5MHz	Pass	902.26M	26.02	-3.98	870.5M	-46.73	902M	-11.79	902M	-10.59	934.64M	-45.43	1.80455G	-40.62	1
914.5MHz	Pass	914.26M	25.96	-4.04	829.92M	-49.40	882.28M	-44.82	902M	-51.65	946.63M	-45.78	1.82831G	-40.70	1
926.5MHz	Pass	926.27M	25.86	-4.14	828.64M	-49.97	894.5M	-45.35	928M	-24.33	928.12M	-22.36	1.8532G	-40.92	1

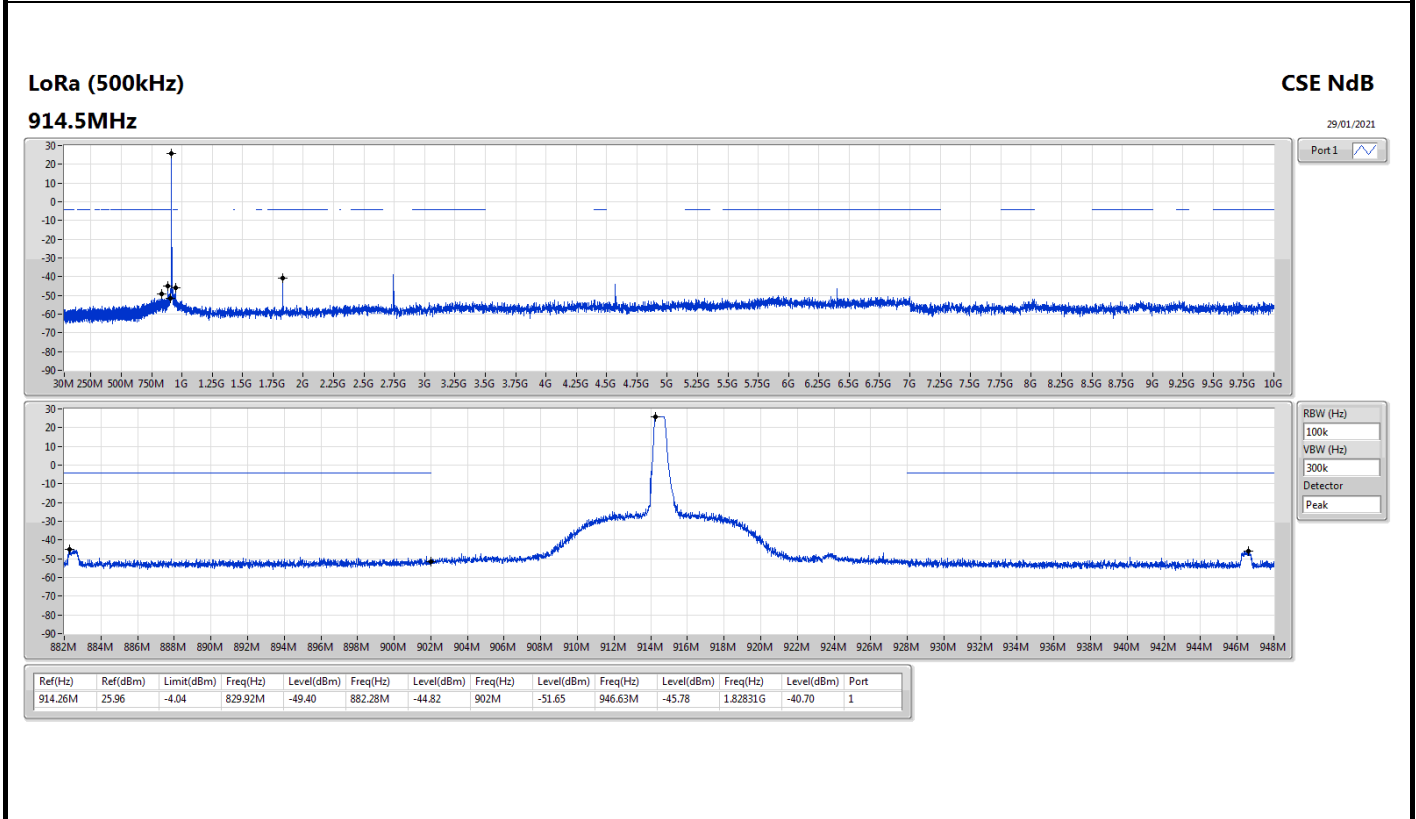
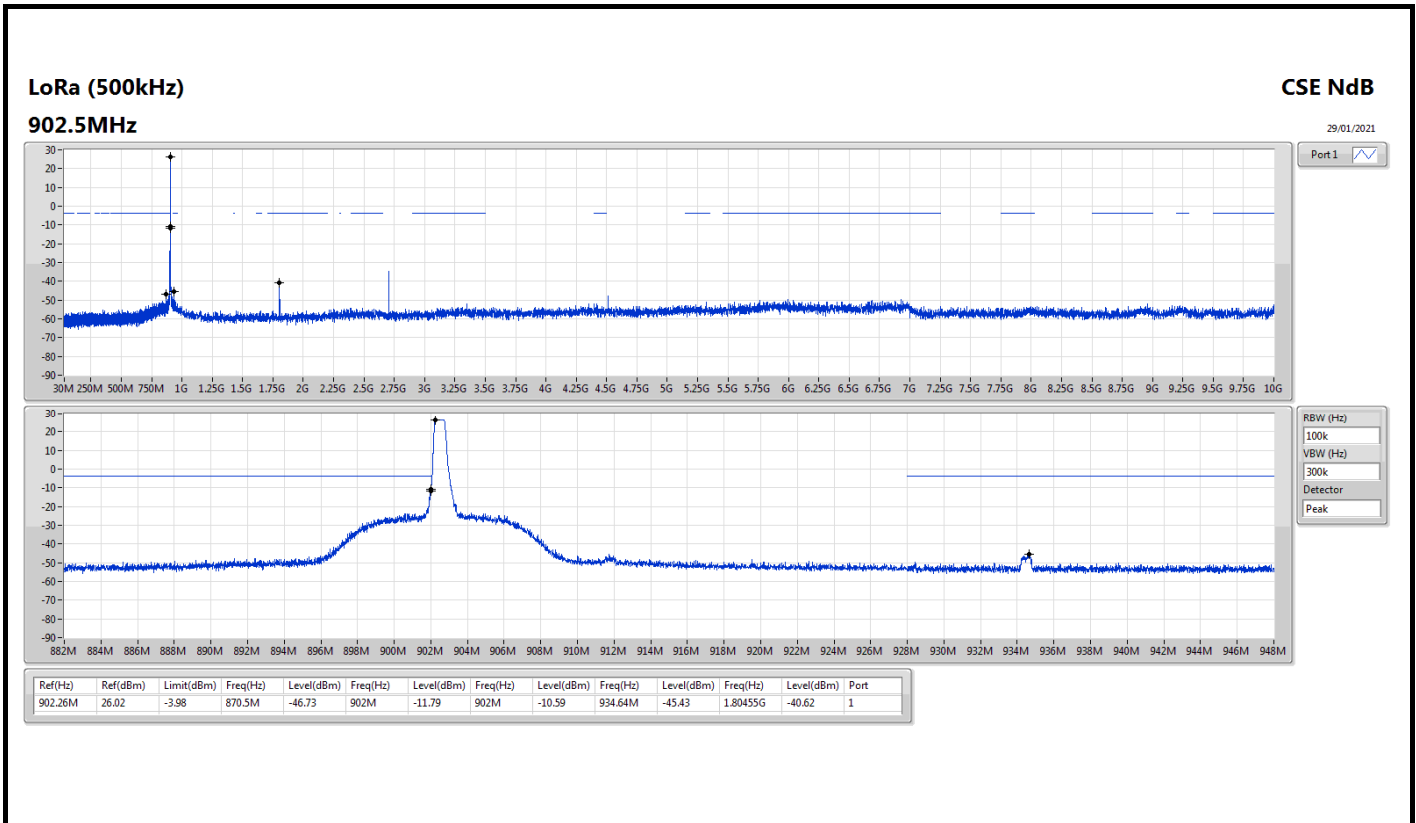

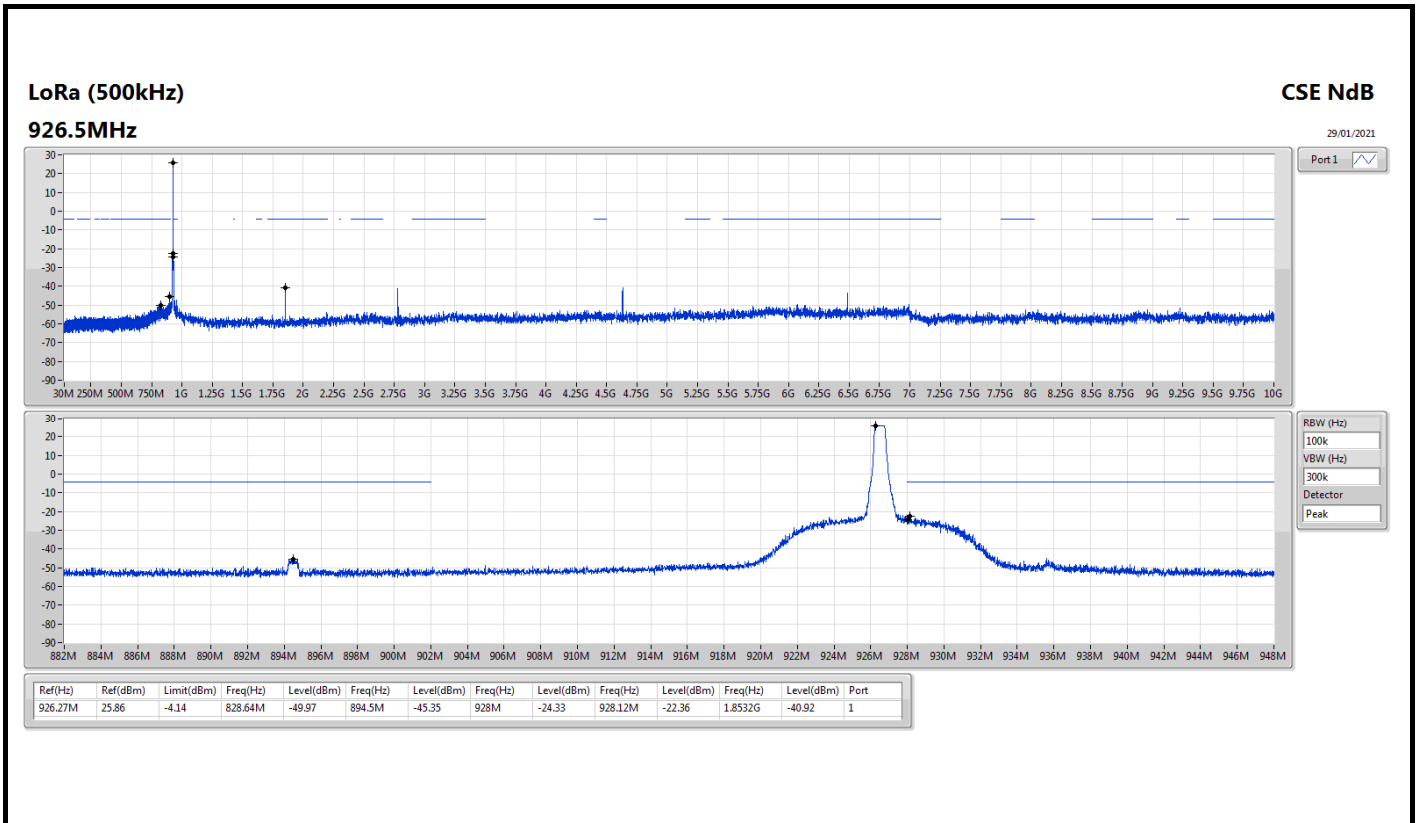



Summary

Mode	Result	Type	Freq (Hz)	Level (dBuV/m)	Limit (dBuV/m)	Margin (dB)	Condition
Mode 1	Pass	PK	44.55M	36.59	40.00	-3.41	Vertical

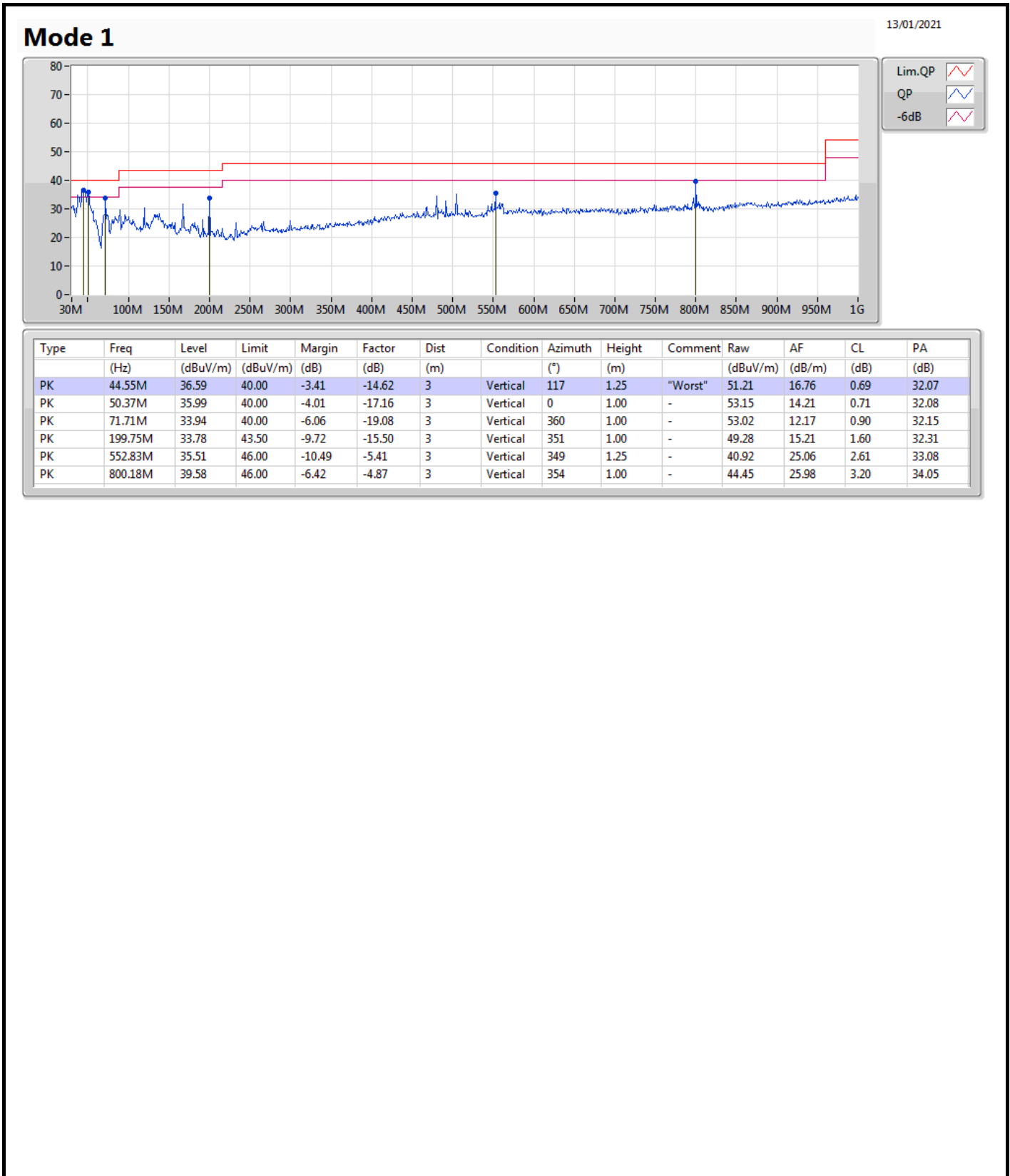

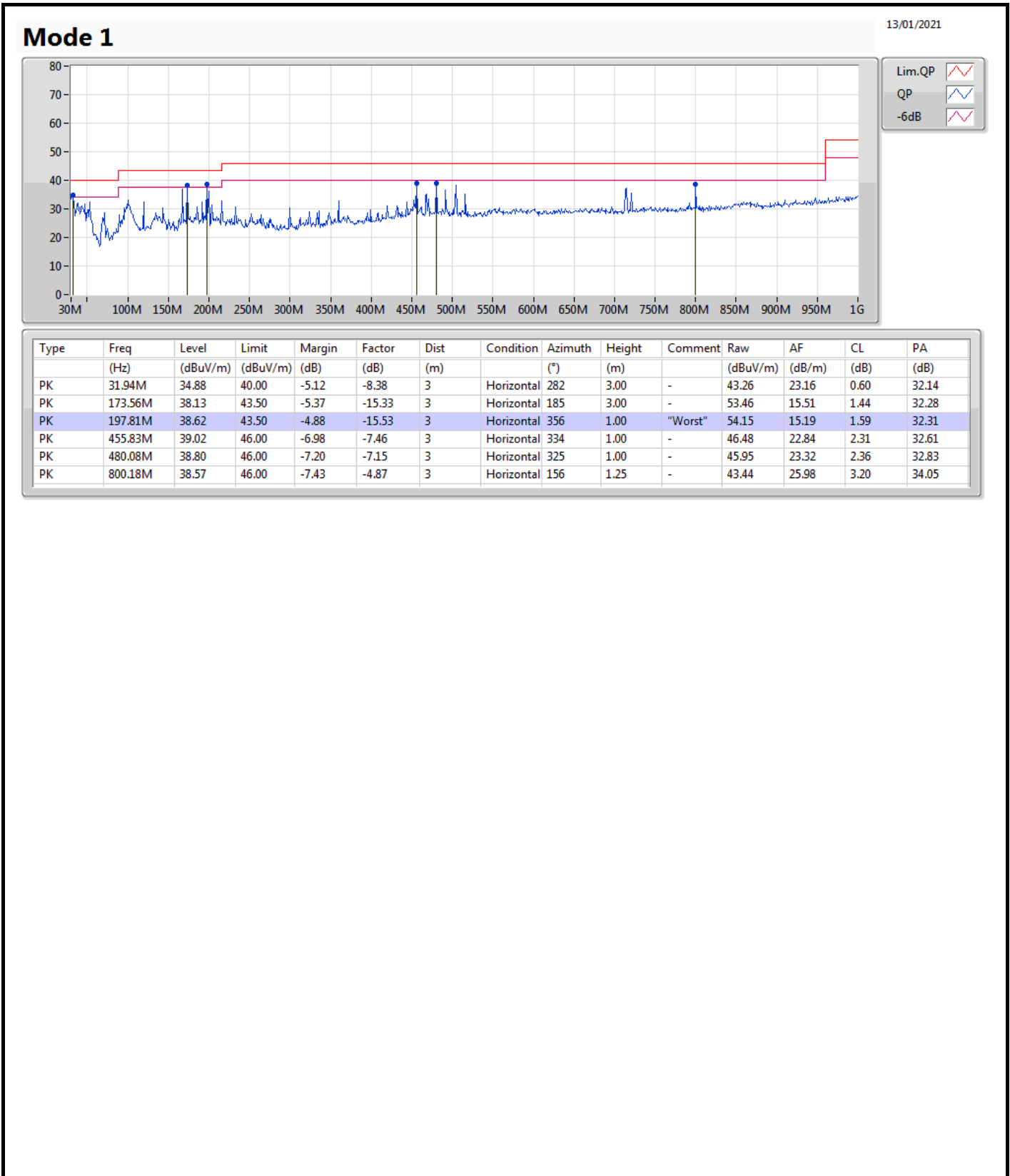



Summary

Mode	Result	Type	Freq (Hz)	Level (dBuV/m)	Limit (dBuV/m)	Margin (dB)	Dist (m)	Condition	Azimuth (°)	Height (m)	Comments
902-928MHz	-	-	-	-	-	-	-	-	-	-	-
LoRa (500kHz)	Pass	AV	2.7074G	35.59	54.00	-18.41	3	Vertical	101	1.52	-

LoRa (500kHz)

26/01/2021

902.5MHz_TX

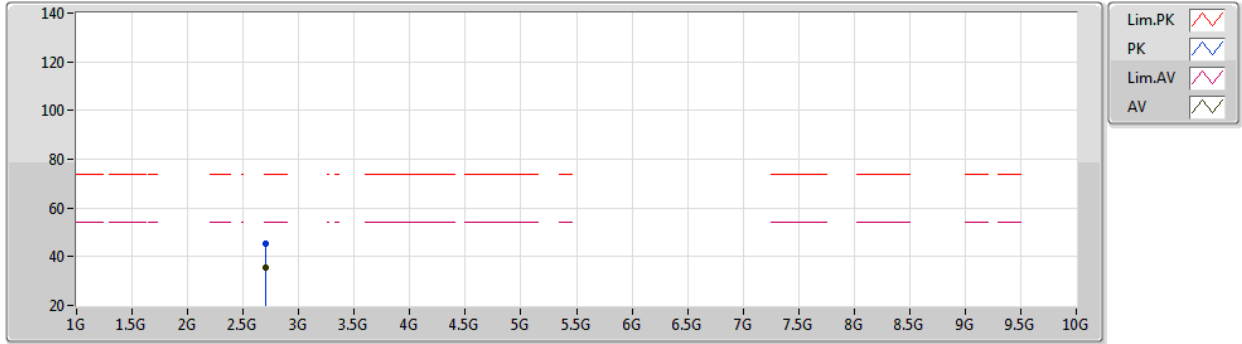

EUT X_1TX
Setting 14
04-E-B-2

Type	Freq (Hz)	Level (dBuV/m)	Limit (dBuV/m)	Margin (dB)	Raw (dBuV)	Dist (m)	Condition	Azimuth (°)	Height (m)	Comment	AF (dB)	CL (dB)	PA (dB)
PK	2.70763G	45.50	74.00	-28.50	47.12	3	Vertical	101	1.52	-	28.67	4.11	34.40
AV	2.7074G	35.59	54.00	-18.41	37.21	3	Vertical	101	1.52	-	28.67	4.11	34.40

LoRa (500kHz)

26/01/2021

902.5MHz_TX

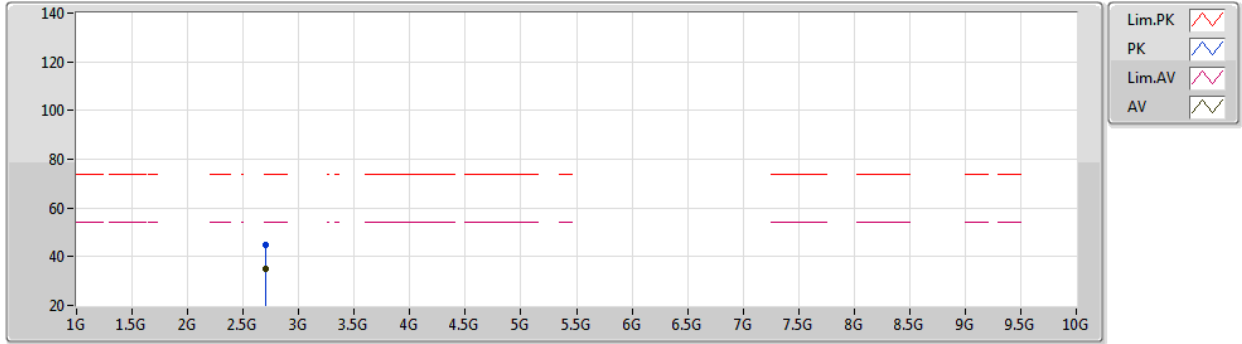

EUT X_1TX
Setting 14
04-E-B-2

Type	Freq (Hz)	Level (dBuV/m)	Limit (dBuV/m)	Margin (dB)	Raw (dBuV)	Dist (m)	Condition	Azimuth (°)	Height (m)	Comment	AF (dB)	CL (dB)	PA (dB)
PK	2.7076G	44.88	74.00	-29.12	46.50	3	Horizontal	8	2.80	-	28.67	4.11	34.40
AV	2.70748G	34.84	54.00	-19.16	36.46	3	Horizontal	8	2.80	-	28.67	4.11	34.40

LoRa (500kHz)

26/01/2021

914.5MHz_TX

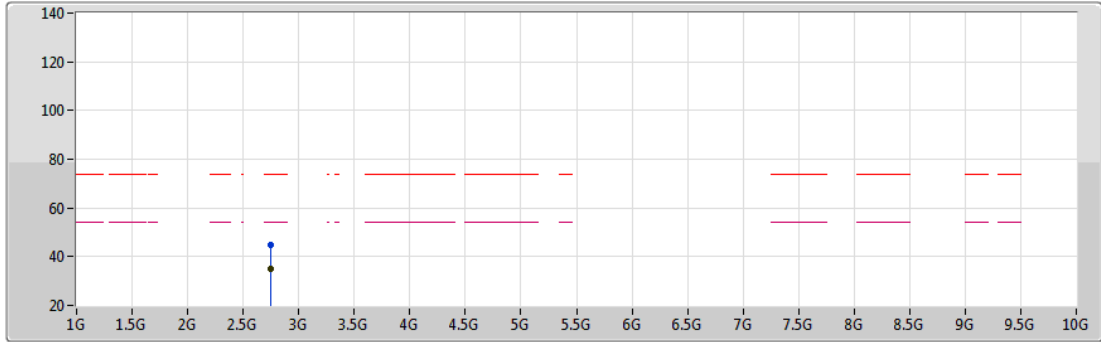

EUT X_1TX
Setting 14
04-E-B-2

Type	Freq (Hz)	Level (dBuV/m)	Limit (dBuV/m)	Margin (dB)	Raw (dBuV)	Dist (m)	Condition	Azimuth (°)	Height (m)	Comment	AF (dB)	CL (dB)	PA (dB)
PK	2.74369G	44.72	74.00	-29.28	46.42	3	Vertical	99	1.17	-	28.53	4.14	34.37
AV	2.74347G	35.23	54.00	-18.77	36.93	3	Vertical	99	1.17	-	28.53	4.14	34.37

LoRa (500kHz)

26/01/2021

914.5MHz_TX

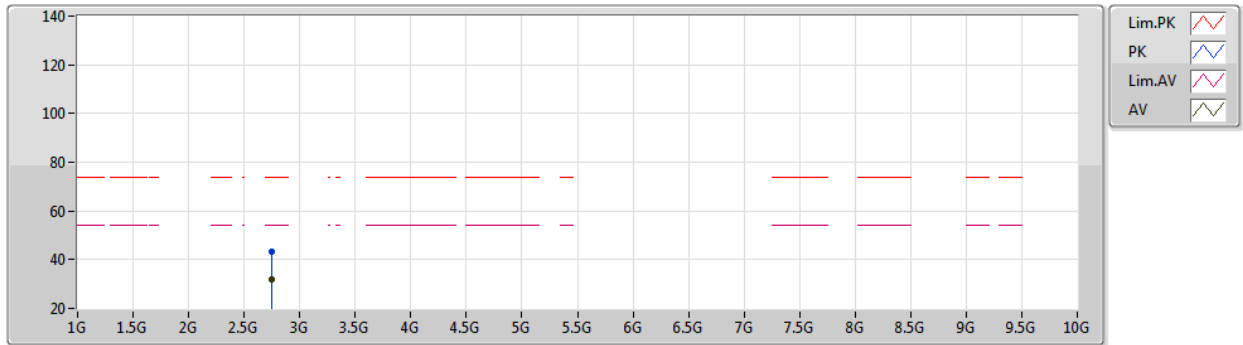

EUT X_1TX
Setting 14
04-E-B-2

Type	Freq (Hz)	Level (dBuV/m)	Limit (dBuV/m)	Margin (dB)	Raw (dBuV)	Dist (m)	Condition	Azimuth (°)	Height (m)	Comment	AF (dB)	CL (dB)	PA (dB)
PK	2.74389G	43.02	74.00	-30.98	44.73	3	Horizontal	13	1.80	-	28.52	4.14	34.37
AV	2.74346G	31.80	54.00	-22.20	33.50	3	Horizontal	13	1.80	-	28.53	4.14	34.37

LoRa (500kHz)

26/01/2021

926.5MHz_TX

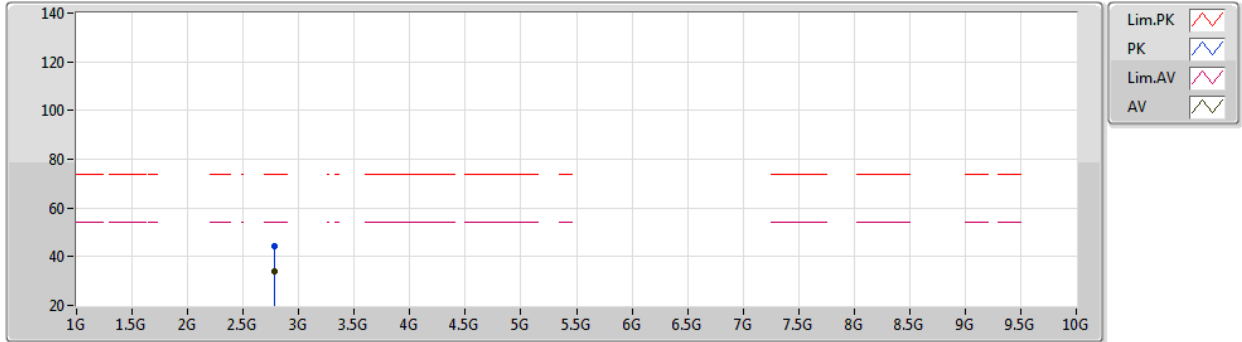

EUT X_1TX
Setting 14
04-E-B-2

Type	Freq (Hz)	Level (dBuV/m)	Limit (dBuV/m)	Margin (dB)	Raw (dBuV)	Dist (m)	Condition	Azimuth (°)	Height (m)	Comment	AF (dB)	CL (dB)	PA (dB)
PK	2.77983G	44.52	74.00	-29.48	46.13	3	Vertical	100	1.51	-	28.56	4.18	34.35
AV	2.77946G	33.71	54.00	-20.29	35.32	3	Vertical	100	1.51	-	28.56	4.18	34.35

LoRa (500kHz)

26/01/2021

926.5MHz_TX

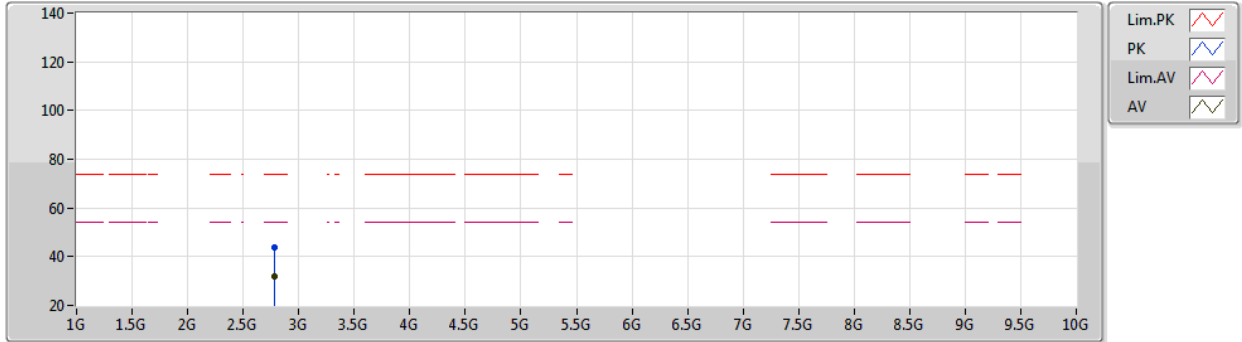

EUT X_1TX
Setting 14
04-E-B-2

Type	Freq (Hz)	Level (dBuV/m)	Limit (dBuV/m)	Margin (dB)	Raw (dBuV)	Dist (m)	Condition	Azimuth (°)	Height (m)	Comment	AF (dB)	CL (dB)	PA (dB)
PK	2.77939G	43.57	74.00	-30.43	45.18	3	Horizontal	14	2.47	-	28.56	4.18	34.35
AV	2.77948G	32.12	54.00	-21.88	33.73	3	Horizontal	14	2.47	-	28.56	4.18	34.35