

User Manual

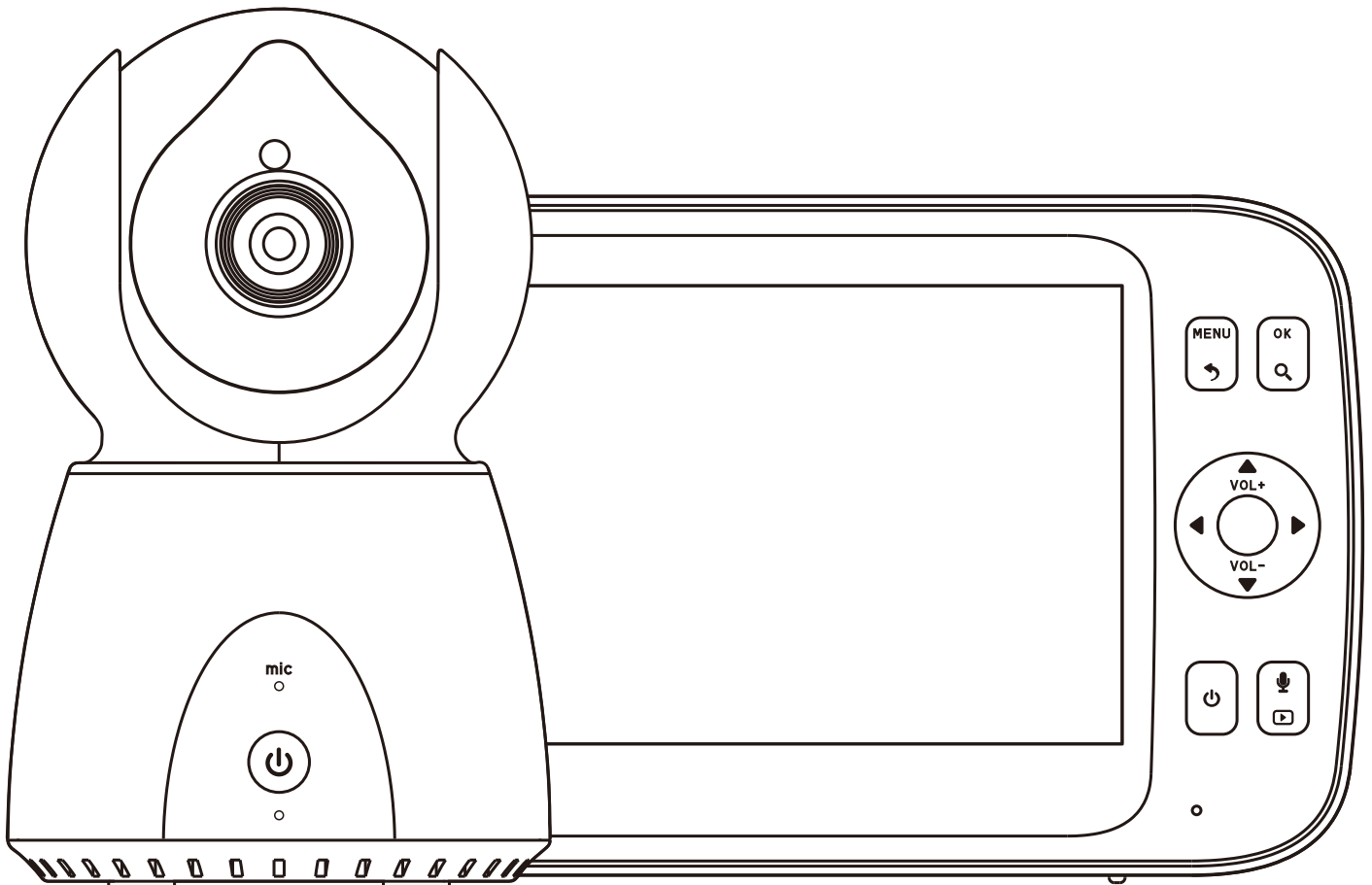

QUICK START GUIDE

Federal Communications Commission (FCC) Statement

This device complies with part 15 of the FCC Rules. Operation is subject to the following two conditions: (1) This device may not cause harmful interference, and (2) this device must accept any interference received, including interference that may cause undesired operation.

Note: This equipment has been tested and found to comply with the limits for a Class B digital device, pursuant to part 15 of the FCC Rules. These limits are designed to provide reasonable protection against harmful interference in a residential installation. This equipment generates, uses and can radiate radio frequency energy and, if not installed and used in accordance with the instructions, may cause harmful interference to radio communications. However, there is no guarantee that interference will not occur in a particular installation. If this equipment does cause harmful interference to radio or television reception, which can be determined by turning the equipment off and on, the user is encouraged to try to correct the interference by one or more of the following measures:

- Reorient or relocate the receiving antenna.
- Increase the separation between the equipment and receiver.
- Connect the equipment into an outlet on a circuit different from that to which the receiver is connected.
- Consult the dealer or an experienced radio/TV technician for help.

Warning: Changes or modifications made to this device not expressly approved by Huafun International (China) Development Co., Ltd. may void the FCC authorization to operate this device.

Note: The manufacturer is not responsible for any radio or TV interference caused by unauthorized modifications to this equipment. Such modifications could void the user's authority to operate the equipment.

1. Setting up your Video Baby Monitor

1.1. Connecting the power adapter for the baby unit

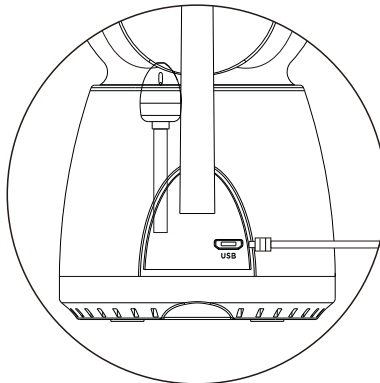



- . Connect the small plug of the adapter to the Baby Unit and the other end to the power socket
- . Only use the enclosed adapter(5V DC/1.5A~2A)

WARNING



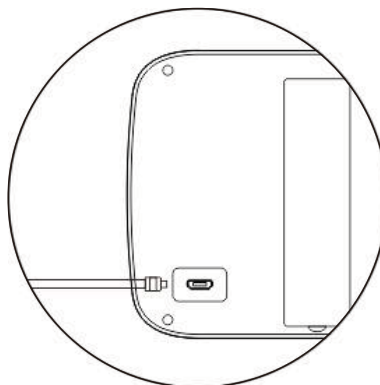





Strangulation Hazard: Children have STRANGLED in cords. Keep this cord out of the reach of the children(more than 1 metre away).

1.2. Connecting the power adapter for the Parent Unit if PU is in low battery status.



- . Connect the small plug of the adapter to the Parent Unit and the other end to the power socket
- . Only use the enclosed adapter(5V DC/1.5A)
- . Recommended charging time of at least 16 hours before first use.
- . Press and hold the POWER button  on the parent unit to turn it ON.

2. Basic operation of the keys

PARENT UNIT		
	ON/OFF button	Press and hold to switch the Parent Unit ON/OFF Press to turn the video screen ON/OFF
	UP/DOWN buttons	Press to tilt the camera upward or downward. Press to adjust volume level
	LEFT/RIGHT buttons	Press to pan the camera left or right
OK	OK buttons	Press to confirm a selection
	Back key	Press to back to previous directory
MENU	Menu buttons	Press to access different menu options or exit the menu
	VIDEO button	Press to back to video screen
	TALK button	Press and hold to talk to your baby
	Digital Zoom button	Press to digital zoom
BABY UNIT		
	ON/OFF button	Press and hold to switch the Baby Unit ON/OFF
	PAIR button	Press and hold to pair to the Parent Unit

3. MENU options and Functions

Camera

Press MENU button--- Select Camera icon---press" OK" button---Press add camera (it support add 4 camera at most) ---press OK button---then press camera " Pair" button to pair within 30 seconds.

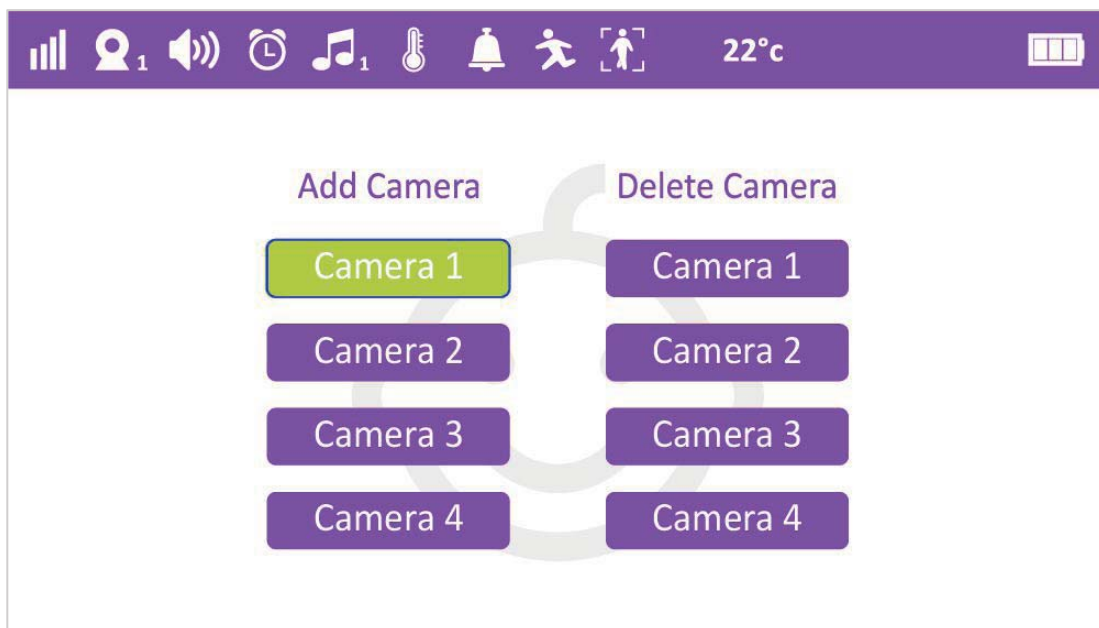
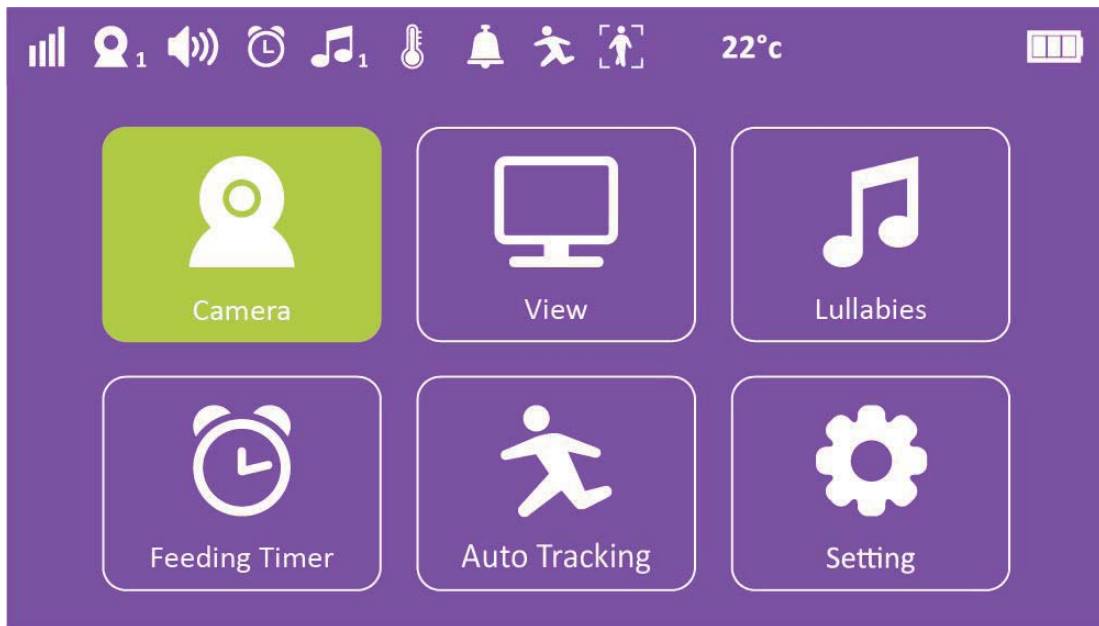



View

Press MENU button---Select View icon--press " OK" button---then you can choose camera 1/ camera 2/ camera 3/camera 4 or scan this 4 cameras to view.

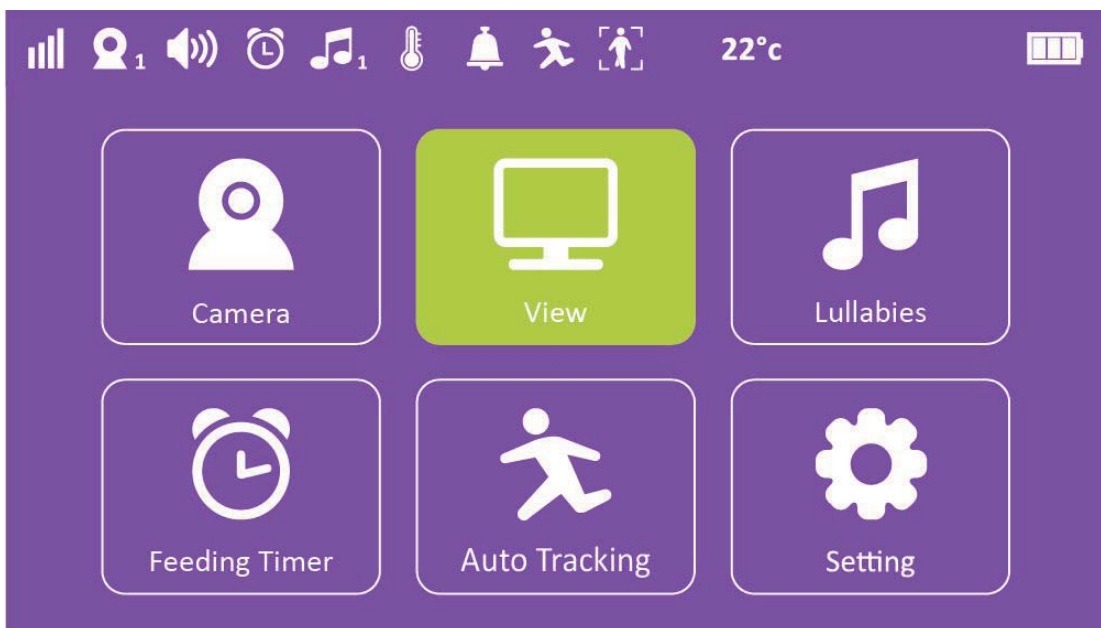



Camera 1

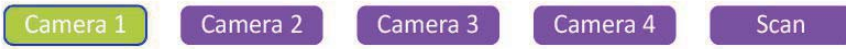
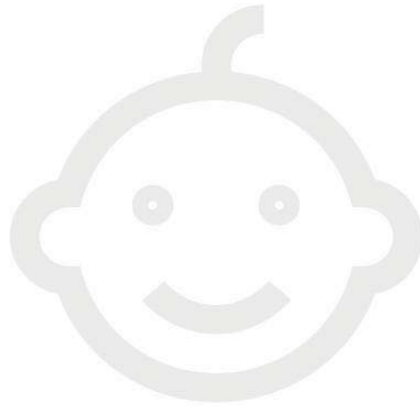

Camera 2

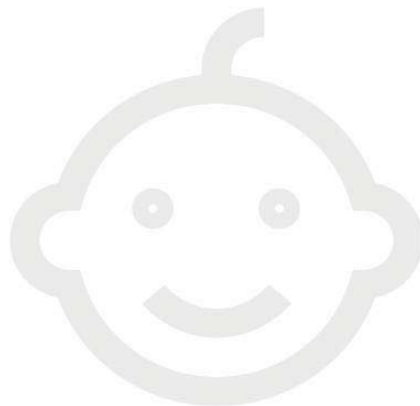

Lullabies

Press MENU button---Select Lullabies icon--press " OK" button---then you can choose lullaby to play from lullabies list. It will automatically single cycle once you chose one of lullaby; If chose All, it will automatically repeat all lullabies list.

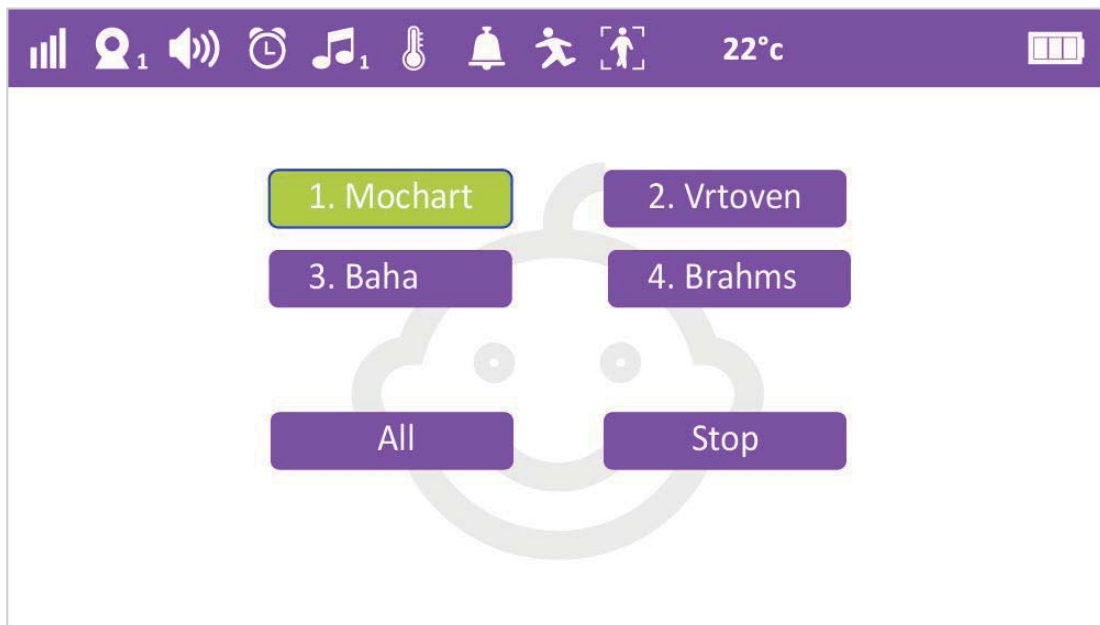
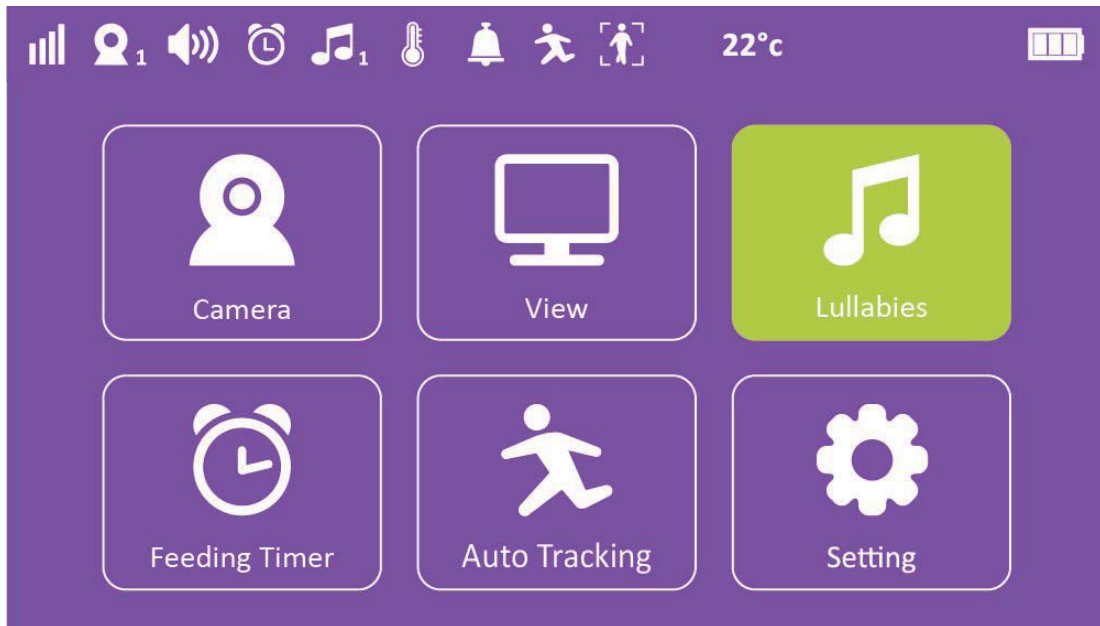

Feeding Timer

Press MENU button---Select Feeding Timer icon--press" OK" button--then you can choose the time to remind for feeding kids.----after selected, count down bar will appear in video view interface--- when up to predefined time, monitor will alarm for 5 seconds.

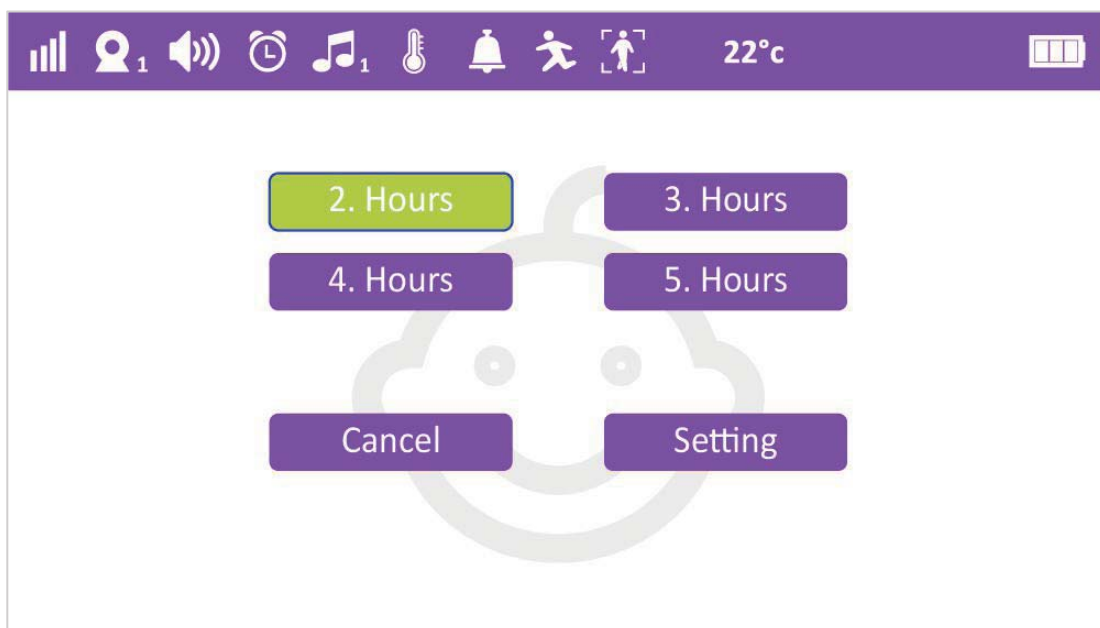
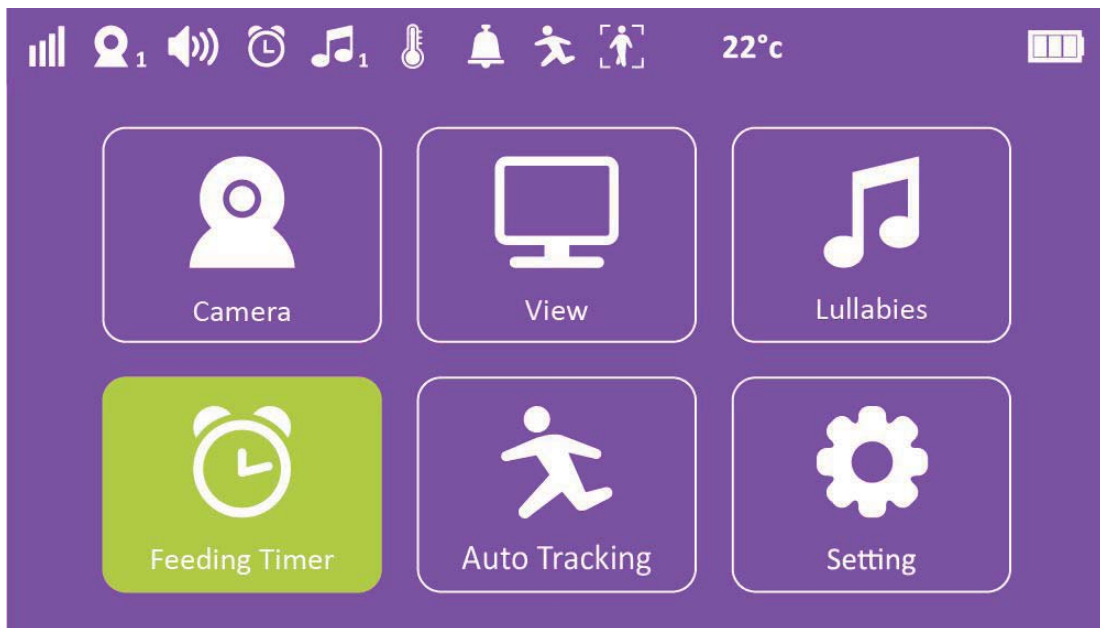

Auto Tracking

Press MENU button---Select Auto Tracking icon---press" ON/OFF" to enable/disable this function---After selected ON, camera will automatically move following with the people or object in front of it.

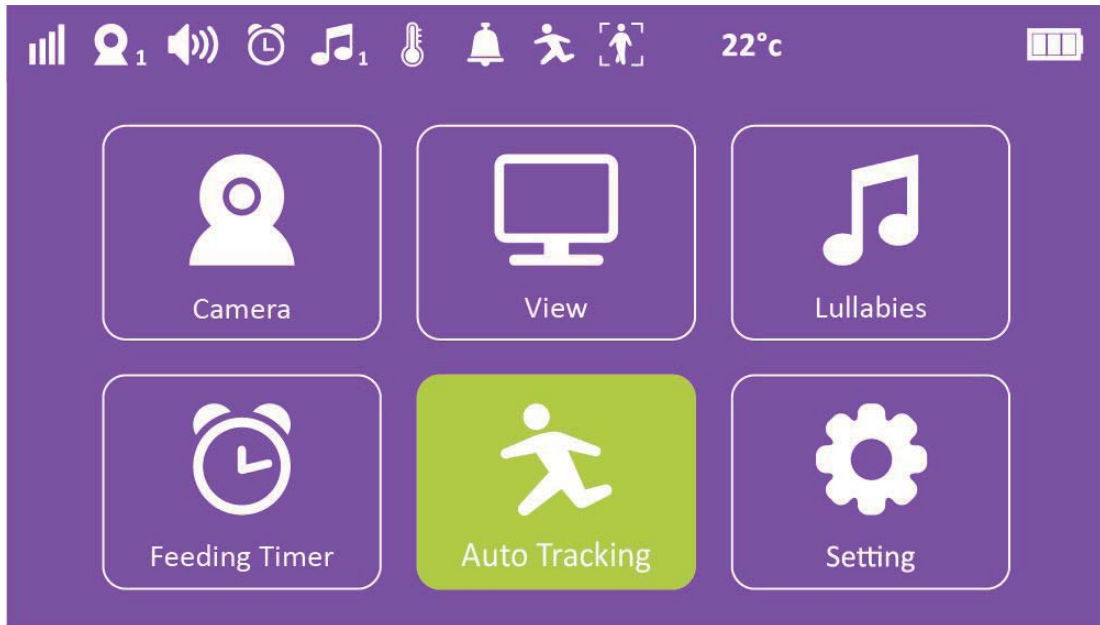

4. Setting

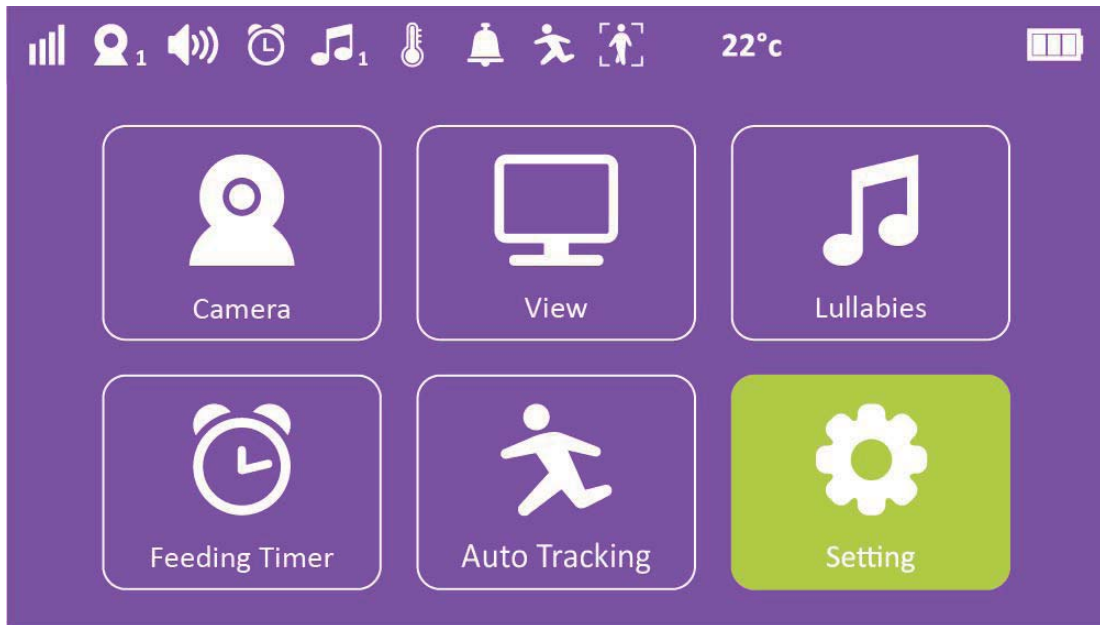

4.1 Language Setting

User can select the language to display

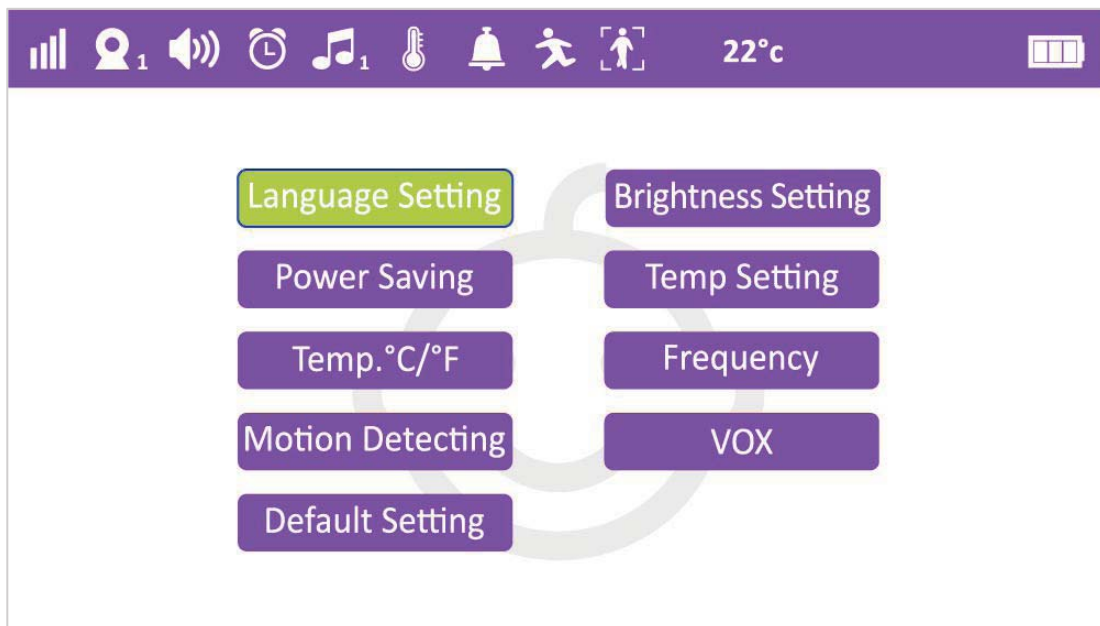

4.2 Brightness Setting

User can select brightness level.

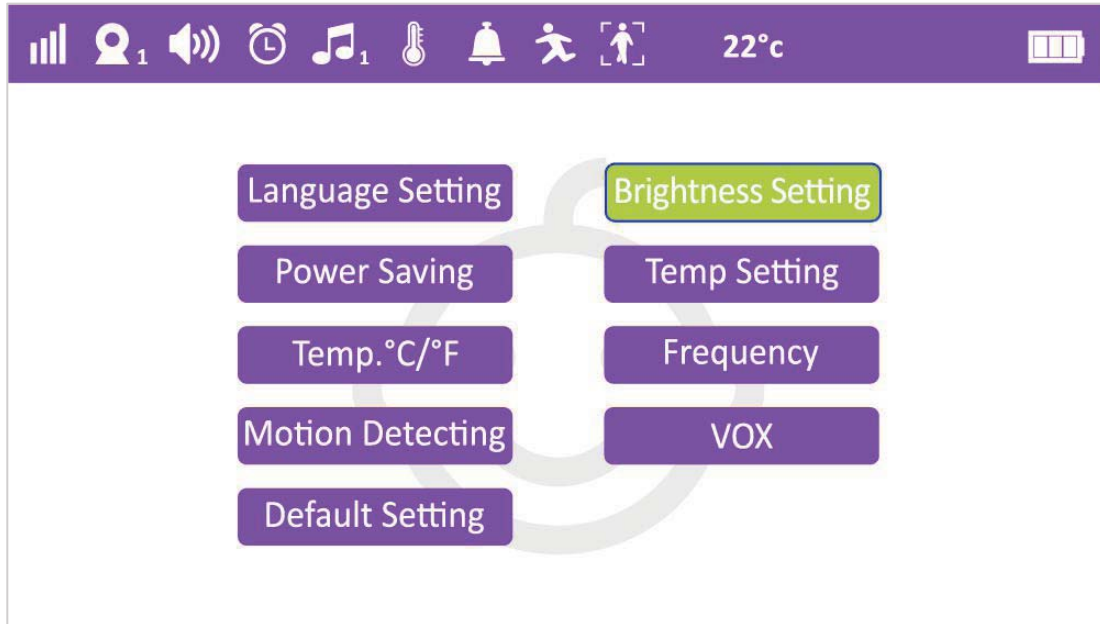

4.3 Power saving

By this function selected to ON, monitor device will enter into power saving mode automatically within 5 seconds, which means screen will off into black status, and it can be only wake up by pressing POWER button.

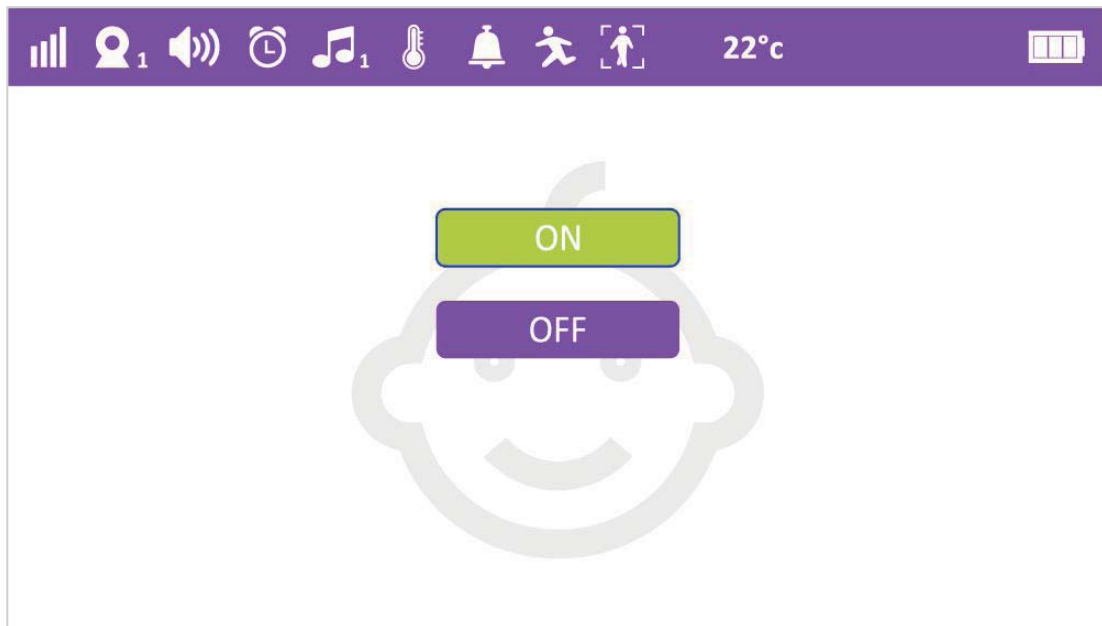
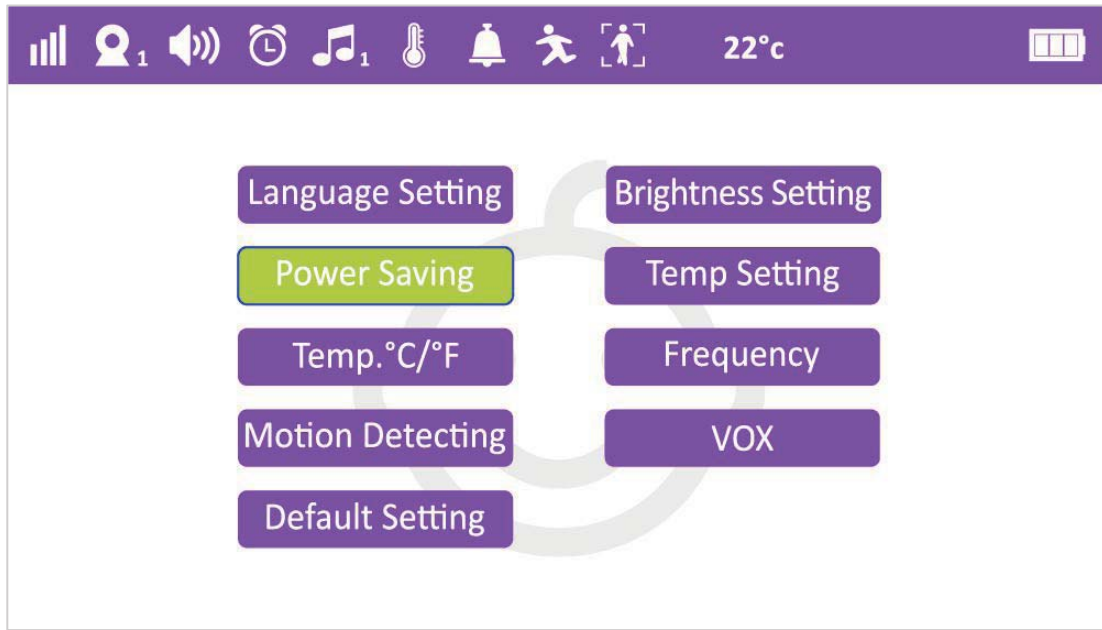

4.4 High-low Temperature alarm setting

User can adjust the highest and lowest temperature limitation data, when room temp reach or beyond the limitation, monitor will alarm automatically.

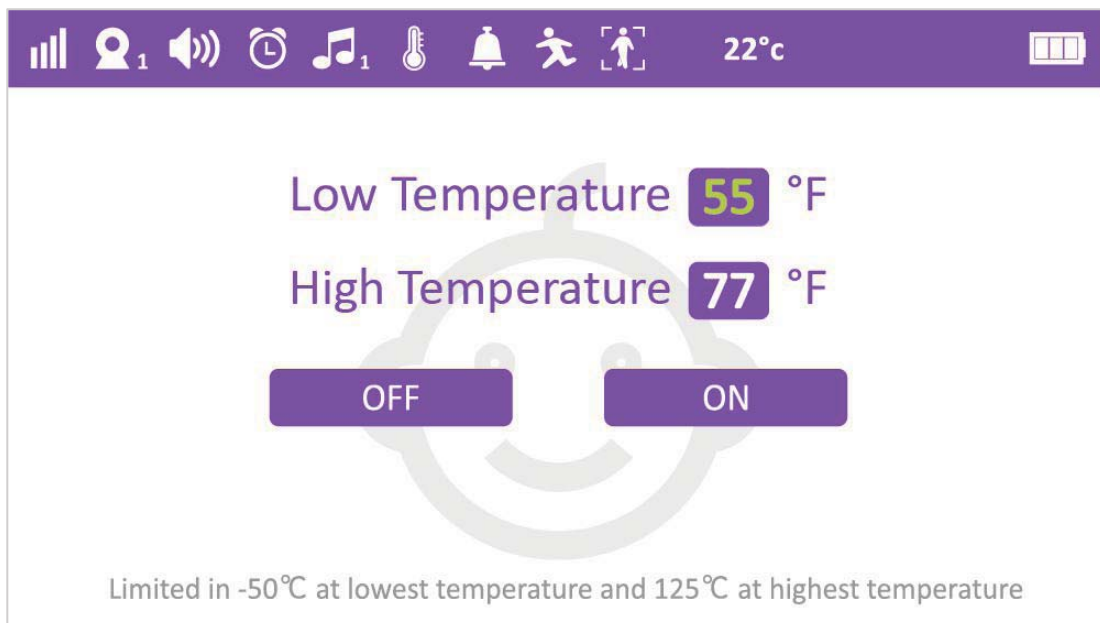
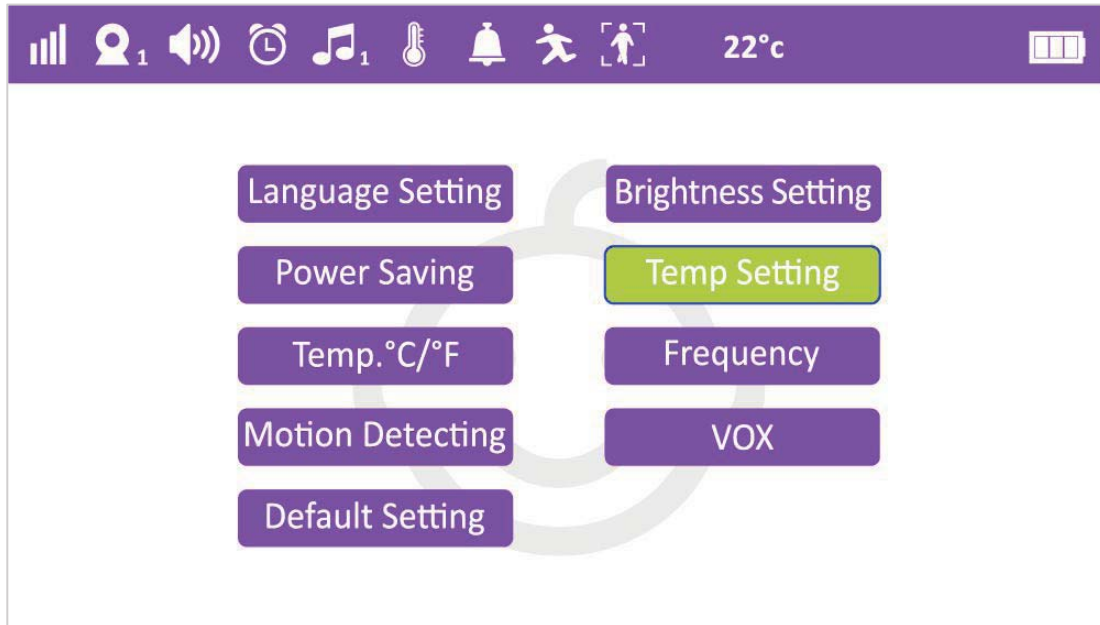

4.5 Temperature °C/ °F switch

User can switch °C & °F easily by this function.

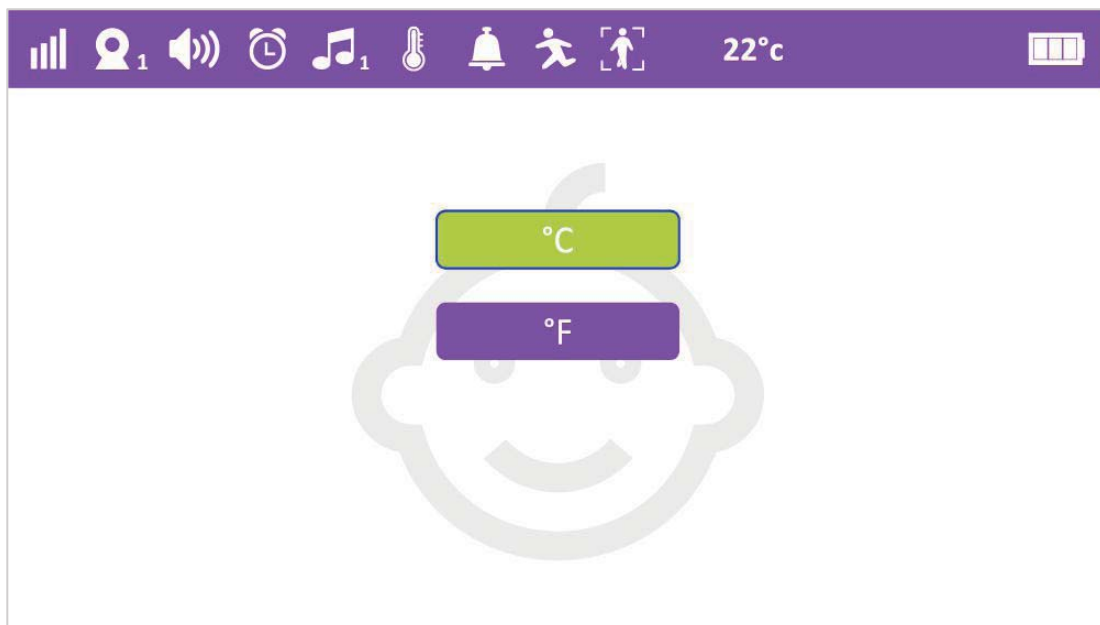
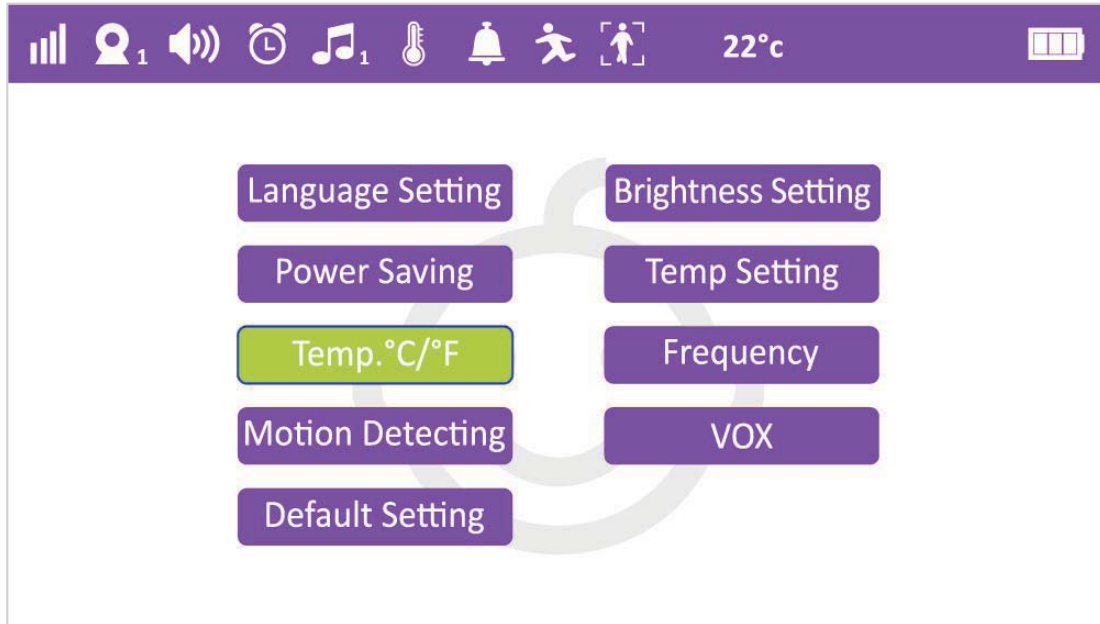

4.6 Frequency

User can switch 60Hz&50Hz easily by this function

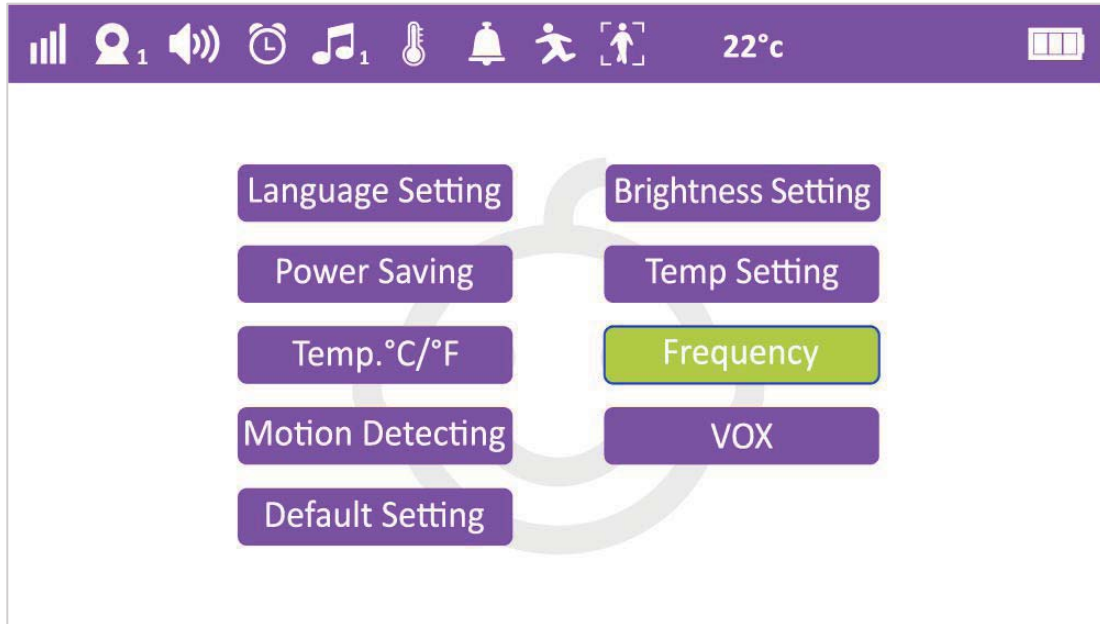

4.7 Motion Detecting

By this function selected to ON, user can hear alarm once any movement happened.

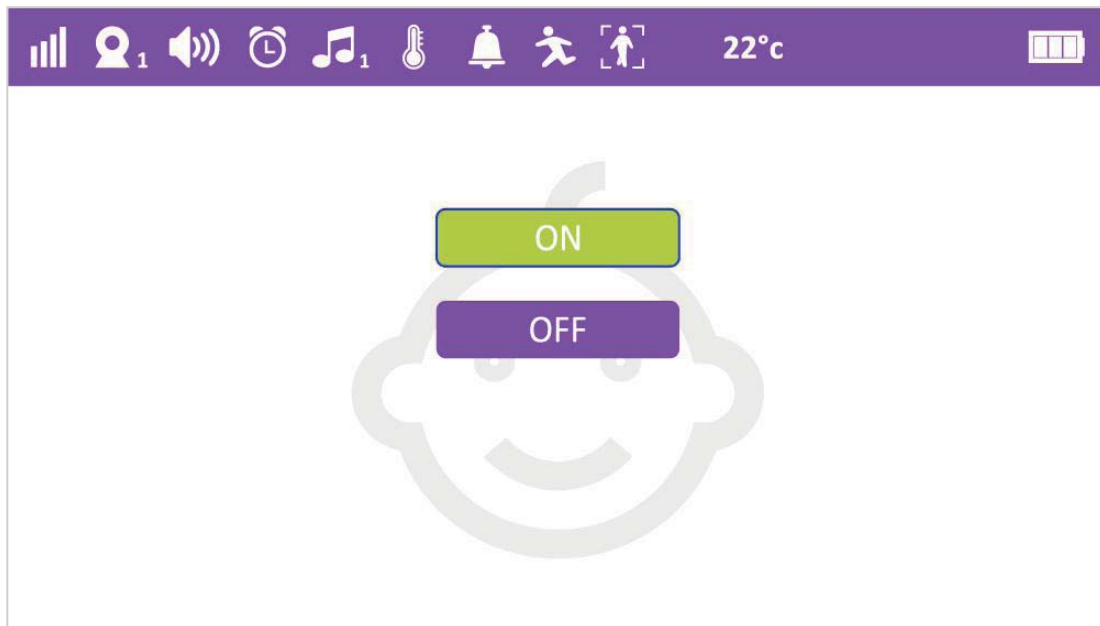
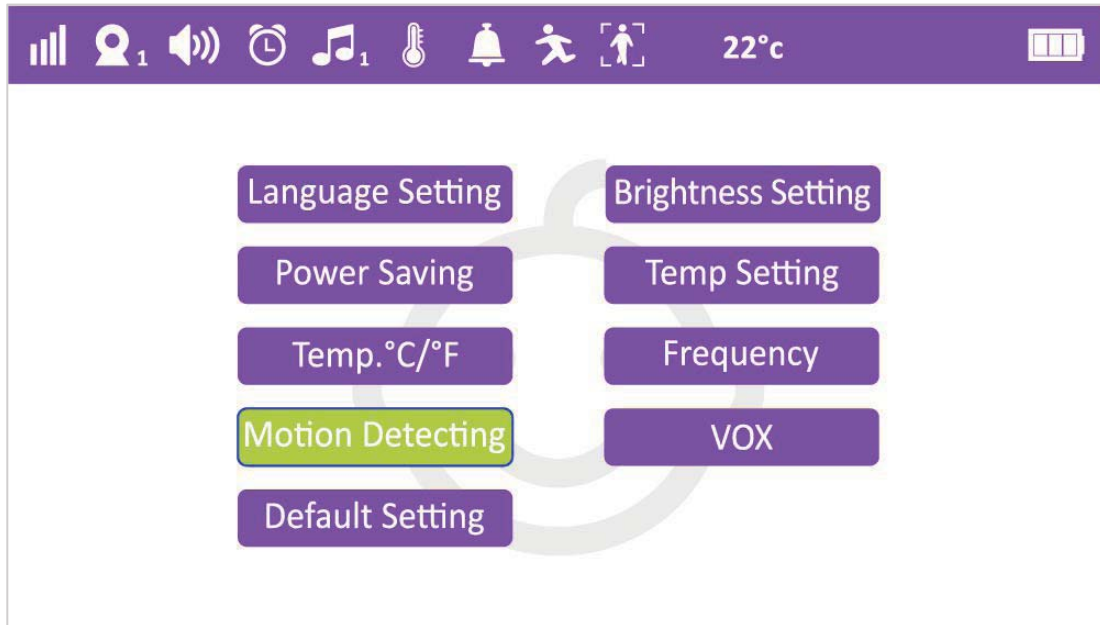

4.8 VOX

By this function selected to ON, user can hear alarm once any abnormal sound or noise happened.

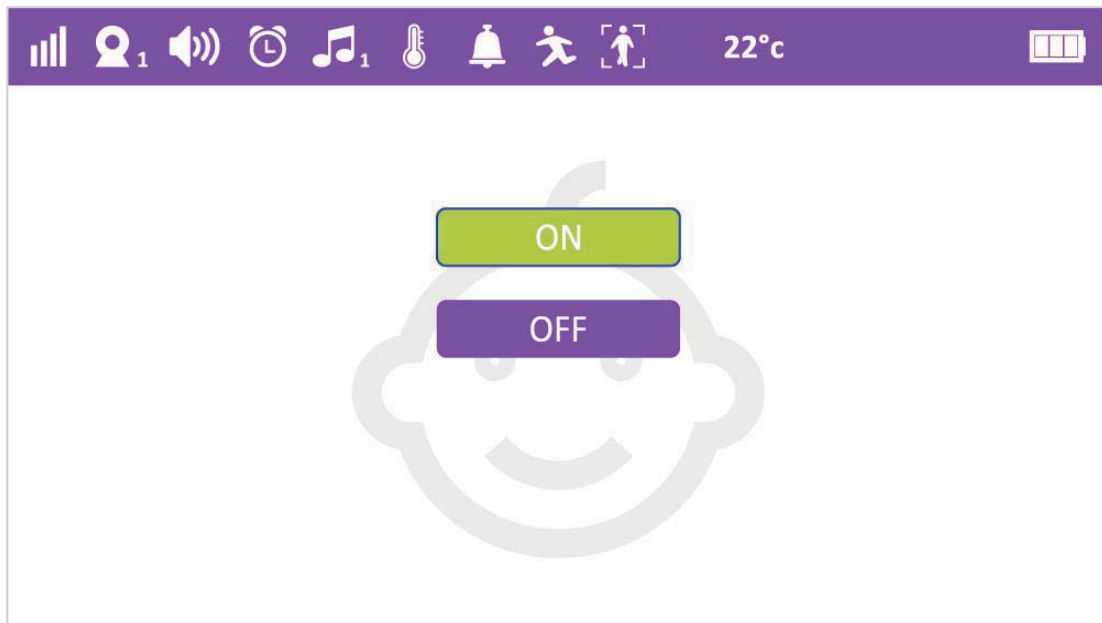
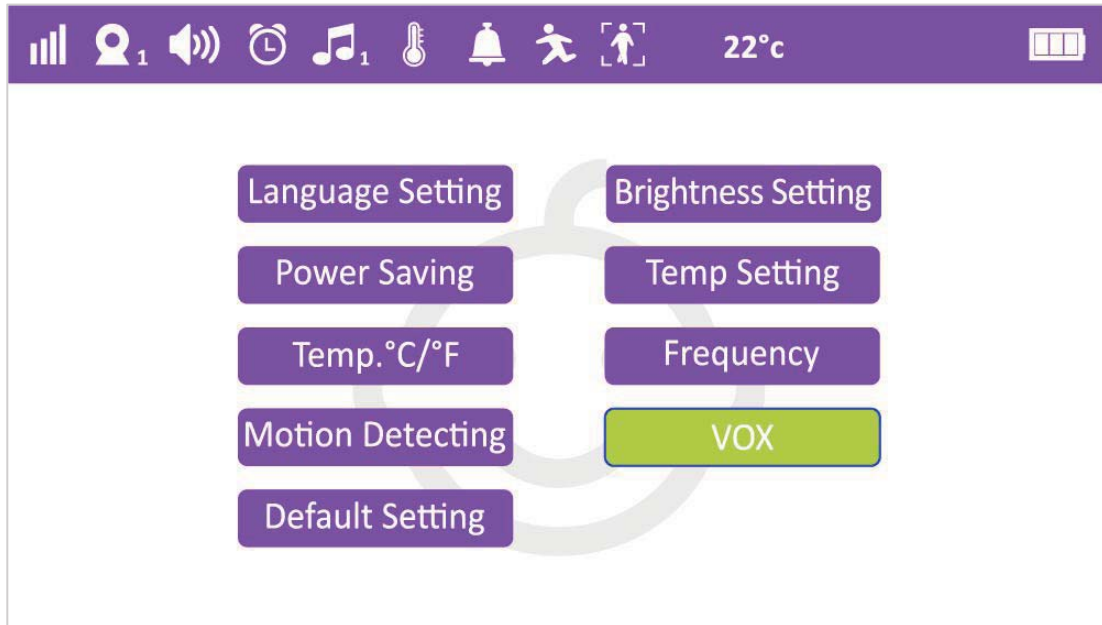

4.9 Default Setting

User can delete all cameras and settings history by selecting this function.

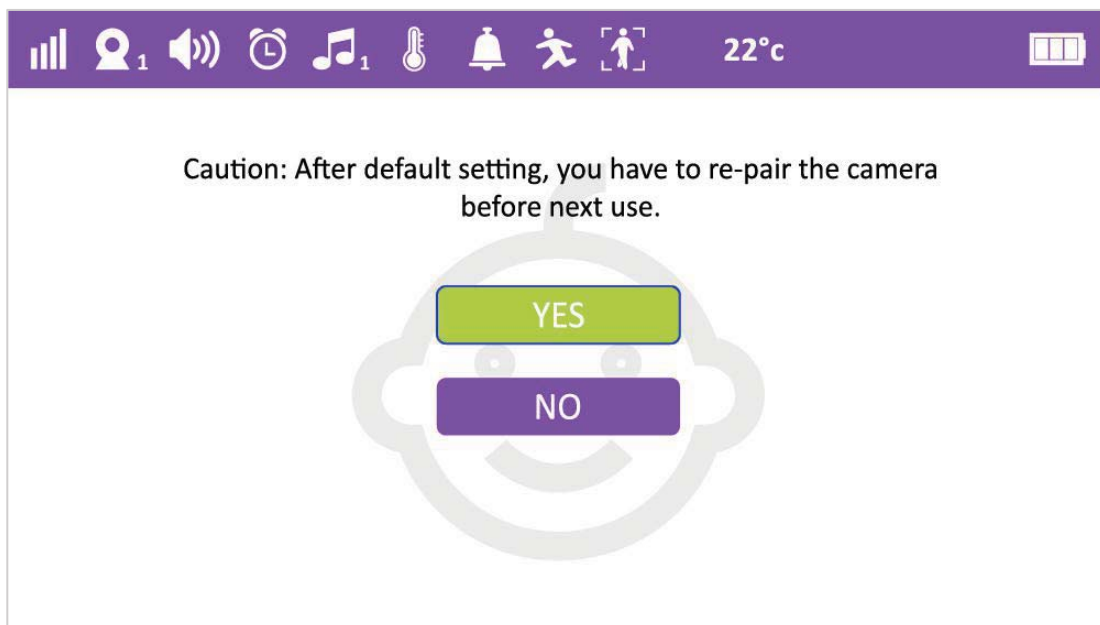
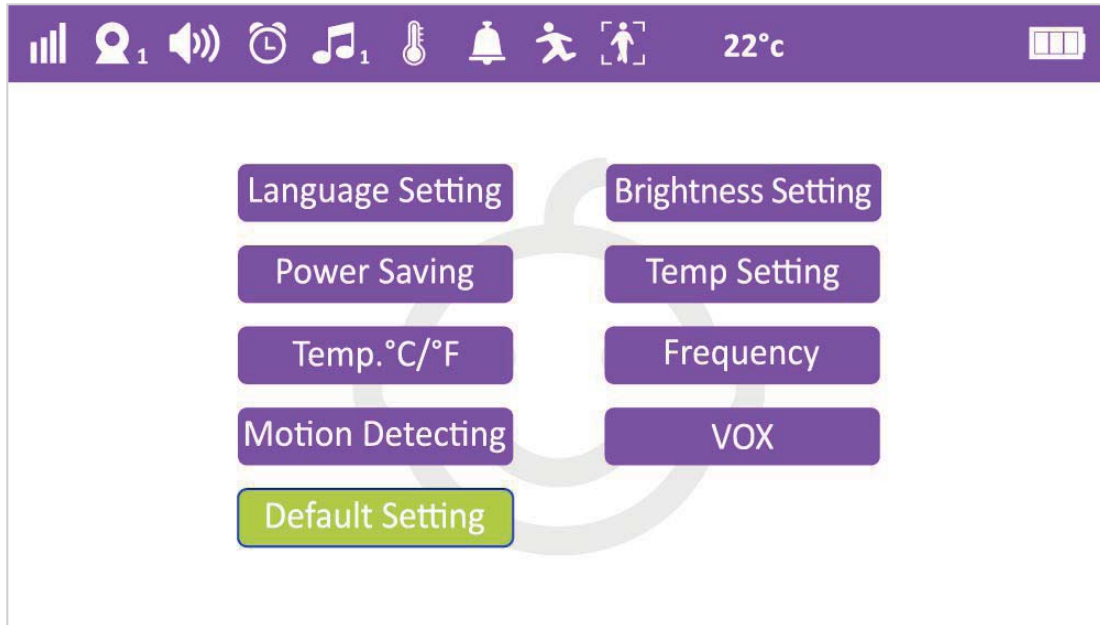

MADE IN CHINA