



FCC RADIO TEST REPORT

FCC ID:2AEHF-SMARTVOLT

Product: NOBUX™ SMART VOLT
Trade Name: NOBUX™
Model Number: SMART VOLT
Serial Model: N/A
Report No.: NTEK-2015NT10222902F6

Prepared for

NOBUX, LLC
8600 NW SOUTH RIVER DR #103 MIAMI, FLORIDA 33166,
United States

Prepared by

Shenzhen NTEK Testing Technology Co., Ltd.
1/F, Building E, Fenda Science Park, Sanwei Community, Xixiang Street
Bao'an District, Shenzhen P.R. China
Tel.: +86-0755-61156588 Fax.: +86-0755-61156599
Website: www.ntek.org.cn



TEST RESULT CERTIFICATION

Applicant's name: NOBUX, LLC
Address: 8600 NW SOUTH RIVER DR #103 MIAMI, FLORIDA 33166,
 United States
Manufacture's Name: NOBUX, LLC
Address: 8600 NW SOUTH RIVER DR #103 MIAMI, FLORIDA 33166,
 United States
Product name.....: NOBUX™ SMART VOLT
Model and/or type reference ...: SMART VOLT
Serial Model: N/A
Standards.....: FCC CFR 47 Part 27
Test procedure: TIA/EIA 603D

This device described above has been tested by NTEK, and the test results show that the equipment under test (EUT) is in compliance with the FCC requirements. And it is applicable only to the tested sample identified in the report.

This report shall not be reproduced except in full, without the written approval of NTEK, this document may be altered or revised by NTEK, personal only, and shall be noted in the revision of the document.

Date of Test.....
Date (s) of performance of tests 22 Oct. 2015 ~10 Nov. 2015
Date of Issue 10 Nov. 2015
Test Result **Pass**

Testing Engineer : Jason Chen
 (Jason Chen)
 Technical Manager : Brown Lu
 (Brown Lu)
 Authorized Signatory : Sam. Chen
 (Sam Chen)

TABLE OF CONTENTS

| | |
|---|-----------|
| 1. GENERAL INFORMATION..... | 4 |
| 1. GENERAL INFORMATION..... | 4 |
| 1.1 PRODUCT DESCRIPTION | 4 |
| 1.2 RELATED SUBMITTAL(S) / GRANT (S) | 5 |
| 1.3 TEST METHODOLOGY..... | 5 |
| 1.4 TEST FACILITY..... | 5 |
| 1.5 SPECIAL ACCESSORIES..... | 5 |
| 1.6 WORST-CASE CONFIGURATION AND MODE..... | 5 |
| 2. SYSTEM TEST CONFIGURATION | 5 |
| 2.1 EUT CONFIGURATION..... | 5 |
| 2.2 EUT EXERCISE | 6 |
| 2.3 CONFIGURATION OF EUT SYSTEM..... | 6 |
| 2.4 TEST SETUP | 7 |
| 3.TEST AND MEASUREMENT EQUIPMENT | 8 |
| 4. OUTPUT POWER..... | 9 |
| 4.1 OUTPUT POWER MEASUREMENT | 9 |
| 4.1.2 LTE BAND 7 | 11 |
| 5. OCCUPIED BANDWIDTH | 15 |
| 5.1.1. LTE BAND 7 | 17 |
| 6. BANDEDGE AND EMISSION MASK..... | 21 |
| 6.1.1. LTE BAND 7 | 22 |
| 7. OUT OF BAND EMISSIONS | 40 |
| 7.1 MEASUREMENT METHOD | 40 |



7.1.1 LTE BAND 7 41

9. RADIATED SPURIOUS EMISSION.....65

9.1. RADIATED POWER (ERP & EIRP) 65

9.1.1 LTE BAND 7 66

10.0 FIELD STRENGTH OF SPURIOUS RADIATION68

10.1.1. LTE BAND 7..... 70

11. FREQUENCY STABILITY.....74

11.1.1. LTE BAND 7 75

12. PEAK-TO-AVERAGE RATIO79

12.1.1 DESCRIPTION OF THE PAR MEASUREMENT 79

12.1.2 MEASURING INSTRUMENTS 79

12.1.3 TEST PROCEDURES..... 79

12.1.4 TEST SETUP..... 79

12.1.5. LTE BAND 7 81

APPENDIX IV85

1. GENERAL INFORMATION

1.1 PRODUCT DESCRIPTION

A major technical description of EUT is described as following:

| | |
|---|---|
| Product Designation: | NOBUX™ SMART VOLT |
| Hardware version: | -- |
| Software version: | -- |
| Frequency Range: | LTE Band 7 Uplink: 2500MHz-2570MHz, Downlink: 2620MHz-2690MHz |
| Type of Modulation: | QPSK/16QAM |
| Antenna: | FPCB Antenna |
| Antenna gain: | 1.0dBi |
| Power Supply: | DC 3.8V by battery or DC 5.0V supplied by adapter |
| Battery parameter: | DC 3.8V/2100mAh |
| Adapter Input: | AC 100-240V~, 50/60Hz, 150mA |
| Adapter Output: | DC 5.0V, 500mA |
| Extreme Vol. Limits: | DC3.6 V to 4.4 V (Nominal DC3.8 V) |
| Extreme Temp. Tolerance | -10°C to +50°C |
| <p>** Note: The High Voltage 4.4V and Low Voltage 3.6V was declared by manufacturer, The EUT couldn't be operate normally with higher or lower voltage.</p> | |

1.2 RELATED SUBMITTAL(S) / GRANT (S)

This submittal(s) (test report) is intended for **FCC ID: 2AEHF-SMART VOLT** filing to comply with the FCC Part 22H&24E &27.

1.3 TEST METHODOLOGY

The tests documented in this report were performed in accordance with TIA-603-C, FCC CFR 47 Part 2, Part 22, Part 24, Part 27.

1.4 TEST FACILITY

The test site used to collect the radiated data is located at:

NTEK Testing Technology Co., Ltd.

1/F, Building E, Fenda Science Park, Sanwei Community, Xixiang Street, Bao'an District, Shenzhen P.R. China.

The test site is constructed and calibrated to meet the FCC requirements in documents ANSI C63.4: 2003.

FCC Registration No.:238937

IC Registration No.:9270A-1,

CNAS Registration No.:L5516

1.5 SPECIAL ACCESSORIES

The battery and the charger, earphone supplied by the applicant were used as accessories and being tested with EUT intended for FCC grant together.

1.6 WORST-CASE CONFIGURATION AND MODE

The worst-case scenario for all measurements is based on the investigation results.

The device has LTE Bands of: Band 2, Band 4, Band 17,

The RB Size was selected to measure for peak or average ERP and EIRP, which was based on the conducted power verification baseline data.

For the fundamental investigation of radiated emissions, the EUT is investigated for vertical and horizontal antenna orientations and X Y and Z orientations of the EUT alone. After the investigations the worst case was determined to be at X orientation for all LTE bands.

2. SYSTEM TEST CONFIGURATION

2.1 EUT CONFIGURATION

The EUT configuration for testing is installed on RF field strength measurement to meet the Commission's requirement and operating in a manner which intends to maximize its emission characteristics in a continuous normal application.

2.2 EUT EXERCISE

The Transmitter was operated in the maximum output power mode through Communication Tester. The TX frequency was fixed which was for the purpose of the measurements.

2.3 CONFIGURATION OF EUT SYSTEM

Table 2-1 Equipment Used in EUT System

| Item | Equipment | Model No. | ID or Specification | Note |
|------|-------------------|------------|----------------------------|------|
| 1 | NOBUX™ SMART VOLT | SMART VOLT | FCC ID: 2AEHF-SMARTVOLT | EUT |
| | | | | |
| | | | | |

*Note: All the accessories have been used during the test.
the following "EUT" in setup diagram means EUT system.*

2.4 TEST SETUP

CONDUCTED SETUP DIAGRAM FOR TESTS

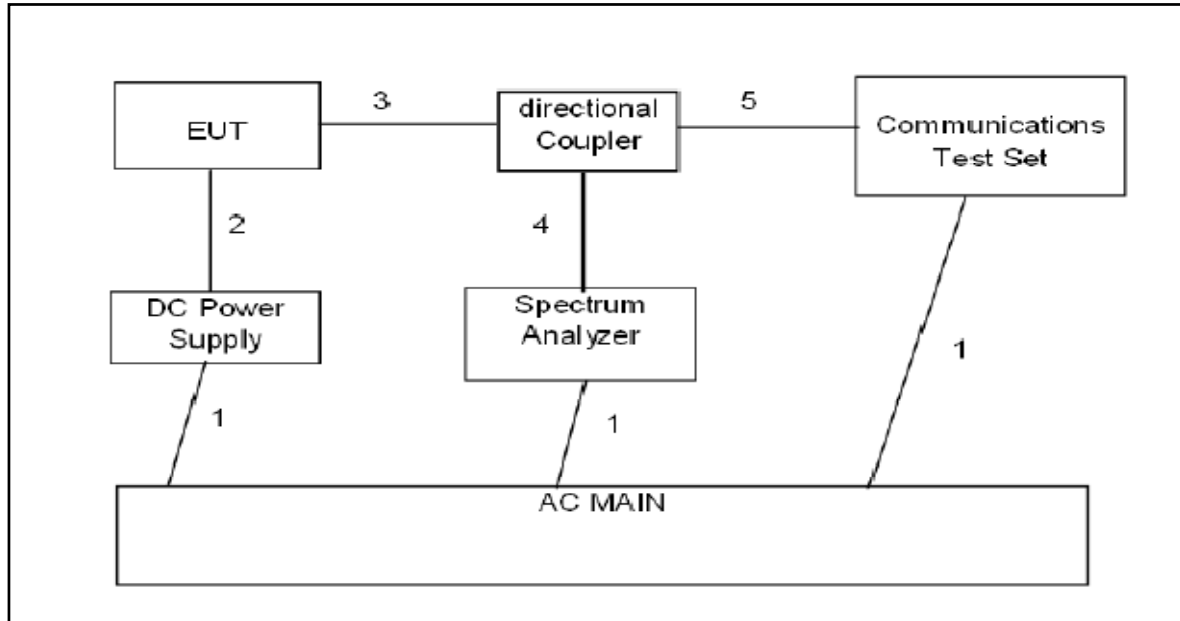

RADIATED SETUP DIAGRAM FOR TESTS

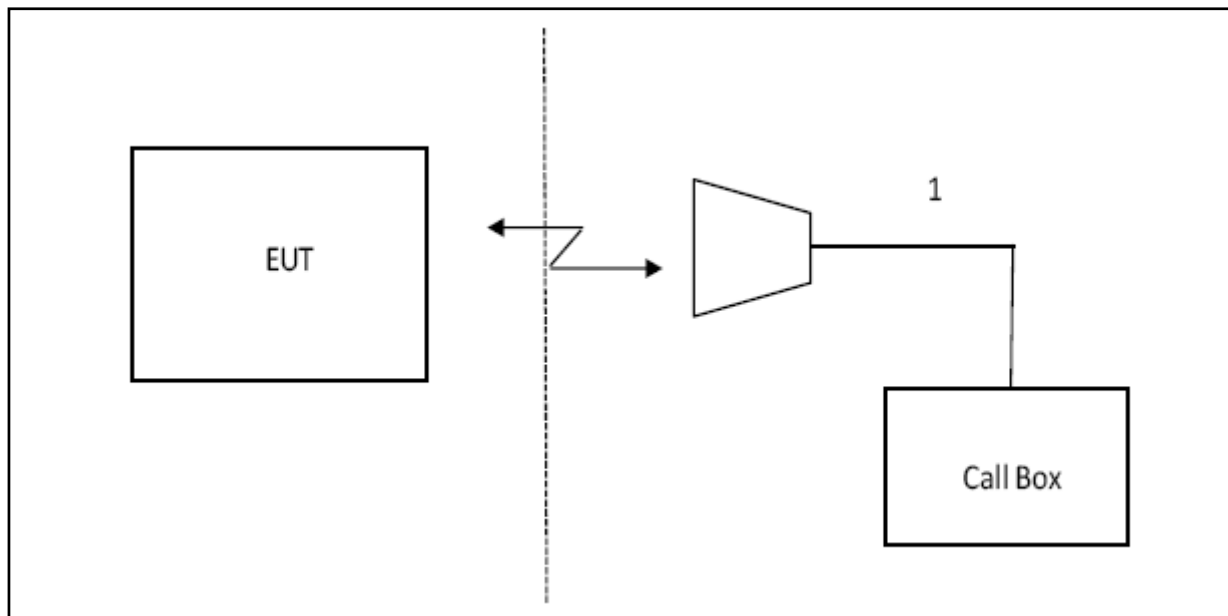

3. TEST AND MEASUREMENT EQUIPMENT

The following test and measurement equipment was utilized for the tests documented in this report:

| NAME OF EQUIPMENT | MANUFACTURER | MODEL | SERIAL NUMBER | NEXT CAL. DATE |
|----------------------|-------------------|-------------|---------------|----------------|
| SPECTRUM ANALYZER | AGILENT | E4440A | US44300399 | 2016.6.26 |
| TEST RECEIVER | R&S | ESCI | A0304218 | 2016.6.26 |
| COMMUNICATION TESTER | R&S | CMU200 | A0304247 | 2016.6.26 |
| COMMUNICATION TESTER | R&S | CMW500 | X | 2016.6.26 |
| TEST RECEIVER | R&S | FCKL1528 | A0304230 | 2016.6.26 |
| LISN | SCHWARZBECK | NSLK8127 | A0304233 | 2016.6.26 |
| CLIMATE CHAMBER | ALBATROSS | -- | -- | 2016.6.26 |
| Loop Antenna | Daze | ZN30900N | SEL0097 | 2016.6.26 |
| Biological Antenna | A.H. Systems Inc. | SAS-521-4 | N/A | 2016.6.26 |
| Horn Antenna | EM | EM-AH-10180 | N/A | 2016.6.26 |

4. OUTPUT POWER

4.1 OUTPUT POWER MEASUREMENT

LTE Measurement Procedure:

All LTE bands conducted power peak and average are obtained from the CMW500 telecommunication test set. The following tests were conducted according to the test requirements outlined in section 6.2 of the 3GPP TS36.101 specification.

UE Power Class: 3 (23 +/- 2dBm). The allowed Maximum Power Reduction (MPR) for the maximum output power due to higher order modulation and transmit bandwidth configuration (resource blocks) is specified in Table 6.2.3-1 of the 3GPP TS36.101.

Table 6.2.3-1: Maximum Power Reduction (MPR) for Power Class 3

| Modulation | Channel bandwidth / Transmission bandwidth (RB) | | | | | | MPR (dB) |
|------------|---|---------|-------|--------|--------|--------|----------|
| | 1.4 MHz | 3.0 MHz | 5 MHz | 10 MHz | 15 MHz | 20 MHz | |
| QPSK | > 5 | > 4 | > 8 | > 12 | > 16 | > 18 | ≤ 1 |
| 16 QAM | ≤ 5 | ≤ 4 | ≤ 8 | ≤ 12 | ≤ 16 | ≤ 18 | ≤ 1 |
| 16 QAM | > 5 | > 4 | > 8 | > 12 | > 16 | > 18 | ≤ 2 |

The allowed A-MPR values specified below in Table 6.2.4.-1 of 3GPP TS36.101 are in addition to the allowed MPR requirements. All the measurements below were performed with A-MPR disabled, by using Network Signaling Value of "NS_01".3

Table 6.2.4-1: Additional Maximum Power Reduction (A-MPR)

| Network Signalling value | Requirements (sub-clause) | E-UTRA Band | Channel bandwidth (MHz) | Resources Blocks (N_{RB}) | A-MPR (dB) |
|--------------------------|---------------------------|--------------------------|-------------------------|-------------------------------|---------------|
| NS_01 | 6.6.2.1.1 | Table 5.5-1 | 1.4, 3, 5, 10, 15, 20 | Table 5.6-1 | NA |
| NS_03 | 6.6.2.2.1 | 2, 4, 10, 23, 25, 35, 36 | 3 | >5 | ≤ 1 |
| | | | 5 | >6 | ≤ 1 |
| | | | 10 | >6 | ≤ 1 |
| | | | 15 | >8 | ≤ 1 |
| | | | 20 | >10 | ≤ 1 |
| NS_04 | 6.6.2.2.2 | 41 | 5 | >6 | ≤ 1 |
| | | | 10, 15, 20 | See Table 6.2.4-4 | |
| NS_05 | 6.6.3.3.1 | 1 | 10, 15, 20 | ≥ 50 | ≤ 1 |
| NS_06 | 6.6.2.2.3 | 12, 13, 14, 17 | 1.4, 3, 5, 10 | Table 5.6-1 | n/a |
| NS_07 | 6.6.2.2.3 | 13 | 10 | Table 6.2.4 2 | Table 6.2.4 2 |
| | 6.6.3.3.2 | | | | |
| NS_08 | 6.6.3.3.3 | 19 | 10, 15 | > 44 | ≤ 3 |
| NS_09 | 6.6.3.3.4 | 21 | 10, 15 | > 40 | ≤ 1 |
| | | | | > 55 | ≤ 2 |
| NS_10 | | 20 | 15, 20 | Table 6.2.4-3 | Table 6.2.4-3 |
| NS_11 | 6.6.2.2.1 | 23 ¹ | 1.4, 3, 5, 10 | Table 6.2.4-5 | Table 6.2.4-5 |
| .. | | | | | |
| NS_32 | - | - | - | - | - |

Note 1: Applies to the lower block of Band 23, i.e. a carrier placed in the 2000-2010 MHz region.

4.1.2 LTE BAND 7

OUTPUT POWER FOR LTE BAND 7 (5.0MHZ)

| Band | Band Width | Channel | Frequency (MHz) | Modulation | RB Configuration | | Peak Power(dBm) | Average Power(dBm) |
|--------|------------|---------|-----------------|------------|------------------|-----------|-----------------|--------------------|
| | | | | | RB Size | RB Offset | | |
| Band 7 | 5.0MHz | 20775 | 2502.5 | QPSK | 1 | Low | 25.14 | 22.07 |
| | | | | | 1 | Mid | 25.13 | 21.73 |
| | | | | | 1 | High | 25.23 | 22.15 |
| | | | | | 12 | Low | 25.68 | 20.64 |
| | | | | | 12 | High | 25.94 | 19.73 |
| | | | | | 25 | Low | 26.76 | 20.97 |
| | | | | 16QAM | 1 | Low | 24.42 | 20.90 |
| | | | | | 1 | Mid | 24.71 | 21.88 |
| | | | | | 1 | High | 24.91 | 21.95 |
| | | | | | 12 | Low | 25.33 | 22.42 |
| | | | | | 12 | High | 25.73 | 21.11 |
| | | | | | 25 | Low | 26.35 | 21.13 |
| | 5.0MHz | 21100 | 2535.0 | QPSK | 1 | Low | 26.06 | 22.80 |
| | | | | | 1 | Mid | 25.85 | 22.42 |
| | | | | | 1 | High | 25.60 | 22.44 |
| | | | | | 12 | Low | 26.71 | 21.74 |
| | | | | | 12 | High | 26.44 | 21.61 |
| | | | | | 25 | Low | 27.16 | 21.59 |
| | | | | 16QAM | 1 | Low | 25.97 | 21.61 |
| | | | | | 1 | Mid | 25.76 | 22.81 |
| | | | | | 1 | High | 25.48 | 22.20 |
| | | | | | 12 | Low | 26.55 | 22.21 |
| | | | | | 12 | High | 26.44 | 21.51 |
| | | | | | 25 | Low | 27.13 | 21.47 |
| | 5.0MHz | 21425 | 2567.5 | QPSK | 1 | Low | 25.73 | 22.79 |
| | | | | | 1 | Mid | 25.79 | 22.79 |
| | | | | | 1 | High | 25.83 | 22.82 |
| 12 | | | | | Low | 26.39 | 21.74 | |
| 12 | | | | | High | 26.34 | 21.71 | |
| 25 | | | | | Low | 27.00 | 21.75 | |
| 16QAM | | | | 1 | Low | 25.74 | 21.68 | |
| | | | | 1 | Mid | 25.78 | 22.78 | |
| | | | | 1 | High | 25.84 | 22.83 | |
| | | | | 12 | Low | 26.25 | 22.83 | |
| | | | | 12 | High | 26.43 | 21.76 | |
| | | | | 25 | Low | 27.37 | 21.81 | |

OUTPUT POWER FOR LTE BAND 7 (10.0MHZ)

| Band | Band Width | Channel | Frequency (MHz) | Modulation | RB Configuration | | Peak Power(dBm) | Average Power(dBm) |
|--------|------------|---------|-----------------|------------|------------------|-----------|-----------------|--------------------|
| | | | | | RB Size | RB Offset | | |
| Band 7 | 10.0 MHz | 20800 | 2505.0 | QPSK | 1 | Low | 24.17 | 21.10 |
| | | | | | 1 | Mid | 24.80 | 21.92 |
| | | | | | 1 | High | 25.56 | 22.48 |
| | | | | | 25 | Low | 25.20 | 20.75 |
| | | | | | 25 | High | 26.06 | 20.96 |
| | | | | | 50 | Low | 26.32 | 21.35 |
| | | | | 16QAM | 1 | Low | 23.94 | 21.32 |
| | | | | | 1 | Mid | 24.73 | 20.71 |
| | | | | | 1 | High | 25.48 | 21.74 |
| | | | | | 25 | Low | 25.13 | 22.46 |
| | | | | | 25 | High | 26.11 | 20.78 |
| | | | | | 50 | Low | 26.49 | 21.07 |
| | 10.0 MHz | 21100 | 2535.0 | QPSK | 1 | Low | 25.84 | 21.95 |
| | | | | | 1 | Mid | 25.55 | 21.45 |
| | | | | | 1 | High | 25.09 | 21.04 |
| | | | | | 25 | Low | 26.26 | 20.90 |
| | | | | | 25 | High | 25.98 | 20.77 |
| | | | | | 50 | Low | 26.63 | 20.62 |
| | | | | 16QAM | 1 | Low | 25.87 | 20.81 |
| | | | | | 1 | Mid | 25.54 | 21.98 |
| | | | | | 1 | High | 25.07 | 21.44 |
| | | | | | 25 | Low | 26.41 | 21.01 |
| | | | | | 25 | High | 26.09 | 20.90 |
| | | | | | 50 | Low | 26.85 | 20.54 |
| | 10.0 MHz | 21400 | 2565.0 | QPSK | 1 | Low | 25.43 | 22.75 |
| | | | | | 1 | Mid | 25.61 | 22.71 |
| | | | | | 1 | High | 25.63 | 22.83 |
| 25 | | | | | Low | 26.17 | 21.52 | |
| 25 | | | | | High | 26.30 | 21.49 | |
| 50 | | | | | Low | 26.80 | 21.74 | |
| 16QAM | | | | 1 | Low | 25.41 | 21.73 | |
| | | | | 1 | Mid | 25.59 | 22.86 | |
| | | | | 1 | High | 25.62 | 22.76 | |
| | | | | 25 | Low | 26.13 | 22.81 | |
| | | | | 25 | High | 26.35 | 21.68 | |
| | | | | 50 | Low | 26.87 | 21.76 | |

OUTPUT POWER FOR LTE BAND 7 (15.0MHZ)

| Band | Band Width | Channel | Frequency (MHz) | Modulation | RB Configuration | | Peak Power(dBm) | Average Power(dBm) |
|--------|------------|---------|-----------------|------------|------------------|-----------|-----------------|--------------------|
| | | | | | RB Size | RB Offset | | |
| Band 7 | 15.0 MHz | 20825 | 2507.5 | QPSK | 1 | Low | 24.00 | 21.00 |
| | | | | | 1 | Mid | 25.18 | 22.52 |
| | | | | | 1 | High | 25.79 | 22.51 |
| | | | | | 36 | Low | 25.35 | 21.17 |
| | | | | | 36 | High | 26.39 | 21.38 |
| | | | | | 75 | Low | 27.17 | 21.55 |
| | | | | 16QAM | 1 | Low | 23.82 | 21.55 |
| | | | | | 1 | Mid | 25.13 | 20.92 |
| | | | | | 1 | High | 25.82 | 22.54 |
| | | | | | 36 | Low | 25.33 | 22.53 |
| | | | | | 36 | High | 26.38 | 21.11 |
| | | | | | 75 | Low | 27.19 | 21.41 |
| | 15.0 MHz | 21100 | 2535.0 | QPSK | 1 | Low | 25.92 | 22.55 |
| | | | | | 1 | Mid | 25.43 | 21.40 |
| | | | | | 1 | High | 24.62 | 21.17 |
| | | | | | 36 | Low | 26.46 | 21.20 |
| | | | | | 36 | High | 25.76 | 20.88 |
| | | | | | 75 | Low | 27.12 | 20.64 |
| | | | | 16QAM | 1 | Low | 25.97 | 21.01 |
| | | | | | 1 | Mid | 25.39 | 22.54 |
| | | | | | 1 | High | 24.58 | 21.38 |
| | | | | | 36 | Low | 26.43 | 21.15 |
| | | | | | 36 | High | 25.73 | 21.17 |
| | | | | | 75 | Low | 27.06 | 20.88 |
| | 15.0 MHz | 21375 | 2562.5 | QPSK | 1 | Low | 25.17 | 22.45 |
| | | | | | 1 | Mid | 25.47 | 22.84 |
| | | | | | 1 | High | 25.61 | 22.86 |
| 36 | | | | | Low | 26.05 | 21.82 | |
| 36 | | | | | High | 26.28 | 21.79 | |
| 75 | | | | | Low | 27.23 | 21.89 | |
| 16QAM | | | | 1 | Low | 25.17 | 21.88 | |
| | | | | 1 | Mid | 25.49 | 22.46 | |
| | | | | 1 | High | 25.64 | 22.84 | |
| | | | | 36 | Low | 26.03 | 22.87 | |
| | | | | 36 | High | 26.25 | 21.82 | |
| | | | | 75 | Low | 27.21 | 21.46 | |

OUTPUT POWER FOR LTE BAND 7 (20.0MHZ)

| Band | Band Width | Channel | Frequency (MHz) | Modulation | RB Configuration | | Peak Power(dBm) | Average Power(dBm) |
|--------|------------|---------|-----------------|------------|------------------|-----------|-----------------|--------------------|
| | | | | | RB Size | RB Offset | | |
| Band 7 | 20.0 MHz | 20850 | 2510.0 | QPSK | 1 | Low | 24.07 | 21.11 |
| | | | | | 1 | Mid | 25.61 | 22.50 |
| | | | | | 1 | High | 26.00 | 22.63 |
| | | | | | 50 | Low | 25.57 | 21.38 |
| | | | | | 50 | High | 26.55 | 21.17 |
| | | | | | 100 | Low | 26.93 | 21.49 |
| | | | | 16QAM | 1 | Low | 23.92 | 21.45 |
| | | | | | 1 | Mid | 25.59 | 20.91 |
| | | | | | 1 | High | 25.98 | 22.51 |
| | | | | | 50 | Low | 25.54 | 22.64 |
| | 50 | High | 26.56 | 21.37 | | | | |
| | 100 | Low | 26.97 | 21.19 | | | | |
| | 20.0 MHz | 21100 | 2535.0 | QPSK | 1 | Low | 26.07 | 22.93 |
| | | | | | 1 | Mid | 25.38 | 21.40 |
| | | | | | 1 | High | 24.52 | 21.17 |
| | | | | | 50 | Low | 26.56 | 21.93 |
| | | | | | 50 | High | 25.69 | 20.83 |
| | | | | | 100 | Low | 27.05 | 20.58 |
| | | | | 16QAM | 1 | Low | 26.04 | 21.97 |
| | | | | | 1 | Mid | 25.37 | 22.80 |
| | | | | | 1 | High | 24.56 | 21.40 |
| | | | | | 50 | Low | 26.54 | 21.18 |
| | 50 | High | 25.67 | 21.28 | | | | |
| | 100 | Low | 26.92 | 20.89 | | | | |
| | 20.0 MHz | 21350 | 2560.0 | QPSK | 1 | Low | 24.63 | 21.56 |
| | | | | | 1 | Mid | 25.30 | 22.74 |
| | | | | | 1 | High | 25.56 | 22.80 |
| 50 | | | | | Low | 25.77 | 21.62 | |
| 50 | | | | | High | 26.19 | 21.30 | |
| 100 | | | | | Low | 26.95 | 21.72 | |
| 16QAM | | | | 1 | Low | 24.60 | 21.91 | |
| | | | | 1 | Mid | 25.35 | 21.53 | |
| | | | | 1 | High | 25.64 | 22.75 | |
| | | | | 50 | Low | 25.75 | 22.84 | |
| 50 | High | 26.20 | 21.63 | | | | | |
| 100 | Low | 27.00 | 21.39 | | | | | |



5. OCCUPIED BANDWIDTH

RULE PART(S)

FCC: §2.1049

LIMITS

For reporting purposes only

TEST PROCEDURE

The transmitter output was connected to a calibrated coaxial cable and coupler, the other end of which was connected to a spectrum analyzer. The occupied bandwidth was measured with the spectrum analyzer at the low, middle and high channel in each band. The -26dB bandwidth was also measured and recorded.

MODES TESTED

LTE Band 7

RESULTS

Test results:

| Band | Mode | RB Size/RB Offset | Frequency (MHz) | 99% Occupied Bandwidth (MHz) | -26dBc Occupied Bandwidth (MHz) |
|---------------|--------------------|-------------------|-----------------|------------------------------|---------------------------------|
| LTE Band 7 | 5.0MHz BAND QPSK | 25/0 | 21100 | 4.52 | 5.02 |
| | 5.0MHz BAND 16QAM | 25/0 | 21100 | 4.52 | 4.99 |
| | 10.0MHz BAND QPSK | 50/0 | 21100 | 9.02 | 10.03 |
| | 10.0MHz BAND 16QAM | 50/0 | 21100 | 9.08 | 9.98 |
| | 15.0MHz BAND QPSK | 75/0 | 21100 | 13.51 | 14.70 |
| | 15.0MHz BAND 16QAM | 75/0 | 21100 | 13.44 | 14.76 |
| | 20.0MHz BAND QPSK | 100/0 | 21100 | 18.42 | 20.43 |
| | 20.0MHz BAND 16QAM | 100/0 | 21100 | 18.38 | 20.26 |

Note: This test was only measured at maximum RB allocation and at CENTER of band for each LTE BW

5.1.1. LTE BAND 7

Band 7,UL Channel 21100,UL Frequency 2535.0,BW 5.0,NO. RB 25,RB POS. Low,QPSK

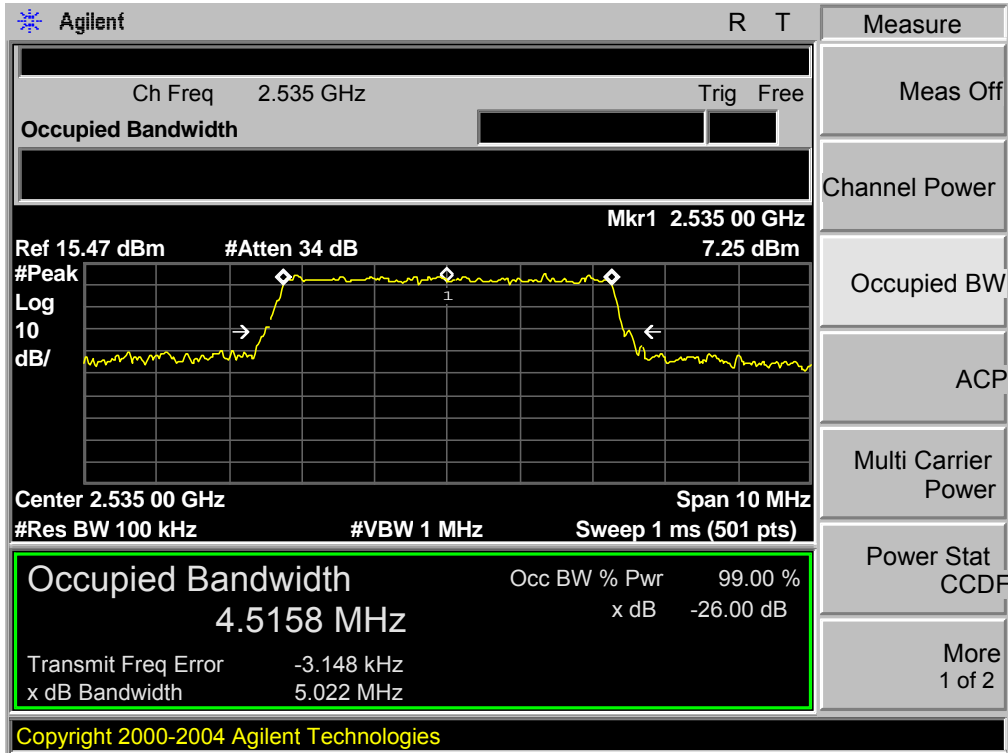

Band 7,UL Channel 21100,UL Frequency 2535.0,BW 5.0,NO. RB 25,RB POS. Low,16QAM

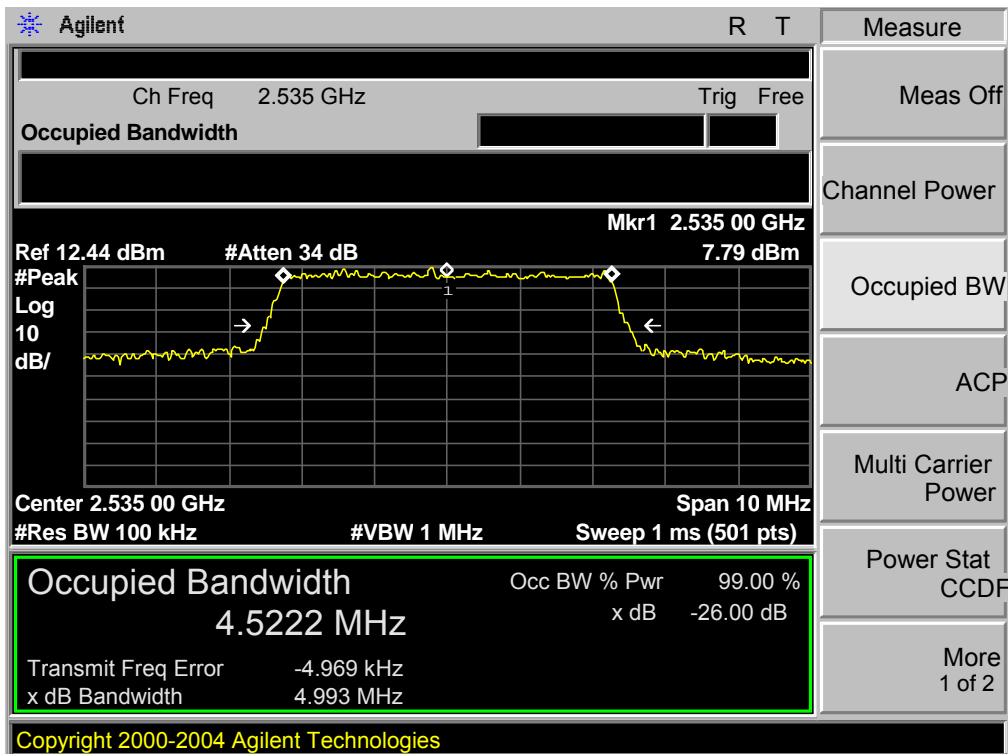

Band 7,UL Channel 21100,UL Frequency 2535.0,BW 10.0,NO. RB 50,RB POS. Low,QPSK

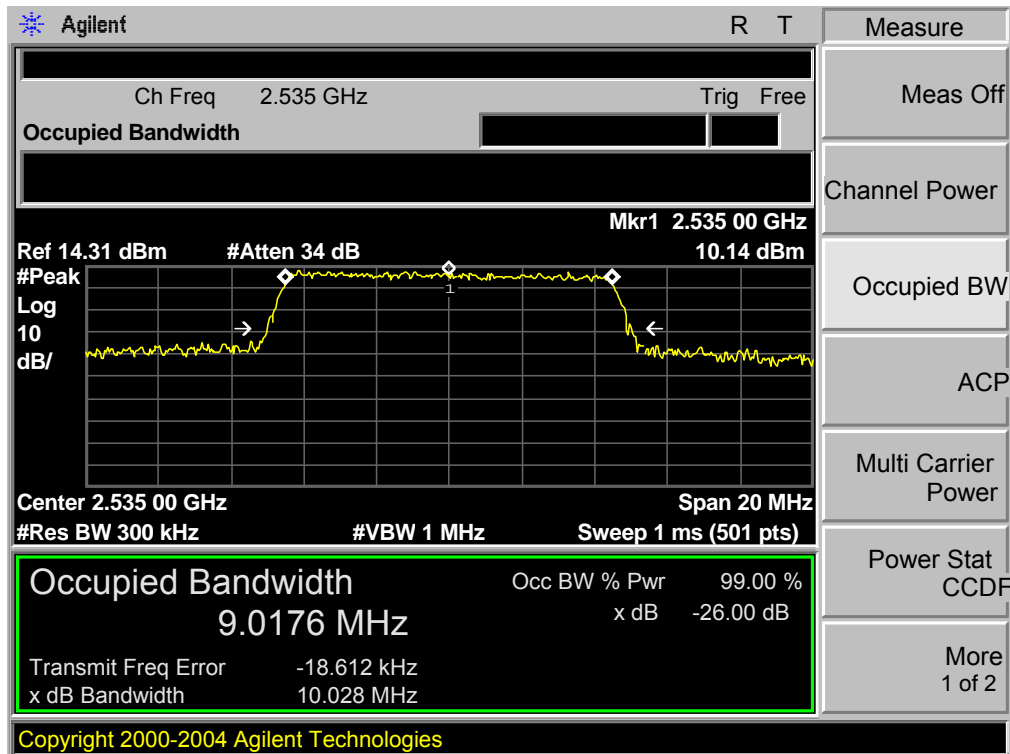

Band 7,UL Channel 21100,UL Frequency 2535.0,BW 10.0,NO. RB 50,RB POS. Low,16QAM

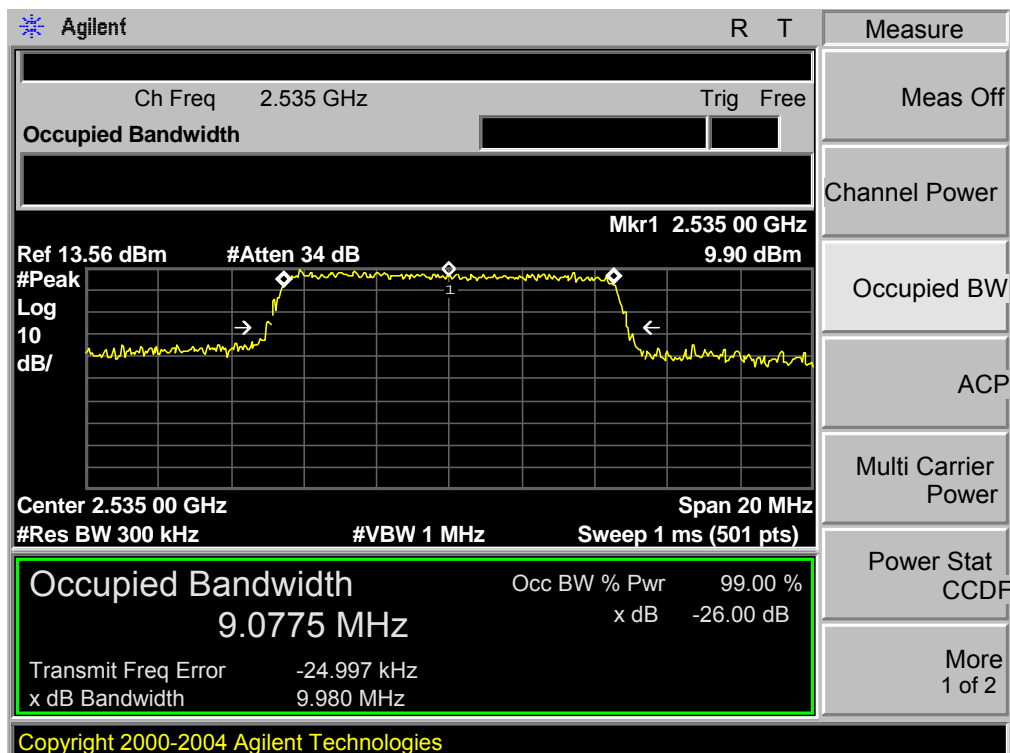

Band 7,UL Channel 21100,UL Frequency 2535.0,BW 15.0,NO. RB 75,RB POS. Low,QPSK

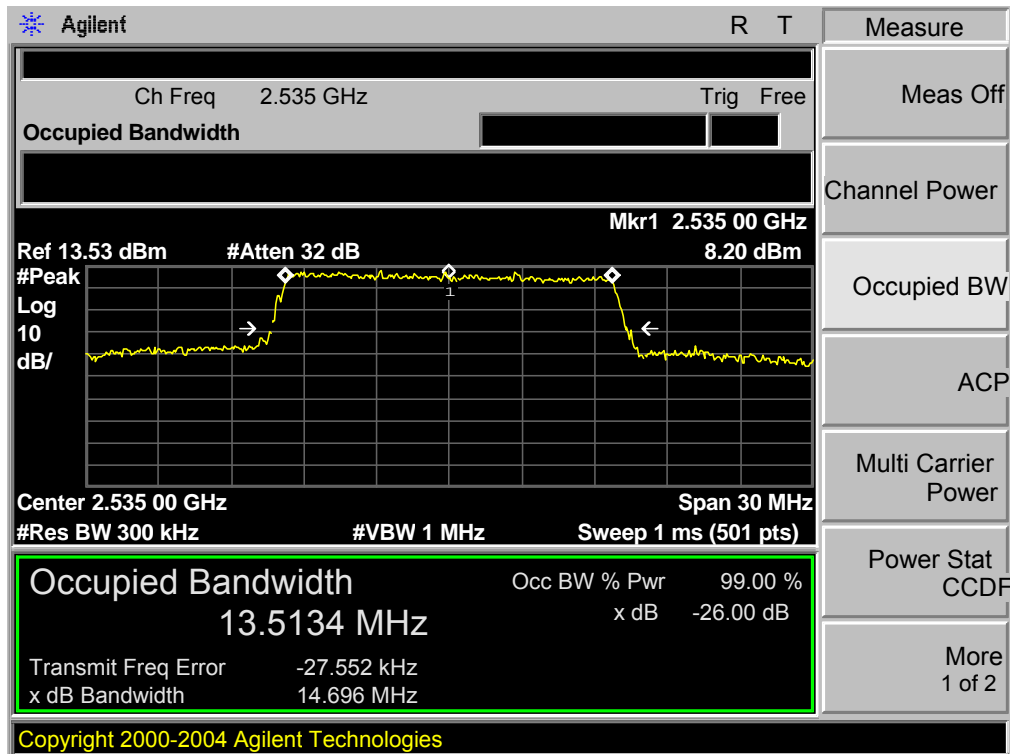

Band 7,UL Channel 21100,UL Frequency 2535.0,BW 15.0,NO. RB 75,RB POS. Low,16QAM

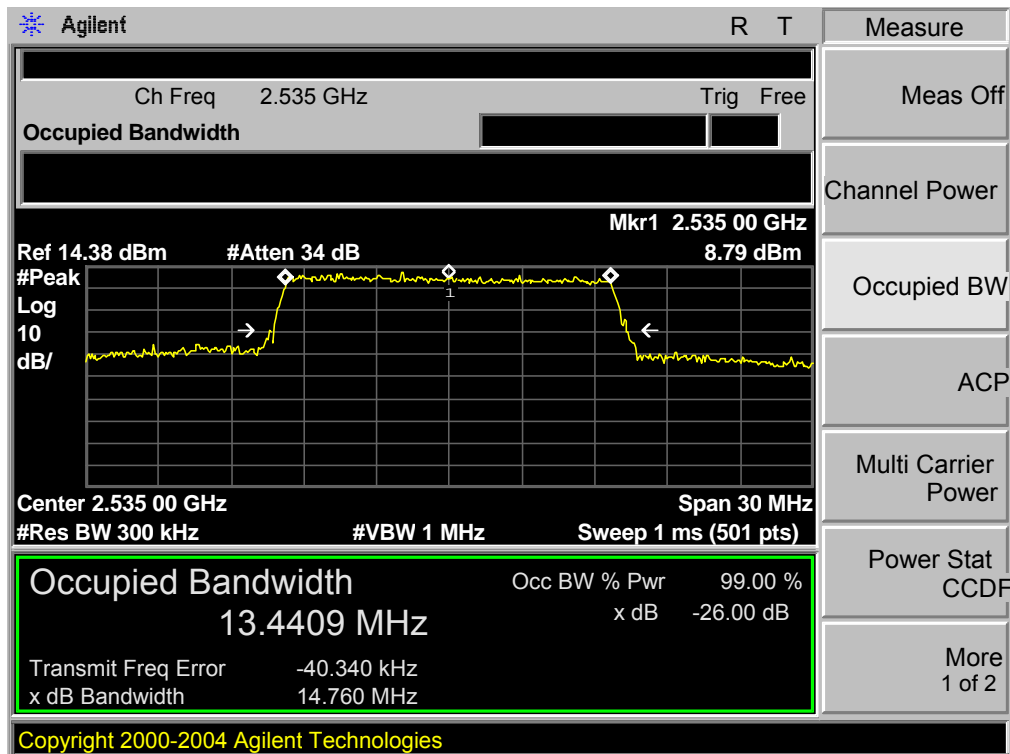

Band 7,UL Channel 21100,UL Frequency 2535.0,BW 20.0,NO. RB 100,RB POS. Low,QPSK

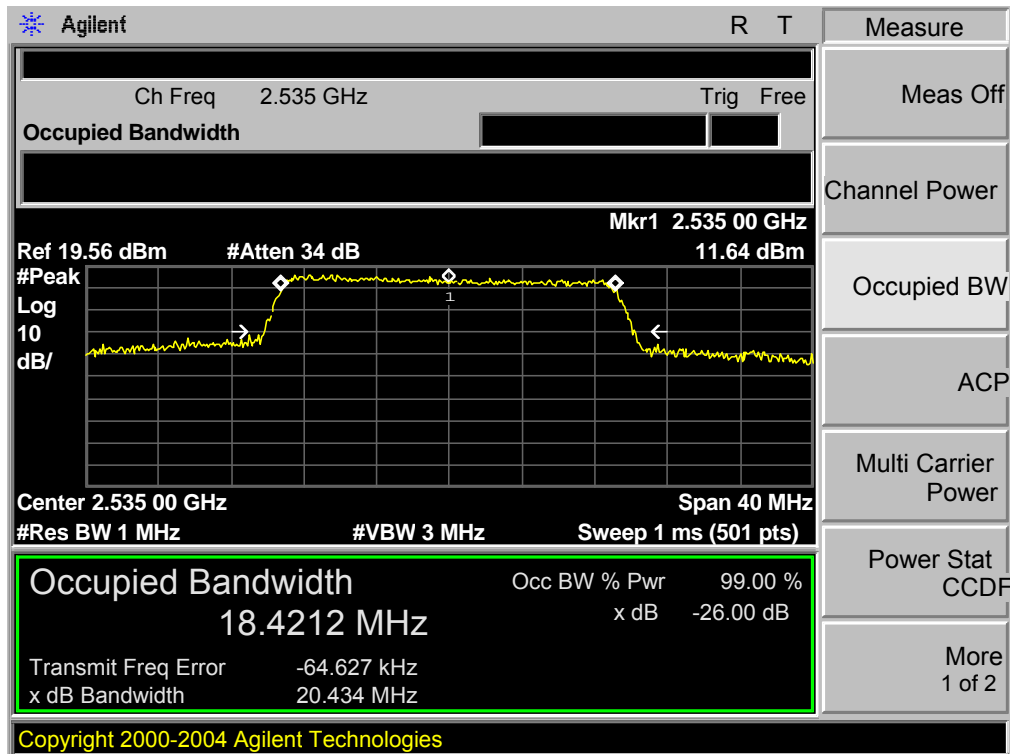

Band 7,UL Channel 21100,UL Frequency 2535.0,BW 20.0,NO. RB 100,RB POS. Low,16QAM

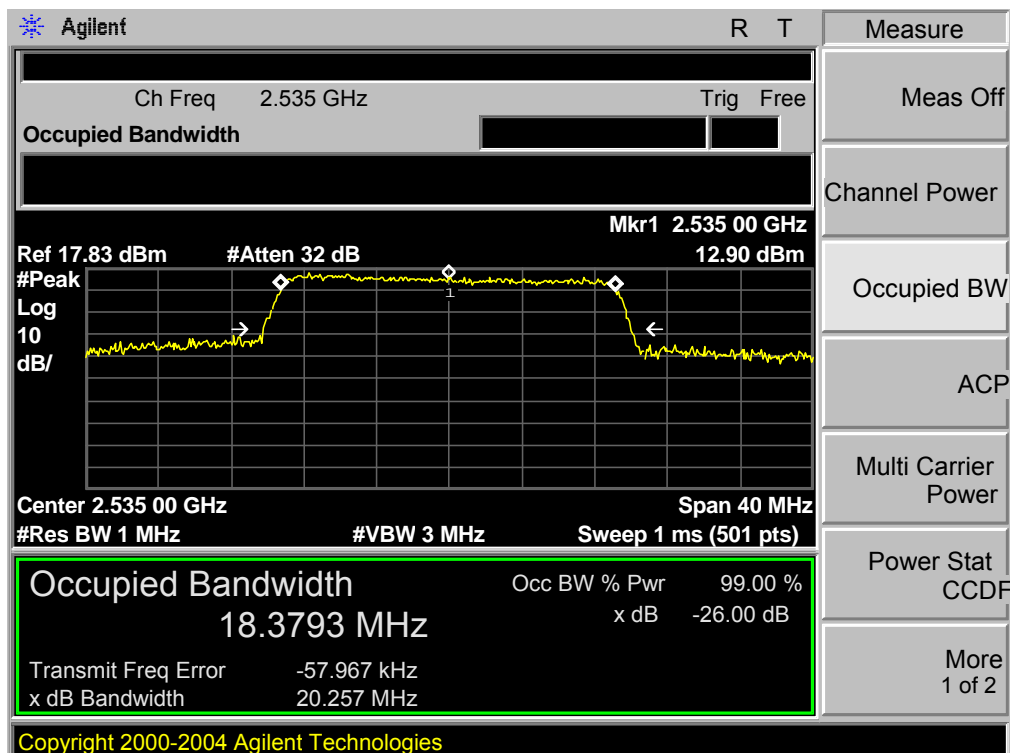

6. BANDEDGE AND EMISSION MASK

RULE PART(S)

FCC: §2.1051, §27.53,

LIMITS

FCC: §22.359, §24.238,

The power of any emission outside of the authorized operating frequency ranges must be attenuated below the transmitting power (P) by a factor of at least $43 + 10 \log (P)$ dB.

(m)(4) For mobile digital stations, the attenuation factor shall be not less than $40 + 10 \log (P)$ dB on all frequencies between the channel edge and 5 megahertz from the channel edge, $43 + 10 \log (P)$ dB on all frequencies between 5 megahertz and X megahertz from the channel edge, and $55 + 10 \log (P)$ dB on all frequencies more than X megahertz from the channel edge, where X is the greater of 6 megahertz or the actual emission bandwidth as defined in paragraph (m)(6) of this section. In addition, the attenuation factor shall not be less than $43 + 10 \log (P)$ dB on all frequencies between 2490.5 MHz and 2496 MHz and $55 + 10 \log (P)$ dB at or below 2490.5 MHz. Mobile Satellite Service licensees operating on frequencies below 2495 MHz may also submit a documented interference complaint against BRS licensees operating on channel BRS Channel 1 on the same terms and conditions as adjacent channel BRS or EBS licensees. Show citation box.

TEST PROCEDURE

The transmitter output was connected to a CMW500 Test Set and configured to operate at maximum power. The band edge emissions were measured at the required operating frequencies in each band on the Spectrum Analyzer.

For each band edge measurement:

Set the spectrum analyzer span to include the block edge frequency (704, 716, 824, 849, 1710 and 1755, 1850 and 1910 MHz)

Set a marker to point the corresponding band edge frequency in each test case.

Set display line at -13 dBm

Set resolution bandwidth to at least 1% of emission bandwidth.

MODES TESTED

LTE Band 7

RESULTS

6.1.1. LTE BAND 7

Band 7,UL Channel 20775,UL Frequency 2502.5,BW 5.0,NO. RB 25,RB POS. Low,QPSK

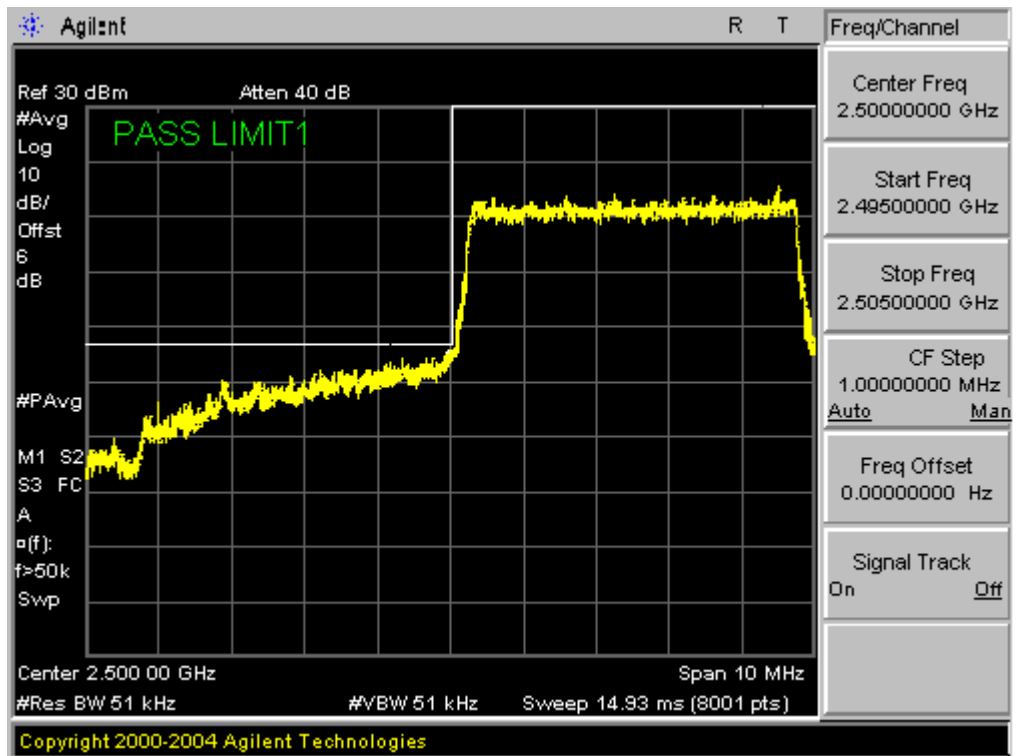

Band 7,UL Channel 20775,UL Frequency 2502.5,BW 5.0,NO. RB 25,RB POS. Low,QPSK

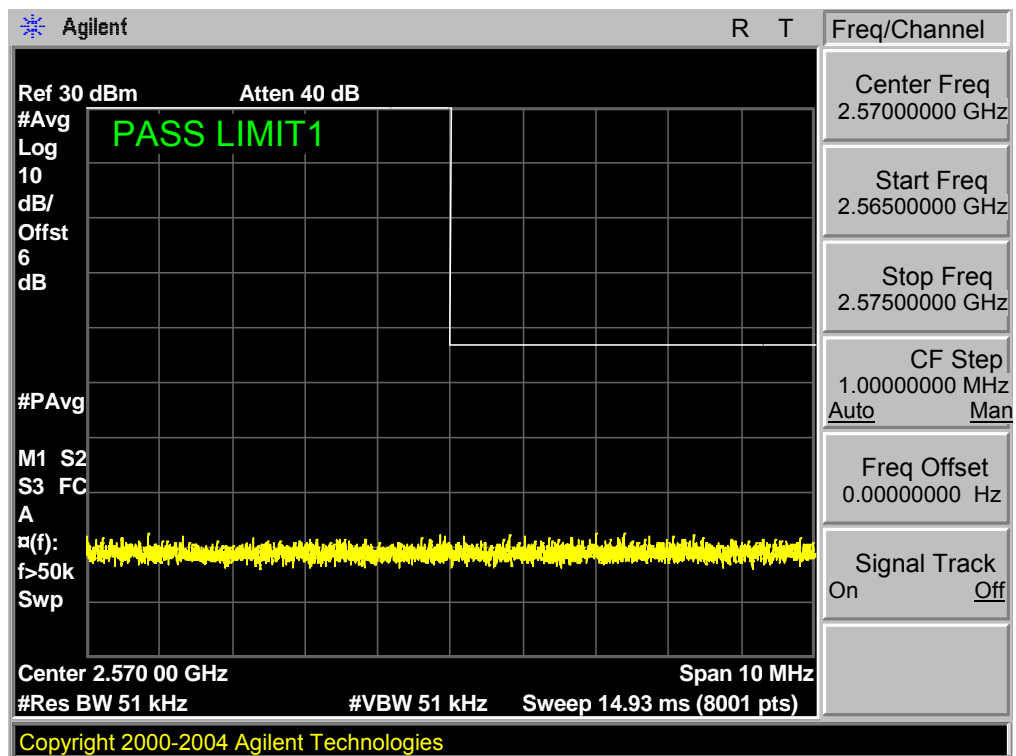

Band 7,UL Channel 20775,UL Frequency 2502.5,BW 5.0,NO. RB 25,RB POS. Low,16QAM

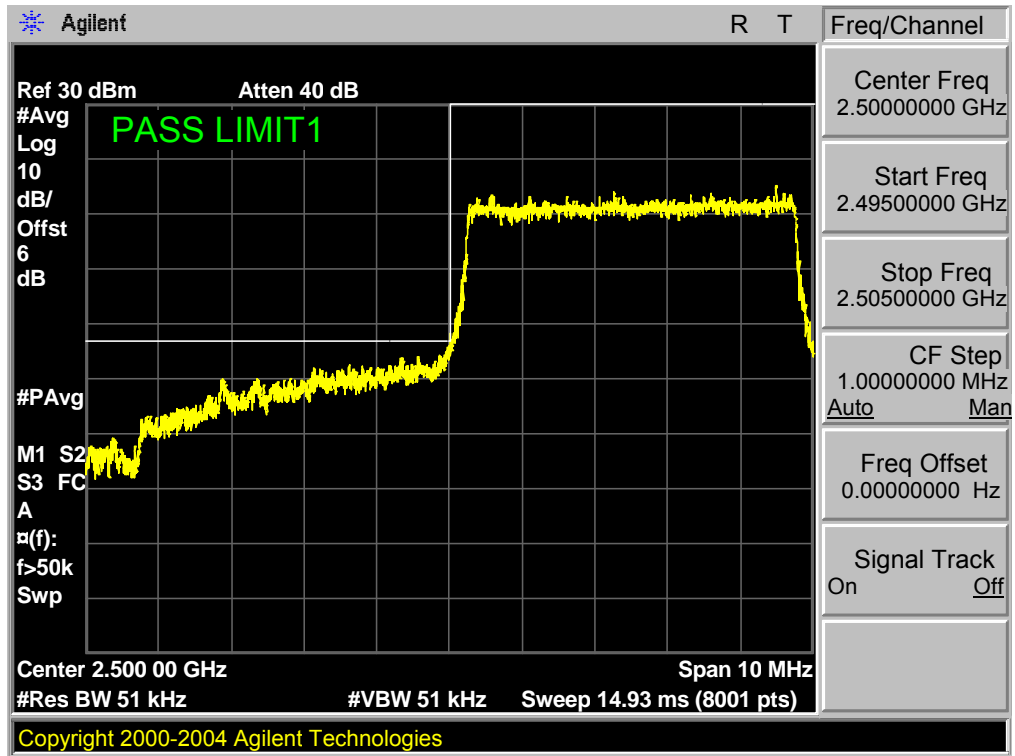

Band 7,UL Channel 20775,UL Frequency 2502.5,BW 5.0,NO. RB 25,RB POS. Low,16QAM

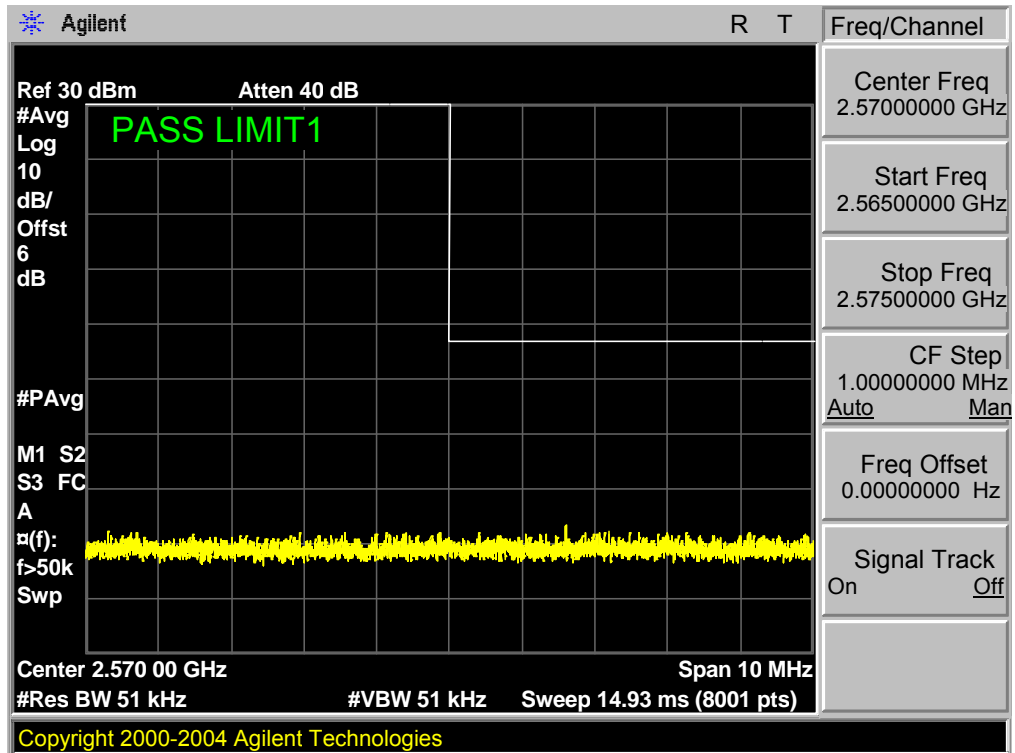

Band 7,UL Channel 21425,UL Frequency 2567.5,BW 5.0,NO. RB 25,RB POS. Low,QPSK

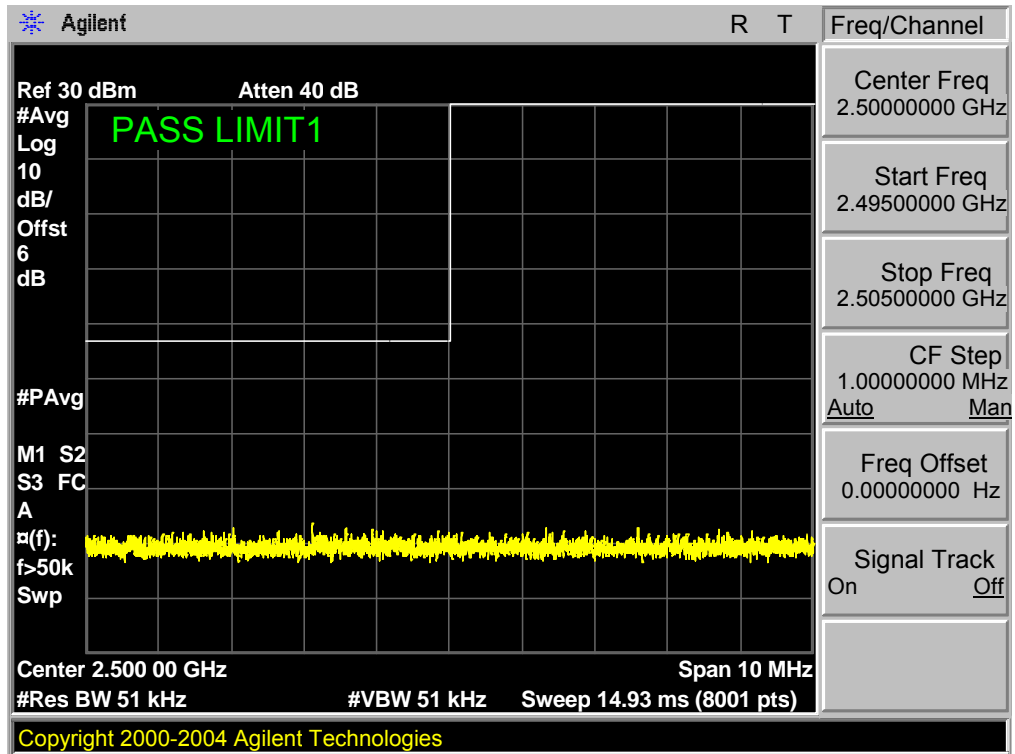

Band 7,UL Channel 21425,UL Frequency 2567.5,BW 5.0,NO. RB 25,RB POS. Low,QPSK

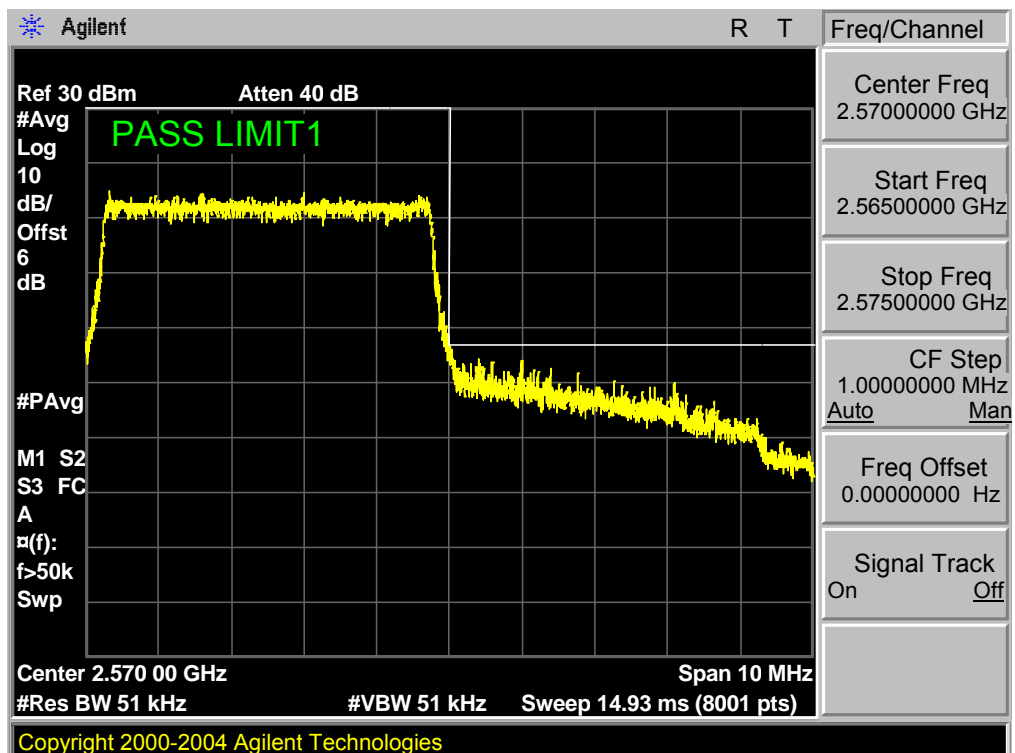

Band 7,UL Channel 21425,UL Frequency 2567.5,BW 5.0,NO. RB 25,RB POS. Low,16QAM

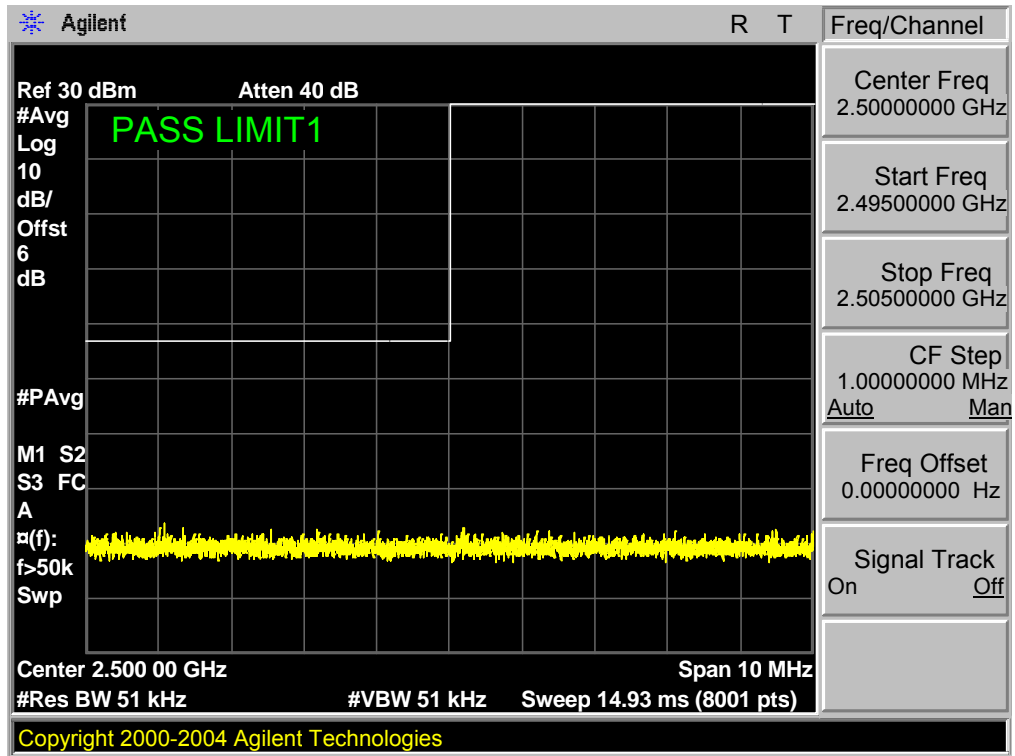

Band 7,UL Channel 21425,UL Frequency 2567.5,BW 5.0,NO. RB 25,RB POS. Low,16QAM

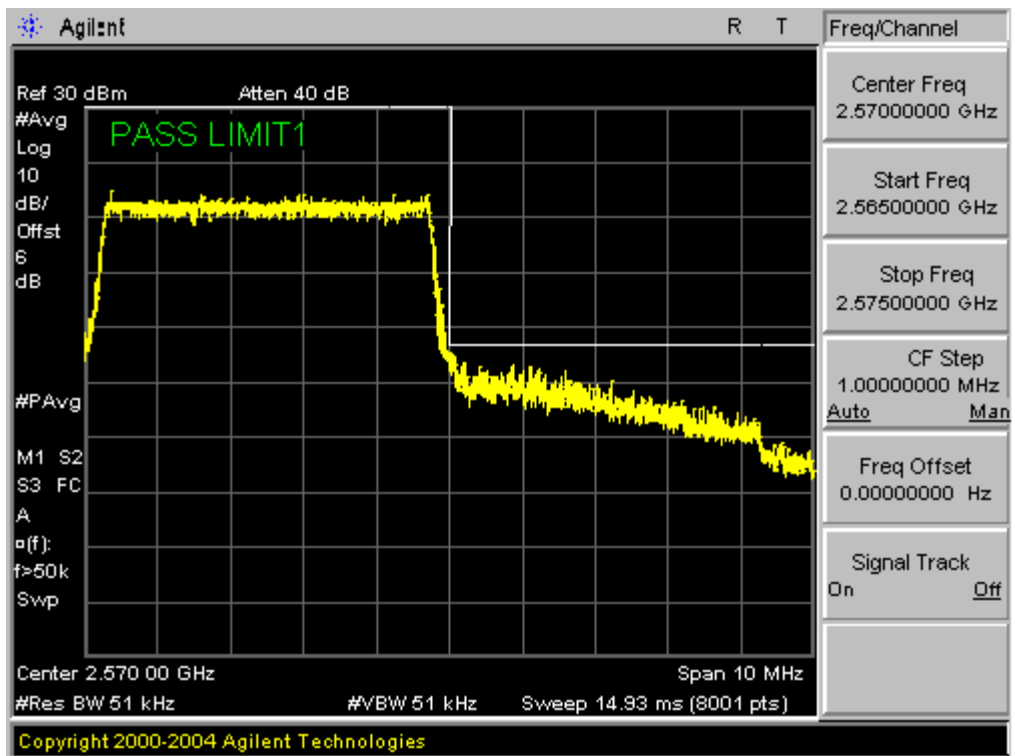

Band 7,UL Channel 20800,UL Frequency 2505.0,BW 10.0,NO. RB 50,RB POS. Low,QPSK

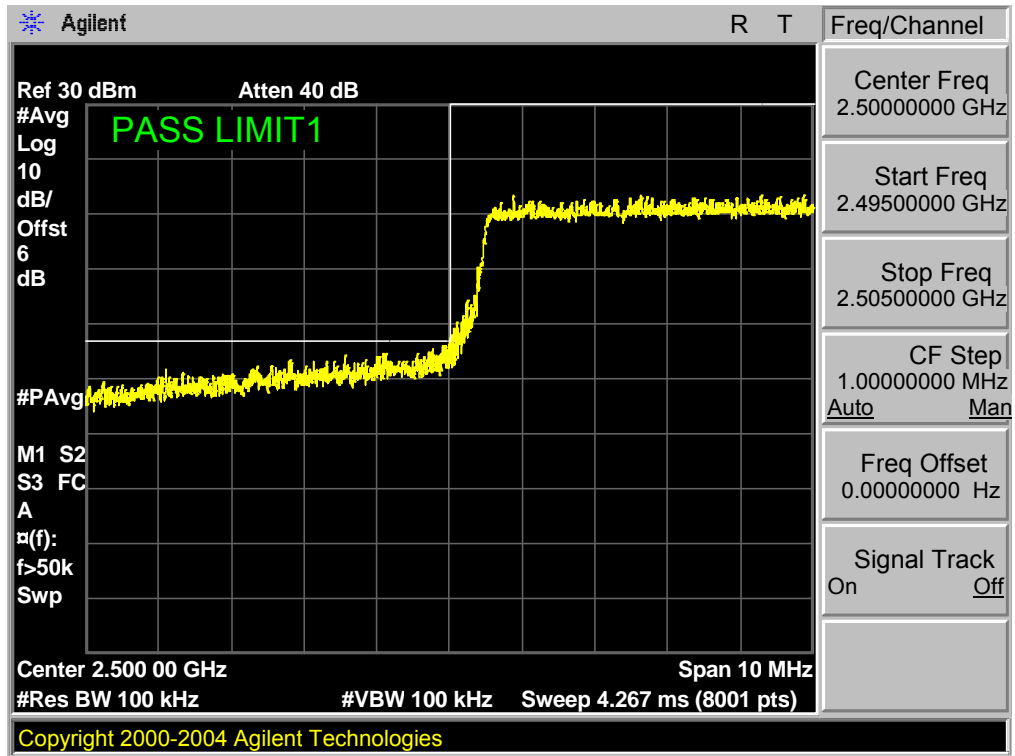

Band 7,UL Channel 20800,UL Frequency 2505.0,BW 10.0,NO. RB 50,RB POS. Low,QPSK

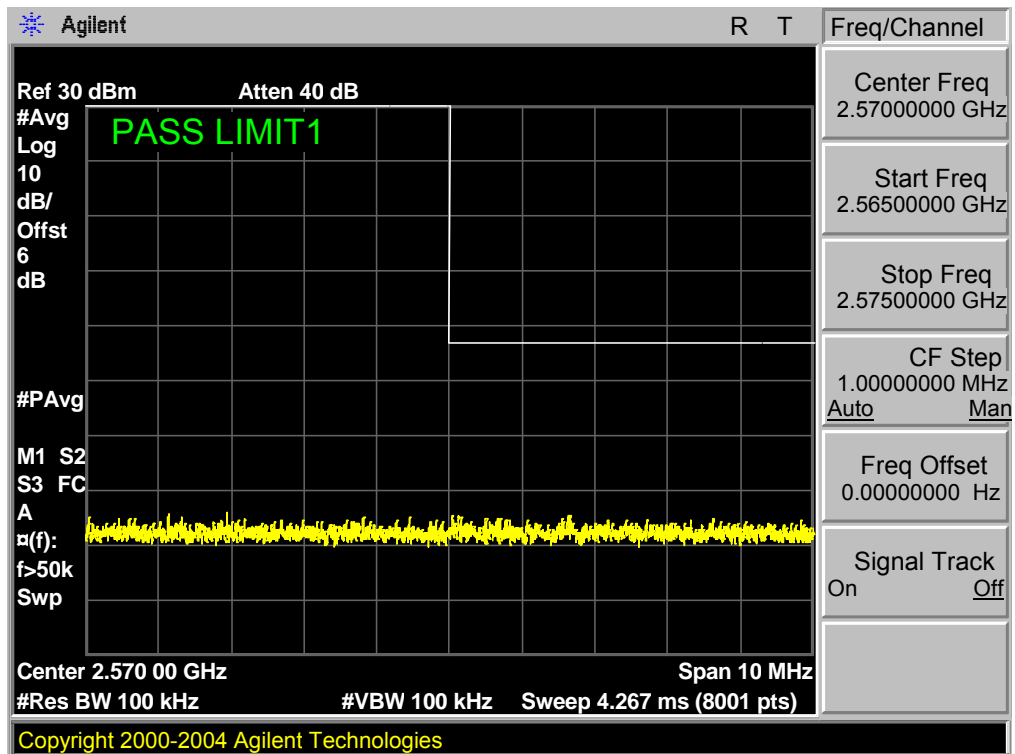

Band 7,UL Channel 20800,UL Frequency 2505.0,BW 10.0,NO. RB 50,RB POS. Low,16QAM

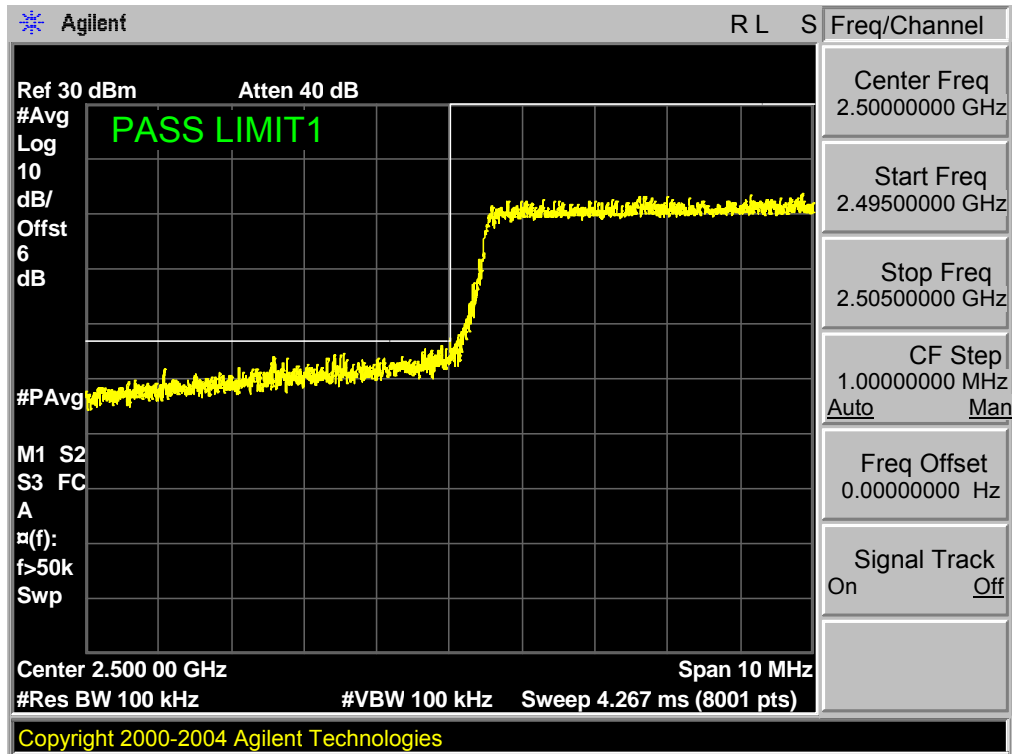

Band 7,UL Channel 20800,UL Frequency 2505.0,BW 10.0,NO. RB 50,RB POS. Low,16QAM

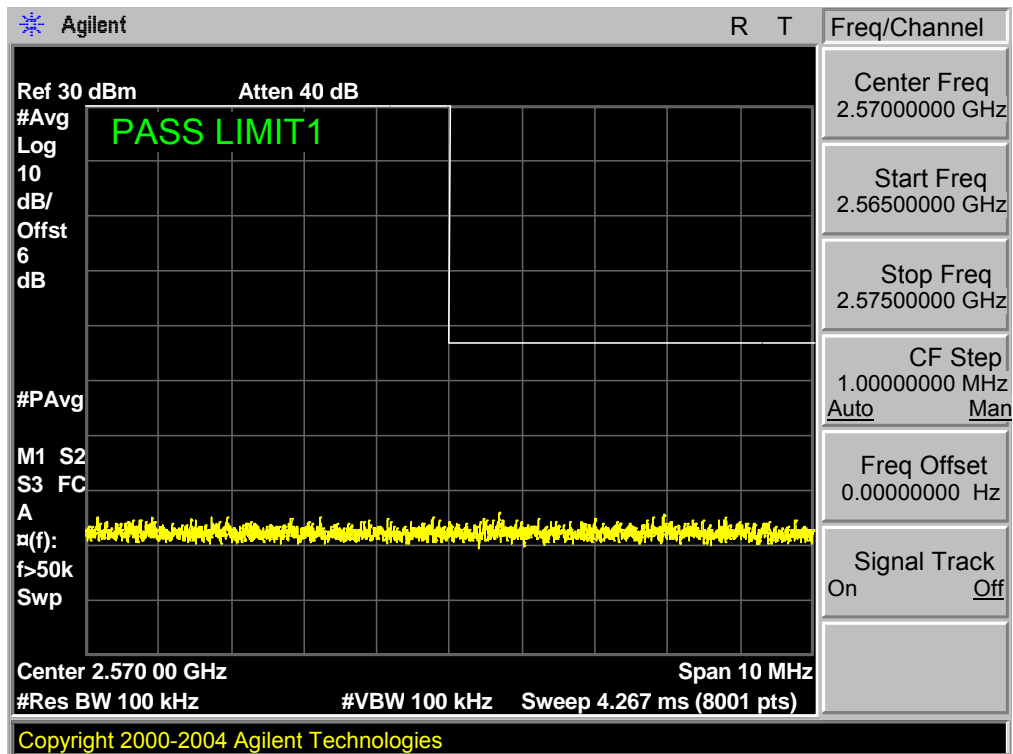

Band 7,UL Channel 21400,UL Frequency 2565.0,BW 10.0,NO. RB 50,RB POS. Low,QPSK

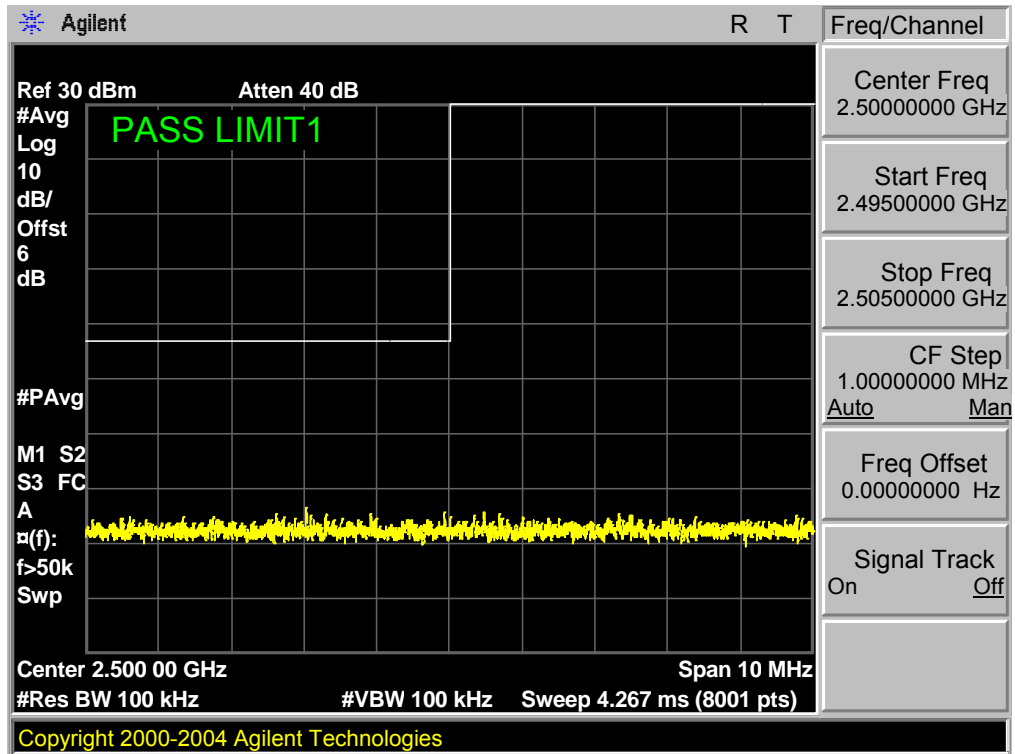

Band 7,UL Channel 21400,UL Frequency 2565.0,BW 10.0,NO. RB 50,RB POS. Low,QPSK

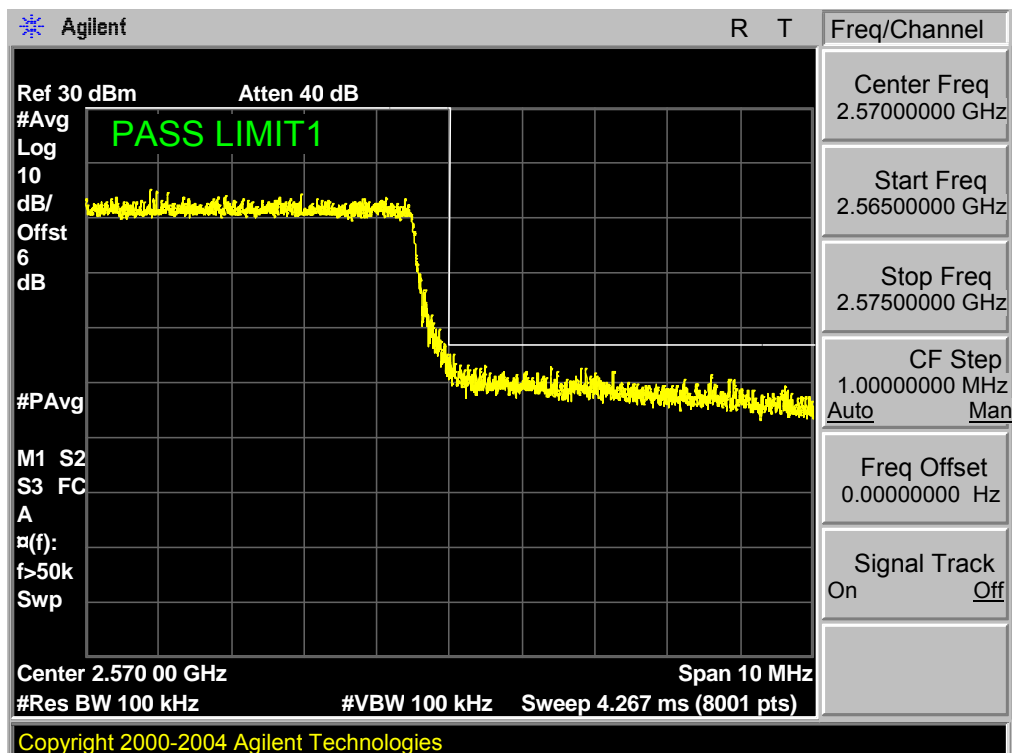

Band 7,UL Channel 21400,UL Frequency 2565.0,BW 10.0,NO. RB 50,RB POS. Low,16QAM

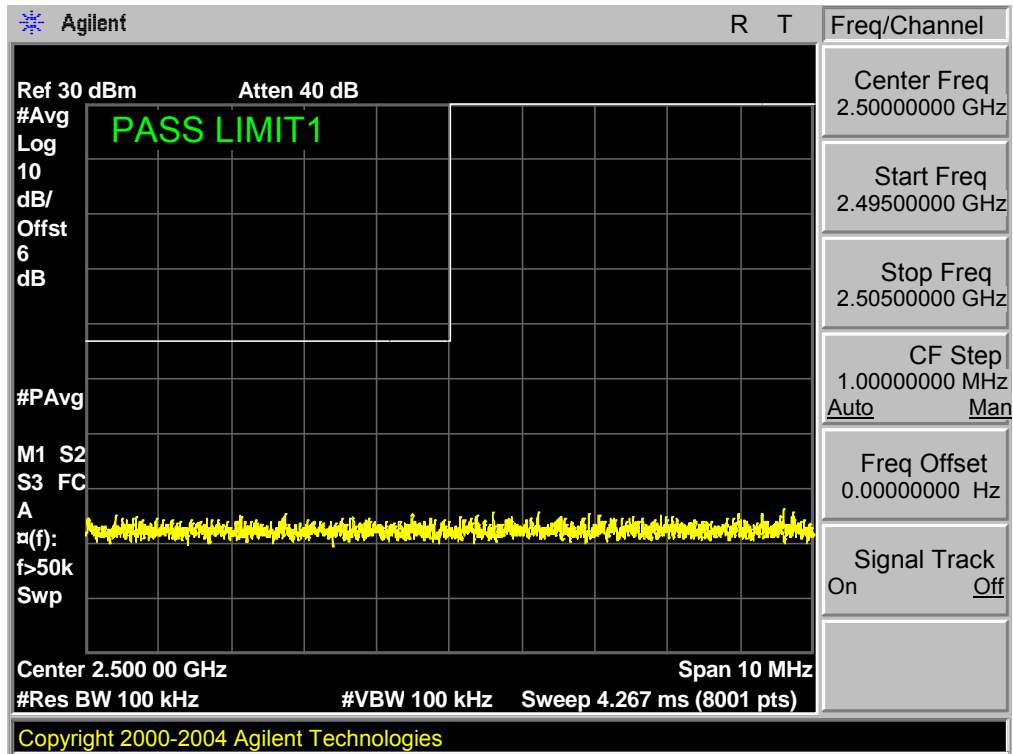

Band 7,UL Channel 21400,UL Frequency 2565.0,BW 10.0,NO. RB 50,RB POS. Low,16QAM

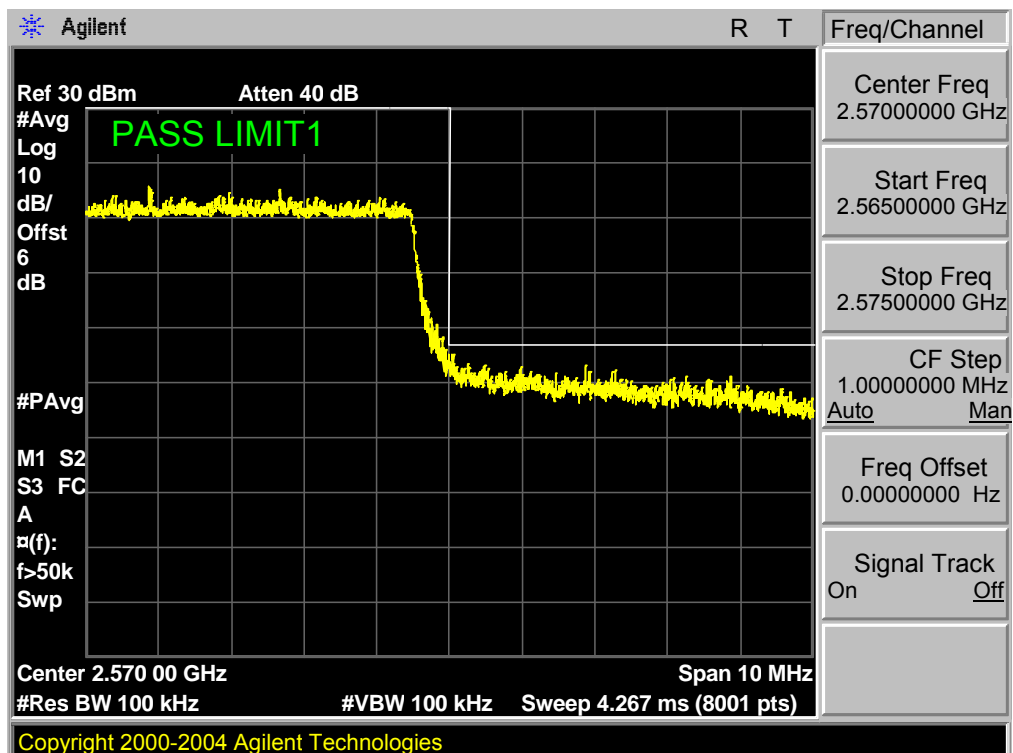

Band 7,UL Channel 21400,UL Frequency 2565.0,BW 10.0,NO. RB 50,RB POS. Low,QPSK

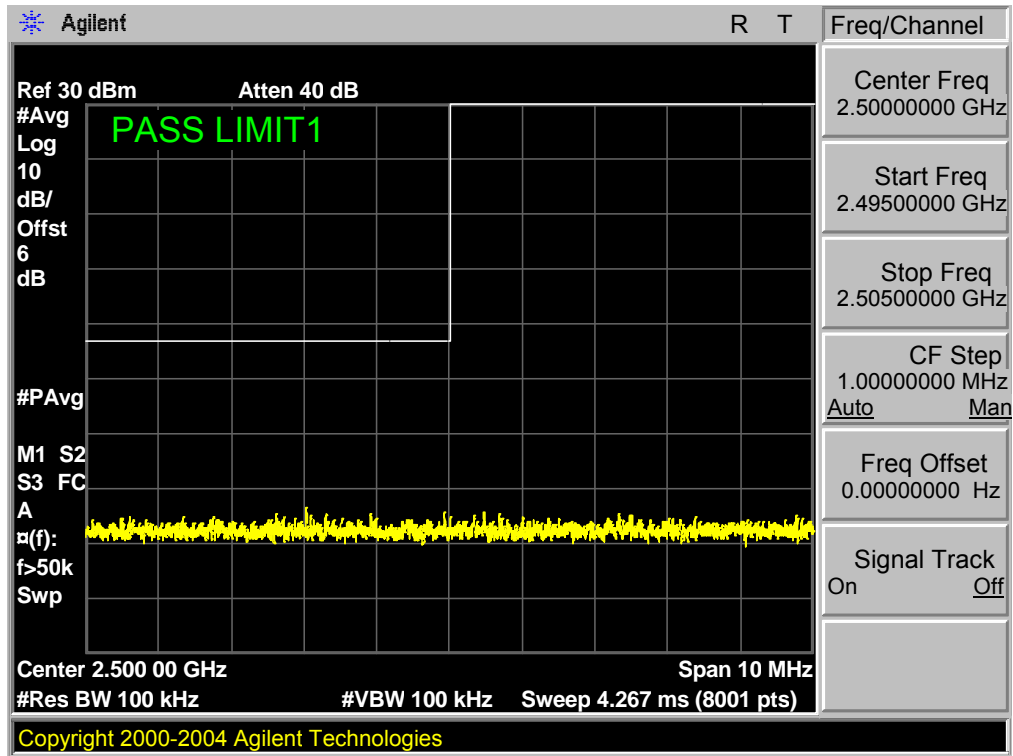

Band 7,UL Channel 21400,UL Frequency 2565.0,BW 10.0,NO. RB 50,RB POS. Low,QPSK

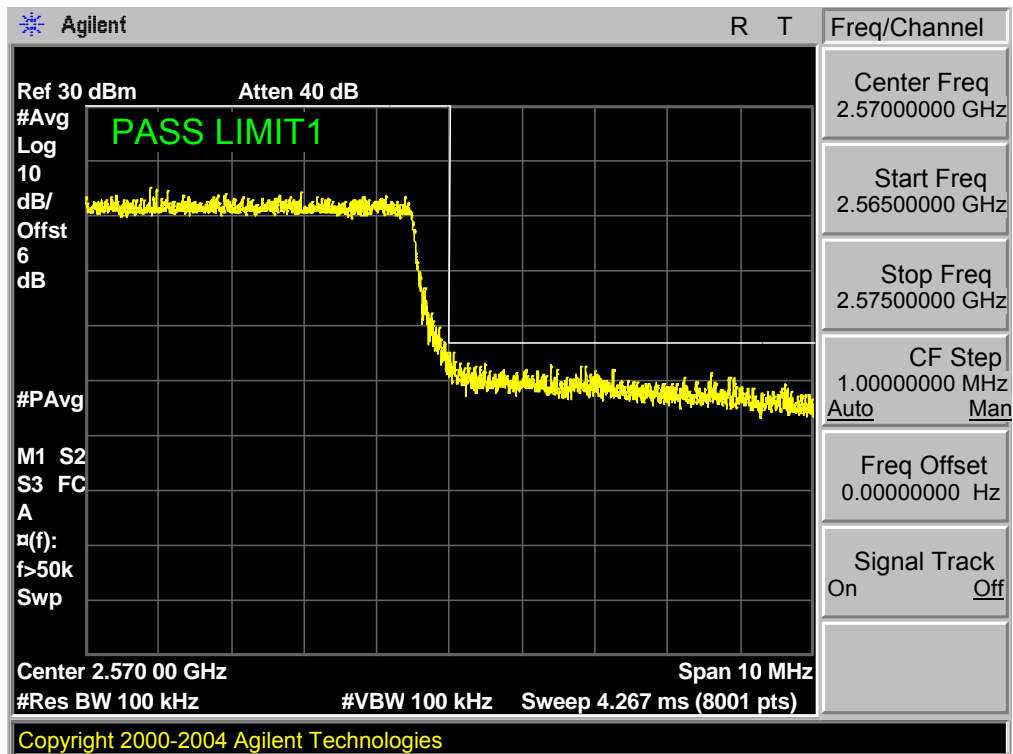

Band 7,UL Channel 21400,UL Frequency 2565.0,BW 10.0,NO. RB 50,RB POS. Low,16QAM

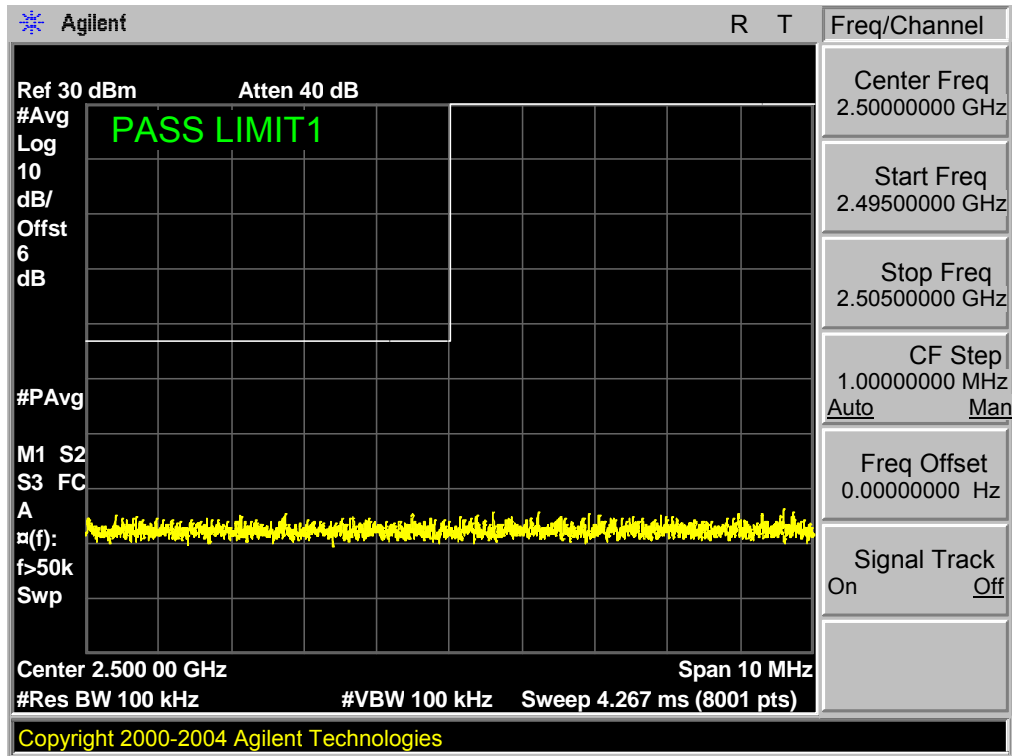

Band 7,UL Channel 21400,UL Frequency 2565.0,BW 10.0,NO. RB 50,RB POS. Low,16QAM

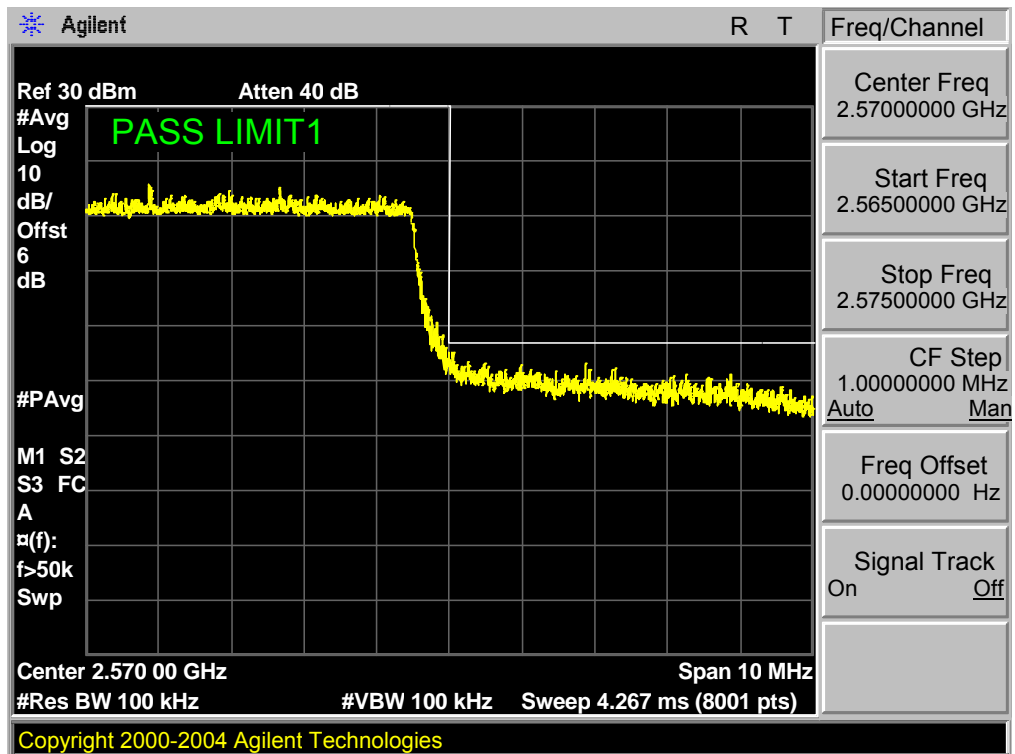

Band 7,UL Channel 20825,UL Frequency 2507.5,BW 15.0,NO. RB 75,RB POS. Low,QPSK

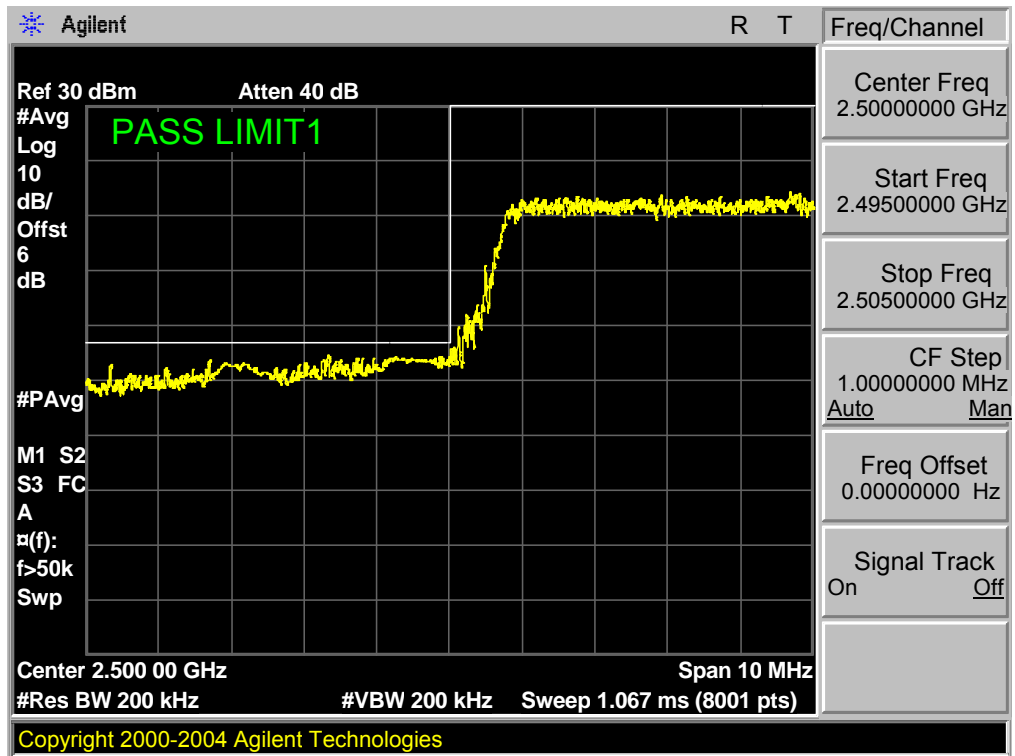

Band 7,UL Channel 20825,UL Frequency 2507.5,BW 15.0,NO. RB 75,RB POS. Low,QPSK

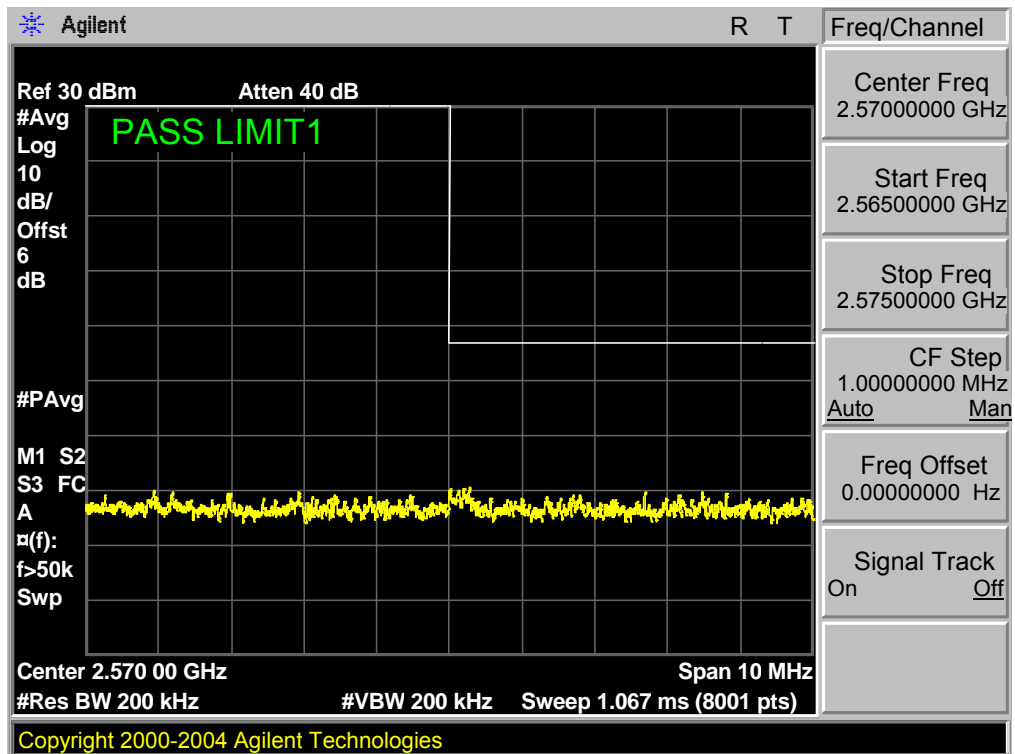

Band 7,UL Channel 20825,UL Frequency 2507.5,BW 15.0,NO. RB 75,RB POS. Low,16QAM

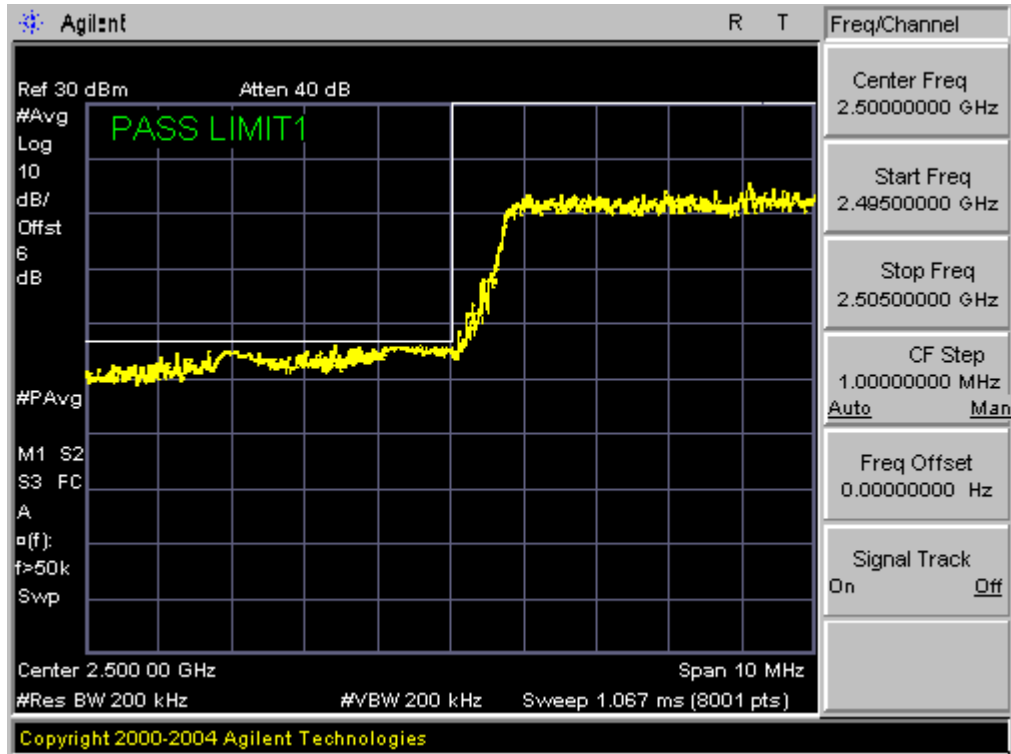

Band 7,UL Channel 20825,UL Frequency 2507.5,BW 15.0,NO. RB 75,RB POS. Low,16QAM

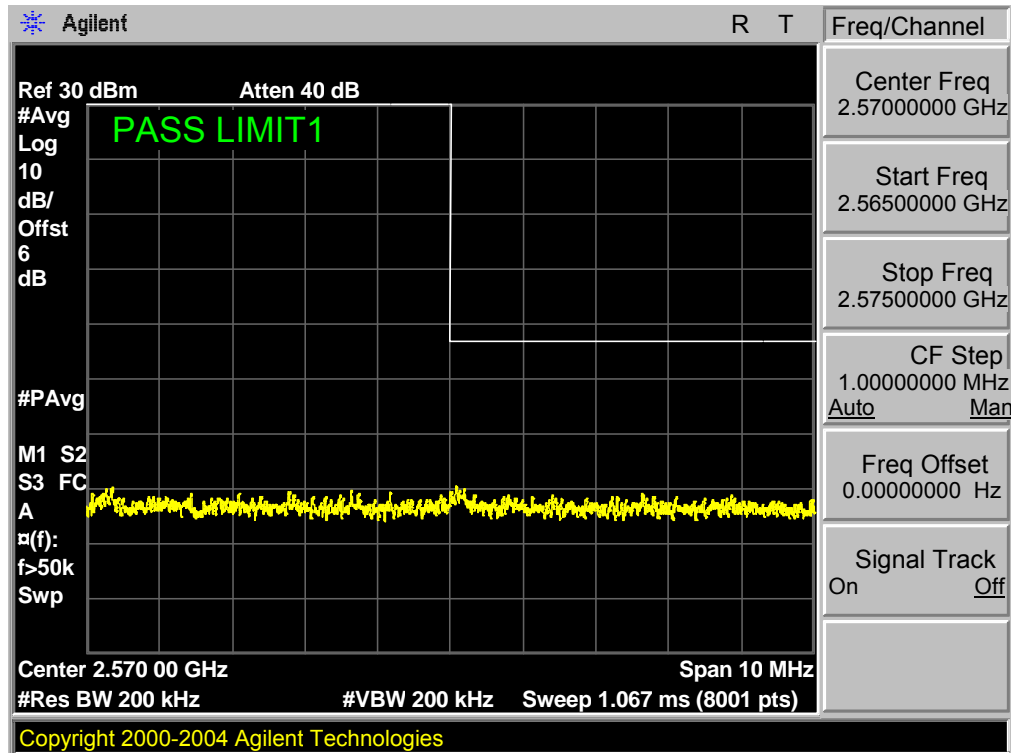

Band 7,UL Channel 21375,UL Frequency 2562.5,BW 15.0,NO. RB 75,RB POS. Low,QPSK

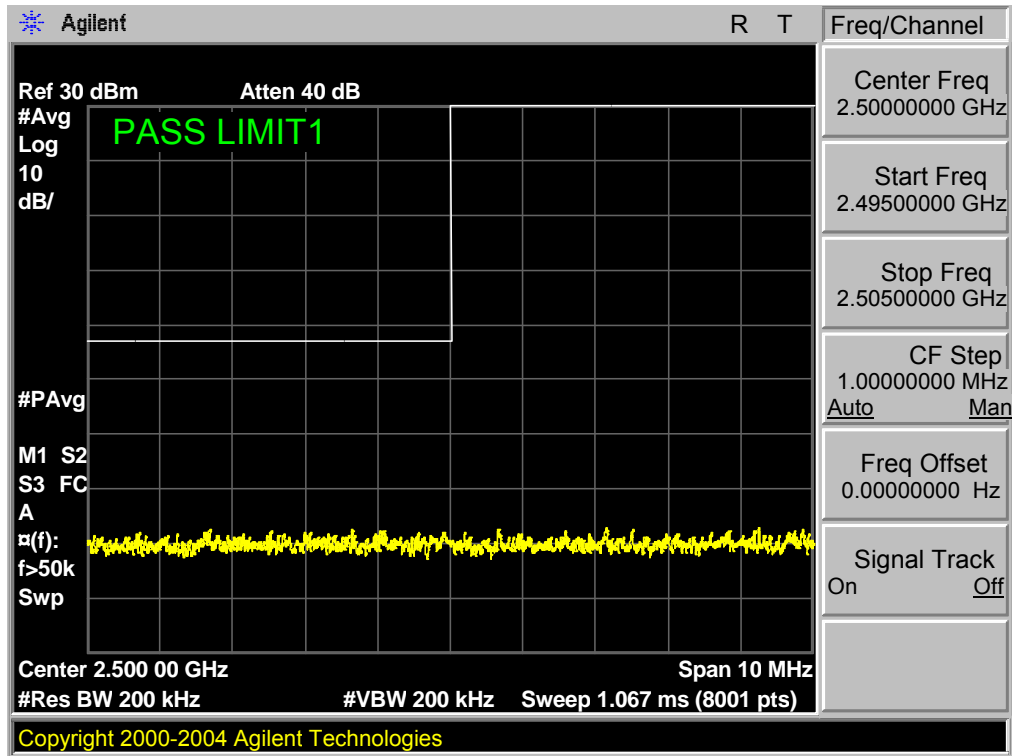

Band 7,UL Channel 21375,UL Frequency 2562.5,BW 15.0,NO. RB 75,RB POS. Low,QPSK

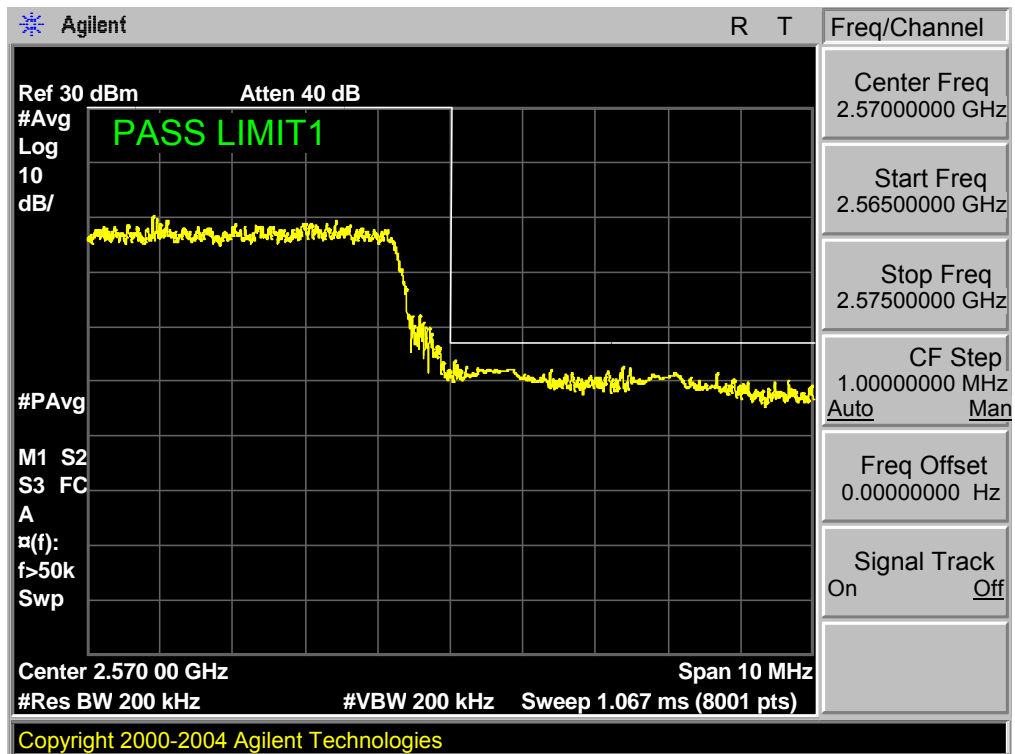

Band 7,UL Channel 21375,UL Frequency 2562.5,BW 15.0,NO. RB 75,RB POS. Low,16QAM

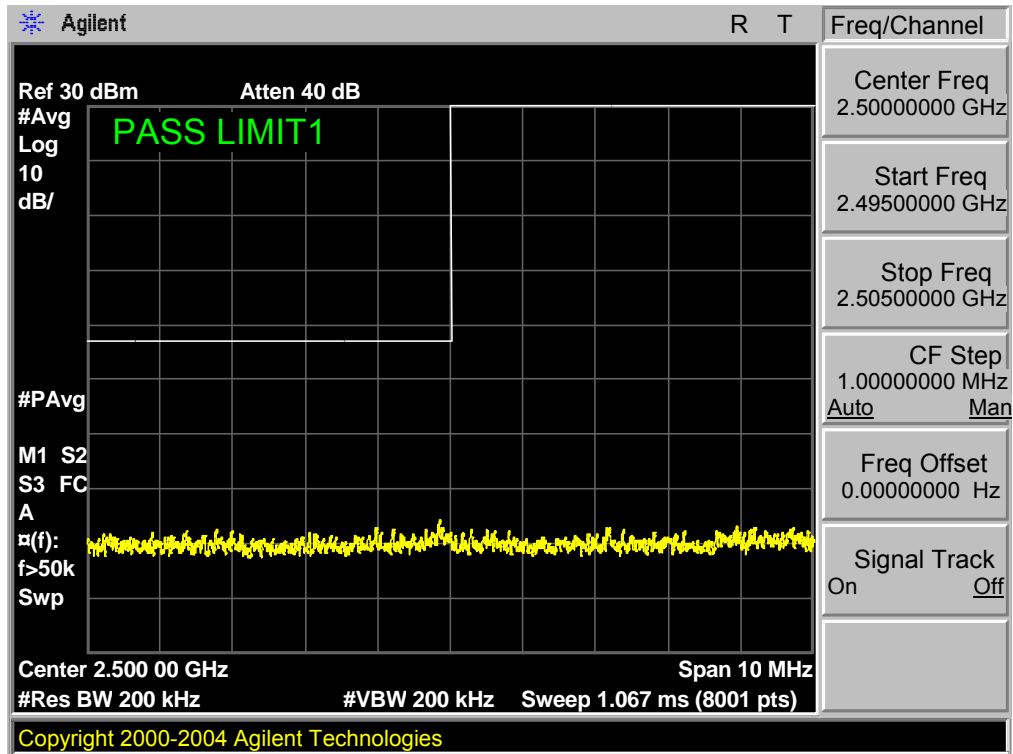

Band 7,UL Channel 21375,UL Frequency 2562.5,BW 15.0,NO. RB 75,RB POS. Low,16QAM

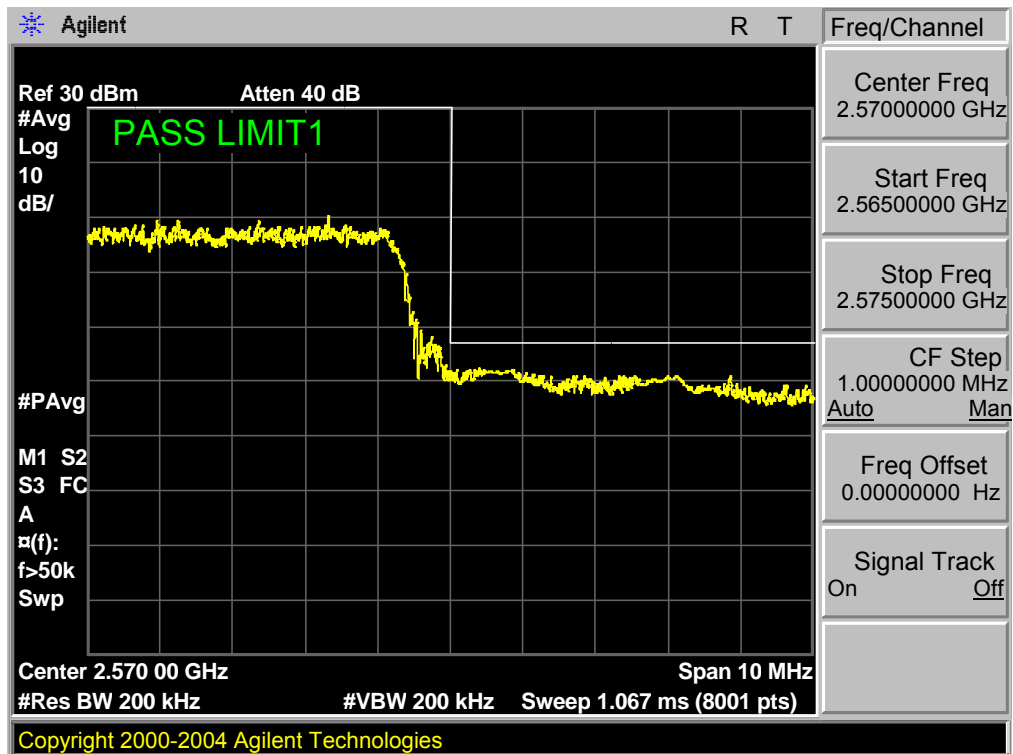

Band 7,UL Channel 20850,UL Frequency 2510.0,BW 20.0,NO. RB 100,RB POS. Low,QPSK

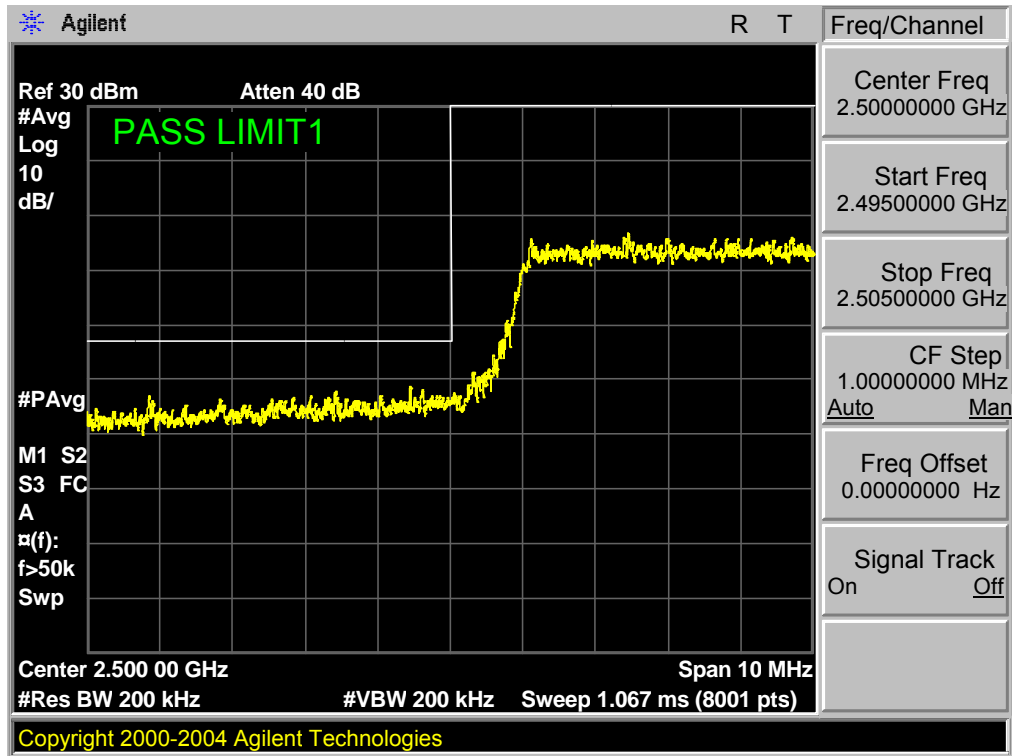

Band 7,UL Channel 20850,UL Frequency 2510.0,BW 20.0,NO. RB 100,RB POS. Low,QPSK

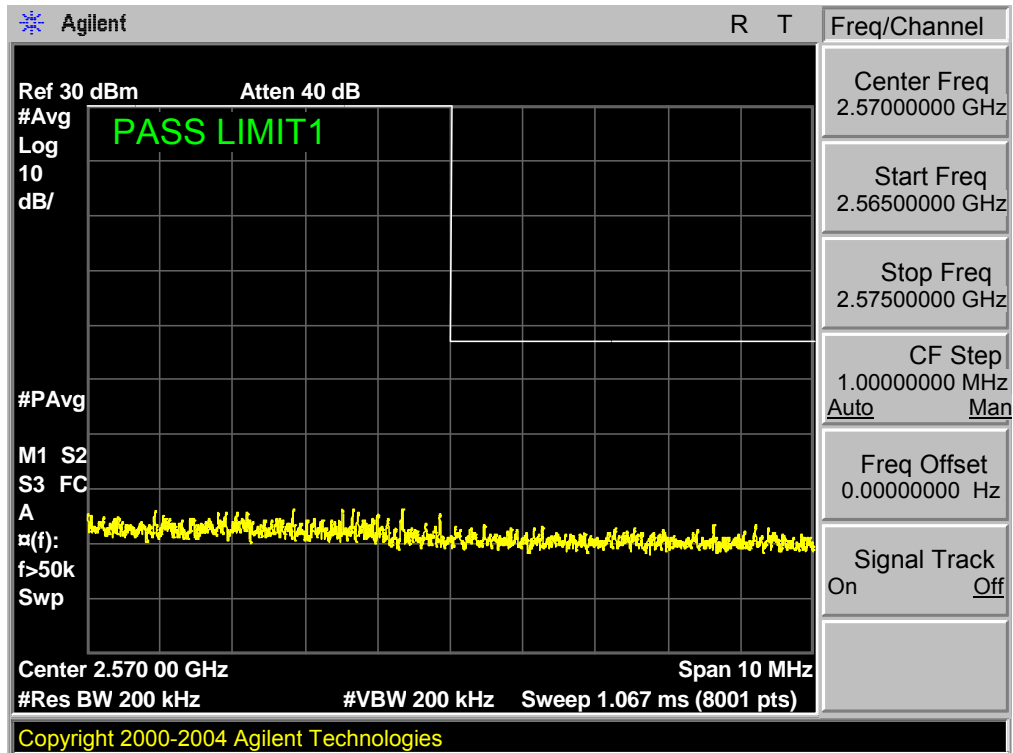

Band 7,UL Channel 20850,UL Frequency 2510.0,BW 20.0,NO. RB 100,RB POS. Low,16QAM

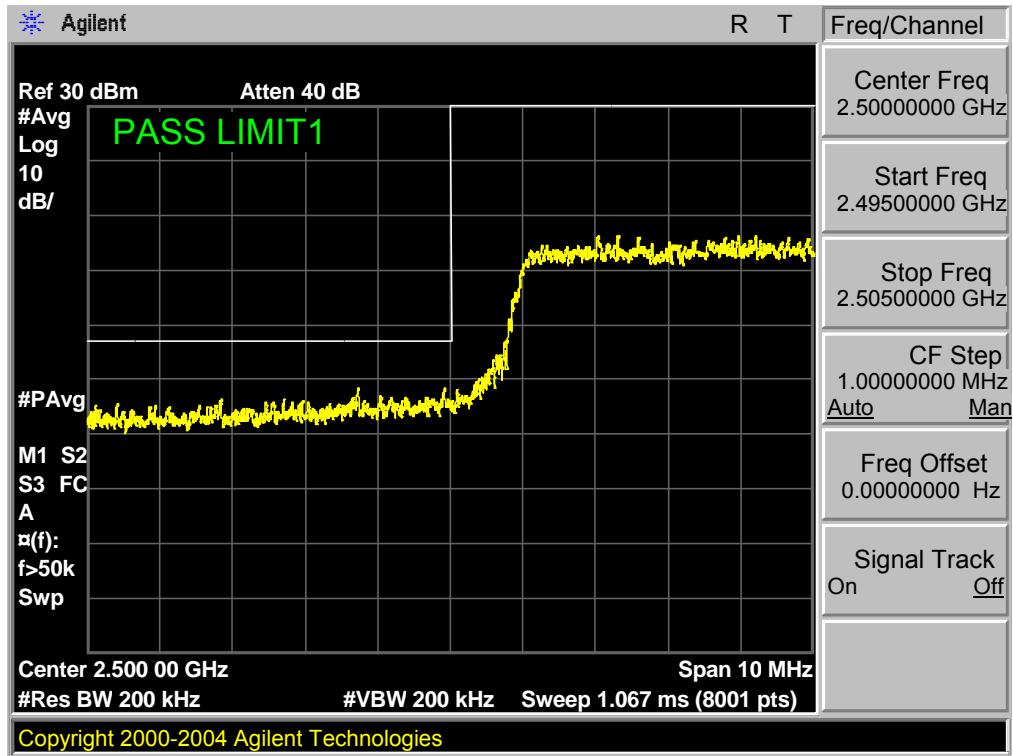

Band 7,UL Channel 20850,UL Frequency 2510.0,BW 20.0,NO. RB 100,RB POS. Low,16QAM

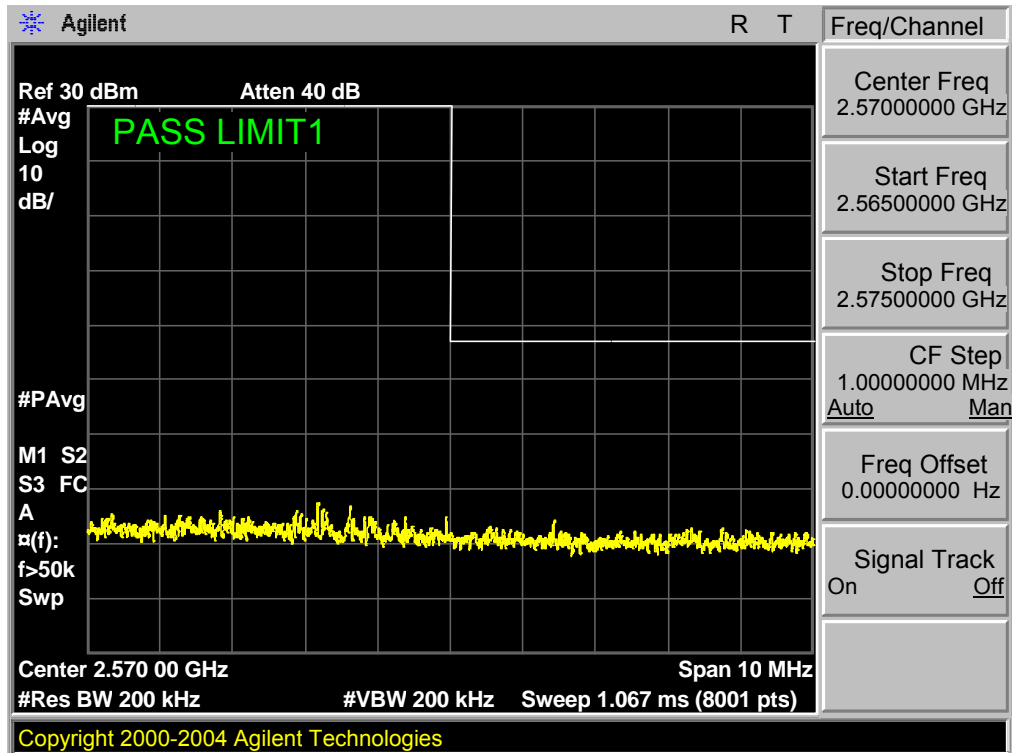

Band 7,UL Channel 21350,UL Frequency 2560.0,BW 20.0,NO. RB 100,RB POS. Low,QPSK

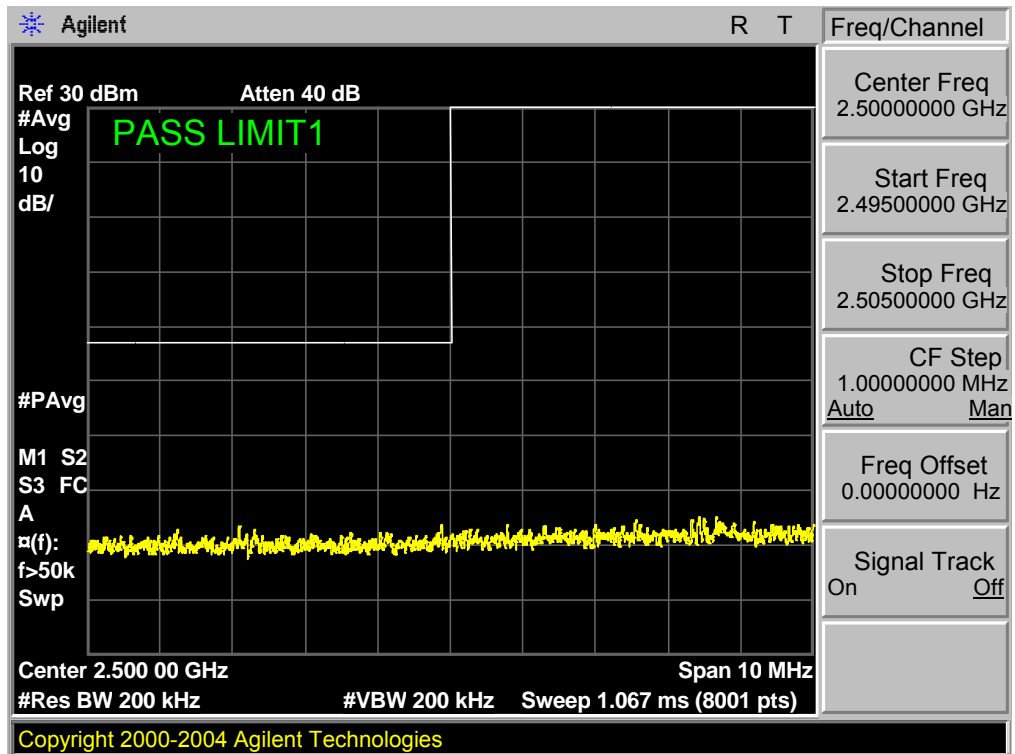

Band 7,UL Channel 21350,UL Frequency 2560.0,BW 20.0,NO. RB 100,RB POS. Low,QPSK

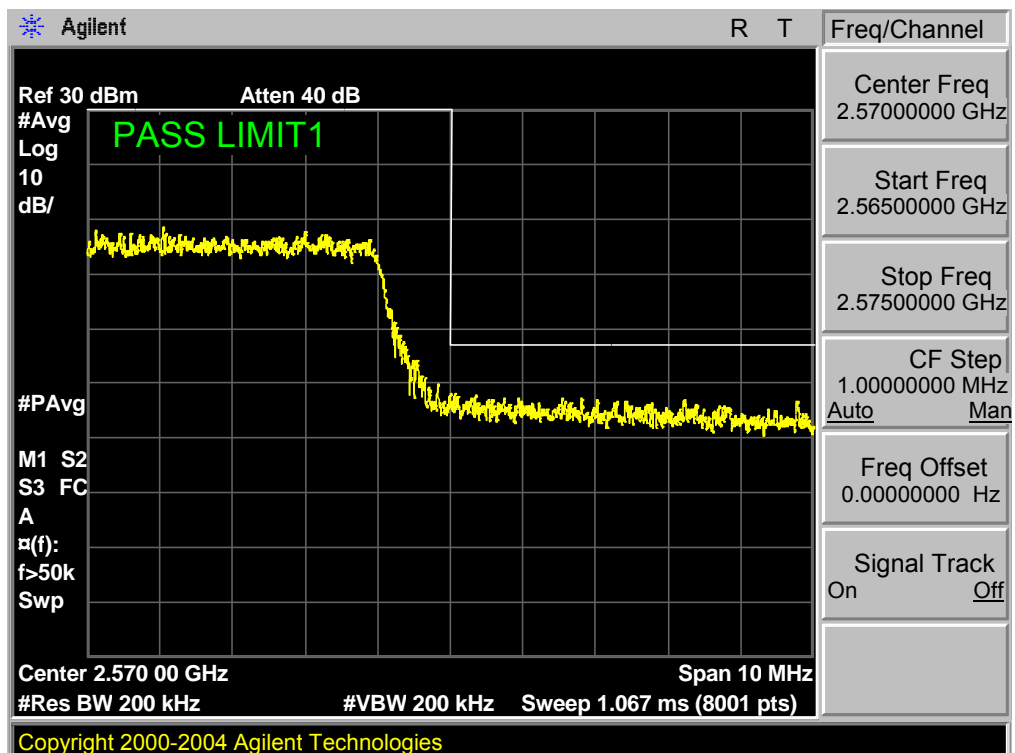

Band 7,UL Channel 21350,UL Frequency 2560.0,BW 20.0,NO. RB 100,RB POS. Low,16QAM

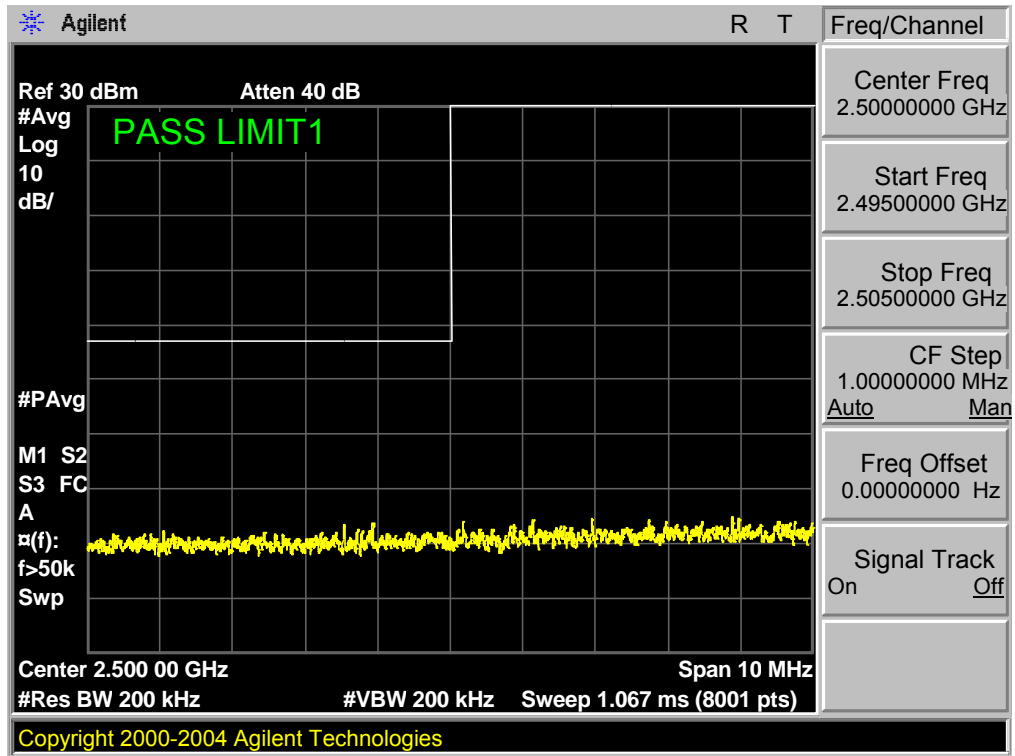

Band 7,UL Channel 21350,UL Frequency 2560.0,BW 20.0,NO. RB 100,RB POS. Low,16QAM

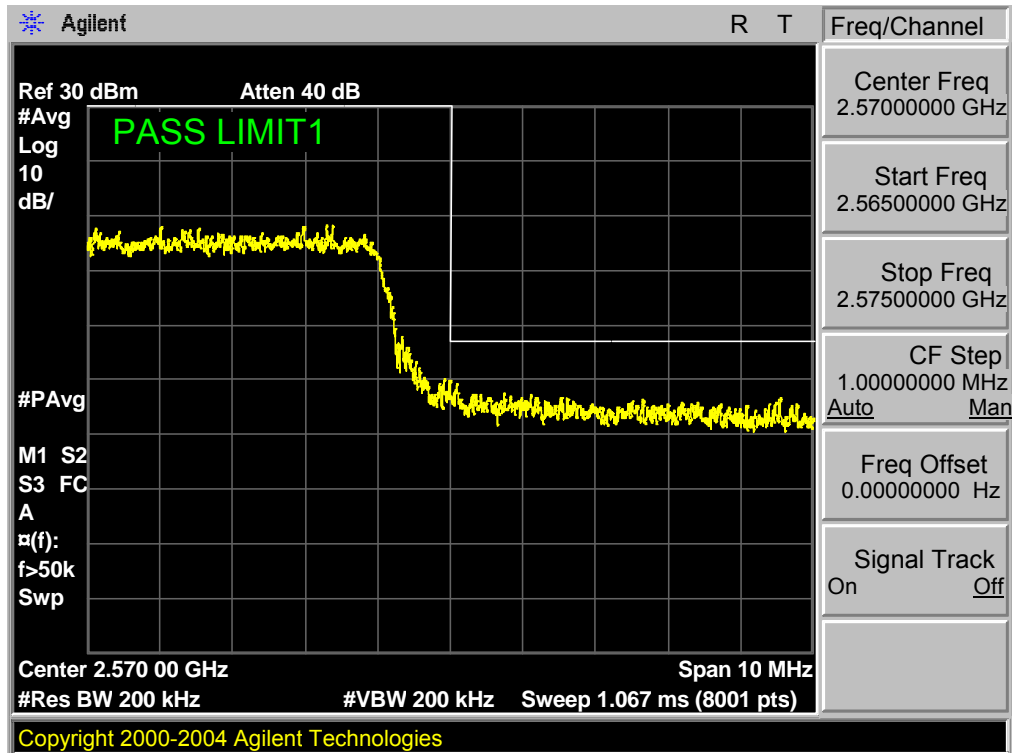

7. OUT OF BAND EMISSIONS

RULE PART(S)

FCC: §2.1051, §27.53

LIMITS

The power of any emission outside of the authorized operating frequency ranges must be attenuated below the transmitting power (P) by a factor of at least $43 + 10 \log (P)$ dB.

TEST PROCEDURE

The RF output of the transmitter was connected to a spectrum analyzer through a calibrated coaxial cable. Sufficient scans were taken to show the out-of-band Emissions, if any, up to 10th harmonic. Multiple sweeps were recorded in maximum hold mode using a peak detector to ensure that the worst-case emissions were caught.

For each out of band emissions measurement:

- Set display line at -13 dBm

- Set RBW & VBW to 100 kHz for the measurement below 1 GHz, and 1 MHz for the measurement above 1 GHz.

MODES TESTED

- LTE Band 7

7.1 MEASUREMENT METHOD

The test set up and general procedure is similar to conducted peak output power test. Only different for setting the measurement configuration of the measuring instrument of Spectrum Analyzer.

7.1.1 LTE BAND 7

Band 7,UL Channel 20775,UL Frequency 2502.5,BW 5.0,NO. RB 1,RB POS. Low,QPSK

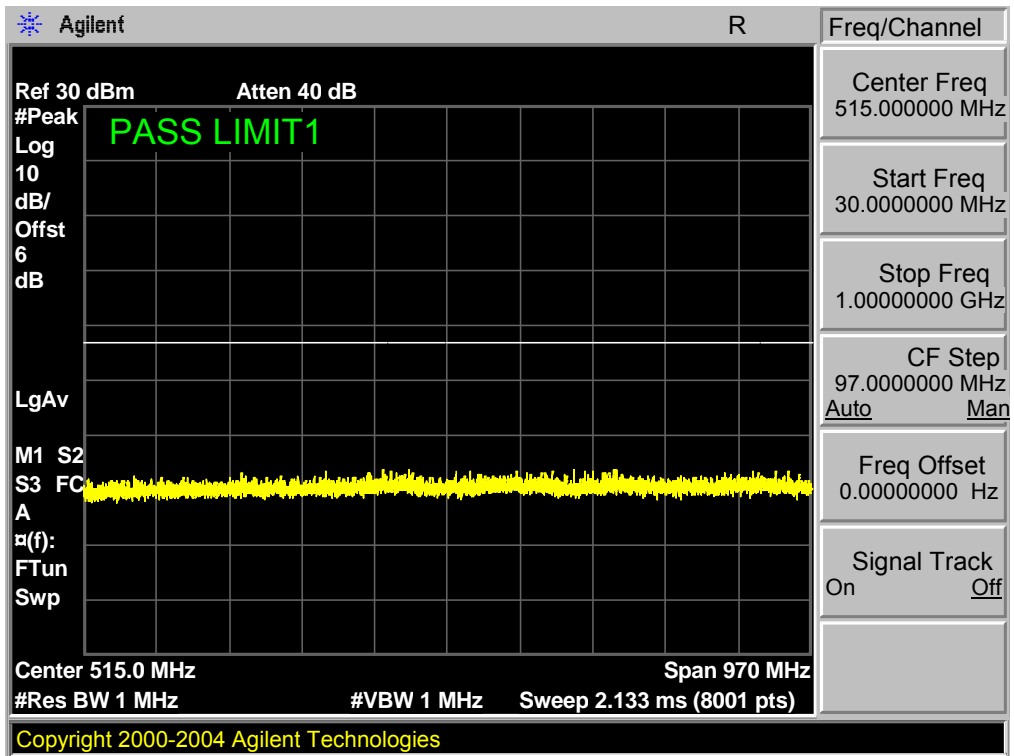

Band 7,UL Channel 20775,UL Frequency 2502.5,BW 5.0,NO. RB 1,RB POS. Low,QPSK

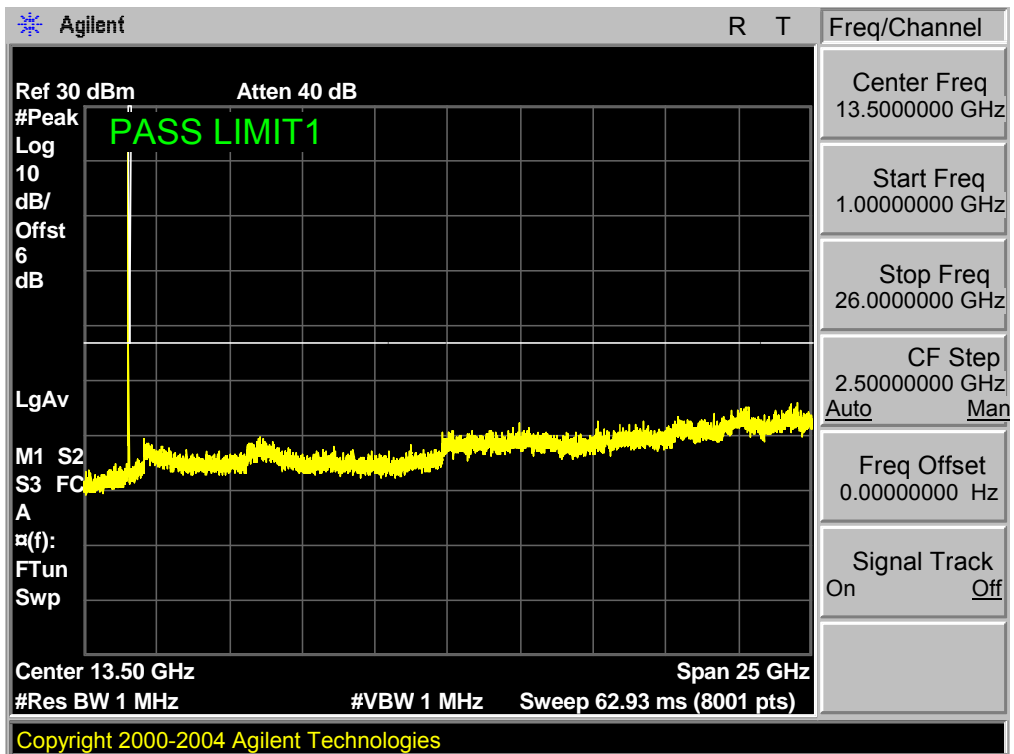

Band 7,UL Channel 21100,UL Frequency 2535.0,BW 5.0,NO. RB 1,RB POS. Low,QPSK

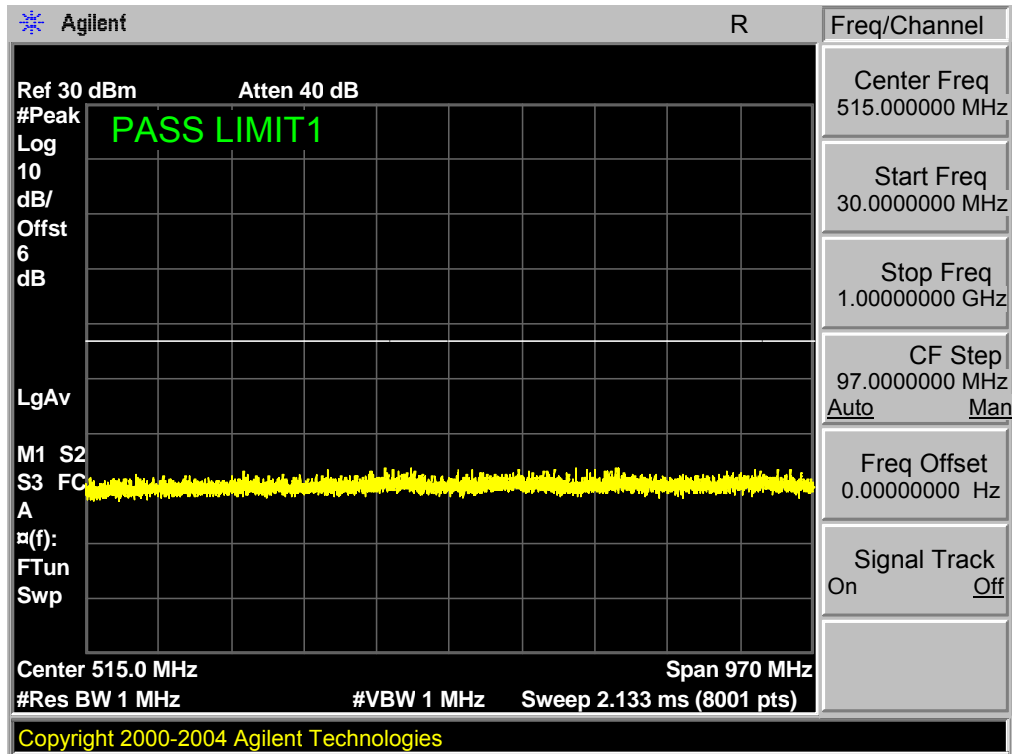

Band 7,UL Channel 21100,UL Frequency 2535.0,BW 5.0,NO. RB 1,RB POS. Low,QPSK

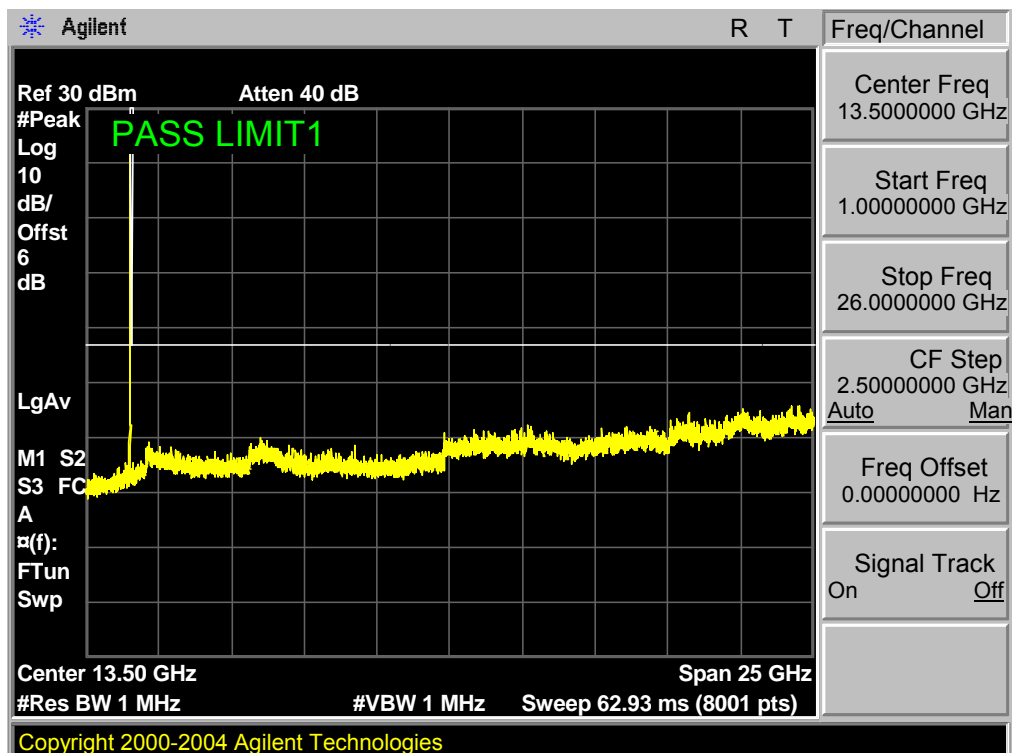

Band 7,UL Channel 21425,UL Frequency 2567.5,BW 5.0,NO. RB 1,RB POS. Low,QPSK

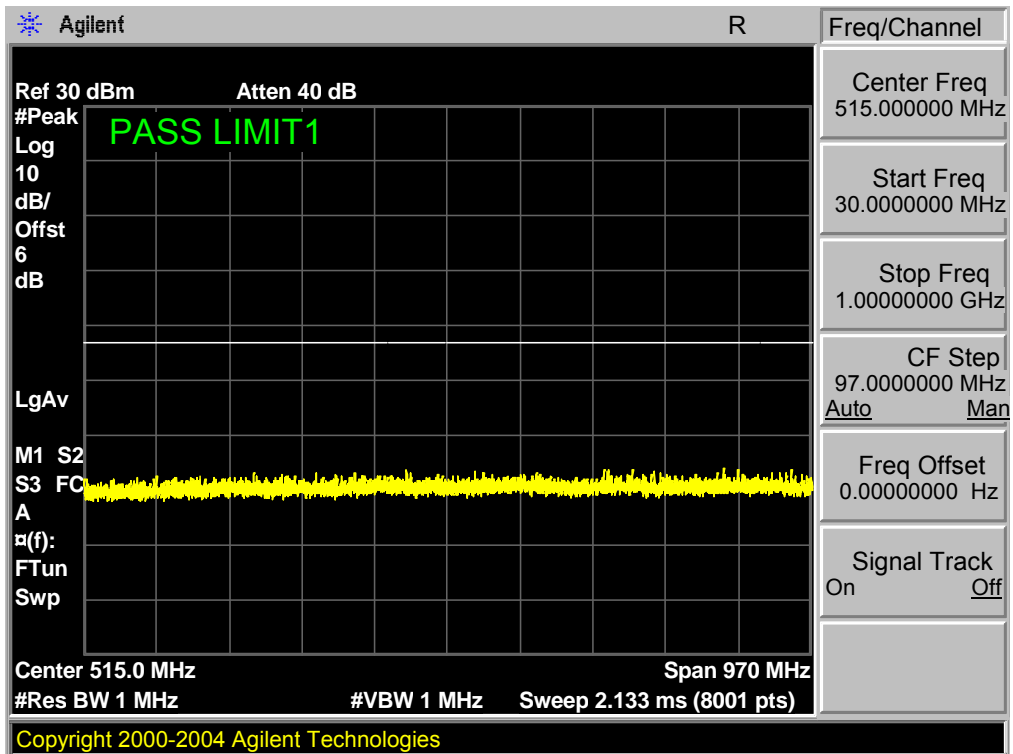

Band 7,UL Channel 21425,UL Frequency 2567.5,BW 5.0,NO. RB 1,RB POS. Low,QPSK

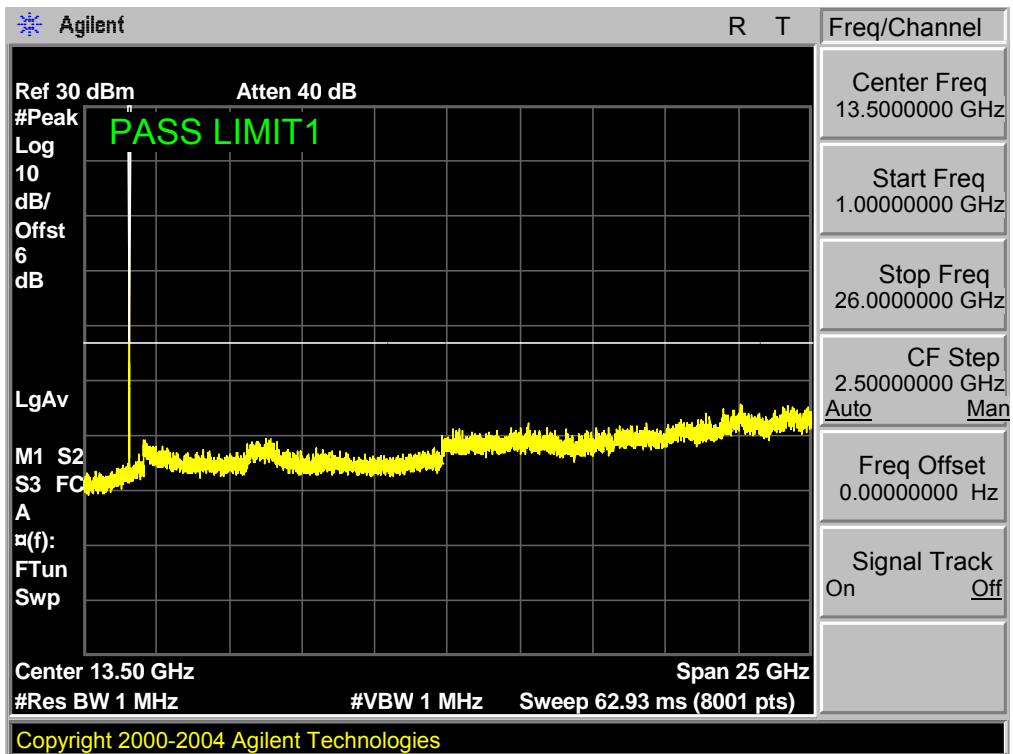

Band 7,UL Channel 20775,UL Frequency 2502.5,BW 5.0,NO. RB 1,RB POS. Low,16QAM

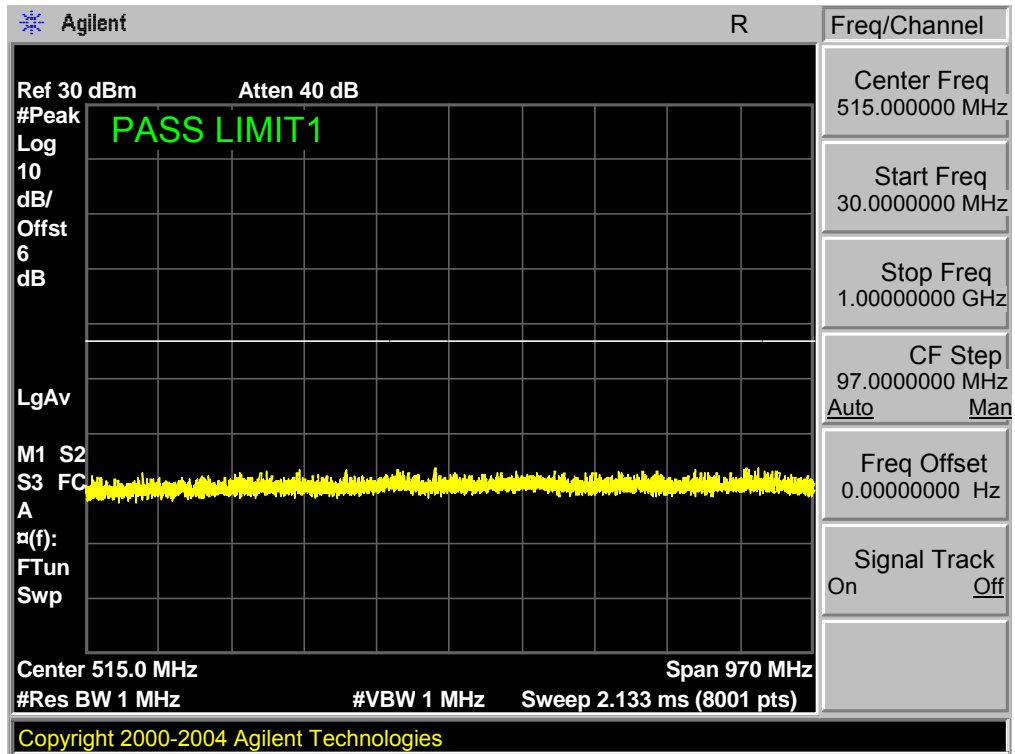

Band 7,UL Channel 20775,UL Frequency 2502.5,BW 5.0,NO. RB 1,RB POS. Low,16QAM

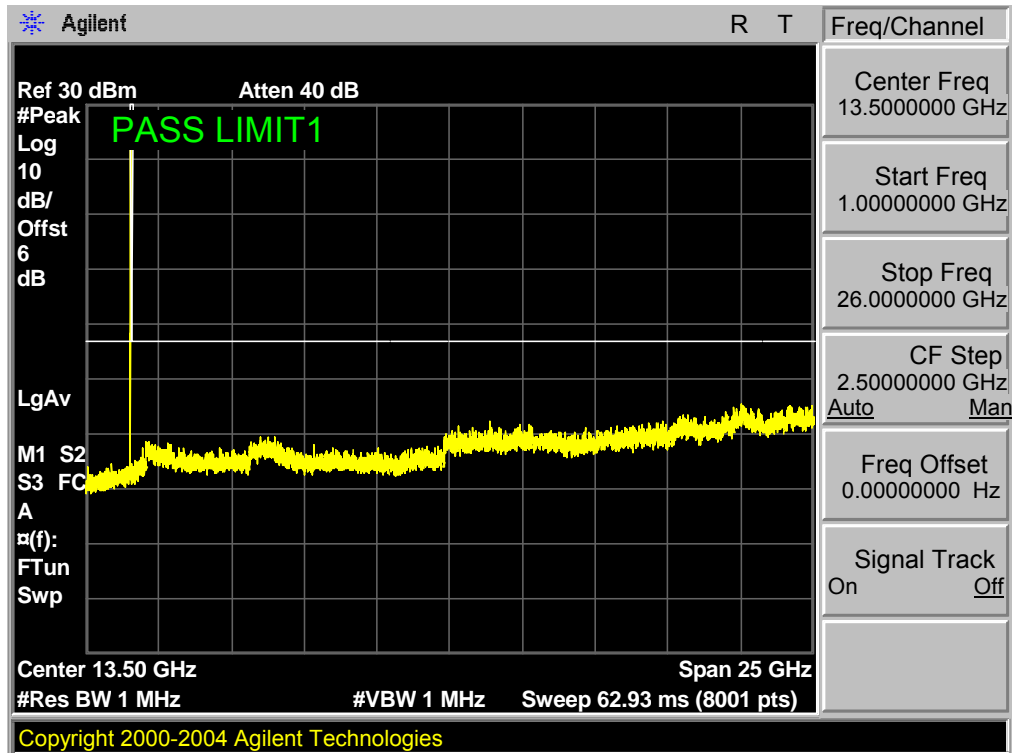

Band 7,UL Channel 21100,UL Frequency 2535.0,BW 5.0,NO. RB 1,RB POS. Low,16QAM

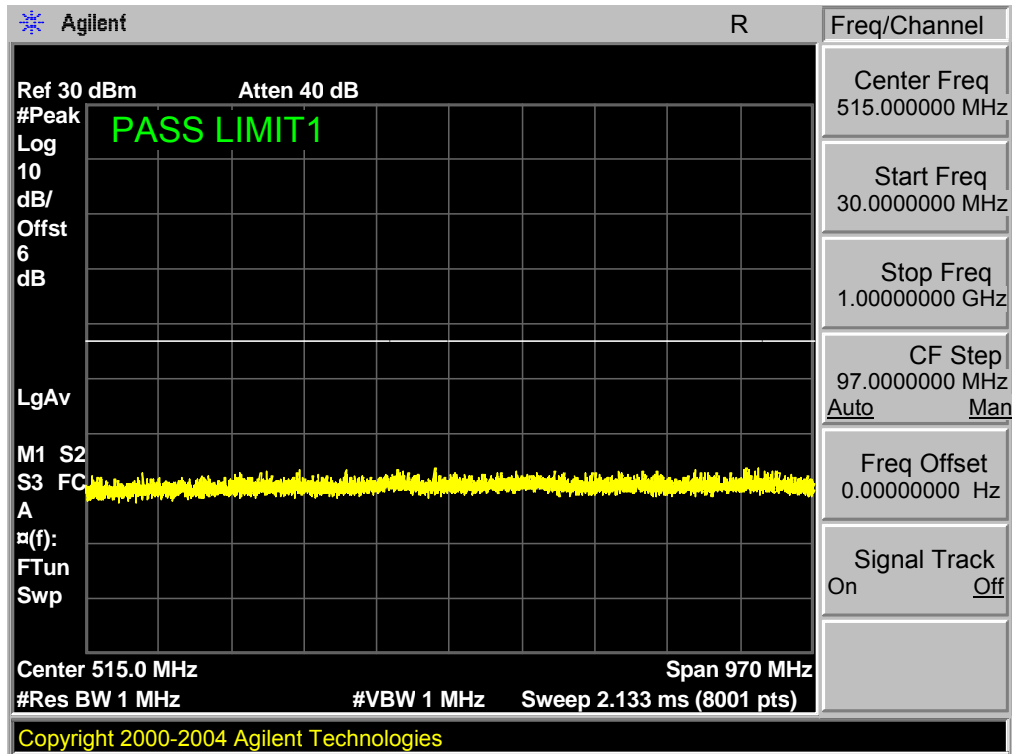

Band 7,UL Channel 21100,UL Frequency 2535.0,BW 5.0,NO. RB 1,RB POS. Low,16QAM

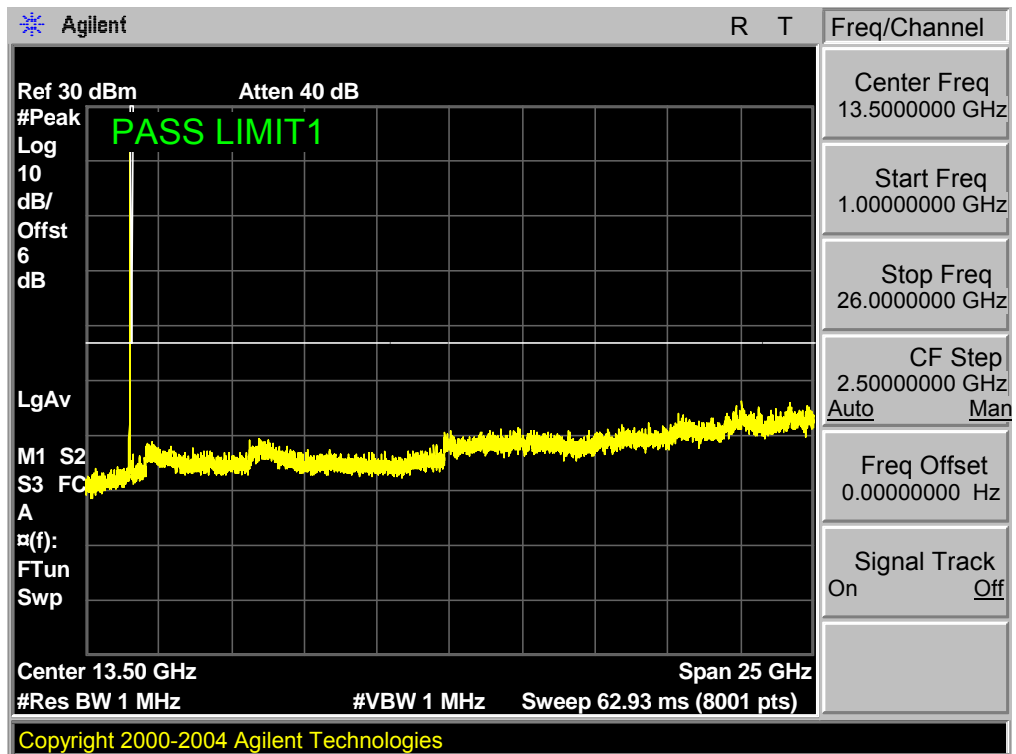

Band 7,UL Channel 21425,UL Frequency 2567.5,BW 5.0,NO. RB 1,RB POS. Low,16QAM

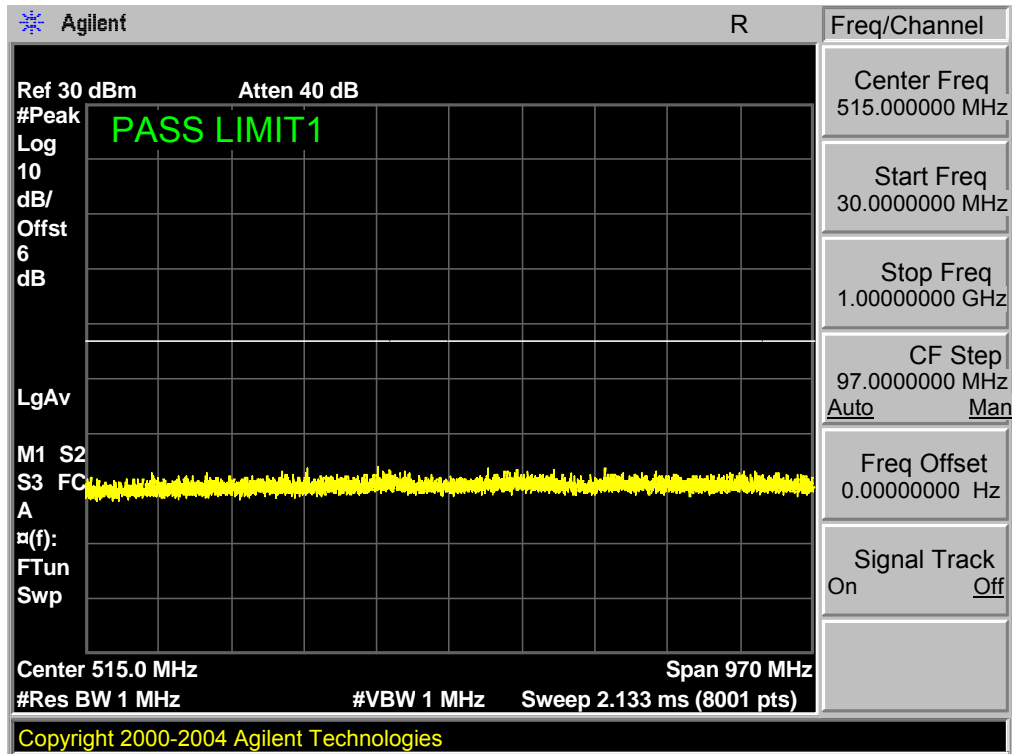

Band 7,UL Channel 21425,UL Frequency 2567.5,BW 5.0,NO. RB 1,RB POS. Low,16QAM

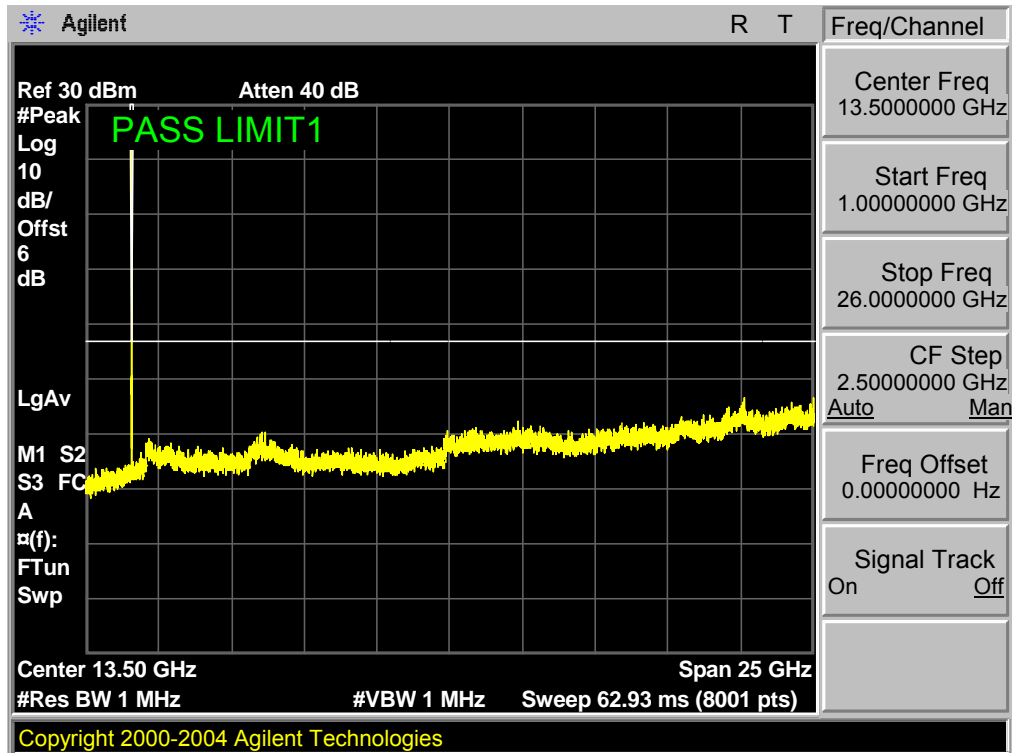

Band 7,UL Channel 20800,UL Frequency 2505.0,BW 10.0,NO. RB 1,RB POS. Low,QPSK

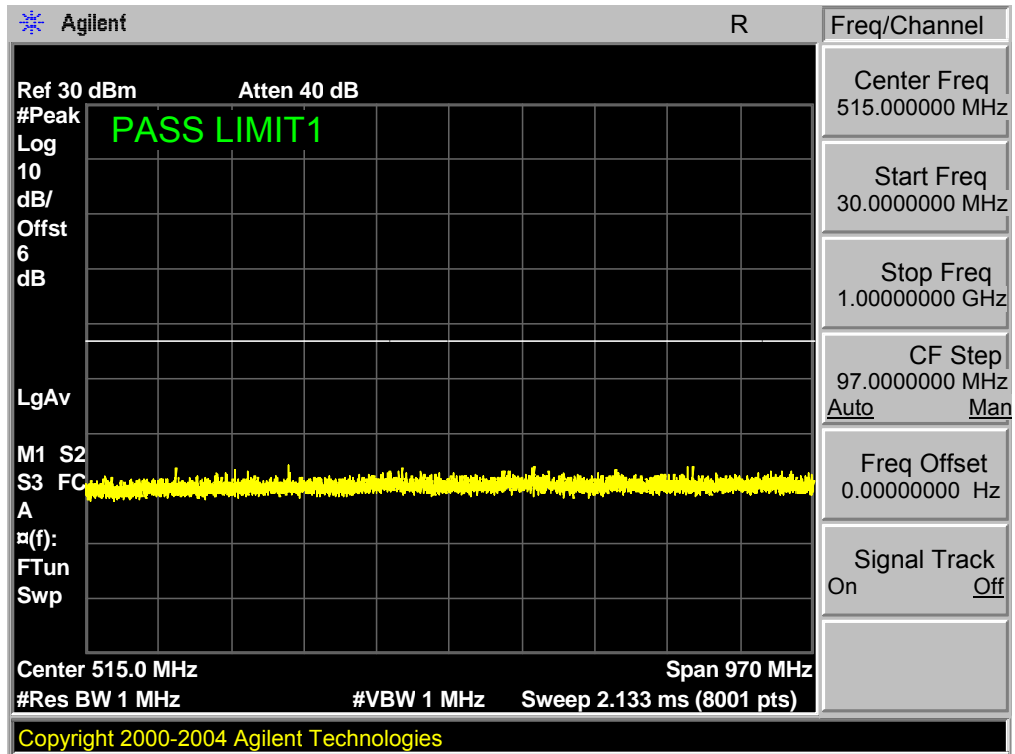

Band 7,UL Channel 20800,UL Frequency 2505.0,BW 10.0,NO. RB 1,RB POS. Low,QPSK

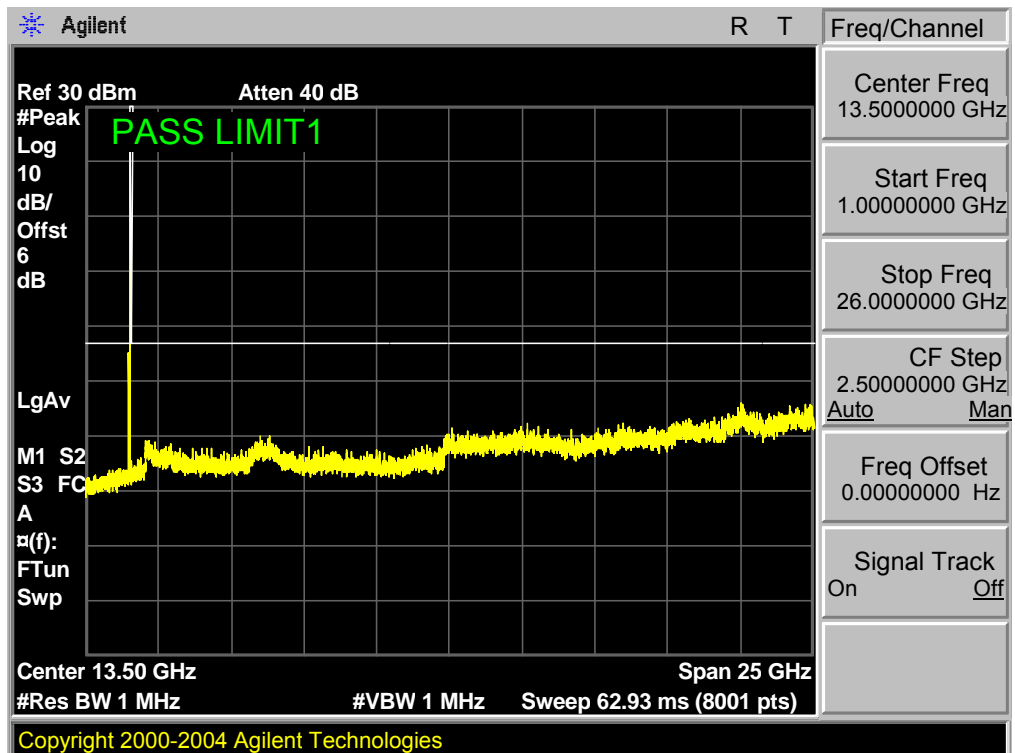

Band 7,UL Channel 21100,UL Frequency 2535.0,BW 10.0,NO. RB 1,RB POS. Low,QPSK

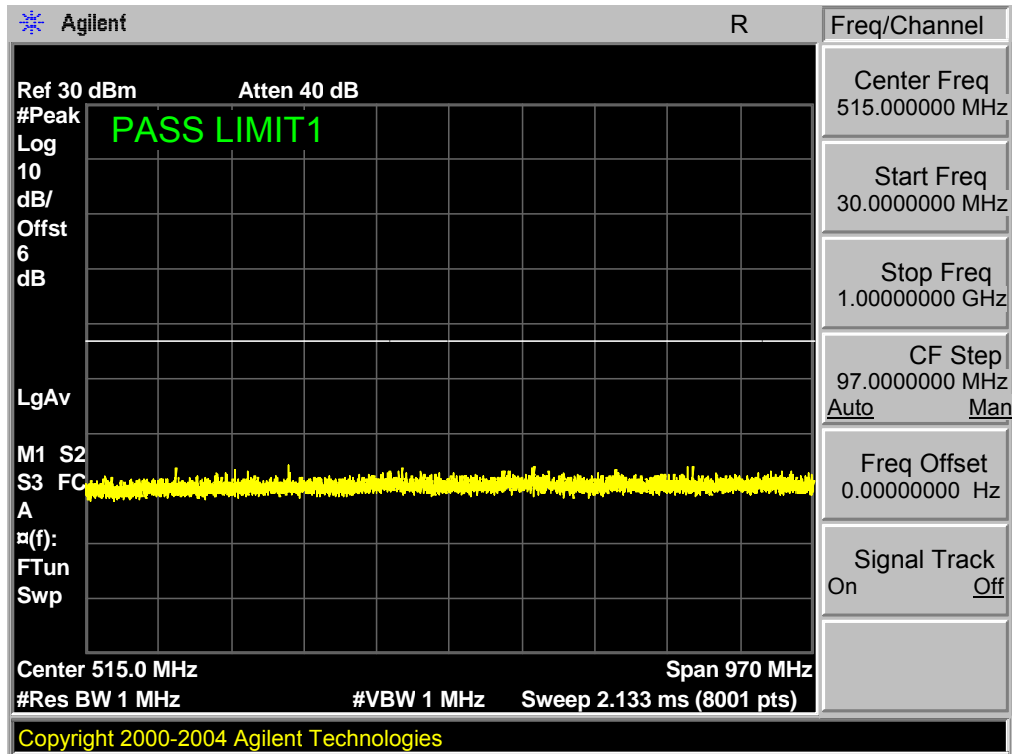

Band 7,UL Channel 21100,UL Frequency 2535.0,BW 10.0,NO. RB 1,RB POS. Low,QPSK

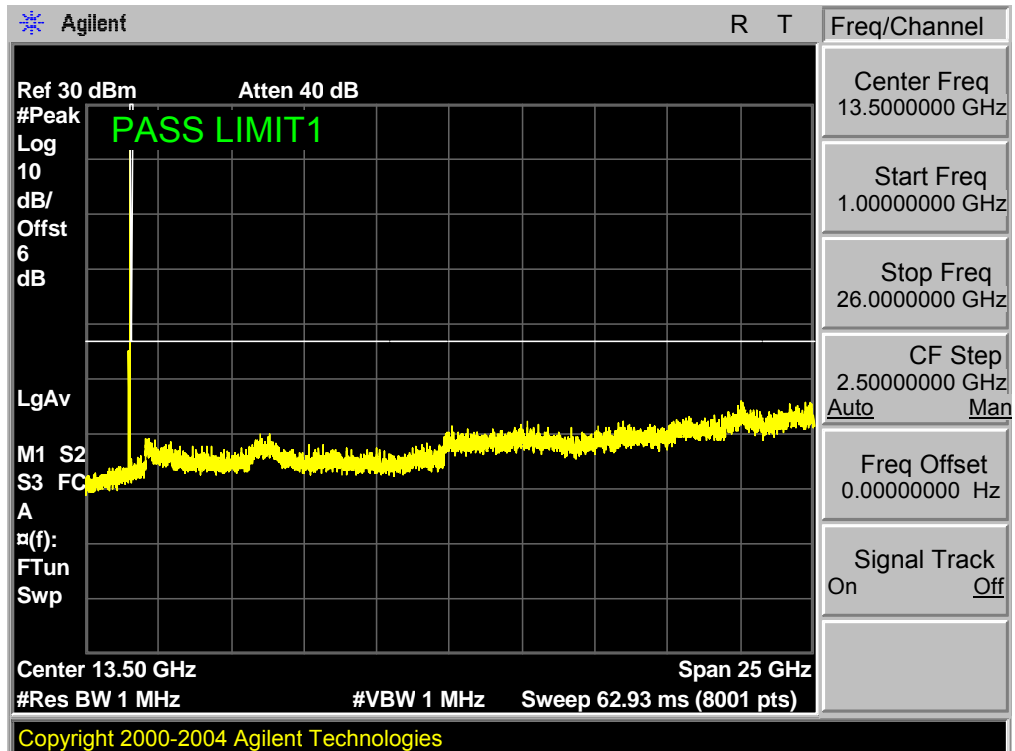

Band 7,UL Channel 21400,UL Frequency 2565.0,BW 10.0,NO. RB 1,RB POS. Low,QPSK

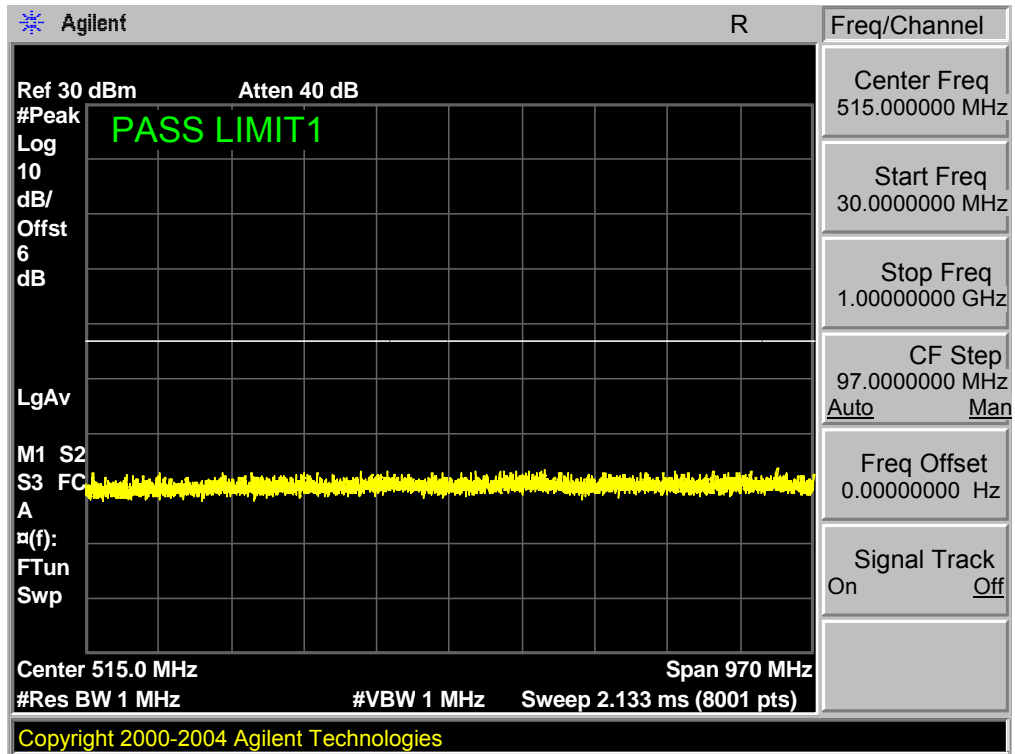

Band 7,UL Channel 21400,UL Frequency 2565.0,BW 10.0,NO. RB 1,RB POS. Low,QPSK

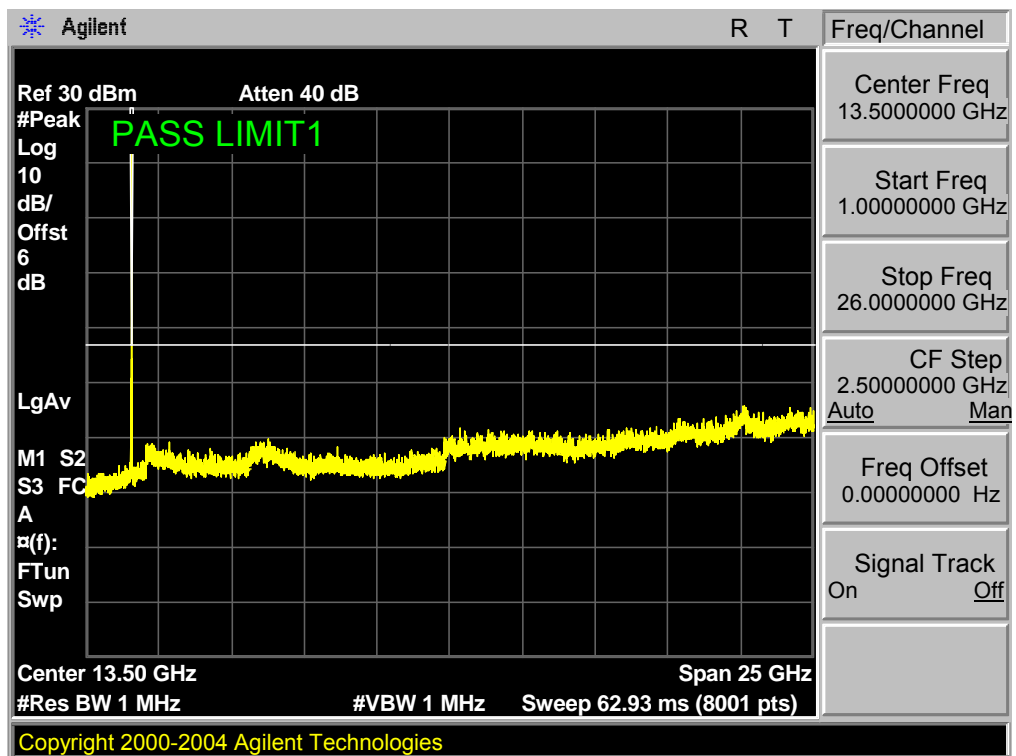

Band 7,UL Channel 20800,UL Frequency 2505.0,BW 10.0,NO. RB 1,RB POS. Low,16QAM

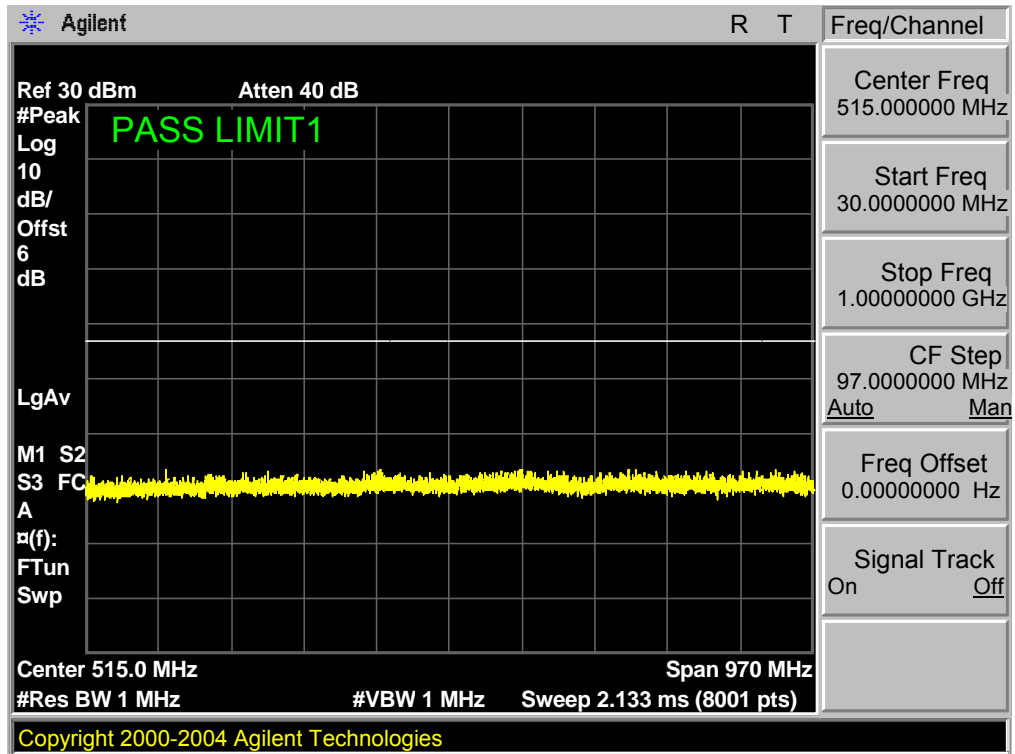

Band 7,UL Channel 20800,UL Frequency 2505.0,BW 10.0,NO. RB 1,RB POS. Low,16QAM

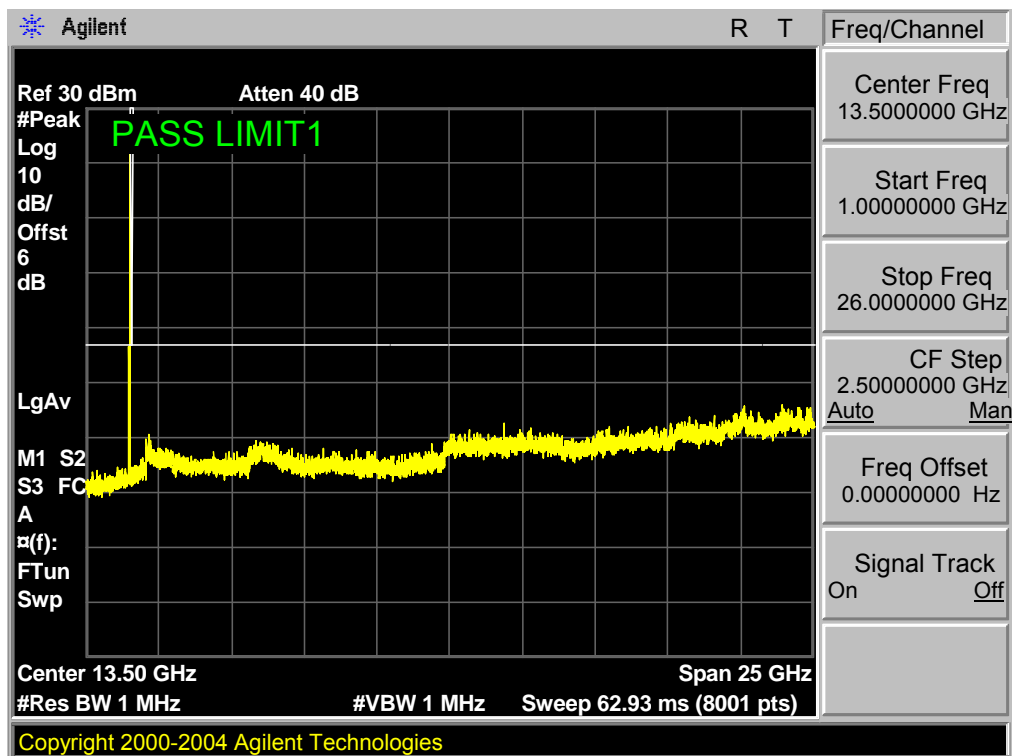

Band 7,UL Channel 21100,UL Frequency 2535.0,BW 10.0,NO. RB 1,RB POS. Low,16QAM

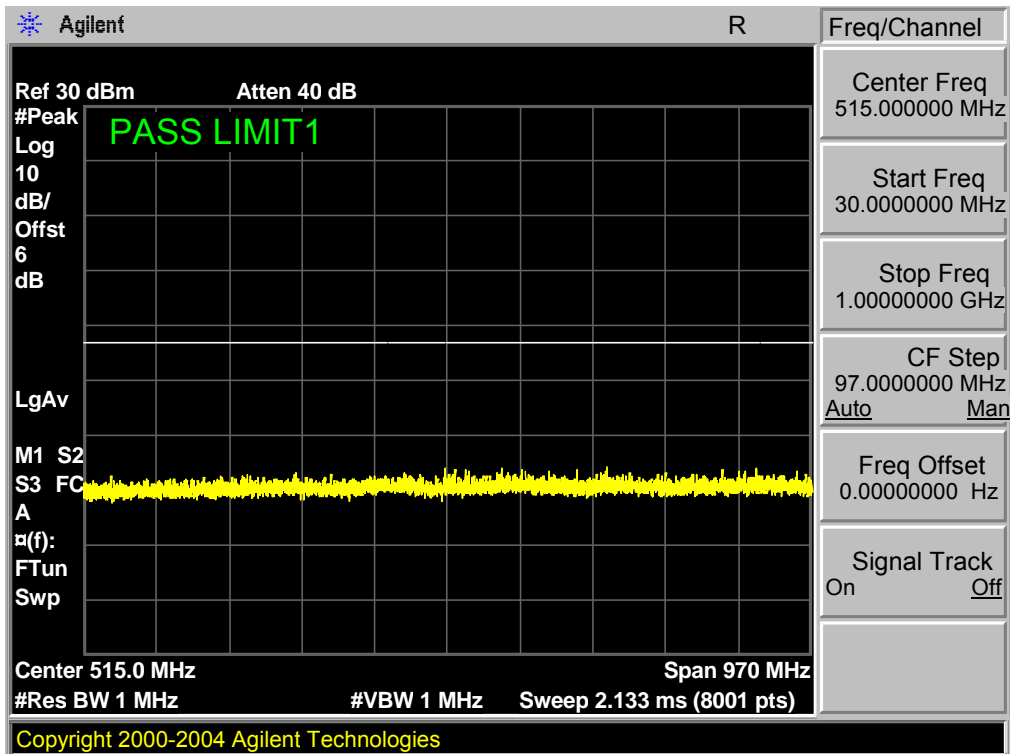

Band 7,UL Channel 21100,UL Frequency 2535.0,BW 10.0,NO. RB 1,RB POS. Low,16QAM

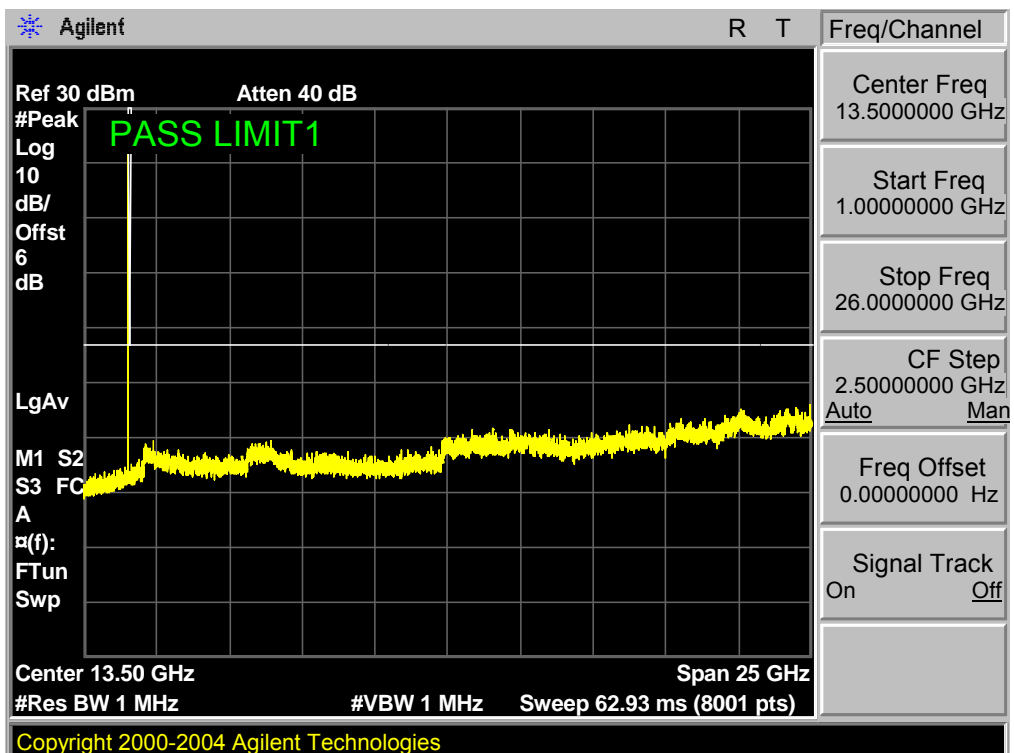

Band 7,UL Channel 21400,UL Frequency 2565.0,BW 10.0,NO. RB 1,RB POS. Low,16QAM

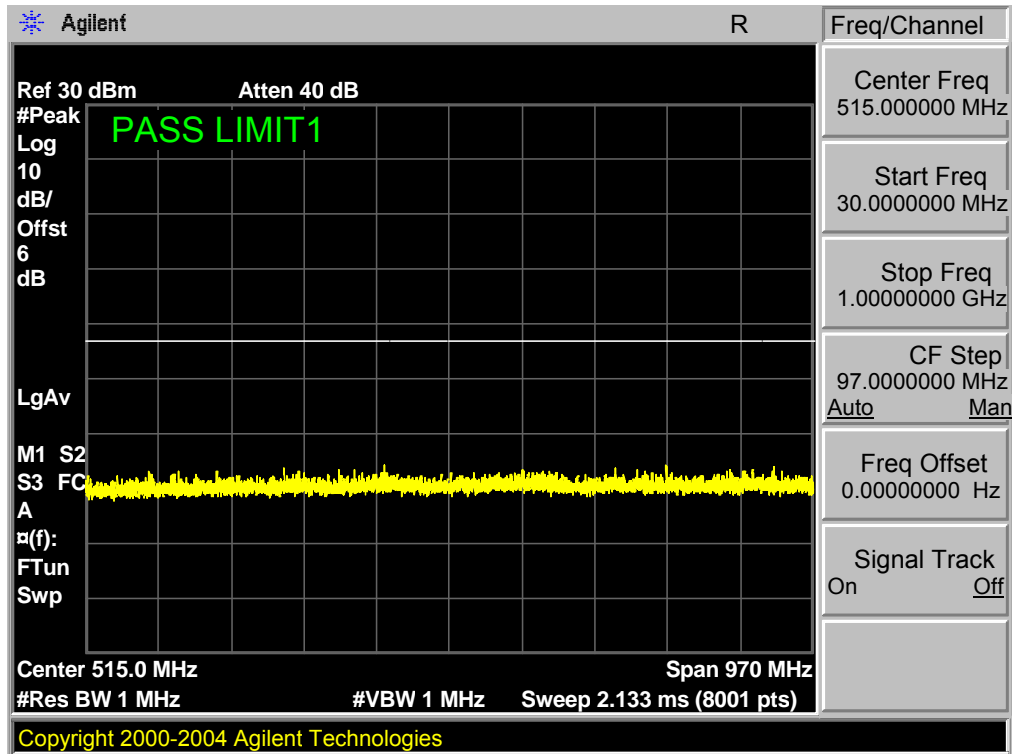

Band 7,UL Channel 21400,UL Frequency 2565.0,BW 10.0,NO. RB 1,RB POS. Low,16QAM

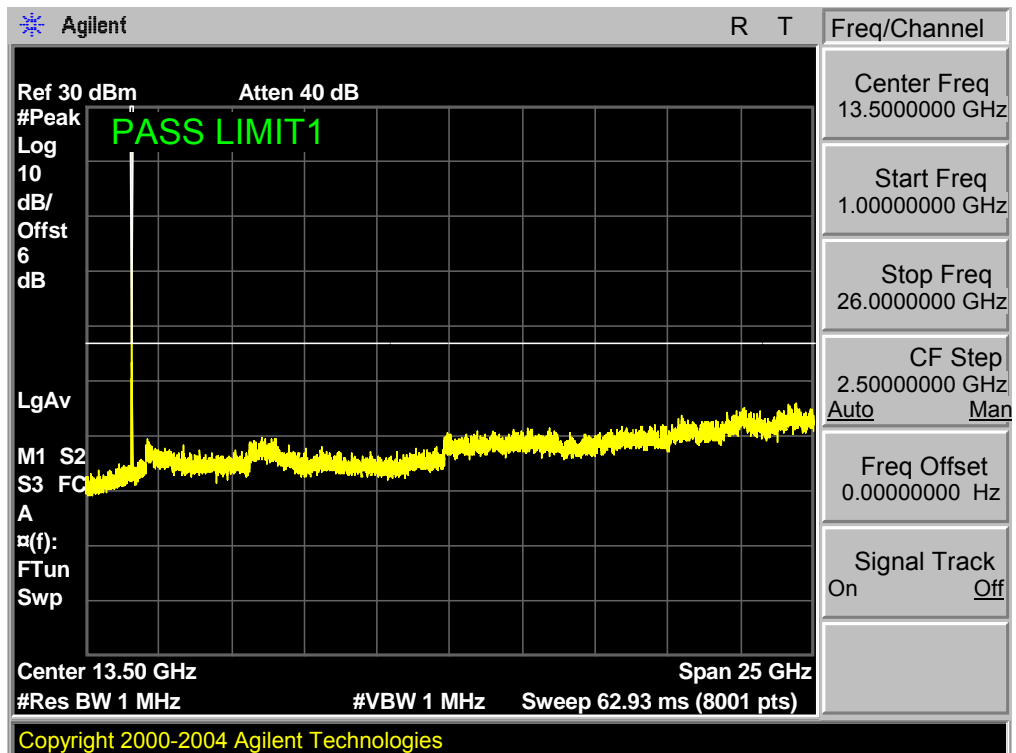

Band 7,UL Channel 20825,UL Frequency 2507.5,BW 15.0,NO. RB 1,RB POS. Low,QPSK

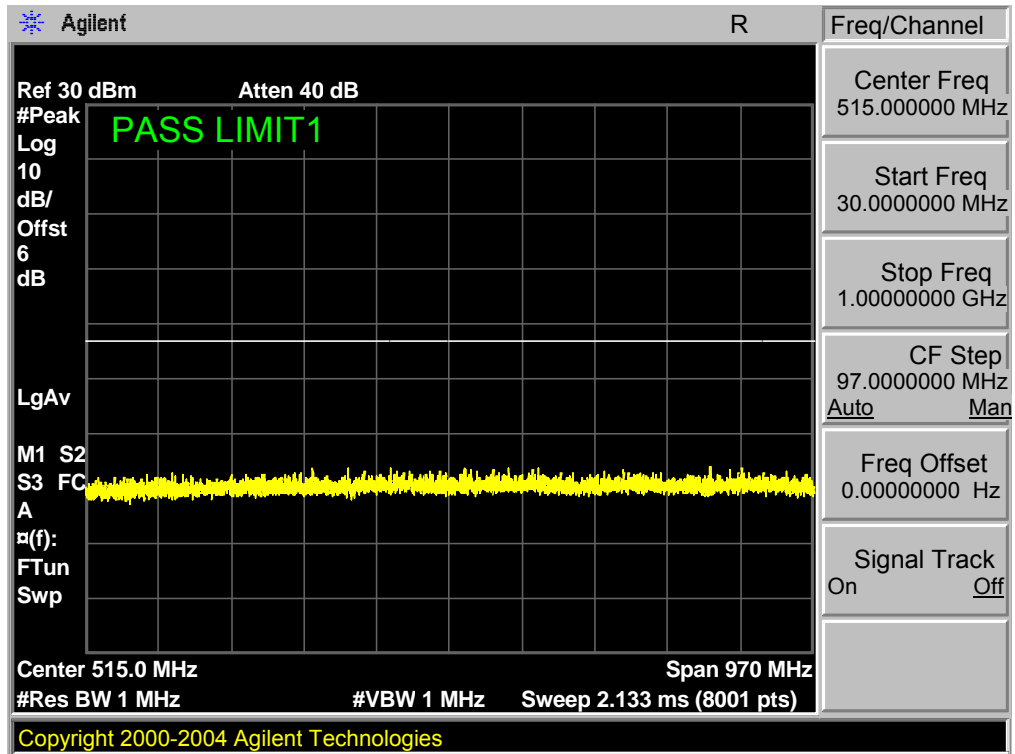

Band 7,UL Channel 20825,UL Frequency 2507.5,BW 15.0,NO. RB 1,RB POS. Low,QPSK

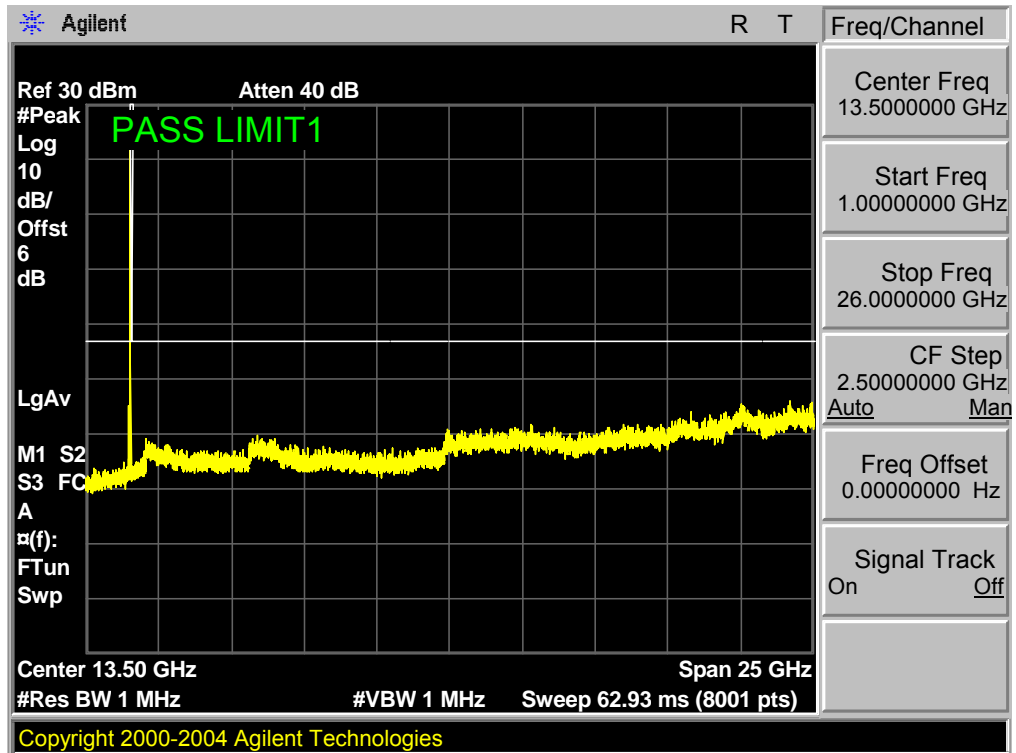

Band 7,UL Channel 21100,UL Frequency 2535.0,BW 15.0,NO. RB 1,RB POS. Low,QPSK

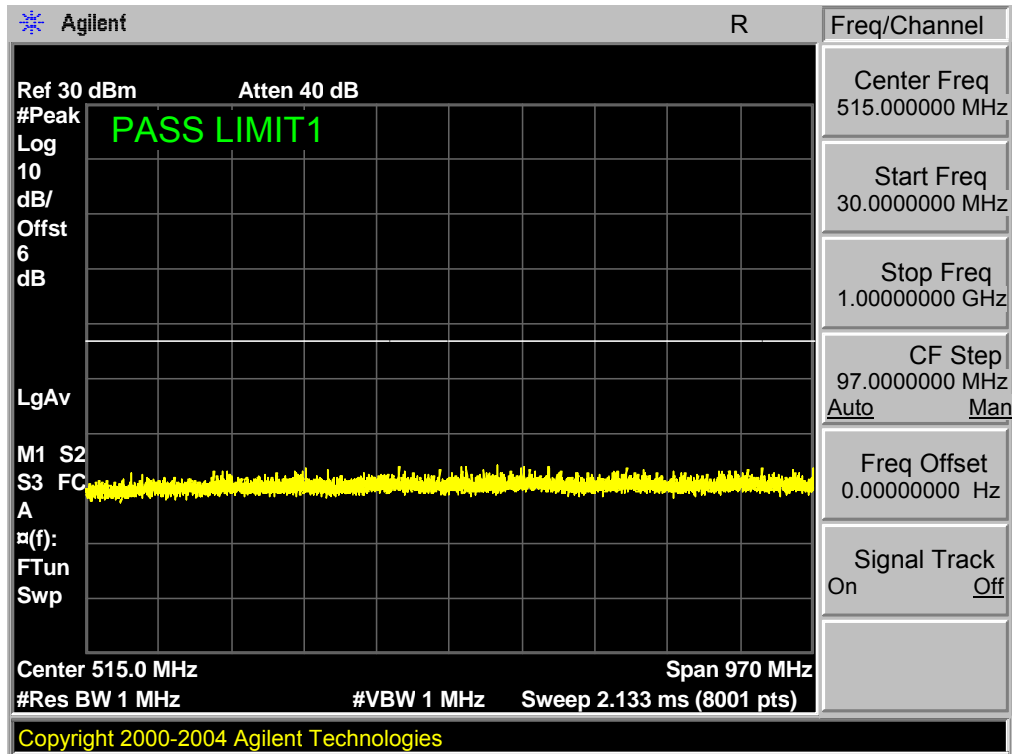

Band 7,UL Channel 21100,UL Frequency 2535.0,BW 15.0,NO. RB 1,RB POS. Low,QPSK

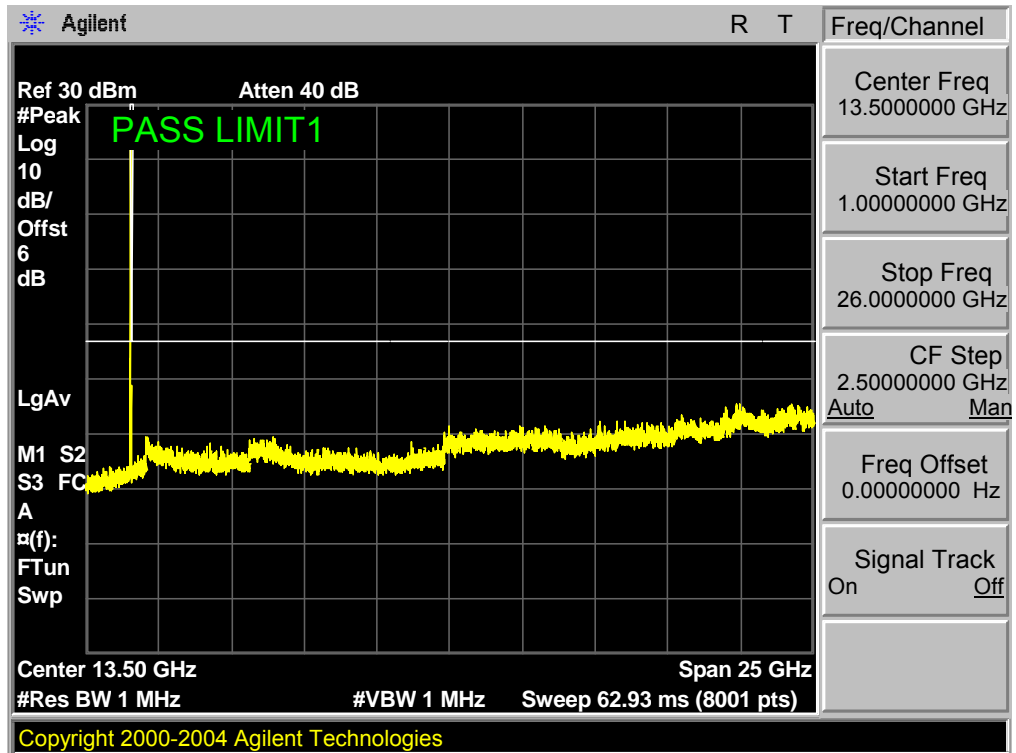

Band 7,UL Channel 21375,UL Frequency 2562.5,BW 15.0,NO. RB 1,RB POS. Low,QPSK

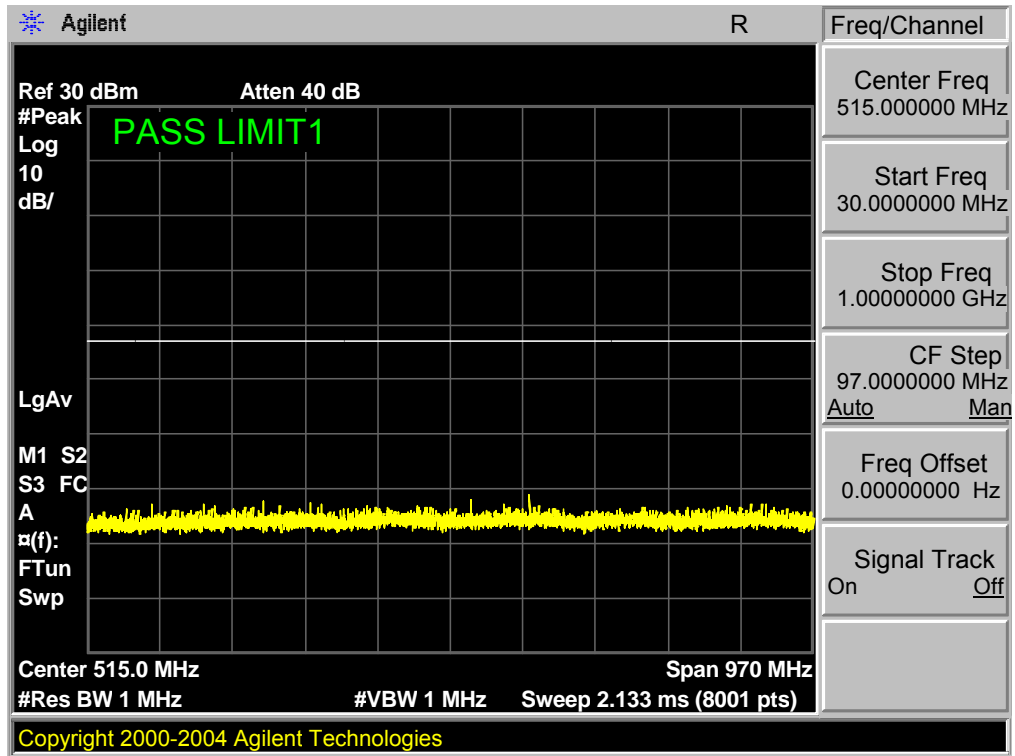

Band 7,UL Channel 21375,UL Frequency 2562.5,BW 15.0,NO. RB 1,RB POS. Low,QPSK

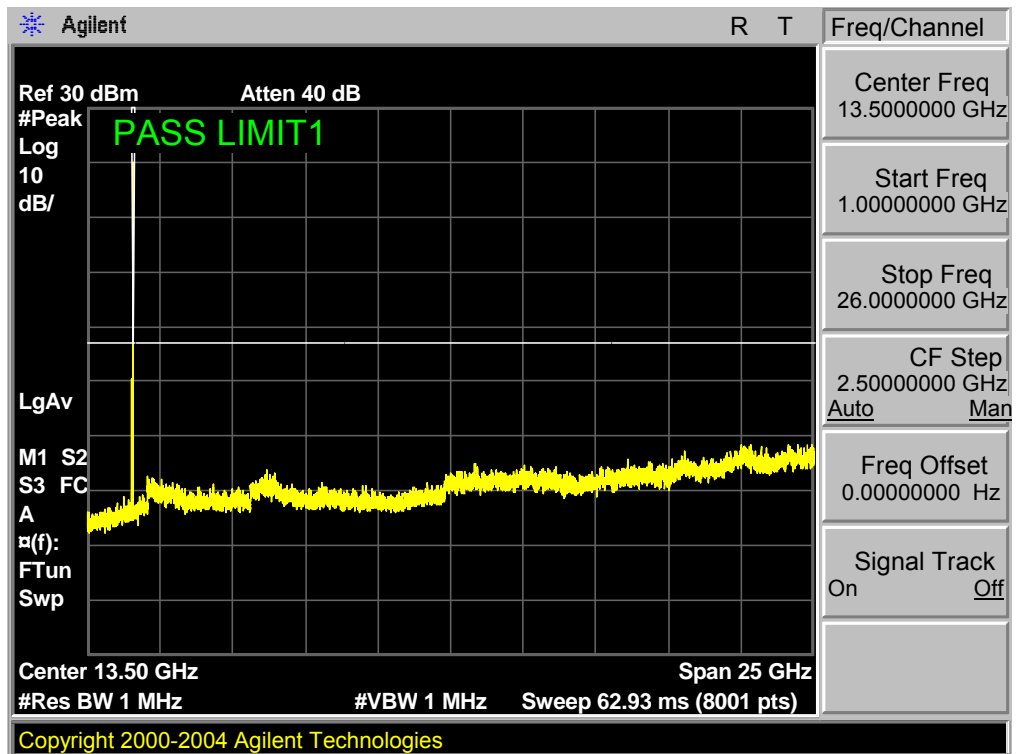

Band 7,UL Channel 20825,UL Frequency 2507.5,BW 15.0,NO. RB 1,RB POS. Low,16QAM

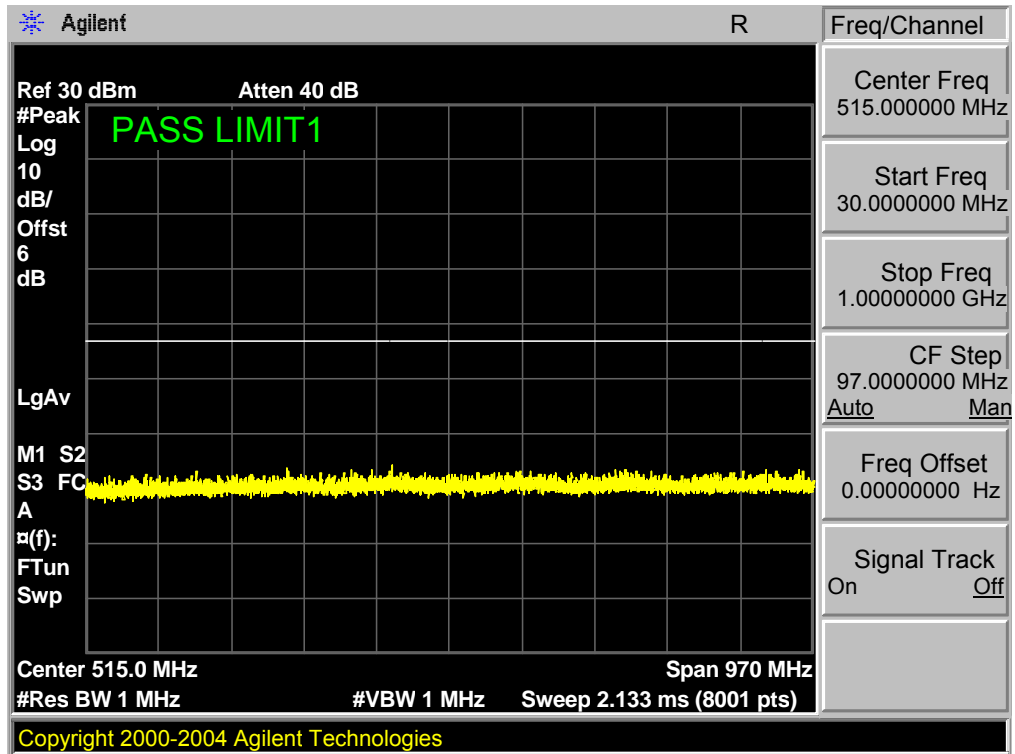

Band 7,UL Channel 20825,UL Frequency 2507.5,BW 15.0,NO. RB 1,RB POS. Low,16QAM

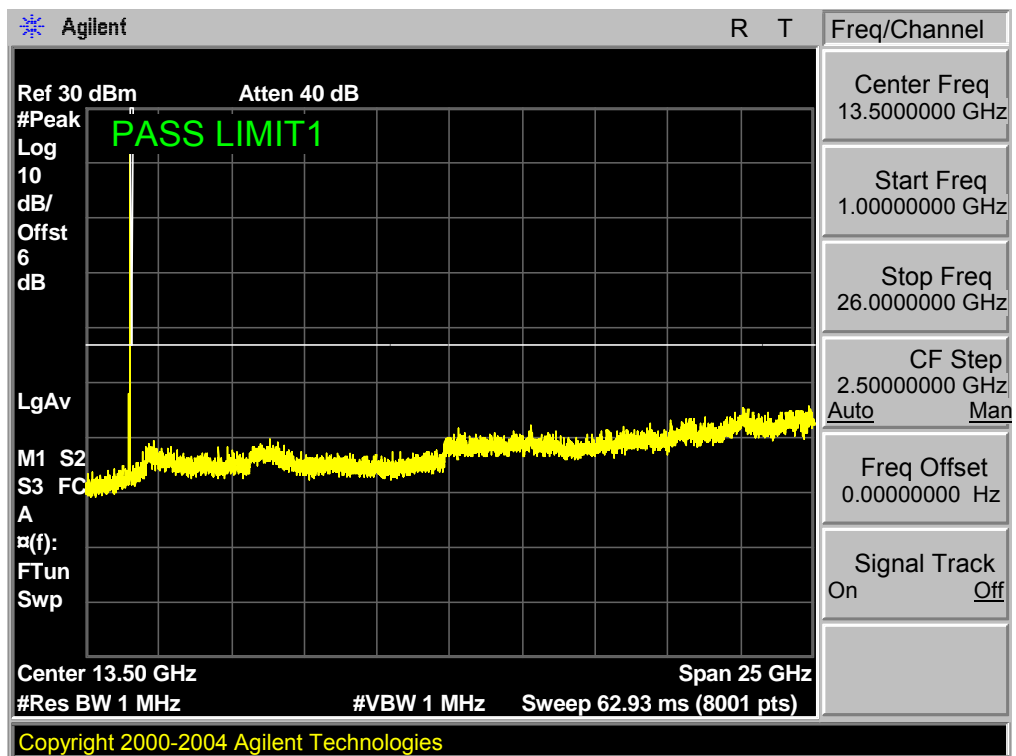

Band 7,UL Channel 21100,UL Frequency 2507.5,BW 15.0,NO. RB 1,RB POS. High,16QAM

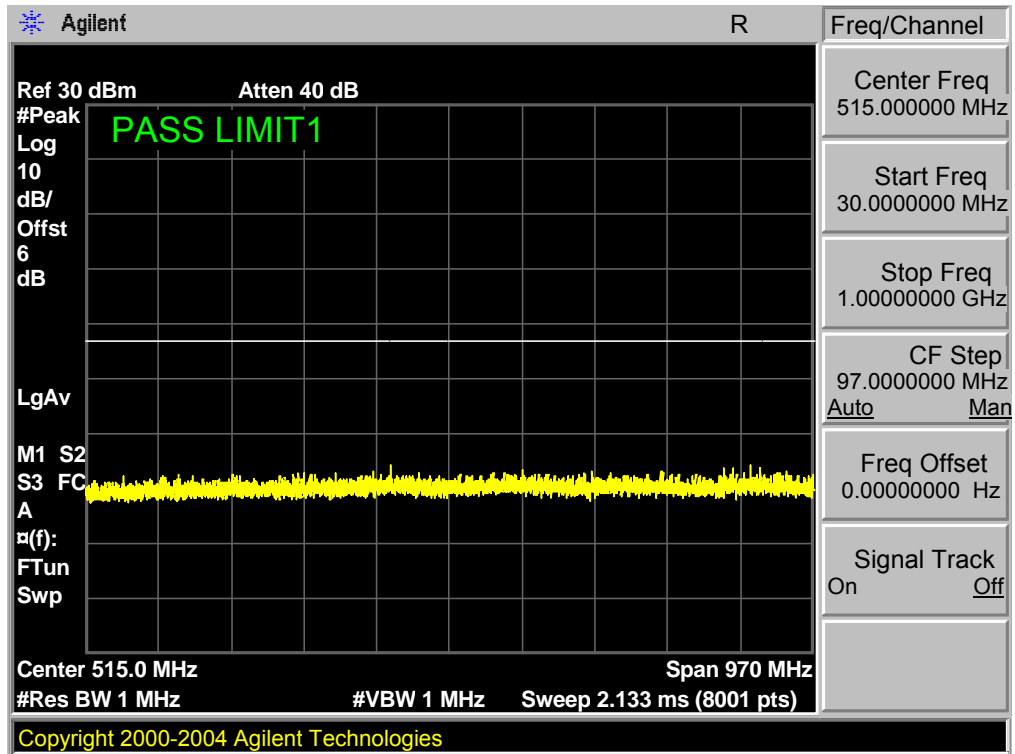

Band 7,UL Channel 21100,UL Frequency 2535.0,BW 15.0,NO. RB 1,RB POS. High,16QAM

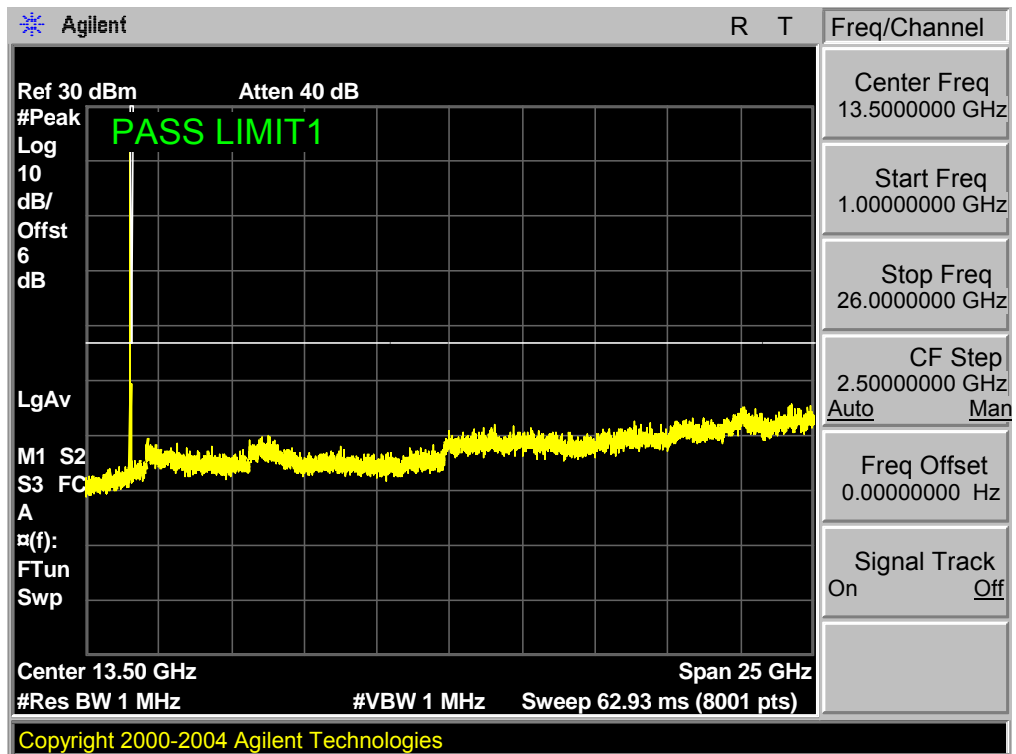

Band 7,UL Channel 21375,UL Frequency 2562.5,BW 15.0,NO. RB 1,RB POS. Low,16QAM

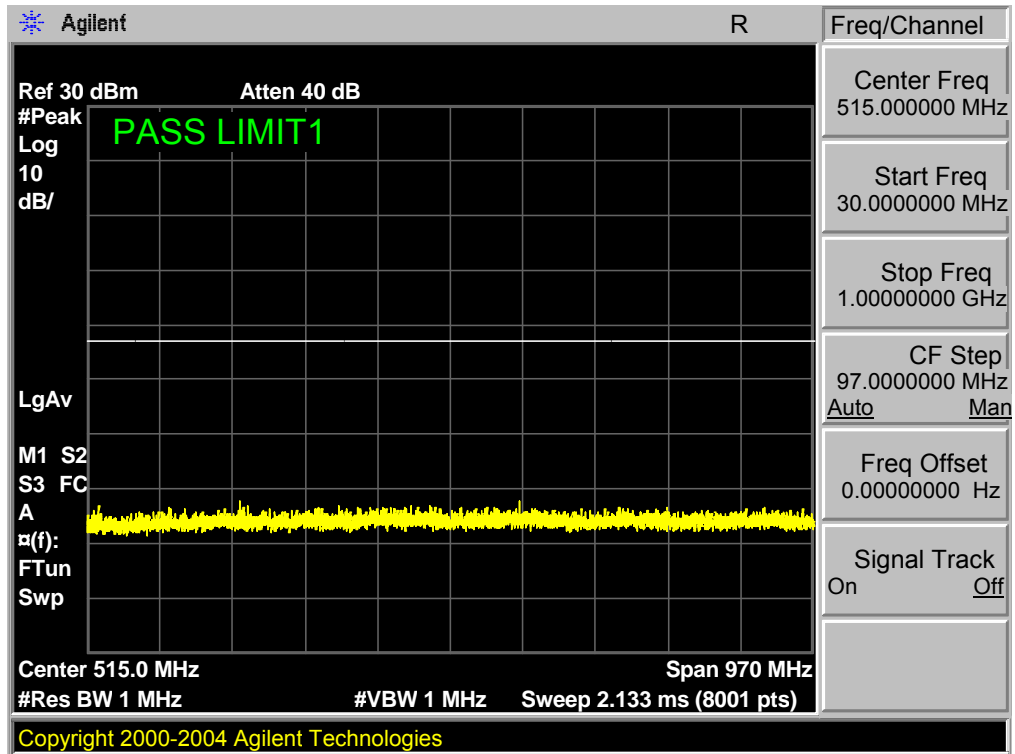

Band 7,UL Channel 21375,UL Frequency 2562.5,BW 15.0,NO. RB 1,RB POS. Low,16QAM

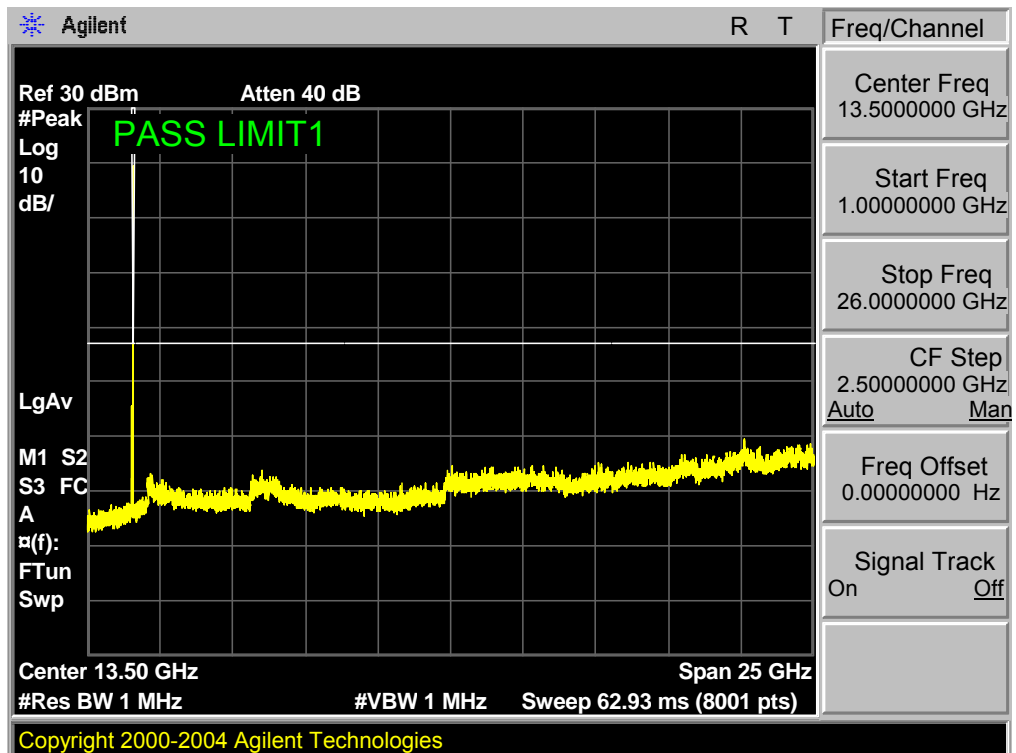

Band 7,UL Channel 20850,UL Frequency 2510.0,BW 20.0,NO. RB 1,RB POS. Low,QPSK

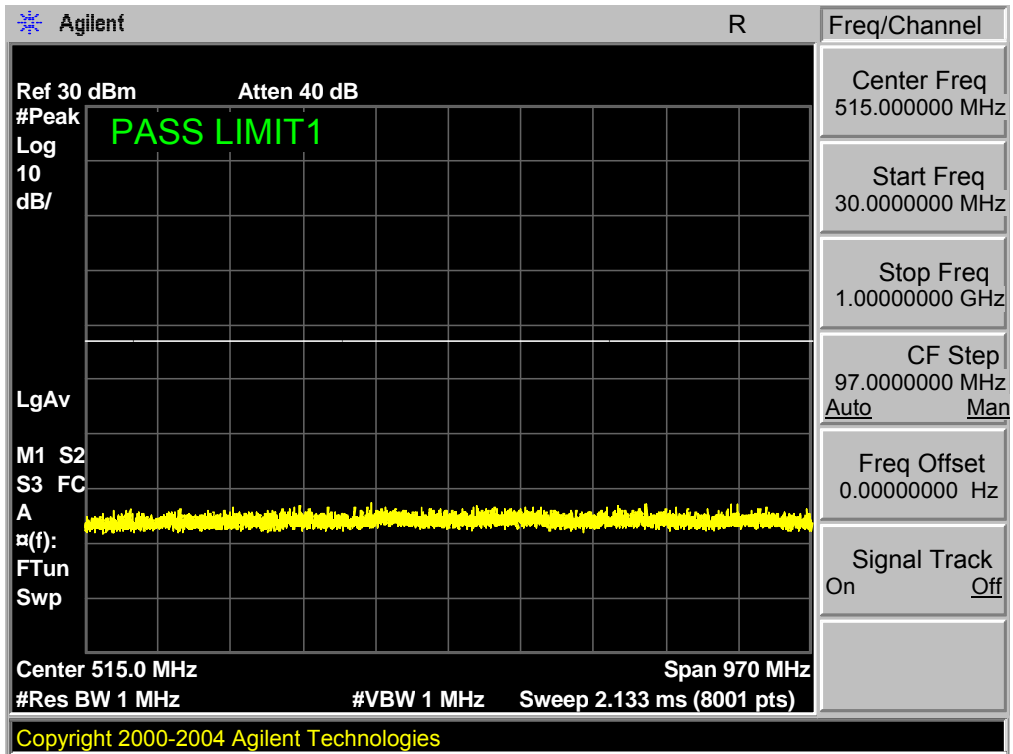

Band 7,UL Channel 20850,UL Frequency 2510.0,BW 20.0,NO. RB 1,RB POS. Low,QPSK

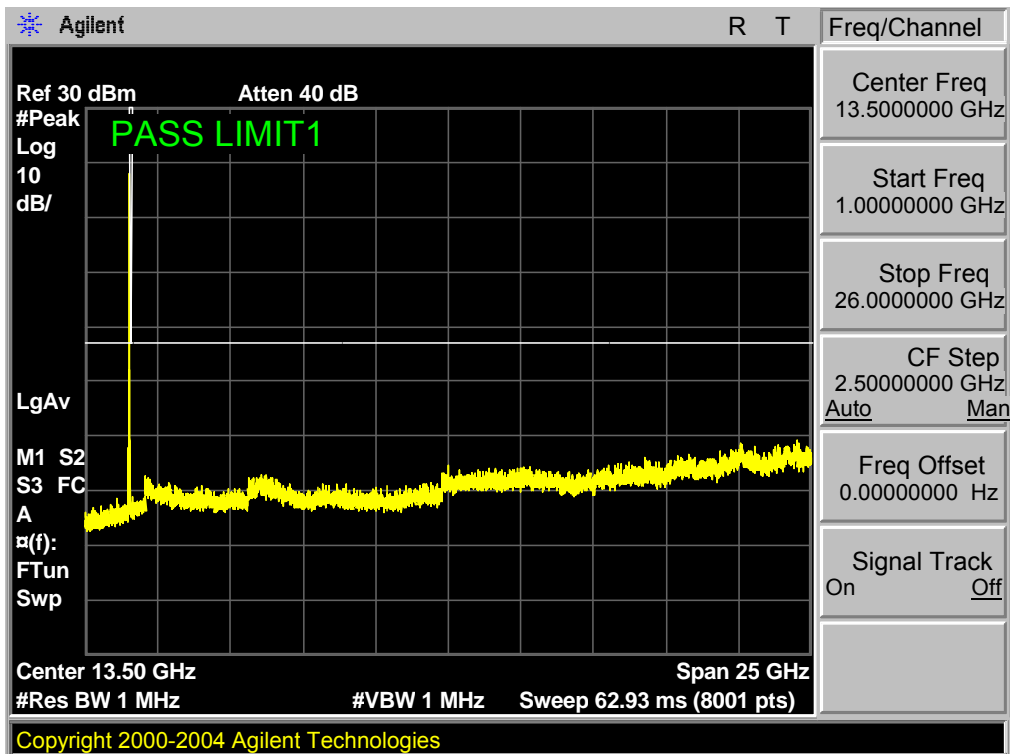

Band 7,UL Channel 21100,UL Frequency 2535.0,BW 20.0,NO. RB 1,RB POS. Low,QPSK

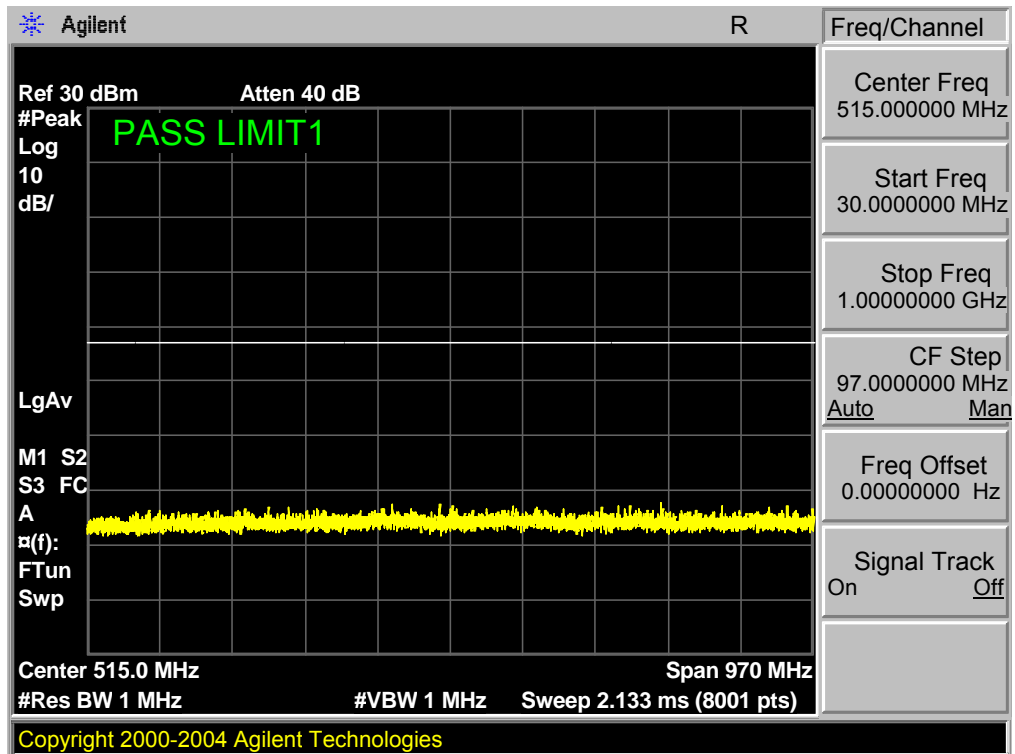

Band 7,UL Channel 21100,UL Frequency 2535.0,BW 20.0,NO. RB 1,RB POS. Low,QPSK

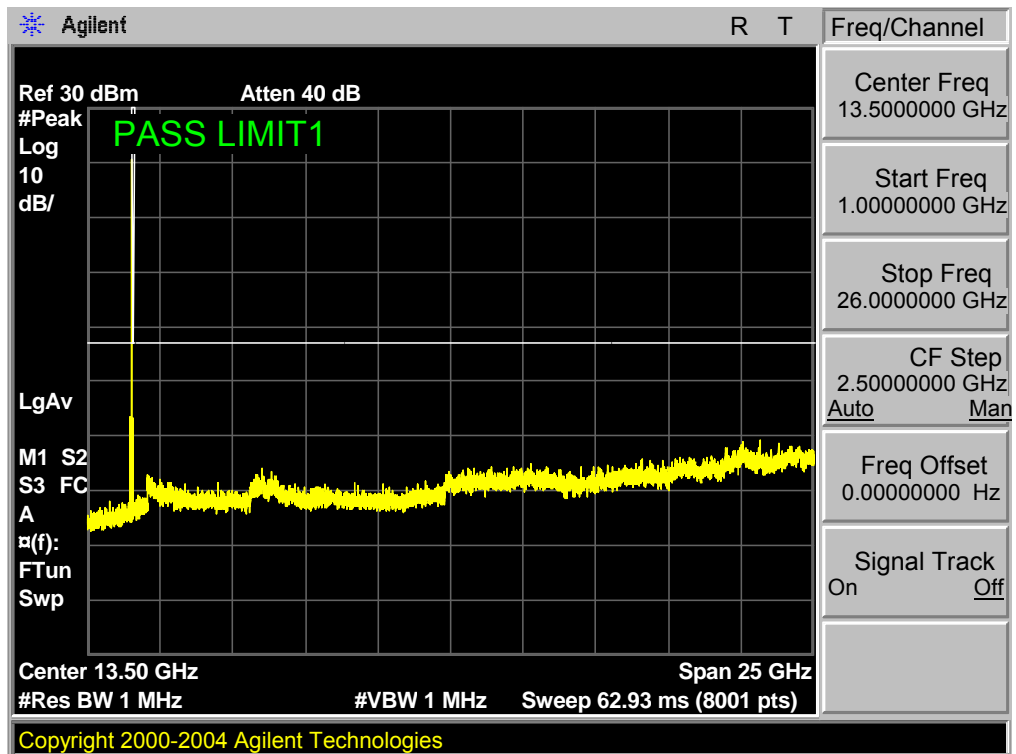

Band 7,UL Channel 21350,UL Frequency 2560.0,BW 20.0,NO. RB 1,RB POS. Low,QPSK

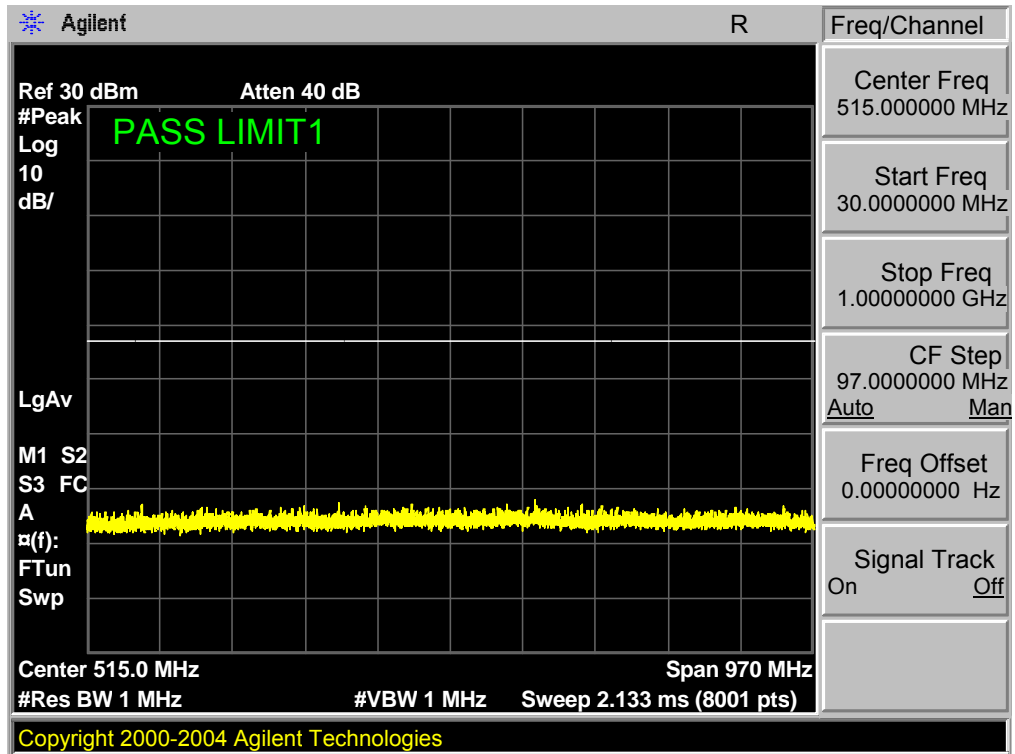

Band 7,UL Channel 21350,UL Frequency 2560.0,BW 20.0,NO. RB 1,RB POS. Low,QPSK

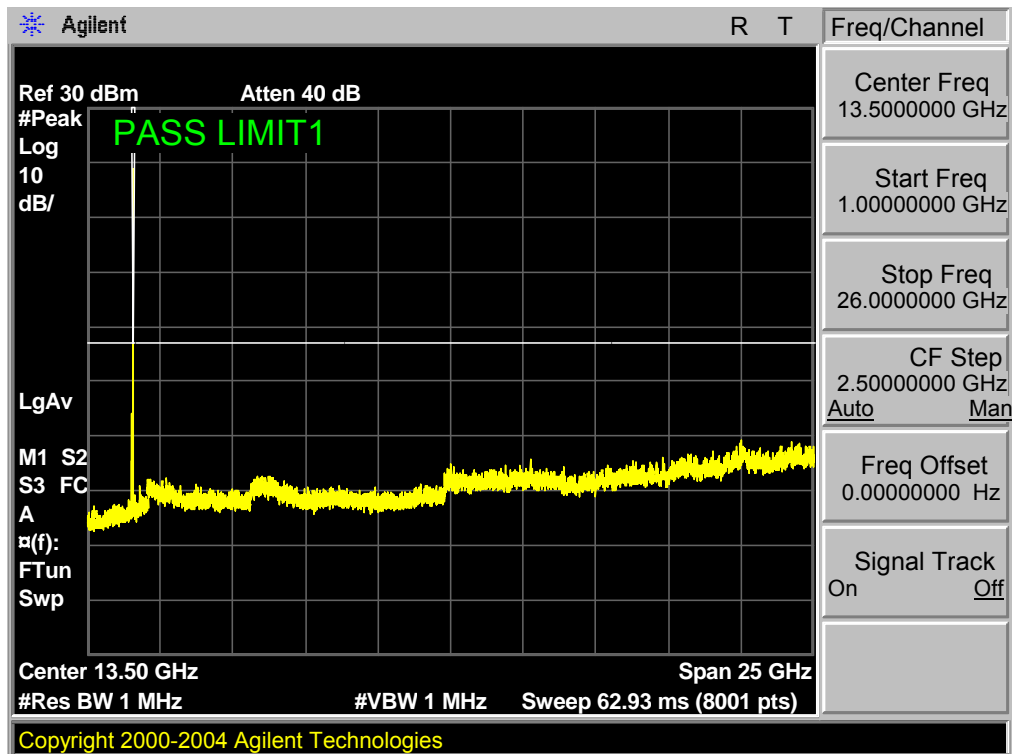

Band 7,UL Channel 20850,UL Frequency 2510.0,BW 20.0,NO. RB 1,RB POS. Low,16QAM

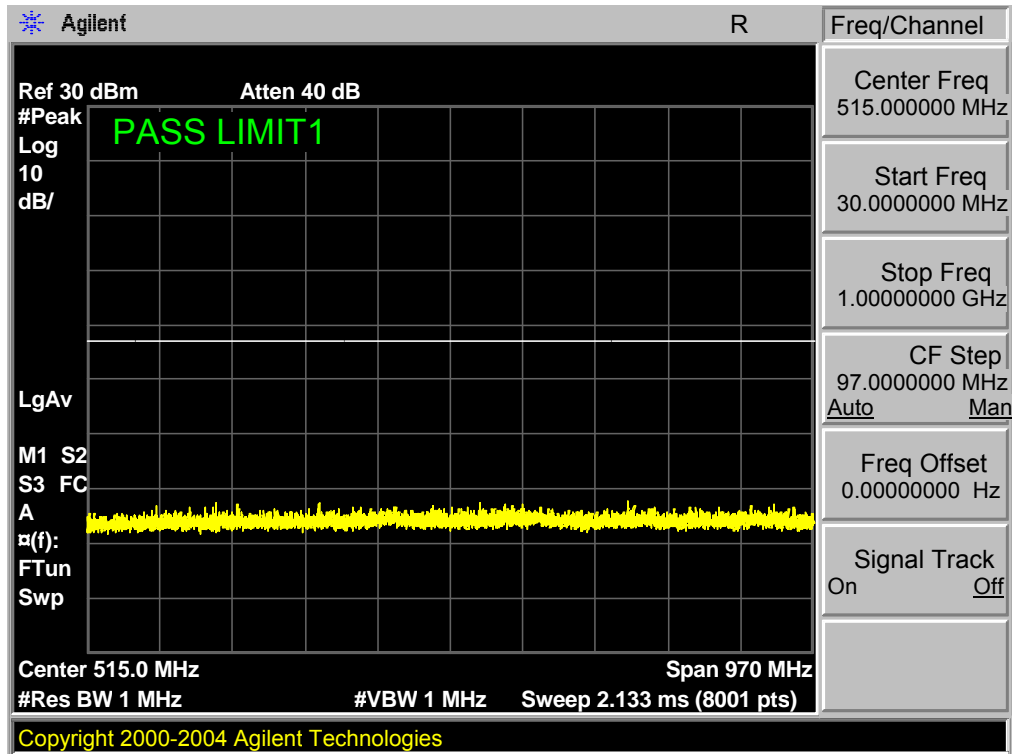

Band 7,UL Channel 20850,UL Frequency 2510.0,BW 20.0,NO. RB 1,RB POS. Low,16QAM

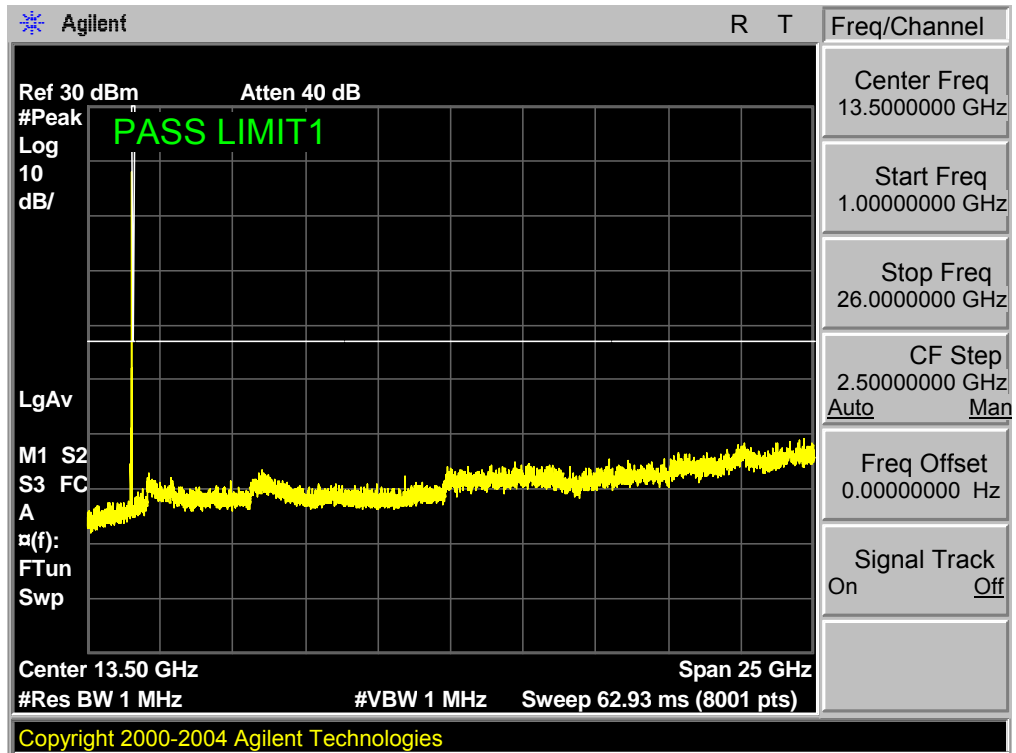

Band 7,UL Channel 21100,UL Frequency 2535.0,BW 20.0,NO. RB 1,RB POS. Low,16QAM

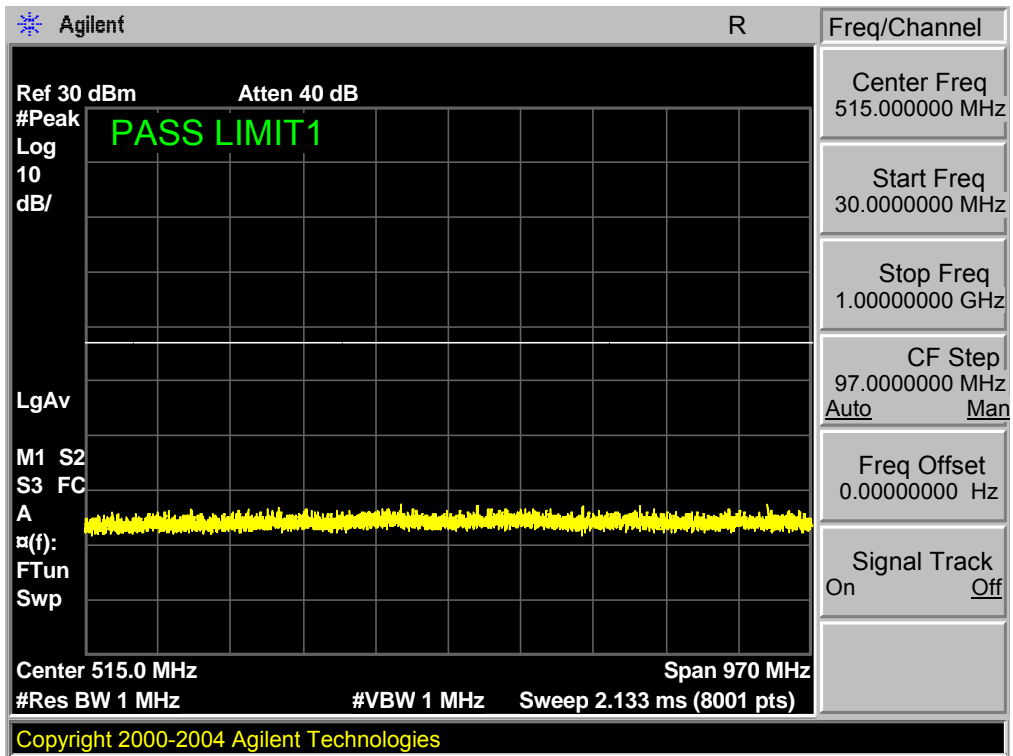

Band 7,UL Channel 21100,UL Frequency 2535.0,BW 20.0,NO. RB 1,RB POS. Low,16QAM

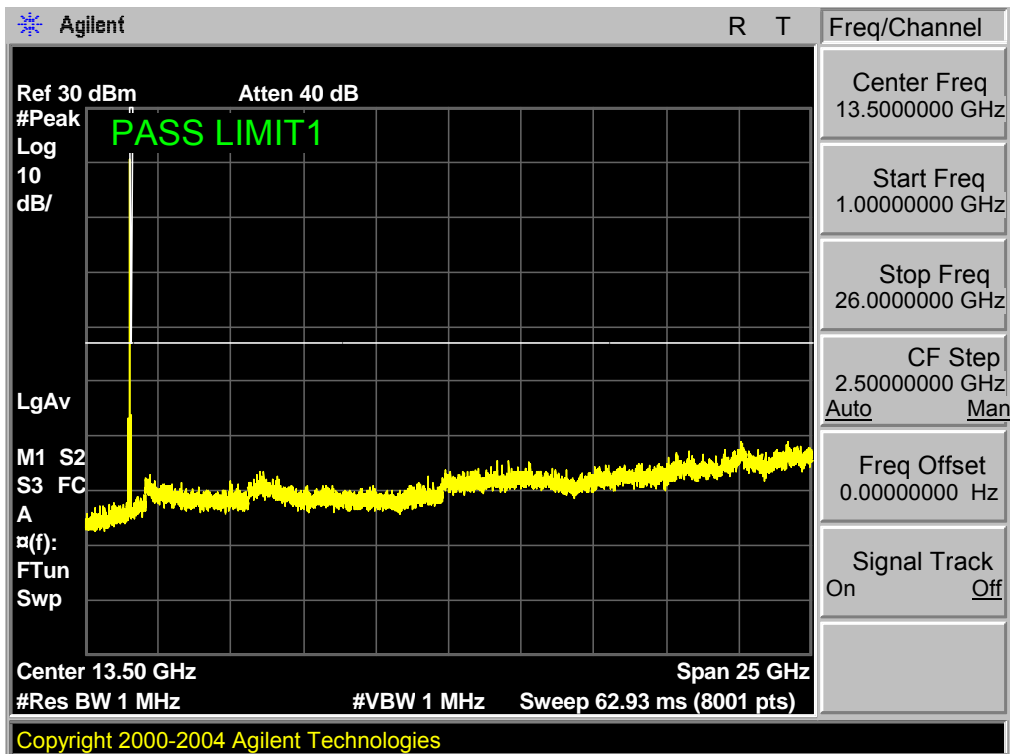

Band 7,UL Channel 21350,UL Frequency 2560.0,BW 20.0,NO. RB 1,RB POS. Low,16QAM

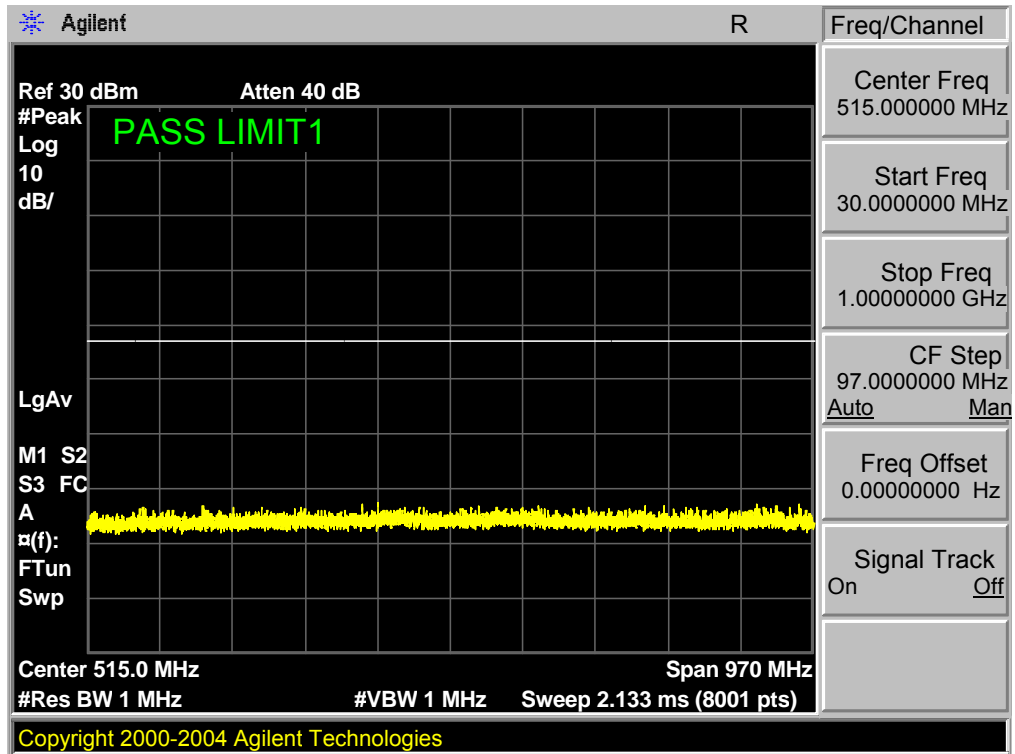

Band 7,UL Channel 21350,UL Frequency 2560.0,BW 20.0,NO. RB 1,RB POS. Low,16QAM

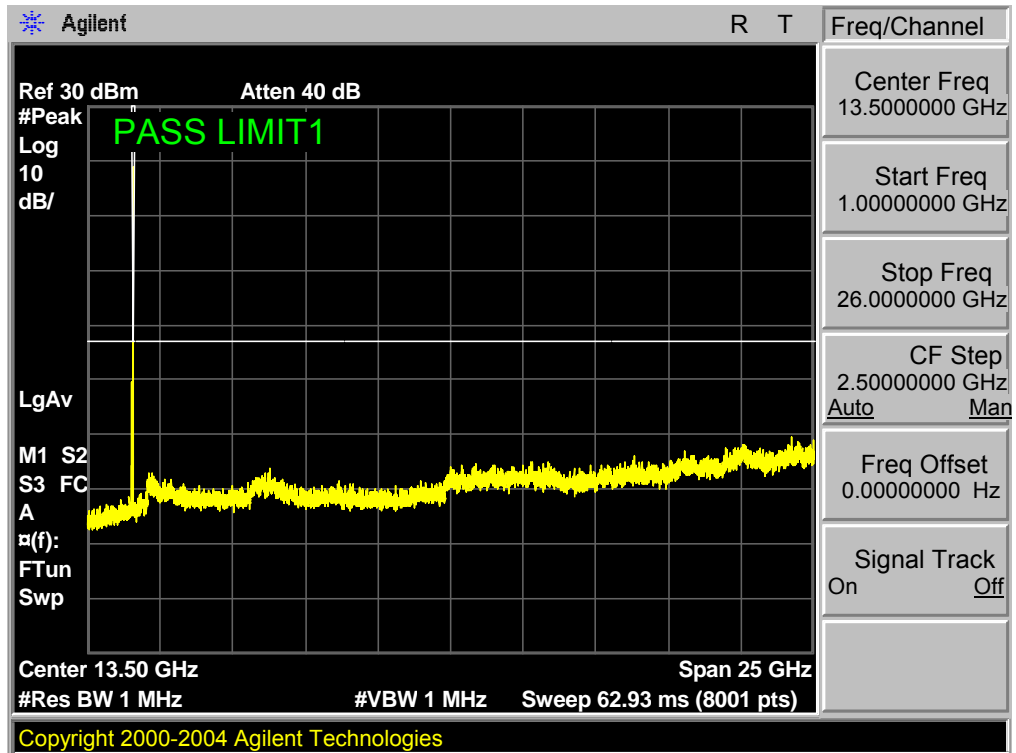

9. Radiated Spurious Emission

9.1. RADIATED POWER (ERP & EIRP)

RULE PART(S)

FCC: §2.1046, §27.50

LIMITS:

22.913(a) - The ERP of mobile transmitters and auxiliary test transmitters must not exceed 7 Watts.

27.50 (c) (10) the following power and antenna height requirements apply to stations transmitting in the 698–746 MHz band, the portable stations (hand-held devices) are limited to 3 watts ERP.

27.50 (b)(10) Portable stations (hand-held devices) transmitting in the 746–757 MHz, 758–763 MHz, 776–793 MHz, and 805–806 MHz bands are limited to 3 watts ERP.

27.50 (d)(4) The following power and antenna height requirements apply to stations transmitting in the 1710–1755 MHz and 2110–2155 MHz bands: Fixed, mobile, and portable (hand-held) stations operating in the 1710–1755 MHz band are limited to 1 watt EIRP.

TEST PROCEDURE

ANSI / TIA / EIA 603C Clause 2.2.17

KDB 971168 v02r01 RF power output using broadband peak and average power meter method.

KDB 971168 D01 Power Meas License Digital Systems v02r01, "Measurement Guidance for Certification of Licensed Digital Transmitters"

MODES TESTED

LTE Band 7

RESULTS

9.1.1 LTE BAND 7
EIRP POWER FOR LTE BAND 7 (5.0MHZ BANDWIDTH)

| Radiated Power (EIRP) for 5.0MHz Band | | | | | | |
|---------------------------------------|------------|-----------|-------------------------|------------------------|--------------------------|------------|
| Mode | RB/RB SIZE | Frequency | Result | | | Conclusion |
| | | | Max. EIRP Average (dBm) | Max. EIRP Average (mW) | Polarization Of Max. ERP | |
| 5.0MHz Band QPSK | 25/0 | 2502.5 | 23.15 | 206.54 | Horizontal | Pass |
| | | 2535.0 | 23.96 | 248.89 | Vertical | Pass |
| | | 2567.5 | 24.11 | 257.63 | Horizontal | Pass |
| 5.0MHz Band 16 QAM | 25/0 | 2502.5 | 24.54 | 284.45 | Vertical | Pass |
| | | 2535.0 | 23.27 | 212.32 | Horizontal | Pass |
| | | 2567.5 | 23.43 | 220.29 | Vertical | Pass |

EIRP POWER FOR LTE BAND 2 (10.0MHZ BANDWIDTH)

| Radiated Power (EIRP) for 10.0MHz Band | | | | | | |
|--|------------|-----------|-------------------------|------------------------|--------------------------|------------|
| Mode | RB/RB SIZE | Frequency | Result | | | Conclusion |
| | | | Max. EIRP Average (dBm) | Max. EIRP Average (mW) | Polarization Of Max. ERP | |
| 10.0MHz Band QPSK | 50/0 | 2505.5 | 24.14 | 259.42 | Horizontal | Pass |
| | | 2535.0 | 24.04 | 253.51 | Vertical | Pass |
| | | 2565.0 | 23.47 | 222.33 | Horizontal | Pass |
| 10.0MHz Band 16 QAM | 50/0 | 2505.5 | 24.16 | 260.62 | Vertical | Pass |
| | | 2535.0 | 23.24 | 210.86 | Horizontal | Pass |
| | | 2565.0 | 23.73 | 236.05 | Vertical | Pass |

EIRP POWER FOR LTE BAND 2 (15.0MHZ BANDWIDTH)

| Radiated Power (EIRP) for 15.0MHz Band | | | | | | |
|--|------------|-----------|-------------------------|------------------------|--------------------------|------------|
| Mode | RB/RB SIZE | Frequency | Result | | | Conclusion |
| | | | Max. EIRP Average (dBm) | Max. EIRP Average (mW) | Polarization Of Max. ERP | |
| 15.0MHz Band QPSK | 75/0 | 2507.5 | 24.31 | 269.77 | Horizontal | Pass |
| | | 2535.0 | 24.19 | 262.42 | Vertical | Pass |
| | | 2562.5 | 23.26 | 211.84 | Horizontal | Pass |
| 15.0MHz Band 16 QAM | 75/0 | 2507.5 | 24.42 | 276.69 | Vertical | Pass |
| | | 2535.0 | 23.24 | 210.86 | Horizontal | Pass |
| | | 2562.5 | 23.73 | 236.05 | Vertical | Pass |

EIRP POWER FOR LTE BAND 2 (20.0MHZ BANDWIDTH)

| Radiated Power (EIRP) for 20.0MHz Band | | | | | | |
|--|------------|-----------|-------------------------|------------------------|--------------------------|------------|
| Mode | RB/RB SIZE | Frequency | Result | | | Conclusion |
| | | | Max. EIRP Average (dBm) | Max. EIRP Average (mW) | Polarization Of Max. ERP | |
| 20.0MHz Band QPSK | 100/0 | 2510.0 | 24.13 | 258.82 | Horizontal | Pass |
| | | 2535.0 | 23.27 | 212.32 | Vertical | Pass |
| | | 2560.0 | 23.33 | 215.28 | Horizontal | Pass |
| 20.0MHz Band 16 QAM | 100/0 | 2510.0 | 24.11 | 257.63 | Vertical | Pass |
| | | 2535.0 | 23.26 | 211.84 | Horizontal | Pass |
| | | 2560.0 | 23.23 | 210.38 | Vertical | Pass |

10.0 FIELD STRENGTH OF SPURIOUS RADIATION

RULE PART(S)

FCC: §2.1053, §27.53

LIMIT

§22.917 (e) and §24.238 (a): Out of band emissions. The power of any emission outside of the authorized operating frequency ranges must be attenuated below the transmitting power (P) by a factor of at least $43 + 10 \log (P)$ dB.

§27.53 (g) For operations in the 698–746 MHz band, the power of any emission outside a licensee's frequency band(s) of operation shall be attenuated below the transmitter power (P) within the licensed band(s) of operation, measured in watts, by at least $43 + 10 \log (P)$ dB.

§27.53 (h) For operations in the 1710–1755 MHz and 2110–2155 MHz bands, the power of any emission outside a licensee's frequency block shall be attenuated below the transmitter power (P) by at least $43 + 10 \log_{10}(P)$ dB.

TEST PROCEDURE

For Cellular equipment - Compliance with these rules is based on the use of measurement instrumentation employing a resolution bandwidth of 100 kHz or greater. In the 1 MHz bands immediately outside and adjacent to the frequency block a resolution bandwidth of at least one percent of the emission bandwidth of the fundamental emission of the transmitter may be employed. A narrower resolution bandwidth is permitted in all cases to improve measurement accuracy provided the measured power is integrated over the full required measurement bandwidth (i.e. 100 kHz or 1 percent of emission bandwidth, as specified). The emission bandwidth is defined as the width of the signal between two points, one below the carrier center frequency and one above the carrier center frequency, outside of which all emissions are attenuated at least 26 dB below the transmitter power.

For PCS equipment - Compliance with these rules is based on the use of measurement instrumentation employing a resolution bandwidth of 1 MHz or greater. However, in the 1 MHz bands immediately outside and adjacent to the frequency block a resolution bandwidth of at least one percent of the emission bandwidth of the fundamental emission of the transmitter may be employed. A narrower resolution bandwidth is permitted in all cases to improve measurement accuracy provided the measured power is integrated over the full required measurement bandwidth (i.e. 1 MHz or 1 percent of emission bandwidth, as specified). The emission bandwidth is defined as the width of the signal between two points, one below the carrier center frequency and one above the carrier center frequency, outside of which all emissions are attenuated at least 26 dB below the transmitter power.

The unwanted emission power shall be measured with a resolution bandwidth of at least 1% of the occupied bandwidth in the 1 MHz band immediately outside and adjacent to the channel edge of the equipment. Beyond the 1 MHz band immediately outside the channel edge of the equipment, a resolution bandwidth of 1 MHz shall be employed. A narrower resolution bandwidth is allowed to be used provided that the measured power is integrated over the full required measurement bandwidth of 1 MHz or 1% of the occupied bandwidth as applicable.

The power of any unwanted emissions measured from the channel edge of the equipment shall be attenuated below the transmitter power, P (dBW), as follows:

- a. for base station and subscriber equipment, other than mobile subscriber equipment, the attenuation shall not be less than $43 + 10 \text{ Log}_{10} (p)$, dB; and
- b. for mobile subscriber equipment, the attenuation shall not be less than $43 + 10 \text{ Log}_{10} (p)$, dB at the channel edges and $55 + 10 \text{ Log}_{10} (p)$ at 5.5 MHz away and beyond the channel edges where p in (a) and (b) is the transmitter power measured in watts.

MODES TESTED

LTE Band 7

RESULTS

10.1.1. LTE BAND 7
QPSK EIRP POWER FOR LTE BAND 7 (5.0MHZ BANDWIDTH)

| Test Results for Low Channel 2502.5MHz | | | | | |
|--|------------|------------------------|------------------------|-------------|------------|
| Frequency(MHz) | Power(dBm) | A _{Rpl} (dBm) | P _{Mea} (dBm) | Limit (dBm) | Polarity |
| 5005.0 | -42.31 | 13.42 | -28.89 | -13.00 | Vertical |
| 5005.0 | -33.18 | 13.42 | -19.76 | -13.00 | Horizontal |
| 7507.5 | -33.67 | 17.12 | -16.55 | -13.00 | Vertical |
| 7507.5 | -34.27 | 17.12 | -17.15 | -13.00 | Horizontal |
| 10010.0 | -39.26 | 19.26 | -20.00 | -13.00 | Horizontal |
| 10010.0 | -33.39 | 19.26 | -14.13 | -13.00 | Vertical |
| Test Results for Mid Channel 2535.0MHz | | | | | |
| 5070.0 | -39.16 | 13.76 | -25.4 | -13.00 | Vertical |
| 5070.0 | -34.72 | 13.76 | -20.96 | -13.00 | Horizontal |
| 7605.0 | -38.32 | 17.56 | -20.76 | -13.00 | Vertical |
| 7605.0 | -37.16 | 17.56 | -19.6 | -13.00 | Horizontal |
| 10140.0 | -36.74 | 19.6 | -17.14 | -13.00 | Horizontal |
| 10140.0 | -38.26 | 19.6 | -18.66 | -13.00 | Vertical |
| Test Results for High Channel 2567.5MHz | | | | | |
| 5135.0 | -39.03 | 13.87 | -25.16 | -13.00 | Vertical |
| 5135.0 | -36.48 | 13.87 | -22.61 | -13.00 | Horizontal |
| 7702.5 | -37.64 | 17.66 | -19.98 | -13.00 | Vertical |
| 7702.5 | -35.47 | 17.66 | -17.81 | -13.00 | Horizontal |
| 10270.0 | -41.68 | 19.75 | -21.93 | -13.00 | Horizontal |
| 10270.0 | -40.37 | 19.75 | -20.62 | -13.00 | Vertical |

QPSK EIRP POWER FOR LTE BAND 7 (10.0MHZ BANDWIDTH)

| Test Results for Low Channel 2505.0MHz | | | | | |
|--|------------|------------------------|------------------------|-------------|------------|
| Frequency(MHz) | Power(dBm) | A _{Rpl} (dBm) | P _{Mea} (dBm) | Limit (dBm) | Polarity |
| 5010.0 | -42.36 | 13.42 | -28.94 | -13.00 | Horizontal |
| 5010.0 | -33.87 | 13.42 | -20.45 | -13.00 | Vertical |
| 7515.0 | -34.75 | 17.12 | -17.63 | -13.00 | Vertical |
| 7515.0 | -36.36 | 17.12 | -19.24 | -13.00 | Horizontal |
| 10020.0 | -35.79 | 19.26 | -16.53 | -13.00 | Horizontal |
| 10020.0 | -36.12 | 19.26 | -16.86 | -13.00 | Vertical |
| Test Results for Mid Channel 2535.0MHz | | | | | |
| 5070.0 | -32.65 | 13.76 | -18.89 | -13.00 | Horizontal |
| 5070.0 | -35.98 | 13.76 | -22.22 | -13.00 | Vertical |
| 7605.0 | -35.64 | 17.56 | -18.08 | -13.00 | Vertical |
| 7605.0 | -44.12 | 17.56 | -26.56 | -13.00 | Horizontal |
| 10140.0 | -38.83 | 19.6 | -19.23 | -13.00 | Horizontal |
| 10140.0 | -37.49 | 19.6 | -17.89 | -13.00 | Vertical |
| Test Results for High Channel 2565.0MHz | | | | | |
| 5130.0 | -34.12 | 13.87 | -20.25 | -13.00 | Horizontal |
| 5130.0 | -35.39 | 13.87 | -21.52 | -13.00 | Vertical |
| 7695.0 | -39.83 | 17.66 | -22.17 | -13.00 | Vertical |
| 7695.0 | -37.53 | 17.66 | -19.87 | -13.00 | Horizontal |
| 10260.0 | -39.83 | 19.75 | -20.08 | -13.00 | Horizontal |
| 10260.0 | -36.77 | 19.75 | -17.02 | -13.00 | Vertical |

QPSK EIRP POWER FOR LTE BAND 7 (15.0MHZ BANDWIDTH)

| Test Results for Low Channel 2507.5MHz | | | | | |
|--|------------|------------------------|------------------------|-------------|------------|
| Frequency(MHz) | Power(dBm) | A _{Rpl} (dBm) | P _{Mea} (dBm) | Limit (dBm) | Polarity |
| 5015.0 | -37.24 | 13.42 | -23.82 | -13 | Horizontal |
| 5015.0 | -36.17 | 13.42 | -22.75 | -13 | Vertical |
| 7522.5 | -38.02 | 17.12 | -20.9 | -13 | Vertical |
| 7522.5 | -36.57 | 17.12 | -19.45 | -13 | Horizontal |
| 10030.0 | -38.91 | 19.26 | -19.65 | -13 | Horizontal |
| 10030.0 | -41.36 | 19.26 | -22.1 | -13 | Vertical |
| Test Results for Mid Channel 2535.0MHz | | | | | |
| 5070.0 | -35.58 | 13.76 | -21.82 | -13 | Horizontal |
| 5070.0 | -34.77 | 13.76 | -21.01 | -13 | Vertical |
| 7605.0 | -39.67 | 17.56 | -22.11 | -13 | Vertical |
| 7605.0 | -41.58 | 17.56 | -24.02 | -13 | Horizontal |
| 10140.0 | -41.32 | 19.6 | -21.72 | -13 | Horizontal |
| 10140.0 | -41.87 | 19.6 | -22.27 | -13 | Vertical |
| Test Results for High Channel 2562.5MHz | | | | | |
| 5125.0 | -37.27 | 13.87 | -23.4 | -13 | Horizontal |
| 5125.0 | -34.24 | 13.87 | -20.37 | -13 | Vertical |
| 7687.5 | -37.62 | 17.66 | -19.96 | -13 | Vertical |
| 7687.5 | -38.79 | 17.66 | -21.13 | -13 | Horizontal |
| 10250.0 | -38.92 | 19.75 | -19.17 | -13 | Horizontal |
| 10250.0 | -41.56 | 19.75 | -21.81 | -13 | Vertical |

QPSK EIRP POWER FOR LTE BAND 7 (20.0MHZ BANDWIDTH)

| Test Results for Low Channel 2510.0MHz | | | | | |
|--|------------|------------------------|------------------------|-------------|------------|
| Frequency(MHz) | Power(dBm) | A _{Rpl} (dBm) | P _{Mea} (dBm) | Limit (dBm) | Polarity |
| 5020.0 | -29.34 | 13.42 | -15.92 | -13.00 | Horizontal |
| 5020.0 | -33.87 | 13.42 | -20.45 | -13.00 | Vertical |
| 7530.0 | -34.75 | 17.12 | -17.63 | -13.00 | Vertical |
| 7530.0 | -36.36 | 17.12 | -19.24 | -13.00 | Horizontal |
| 10040.0 | -35.79 | 19.26 | -16.53 | -13.00 | Horizontal |
| 10040.0 | -36.12 | 19.26 | -16.86 | -13.00 | Vertical |
| Test Results for Mid Channel 2535.0MHz | | | | | |
| 5070.0 | -32.65 | 13.76 | -18.89 | -13.00 | Horizontal |
| 5070.0 | -35.98 | 13.76 | -22.22 | -13.00 | Vertical |
| 7605.0 | -35.64 | 17.56 | -18.08 | -13.00 | Vertical |
| 7605.0 | -44.12 | 17.56 | -26.56 | -13.00 | Horizontal |
| 10140.0 | -38.83 | 19.6 | -19.23 | -13.00 | Horizontal |
| 10140.0 | -37.49 | 19.6 | -17.89 | -13.00 | Vertical |
| Test Results for High Channel 2565.0MHz | | | | | |
| 5120.0 | -34.12 | 13.87 | -20.25 | -13.00 | Horizontal |
| 5120.0 | -35.39 | 13.87 | -21.52 | -13.00 | Vertical |
| 7680.0 | -39.83 | 17.66 | -22.17 | -13.00 | Vertical |
| 7680.0 | -37.53 | 17.66 | -19.87 | -13.00 | Horizontal |
| 10240.0 | -39.83 | 19.75 | -20.08 | -13.00 | Horizontal |
| 10240.0 | -36.77 | 19.75 | -17.02 | -13.00 | Vertical |

11. FREQUENCY STABILITY

RULE PART(S)

FCC: §2.1055, §27.54

LIMITS

§22.355 - The carrier frequency shall not depart from the reference frequency in excess of ± 2.5 ppm for mobile stations.

§24.235 - The frequency stability shall be sufficient to ensure that the fundamental emission stays within the authorized frequency block.

TEST PROCEDURE

Use CMW 500 with Frequency Error measurement capability.

Temp. = -30° to $+50^{\circ}$ C

Voltage = low voltage, 3.4VDC, Normal, 3.8VDC and High voltage, 4.3VDC.

Frequency Stability vs Temperature:

The EUT is placed inside a temperature chamber. The temperature is set to 20° C and allowed to stabilize. After sufficient soak time, the transmitting frequency error is measured. The temperature is increased by 10 degrees, allowed to stabilize and soak, and then the measurement is repeated. This is repeated until $+50^{\circ}$ C is reached.

Frequency Stability vs Voltage:

The peak frequency error is recorded (worst-case).

MODES TESTED

LTE Band 7

RESULTS

See the following pages.

11.1.1. LTE BAND 7

QPSK, (5.0MHz BANDWIDTH)

| BAND | CHANNEL | Frequency [MHz] | BANDWIDTH | Temperature [°C] | Voltage[V] | Frequency Error[Hz] | Frequency Error[ppm] | Limit [ppm] |
|------|---------|-----------------|-----------|------------------|------------|---------------------|----------------------|-------------|
| 7 | 20775 | 2502.5 | 5.0 | 25 | 3.7 | 10.7 | 0.004264 | 2.5 |
| 7 | 20775 | 2502.5 | 5.0 | 50 | 3.7 | 9.3 | 0.003727 | 2.5 |
| 7 | 20775 | 2502.5 | 5.0 | 40 | 3.7 | 8.6 | 0.003447 | 2.5 |
| 7 | 20775 | 2502.5 | 5.0 | 30 | 3.7 | 10.7 | 0.004287 | 2.5 |
| 7 | 20775 | 2502.5 | 5.0 | 10 | 3.7 | 8.6 | 0.003418 | 2.5 |
| 7 | 20775 | 2502.5 | 5.0 | 0 | 3.7 | 12.0 | 0.004796 | 2.5 |
| 7 | 20775 | 2502.5 | 5.0 | -10 | 3.7 | 7.3 | 0.002904 | 2.5 |
| 7 | 20775 | 2502.5 | 5.0 | -20 | 3.7 | 10.1 | 0.004024 | 2.5 |
| 7 | 20775 | 2502.5 | 5.0 | -30 | 3.7 | 10.8 | 0.004310 | 2.5 |
| 7 | 20775 | 2502.5 | 5.0 | 25 | 10% | 9.0 | 0.003590 | 2.5 |
| 7 | 20775 | 2502.5 | 5.0 | 25 | -10% | 3.8 | 0.001538 | 2.5 |
| 7 | 20775 | 2502.5 | 5.0 | 25 | End Point | 8.6 | 0.003436 | 2.5 |
| 7 | 21425 | 2567.5 | 5.0 | 25 | 3.7 | 9.3 | 0.003638 | 2.5 |
| 7 | 21425 | 2567.5 | 5.0 | 50 | 3.7 | 10.5 | 0.004106 | 2.5 |
| 7 | 21425 | 2567.5 | 5.0 | 40 | 3.7 | 8.6 | 0.003365 | 2.5 |
| 7 | 21425 | 2567.5 | 5.0 | 30 | 3.7 | 3.8 | 0.001476 | 2.5 |
| 7 | 21425 | 2567.5 | 5.0 | 10 | 3.7 | 4.7 | 0.001827 | 2.5 |
| 7 | 21425 | 2567.5 | 5.0 | 0 | 3.7 | 5.6 | 0.002173 | 2.5 |
| 7 | 21425 | 2567.5 | 5.0 | -10 | 3.7 | 6.3 | 0.002463 | 2.5 |
| 7 | 21425 | 2567.5 | 5.0 | -20 | 3.7 | 5.8 | 0.002268 | 2.5 |
| 7 | 21425 | 2567.5 | 5.0 | -30 | 3.7 | 6.2 | 0.002396 | 2.5 |
| 7 | 21425 | 2567.5 | 5.0 | 25 | 10% | 5.7 | 0.002212 | 2.5 |
| 7 | 21425 | 2567.5 | 5.0 | 25 | -10% | 3.8 | 0.001476 | 2.5 |
| 7 | 21425 | 2567.5 | 5.0 | 25 | End Point | 3.8 | 0.001476 | 2.5 |

QPSK, (10.0MHz BANDWIDTH)

| BAND | CHANNEL | Frequency [MHz] | BANDWIDTH | Temperature [°C] | Voltage[V] | Frequency Error[Hz] | Frequency Error[ppm] | Limit [ppm] |
|------|---------|-----------------|-----------|------------------|------------|---------------------|----------------------|-------------|
| 7 | 20800 | 2505.0 | 10.0 | 25 | 3.7 | 4.5 | 0.001782 | 2.5 |
| 7 | 20800 | 2505.0 | 10.0 | 50 | 3.7 | 10.2 | 0.004060 | 2.5 |
| 7 | 20800 | 2505.0 | 10.0 | 40 | 3.7 | 8.8 | 0.003529 | 2.5 |
| 7 | 20800 | 2505.0 | 10.0 | 30 | 3.7 | -3.2 | -0.001279 | 2.5 |
| 7 | 20800 | 2505.0 | 10.0 | 10 | 3.7 | -4.0 | -0.001582 | 2.5 |
| 7 | 20800 | 2505.0 | 10.0 | 0 | 3.7 | 6.2 | 0.002484 | 2.5 |
| 7 | 20800 | 2505.0 | 10.0 | -10 | 3.7 | 6.1 | 0.002444 | 2.5 |
| 7 | 20800 | 2505.0 | 10.0 | -20 | 3.7 | 7.3 | 0.002924 | 2.5 |
| 7 | 20800 | 2505.0 | 10.0 | -30 | 3.7 | 9.4 | 0.003746 | 2.5 |
| 7 | 20800 | 2505.0 | 10.0 | 25 | 10% | -4.3 | -0.001730 | 2.5 |
| 7 | 20800 | 2505.0 | 10.0 | 25 | -10% | 5.2 | 0.002079 | 2.5 |
| 7 | 20800 | 2505.0 | 10.0 | 25 | End Point | 4.6 | 0.001833 | 2.5 |
| 7 | 21400 | 2565.0 | 10.0 | 25 | 3.7 | 13.4 | 0.005231 | 2.5 |
| 7 | 21400 | 2565.0 | 10.0 | 50 | 3.7 | 10.9 | 0.004244 | 2.5 |
| 7 | 21400 | 2565.0 | 10.0 | 40 | 3.7 | 11.8 | 0.004584 | 2.5 |
| 7 | 21400 | 2565.0 | 10.0 | 30 | 3.7 | 9.4 | 0.003664 | 2.5 |
| 7 | 21400 | 2565.0 | 10.0 | 10 | 3.7 | 5.7 | 0.002236 | 2.5 |
| 7 | 21400 | 2565.0 | 10.0 | 0 | 3.7 | 8.4 | 0.003279 | 2.5 |
| 7 | 21400 | 2565.0 | 10.0 | -10 | 3.7 | 12.7 | 0.004936 | 2.5 |
| 7 | 21400 | 2565.0 | 10.0 | -20 | 3.7 | 15.9 | 0.006213 | 2.5 |
| 7 | 21400 | 2565.0 | 10.0 | -30 | 3.7 | 11.5 | 0.004495 | 2.5 |
| 7 | 21400 | 2565.0 | 10.0 | 25 | 10% | 6.4 | 0.002482 | 2.5 |
| 7 | 21400 | 2565.0 | 10.0 | 25 | -10% | 7.6 | 0.002978 | 2.5 |
| 7 | 21400 | 2565.0 | 10.0 | 25 | End Point | 10.0 | 0.003904 | 2.5 |

QPSK, (15.0MHz BANDWIDTH)

| BAND | CHANNEL | Frequency [MHz] | BANDWIDTH | Temperature [°C] | Voltage[V] | Frequency Error[Hz] | Frequency Error[ppm] | Limit [ppm] |
|------|---------|-----------------|-----------|------------------|------------|---------------------|----------------------|-------------|
| 7 | 20825 | 2507.5 | 15.0 | 25 | 3.7 | 6.4 | 0.002556 | 2.5 |
| 7 | 20825 | 2507.5 | 15.0 | 50 | 3.7 | 10.3 | 0.004102 | 2.5 |
| 7 | 20825 | 2507.5 | 15.0 | 40 | 3.7 | 11.1 | 0.004421 | 2.5 |
| 7 | 20825 | 2507.5 | 15.0 | 30 | 3.7 | 6.2 | 0.002465 | 2.5 |
| 7 | 20825 | 2507.5 | 15.0 | 10 | 3.7 | 8.6 | 0.003423 | 2.5 |
| 7 | 20825 | 2507.5 | 15.0 | 0 | 3.7 | 5.3 | 0.002117 | 2.5 |
| 7 | 20825 | 2507.5 | 15.0 | -10 | 3.7 | 10.3 | 0.004119 | 2.5 |
| 7 | 20825 | 2507.5 | 15.0 | -20 | 3.7 | 10.4 | 0.004153 | 2.5 |
| 7 | 20825 | 2507.5 | 15.0 | -30 | 3.7 | 10.7 | 0.004284 | 2.5 |
| 7 | 20825 | 2507.5 | 15.0 | 25 | 10% | -3.7 | -0.001460 | 2.5 |
| 7 | 20825 | 2507.5 | 15.0 | 25 | -10% | 7.5 | 0.002972 | 2.5 |
| 7 | 20825 | 2507.5 | 15.0 | 25 | End Point | 5.1 | 0.002042 | 2.5 |
| 7 | 21375 | 2562.5 | 15.0 | 25 | 3.7 | 8.5 | 0.003333 | 2.5 |
| 7 | 21375 | 2562.5 | 15.0 | 50 | 3.7 | 12.1 | 0.004734 | 2.5 |
| 7 | 21375 | 2562.5 | 15.0 | 40 | 3.7 | 10.3 | 0.004008 | 2.5 |
| 7 | 21375 | 2562.5 | 15.0 | 30 | 3.7 | 6.1 | 0.002395 | 2.5 |
| 7 | 21375 | 2562.5 | 15.0 | 10 | 3.7 | 9.4 | 0.003668 | 2.5 |
| 7 | 21375 | 2562.5 | 15.0 | 0 | 3.7 | 7.3 | 0.002841 | 2.5 |
| 7 | 21375 | 2562.5 | 15.0 | -10 | 3.7 | 12.9 | 0.005024 | 2.5 |
| 7 | 21375 | 2562.5 | 15.0 | -20 | 3.7 | 10.4 | 0.004058 | 2.5 |
| 7 | 21375 | 2562.5 | 15.0 | -30 | 3.7 | 10.6 | 0.004142 | 2.5 |
| 7 | 21375 | 2562.5 | 15.0 | 25 | 10% | 5.6 | 0.002188 | 2.5 |
| 7 | 21375 | 2562.5 | 15.0 | 25 | -10% | 5.0 | 0.001937 | 2.5 |
| 7 | 21375 | 2562.5 | 15.0 | 25 | End Point | 5.7 | 0.002216 | 2.5 |

QPSK, (20.0MHz BANDWIDTH)

| BAND | CHANNEL | Frequency [MHz] | BANDWIDTH | Temperature [°C] | Voltage[V] | Frequency Error[Hz] | Frequency Error[ppm] | Limit [ppm] |
|------|---------|-----------------|-----------|------------------|------------|---------------------|----------------------|-------------|
| 7 | 20850 | 2510.0 | 20.0 | 25 | 3.7 | 11.3 | 0.004502 | 2.5 |
| 7 | 20850 | 2510.0 | 20.0 | 50 | 3.7 | 12.5 | 0.004993 | 2.5 |
| 7 | 20850 | 2510.0 | 20.0 | 40 | 3.7 | 11.1 | 0.004440 | 2.5 |
| 7 | 20850 | 2510.0 | 20.0 | 30 | 3.7 | 7.0 | 0.002804 | 2.5 |
| 7 | 20850 | 2510.0 | 20.0 | 10 | 3.7 | 9.6 | 0.003830 | 2.5 |
| 7 | 20850 | 2510.0 | 20.0 | 0 | 3.7 | 6.4 | 0.002565 | 2.5 |
| 7 | 20850 | 2510.0 | 20.0 | -10 | 3.7 | 9.2 | 0.003670 | 2.5 |
| 7 | 20850 | 2510.0 | 20.0 | -20 | 3.7 | 13.4 | 0.005323 | 2.5 |
| 7 | 20850 | 2510.0 | 20.0 | -30 | 3.7 | 10.5 | 0.004195 | 2.5 |
| 7 | 20850 | 2510.0 | 20.0 | 25 | 10% | 7.2 | 0.002850 | 2.5 |
| 7 | 20850 | 2510.0 | 20.0 | 25 | -10% | 5.2 | 0.002092 | 2.5 |
| 7 | 20850 | 2510.0 | 20.0 | 25 | End Point | 7.8 | 0.003106 | 2.5 |
| 7 | 21100 | 2535.0 | 20.0 | 25 | 3.7 | 10.5 | 0.004136 | 2.5 |
| 7 | 21100 | 2535.0 | 20.0 | 50 | 3.7 | -5.2 | -0.002071 | 2.5 |
| 7 | 21100 | 2535.0 | 20.0 | 40 | 3.7 | 3.8 | 0.001518 | 2.5 |
| 7 | 21350 | 2560.0 | 20.0 | 30 | 3.7 | -6.7 | -0.002615 | 2.5 |
| 7 | 21350 | 2560.0 | 20.0 | 10 | 3.7 | -8.0 | -0.003107 | 2.5 |
| 7 | 21350 | 2560.0 | 20.0 | 0 | 3.7 | -8.0 | -0.003118 | 2.5 |
| 7 | 21350 | 2560.0 | 20.0 | -10 | 3.7 | -8.0 | -0.003124 | 2.5 |
| 7 | 21350 | 2560.0 | 20.0 | -20 | 3.7 | -6.1 | -0.002364 | 2.5 |
| 7 | 21350 | 2560.0 | 20.0 | -30 | 3.7 | -7.7 | -0.002990 | 2.5 |
| 7 | 21350 | 2560.0 | 20.0 | 25 | 10% | -11.6 | -0.004532 | 2.5 |
| 7 | 21350 | 2560.0 | 20.0 | 25 | -10% | -7.1 | -0.002766 | 2.5 |
| 7 | 21350 | 2560.0 | 20.0 | 25 | End Point | -10.3 | -0.004012 | 2.5 |

12. Peak-to-Average Ratio

12.1.1 DESCRIPTION OF THE PAR MEASUREMENT

The peak-to-average ratio (PAR) of the transmission may not exceed 13 dB.

12.1.2 MEASURING INSTRUMENTS

See list of measuring instruments of this test report.

12.1.3 TEST PROCEDURES

1. The EUT was connected to Spectrum Analyzer and Base Station via power divider.
2. The RF output of EUT was connected to the spectrum analyzer by RF cable and attenuator. The path loss was compensated to the results for each measurement.
3. For GSM/EGPRS operating modes:
 - a. Set the RBW = 1MHz, VBW = 1MHz, Peak detector in spectrum analyzer.
 - b. Set EUT in maximum power output, and triggered the burst signal.
 - c. Measured respectively the Peak level and Mean level, and the deviation was recorded as Peak to Average Ratio.
4. For UMTS operating modes:
 - a. Set the CCDF (Complementary Cumulative Distribution Function) option in spectrum analyzer.
 - b. The highest RF powers were measured and recorded the maximum PAPR level associated with a probability of 0.1 %.

12.1.4 TEST SETUP

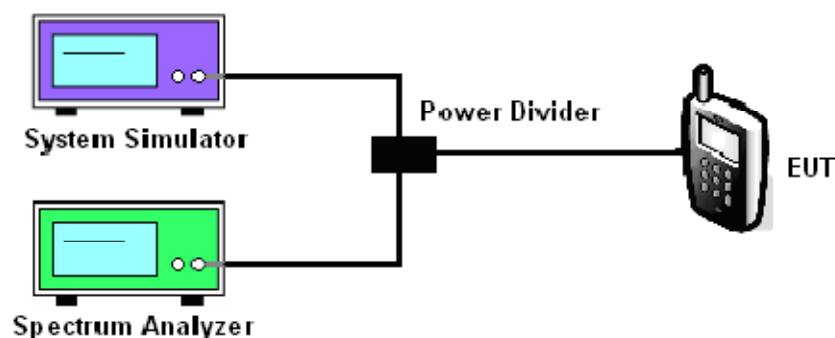

| BAND | CHANNEL | Frequency [MHz] | BANDWIDTH | NO. RB | RB POS. | MODULATION | PAR [dB] |
|------|---------|-----------------|-----------|--------|---------|------------|----------|
| 7 | 18900 | 2315.0 | 5.0 | 1 | Low | QPSK | 8.65 |
| 7 | 18900 | 2315.0 | 5.0 | 1 | Low | 16QAM | 7.85 |
| 7 | 18900 | 2315.0 | 10.0 | 1 | Low | QPSK | 7.97 |
| 7 | 18900 | 2315.0 | 10.0 | 1 | Low | 16QAM | 8.20 |
| 7 | 18900 | 2315.0 | 15.0 | 1 | Low | QPSK | 8.07 |
| 7 | 18900 | 2315.0 | 15.0 | 1 | Low | 16QAM | 7.95 |
| 7 | 18900 | 2315.0 | 20.0 | 1 | Low | QPSK | 8.20 |
| 7 | 18900 | 2315.0 | 20.0 | 1 | Low | 16QAM | 8.45 |

12.1.5. LTE BAND 7

Band 7,UL Channel 18900,UL Frequency 2315.0,BW 5.0,NO. RB 1,RB POS. Low,QPSK

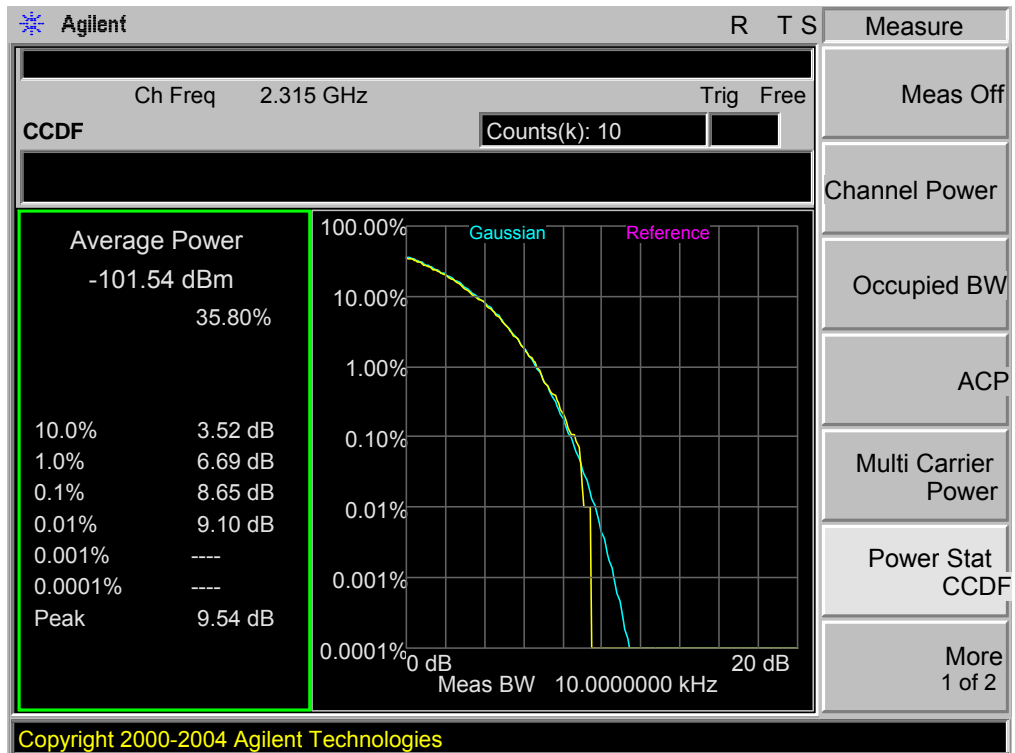

Band 7,UL Channel 18900,UL Frequency 2315.0,BW 5.0,NO. RB 1,RB POS. Low,16QAM

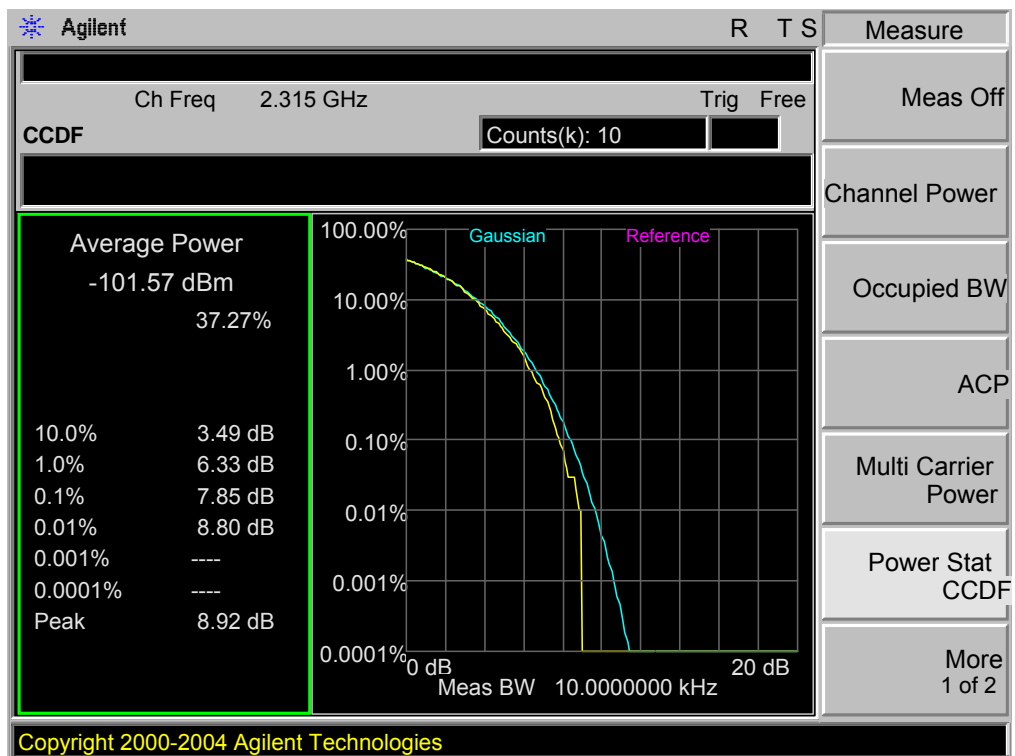

Band 7,UL Channel 18900,UL Frequency 2315.0,BW 10.0,NO. RB 1,RB POS. Low,QPSK

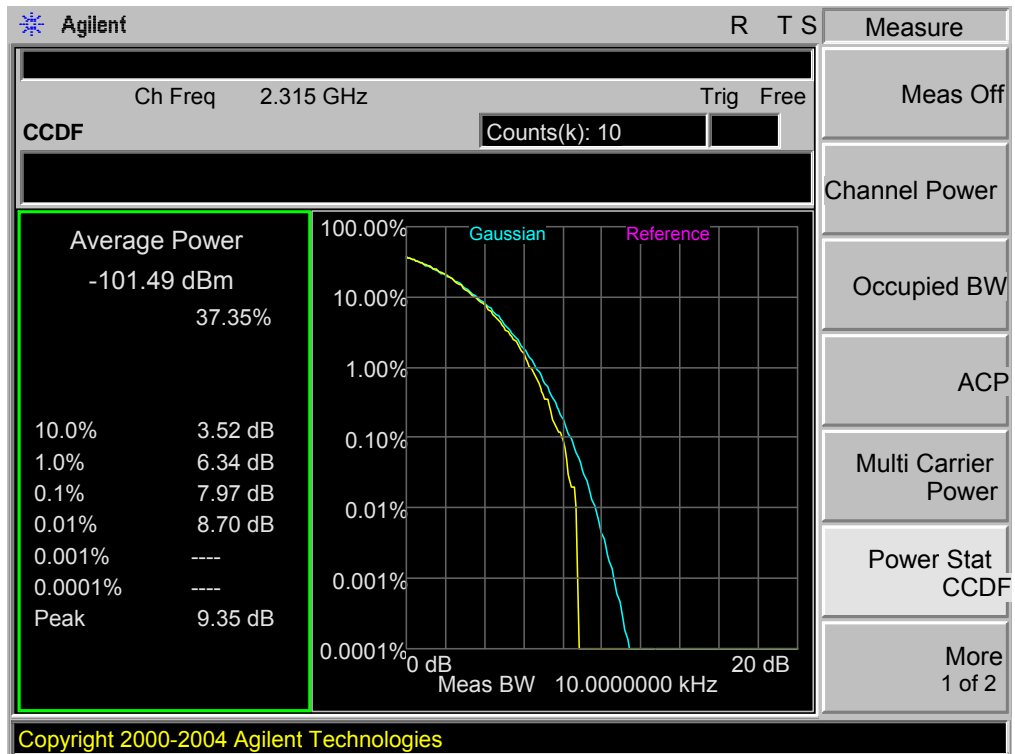

Band 7,UL Channel 18900,UL Frequency 2315.0,BW 10.0,NO. RB 1,RB POS. Low,16QAM

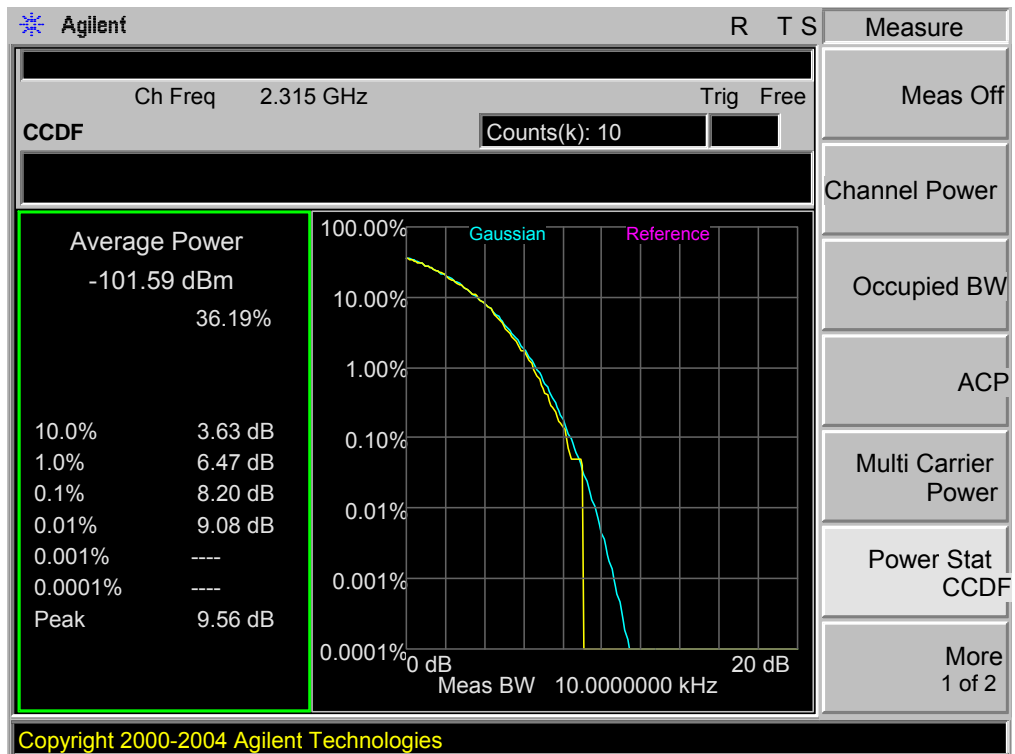

Band 7,UL Channel 18900,UL Frequency 2315.0,BW 15.0,NO. RB 1,RB POS. Low,QPSK

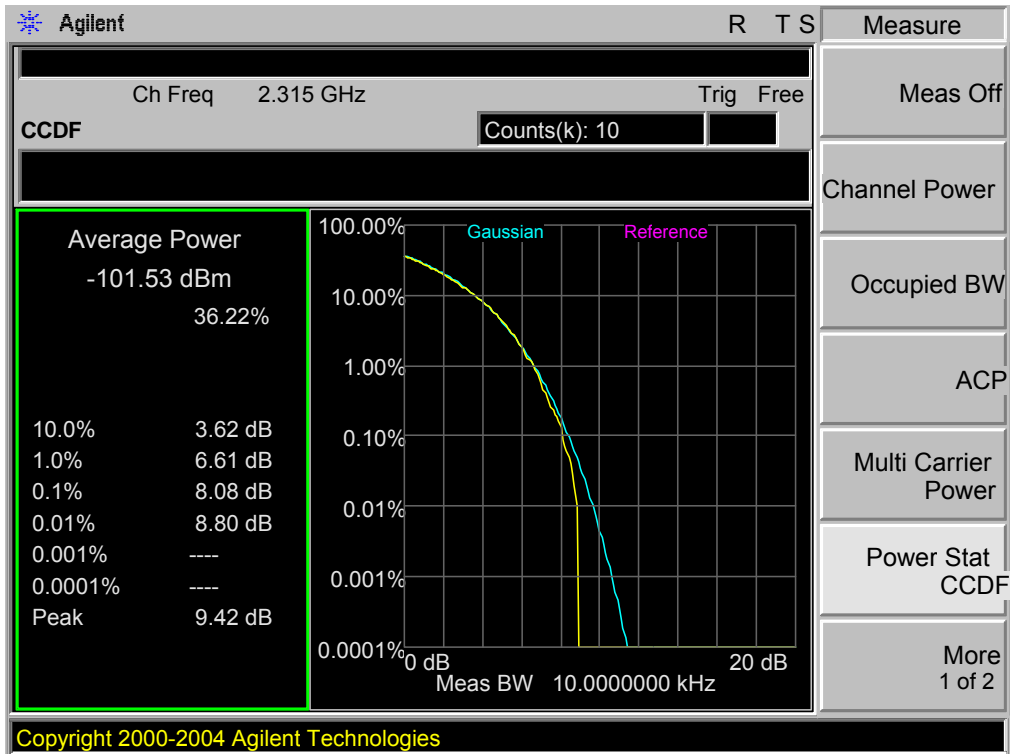

Band 7,UL Channel 18900,UL Frequency 2315.0,BW 15.0,NO. RB 1,RB POS. Low,16QAM

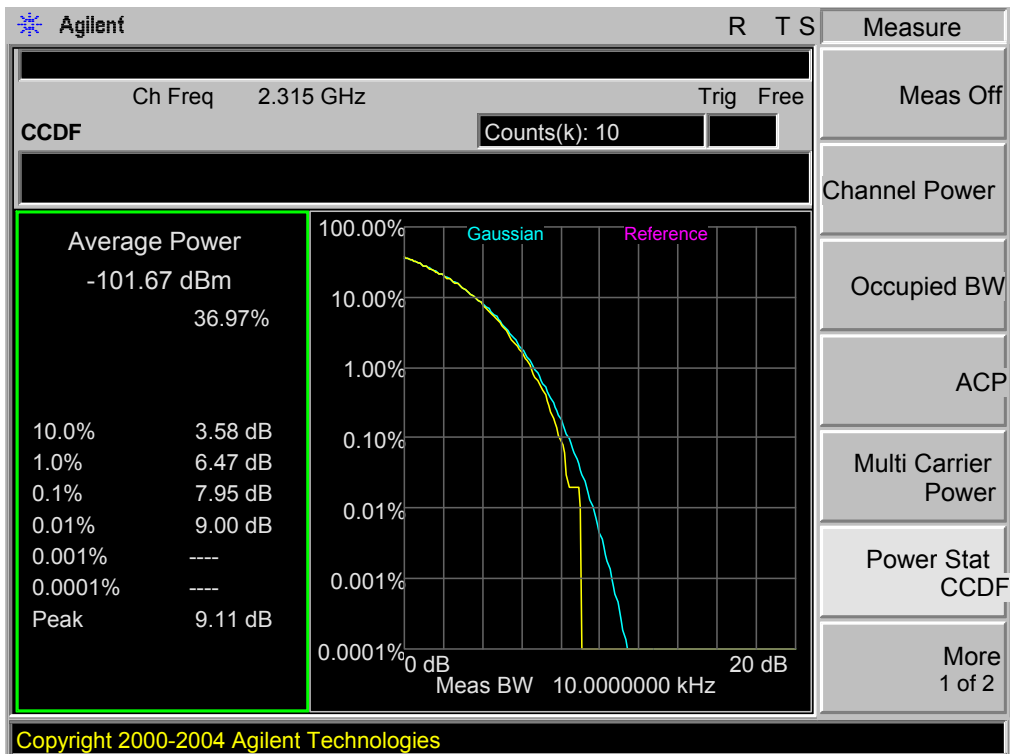

Band 7,UL Channel 18900,UL Frequency 2315.0,BW 20.0,NO. RB 1,RB POS. Low,QPSK

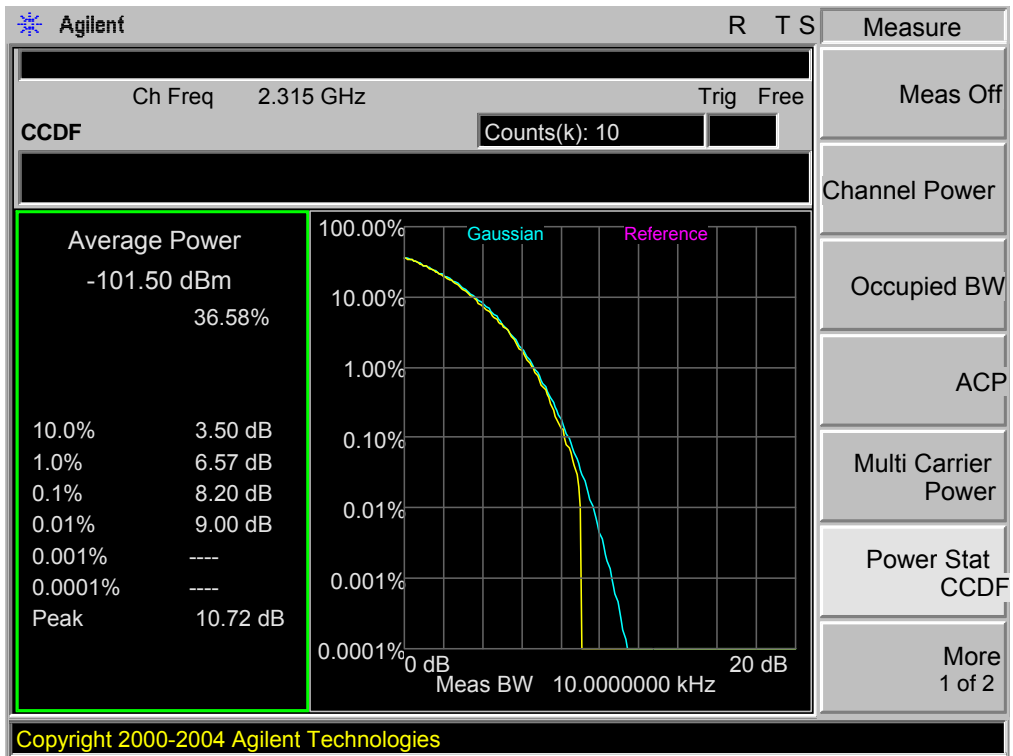

Band 7,UL Channel 18900,UL Frequency 2315.0,BW 20.0,NO. RB 1,RB POS. Low,16QAM

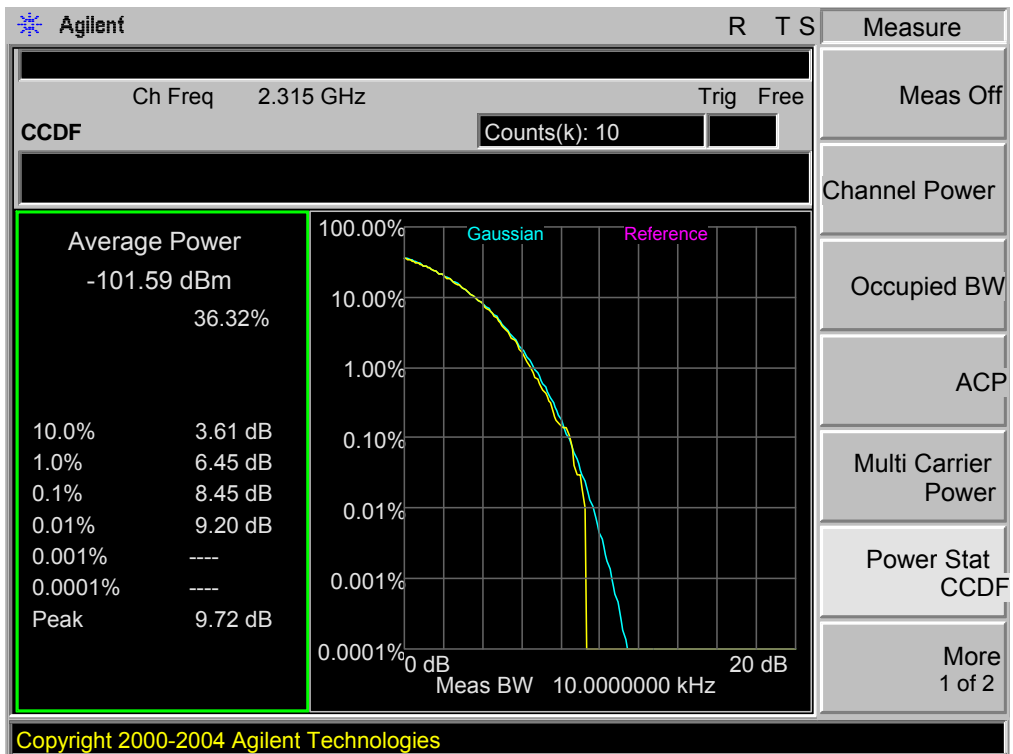

APPENDIX IV

RADIATED SPURIOUS EMISSION

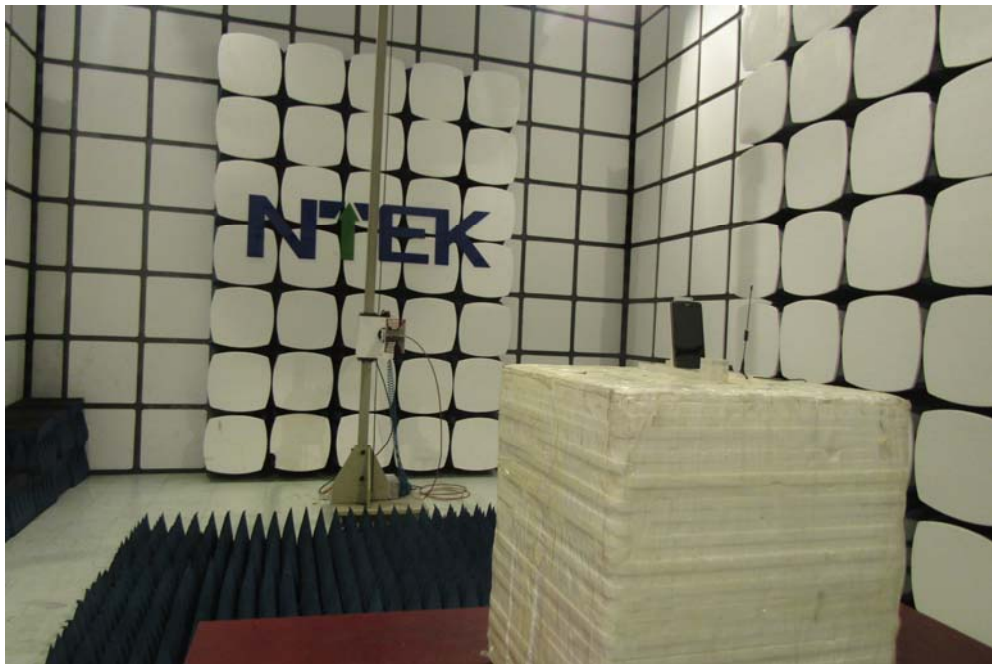
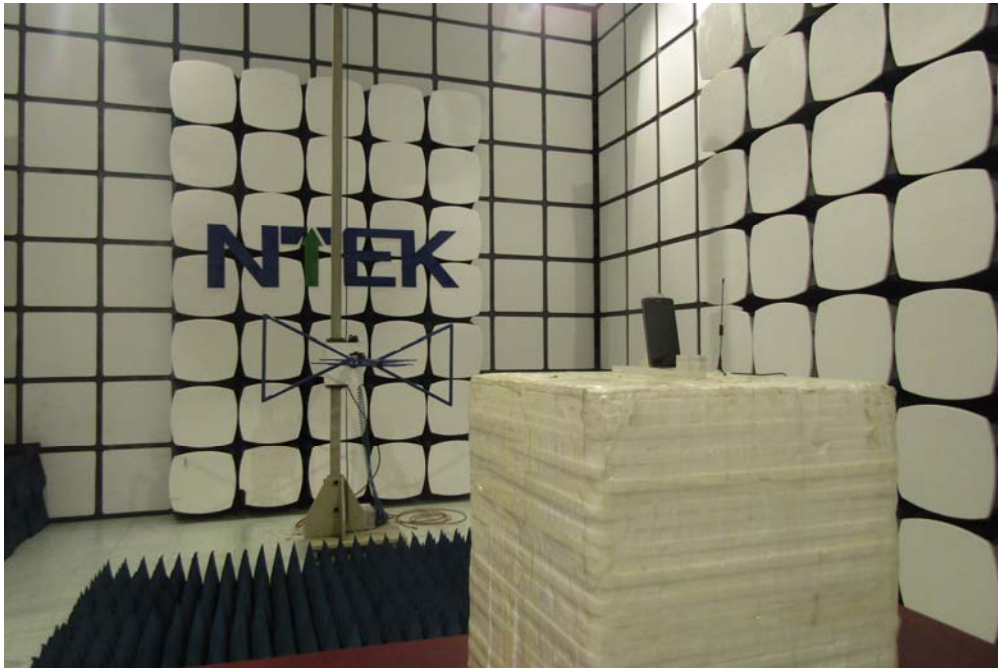

----END OF REPORT----