



www.cohdawireless.com

Cohda*Mobility* MK5 Module Datasheet

Date: May 2015
Version: V1.2.0
Reference: CWD-P0052-HWM-
DATA-WW01-061
Prepared for:
Prepared by: David de Haaij
Mike Sloman
Authorised By: Fabien CURE
(Chief Engineer)
Distribution:

This document is offered in confidence and may not be used
for any purpose other than that for which it is supplied.

© Copyright Cohda Wireless Pty Ltd

ABN 84 107 936 309

COMMERCIAL-IN-CONFIDENCE

Cohda Wireless Pty Ltd
82-84 Melbourne Street
North Adelaide, SA 5006 Australia

P +61 8 8364 4719
F +61 8 8364 4597

Change Log

Version	Date	Comments
0.1	27/10/2014	Initial Version for Review
0.2	12/11/2014	Update following review feedback
0.9	5/12/2014	Issue for technical release
1.0	10/12/2014	Issue for release
1.1	01/04/2015	Review of nACR and ACR data
1.2	07/05/2015	Update LO Leakage and Block Diagram

Table of Contents

1	Functional Description	6
1.1	Overview	6
1.2	CohdaMobility MAC.....	7
1.3	Performance.....	8
1.3.1	Receiver Sensitivity.....	8
1.3.2	Receiver Maximum Input Level.....	9
1.3.3	Transmitter Specifications.....	9
1.3.4	Power Level and Spectral Mask.....	10
1.3.5	Adjacent Channel Rejection.....	13
1.3.6	Non-Adjacent Channel Rejection	14
1.3.7	Return Loss.....	15
1.3.8	Power Measurements	15
1.4	Block Diagram.....	15
1.5	<i>CohdaMobility</i> DSRC Radio	15
1.5.1	<i>CohdaMobility</i> PHY.....	15
1.5.2	Reset	17
1.5.3	GPIO.....	17
1.5.4	1PPS.....	17
1.5.5	USB	17
1.5.6	Power Supplies	17
2	Pin Definition	18
3	Example Circuit	21
4	Mechanical Specification	22
5	Reliability and Compliance	25
5.1	ESD.....	25
	Regulatory Information	25
5.2	25
6	Product Packaging and Handling	26
7	Labelling.....	27
7.1	Product Label: MK5 Module	27
7.2	Label paste at Anti-Static bag and Pbox.	27

List of Tables

Table 1 - Key Features of the MK5 Module	6
Table 2 - MK5 Module Receive Sensitivity.....	8
Table 3 - Highway NLoS channel parameters	8
Table 4 - General Transmitter Specification	10
Table 5 - MK5 Module 5GHz Radio Transmitter Specifications	10
Table 6 - Transmitter unwanted emission limits from 1GHz to 18GHz outside the 5GHz ITS frequency bands.....	11
Table 7 - Adjacent Channel Rejection (ACR)	13
Table 8 - Non-Adjacent Channel Rejection (nACR)	14
Table 9 - Permissible radio path configurations.....	16
Table 10 - Module Pin Assignments	19
Table 11 - Example circuit Bill of Material	21
Table 12 - MK5 Module environmental requirements.....	25

1 Functional Description

1.1 Overview

The MK5 Module is designed to provide a compact platform for the deployment of advanced connected vehicle applications which can exploit the significant performance of the **CohdaMobility** Radio in mobile environments.

The MK5 Module is an automotive qualified single or dual channel **CohdaMobility** IEEE 802.11p radio, operating from -40C to +85C PCB ambient temperature.

The MK5 module is a complete IEEE 802.11p dual-antenna radio, incorporating Link-, MAC- and PHY Layers and 5.9GHz RF Front-End. It is a surface mount module that only requires connections to 5.9GHz antennas, USB connection to a host processor, and power supply.

The key features of the MK5 Module are summarised in Table 1 below.

Table 1 - Key Features of the MK5 Module

Parameter	Specification	
Frequency Bands	5.9 GHz 760 MHz (Future) 2.4 GHz (Future)	
Transmit Power	5.9 GHz: -10 to +23 dBm	5.9 GHz: Class C
Receive Sensitivity	5.9 GHz: -97 dBm	@ 3Mbps
Antenna Diversity	5.9 GHz only: CDD Transmit Diversity MRC Receive Diversity	
Bandwidth	10 MHz 20 MHz (Future)	
Data Rates	3 to 54 Mbps	
Power Supply	3.3V 5.0V	
Power Consumption	4W (Max)	
Temperature Range	-40°C to +85°C	
Dimensions	40 (L) x 30 (W) x 4 (H) mm	
Standards Conformance	IEEE 802.11p – 2010 ETSI ES 202 663 IEEE 1609.4 – 2010	

1.2 CohdaMobility MAC

The *CohdaMobility* MAC implements a full IEEE 802.11p compliant MAC layer, for one or two independent radio channels. The MAC runs on the ARM processor of the SAF5100.

The *CohdaMobility* MAC provides fast, time-synchronised channel switching functionality. It also provides support for multiple queue sets, allowing packets to be queued while the PHY/MAC is operating on another channel.

The MAC provides the following operating modes:

- Single radio, single channel operation.
 - o Only one of the radios are used
- Single radio, time-synchronised multi-channel operation
 - o Channel switching between two channels with independent sets of transmit queues.
- Dual radio, multi-channel operation
 - o Independent MAC/PHY entities operating concurrently on different radio channels.
 - o Optional coordination between channels to avoid self-interference when operating on close radio channels.
- Dual radio time synchronised multichannel operation.
 - o As above, plus one of the radios optionally performs channel switching between two channels with independent sets of transmit queues

The *CohdaMobility* MAC provides full IEEE 802.11p support. Full support for MAC time-synchronisation is provided via an external GNSS receiver under software control or using an external 1PPS signal.

Other features of the MAC include:

- Radio channel measurements
 - o Channel utilisation (ratio of channel busy time to measurement duration)
 - o Channel active ratio (proportion of time that the radio is tuned to the SCH or CCH, respectively)
 - o Per-channel statistics (number of packets successfully transmitted, number of packets that failed to transmit, number of packets successfully received, and number of packets received in error. Broken down according to broadcast, multicast, and unicast packets)
 - o Received signal and noise power levels.

1.3 Performance

1.3.1 Receiver Sensitivity

The receive sensitivity of the MK5 Radio is presented in Table 2 for single and dual receive antennas, operating at 5.9GHz in DSRC 10MHz bandwidth mode. The packet error rate (PER) is less than 10% at a PSDU length of 1,000 octets for these input levels. The receive sensitivity is measured with a signal input directly to the antenna ports. Example plots are presented in Figure 1 and Figure 2 overleaf.

Table 2 - MK5 Module Receive Sensitivity

Rate ID	Channel Number of Antennas MCS	No Multipath [dBm]		Highway NLoS [dBm]	
		1 Typical (Min)	2 Typical (Min)	1 Typical (Min)	2 Typical (Min)
11	1/2 BPSK	-98 (-95)	-99 (-97)	-95 (-92)	-97 (-95)
15	3/4 BPSK	-96 (-93)	-98 (-96)	-92 (-89)	-95 (-93)
10	1/2 QPSK	-95 (-92)	-97 (-95)	-88 (-85)	-92 (-90)
14	3/4 QPSK	-93 (-90)	-95 (-93)	-86 (-83)	-89 (-87)
9	1/2 16QAM	-90 (-87)	-92 (-90)	-85 (-82)	-88 (-86)
13	3/4 16QAM	-86 (-83)	-88 (-86)	-82 (-79)	-85 (-86)
8	2/3 64QAM	-82 (-79)	-84 (-82)	na	na
12	3/4 64QAM	-80 (-77)	-83 (-81)	na	na

The Highway NLoS (Non Line of Sight) channel parameters used to obtain the values in Table 2 are captured in Table 3 below.

Table 3 - Highway NLoS channel parameters

Tap #	Relative Power [dB]	Delay [ns]	Doppler Frequency [Hz]
0	0	0	0
1	-2	200	689
2	-5	433	-492
3	-7	700	886

This channel was used in the RF testing at the third ETSI Plugtest (CMS3).

Each tap is faded using Pure Doppler, but the second antenna has a Doppler increased by 11Hz, which prevents phase synchronization of the channels. The Rx Power listed in Table 2 refers to the power of Tap 0.

The values presented are typical values, measured at +25°C. The sensitivity may be reduced by approximately 1dB when operating at +85°C or -40°C.

1.3.2 Receiver Maximum Input Level

The receiver maximum operating input level is -20dBm (the PER may exceed 10% for input levels above this value).

The input level should not exceed 0 dBm to avoid damage.

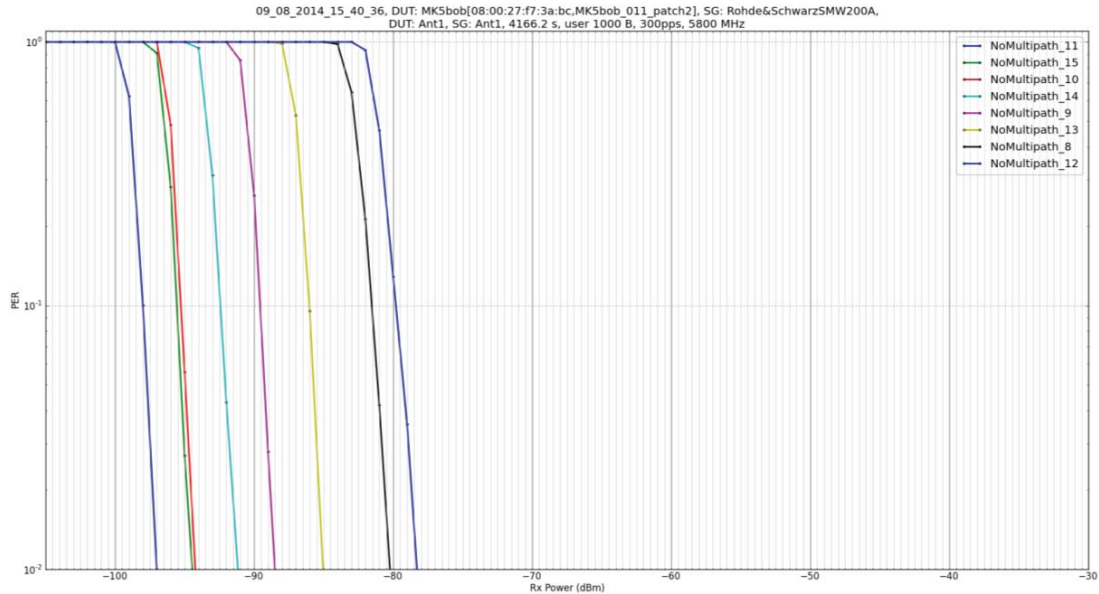

Figure 1 - Receiver sensitivity for Antenna 1 (No RF multipath)

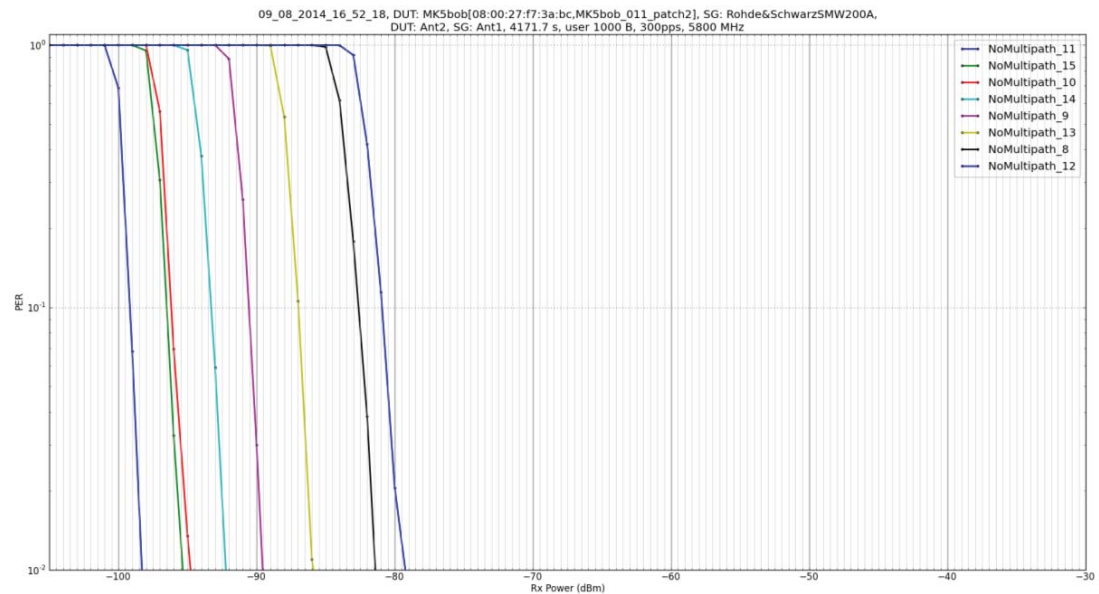

Figure 2 - Receiver sensitivity for Antenna 2 (No RF multipath)

1.3.3 Transmitter Specifications

Table outlines the transmitter specifications common to all operating modes of the MK5 Module Radio.

Table 4 - General Transmitter Specification

Specification	Performance
Output centre frequency and symbol clock tolerance.	±10ppm
Transmitter spectral flatness	< ±2 dB in all bandwidth and modulation modes
Transmitter centre frequency leakage	> 15 dB below average sub-carrier power in all bandwidth and modulation modes
Transmit power control step-size.	0.5 dB
Transmit power control accuracy	±2 dB over temperature

1.3.4 Power Level and Spectral Mask

The MK5 Module Radio maximum output power and spectral mask characteristics are outlined in Table 5. This specification applies to each of the two 5GHz antenna ports available (Ant1 and Ant2) and targets the entire temperature range. Measured results for the MK5 Module are presented in and . Figure 5 and Figure 6 presents typical Out-of-Band unwanted emission results for the MK5 Module.

Table 5 - MK5 Module 5GHz Radio Transmitter Specifications

Specification	Performance
Maximum Transmit Power	+23dBm per antenna port (+26dBm effective transmit power in 2-antenna transmit mode)
Minimum Transmit Power	-10 dBm
Transmit power control	0.5dB steps monotonically increasing/decreasing
EVM	per IEEE802.11-2007 (clause 17.3.9.6.3)
Spectral Mask	Targets DSRC class C, <ul style="list-style-type: none"> • 5.0 MHz, -26 dBc • 5.5 MHz, -32 dBc • 10 MHz, -40 dBc • 15 MHz, -50 dBc
Out of Band Emissions	Target ETSI emission mask [EN 302 571] as per Table 6
Supported channels	5GHz: 168-184

Table 6 - Transmitter unwanted emission limits from 1GHz to 18GHz outside the 5GHz ITS frequency bands

Frequency Range	Res BW [MHz]	Maximum Power (EIRP) [dBm]
1 GHz < f < 5,795 GHz	1	-30
5,795 GHz < f < 5,815 GHz	1	-40
5,815 GHz < f < 5,850 GHz	1	-40
5,850 GHz < f < 5,855 GHz	1	-30
5,925 GHz < f < 5,965 GHz	1	-40
5,965 GHz < f < 18 GHz	1	-30

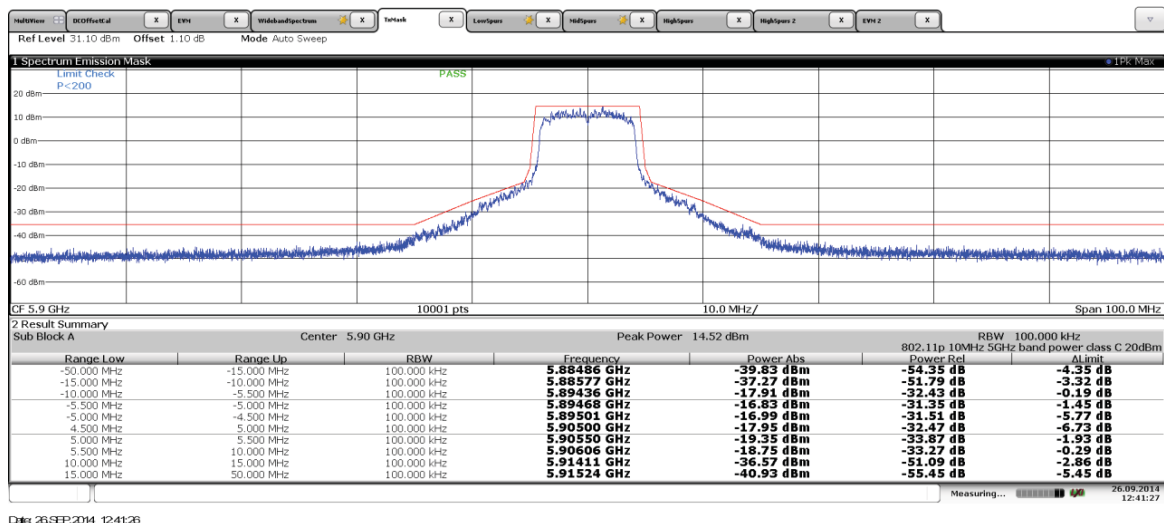

Figure 3 - MK5 Module Class-C Transmission Mask

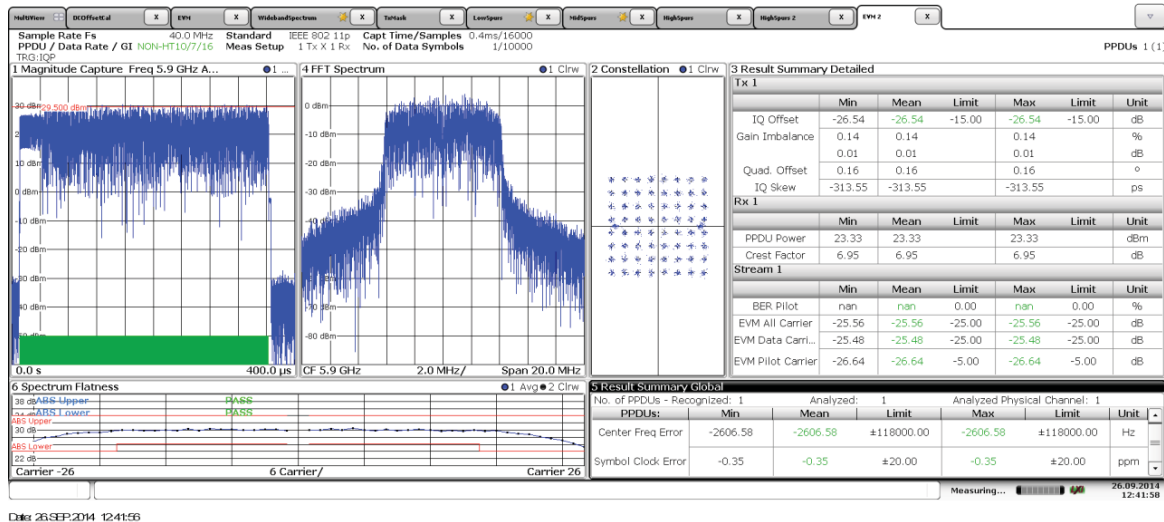

Figure 4 - MK5 Module EVM and Transmit Power

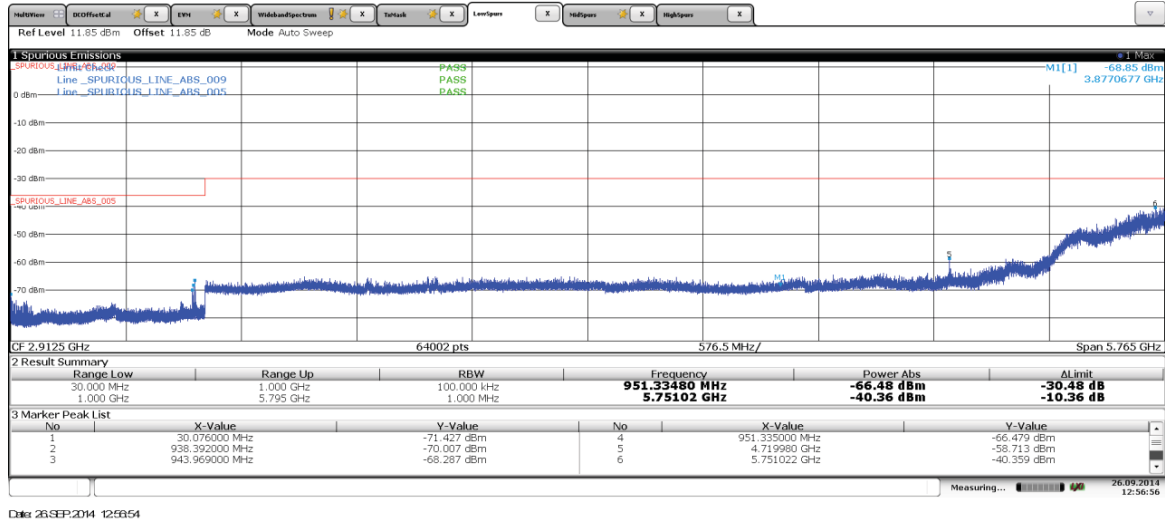

Figure 5 - MK5 Module Out-of-Band emission mask (Below DSRC)

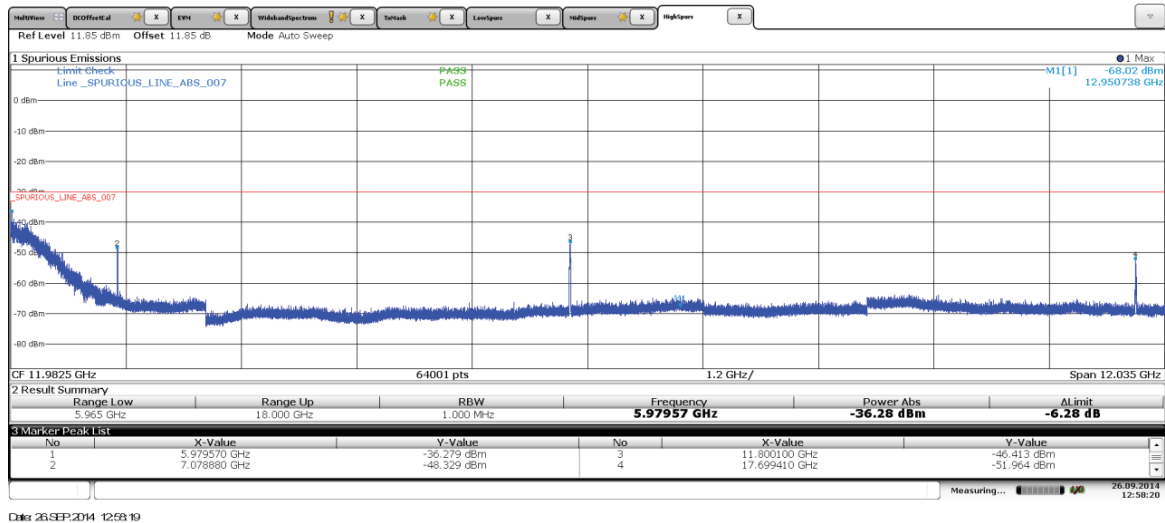

Figure 6 - MK5 Module Out-of-Band emission mask (Above DSRC)

1.3.5 Adjacent Channel Rejection

The adjacent channel rejection of a MK5 Module is measured by setting the desired signal strength 3 dB above the receive sensitivity specified in Table 18-14 of the IEEE802.11-2012 standard Table 2 and raising the power of the interfering signal until 10% PER is caused for a PSDU length of 1000 octets. The power difference between the interfering and the desired channel is the corresponding adjacent channel rejection. The interfering signal in the adjacent channel is a conformant OFDM signal, meeting the DSRC Class C mask, unsynchronized with the signal in the channel under test. The receive sensitivity values are measured with a signal input directly to the Antenna Ports. Measured results for the MK5 Module adjacent channel rejection, together with the target nACR values obtained from the IEEE802.11-2012 standard, are provided in Table 7

Table 7 - Adjacent Channel Rejection (ACR)

Modulation	Target ACR [dB]	Target opt. enh. ACR [dB]	MK5 Typical ACR [dB]
½ BPSK	16	28	37
¾ BPSK	15	27	33
½ QPSK	13	25	35
¾ QPSK	11	23	29
½ 16QAM	8	20	29
¾ 16QAM	4	16	25
⅔ 64QAM	0	12	22
¾ 64QAM	-1	11	20

1.3.6 Non-Adjacent Channel Rejection

The non-adjacent channel rejection of a MK5 Module Radio is measured by setting the desired signal's strength 3 dB above the rate-dependent sensitivity specified in Table 18-14 of the IEEE802.11-2012, and raising the power of the interfering signal until a 10% PER occurs for a PSDU length of 1000 octets. The power difference between the interfering and the desired channel is the corresponding nonadjacent channel rejection. The interfering signal in the non-adjacent channel is a conformant OFDM signal, targeting the DSRC Class C mask, unsynchronized with the signal in the channel under test. The receive sensitivity values are measured with a signal input directly to the Antenna Ports. Measured results for the MK5 Module non-adjacent channel rejection, together with the target nACR values obtained from the IEEE802.11-2012 standard, are provided in Table 8.

Table 8 - Non-Adjacent Channel Rejection (nACR)

Modulation	Target nACR [dB]	Target opt. enh. nACR [dB]	Typical nACR [dB]
½ BPSK	32	42	51
¾ BPSK	31	41	48
½ QPSK	29	39	48
¾ QPSK	27	37	45
½ 16QAM	24	34	42
¾ 16QAM	20	30	38
⅔ 64QAM	16	26	34
¾ 64QAM	15	25	32

1.3.7 Return Loss

The return loss on all RF ports is no more than -10 dB.

1.3.8 Power Measurements

All receiver power measurements made by MK5 Module (e.g. RSSI) is accurate to ± 2 dB over the range of -95 to -20 dBm and over the operating temperature range.

1.4 Block Diagram

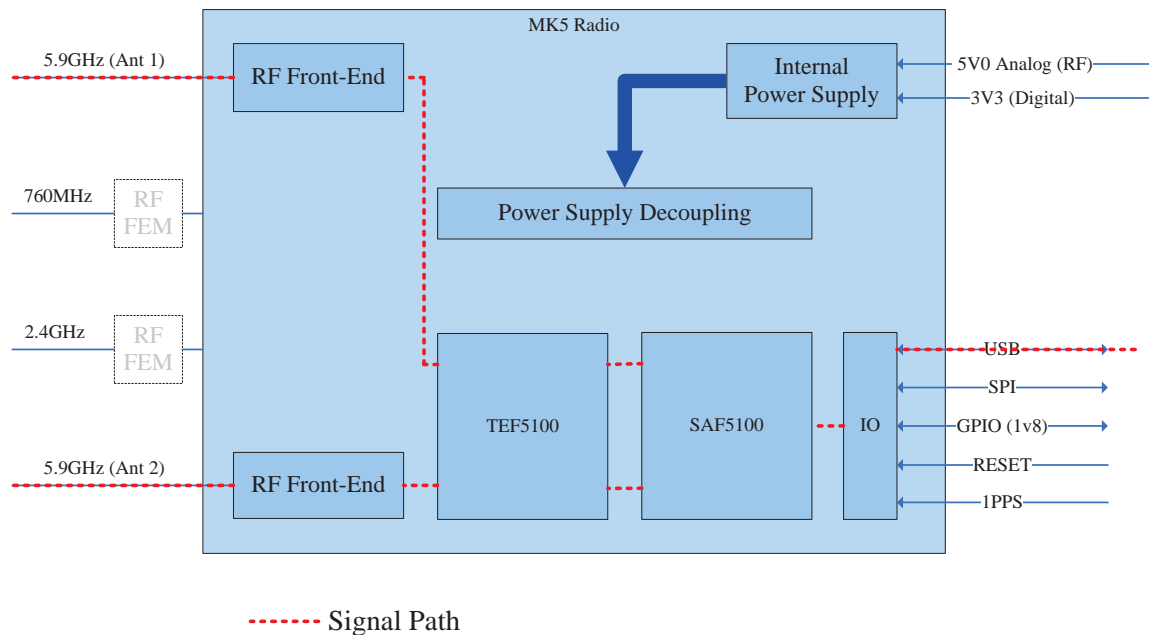

Figure 7 - MK5 HW Block Diagram

1.5 CohdaMobility DSRC Radio

1.5.1 CohdaMobility PHY

The **CohdaMobility** PHY is a full IEEE 802.11p compliant physical layer radio transceiver (PHY) employing the Cohda Wireless advanced mobility receiver algorithms. The PHY RF front-end can provide multiple radio configurations, allowing the MK5 Module to implement single or dual radio DSRC systems. The RF sub-system provides separate antenna ports for 5GHz bands via castellated edges of the module. RF output pin sets (separate Rx and Tx pins) are available for 760MHz and 2.4GHz. These two frequency bands will require off-board RF Front-End circuits for complete integration into a radio system.

In the dual-radio configuration, the **CohdaMobility** PHY effectively operates as two independent PHY modules, each operating on a different radio channel.

The module can support the dual-radio configurations shown in Figure 8.

Table 9 - Permissible radio path configurations

Configuration	5GHz (Ant 1)	5GHz (Ant 2)	760MHz	2.4GHz
1	Yes	Yes	-	-
2	Yes	-	-	Yes
3	-	Yes	Yes	-
4	-	-	Yes	Yes

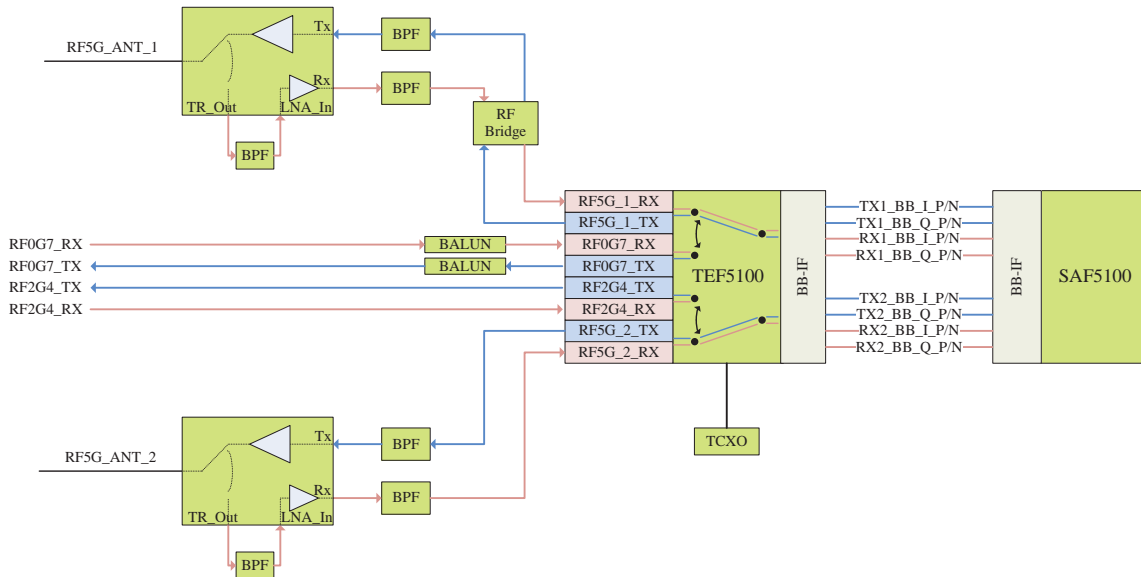

Figure 8 - RF Front-End Block Diagram

The 760MHz and 2.4GHz RF circuits will require external RF Front-End design on host (carrier) board.

The **CohdaMobility** PHY provides 2-antenna diversity transmission and reception at 5.9GHz for optimum radio performance. A summary of the operating modes and functionality of the **CohdaMobility** PHY are as follows:

- Single-channel mode (1 or 2 antenna diversity operation).
- Dual-channel mode (1 antenna per channel), 2 independent IEEE 802.11p radios operating on different radio channels.
- 10MHz (DSRC) channel bandwidth modes.
- Supported frequency bands:
 - o As per Table 1
- Transmit mask meeting IEEE 802.11p Class C (5GHz band).
- IEEE 802.11p enhanced adjacent channel receiver performance.
- Transmit antenna cyclic delay diversity (2 antenna operation in 5.9 GHz band only).
- Transmit power control (0.5dB steps).
- Fast mode changes for synchronised channel switching systems.



1.5.2 Reset

The reset line will keep the SAF5100 and TEF5100 IC's on the MK5 module in reset. Contact Cohda Wireless for specific information on the implementation of this pin.

1.5.3 GPIO

Refer Table 10.

1.5.4 1PPS

The 1PPS input is required by the radio to align transmissions when channel switching and for timekeeping. The MK5 accepts pulses with standard CMOS 1V8 levels. The signal should have the rising edge on the UTC second. Pulse width should be 1ms nominally. Pulse widths up to 250ms should be tolerable. As with all MK5 input this signal must NEVER be driven into the MK5 when the internal MK5 supplies are off. Contact Cohda Wireless for specific information on the implementation of this pin.

1.5.5 USB

Refer Table 10.

1.5.6 Power Supplies

The MK5 module 5.0v supplies are designed to support up to 400mA current draw for each radio (producing a continuous sinus wave at maximum transmit power).

The 3.3v power supply is designed to support up to 1A, assuming maximum load on all the DSP and RF transceiver functions.

The total power consumption of the MK5 module will not exceed 4W in normal operation, and typically consumes only 2.1W.

2 Pin Definition

The pin definition for the MK5 Module is presented in Figure below.

All pins marked as N/C should be soldered for mechanical strength with no further electrical connections.

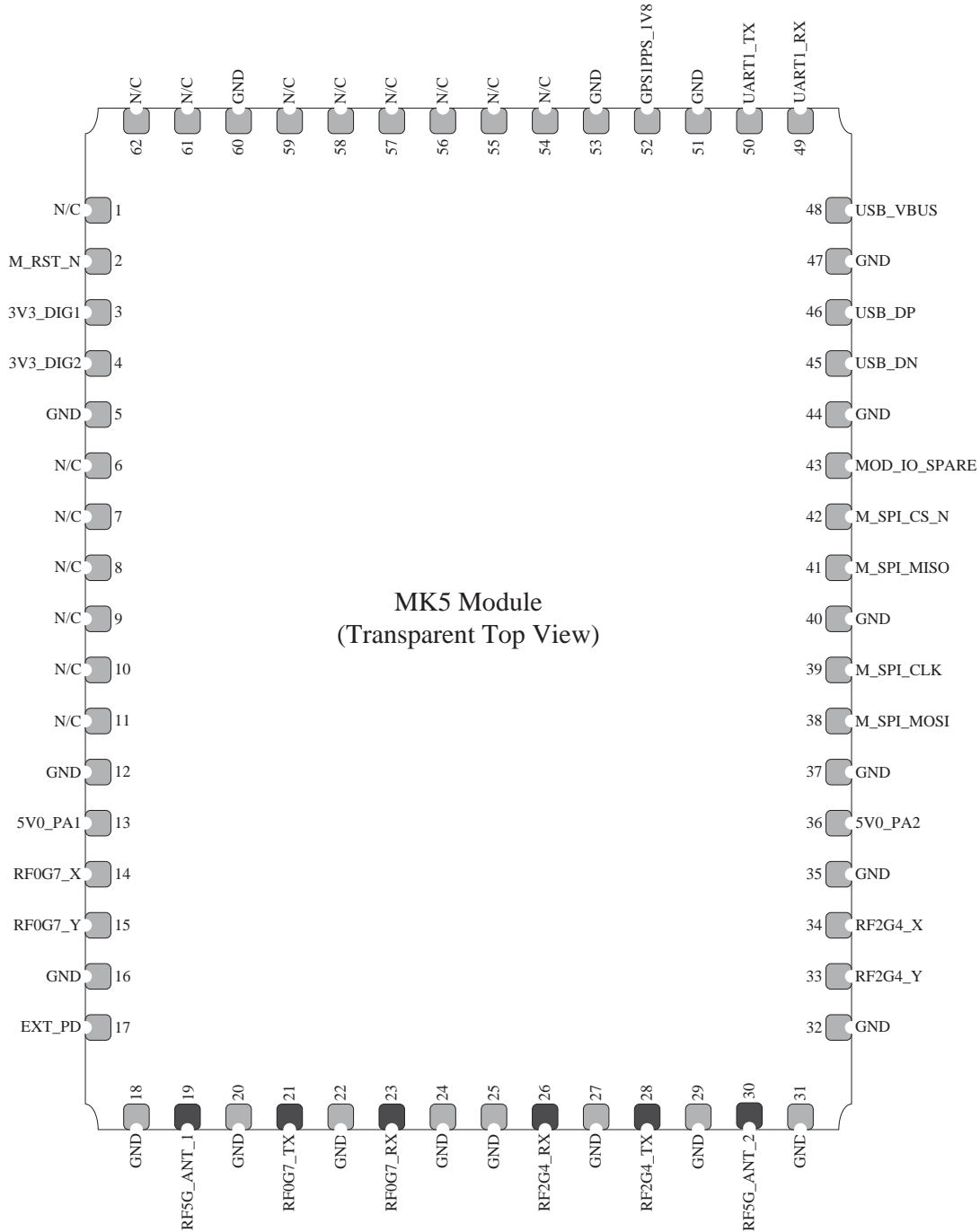

Figure 9 - MK5 Module transparent top view

Table 10 - Module Pin Assignments

Pin	Assignment	Pin Direction	Description
1	N/C		
2	M_RST_N	I	Module Reset (1.8v) ¹
3	3V3_DIG1	P	3.3V Power Supply
4	3V3_DIG2	P	3.3V Power Supply
5	GND	P	Ground
6	N/C		See Note 2
7	N/C		
8	N/C		
9	N/C		
10	N/C		
11	N/C		
12	GND	P	Ground
13	5V0_PA1	P	5.0V Power Supply (RF Ant 1) ⁴
14	RF0G7_X (N/C)	O	760MHz Control Pin (N/C for 5.9GHz only modules)
15	RF0G7_Y (N/C)	O	760MHz Control Pin (N/C for 5.9GHz only modules)
16	GND	P	Ground
17	EXT_PD (N/C)	O	External Power Detect (N/C for 5.9GHz only modules)
18	GND	P	Ground
19	RF5G_ANT1	O	5.9GHz RF Port (Ant 1)
20	GND	P	Ground
21	RF0G7_TX (N/C)	RF	760MHz RF Output Pin (Tx) (N/C for 5.9GHz modules)
22	GND	P	Ground
23	RF0G7_RX (N/C)	RF	760MHz RF Input Pin (Rx) (N/C for 5.9GHz modules)
24	GND	P	Ground
25	GND	P	Ground
26	RF2G4_RX (N/C)	RF	2.4GHz RF Input Pin (Rx) (N/C for 5.9GHz modules)
27	GND	P	Ground
28	RF2G4_TX (N/C)	RF	2.4GHz RF Output Pin (Tx) (N/C for 5.9GHz modules)
29	GND	P	Ground
30	RF5G_ANT2	RF	5GHz RF Port (Ant 2)
31	GND	P	Ground
32	GND	P	Ground
33	RF2G4_Y (N/C)	O	2.4GHz Control Pin (N/C for 5.9GHz only modules)
34	RF2G4_X (N/C)	O	2.4GHz Control Pin (N/C for 5.9GHz only modules)
35	GND	P	Ground
36	5V0_PA2	P	5.0V Power Supply (RF Ant 2) ⁴
37	GND	P	Ground



38	M_SPI_MOSI	O	Module SPI Bus ⁵
39	M_SPI_SCK	O	Module SPI Bus ⁵
40	GND	P	Ground
41	M_SPI_MISO	I	Module SPI Bus ⁵
42	M_SPI_CS	O	Module SPI Bus ⁵
43	MOD_IO_SPARE	O	General Purpose IO (1.8V) ⁶
44	GND	P	Ground
45	M_USB_D_N	BI	Module USB Bus ⁷
46	M_USB_D_P	BI	Module USB Bus ⁷
47	GND	P	Ground
48	M_USB_VBUS	P	Module USB Bus ⁷
49	UART1_RX	I	UART1 Receive Line ⁸
50	UART1_TX	O	UART1 Transmit line ⁸
51	GND	P	Ground
52	GPS_1PPS_1V8	I	1PPS Input (1.8v) ⁹
53	GND	P	Ground
54	N/C		
55	N/C		
56	N/C		
57	N/C		
58	N/C		
59	N/C		
60	GND	P	Ground
61	N/C		
62	N/C		

P=Power I=Input O=Output BI=Bidirectional RF=Radio Frequency

NOTES

1. This pin should be driven by an open drain/collector device. It is internally pulled high to 1V8 by 10k. When reset it should be below 0.2V.
2. This pin is internally pulled to pin 3 and 4, the 3V3 supply lines. This should not be shorted or pulled to ground. See HW manual.
3. These 3 pins should never be loaded by more than 500 kΩ to ground or 1V8 as this would interfere with correct internal operation at boot.
4. The 5V0_PAn pins should have bypass caps located at the pin. These are NOT connected internally and each supply is isolated to its own PA. Supply must be provided whenever the module main supply is powered.
5. The SPI bus is nominally an output on all modules. Internally, depending upon version of module, there may be a flash memory on this bus. Direction of these lines may be swapped on some versions of the module depending upon customer requirements. Always check your modules model and version against the HW documentation.
6. This line is optionally a SPI CS line. In other cases it may be used as a GPIO. Please check model number against HW documentation for how to use this pin in your application.
7. The USB interface is only between the module and host processor for short impedance controlled traces. The data and VBUS signals should only be applied to these pins when the module has power applied otherwise damage may occur.
8. This UART is not yet implemented but may be used in the future for customer specific or Cohda Wireless use.
9. This input, as with all inputs, should not be driven in to the device when the power is not supplied to the module otherwise damage will occur. Contact Cohda Wireless for further information.

3 Example Circuit

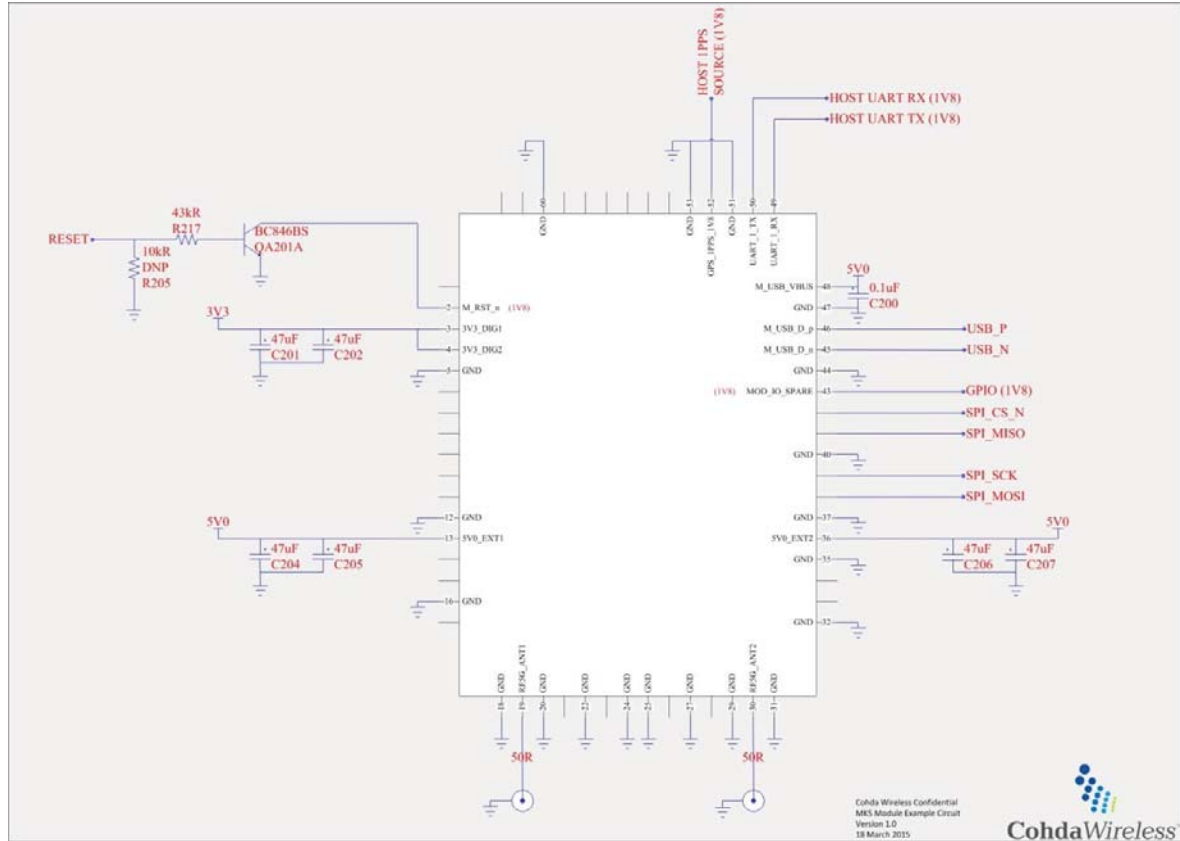

Figure 10 - Example circuit around the MK5 Module

Table 11 - Example circuit Bill of Material

Designator	Part Description	Manufacturer	Manufacturer Part #
C200	CAP CER .1UF 16V X7R 0402	Murata	GRM155R71C104KA88D
C201, C202, C204, C205, C206, C207	CAP CER 47uF 10V X5R 1206 +/-20%	Taiyo Yuden	LMK316BJ476ML-T
R217, R218	RES CHIP 43k OHM 1/16W 0402 +/-1%	Yageo	RC0402FR-0743KL
QA201A	TRANS NPN/NPN BC846BS,115 NXP SOT363	NXP	BC846BS,115

4 Mechanical Specification

The 3D mechanical outline of the MK5 Module is presented in Figure 11 below. The module is a rectangular unit with dimensions of 40mm x 30mm and a height of approximately 3.5mm.

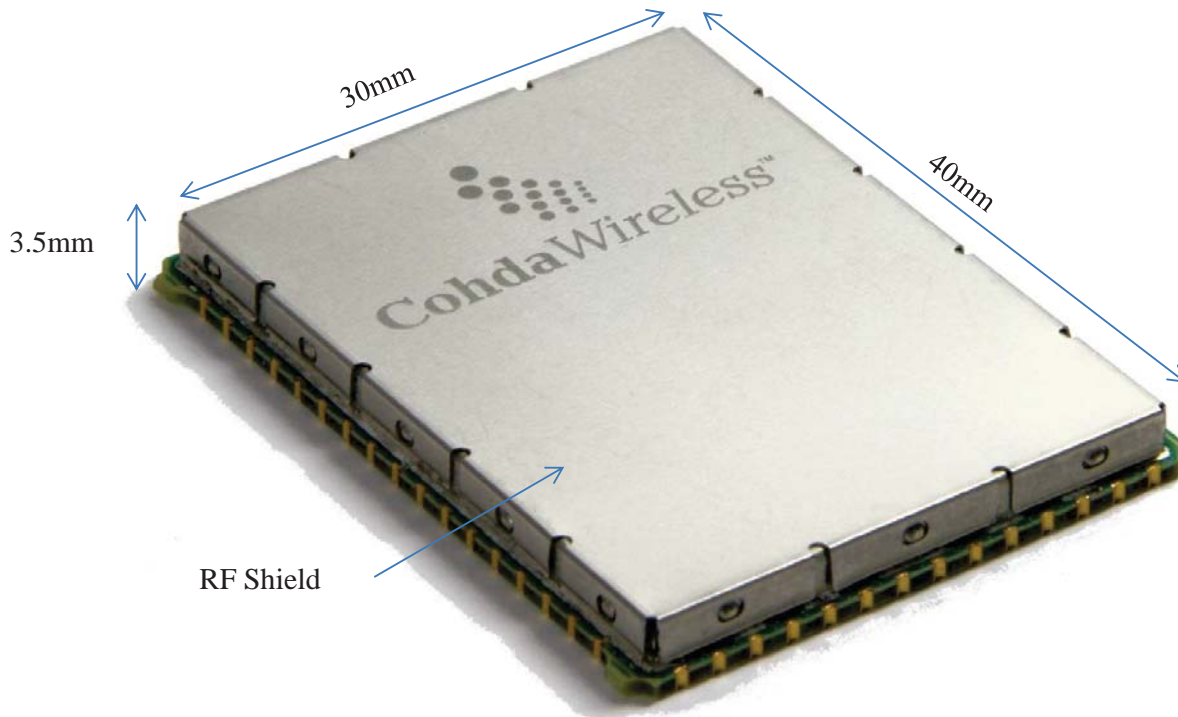

Figure 11 - 3D Mechanical Outline

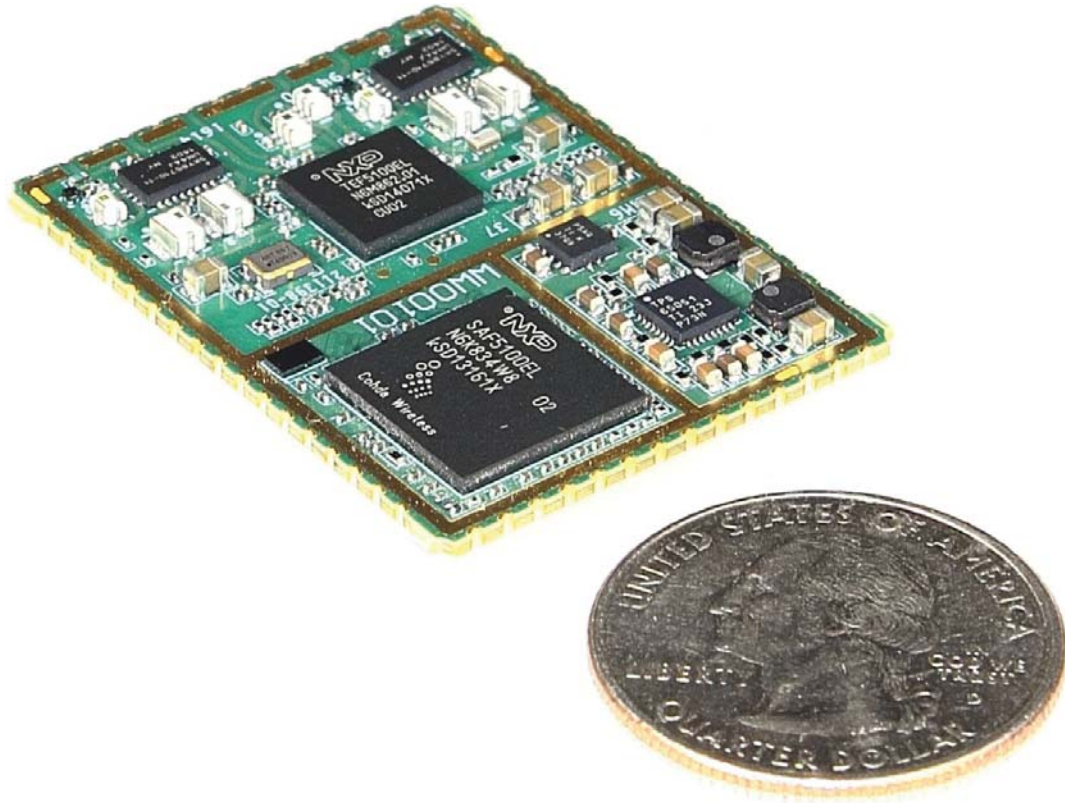
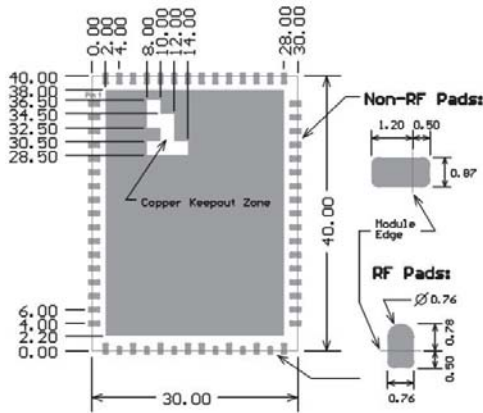

Figure 12 - MK5 Module 3D view (no shield)

The 2D MK5 Module outline and recommended footprint is shown in Figure 13 below.

Top Copper



All dimensions are in millimeter (mm).
 RF pads are for pins: 19, 21, 23, 26, 28, and 30.
 Ensure 50 ohm transition for these pins.
 Apply solder mask expansion based on fabrication technology.
 A good starting point is 0.13 mm (5 mil) expansion from pad edges.

Solder Paste Stencil

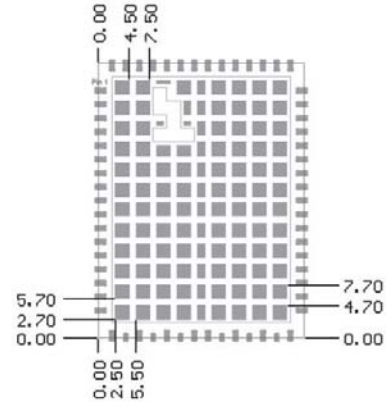

Paste for castellated pads should be 1:1 with copper pad.
 Paste for center ground pad should be divided into 2 x 2 mm squares with 1 mm separation between squares and 0.5 mm from pad edge.

Figure 13 - MK5 Module footprint

The castellated RF edges of the MK5 Module require careful routing to Carrier board antenna connectors. The top layer of the Carrier board should be of high quality low-loss dielectric material such as Megtron6 or equivalent, with a short RF path to the antenna connectors.

5 Reliability and Compliance

The performance of MK5 Module will be valid over a temperature range of -40C to +85C (PCB ambient temperature). Table 12 presents a summary of the environmental requirements on the MK5 Module.

Table 12 - MK5 Module environmental requirements

Item	Standard
Vibration	ISO 16750-3:2007
Mechanical Shock	DIN EN 60068-2-29:1995
Damp Heat	IEC 60068-2-30
Drop Test	ISO16750-3:2007 DIN EN 60068-2-32:1995

5.1 ESD

The MK5 Module interfaces are designed to withstand a touch discharge of $\pm 15\text{kV}$ (150Ohm,150pF).

5.2 Regulatory Information

Note: This equipment has been tested and found to comply with the limits for a Class B digital device, pursuant to part 15 of the FCC Rules. These limits are designed to provide reasonable protection against harmful interference in a residential installation. This equipment generates, uses and can radiate radio frequency energy and, if not installed and used in accordance with the manufacturer's instructions, may cause harmful interference to radio communications.

6 Product Packaging and Handling

The MK5 modules are delivered in a standard 40mm x 40mm tray. Small ESD foam is placed at the tray to prevent the module from movement during shipping and transportation.

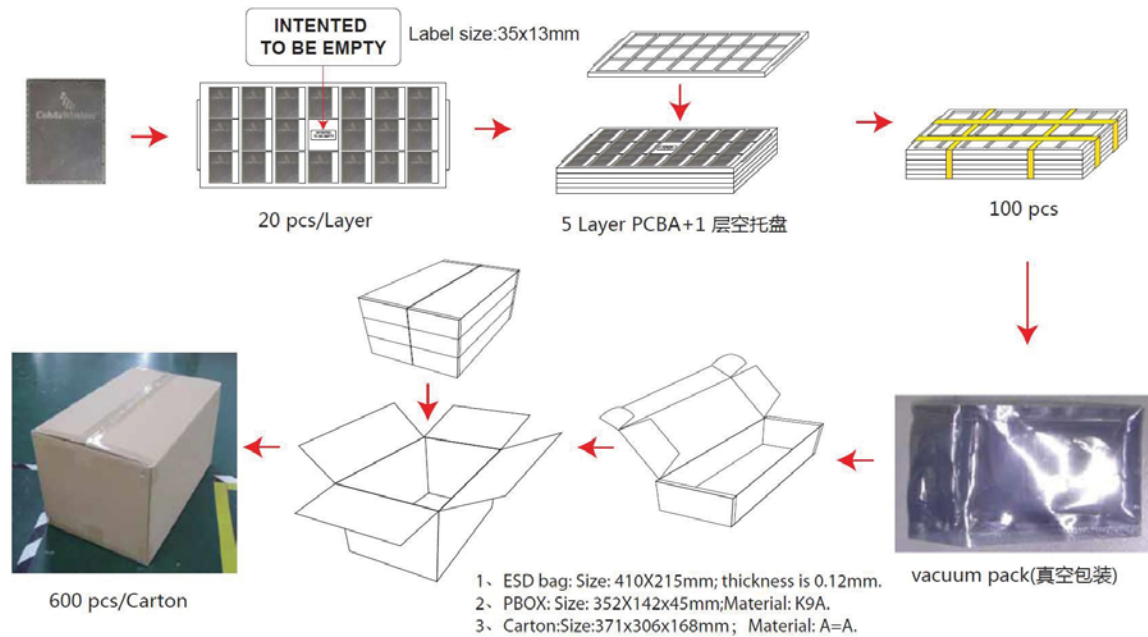

Figure 14 - MK5 Packaging

The MK5 module is an Electrostatic Sensitive Device (ESD) and require special precautions when handling. In addition to standard ESD safety practices, the following measures should be taken into account whenever handling the receiver:

- Unless there is a galvanic coupling between the local GND (i.e. the work table) and the PCB GND, then the first point of contact when handling the PCB must always be between the local GND and PCB GND.
- When handling the RF pin, do not come into contact with any charged capacitors and be careful when contacting materials that can develop charges (e.g. antenna, coax cable ~50-80 pF/m, soldering iron, ...)
- To prevent electrostatic discharge through the RF input, do not touch any exposed antenna area. If there is any risk that such exposed antenna area is touched in non ESD protected work area, implement proper ESD protection measures in the design.
- When soldering RF connectors and patch antennas to the receiver's RF pin, make sure to use an ESD safe soldering iron (tip).

7 Labelling

7.1 Product Label: MK5 Module

Dimension: 2.5 cm x 2 cm

Label paste onto Metal shield

Serial number range is 04E54802xxxx, continue from previous serial number. Increment 2-step (Hex) per Module, ie. 04E54802xx00, xx02, xx04



7.2 Label paste at Anti-Static bag and Pbox.

Dimension: 10 cm x 6 cm or recommended.



Lot No: AAAA_BB_CC

-Where AAAA is lot size

-Where BB is Build Plant or CM code (Aztech is designated as 01)

-Where CC is Build order, please use 02 for coming Build order.

7.3 End Product Labeling

The MK5 is marked with an FCC ID. It must be visible in the end product. If the MK5 is inside the end product, then there must be a label present on the outside of the product with these markings:

Contains Module FCC ID: 2AEGPMK5OBU