

FCC REPORT

(LTE)

Applicant: Antel Communications LLC

Address of Applicant: 21 Bennetts Road, Suite 201, Setauket, NY 11733, USA

Equipment Under Test (EUT)

Product Name: smart phone

Model No.: AL501

Trade mark: Avantel

FCC ID: 2AE62AL501

Applicable standards: FCC CFR Title 47 Part 2
FCC CFR Title 47 Part24 Subpart E
FCC CFR Title 47 Part27 Subpart L

Date of sample receipt: 23 Nov., 2015

Date of Test: 23 Nov., to 21 Dec., 2015

Date of report issued: 21 Dec., 2015

Test Result: PASS*

* In the configuration tested, the EUT complied with the standards specified above.

Authorized Signature:



Bruce Zhang
Laboratory Manager

This report details the results of the testing carried out on one sample. The results contained in this test report do not relate to other samples of the same product and does not permit the use of the CCIS product certification mark. The manufacturer should ensure that all products in series production are in conformity with the product sample detailed in this report.

This report may only be reproduced and distributed in full. If the product in this report is used in any configuration other than that detailed in the report, the manufacturer must ensure the new system complies with all relevant standards.

This document cannot be reproduced except in full, without prior written approval of the Company. Any unauthorized alteration, forgery or falsification of the content or appearance of this document is unlawful and offenders may be prosecuted to the fullest extent of the law. Unless otherwise stated the results shown in this test report refer only to the sample(s) tested and such sample(s) are retained for 90 days only.

2. Version

Version No.	Date	Description
<i>00</i>	<i>21 Dec., 2015</i>	<i>Original</i>

Tested by:**Date:***21 Dec., 2015*

Test Engineer**Reviewed by:****Date:***21 Dec., 2015*

Project Engineer

3. Contents

	Page
1. COVER PAGE	1
2. VERSION	2
3. CONTENTS	3
4. TEST SUMMARY	4
5. GENERAL INFORMATION	5
5.1 CLIENT INFORMATION.....	5
5.2 GENERAL DESCRIPTION OF E.U.T.....	5
5.3 TEST MODES.....	9
5.4 RELATED SUBMITTAL(S) / GRANT (S).....	9
5.5 TEST METHODOLOGY.....	9
5.6 LABORATORY FACILITY.....	9
5.7 LABORATORY LOCATION.....	9
5.8 TEST INSTRUMENTS LIST.....	10
6. SYSTEM TEST CONFIGURATION	11
6.1 EUT CONFIGURATION.....	11
6.2 EUT EXERCISE.....	11
6.3 CONFIGURATION OF TESTED SYSTEM.....	11
6.4 DESCRIPTION OF TEST MODES.....	11
6.5 CONDUCTED OUTPUT POWER.....	12
6.6 PEAK-TO-AVERAGE RATIO.....	17
6.7 OCCUPY BANDWIDTH.....	20
6.8 MODULATION CHARACTERISTIC.....	47
6.9 OUT OF BAND EMISSION AT ANTENNA TERMINALS.....	47
6.10 ERP, EIRP MEASUREMENT.....	276
6.11 FIELD STRENGTH OF SPURIOUS RADIATION MEASUREMENT.....	284
6.12 FREQUENCY STABILITY V.S. TEMPERATURE MEASUREMENT.....	290
6.13 FREQUENCY STABILITY V.S. VOLTAGE MEASUREMENT.....	299
7 TEST SETUP PHOTO	304
8 EUT CONSTRUCTIONAL DETAILS	305

4. Test Summary

Test Item	Section in CFR 47	Result
RF Exposure (SAR)	Part 1.1307 Part 2.1093	Pass(Please refer to SAR Report)
RF Output Power	Part 2.1046 Part 24.232 (c) Part 27.50 (d)(4)	Pass
Peak-to-Average Ratio	Part 24.232 (d)	Pass
Modulation Characteristics	Part 2.1047	Pass
99% & -26 dB Occupied Bandwidth	Part 2.1049 Part 24.238 Part 27.53(h)	Pass
Spurious Emissions at Antenna Terminal	Part 2.1051 Part 24.238 (a) Part 27.53 (h)	Pass
Field Strength of Spurious Radiation	Part 2.1053 Part 24.238 (a) Part 27.53 (h)	Pass
Out of band emission, Band Edge	Part 22.917 (a) Part 24.238 (a) Part 27.53 (h)	Pass
Frequency stability vs. temperature	Part 2.1055(a)(1)(b)	Pass
Frequency stability vs. voltage	Part 2.1055(d)(1)(2)	Pass

Pass: The EUT complies with the essential requirements in the standard.

5. General Information

5.1 Client Information

Applicant:	Antel Communications LLC
Address of Applicant:	21 Bennetts Road, Suite 201, Setauket, NY 11733, USA
Manufacturer:	AMER Mobile Technology Co.,LTD
Address of Manufacturer:	17F, Tower B, HuiHai Center, Chuangye Road no.1,Longhua new district, Shenzhen. China.

5.2 General Description of E.U.T.

Product Name:	smart phone
Model No.:	AL501
Operation Frequency range:	LTE Band 2: TX: 1850MHz-1910MHz, RX: 1930MHz-1990MHz LTE Band 4:TX: 1710MHz-1755MHz, RX: 2110MHz-2155MHz
Modulation type:	QPSK, 16QAM
Antenna type:	Internal Antenna
Antenna gain:	LTE Band 2: 0.51dBi LTE Band 4: 0.53dBi
AC adapter:	Model: AL501 Input:100-240V AC, 50/60Hz 0.15A Output:5V DC MAX 1000mA
Power supply:	Rechargeable Li-ion Battery DC3.7V-2150mAh

Operation Frequency List:

LTE Band 2(1.4MHz)		LTE Band 2(3MHz)	
Channel	Frequency (MHz)	Channel	Frequency (MHz)
18607	1850.70	18615	1851.50
18608	1850.80	18616	1851.60
....
18899	1879.90	18899	1879.90
18900	1880.00	18900	1880.00
18901	1880.10	18901	1880.10
...
19193	1909.20	19185	1908.40
19194	1909.30	19186	1908.50
LTE Band 2(5MHz)		LTE Band 2(10MHz)	
Channel	Frequency (MHz)	Channel	Frequency (MHz)
18625	1852.50	18650	1855.00
18626	1852.60	18651	1855.10
....
18899	1879.90	18899	1879.90
18900	1880.00	18900	1880.00
18901	1880.10	18901	1880.10
...
19175	1907.40	19150	1904.90
19176	1907.50	19151	1905.00
LTE Band 2(15MHz)		LTE Band 2(20MHz)	
Channel	Frequency (MHz)	Channel	Frequency (MHz)
18675	1857.50	18700	1860.00
18676	1857.60	18701	1860.10
....
18899	1879.90	18899	1879.90
18900	1880.00	18900	1880.00
18901	1880.10	18901	1880.10
...
19125	1902.40	19100	1899.90
19126	1902.50	19101	1900.00

LTE Band 4(1.4MHz)		LTE Band 4(3MHz)	
Channel	Frequency (MHz)	Channel	Frequency (MHz)
19957	1710.70	19965	1711.50
19958	1710.80	19966	1711.60
....
20174	1732.40	20174	1732.40
20175	1732.50	20175	1732.50
20176	1732.60	20176	1732.60
...
20392	1754.20	20384	1753.40
20393	1754.30	20385	1753.50
LTE Band 4(5MHz)		LTE Band 4(10MHz)	
Channel	Frequency (MHz)	Channel	Frequency (MHz)
19975	1712.50	20000	1715.00
19976	1712.60	20001	1715.10
....
20174	1732.40	20174	1732.40
20175	1732.50	20175	1732.50
20176	1732.60	20176	1732.60
...
20374	1752.40	20349	1749.90
20375	1752.50	20350	1750.00
LTE Band 4(15MHz)		LTE Band 4(20MHz)	
Channel	Frequency (MHz)	Channel	Frequency (MHz)
20025	1717.50	20050	1720.00
20026	1717.60	20051	1720.10
....
20174	1732.40	20174	1732.40
20175	1732.50	20175	1732.50
20176	1732.60	20176	1732.60
...
20324	1747.40	20299	1744.90
20325	1747.50	20300	1745.00

Regards to the operating frequency range, the lowest frequency, the middle frequency, and the highest frequency of channel were selected to perform the test, and the selected channels as below:

LTE Band 2(1.4MHz)			LTE Band 2(3MHz)		
Channel	Frequency (MHz)		Channel	Frequency (MHz)	
Lowest channel	18607	1850.70	Lowest channel	18615	1851.50
Middle channel	18900	1880.00	Middle channel	18900	1880.00
Highest channel	19193	1909.30	Highest channel	19185	1908.50
LTE Band 2(5MHz)			LTE Band 2(10MHz)		
Channel	Frequency (MHz)		Channel	Frequency (MHz)	
Lowest channel	18625	1852.50	Lowest channel	18650	1855.00
Middle channel	18900	1880.00	Middle channel	18900	1880.00
Highest channel	19175	1907.50	Highest channel	19150	1905.00
LTE Band 2(15MHz)			LTE Band 2(20MHz)		
Channel	Frequency (MHz)		Channel	Frequency (MHz)	
Lowest channel	18675	1857.50	Lowest channel	18700	1860.00
Middle channel	18900	1880.00	Middle channel	18900	1880.00
Highest channel	19125	1902.50	Highest channel	19100	1900.00

LTE Band 4(1.4MHz)			LTE Band 4(3MHz)		
Channel:	Frequency (MHz)		Channel	Frequency (MHz)	
Lowest channel	19957	1710.70	Lowest channel	19965	1711.50
Middle channel	20175	1732.50	Middle channel	20175	1732.50
Highest channel	20393	1754.30	Highest channel	20385	1753.50
LTE Band 4(5MHz)			LTE Band 4(10MHz)		
Channel	Frequency (MHz)		Channel	Frequency (MHz)	
Lowest channel	19975	1712.50	Lowest channel	20000	1715.00
Middle channel	20175	1732.50	Middle channel	20175	1732.50
Highest channel	20375	1752.50	Highest channel	20350	1750.00
LTE Band 4(15MHz)			LTE Band 4(20MHz)		
Channel	Frequency (MHz)		Channel	Frequency (MHz)	
Lowest channel	20025	1717.50	Lowest channel	20050	1720.00
Middle channel	20175	1732.50	Middle channel	20175	1732.50
Highest channel	20325	1747.50	Highest channel	20300	1745.00

5.3 Test modes

Data mode (LTE band 2(QPSK))	Keep the EUT in data communicating mode on LTE band 2(QPSK). (LTE band2(1.4MHz), LTE band2(3MHz), LTE band2(5MHz), LTE band2(10MHz), LTE band2(15MHz), LTE band2(20MHz))
Data mode (LTE band 2(16QAM))	Keep the EUT in data communicating mode on LTE band 2(16QAM). (LTE band2(1.4MHz), LTE band2(3MHz), LTE band2(5MHz), LTE band2(10MHz), LTE band2(15MHz), LTE band2(20MHz))
Data mode (LTE band 4(QPSK))	Keep the EUT in data communicating mode on LTE band 4(QPSK). (LTE band 4(1.4MHz), LTE band 4(3MHz), LTE band 4(5MHz), LTE band 4(10MHz), LTE band 4(15MHz), LTE band 4(20MHz))
Data mode (LTE band 4(16QAM))	Keep the EUT in data communicating mode on LTE band 4(16QAM). (LTE band 4(1.4MHz), LTE band 4(3MHz), LTE band 4(5MHz), LTE band 4(10MHz), LTE band 4(15MHz), LTE band 4(20MHz))
Remark :	Just the worst case data were shown in the report.

5.4 Related Submittal(s) / Grant (s)

This submittal(s) (test report) is filing to comply with Section Part 24 subpart E, Part 27 subpart L of the FCC CFR 47 Rules.

5.5 Test Methodology

Both conducted and radiated testing were performed according to the procedures document on TIA/EIA 603 and FCC CFR 47clause 2.1046, 2.1047, 2.1049, 2.1051, 2.1053, 2.1055 and 2.1057

5.6 Laboratory Facility

The test facility is recognized, certified, or accredited by the following organizations:

- **FCC - Registration No.: 817957**
Shenzhen Zhongjian Nanfang Testing Co., Ltd. EMC Laboratory has been registered and fully described in a report filed with the (FCC) Federal Communications Commission. The acceptance letter from the FCC is maintained in out files. Registration 817957, February 27, 2012.
- **IC - Registration No.: 10106A-1**
The 3m Semi-anechoic chamber of Shenzhen Zhongjian Nanfang Testing Co., Ltd. has been Registered by Certification and Engineering Bureau of Industry Canada for radio equipment testing with Registration No.: 10106A-1.
- **CNAS - Registration No.: CNAS L6048**
Shenzhen Zhongjian Nanfang Testing Co., Ltd. is accredited to ISO/IEC 17025:2005 General Requirements for the Competence of Testing and Calibration laboratories for the competence of testing. The Registration No. is CNAS L6048.

5.7 Laboratory Location

Shenzhen Zhongjian Nanfang Testing Co., Ltd.
Address: No.B-C, 1/F., Building 2, Laodong No.2 Industrial Park, Xixiang Road,
Bao'an District, Shenzhen, Guangdong, China
Tel: +86-755-23118282
Fax: +86-755-23116366

5.8 Test Instruments list

Test Equipment	Manufacturer	Model No.	Inventory No.	Cal. Date (mm-dd-yy)	Cal. Due date (mm-dd-yy)
3m SAC	SAEMC	9(L)*6(W)* 6(H)	CCIS0001	08-23-2014	08-22-2017
BiConiLog Antenna	SCHWARZBECK	VULB9163	CCIS0005	03-28-2015	03-28-2016
Horn Antenna	SCHWARZBECK	BBHA9120D	CCIS0006	03-28-2015	03-28-2016
Pre-amplifier (10kHz-1.3GHz)	HP	8447D	CCIS0003	04-01-2015	03-31-2016
Pre-amplifier (1GHz-18GHz)	Compliance Direction Systems Inc.	PAP-1G18	CCIS0011	04-01-2015	03-31-2016
Pre-amplifier (18-26.5GHz)	Rohde & Schwarz	AFS33-18002 650-30-8P-44	GTS218	04-01-2015	03-31-2016
Horn Antenna	ETS-LINDGREN	3160	GTS217	04-01-2015	03-31-2016
Logarithm Antenna	Schwarzbeck	VUSLP 9111	CCIS0045	04-01-2015	03-31-2016
Spectrum analyzer 9k-30GHz	Rohde & Schwarz	FSP30	CCIS0023	03-28-2015	03-28-2016
EMI Test Receiver	Rohde & Schwarz	ESRP7	CCIS0167	03-28-2015	03-28-2016
Loop antenna	Laplace instrument	RF300	EMC0701	04-01-2015	03-31-2016
LTE Simulated station	Anritsu	MT8820C	CCIS0170	04-08-2015	04-08-2016
Temperature and humidity chamber	FoshanHengpu	HPGDS-500	CCIS0240	04-01-2015	03-31-2016

6. System test configuration

6.1 EUT Configuration

The EUT configuration for testing is installed on RF field strength measurement to meet the commission’s requirement and operating in a manner which intends to maximize its emission characteristics in a continuous normal application.

6.2 EUT Exercise

The EUT (Transmitter) was operated in the engineering mode to fix the Tx frequency which was for the purpose of the measurements.

6.3 Configuration of Tested System

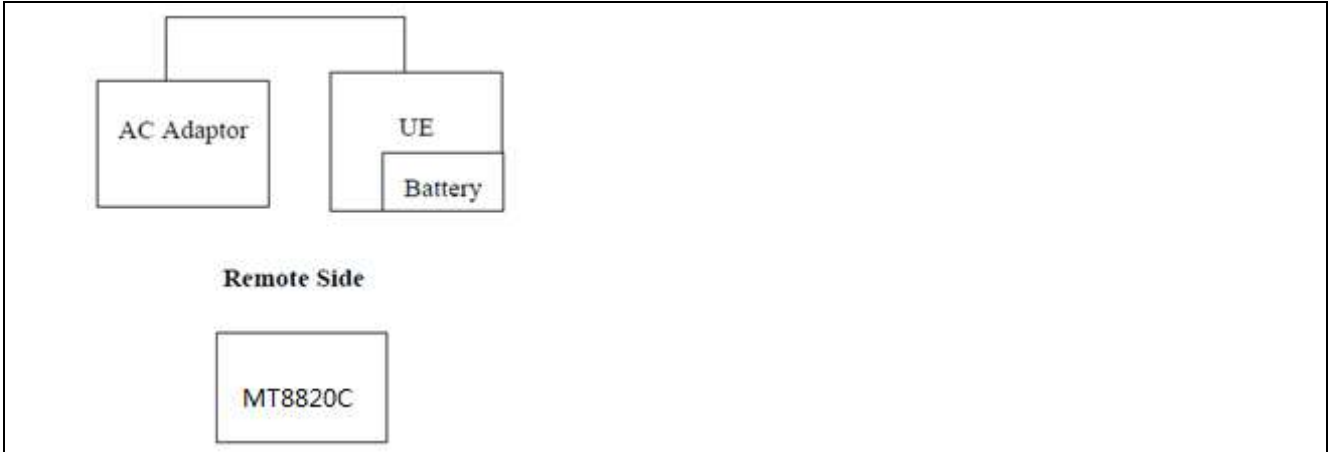

6.4 Description of Test Modes

The EUT has been tested under operating condition.
 EUT staying in continuous transmitting mode. Channel Low, Mid and High for each type band with rated data rate were chosen for full testing.
 The field strength of spurious radiation emission was measured as EUT stand-up position (H mode) and lie down position (E1, E2 mode) for three modes (LTE Band 2, LTE Band 4) with power adaptor, earphone and Data cable. The worst-case H mode for LTE Band 2, LTE Band 4.

6.5 Conducted Output Power

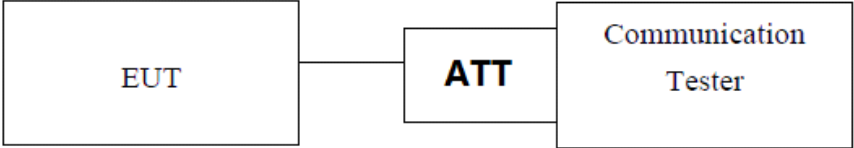
Test Requirement:	FCC Part 24.232 (c), part 27.50(d)
Test Method:	FCC part2.1046
Limit:	LTE Band2: 2W LTE Band 4: 1W
Test setup:	 <p style="text-align: center;"><i>Note: Measurement setup for testing on Antenna connector</i></p>
Test Procedure:	The transmitter output was connected to a calibrated attenuator, the other end of which was connected to the simulated station. Transmitter output power was read off in dBm.
Test Instruments:	Refer to section 5.8 for details
Test mode:	Refer to section 5.3 for details
Test results:	Passed

Measurement Data

LTE Band 2 part

LTE Band	Bandwidth (MHz)	Modulation	RB Size	RB Offset	Average Power (dBm)		
					18607	18900	19193
					1850.7MHz	1880.0MHz	1909.3MHz
2	1.4	QPSK	1	0	22.52	22.41	22.20
			1	2	22.41	22.36	22.19
			1	5	22.38	22.39	22.21
			3	0	22.54	22.53	22.30
			3	1	22.52	22.54	22.29
			3	2	22.60	22.50	22.31
		16QAM	1	0	21.38	21.25	21.26
			1	2	21.34	21.40	21.48
			1	5	21.42	21.43	21.53
			3	0	21.45	21.48	21.31
			3	1	21.32	21.46	21.32
			3	2	21.54	21.32	21.34
			6	0	20.43	20.37	20.21
LTE Band	Bandwidth (MHz)	Modulation	RB Size	RB Offset	Average Power (dBm)		
					18615	18900	19185
					1851.5MHz	1880.0MHz	1908.5MHz
2	3	QPSK	1	0	22.28	22.31	22.23
			1	7	22.33	22.33	22.25
			1	14	22.30	22.42	22.13
			8	0	21.52	21.54	21.42
			8	4	21.51	21.58	21.36
			8	7	21.50	21.57	21.38
		16QAM	15	0	21.57	21.57	21.38
			1	0	21.63	21.44	21.58
			1	7	21.44	21.38	21.53
			1	14	21.65	21.41	21.51
			8	0	20.46	20.59	20.32
			8	4	20.44	20.41	20.25
			8	7	20.56	20.46	20.22
			15	0	20.48	20.47	20.15
LTE Band	Bandwidth (MHz)	Modulation	RB Size	RB Offset	Average Power (dBm)		
					18625	18900	19175
					1852.5MHz	1880.0MHz	1907.5MHz
2	5	QPSK	1	0	22.53	22.47	22.43
			1	12	22.50	22.36	22.40
			1	24	22.41	22.36	22.26
			12	0	21.56	21.58	21.50
			12	6	21.60	21.59	21.51
			12	11	21.55	21.62	21.47
		16QAM	25	0	21.53	21.61	21.45
			1	0	21.51	21.86	21.79
			1	12	21.44	21.79	21.63
			1	24	21.43	21.64	21.55
			12	0	20.48	20.45	20.38
			12	6	20.45	20.47	20.35
			12	11	20.45	20.43	20.30
			25	0	20.48	20.45	20.38

LTE Band	Bandwidth (MHz)	Modulation	RB Size	RB Offset	Average Power (dBm)		
					18650	18900	19150
					1855.0MHz	1880.0MHz	1905.0MHz
2	10	QPSK	1	0	22.26	22.50	22.39
			1	24	22.35	22.24	22.36
			1	49	22.40	22.06	21.76
			25	0	21.60	21.56	21.47
			25	12	21.56	21.60	21.44
			25	24	21.53	21.49	21.48
		16QAM	50	0	21.63	21.65	21.53
			1	0	21.68	21.59	21.84
			1	24	21.53	21.21	21.38
			1	49	21.79	21.30	21.04
			25	0	20.50	20.51	20.46
			25	12	20.52	20.53	20.45
			25	24	20.49	20.37	20.33
			50	0	20.48	20.52	20.40
LTE Band	Bandwidth (MHz)	Modulation	RB Size	RB Offset	Average Power (dBm)		
					18675	18900	19125
					1857.5MHz	1880.0MHz	1902.5MHz
2	15	QPSK	1	0	22.30	22.47	22.48
			1	37	22.39	22.18	22.37
			1	74	22.37	22.25	21.89
			36	0	21.59	21.66	21.56
			36	16	21.58	21.56	21.54
			36	35	21.56	21.53	21.52
			75	0	21.58	21.67	21.52
		16QAM	1	0	21.96	21.67	22.08
			1	37	21.62	21.52	21.99
			1	74	21.64	21.46	21.33
			36	0	20.57	20.58	20.52
			36	16	20.61	20.51	20.45
			36	35	20.57	20.45	20.39
			75	0	20.51	20.47	20.48
LTE Band	Bandwidth (MHz)	Modulation	RB Size	RB Offset	Average Power (dBm)		
					18700	18900	19100
					1860.0MHz	1880.0MHz	1900.0MHz
2	20	QPSK	1	0	22.40	22.56	22.61
			1	49	22.45	22.12	22.42
			1	99	22.45	22.32	22.06
			50	0	21.68	21.65	21.66
			50	24	21.57	21.55	21.55
			50	49	21.58	21.50	21.54
			100	0	21.53	21.65	21.57
		16QAM	1	0	21.69	21.79	21.65
			1	49	21.80	21.77	21.71
			1	99	21.78	21.50	21.67
			50	0	20.64	20.60	20.48
			50	24	20.58	20.59	20.49
			50	49	20.45	20.52	20.50
			100	0	20.55	20.51	20.44

LTE Band 4 part

LTE Band	Bandwidth (MHz)	Modulation	RB Size	RB Offset	Average Power (dBm)		
					19957	20175	20393
					1710.7MHz	1732.5MHz	1754.3MHz
4	1.4	QPSK	1	0	21.58	21.62	21.72
			1	2	21.52	21.61	21.70
			1	5	21.55	21.62	21.78
			3	0	21.68	21.85	21.89
			3	1	21.69	21.74	21.85
			3	2	21.67	21.79	21.87
		16QAM	6	0	20.58	20.73	20.97
			1	0	20.42	20.93	21.73
			1	2	20.94	20.68	20.8/5
			1	5	20.62	20.66	20.86
			3	0	20.71	20.69	20.91
			3	1	20.50	20.64	20.80
			3	2	20.67	20.64	20.71
			6	0	19.63	19.65	19.81
LTE Band	Bandwidth (MHz)	Modulation	RB Size	RB Offset	Average Power (dBm)		
					19965	20175	20385
					1711.5MHz	1732.5MHz	1753.5MHz
4	3	QPSK	1	0	21.56	21.67	21.85
			1	7	21.56	21.70	21.78
			1	14	21.54	21.73	21.70
			8	0	20.63	20.68	20.95
			8	4	20.57	20.69	20.98
			8	7	20.61	20.68	20.93
		16QAM	15	0	20.63	20.69	20.89
			1	0	20.35	20.47	20.93
			1	7	20.56	20.64	20.75
			1	14	20.63	20.59	20.82
			8	0	19.70	19.62	19.84
			8	4	19.61	19.83	19.77
			8	7	19.56	19.82	19.84
			15	0	19.66	19.52	19.89
LTE Band	Bandwidth (MHz)	Modulation	RB Size	RB Offset	Average Power (dBm)		
					19975	20175	20375
					1712.5MHz	1732.5MHz	1752.5MHz
4	5	QPSK	1	0	21.65	21.74	21.87
			1	12	21.64	21.70	21.85
			1	24	21.57	21.63	21.76
			12	0	20.66	20.72	20.96
			12	6	20.65	20.82	20.97
			12	11	20.64	20.72	20.90
		16QAM	25	0	20.62	20.73	20.93
			1	0	20.72	20.53	20.36
			1	12	20.66	20.46	20.34
			1	24	20.45	20.91	20.85
			12	0	20.68	19.71	19.78
			12	6	19.63	19.73	19.73
			12	11	19.54	19.67	19.80
			25	0	19.60	19.65	19.86

LTE Band	Bandwidth (MHz)	Modulation	RB Size	RB Offset	Average Power (dBm)		
					20000	20175	20350
					1715.0MHz	1732.5MHz	1750.0MHz
4	10	QPSK	1	0	21.67	21.71	21.88
			1	24	21.56	21.58	21.79
			1	49	21.58	21.62	21.79
			25	0	20.65	20.72	20.92
			25	12	20.66	20.75	20.96
			25	24	20.62	20.71	20.90
			50	0	20.66	20.80	20.94
		16QAM	1	0	21.01	20.73	21.01
			1	24	20.64	20.56	20.70
			1	49	20.98	20.67	20.87
			25	0	19.69	19.79	19.85
			25	12	19.65	19.74	19.92
			25	24	19.71	19.67	19.87
			50	0	19.69	19.64	19.84
LTE Band	Bandwidth (MHz)	Modulation	RB Size	RB Offset	Average Power (dBm)		
					20025	20175	20325
					1717.5MHz	1732.5MHz	1747.5MHz
4	15	QPSK	1	0	21.73	21.82	21.96
			1	37	21.68	21.75	21.88
			1	74	21.70	21.73	21.84
			36	0	20.69	20.83	20.98
			36	16	20.73	20.73	20.97
			36	35	20.72	20.76	20.94
			75	0	20.67	20.78	20.94
		16QAM	1	0	20.98	20.97	21.06
			1	37	20.85	20.80	21.07
			1	74	20.87	20.77	20.93
			36	0	19.72	19.82	19.95
			36	16	19.77	19.74	19.87
			36	35	19.75	19.68	19.87
			75	0	19.70	19.79	19.89
LTE Band	Bandwidth (MHz)	Modulation	RB Size	RB Offset	Average Power (dBm)		
					20050	20175	20300
					1720.0MHz	1732.5MHz	1745.0MHz
4	20	QPSK	1	0	21.82	21.86	21.97
			1	49	21.76	21.68	21.82
			1	99	21.78	21.70	21.86
			50	0	20.73	20.87	20.92
			50	24	20.69	20.78	20.91
			50	49	20.74	20.70	20.90
			100	0	20.70	20.83	20.96
		16QAM	1	0	20.83	20.92	21.64
			1	49	20.88	20.67	21.08
			1	99	20.50	20.75	20.74
			50	0	19.77	19.84	19.84
			50	24	19.76	19.80	19.89
			50	49	19.73	19.72	19.83
			100	0	19.73	19.83	19.90

6.6 Peak-to-Average Ratio

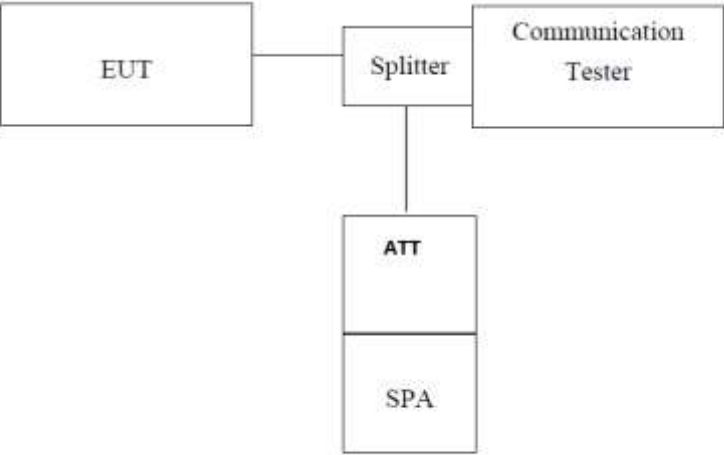
Test Requirement:	FCC part 24.232(d)
Limit:	The peak-to-average ratio (PAR) of the transmission may not exceed 13 dB.
Test setup:	 <p><i>Note: Measurement setup for testing on Antenna connector</i></p>
Test Procedure:	<ol style="list-style-type: none"> 1 The RF output of the transceiver was connected to a spectrum analyzer through appropriate attenuation. 2 Set the CCDF option in spectrum analyzer, $RBW \geq OBW$, 3 Set the EUT working in highest power level, measured and recorded the 0.1% as PAPR level. 4 Repeat step 1~3 at other frequency and modulations.
Test Instruments:	Refer to section 5.8 for details
Test mode:	Refer to section 5.3 for details
Test results:	Passed

BW(MHz)	Modulation	RB Size	RB Offset	PAPR
LTE Band 2 (Middle Channel)				
20MHz	QPSK	100	0	4.61
	16QAM	100	0	5.48
LTE Band 4 (Middle Channel)				
20MHz	QPSK	100	0	4.49
	16QAM	100	0	5.45

Test plots as below:

LTE Band 2 Middle channel

Modulation: QPSK

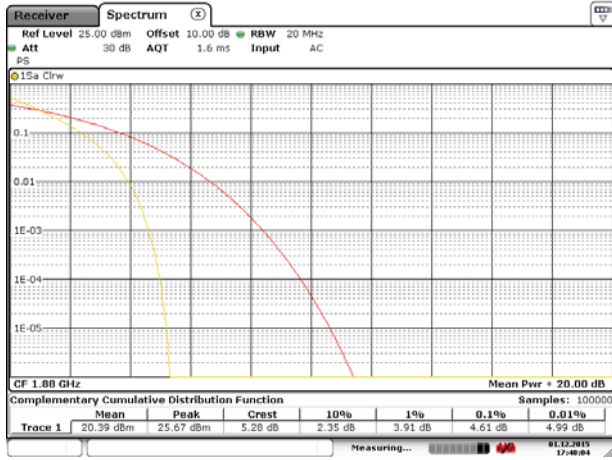

Date: 1.DBC.2015 17:48:04

Modulation:16QAM

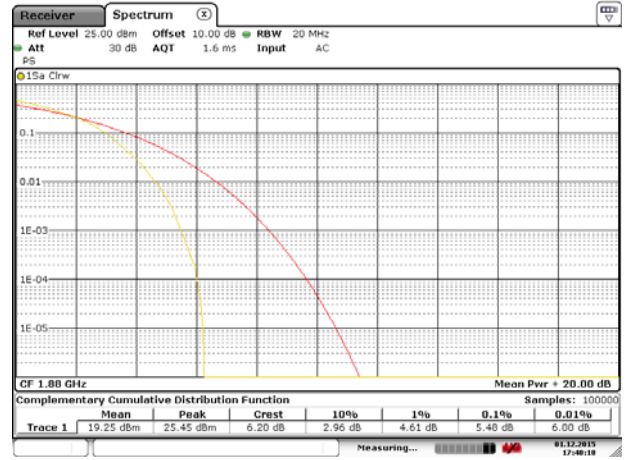

Date: 1.DBC.2015 17:48:18

LTE Band 4 Middle channel

Modulation: QPSK

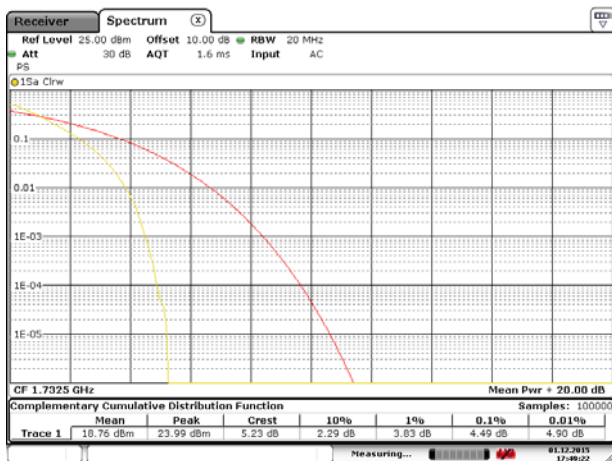

Date: 1.DBC.2015 17:49:22

Modulation:16QAM

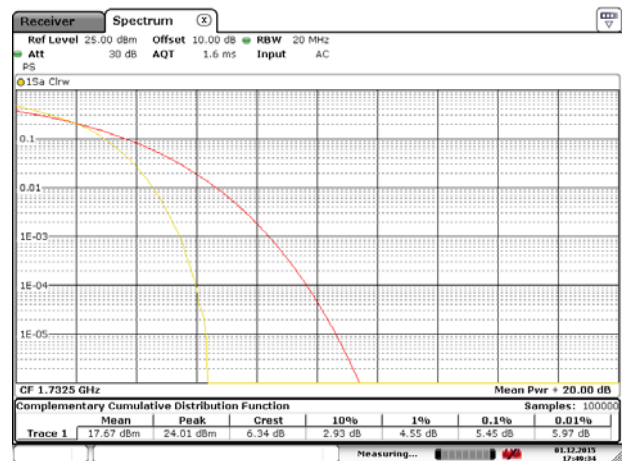

Date: 1.DBC.2015 17:49:34

6.7 Occupy Bandwidth

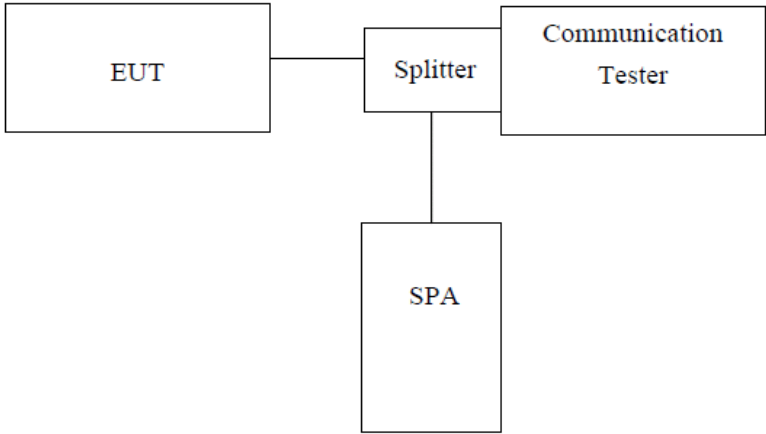
Test Requirement:	FCC Part 24.238,part 27.53(h)
Test Method:	FCC part2.1049
Test setup:	 <p style="text-align: center;"><i>Note: Measurement setup for testing on Antenna connector</i></p>
Test Procedure:	<ol style="list-style-type: none"> 1. The EUT's output RF connector was connected with a short cable to the spectrum analyzer 2. RBW was set to about 1% ~ 5% of emission BW, VBW= 3 times RBW. 3. -26dBc display line was placed on the screen (or 99% bandwidth), the occupied bandwidth is the delta frequency between the two points where the display line intersects the signal trace.
Test Instruments:	Refer to section 5.8 for details
Test mode:	Refer to section 5.3 for details
Test results:	Passed

Measurement Data

LTE Band 2 part:

EUT Mode	Channel	Frequency(MHz)	Modulation	99% OBW (kHz)	-26dBcEBW (kHz)
1.4MHz	18607	1850.70	16QAM	1104	1266
			QPSK	1104	1272
	18900	1880.00	16QAM	1098	1296
			QPSK	1104	1272
	19193	1909.30	16QAM	1098	1260
			QPSK	1098	1272
3MHz	18615	1851.50	16QAM	2736	3024
			QPSK	2736	3060
	18900	1880.00	16QAM	2724	3024
			QPSK	2448	3084
	19185	1908.50	16QAM	2736	3024
			QPSK	2736	3048
5MHz	18625	1852.50	16QAM	4520	5040
			QPSK	4520	5080
	18900	1880.00	16QAM	4500	5000
			QPSK	4560	5040
	19175	1907.50	16QAM	4500	4980
			QPSK	4520	5000
10MHz	18650	1855.00	16QAM	9120	10120
			QPSK	9120	10240
	18900	1880.00	16QAM	9160	10200
			QPSK	9120	10200
	19150	1905.00	16QAM	9080	10200
			QPSK	9080	10200
15MHz	18675	1857.50	16QAM	13500	14940
			QPSK	13620	14880
	18900	1880.00	16QAM	13560	14940
			QPSK	13560	15000
	19125	1902.50	16QAM	13560	14880
			QPSK	13500	14940
20MHz	18700	1860.00	16QAM	17920	19440
			QPSK	18160	19440
	18900	1880.00	16QAM	18000	19520
			QPSK	18080	19520
	19100	1900.00	16QAM	18000	19520
			QPSK	18000	19600

LTE Band 4 part:

EUT Mode	Channel	Frequency(MHz)	Modulation	99% OBW (kHz)	-26dBcEBW (kHz)
1.4MHz	19957	1710.7	16QAM	1098	1278
			QPSK	1098	1278
	20175	1732.5	16QAM	1104	1284
			QPSK	1104	1278
	20393	1754.3	16QAM	1098	1254
			QPSK	1104	1272
3MHz	19965	1711.5	16QAM	2712	3012
			QPSK	2736	3060
	20175	1732.5	16QAM	2736	3012
			QPSK	2748	3084
	20385	1750.5	16QAM	2736	3012
			QPSK	2748	3048
5MHz	19975	1712.5	16QAM	4520	5040
			QPSK	4520	4980
	20175	1732.5	16QAM	4520	5040
			QPSK	4520	5040
	20375	1752.5	16QAM	4520	5040
			QPSK	4520	5020
10MHz	20000	1715.0	16QAM	9120	10200
			QPSK	9120	10280
	20175	1732.5	16QAM	9080	9080
			QPSK	9080	10440
	20350	1750.0	16QAM	9120	10200
			QPSK	9120	10240
15MHz	20025	1717.5	16QAM	13560	14940
			QPSK	13620	14880
	20175	1732.5	16QAM	13560	15000
			QPSK	13560	14940
	20325	1747.5	16QAM	13560	14880
			QPSK	13560	14940
20MHz	20050	1720.0	16QAM	18000	19600
			QPSK	18080	19600
	20175	1732.5	16QAM	18000	19600
			QPSK	18160	19600
	20300	1745.0	16QAM	18080	19520
			QPSK	18080	19440

Test plot as follows:

LTE Band 2 part

Test Item:99% Occupy bandwidth
 BW: 1.4MHz

Modulation: 16QAM

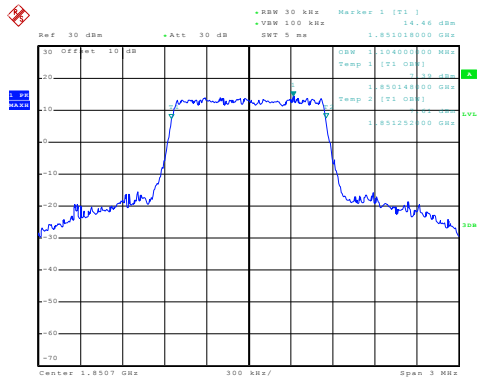

Date: 21.NOV.2015 21:09:25

Modulation: QPSK

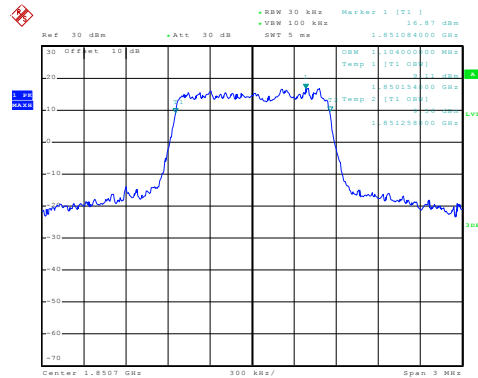

Date: 21.NOV.2015 21:08:49

Lowest channel

Modulation:16QAM

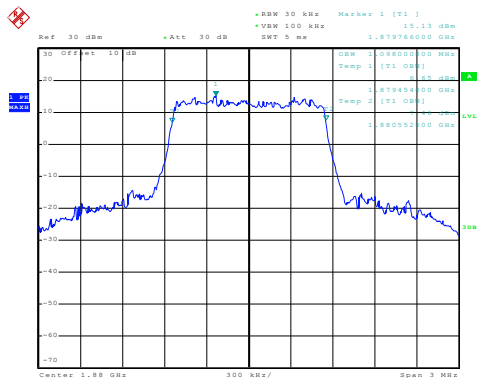

Date: 21.NOV.2015 21:10:24

Modulation:QPSK

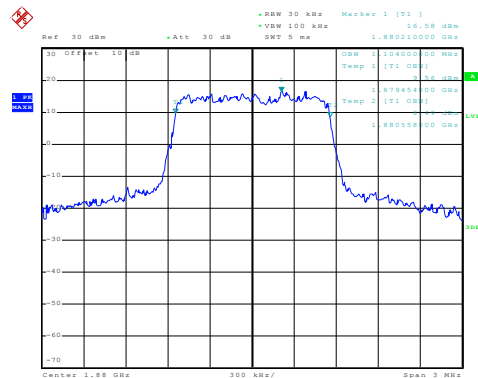

Date: 21.NOV.2015 21:09:50

Middle channel

Modulation:16QAM

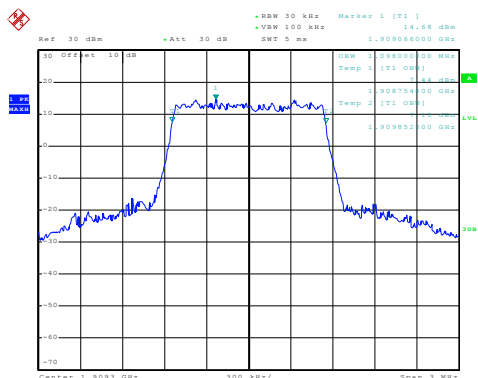

Date: 21.NOV.2015 21:11:34

Modulation:QPSK

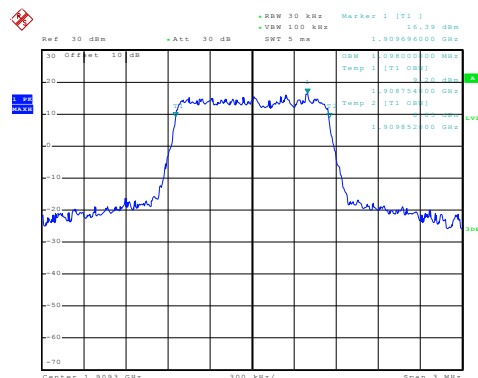

Date: 21.NOV.2015 21:10:57

Highest channel

Test Item:99% Occupy bandwidth
 BW: 3MHz

Modulation:16QAM

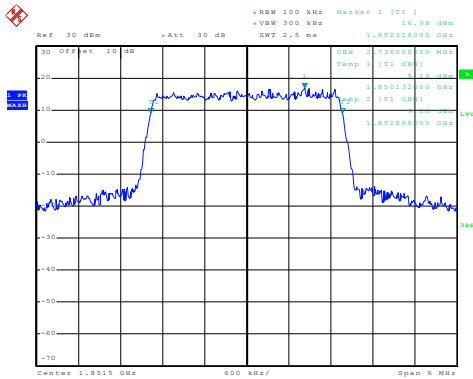

Date: 21.NOV.2015 21:13:08

Modulation:QPSK

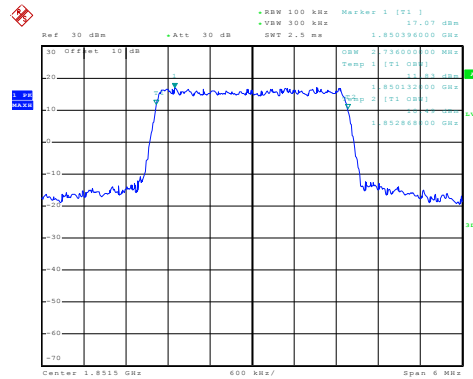

Date: 21.NOV.2015 21:12:34

Lowest channel

Modulation:16QAM

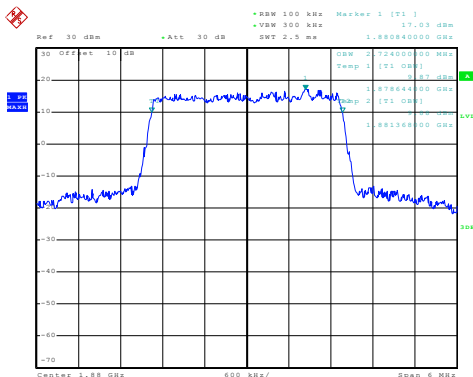

Date: 21.NOV.2015 21:14:11

Modulation:QPSK

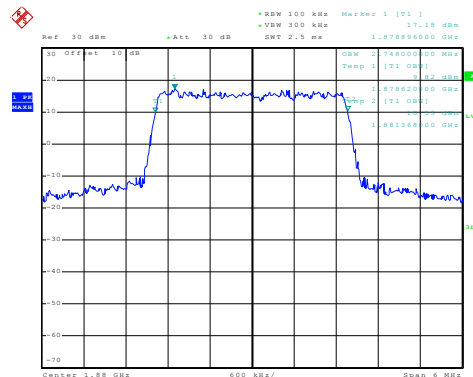

Date: 21.NOV.2015 21:13:58

Middle channel

Modulation:16QAM

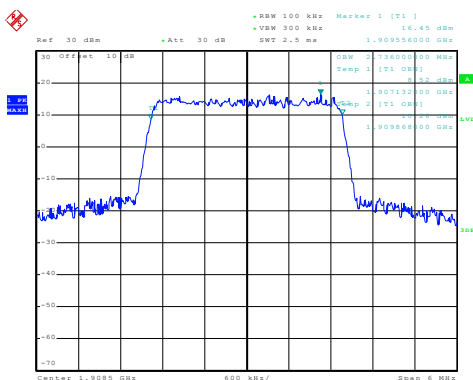

Date: 21.NOV.2015 21:15:31

Modulation:QPSK

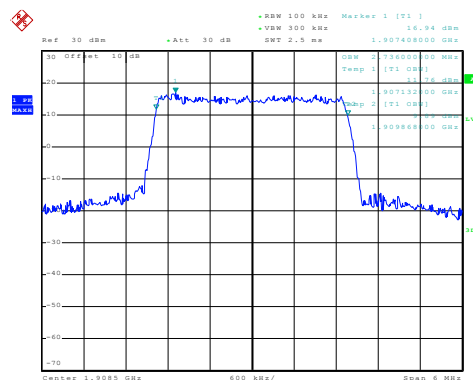

Date: 21.NOV.2015 21:15:20

Highest channel

Test Item:99% Occupy bandwidth
 BW: 5MHz

Modulation:16QAM

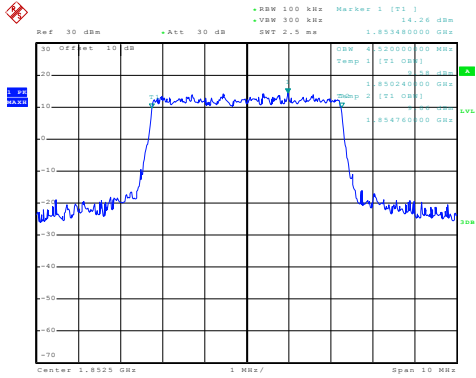

Date: 21.NOV.2015 21:19:51

Modulation:QPSK

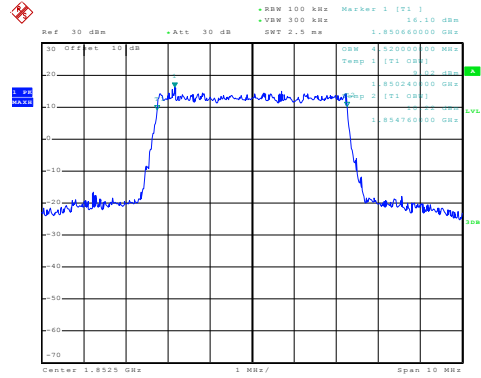

Date: 21.NOV.2015 21:17:58

Lowest channel

Modulation:16QAM

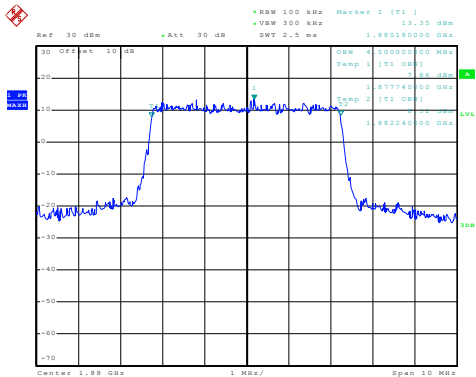

Date: 21.NOV.2015 21:21:36

Modulation:QPSK

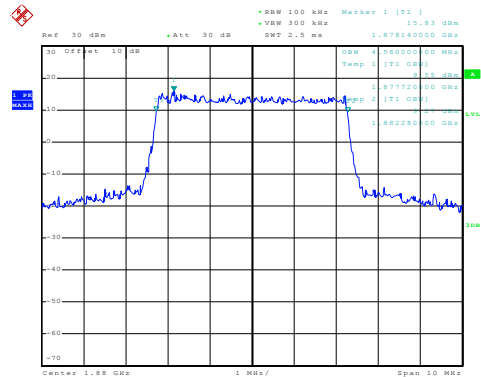

Date: 21.NOV.2015 21:20:23

Middle channel

Modulation:16QAM

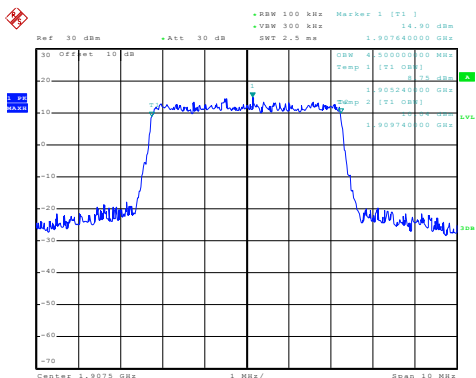

Date: 21.NOV.2015 21:29:49

Modulation:QPSK

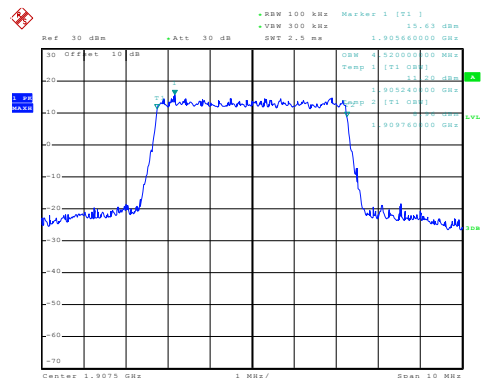

Date: 21.NOV.2015 21:29:13

Highest channel

Test Item:99% Occupy bandwidth
BW: 10MHz

Modulation:16QAM

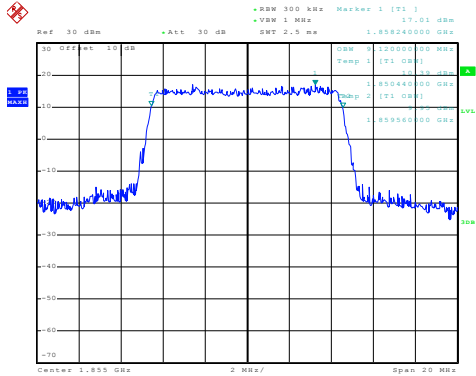

Date: 21.NOV.2015 21:31:17

Modulation:QPSK

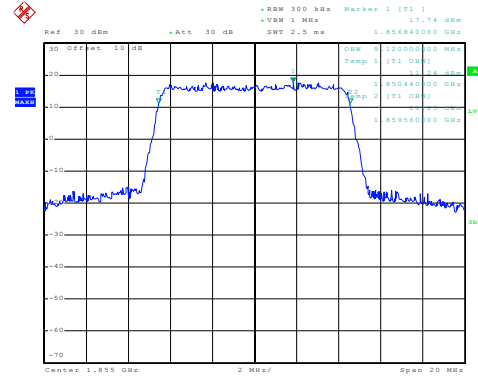

Date: 21.NOV.2015 21:30:42

Lowest channel

Modulation:16QAM

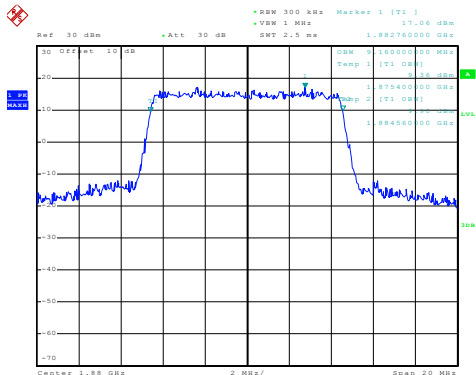

Date: 21.NOV.2015 21:32:18

Modulation:QPSK

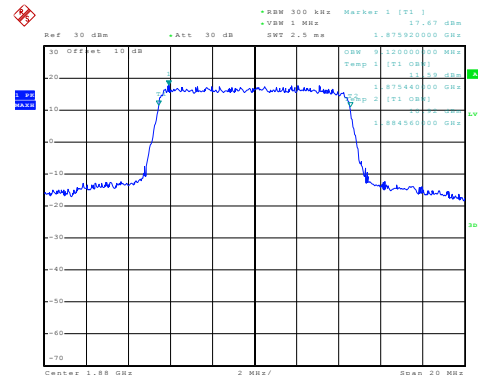

Date: 21.NOV.2015 21:31:46

Middle channel

Modulation:16QAM

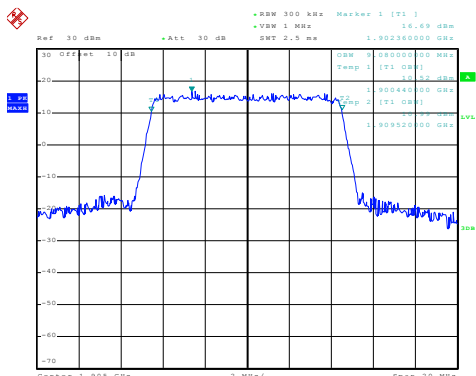

Date: 21 NOV 2015 21:33:43

Modulation:QPSK

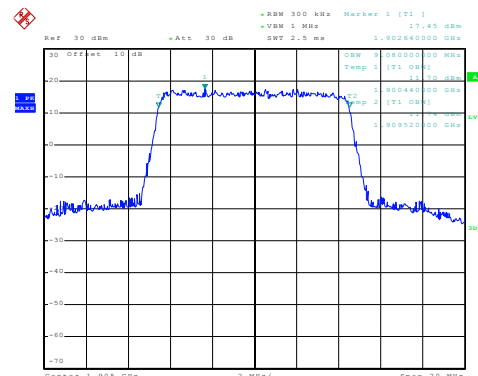

Date: 21 NOV 2015 21:33:06

Highest channel

Test Item: 99% Occupancy bandwidth
 BW: 15MHz

Modulation: 16QAM

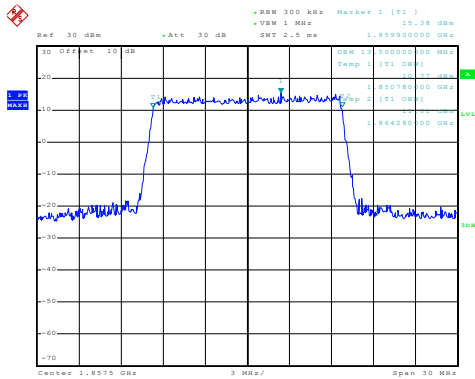

Date: 21.NOV.2015 21:35:11

Modulation: QPSK

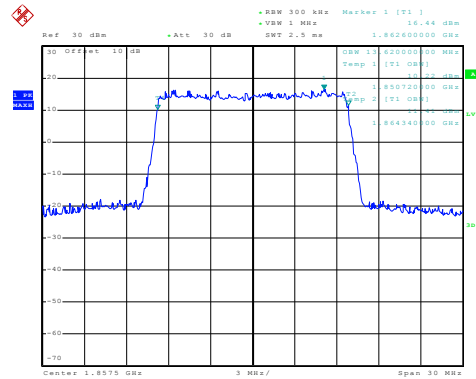

Date: 21.NOV.2015 21:34:36

Lowest channel

Modulation: 16QAM

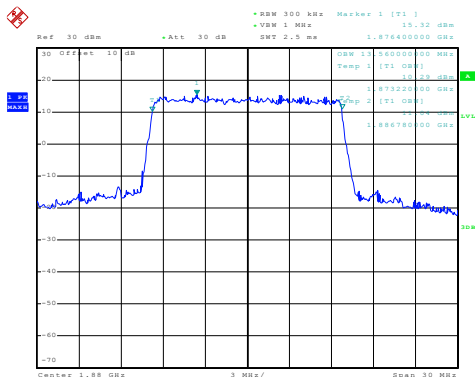

Date: 21.NOV.2015 21:36:33

Modulation: QPSK

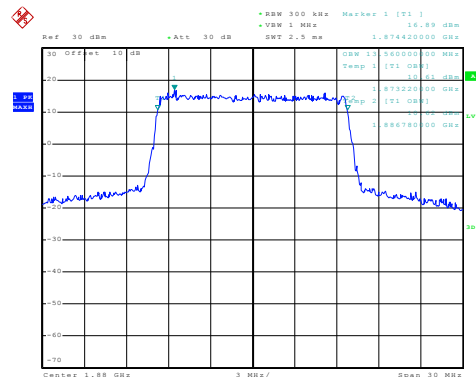

Date: 21.NOV.2015 21:35:40

Middle channel

Modulation: 16QAM

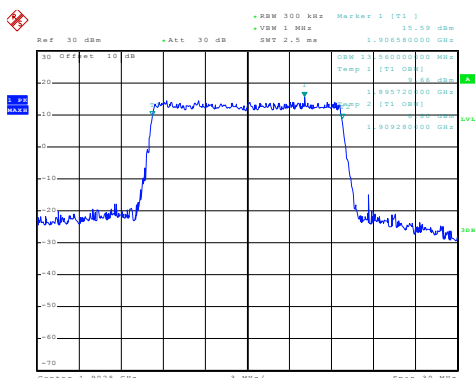

Date: 21.NOV.2015 21:37:52

Modulation: QPSK

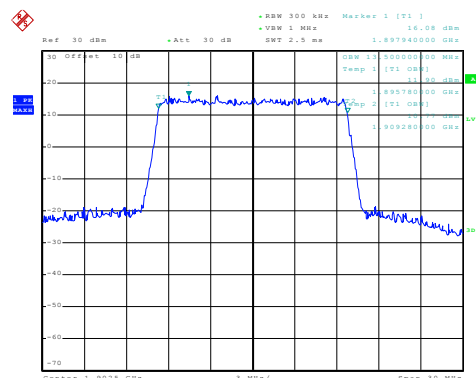

Date: 21.NOV.2015 21:37:18

Highest channel

Test Item:99% Occupy bandwidth
BW: 20MHz

Modulation:16QAM

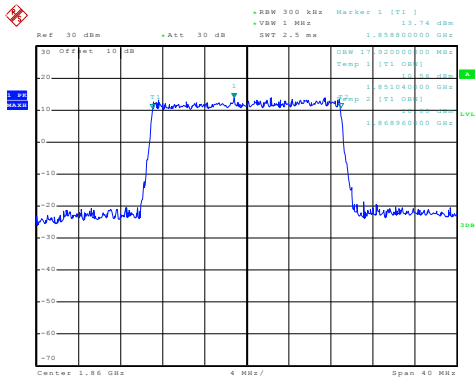

Date: 21.NOV.2015 21:39:21

Modulation:QPSK

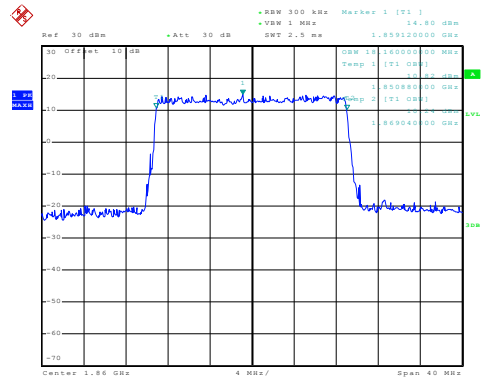

Date: 21.NOV.2015 21:38:46

Lowest channel

Modulation:16QAM

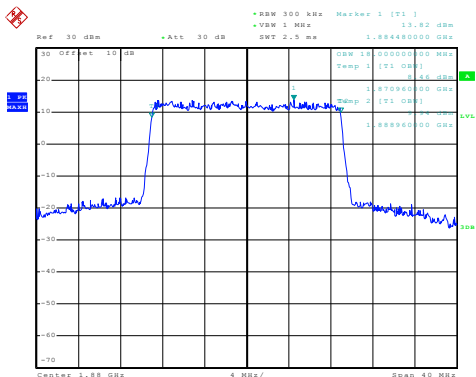

Date: 21.NOV.2015 21:40:27

Modulation:QPSK

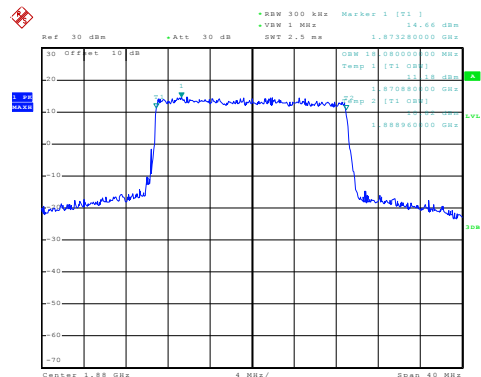

Date: 21.NOV.2015 21:39:44

Middle channel

Modulation:16QAM

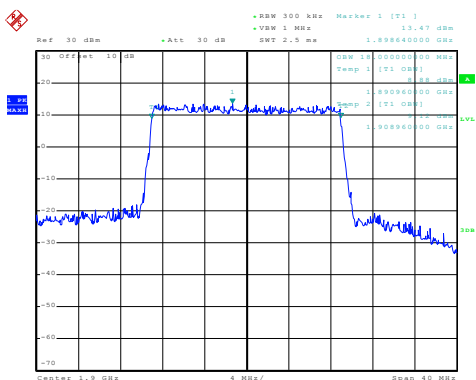

Date: 21.NOV.2015 21:41:40

Modulation:QPSK

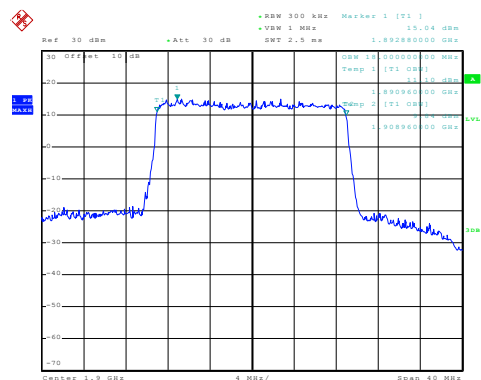

Date: 21.NOV.2015 21:41:06

Highest channel

Test Item:-26dBc bandwidth
 BW: 1.4MHz

Modulation:16QAM

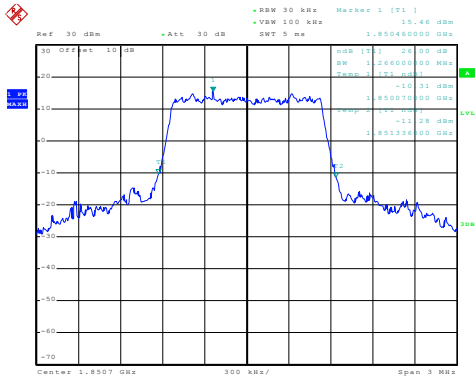

Date: 21 NOV 2015 21:04:13

Modulation:QPSK

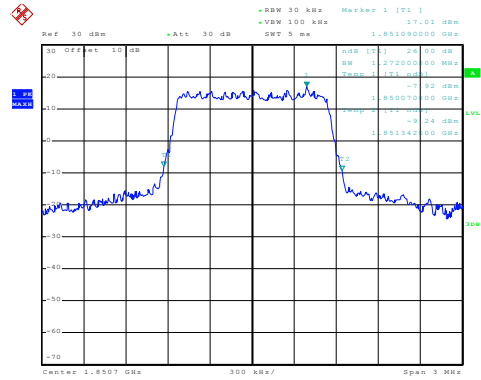

Date: 21 NOV 2015 21:04:01

Lowest channel

Modulation:16QAM

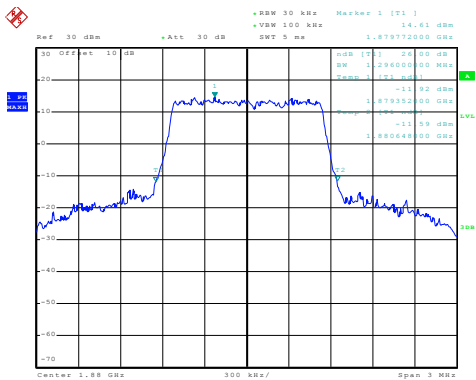

Date: 21 NOV 2015 21:10:13

Modulation:QPSK

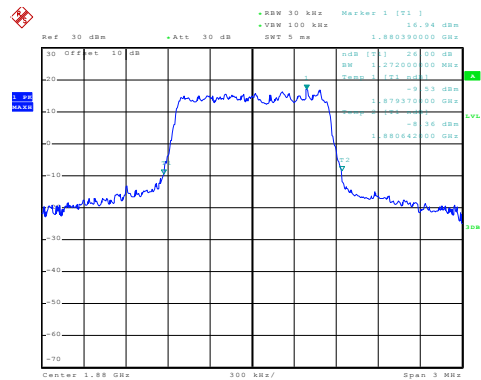

Date: 21 NOV 2015 21:10:01

Middle channel

Modulation:16QAM

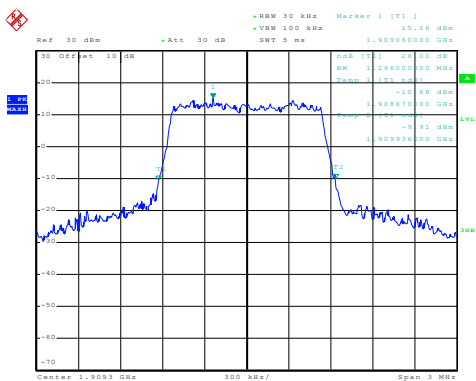

Date: 21 NOV 2015 21:11:21

Modulation:QPSK

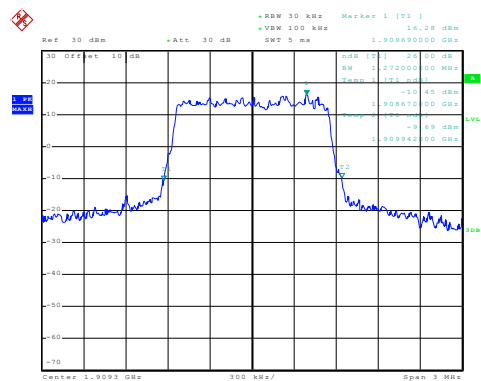

Date: 21 NOV 2015 21:11:04

Highest channel

Test Item:-26dBc bandwidth
 BW: 3MHz

Modulation:16QAM

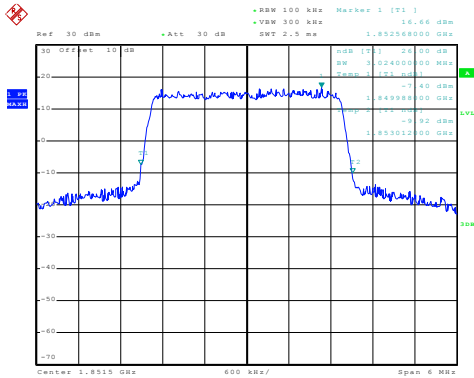

Date: 21 NOV 2015 21:13:22

Modulation:QPSK

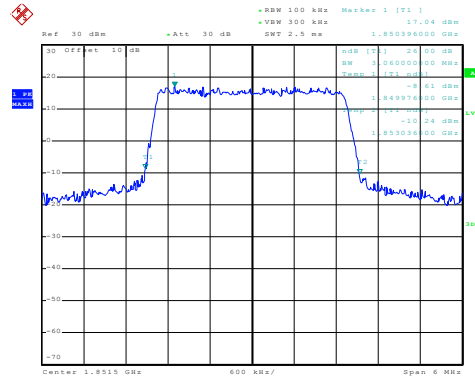

Date: 21 NOV 2015 21:12:45

Lowest channel

Modulation:16QAM

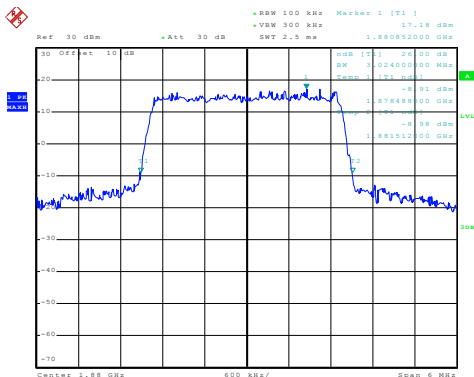

Date: 21 NOV 2015 21:14:21

Modulation:QPSK

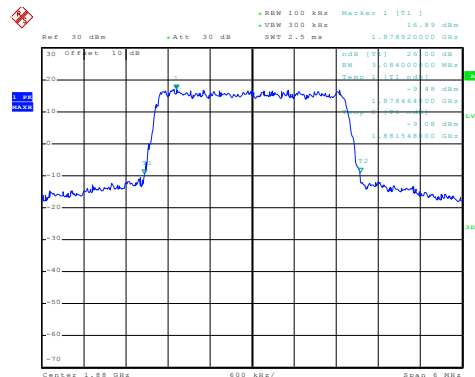

Date: 21 NOV 2015 21:12:46

Middle channel

Modulation:16QAM

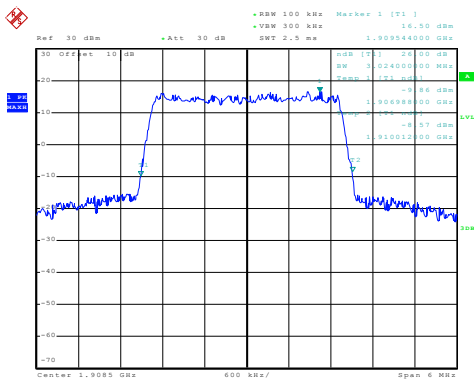

Date: 21 NOV 2015 21:15:46

Modulation:QPSK

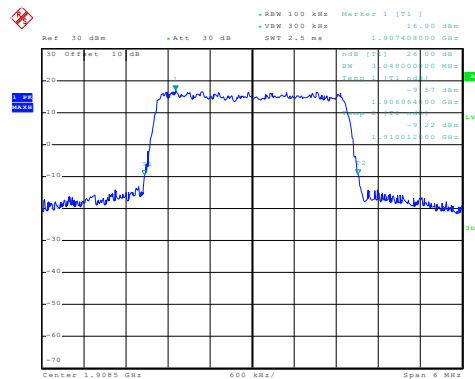

Date: 21 NOV 2015 21:15:10

Highest channel

Test Item:-26dBc bandwidth
 BW: 5MHz

Modulation:16QAM

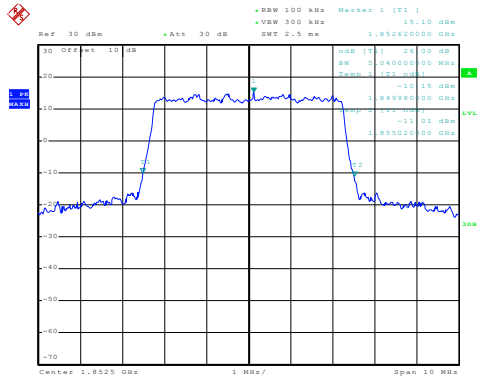

Date: 21 NOV 2015 21:19:34

Modulation:QPSK

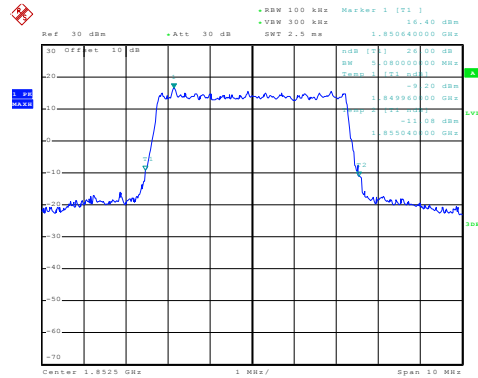

Date: 21 NOV 2015 21:17:42

Lowest channel

Modulation:16QAM

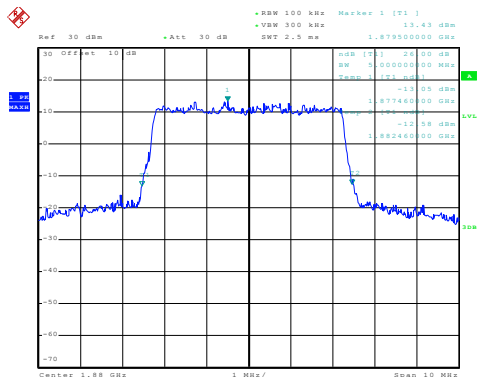

Date: 21 NOV 2015 21:21:25

Modulation:QPSK

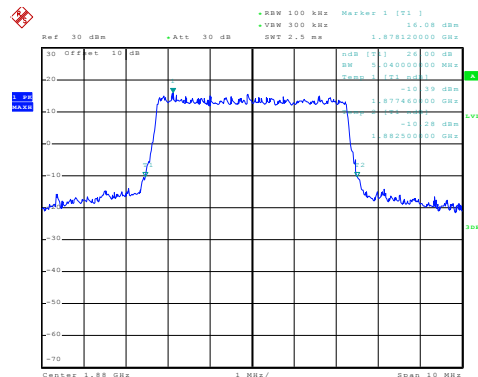

Date: 21 NOV 2015 21:20:49

Middle channel

Modulation:16QAM

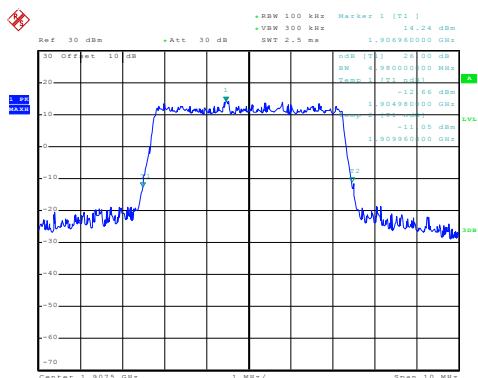

Date: 21 NOV 2015 21:29:36

Modulation:QPSK

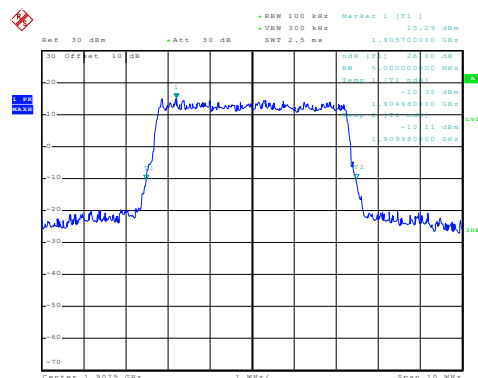

Date: 21 NOV 2015 21:29:23

Highest channel

Test Item:-26dBc bandwidth
 BW: 10MHz

Modulation:16QAM

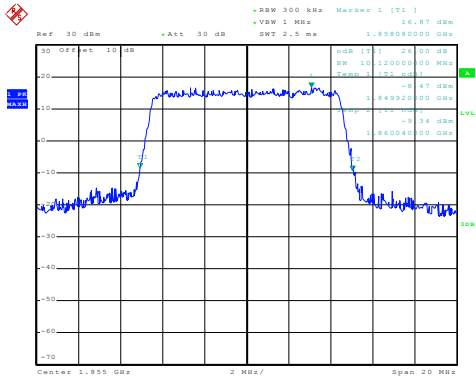

Date: 21 NOV 2015 21:31:05

Modulation:QPSK

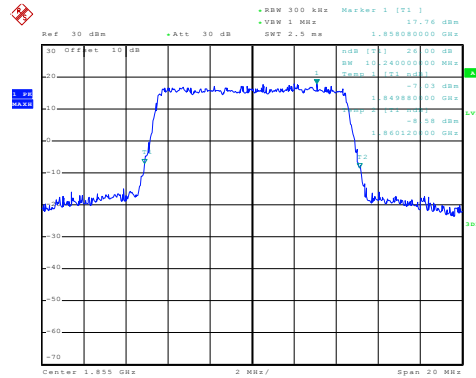

Date: 21 NOV 2015 21:30:55

Lowest channel

Modulation:16QAM

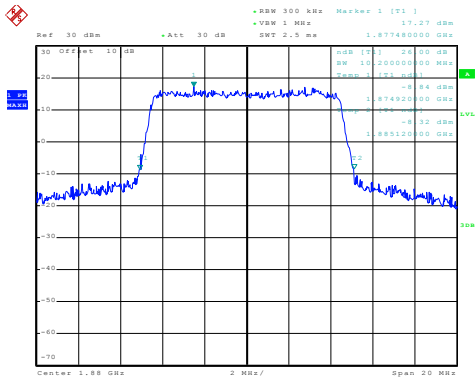

Date: 21 NOV 2015 21:32:08

Modulation:QPSK

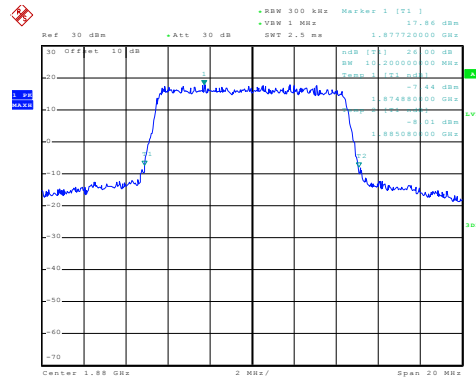

Date: 21 NOV 2015 21:31:57

Middle channel

Modulation:16QAM

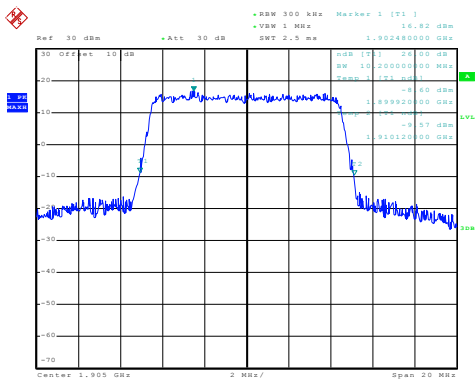

Date: 21 NOV 2015 21:33:28

Modulation:QPSK

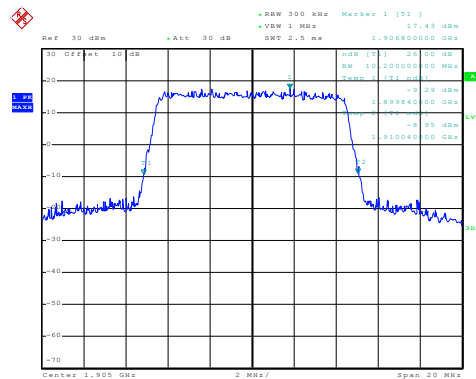

Date: 21 NOV 2015 21:33:17

Highest channel

Test Item:-26dBc bandwidth
 BW: 15MHz

Modulation:16QAM

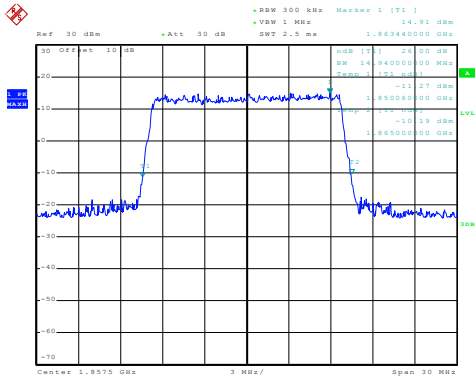

Date: 21 NOV 2015 21:14:54

Modulation:QPSK

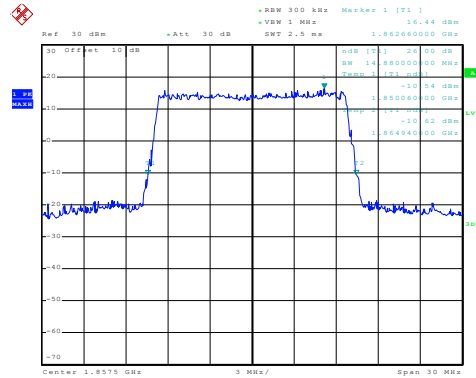

Date: 21 NOV 2015 21:14:47

Lowest channel

Modulation:16QAM

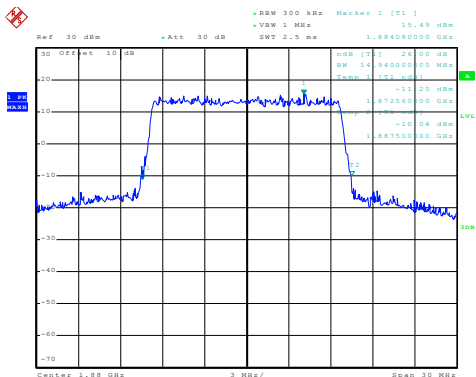

Date: 21 NOV 2015 21:16:05

Modulation:QPSK

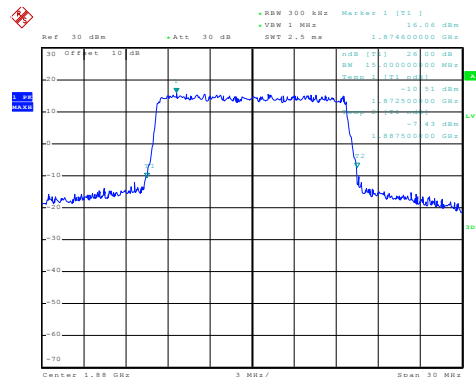

Date: 21 NOV 2015 21:15:52

Middle channel

Modulation:16QAM

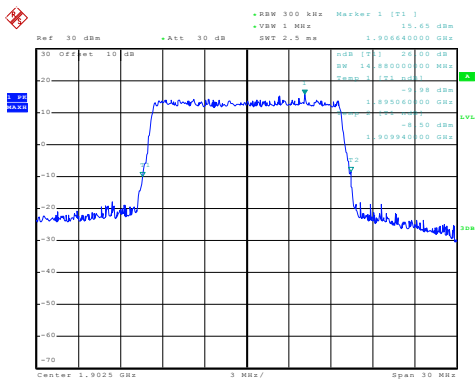

Date: 21 NOV 2015 21:17:41

Modulation:QPSK

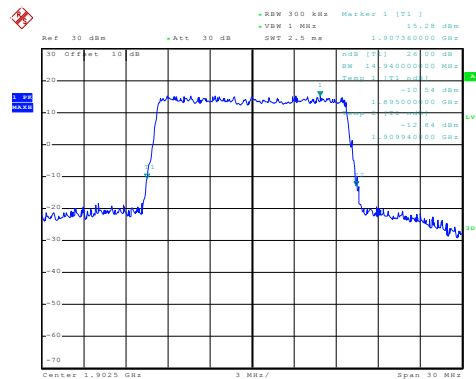

Date: 21 NOV 2015 21:17:30

Highest channel

Test Item:-26dBc bandwidth
 BW: 20MHz

Modulation:16QAM

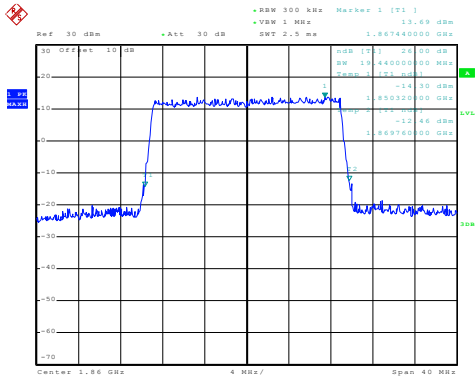

Date: 21 NOV 2015 21:39:04

Modulation:QPSK

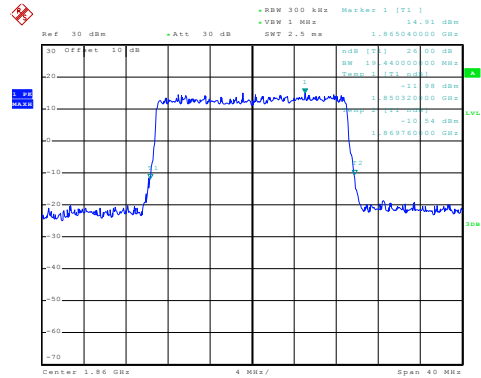

Date: 21 NOV 2015 21:38:55

Lowest channel

Modulation:16QAM

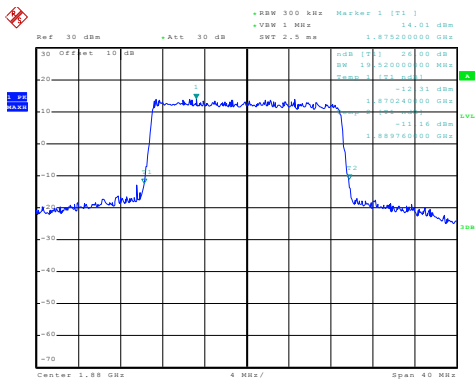

Date: 21 NOV 2015 21:40:17

Modulation:QPSK

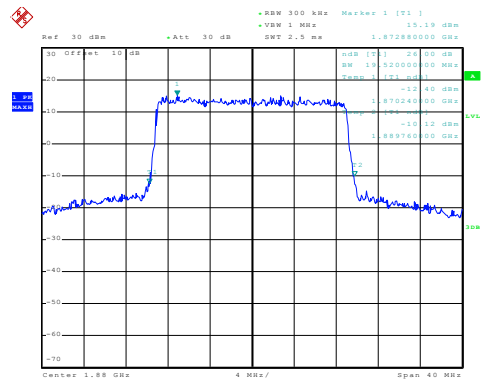

Date: 21 NOV 2015 21:39:55

Middle channel

Modulation:16QAM

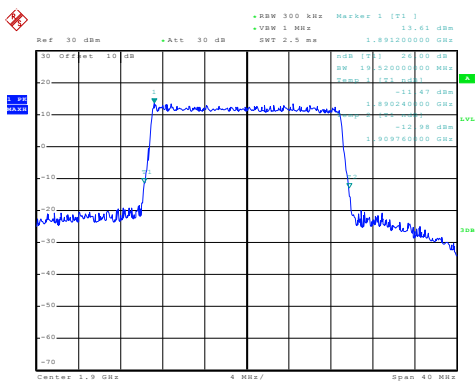

Date: 21 NOV 2015 21:41:30

Modulation:QPSK

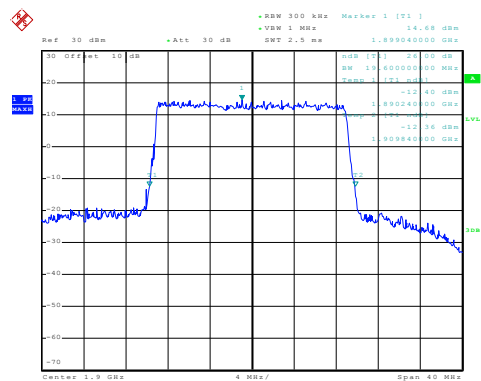

Date: 21 NOV 2015 21:41:17

Highest channel

LTE Band 4 part

Test Item:99% Occupy bandwidth
 BW: 1.4MHz

Modulation:16QAM

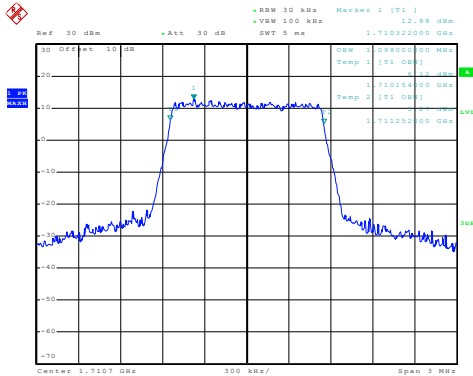

Date: 21.NOV.2015 20:29:43

Modulation:QPSK

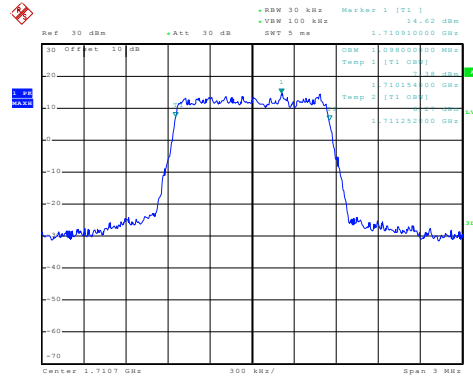

Date: 21.NOV.2015 20:29:31

Lowest channel

Modulation:16QAM

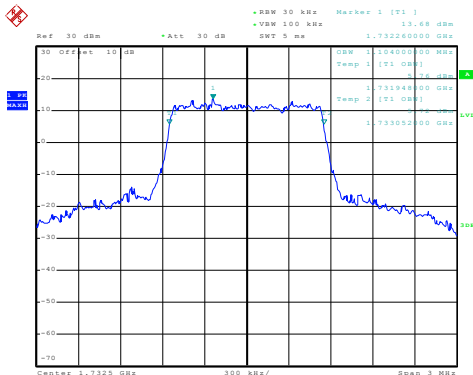

Date: 21.NOV.2015 20:31:13

Modulation:QPSK

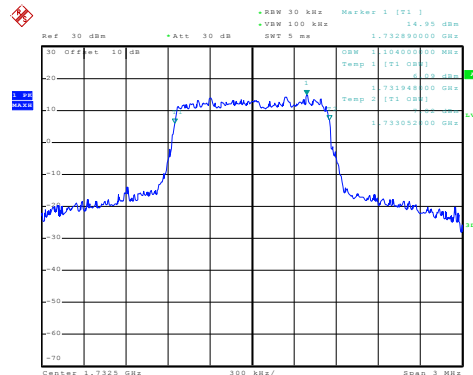

Date: 21.NOV.2015 20:30:53

Middle channel

Modulation:16QAM

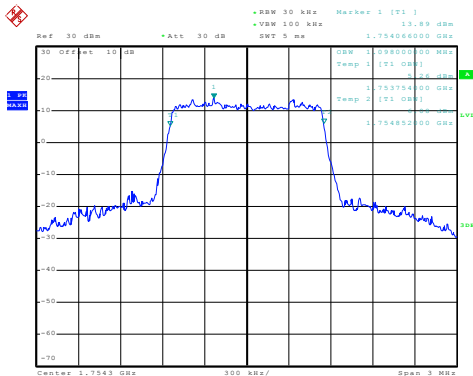

Date: 21 NOV 2015 20:32:18

Modulation:QPSK

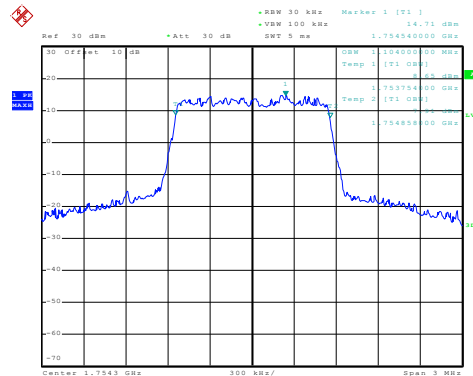

Date: 21 NOV 2015 20:32:06

Highest channel

Test Item:99% Occupy bandwidth
 BW: 3MHz

Modulation:16QAM

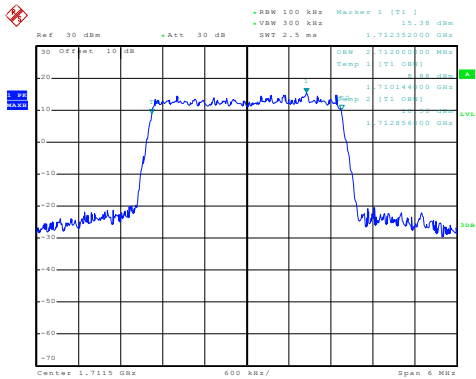

Date: 21.NOV.2015 20:34:17

Modulation:QPSK

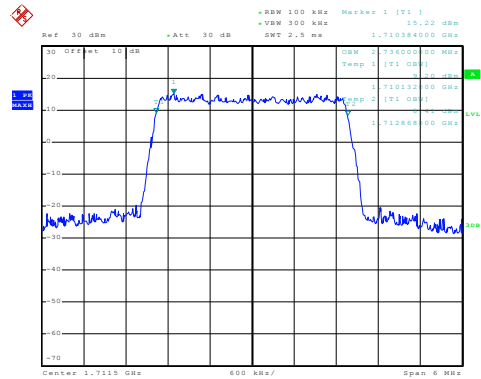

Date: 21.NOV.2015 20:34:05

Lowest channel

Modulation:16QAM

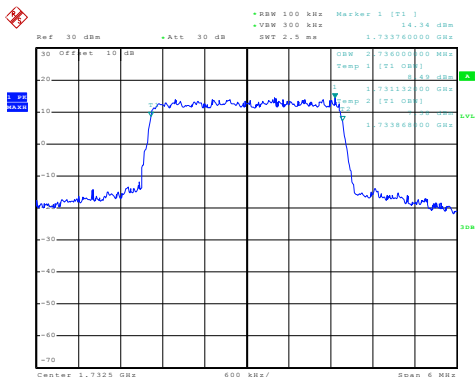

Date: 21.NOV.2015 20:35:30

Modulation:QPSK

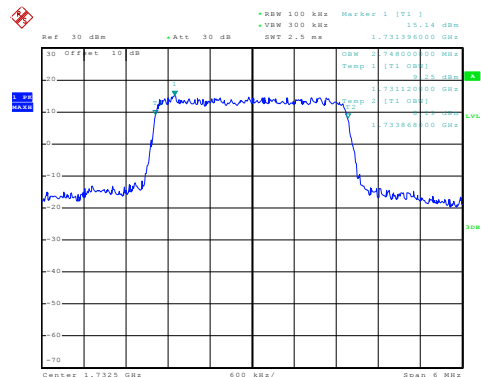

Date: 21.NOV.2015 20:35:16

Middle channel

Modulation:16QAM

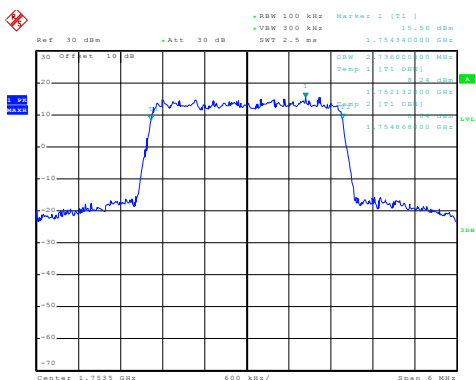

Date: 21.NOV.2015 20:36:38

Modulation:QPSK

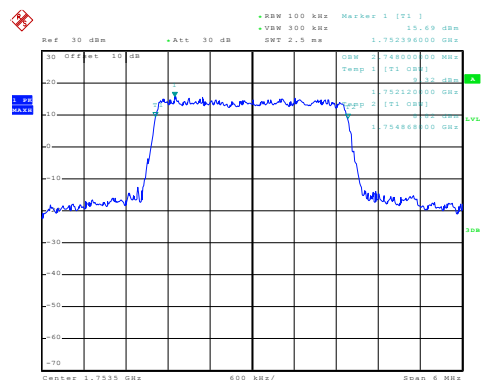

Date: 21.NOV.2015 20:36:20

Highest channel

Test Item:99% Occupy bandwidth
BW: 5MHz

Modulation:16QAM

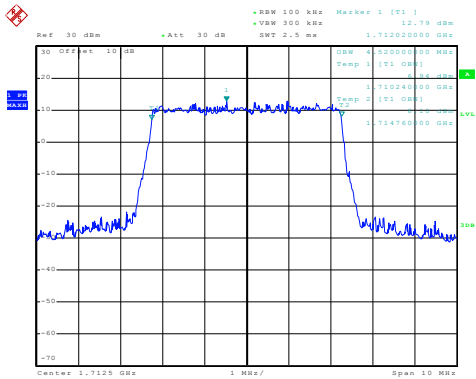

Date: 21.NOV.2015 20:38:53

Modulation:QPSK

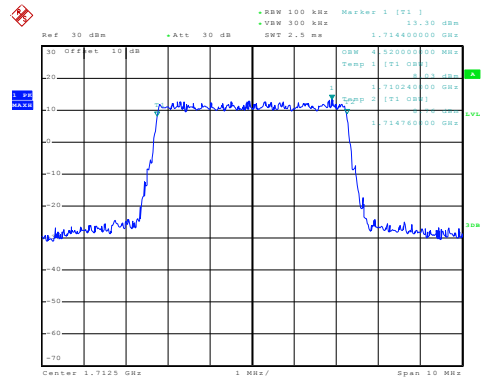

Date: 21.NOV.2015 20:38:38

Lowest channel

Modulation:16QAM

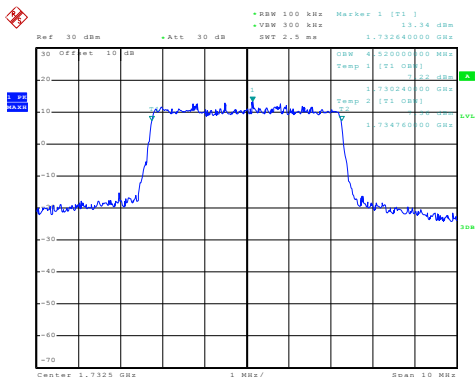

Date: 21.NOV.2015 20:43:54

Modulation:QPSK

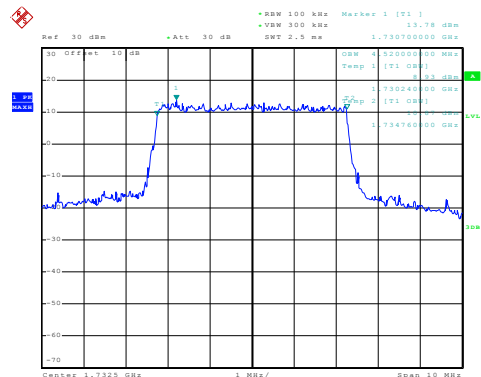

Date: 21.NOV.2015 20:43:41

Middle channel

Modulation:16QAM

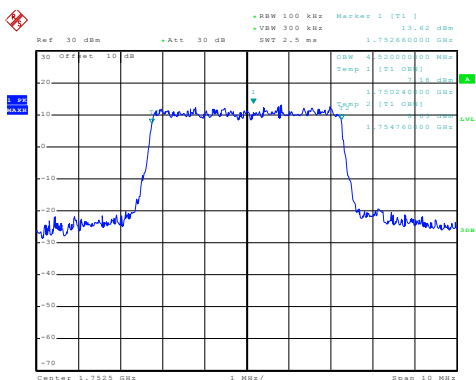

Date: 21.NOV.2015 20:44:59

Modulation:QPSK

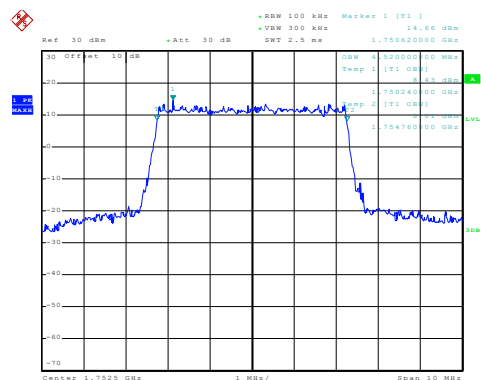

Date: 21.NOV.2015 20:44:47

Highest channel

Test Item:99% Occupy bandwidth
 BW: 10MHz

Modulation:16QAM

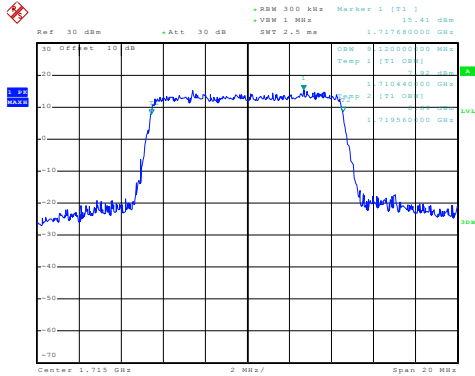

Date: 21.NOV.2015 20:46:48

Modulation:QPSK

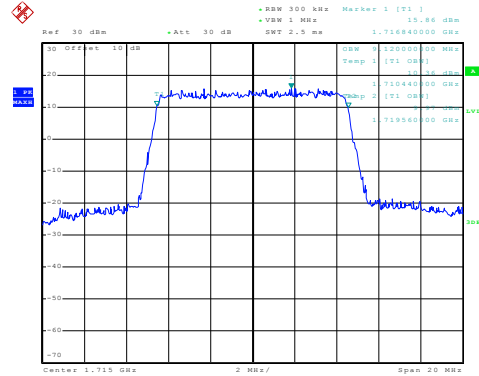

Date: 21.NOV.2015 20:46:37

Lowest channel

Modulation:16QAM

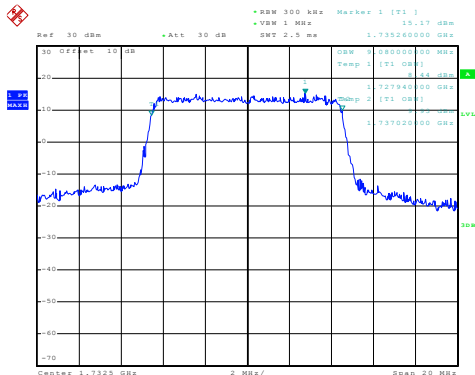

Date: 21.NOV.2015 20:48:02

Modulation:QPSK

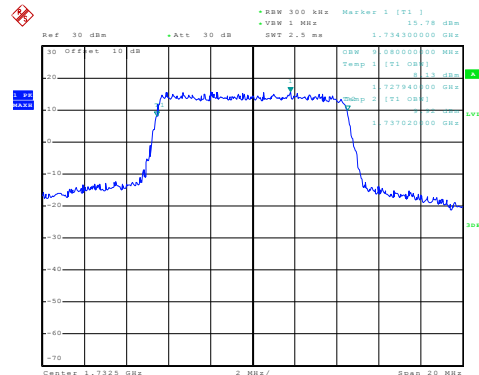

Date: 21.NOV.2015 20:47:50

Middle channel

Modulation:16QAM

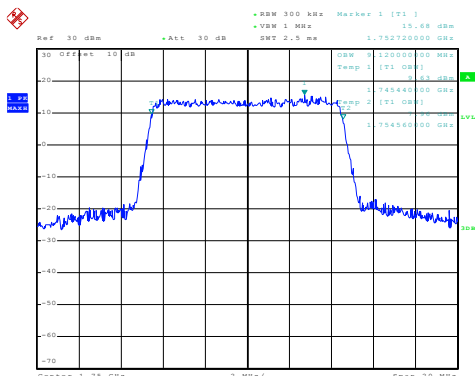

Date: 21.NOV.2015 20:49:44

Modulation:QPSK

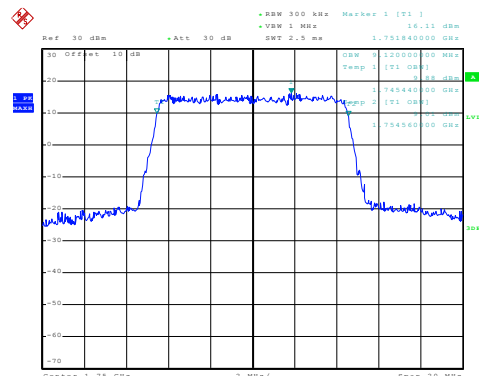

Date: 21.NOV.2015 20:49:08

Highest channel

Test Item:99% Occupy bandwidth
 BW: 15MHz

Modulation:16QAM

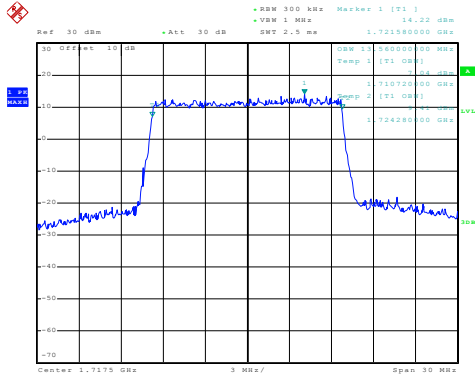

Date: 21.NOV.2015 20:51:37

Modulation:QPSK

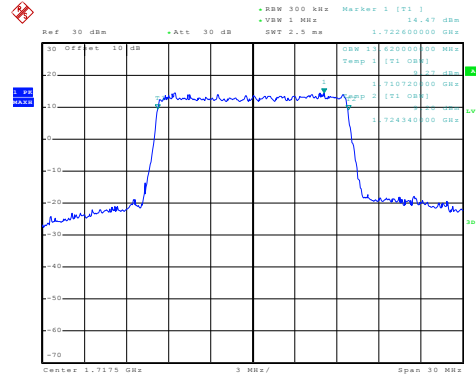

Date: 21.NOV.2015 20:51:00

Lowest channel

Modulation:16QAM

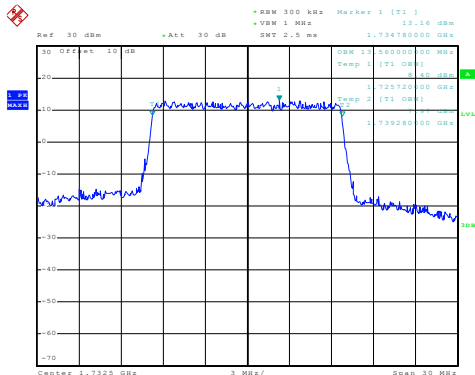

Date: 21.NOV.2015 20:53:04

Modulation:QPSK

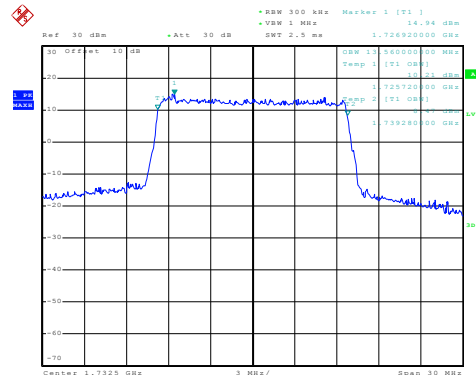

Date: 21.NOV.2015 20:52:28

Middle channel

Modulation:16QAM

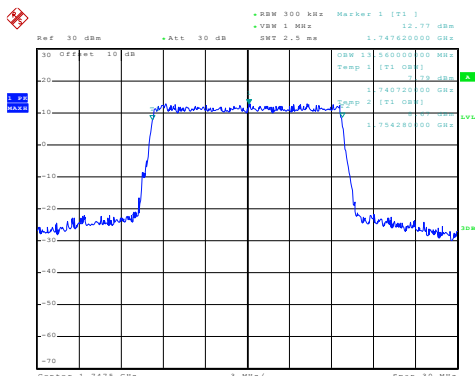

Date: 21.NOV.2015 20:54:30

Modulation:QPSK

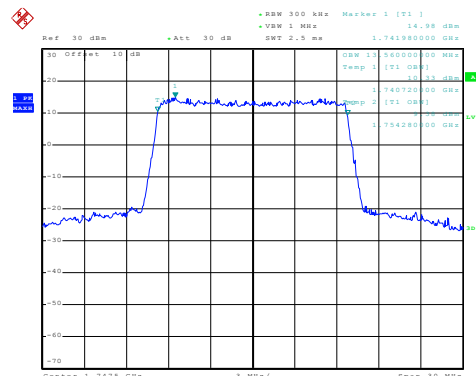

Date: 21.NOV.2015 20:53:54

Highest channel

Test Item:99% Occupy bandwidth
BW: 20MHz

Modulation:16QAM

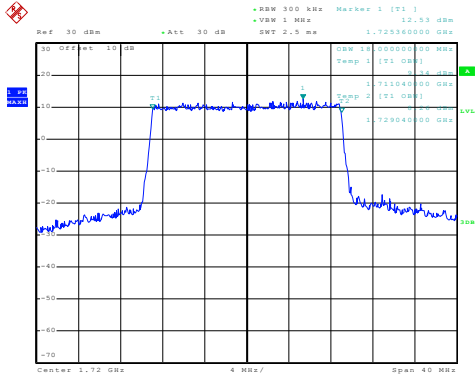

Date: 21.NOV.2015 20:56:07

Modulation:QPSK

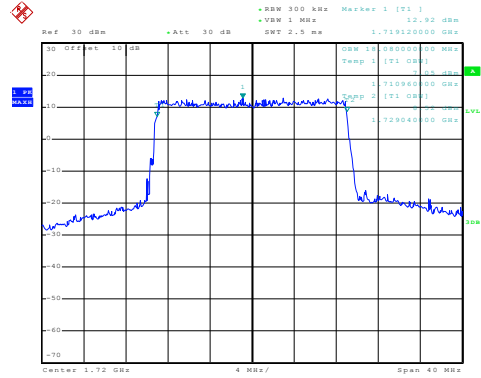

Date: 21.NOV.2015 20:55:26

Lowest channel

Modulation:16QAM

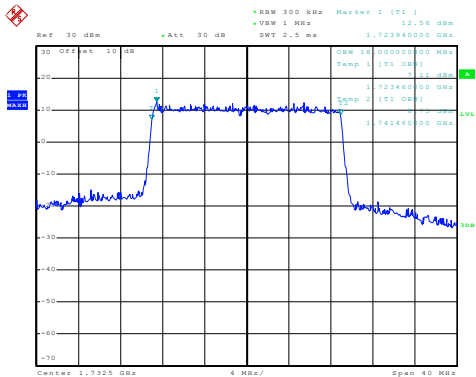

Date: 21.NOV.2015 20:57:47

Modulation:QPSK

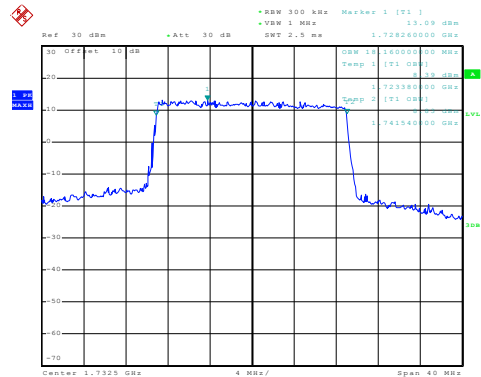

Date: 21.NOV.2015 20:56:54

Middle channel

Modulation:16QAM

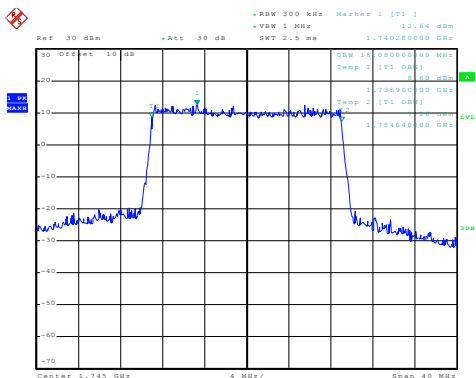

Date: 21.NOV.2015 21:01:02

Modulation:QPSK

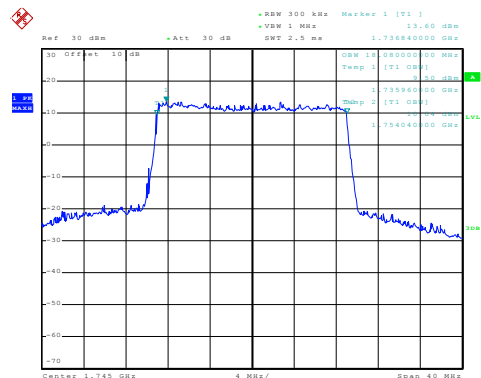

Date: 21.NOV.2015 21:00:21

Highest channel

Test Item:-26dBc bandwidth
 BW: 1.4MHz

Modulation:16QAM

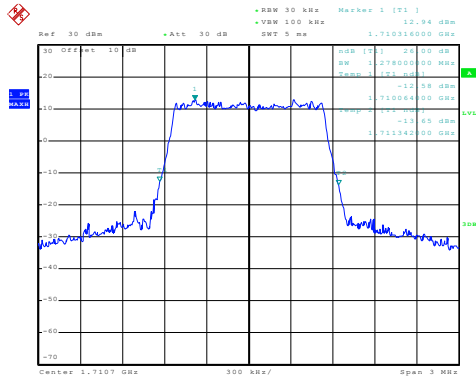

Date: 21 NOV 2015 20:29:53

Modulation:QPSK

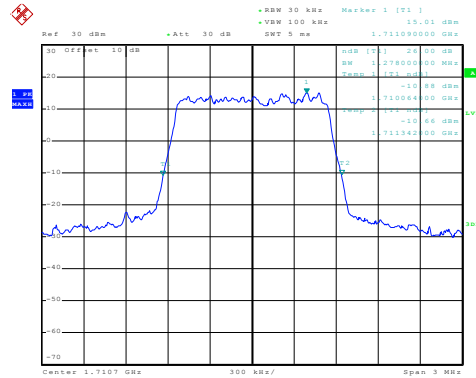

Date: 21 NOV 2015 20:29:19

Lowest channel

Modulation:16QAM

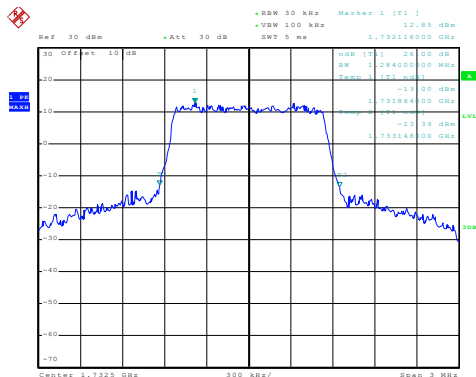

Date: 21 NOV 2015 20:31:23

Modulation:QPSK

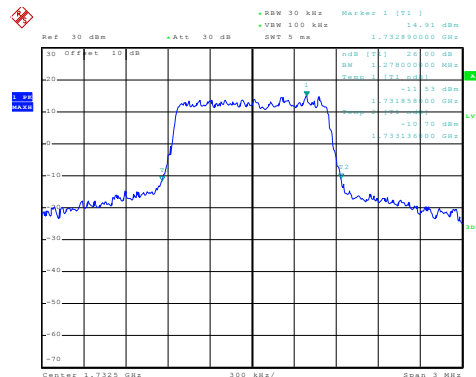

Date: 21 NOV 2015 20:30:43

Middle channel

Modulation:16QAM

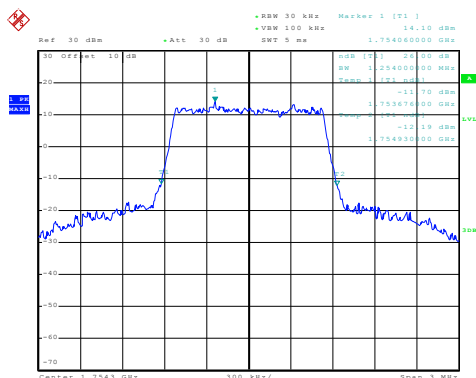

Date: 21 NOV 2015 20:32:29

Modulation:QPSK

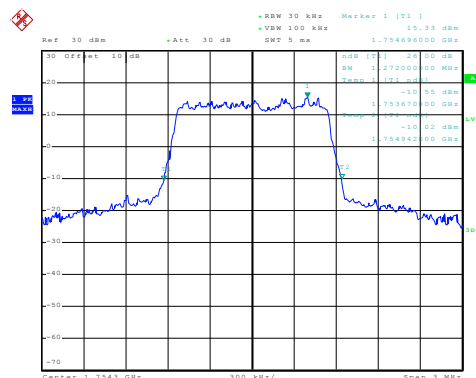

Date: 21 NOV 2015 20:31:52

Highest channel

Test Item:-26dBc bandwidth
 BW: 3MHz

Modulation:16QAM

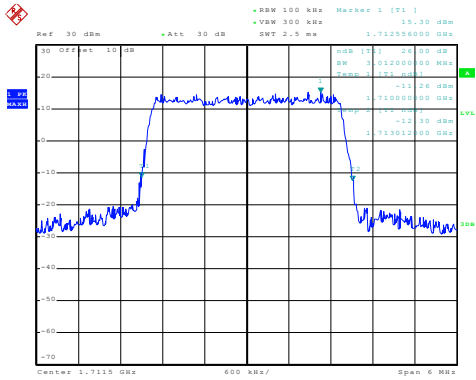

Date: 21 NOV 2015 20:14:28

Modulation:QPSK

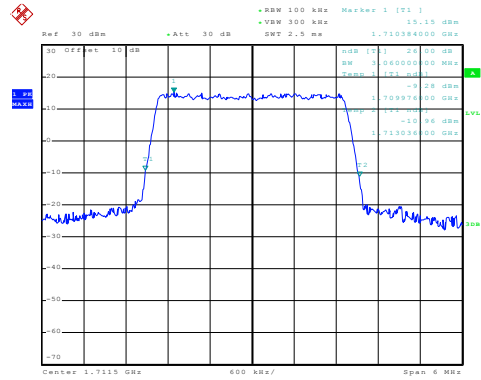

Date: 21 NOV 2015 20:14:54

Lowest channel

Modulation:16QAM

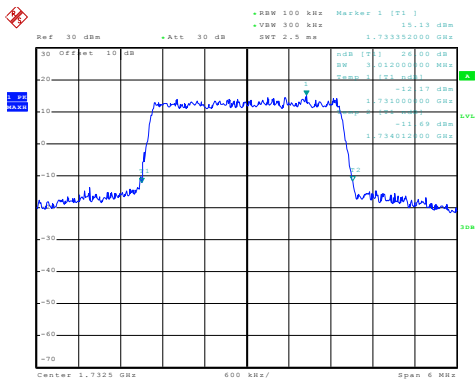

Date: 21 NOV 2015 20:15:19

Modulation:QPSK

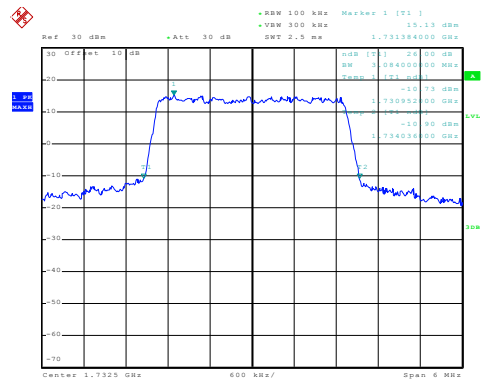

Date: 21 NOV 2015 20:15:07

Middle channel

Modulation:16QAM

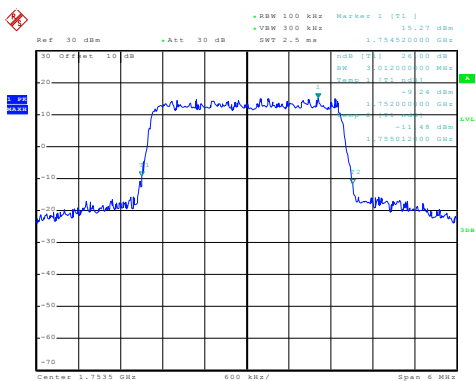

Date: 21 NOV 2015 20:16:54

Modulation:QPSK

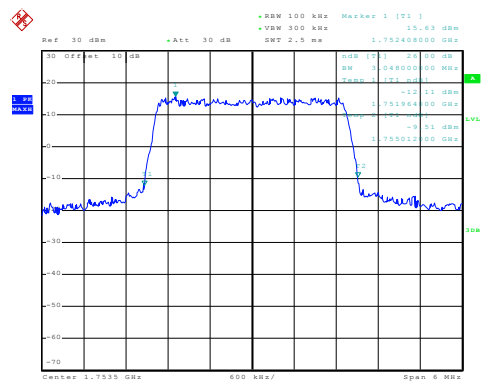

Date: 21 NOV 2015 20:16:09

Highest channel

Test Item:-26dBc bandwidth
 BW: 5MHz

Modulation:16QAM

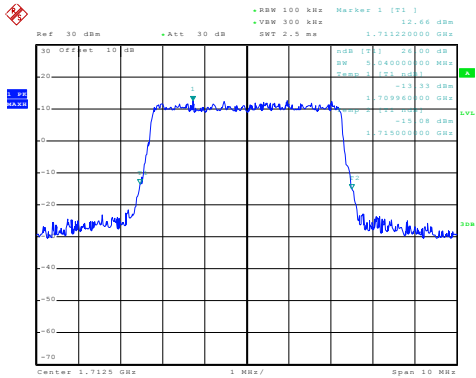

Date: 21 NOV 2015 20:39:13

Modulation:QPSK

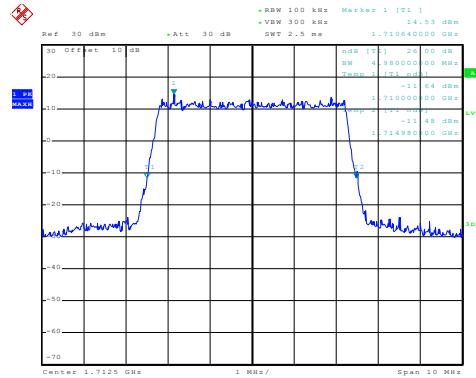

Date: 21 NOV 2015 20:38:27

Lowest channel

Modulation:16QAM

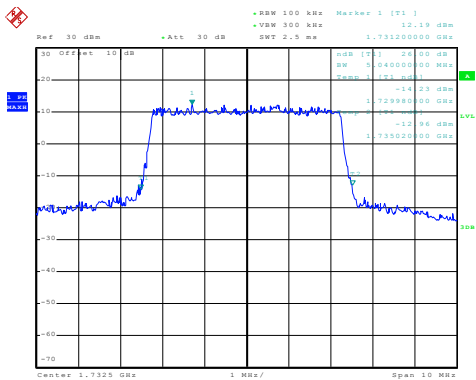

Date: 21 NOV 2015 20:44:06

Modulation:QPSK

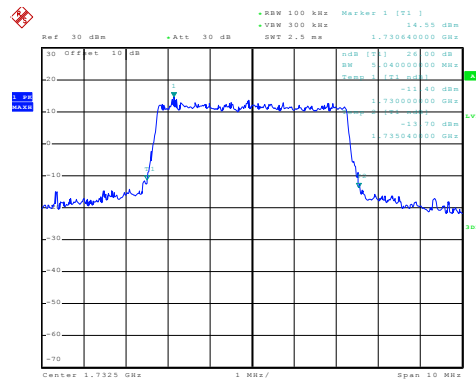

Date: 21 NOV 2015 20:43:27

Middle channel

Modulation:16QAM

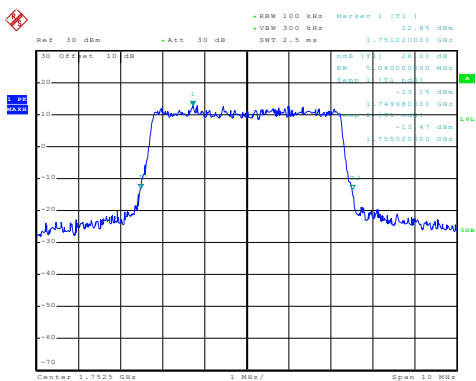

Date: 21 NOV 2015 20:45:04

Modulation:QPSK

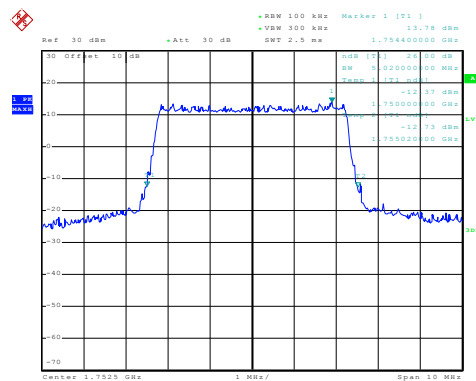

Date: 21 NOV 2015 20:44:27

Highest channel

Test Item:-26dBc bandwidth
 BW: 10MHz

Modulation:16QAM

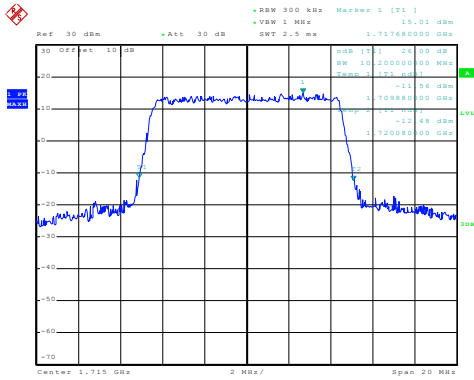

Date: 21 NOV 2015 20:46:54

Modulation:QPSK

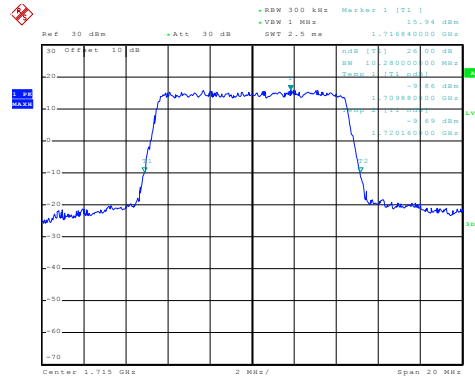

Date: 21 NOV 2015 20:46:25

Lowest channel

Modulation:16QAM

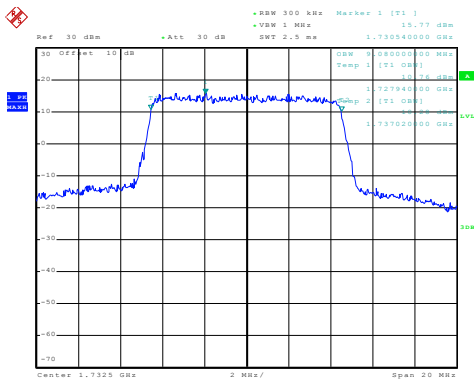

Date: 21 NOV 2015 20:48:14

Modulation:QPSK

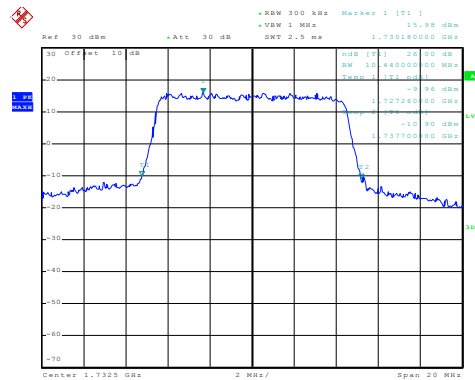

Date: 21 NOV 2015 20:47:40

Middle channel

Modulation:16QAM

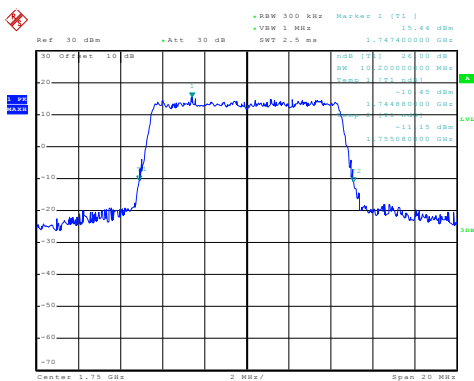

Date: 21 NOV 2015 20:49:13

Modulation:QPSK

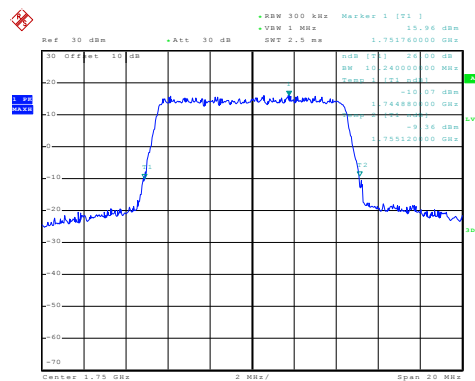

Date: 21 NOV 2015 20:49:14

Highest channel

Test Item:-26dBc bandwidth
 BW: 15MHz

Modulation:16QAM

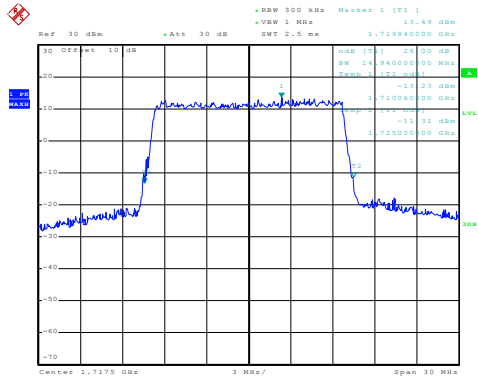

Date: 21 NOV 2015 20:51:26

Modulation:QPSK

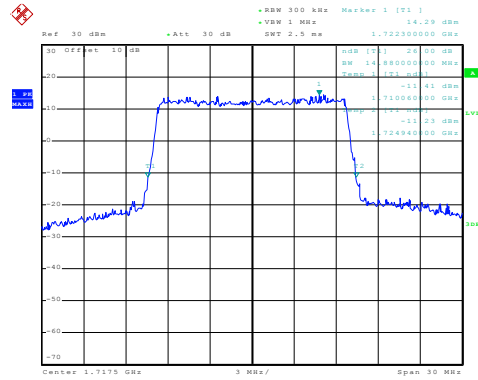

Date: 21 NOV 2015 20:51:14

Lowest channel

Modulation:16QAM

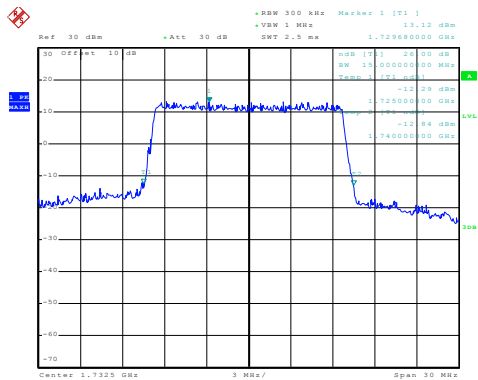

Date: 21 NOV 2015 20:52:50

Modulation:QPSK

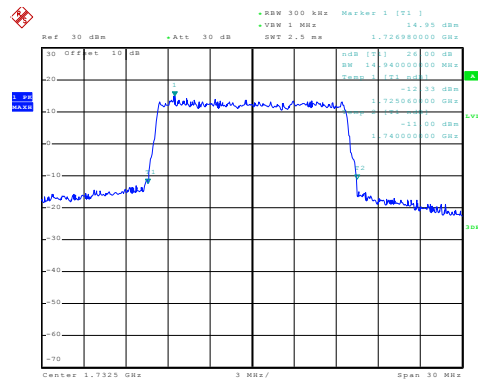

Date: 21 NOV 2015 20:52:38

Middle channel

Modulation:16QAM

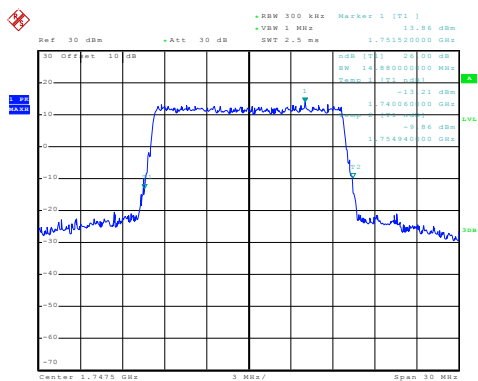

Date: 21 NOV 2015 20:54:20

Modulation:QPSK

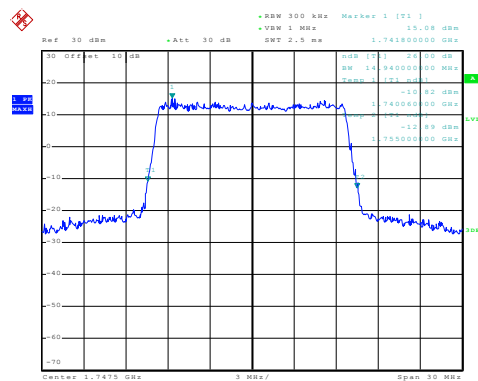

Date: 21 NOV 2015 20:54:07

Highest channel

Test Item:-26dBc bandwidth
 BW: 20MHz

Modulation:16QAM

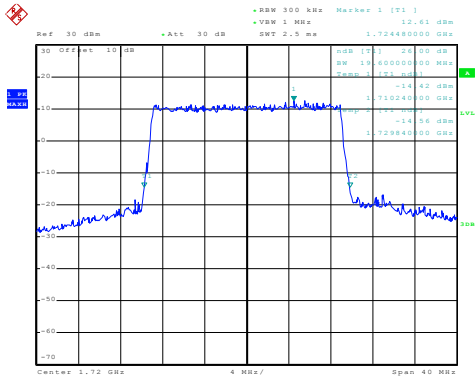

Date: 21 NOV 2015 20:55:54

Modulation:QPSK

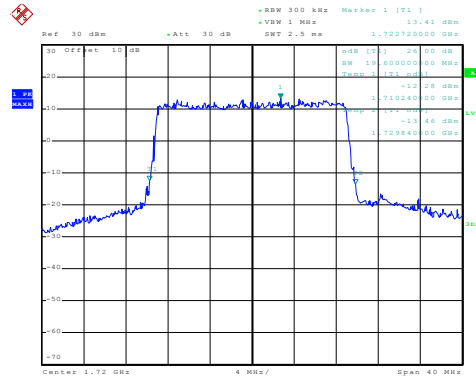

Date: 21 NOV 2015 20:55:54

Lowest channel

Modulation:16QAM

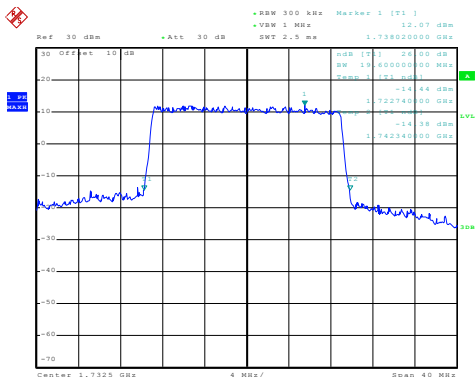

Date: 21 NOV 2015 20:57:30

Modulation:QPSK

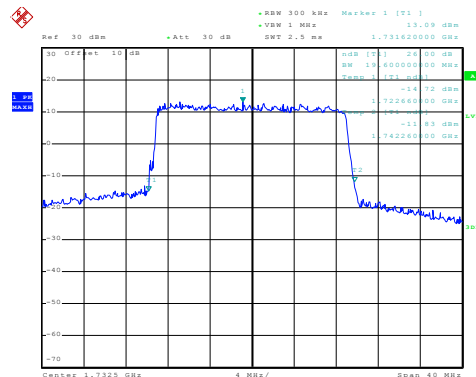

Date: 21 NOV 2015 20:57:05

Middle channel

Modulation:16QAM

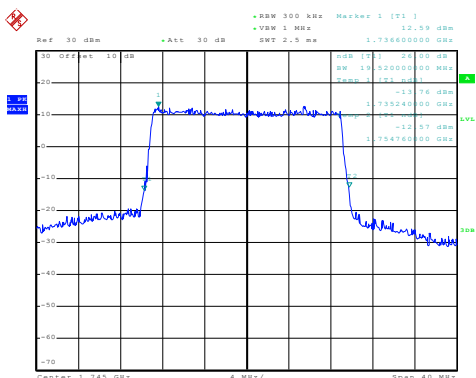

Date: 21 NOV 2015 21:00:52

Modulation:QPSK

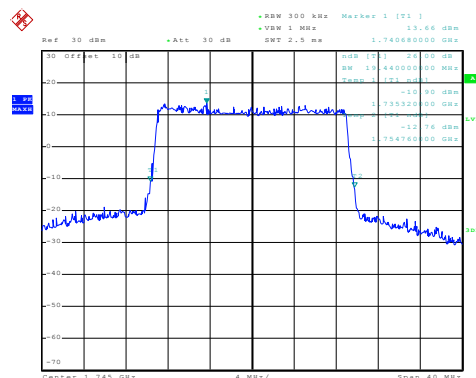

Date: 21 NOV 2015 21:00:51

Highest channel

6.8 Modulation Characteristic

According to FCC § 2.1047(d) there is no specific requirement for digital modulation, therefore modulation characteristic is not presented.

6.9 Out of band emission at antenna terminals

Test Requirement:	FCC Part 24.238 (a), part 27.53(h)
Test Method:	FCC part 2.1051
Limit:	<p>Conducted spurious emission: LTE Band 2, Band 4: -13 dBm Band edge: LTE Band 2, Band 4: the power of any emission outside a licensee's frequency block shall be attenuated below the transmitter power (P) in watts by at least $43 + 10 \log_{10}(P)$ dB.</p>
Test setup:	<p style="text-align: center;"><i>Note: Measurement setup for testing on Antenna connector</i></p>
Test Procedure:	<ol style="list-style-type: none"> 1 The RF output of the transceiver was connected to a spectrum analyzer through appropriate attenuation. 2 The resolution bandwidth of the spectrum analyzer was set at 100 kHz when below 1GHz, 1MHz when above 1 GHz; sufficient scans were taken to show the out of band Emissions if any up to 10th harmonic. 3 For the out of band: Set the RBW=100 kHz, VBW=300 kHz when below 1 GHz, RBW =1 MHz, VBW=3 MHz when above 1 GHz, Start=30MHz, Stop= 10th harmonic. 4 Band Edge Requirements: In the 1 MHz bands immediately outside and adjacent to the frequency block, a resolution bandwidth of at least 1 percent of the emission bandwidth of the fundamental emission of the transmitter may be employed to measure the out of band Emissions.
Test Instruments:	Refer to section 5.8 for details
Test mode:	Refer to section 5.3 for details
Test results:	Passed

Test plots as follows:

Spurious emission

LTE band 2 Part:

1.4MHz

Test Mode:	LTE band 2(1.4 MHz 16QAM) RB Size 1 & RB Offset 0	Test Channel:	Lowest channel
------------	--	---------------	----------------

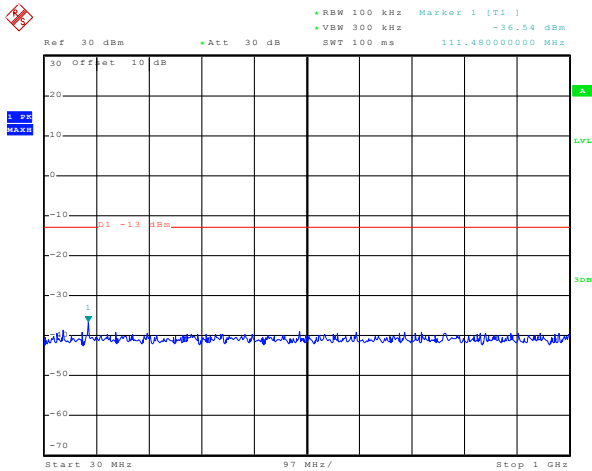

Date: 21.NOV.2015 21:51:12

30MHz~1GHz

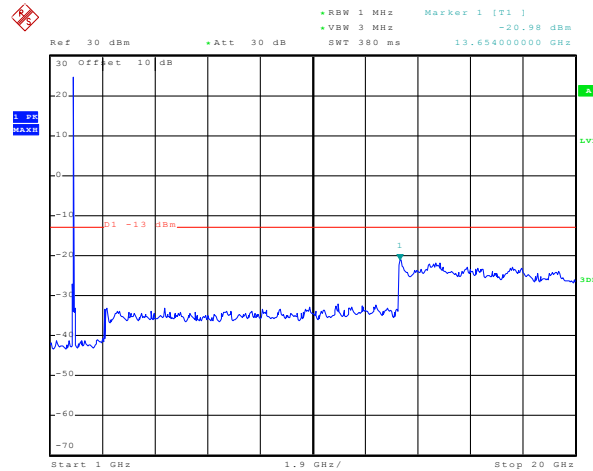

Date: 21.NOV.2015 21:54:21

1GHz~20GHz

Test Mode:	LTE band 2(1.4 MHz 16QAM) RB Size 1 & RB Offset 0	Test Channel:	Middle channel
------------	--	---------------	----------------

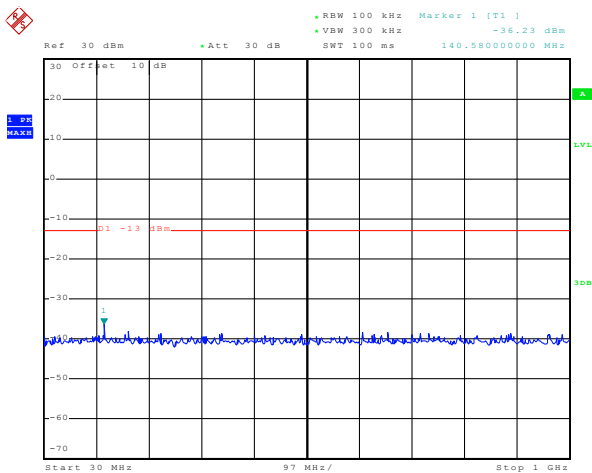

Date: 21.NOV.2015 21:58:50

30MHz~1GHz

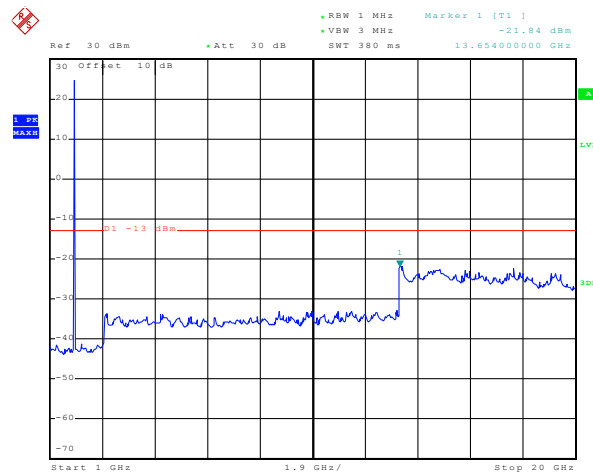

Date: 21.NOV.2015 21:56:06

1GHz~20GHz

Test Mode:	LTE band 2(1.4 MHz 16QAM) RB Size 1 & RB Offset 0	Test Channel:	Highest channel
------------	--	---------------	-----------------

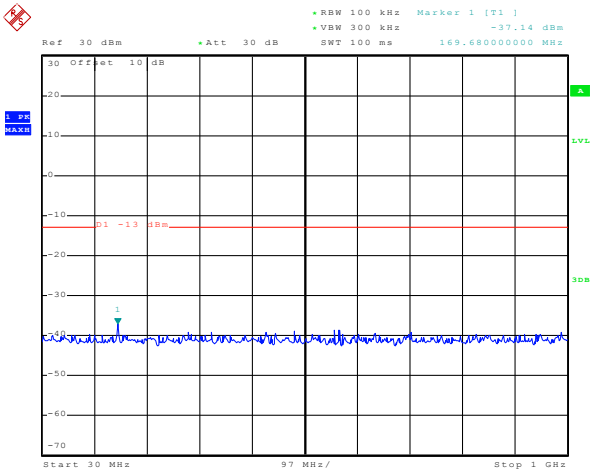

Date: 21.NOV.2015 22:00:58

30MHz~1GHz

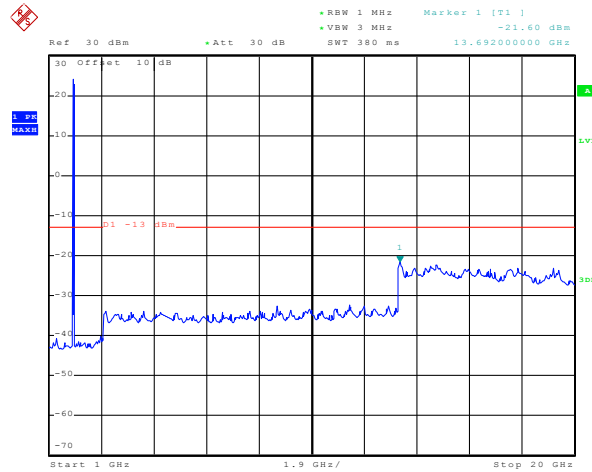

Date: 21.NOV.2015 22:05:11

1GHz~20GHz

Test Mode:	LTE band 2(1.4 MHz 16QAM) RB Size 3 & RB Offset 0	Test Channel:	Lowest channel
------------	--	---------------	----------------

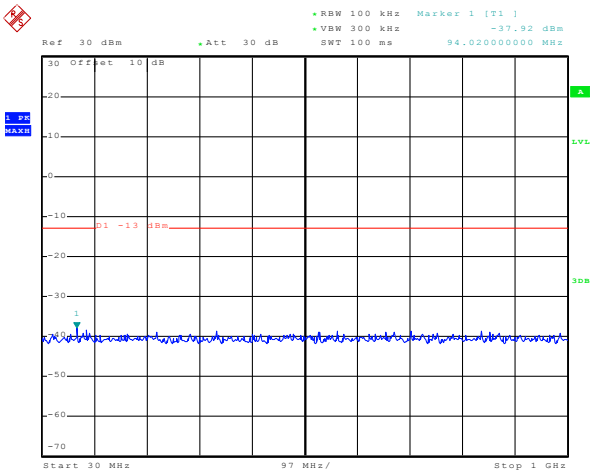

Date: 21.NOV.2015 21:51:35

30MHz~1GHz

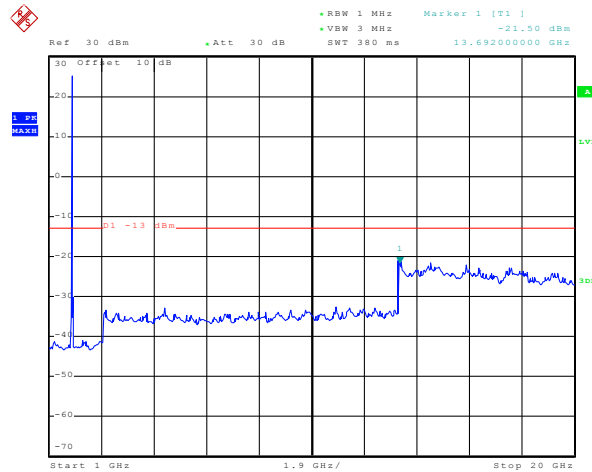

Date: 21.NOV.2015 21:54:46

1GHz~20GHz

Test Mode:	LTE band 2(1.4 MHz 16QAM) RB Size 3 & RB Offset 0	Test Channel:	Middle channel
------------	--	---------------	----------------

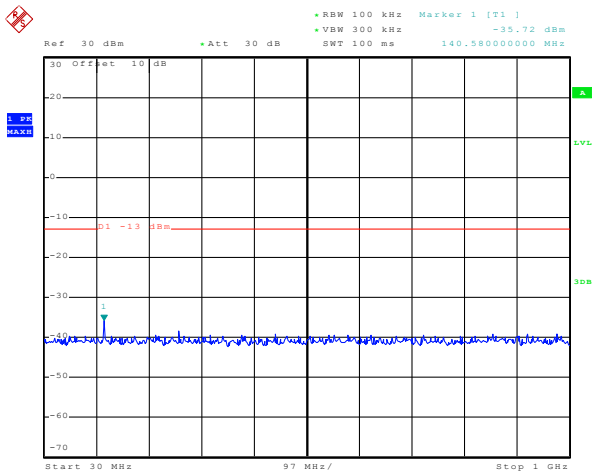

Date: 21.NOV.2015 21:59:07

30MHz~1GHz

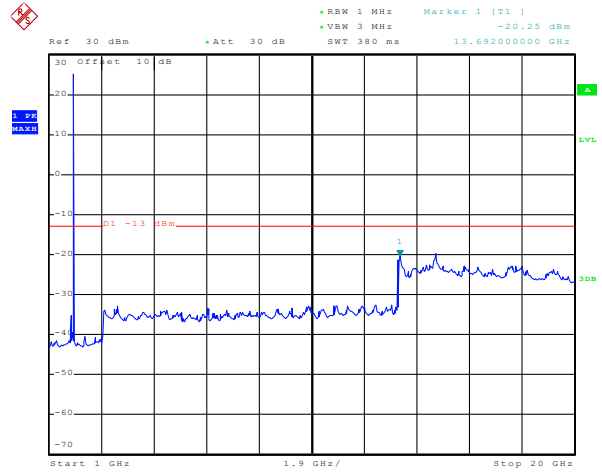

Date: 21.NOV.2015 21:56:39

1GHz~20GHz

Test Mode:	LTE band 2(1.4 MHz 16QAM) RB Size 3 & RB Offset 0	Test Channel:	Highest channel
------------	--	---------------	-----------------

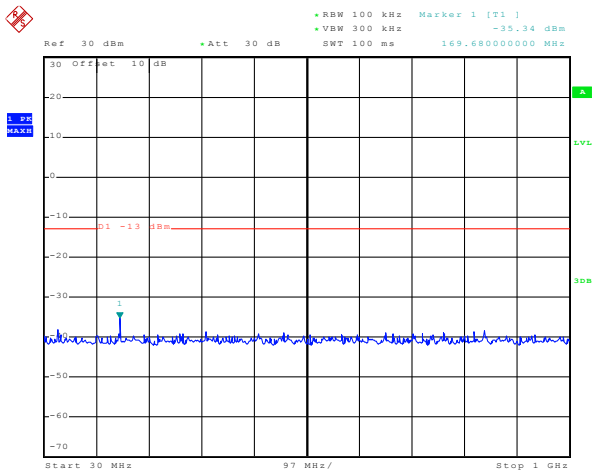

Date: 21.NOV.2015 22:01:16

30MHz~1GHz

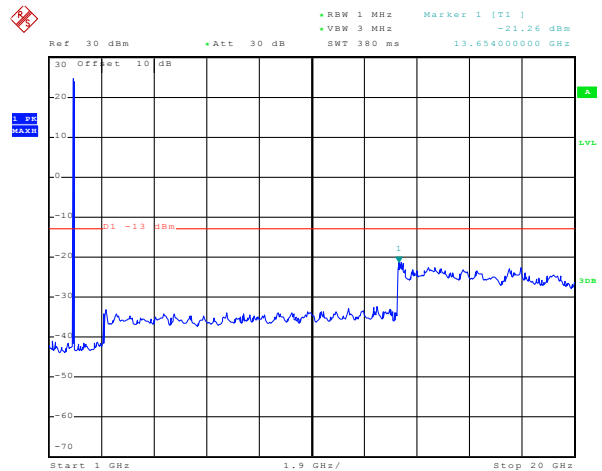

Date: 21.NOV.2015 22:05:28

1GHz~20GHz

Test Mode:	LTE band 2(1.4 MHz 16QAM) RB Size 6 & RB Offset 0	Test Channel:	Lowest channel
------------	--	---------------	----------------

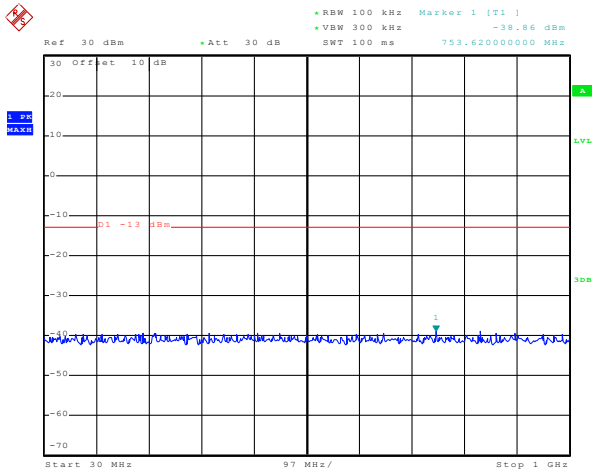

Date: 21.NOV.2015 21:52:09

30MHz~1GHz

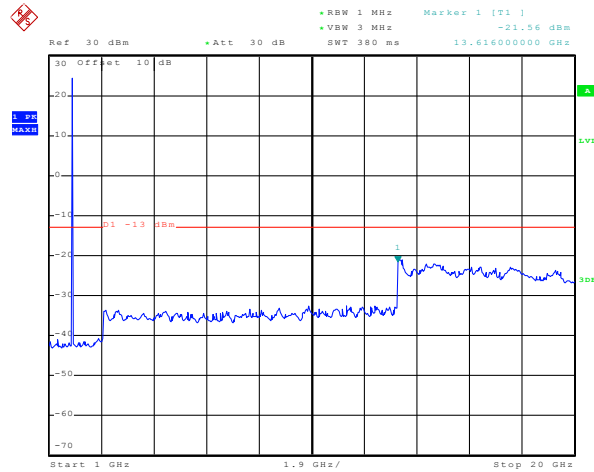

Date: 21.NOV.2015 21:52:59

1GHz~20GHz

Test Mode:	LTE band 2(1.4 MHz 16QAM) RB Size 6 & RB Offset 0	Test Channel:	Middle channel
------------	--	---------------	----------------

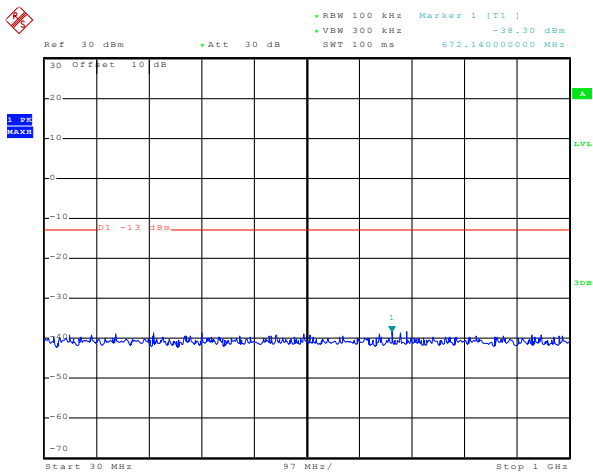

Date: 21.NOV.2015 21:58:02

30MHz~1GHz

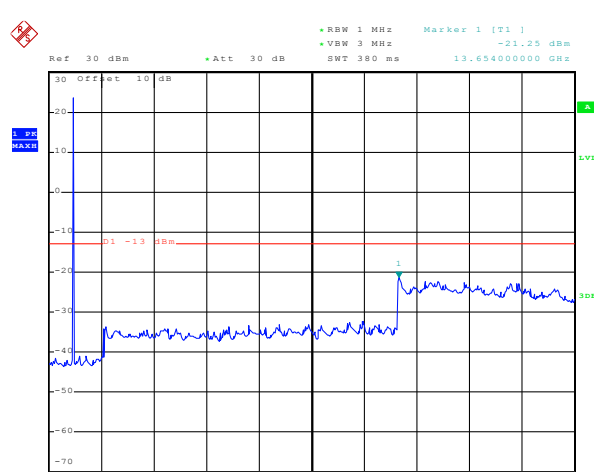

Date: 21.NOV.2015 21:57:35

1GHz~20GHz

Test Mode:	LTE band 2(1.4 MHz 16QAM) RB Size 6 & RB Offset 0	Test Channel:	Highest channel
------------	--	---------------	-----------------

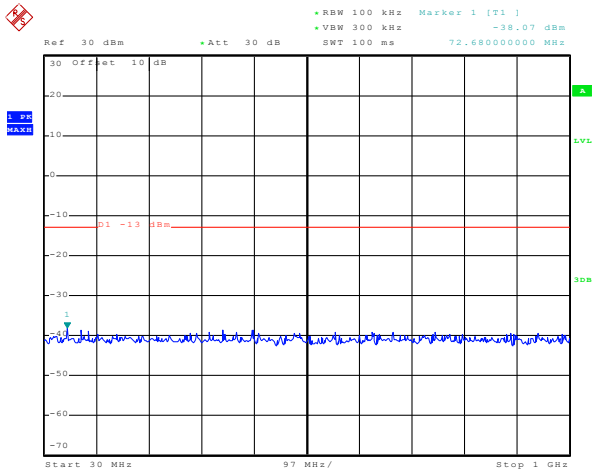

Date: 21.NOV.2015 22:02:02

30MHz~1GHz

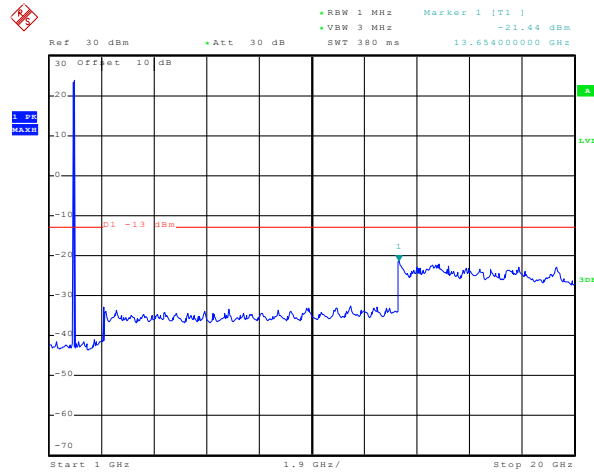

Date: 21.NOV.2015 22:04:00

1GHz~20GHz

Test Mode:	LTE band 2(1.4 MHz QPSK) RB Size 1 & RB Offset 0	Test Channel:	Lowest channel
------------	---	---------------	----------------

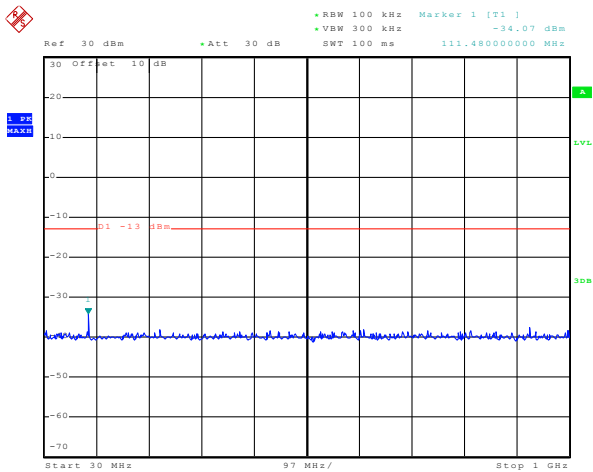

Date: 21.NOV.2015 21:50:57

30MHz~1GHz

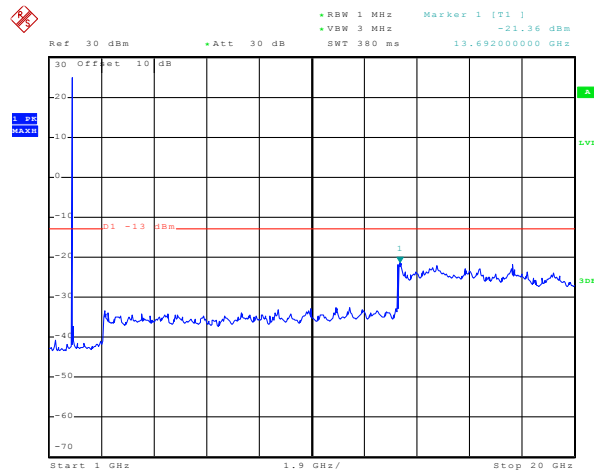

Date: 21.NOV.2015 21:53:44

1GHz~20GHz

Test Mode:	LTE band 2(1.4 MHz QPSK) RB Size 1 & RB Offset 0	Test Channel:	Middle channel
------------	---	---------------	----------------

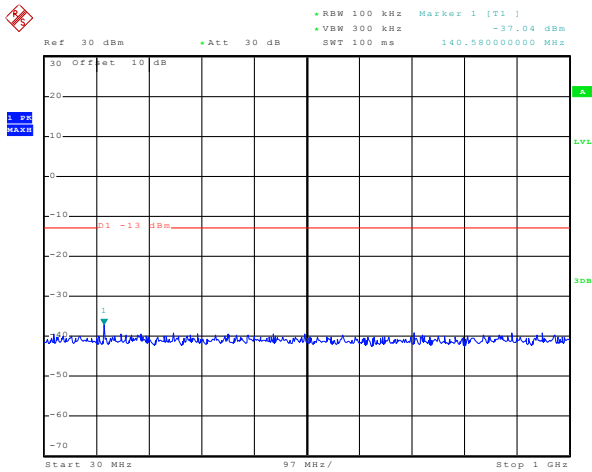

Date: 21.NOV.2015 21:58:26

30MHz~1GHz

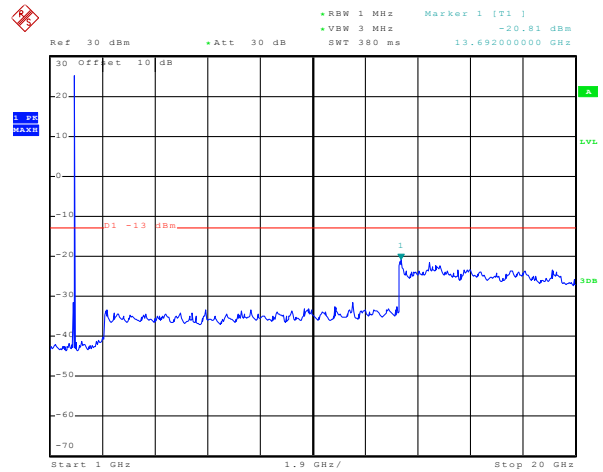

Date: 21.NOV.2015 21:55:49

1GHz~20GHz

Test Mode:	LTE band 2(1.4 MHz QPSK) RB Size 1 & RB Offset 0	Test Channel:	Highest channel
------------	---	---------------	-----------------

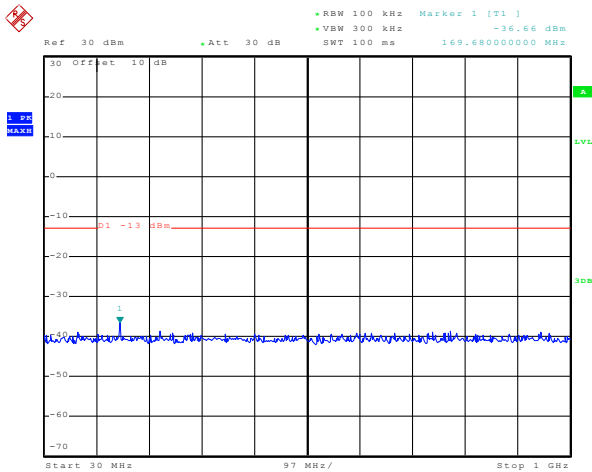

Date: 21.NOV.2015 22:00:44

30MHz~1GHz

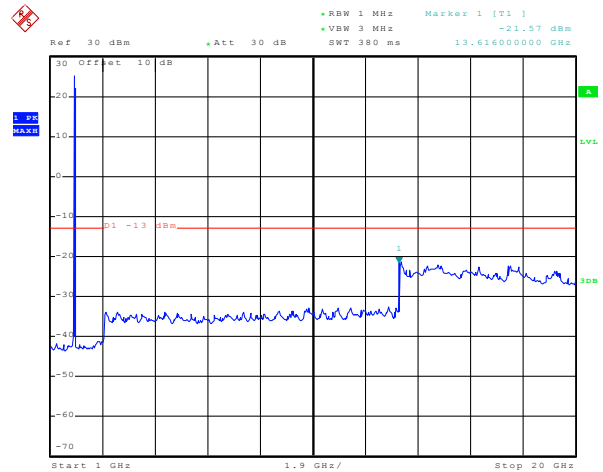

Date: 21.NOV.2015 22:04:49

1GHz~20GHz

Test Mode:	LTE band 2(1.4 MHz QPSK) RB Size 3 & RB Offset 0	Test Channel:	Lowest channel
------------	---	---------------	----------------

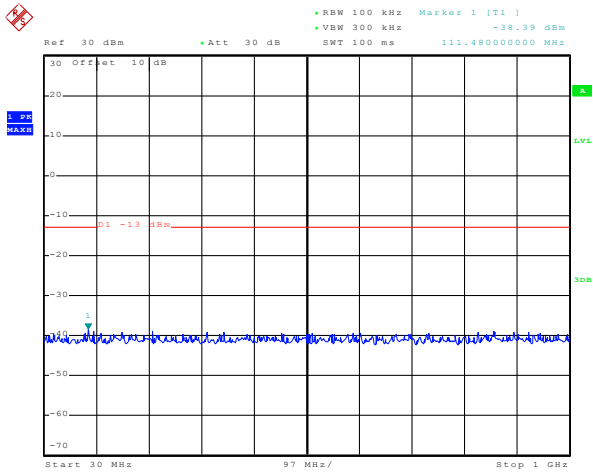

Date: 21.NOV.2015 21:51:47

30MHz~1GHz

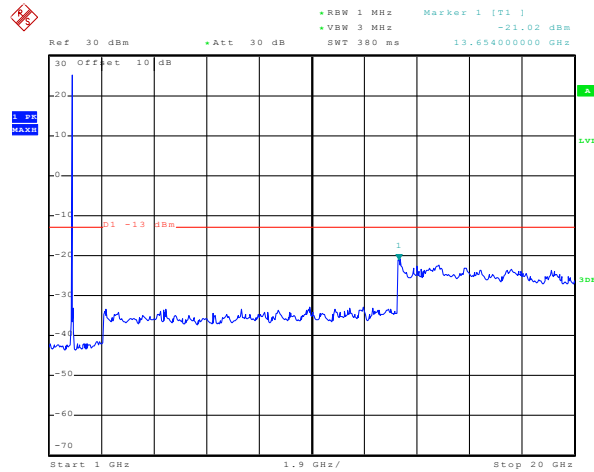

Date: 21.NOV.2015 21:55:03

1GHz~20GHz

Test Mode:	LTE band 2(1.4 MHz QPSK) RB Size 3 & RB Offset 0	Test Channel:	Middle channel
------------	---	---------------	----------------

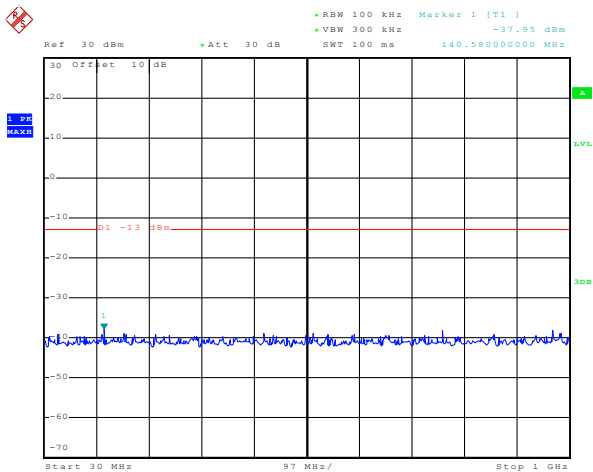

Date: 21.NOV.2015 21:59:26

30MHz~1GHz

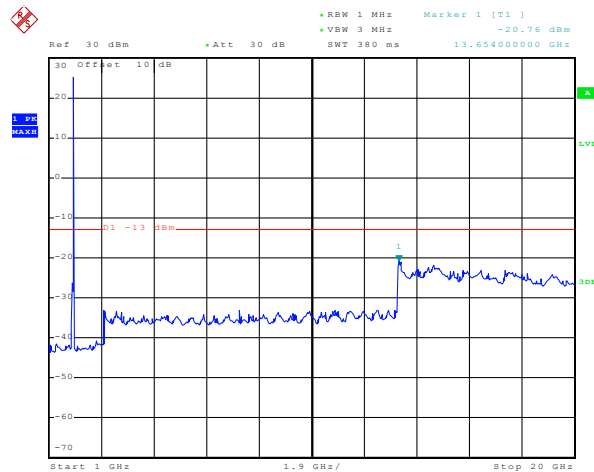

Date: 21.NOV.2015 21:57:01

1GHz~20GHz

Test Mode:	LTE band 2(1.4 MHz QPSK) RB Size 3 & RB Offset 0	Test Channel:	Highest channel
------------	---	---------------	-----------------

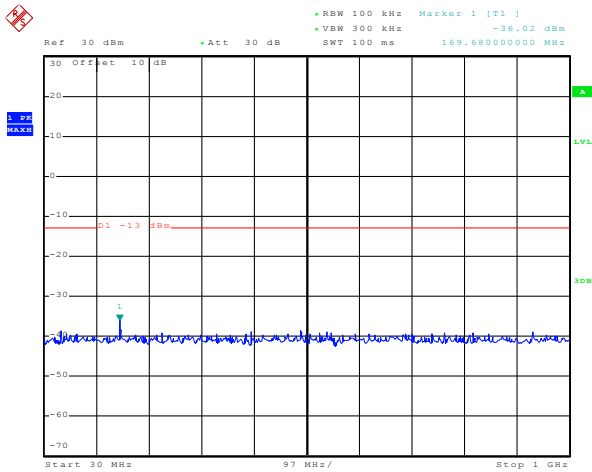

Date: 21.NOV.2015 22:01:30

30MHz~1GHz

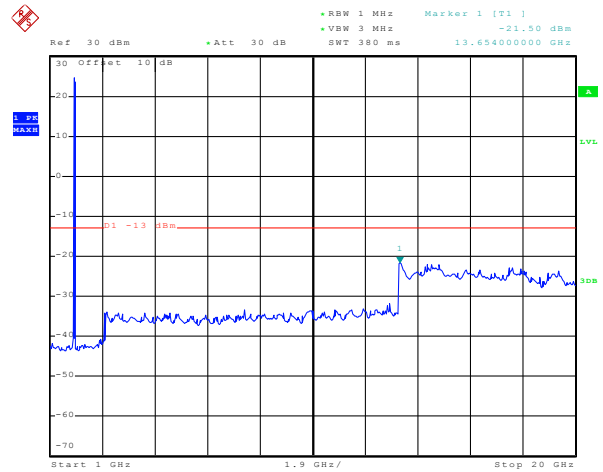

Date: 21.NOV.2015 22:05:50

1GHz~20GHz

Test Mode:	LTE band 2(1.4 MHz QPSK) RB Size 6 & RB Offset 0	Test Channel:	Lowest channel
------------	---	---------------	----------------

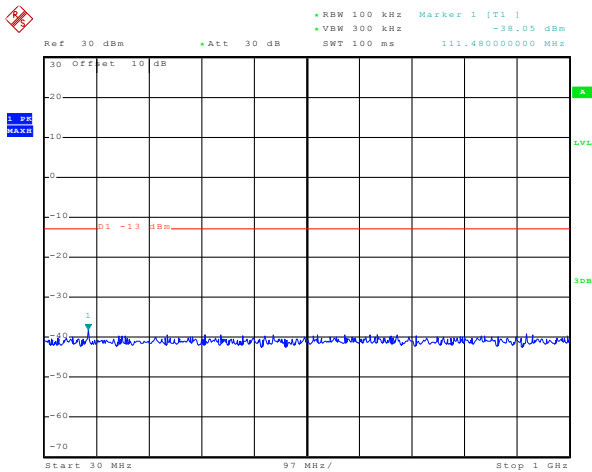

Date: 21.NOV.2015 21:51:58

30MHz~1GHz

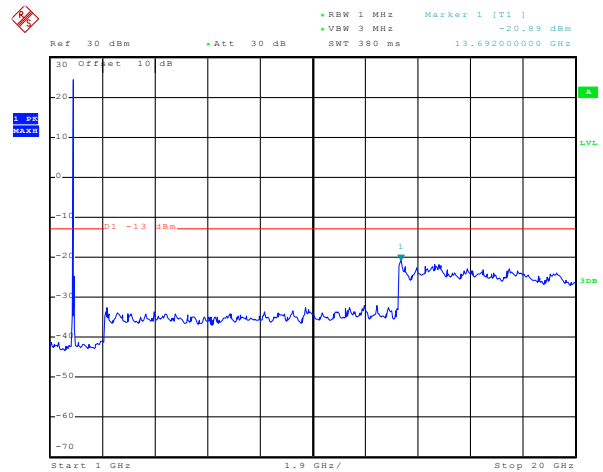

Date: 21.NOV.2015 21:53:28

1GHz~20GHz

Test Mode:	LTE band 2(1.4 MHz QPSK) RB Size 6 & RB Offset 0	Test Channel:	Middle channel
------------	---	---------------	----------------

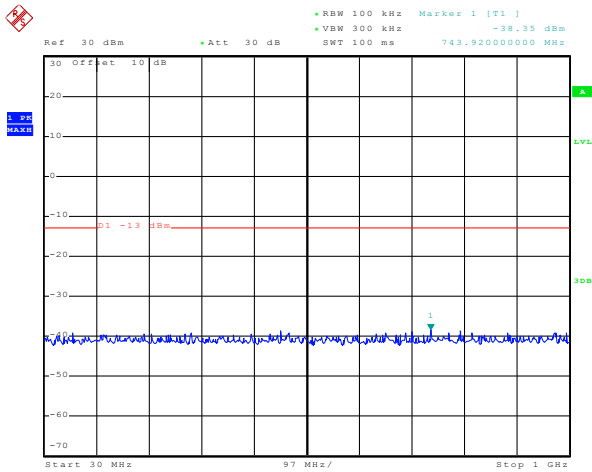

Date: 21.NOV.2015 21:58:15

30MHz~1GHz

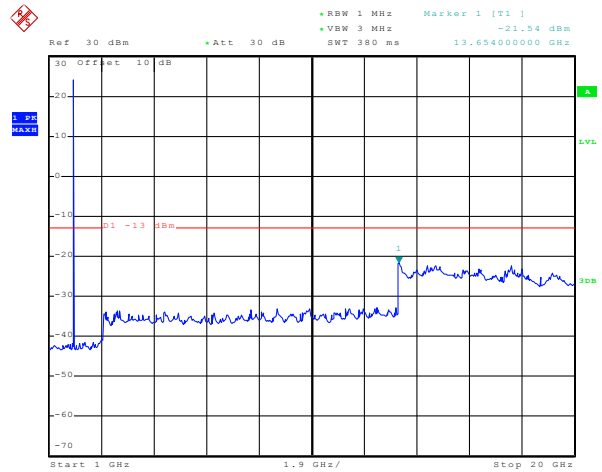

Date: 21.NOV.2015 21:57:17

1GHz~20GHz

Test Mode:	LTE band 2(1.4 MHz QPSK) RB Size 6 & RB Offset 0	Test Channel:	Highest channel
------------	---	---------------	-----------------

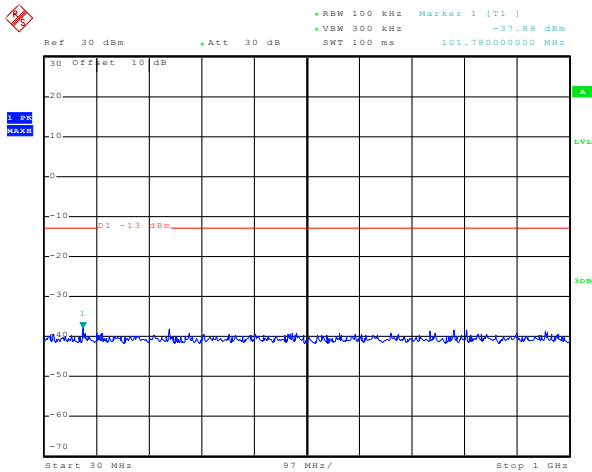

Date: 21.NOV.2015 22:01:50

30MHz~1GHz

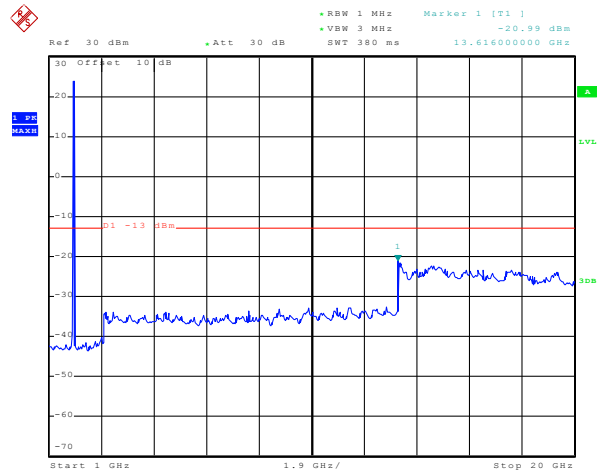

Date: 21.NOV.2015 22:04:19

1GHz~20GHz

3MHz

Test Mode:	LTE band 2(3MHz 16QAM) RB Size 1 & RB Offset 0	Test Channel:	Lowest channel
------------	---	---------------	----------------

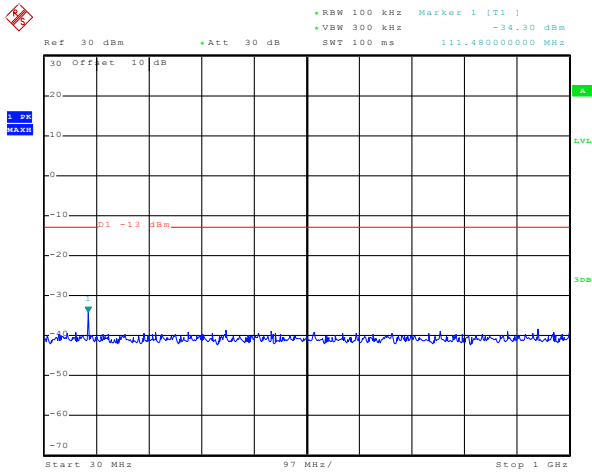

Date: 21.NOV.2015 22:14:15

30MHz~1GHz

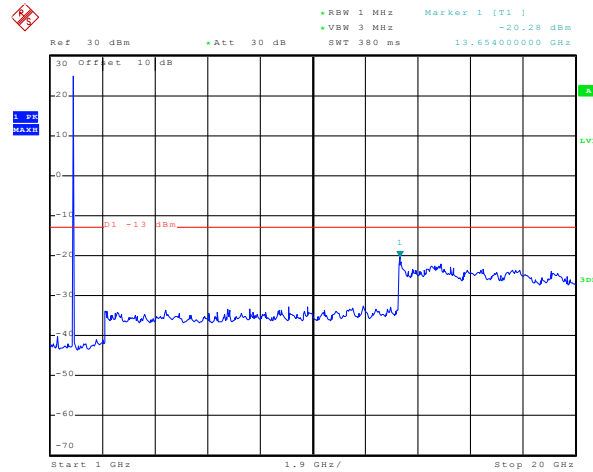

Date: 21.NOV.2015 22:08:15

1GHz~20GHz

Test Mode:	LTE band 2(3MHz 16QAM) RB Size 1 & RB Offset 0	Test Channel:	Middle channel
------------	---	---------------	----------------

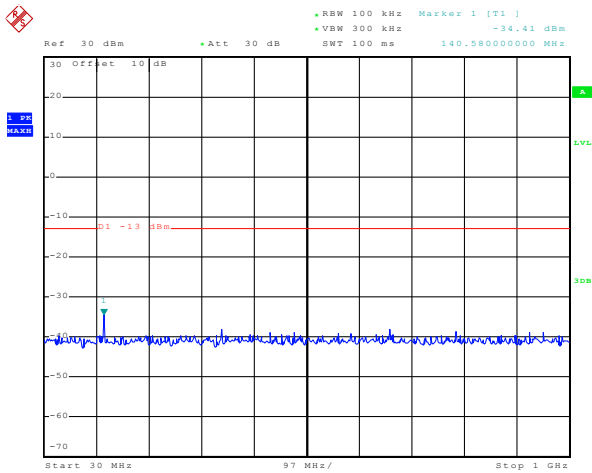

Date: 21.NOV.2015 22:15:28

30MHz~1GHz

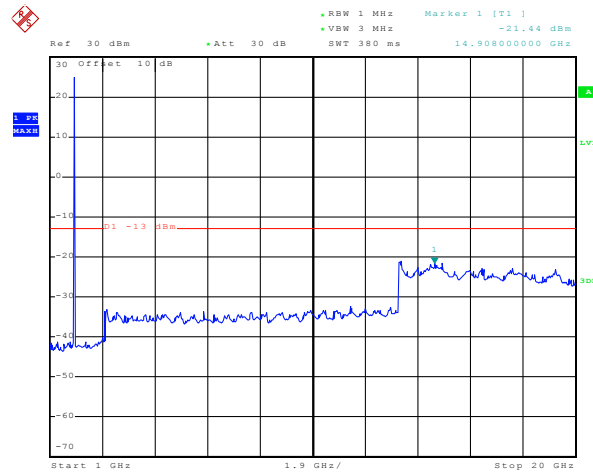

Date: 21.NOV.2015 22:19:02

1GHz~20GHz

Test Mode:	LTE band 2(3MHz 16QAM) RB Size 1 & RB Offset 0	Test Channel:	Highest channel
------------	---	---------------	-----------------

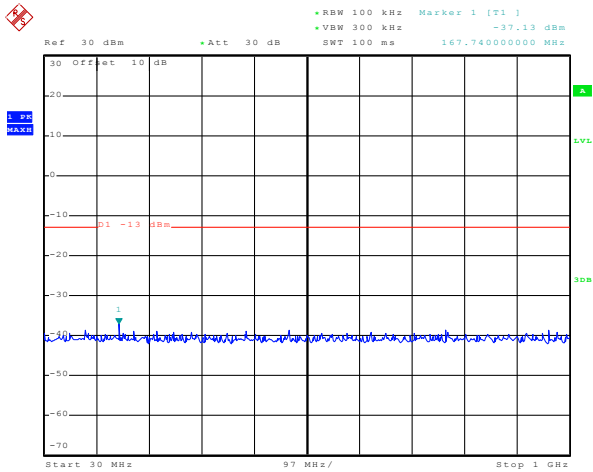

Date: 21.NOV.2015 22:23:48

30MHz~1GHz

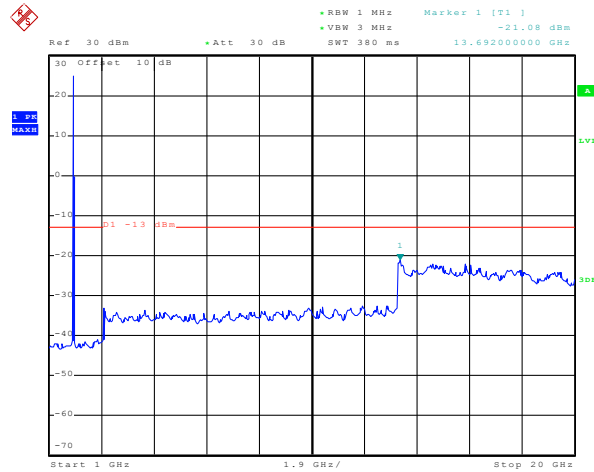

Date: 21.NOV.2015 22:20:43

1GHz~20GHz

Test Mode:	LTE band 2(3MHz 16QAM) RB Size 8 & RB Offset 0	Test Channel:	Lowest channel
------------	---	---------------	----------------

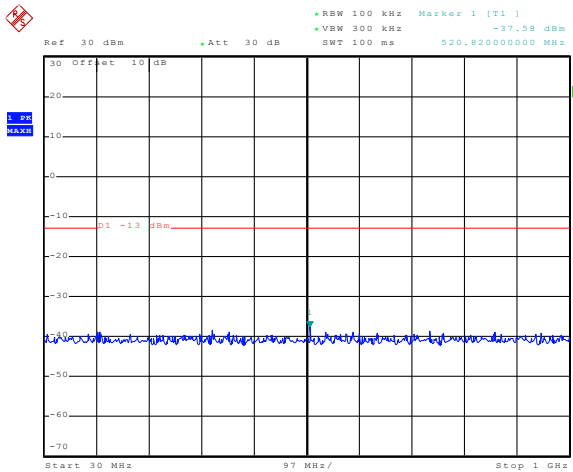

Date: 21.NOV.2015 22:14:33

30MHz~1GHz

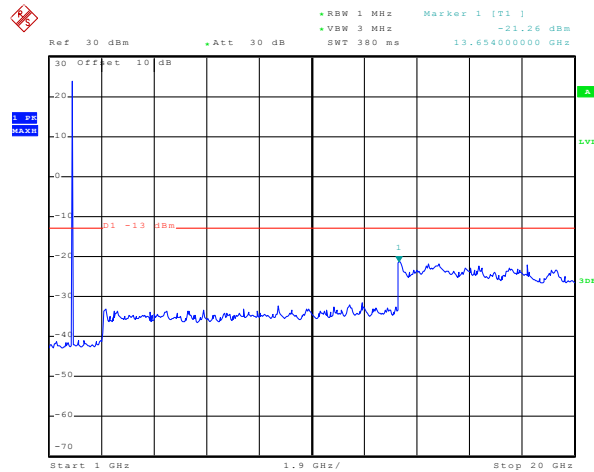

Date: 21.NOV.2015 22:09:17

1GHz~20GHz

Test Mode:	LTE band 2(3MHz 16QAM) RB Size 8 & RB Offset 0	Test Channel:	Middle channel
------------	---	---------------	----------------

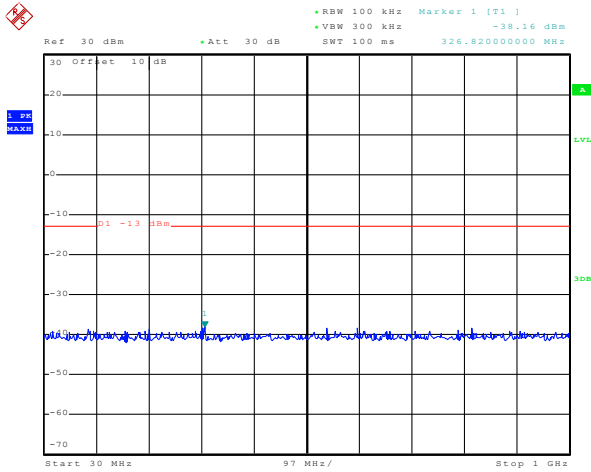

Date: 21.NOV.2015 22:15:52

30MHz~1GHz

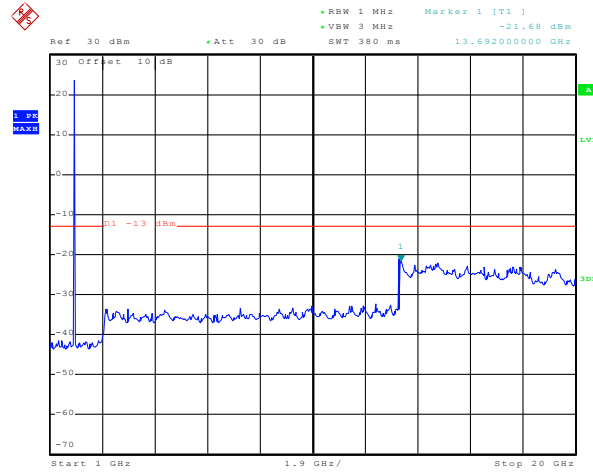

Date: 21.NOV.2015 22:19:20

1GHz~20GHz

Test Mode:	LTE band 2(3MHz 16QAM) RB Size 8 & RB Offset 0	Test Channel:	Highest channel
------------	---	---------------	-----------------

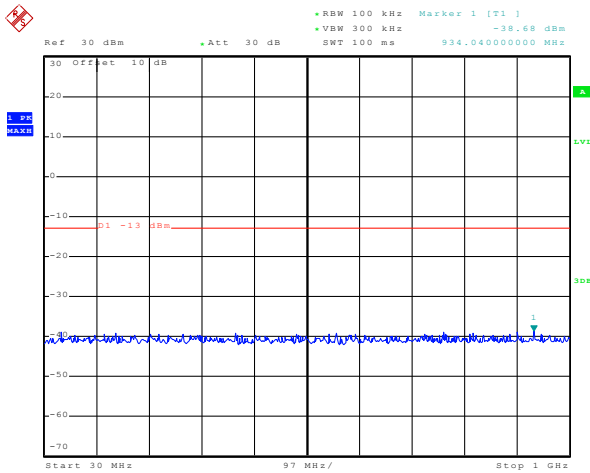

Date: 21.NOV.2015 22:24:11

30MHz~1GHz

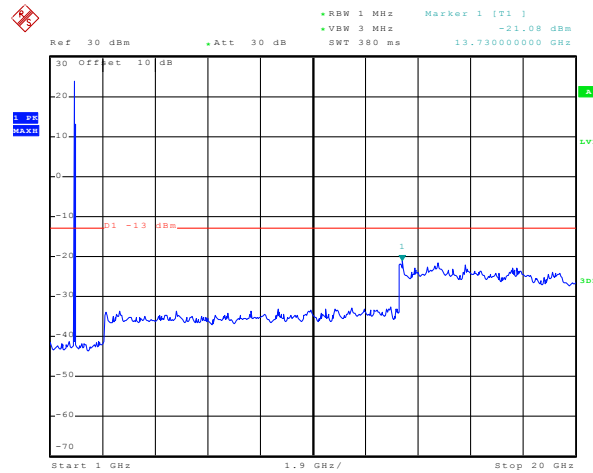

Date: 21.NOV.2015 22:21:07

1GHz~20GHz

Test Mode:	LTE band 2(3MHz 16QAM) RB Size 15& RB Offset 0	Test Channel:	Lowest channel
------------	---	---------------	----------------

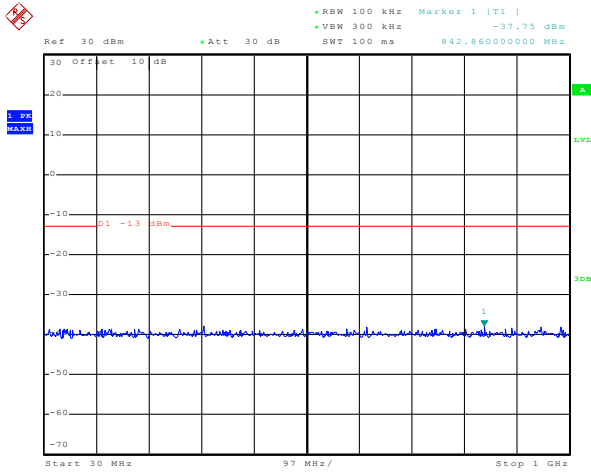

Date: 21.NOV.2015 22:13:00

30MHz~1GHz

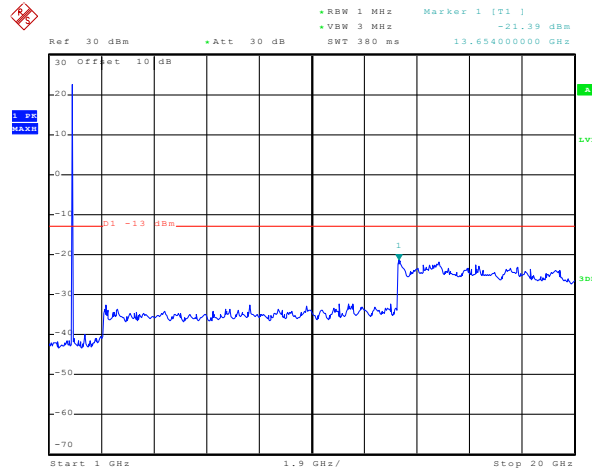

Date: 21.NOV.2015 22:10:50

1GHz~20GHz

Test Mode:	LTE band 2(3MHz 16QAM) RB Size 15& RB Offset 0	Test Channel:	Middle channel
------------	---	---------------	----------------

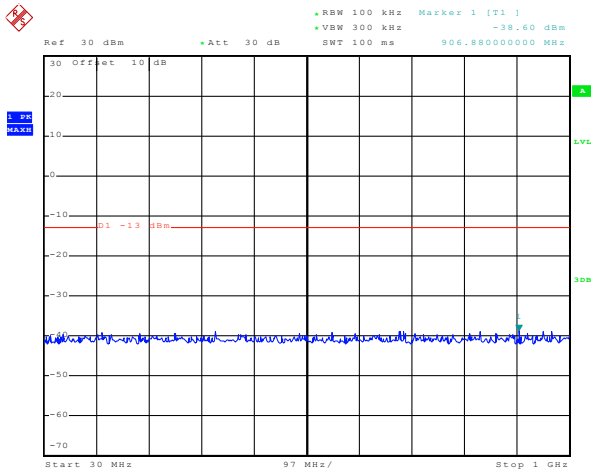

Date: 21.NOV.2015 22:17:01

30MHz~1GHz

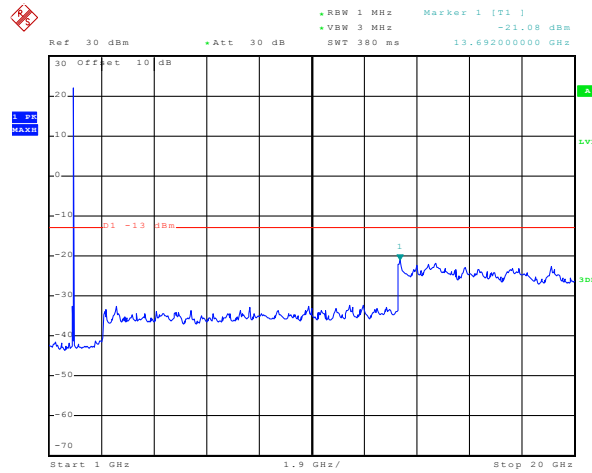

Date: 21.NOV.2015 22:17:48

1GHz~20GHz

Test Mode:	LTE band 2(3MHz 16QAM) RB Size 15& RB Offset 0	Test Channel:	Highest channel
------------	---	---------------	-----------------

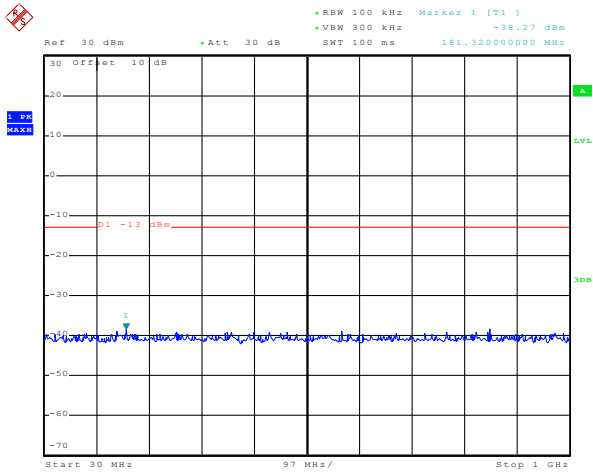

Date: 21.NOV.2015 22:23:05

30MHz~1GHz

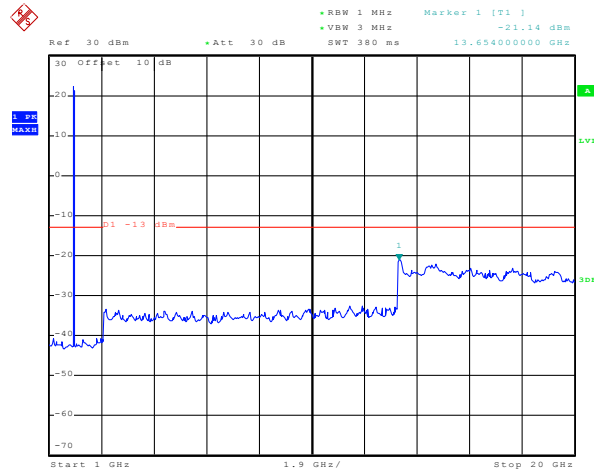

Date: 21.NOV.2015 22:22:20

1GHz~20GHz

Test Mode:	LTE band 2(3MHz QPSK) RB Size 1 & RB Offset 0	Test Channel:	Lowest channel
------------	--	---------------	----------------

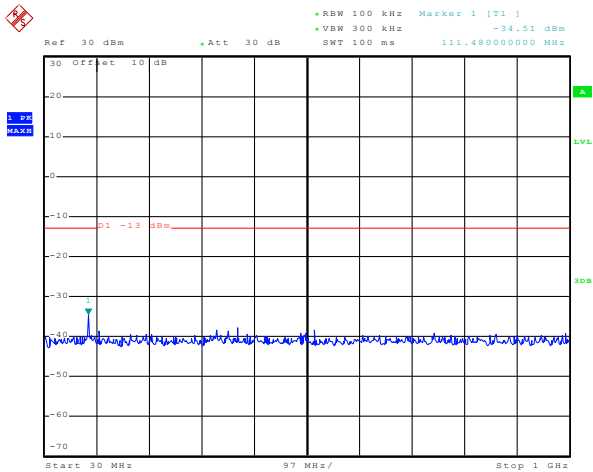

Date: 21.NOV.2015 22:13:59

30MHz~1GHz

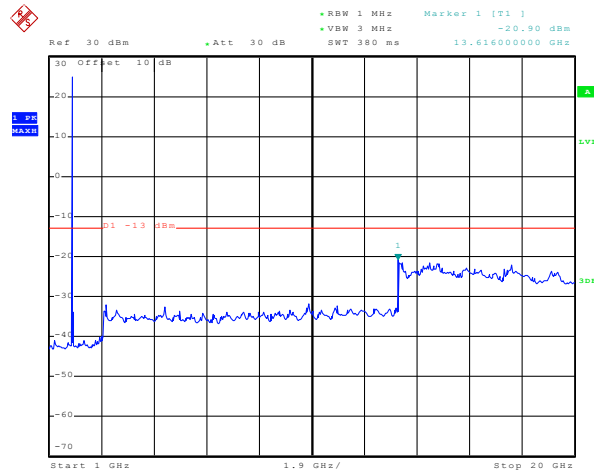

Date: 21.NOV.2015 22:07:47

1GHz~20GHz

Test Mode:	LTE band 2(3MHz QPSK) RB Size 1 & RB Offset 0	Test Channel:	Middle channel
------------	--	---------------	----------------

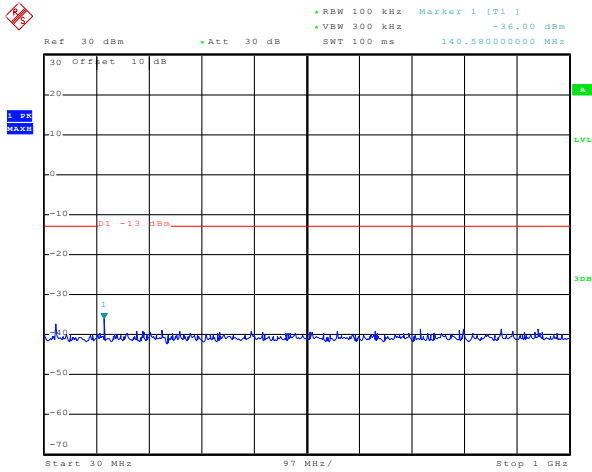

Date: 21.NOV.2015 22:15:15

30MHz~1GHz

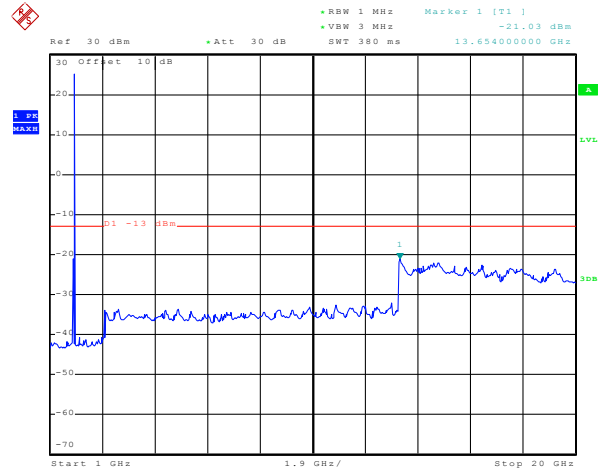

Date: 21.NOV.2015 22:18:32

1GHz~20GHz

Test Mode:	LTE band 2(3MHz QPSK) RB Size 1 & RB Offset 0	Test Channel:	Highest channel
------------	--	---------------	-----------------

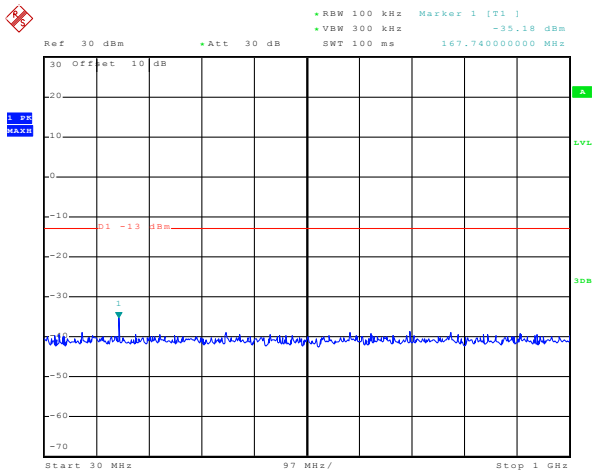

Date: 21.NOV.2015 22:23:29

30MHz~1GHz

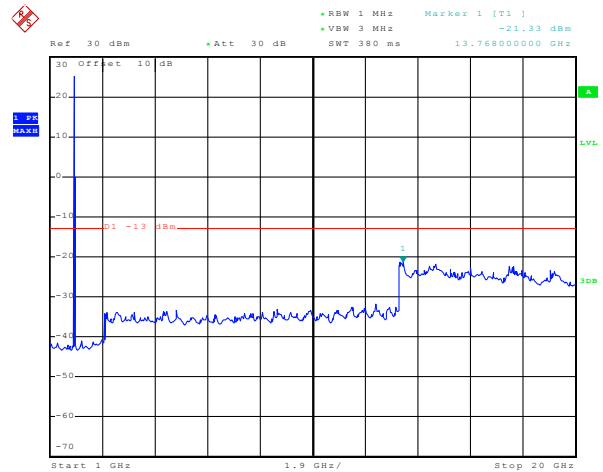

Date: 21.NOV.2015 22:20:17

1GHz~20GHz

Test Mode:	LTE band 2(3MHz QPSK) RB Size 8 & RB Offset 0	Test Channel:	Lowest channel
------------	--	---------------	----------------

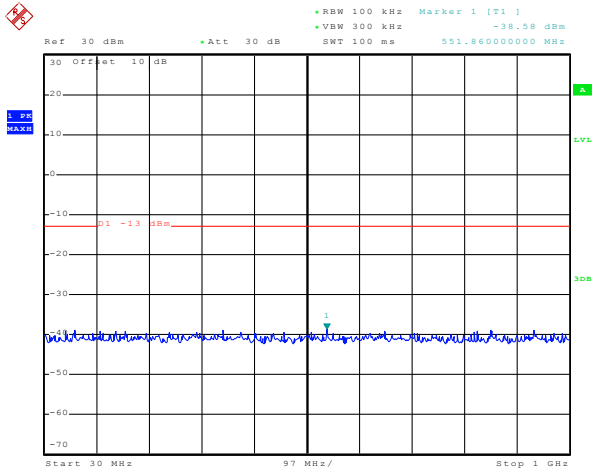

Date: 21.NOV.2015 22:14:47

30MHz~1GHz

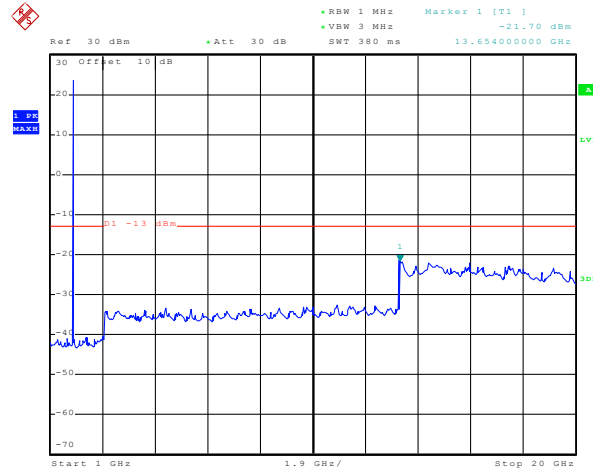

Date: 21.NOV.2015 22:09:47

1GHz~20GHz

Test Mode:	LTE band 2(3MHz QPSK) RB Size 8 & RB Offset 0	Test Channel:	Middle channel
------------	--	---------------	----------------

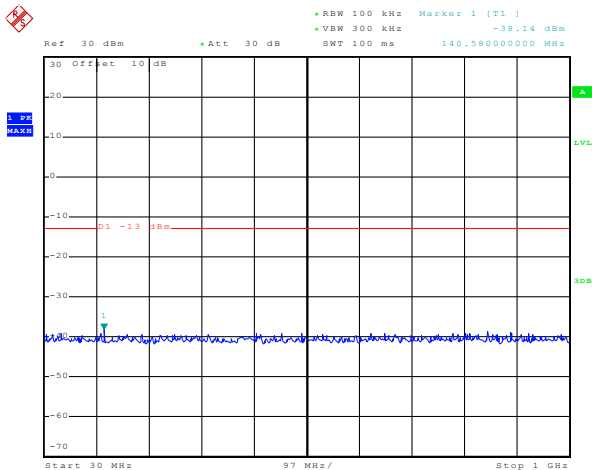

Date: 21.NOV.2015 22:16:12

30MHz~1GHz

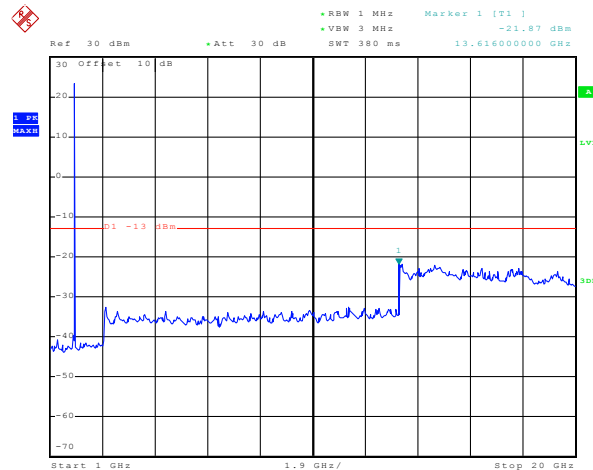

Date: 21.NOV.2015 22:19:42

1GHz~20GHz

Test Mode:	LTE band 2(3MHz QPSK) RB Size 8 & RB Offset 0	Test Channel:	Highest channel
------------	--	---------------	-----------------

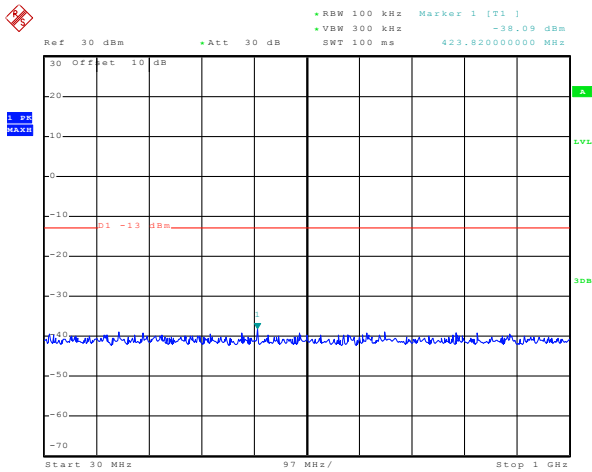

Date: 21.NOV.2015 22:24:24

30MHz~1GHz

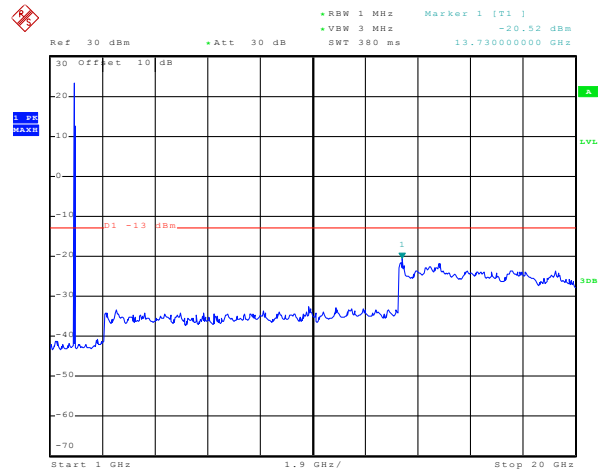

Date: 21.NOV.2015 22:21:30

1GHz~20GHz

Test Mode:	LTE band 2(3MHz QPSK) RB Size 15& RB Offset 0	Test Channel:	Lowest channel
------------	--	---------------	----------------

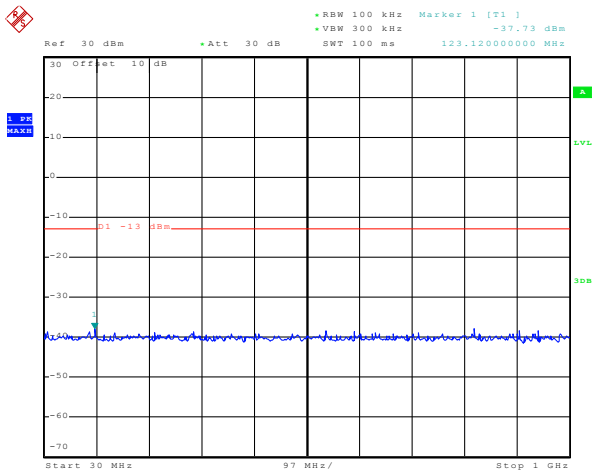

Date: 21.NOV.2015 22:13:48

30MHz~1GHz

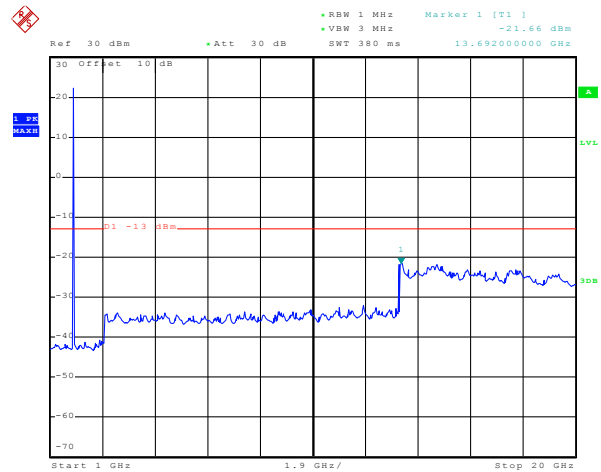

Date: 21.NOV.2015 22:10:22

1GHz~20GHz

Test Mode:	LTE band 2(3MHz QPSK) RB Size 15& RB Offset 0	Test Channel:	Middle channel
------------	--	---------------	----------------

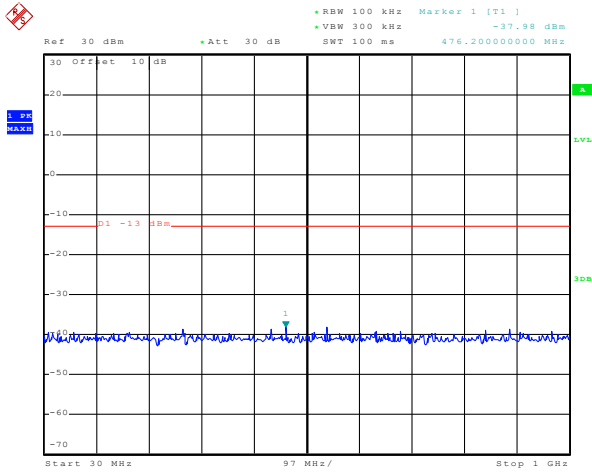

Date: 21.NOV.2015 22:16:48

30MHz~1GHz

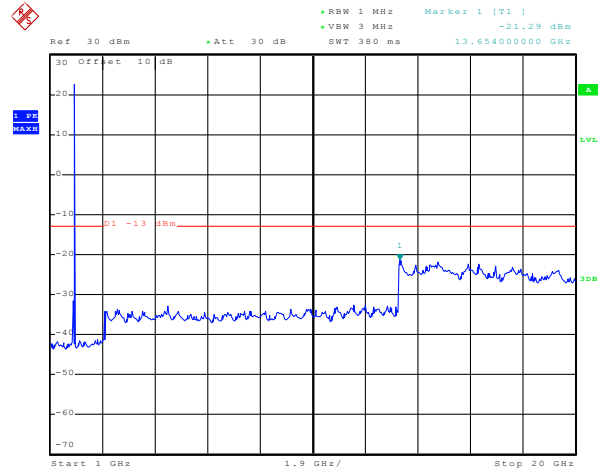

Date: 21.NOV.2015 22:18:10

1GHz~20GHz

Test Mode:	LTE band 2(3MHz QPSK) RB Size 15& RB Offset 0	Test Channel:	Highest channel
------------	--	---------------	-----------------

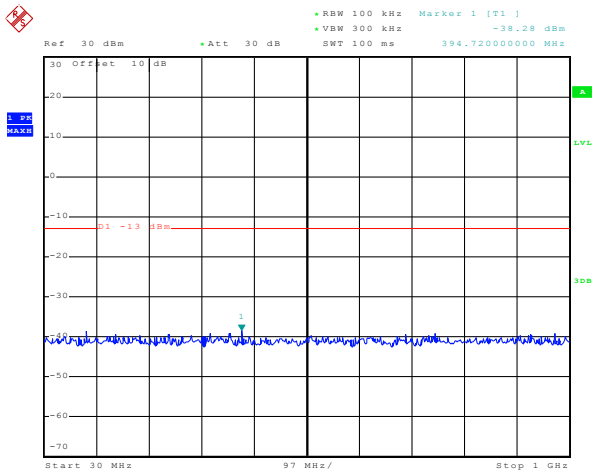

Date: 21.NOV.2015 22:23:16

30MHz~1GHz

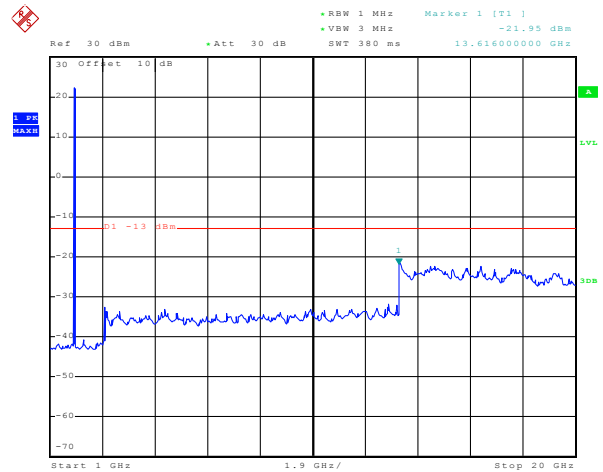

Date: 21.NOV.2015 22:21:49

1GHz~20GHz

5MHz

Test Mode:	LTE band 2(5MHz 16QAM) RB Size 1& RB Offset 0	Test Channel:	Lowest channel
------------	--	---------------	----------------

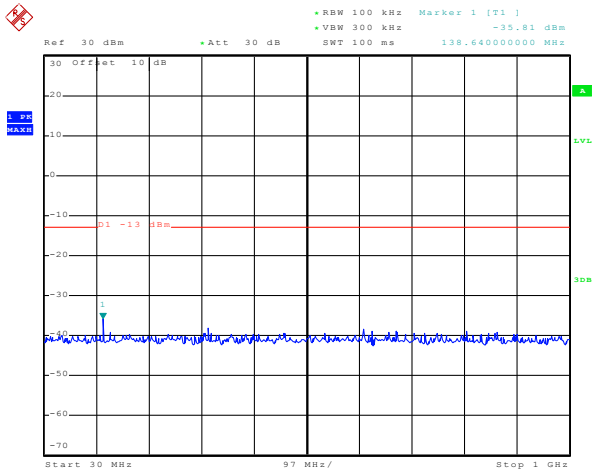

Date: 26.NOV.2015 21:58:58

30MHz~1GHz

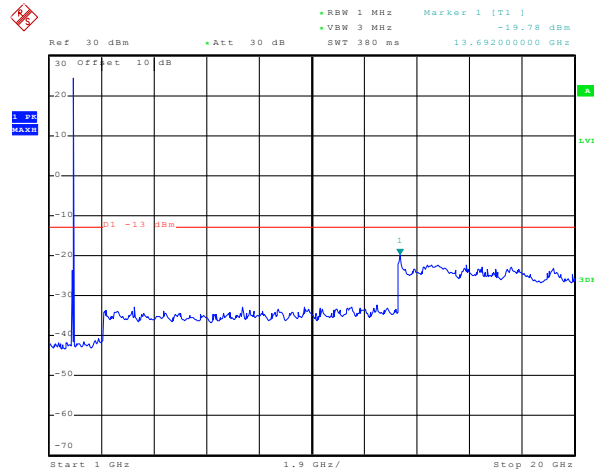

Date: 26.NOV.2015 22:02:21

1GHz~20GHz

Test Mode:	LTE band 2(5MHz 16QAM) RB Size 1& RB Offset 0	Test Channel:	Middle channel
------------	--	---------------	----------------

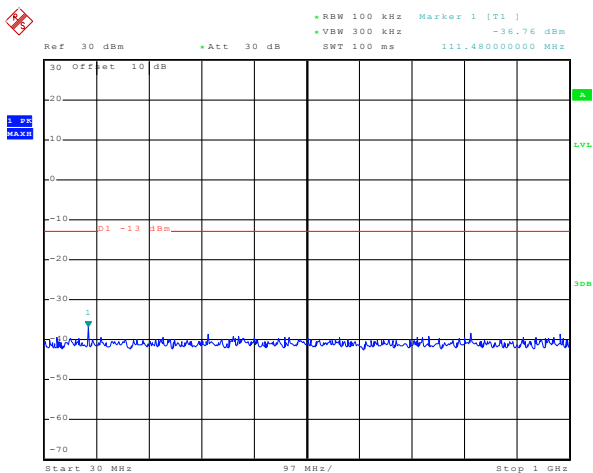

Date: 26.NOV.2015 22:08:05

30MHz~1GHz

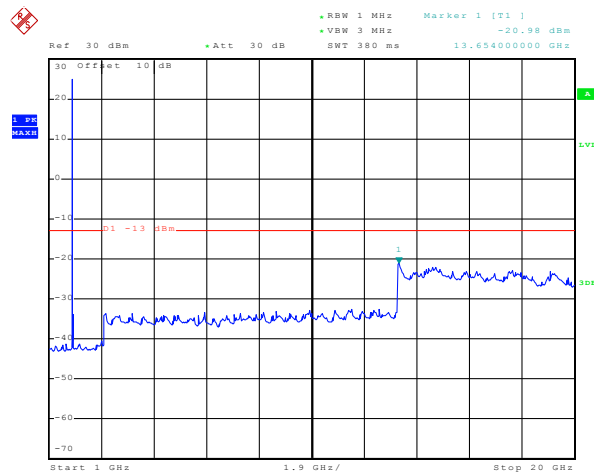

Date: 26.NOV.2015 22:04:46

1GHz~20GHz

Test Mode:	LTE band 2(5MHz 16QAM) RB Size 1& RB Offset 0	Test Channel:	Highest channel
------------	--	---------------	-----------------

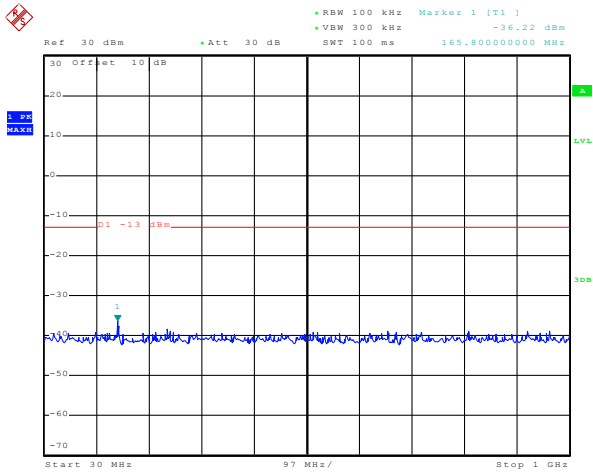

Date: 26.NOV.2015 22:10:38

30MHz~1GHz

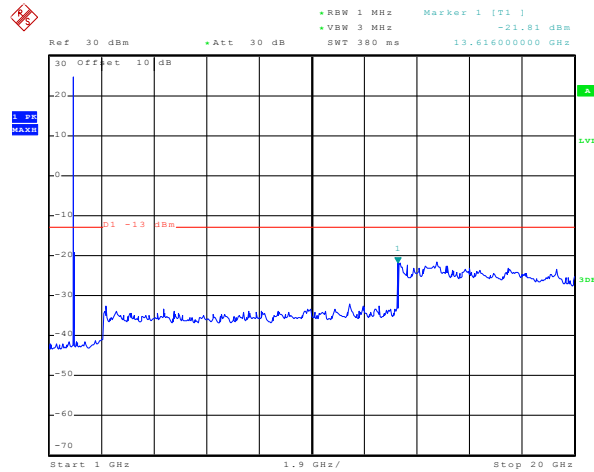

Date: 26.NOV.2015 22:14:07

1GHz~20GHz

Test Mode:	LTE band 2(5MHz 16QAM) RB Size 12& RB Offset 0	Test Channel:	Lowest channel
------------	---	---------------	----------------

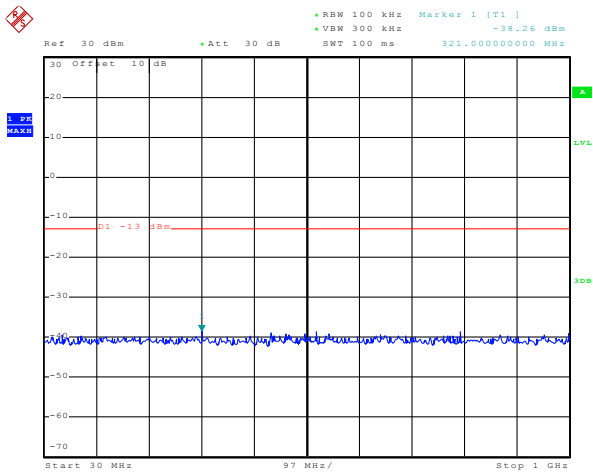

Date: 26.NOV.2015 21:59:26

30MHz~1GHz

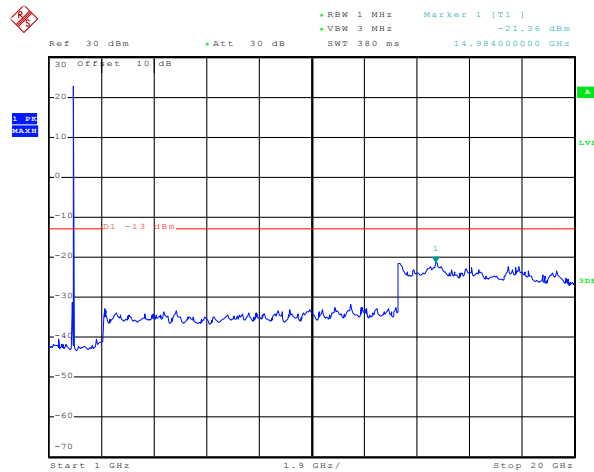

Date: 26.NOV.2015 22:02:55

1GHz~20GHz

Test Mode:	LTE band 2(5MHz 16QAM) RB Size 12& RB Offset 0	Test Channel:	Middle channel
------------	---	---------------	----------------

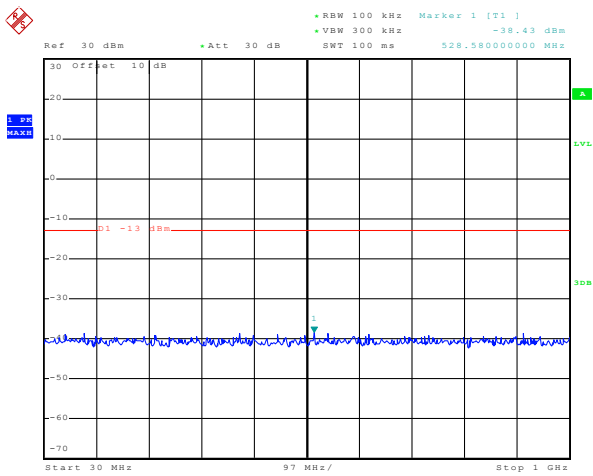

Date: 26.NOV.2015 22:08:30

30MHz~1GHz

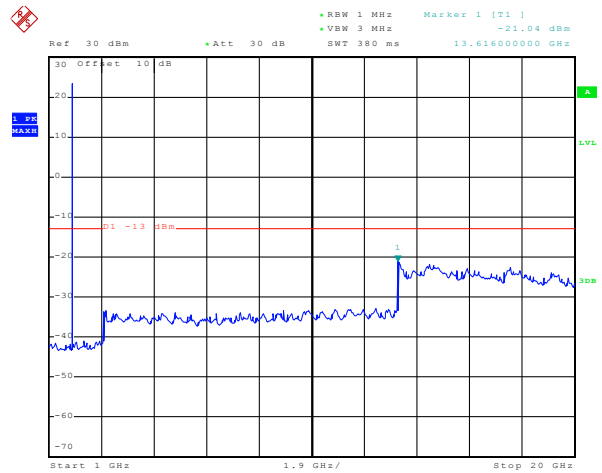

Date: 26.NOV.2015 22:05:18

1GHz~20GHz

Test Mode:	LTE band 2(5MHz 16QAM) RB Size 12& RB Offset 0	Test Channel:	Highest channel
------------	---	---------------	-----------------

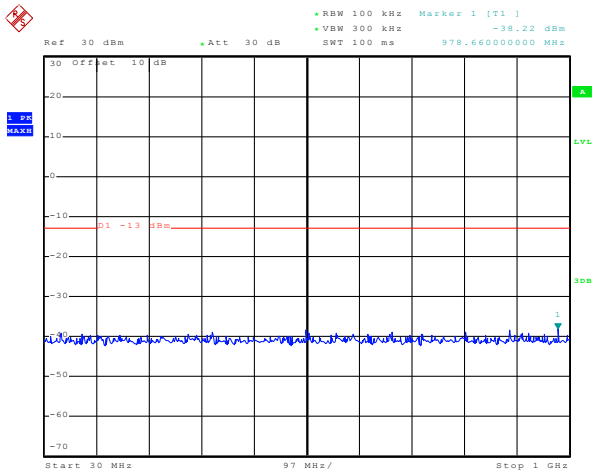

Date: 26.NOV.2015 22:10:55

30MHz~1GHz

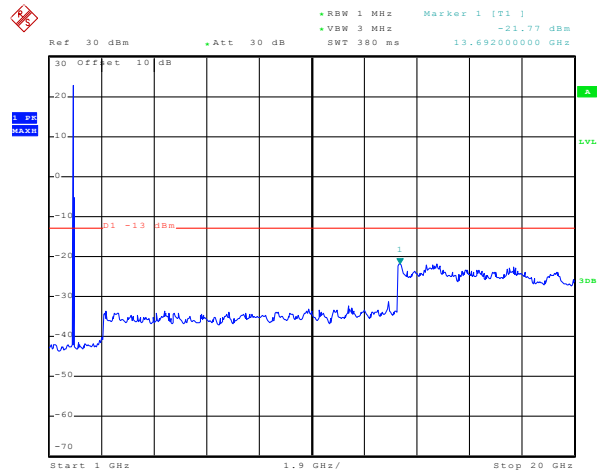

Date: 26.NOV.2015 22:14:39

1GHz~20GHz

Test Mode:	LTE band 2(5MHz 16QAM) RB Size 25& RB Offset 0	Test Channel:	Lowest channel
------------	---	---------------	----------------

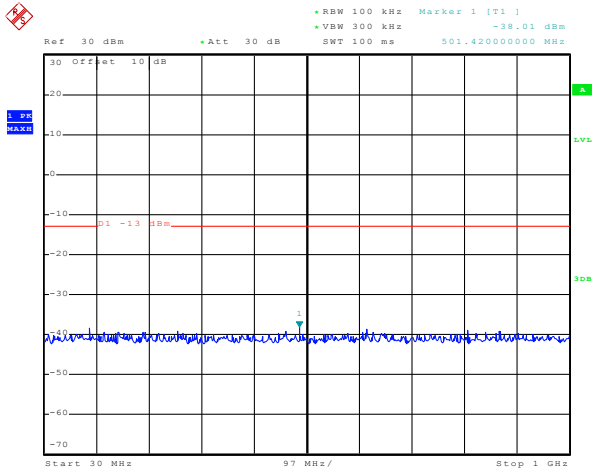

Date: 26.NOV.2015 22:00:15

30MHz~1GHz

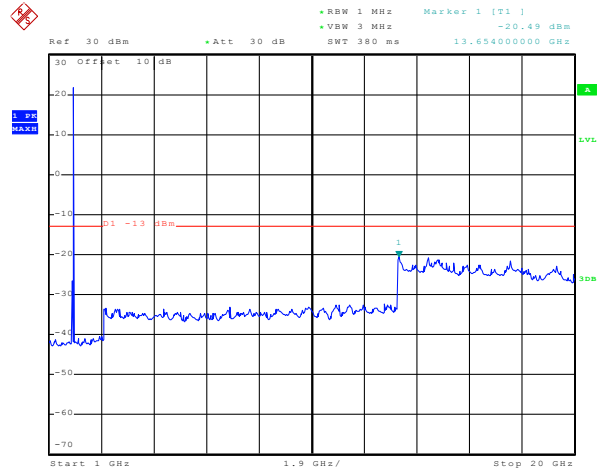

Date: 26.NOV.2015 22:00:59

1GHz~20GHz

Test Mode:	LTE band 2(5MHz 16QAM) RB Size 25& RB Offset 0	Test Channel:	Middle channel
------------	---	---------------	----------------

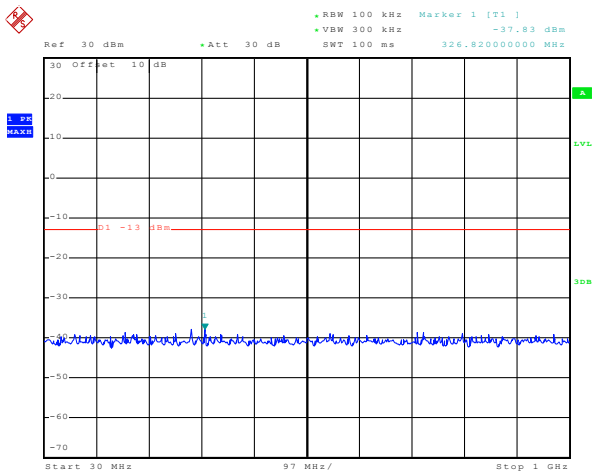

Date: 26.NOV.2015 22:07:26

30MHz~1GHz

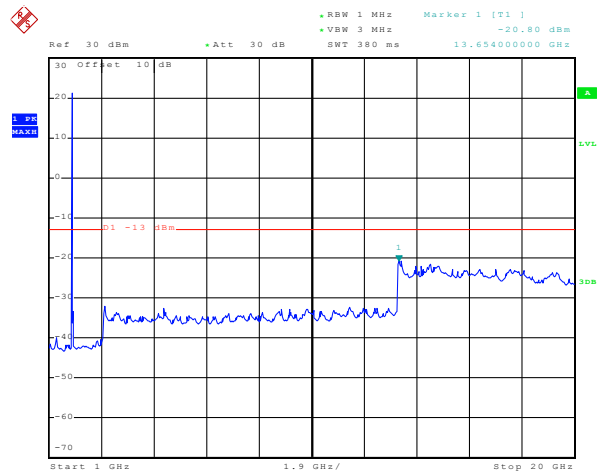

Date: 26.NOV.2015 22:07:00

1GHz~20GHz

Test Mode:	LTE band 2(5MHz 16QAM) RB Size 25& RB Offset 0	Test Channel:	Highest channel
------------	---	---------------	-----------------

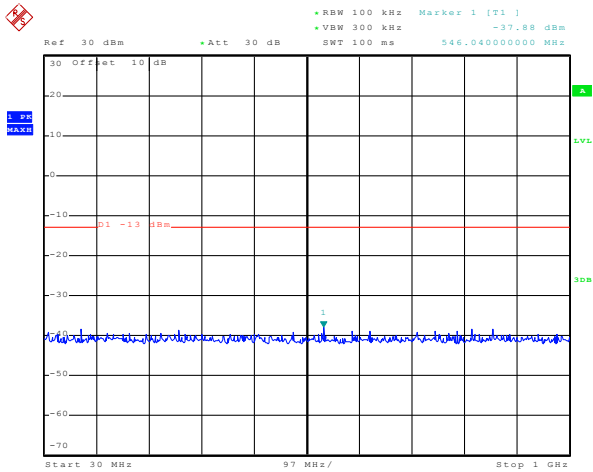

Date: 26.NOV.2015 22:11:43

30MHz~1GHz

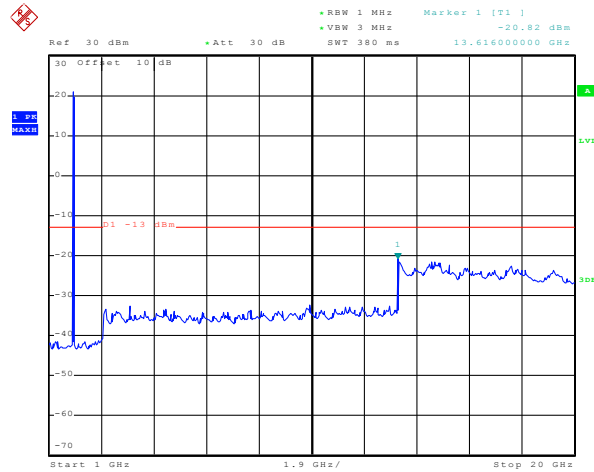

Date: 26.NOV.2015 22:12:46

1GHz~20GHz

Test Mode:	LTE band 2(5MHz QPSK) RB Size 1& RB Offset 0	Test Channel:	Lowest channel
------------	---	---------------	----------------

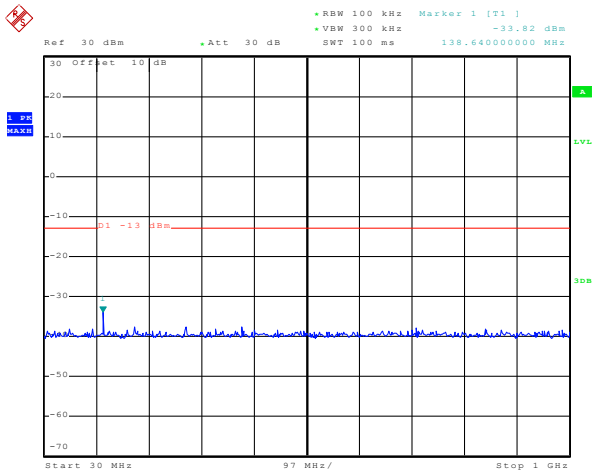

Date: 26.NOV.2015 21:58:39

30MHz~1GHz

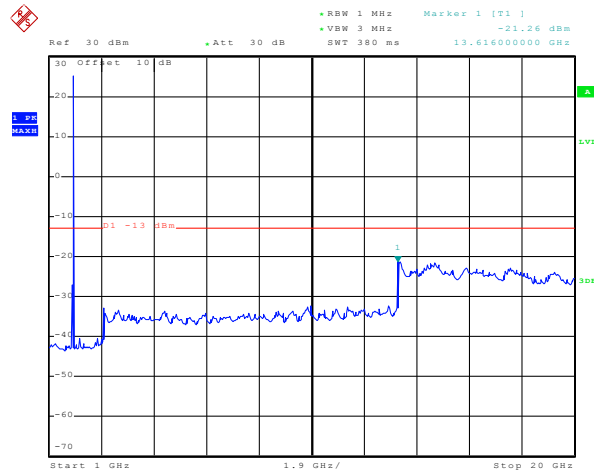

Date: 26.NOV.2015 22:01:48

1GHz~20GHz

Test Mode:	LTE band 2(5MHz QPSK) RB Size 1& RB Offset 0	Test Channel:	Middle channel
------------	---	---------------	----------------

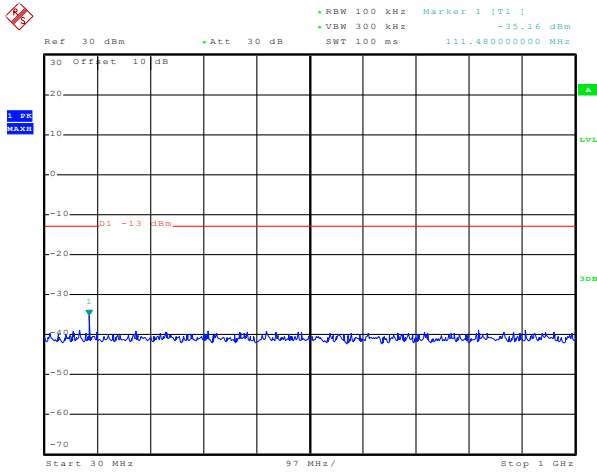

Date: 26.NOV.2015 22:07:51

30MHz~1GHz

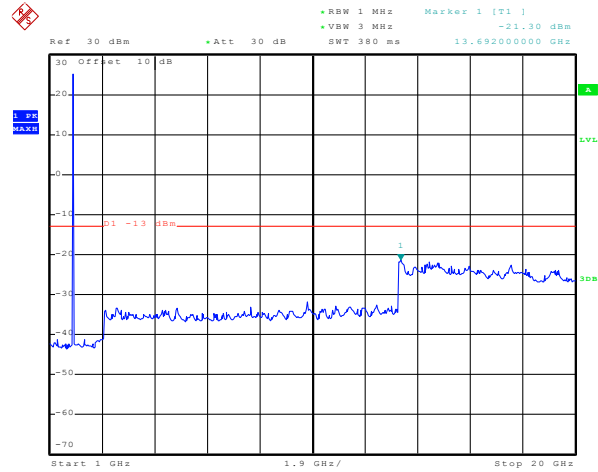

Date: 26.NOV.2015 22:04:18

1GHz~20GHz

Test Mode:	LTE band 2(5MHz QPSK) RB Size 1& RB Offset 0	Test Channel:	Highest channel
------------	---	---------------	-----------------

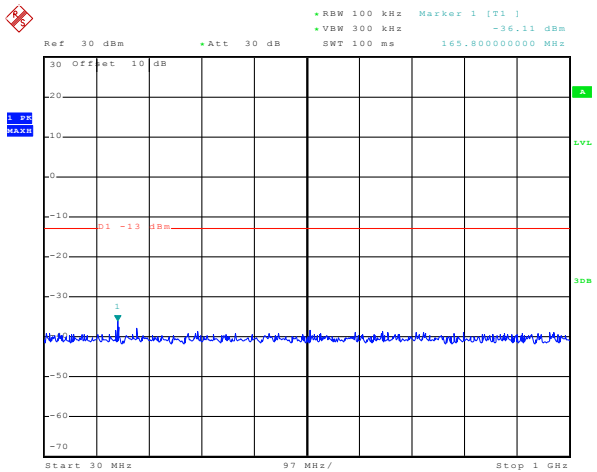

Date: 26.NOV.2015 22:10:23

30MHz~1GHz

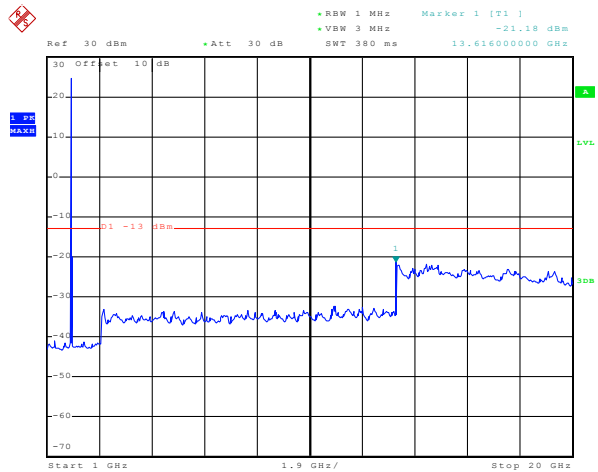

Date: 26.NOV.2015 22:13:46

1GHz~20GHz

Test Mode:	LTE band 2(5MHz QPSK) RB Size 12& RB Offset 0	Test Channel:	Lowest channel
------------	--	---------------	----------------

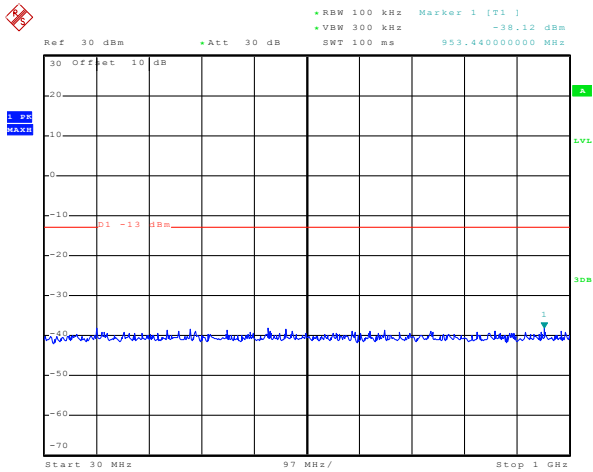

Date: 26.NOV.2015 21:59:49

30MHz~1GHz

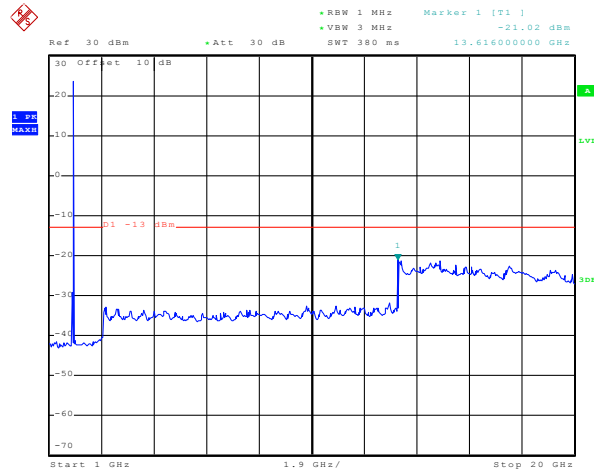

Date: 26.NOV.2015 22:03:32

1GHz~20GHz

Test Mode:	LTE band 2(5MHz QPSK) RB Size 12& RB Offset 0	Test Channel:	Middle channel
------------	--	---------------	----------------

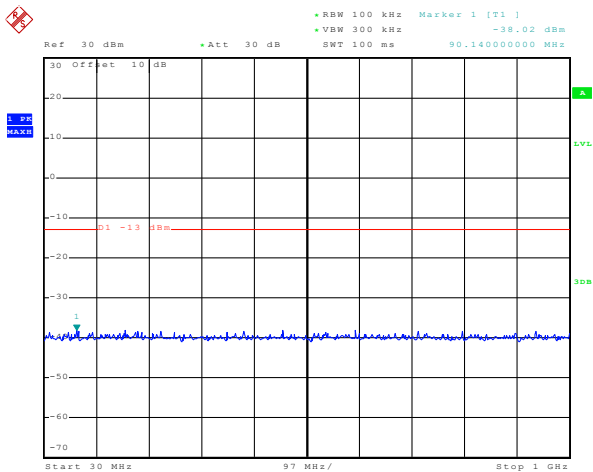

Date: 26.NOV.2015 22:09:51

30MHz~1GHz

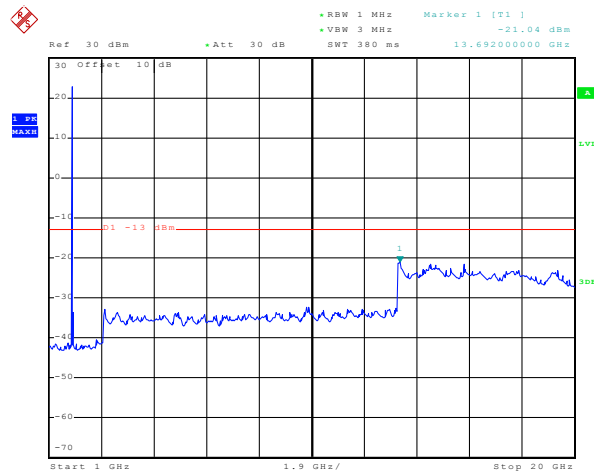

Date: 26.NOV.2015 22:05:51

1GHz~20GHz

Test Mode:	LTE band 2(5MHz QPSK) RB Size 12& RB Offset 0	Test Channel:	Highest channel
------------	--	---------------	-----------------

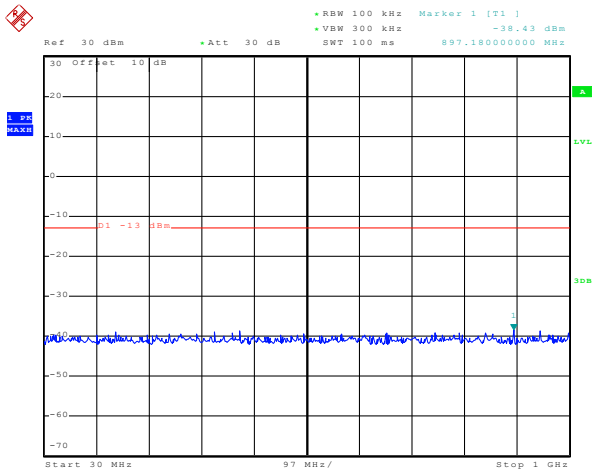

Date: 26.NOV.2015 22:11:11

30MHz~1GHz

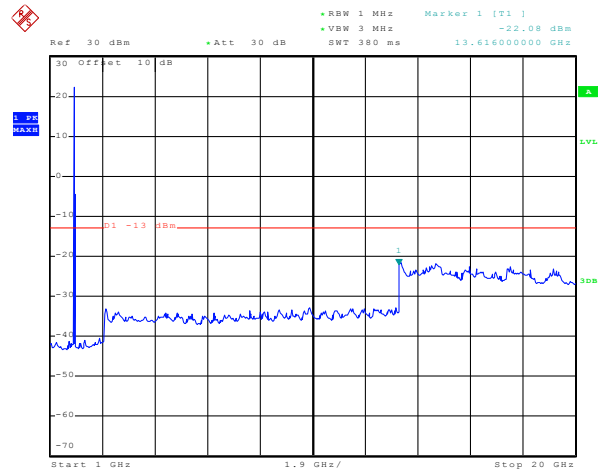

Date: 26.NOV.2015 22:15:08

1GHz~20GHz

Test Mode:	LTE band 2(5MHz QPSK) RB Size 25& RB Offset 0	Test Channel:	Lowest channel
------------	--	---------------	----------------

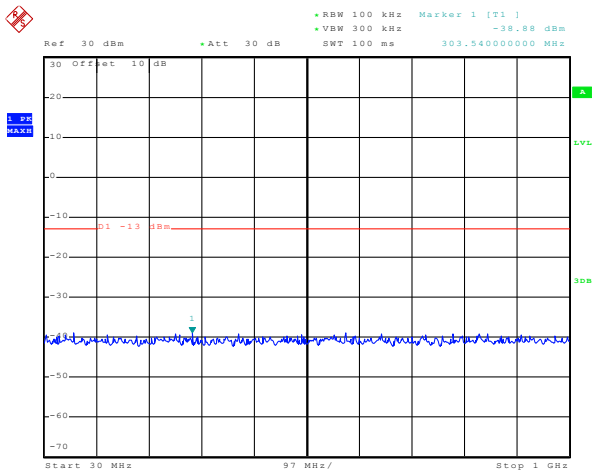

Date: 26.NOV.2015 22:00:03

30MHz~1GHz

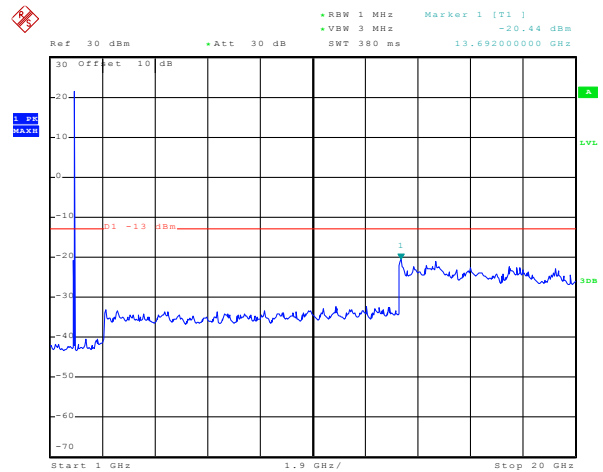

Date: 26.NOV.2015 22:01:25

1GHz~20GHz

Test Mode:	LTE band 2(5MHz QPSK) RB Size 25& RB Offset 0	Test Channel:	Middle channel
------------	--	---------------	----------------

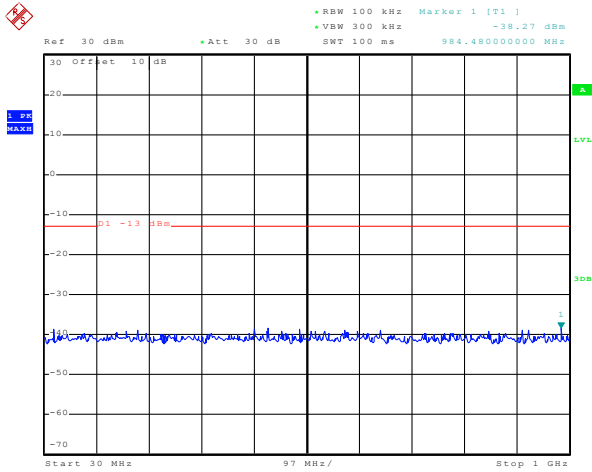

Date: 26.NOV.2015 22:07:38

30MHz~1GHz

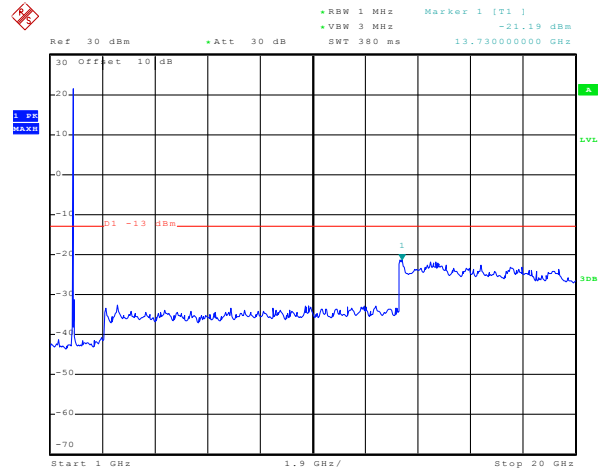

Date: 26.NOV.2015 22:06:18

1GHz~20GHz

Test Mode:	LTE band 2(5MHz QPSK) RB Size 25& RB Offset 0	Test Channel:	Highest channel
------------	--	---------------	-----------------

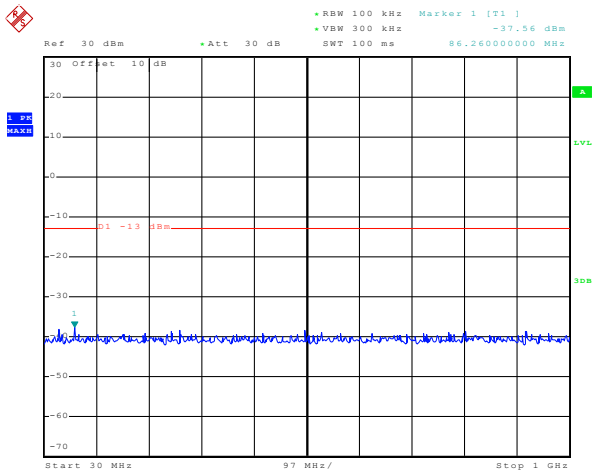

Date: 26.NOV.2015 22:11:30

30MHz~1GHz

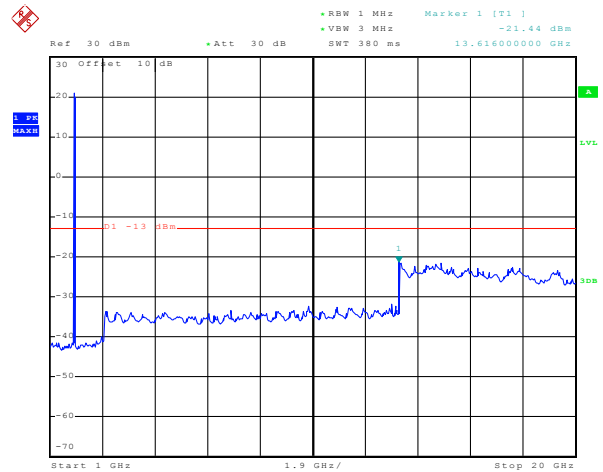

Date: 26.NOV.2015 22:13:20

1GHz~20GHz

10MHz

Test Mode:	LTE band 2(10MHz 16QAM) RB Size 1& RB Offset 0	Test Channel:	Lowest channel
------------	---	---------------	----------------

6

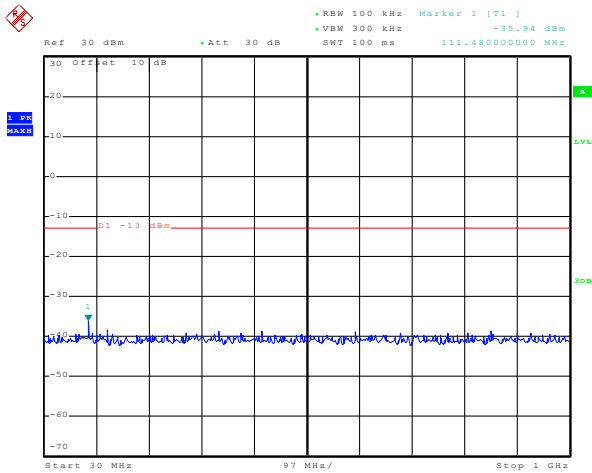

Date: 26.NOV.2015 22:22:15

30MHz~1GHz

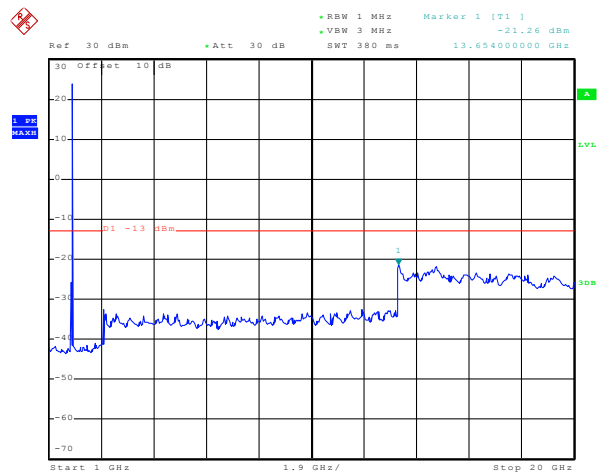

Date: 26.NOV.2015 22:18:20

1GHz~20GHz

Test Mode:	LTE band 2(10MHz 16QAM) RB Size 1& RB Offset 0	Test Channel:	Middle channel
------------	---	---------------	----------------

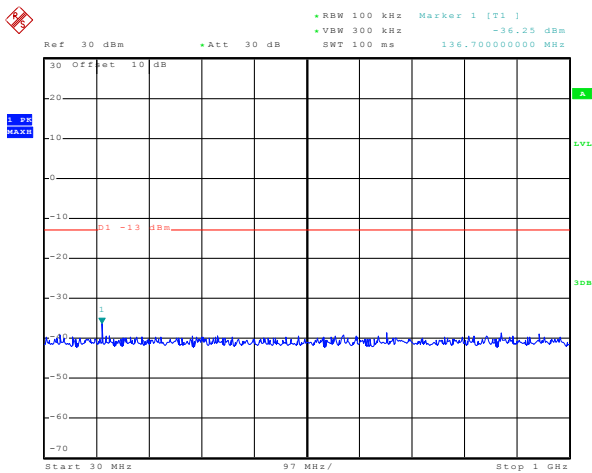

Date: 26.NOV.2015 22:23:55

30MHz~1GHz

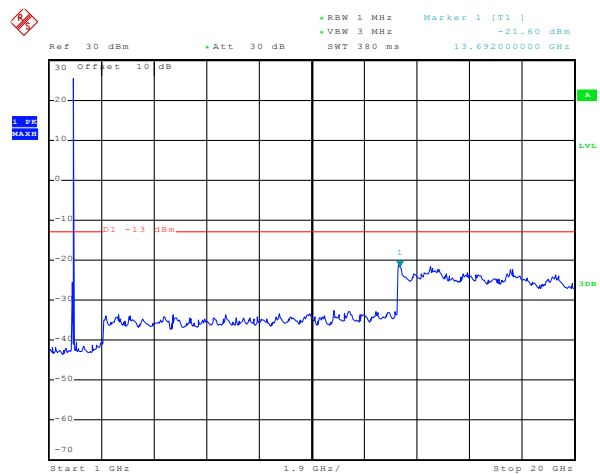

Date: 26.NOV.2015 22:26:56

1GHz~20GHz

Test Mode:	LTE band 2(10MHz 16QAM) RB Size 1& RB Offset 0	Test Channel:	Highest channel
------------	---	---------------	-----------------

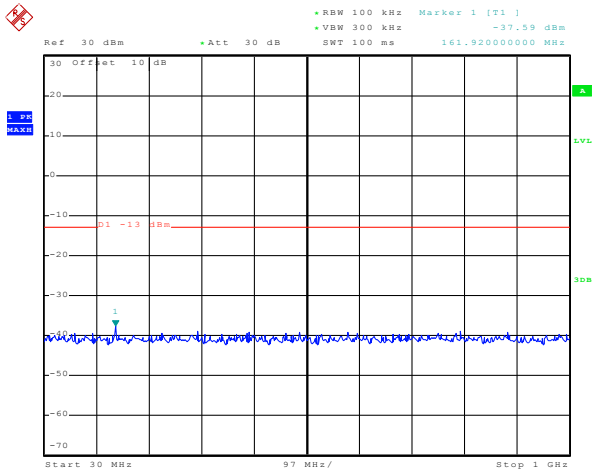

Date: 26.NOV.2015 22:32:52

30MHz~1GHz

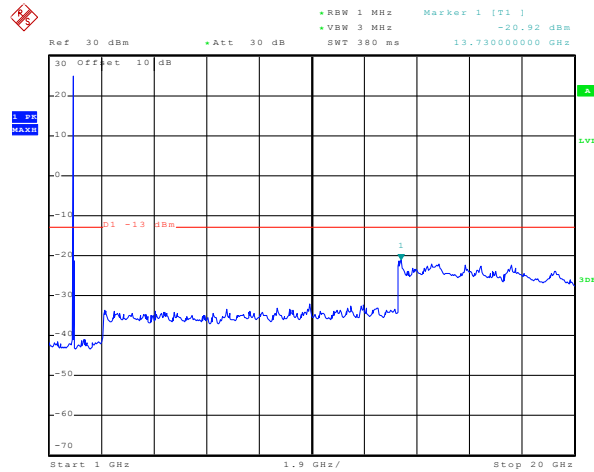

Date: 26.NOV.2015 22:29:38

1GHz~20GHz

Test Mode:	LTE band 2(10MHz 16QAM) RB Size 25& RB Offset 0	Test Channel:	Lowest channel
------------	--	---------------	----------------

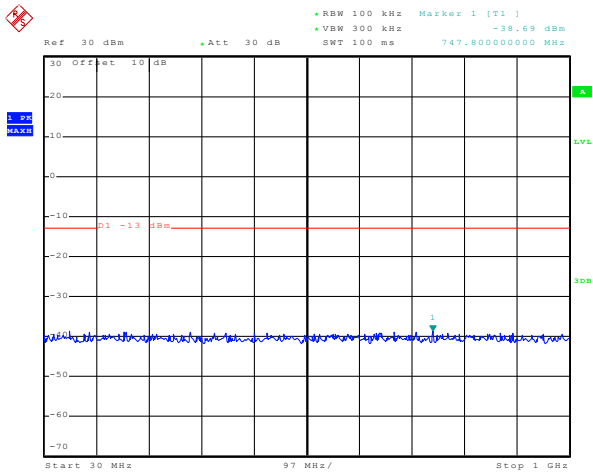

Date: 26.NOV.2015 22:22:44

30MHz~1GHz

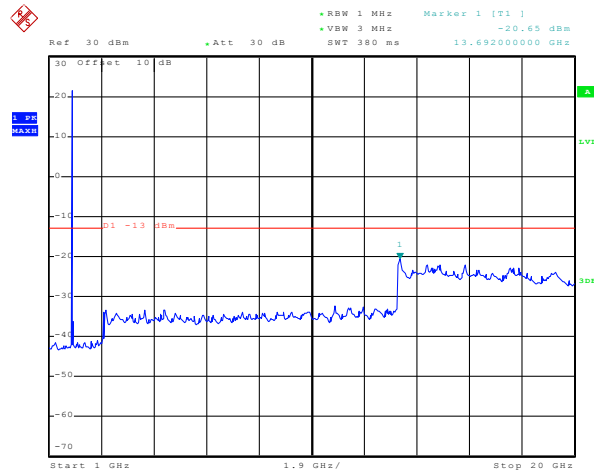

Date: 26.NOV.2015 22:18:50

1GHz~20GHz

Test Mode:	LTE band 2(10MHz 16QAM) RB Size 25& RB Offset 0	Test Channel:	Middle channel
------------	--	---------------	----------------

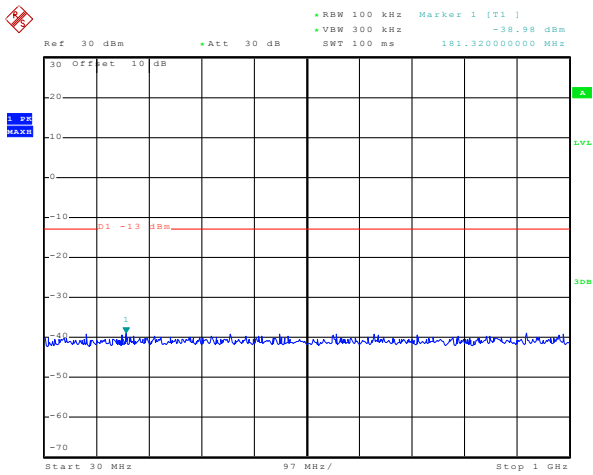

Date: 26.NOV.2015 22:24:14

30MHz~1GHz

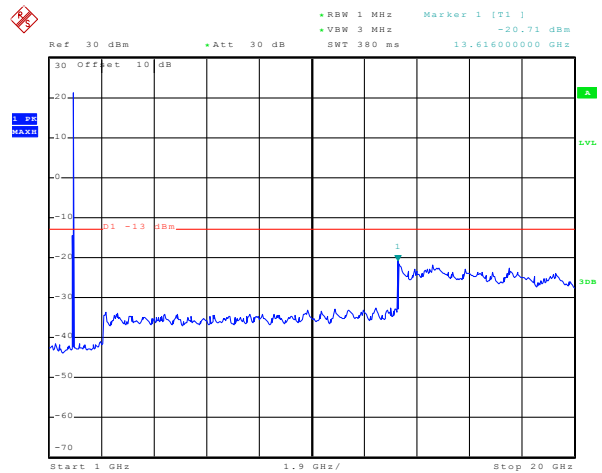

Date: 26.NOV.2015 22:27:25

1GHz~20GHz

Test Mode:	LTE band 2(10MHz 16QAM) RB Size 25& RB Offset 0	Test Channel:	Highest channel
------------	--	---------------	-----------------

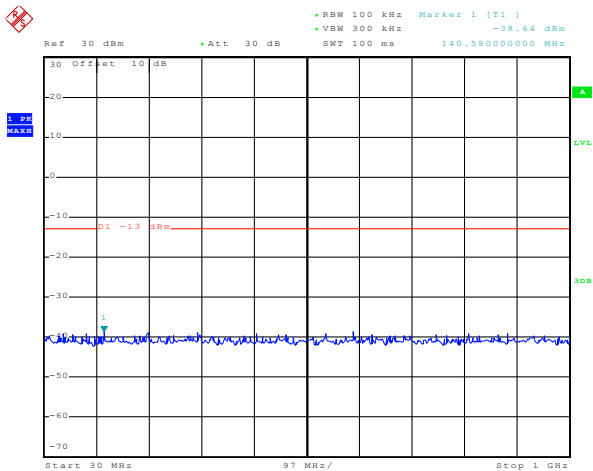

Date: 26.NOV.2015 22:33:10

30MHz~1GHz

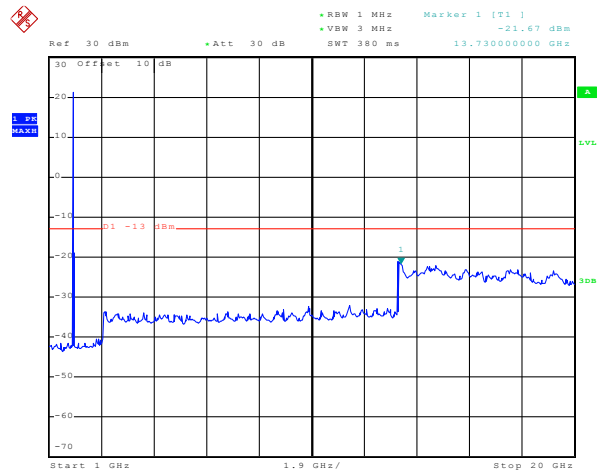

Date: 26.NOV.2015 22:30:14

1GHz~20GHz

Test Mode:	LTE band 2(10MHz 16QAM) RB Size 50& RB Offset 0	Test Channel:	Lowest channel
------------	--	---------------	----------------

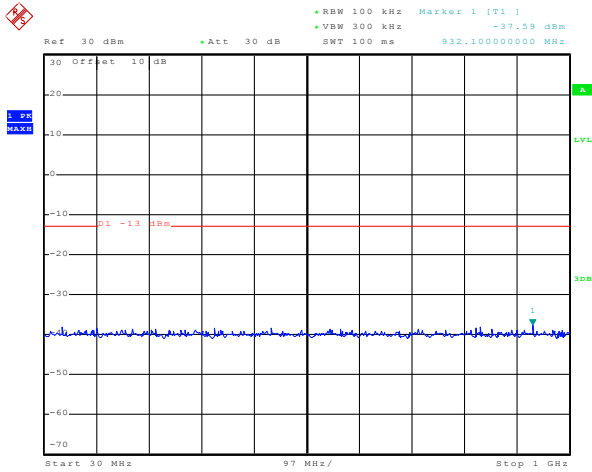

Date: 26.NOV.2015 22:21:20

30MHz~1GHz

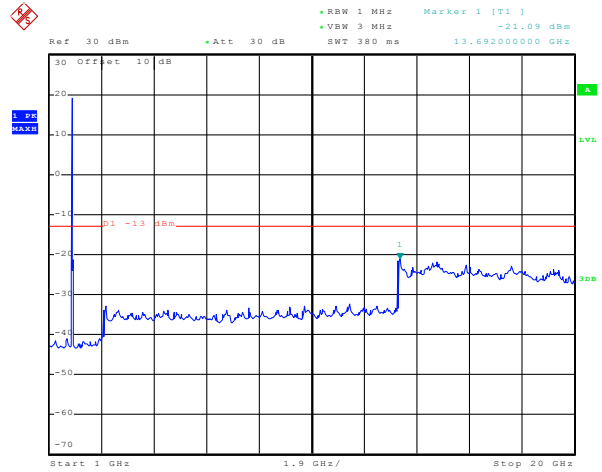

Date: 26.NOV.2015 22:20:00

1GHz~20GHz

Test Mode:	LTE band 2(10MHz 16QAM) RB Size 50& RB Offset 0	Test Channel:	Middle channel
------------	--	---------------	----------------

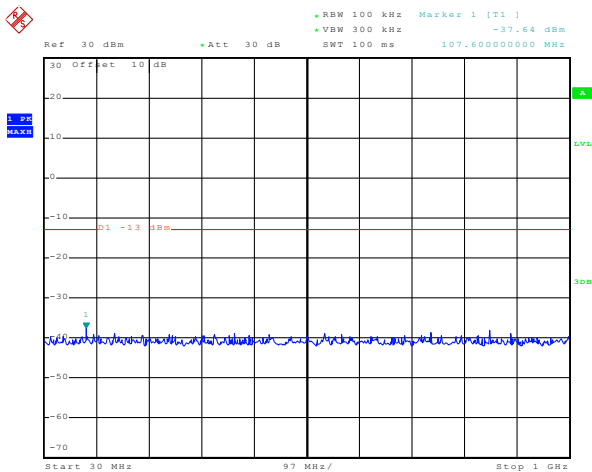

Date: 26.NOV.2015 22:25:00

30MHz~1GHz

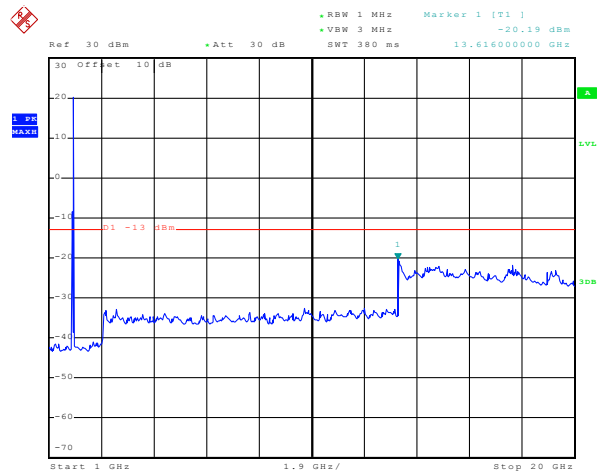

Date: 26.NOV.2015 22:25:39

1GHz~20GHz

Test Mode:	LTE band 2(10MHz 16QAM) RB Size 50& RB Offset 0	Test Channel:	Highest channel
------------	--	---------------	-----------------

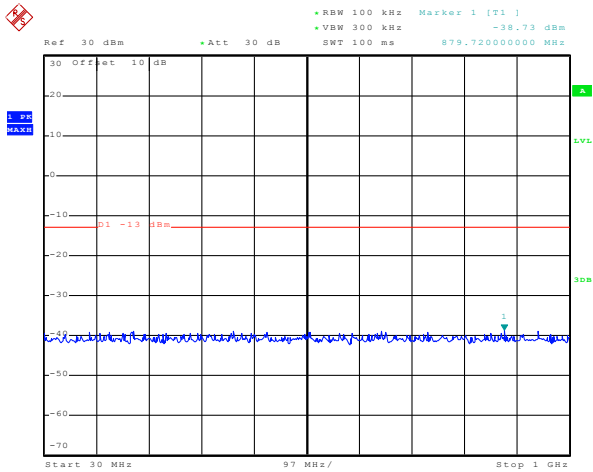

Date: 26.NOV.2015 22:31:59

30MHz~1GHz

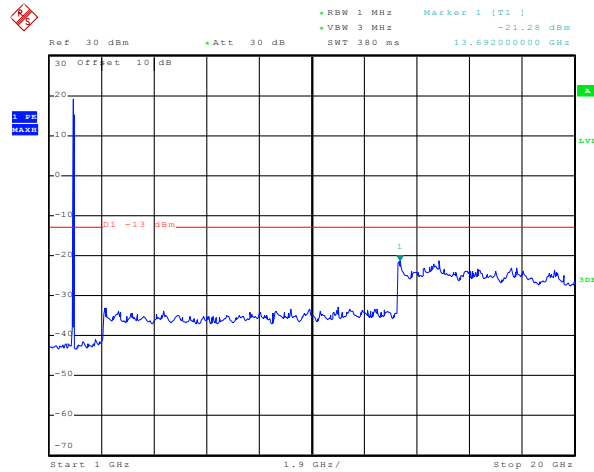

Date: 26.NOV.2015 22:31:29

1GHz~20GHz

Test Mode:	LTE band 2(10MHz QPSK) RB Size 1& RB Offset 0	Test Channel:	Lowest channel
------------	--	---------------	----------------

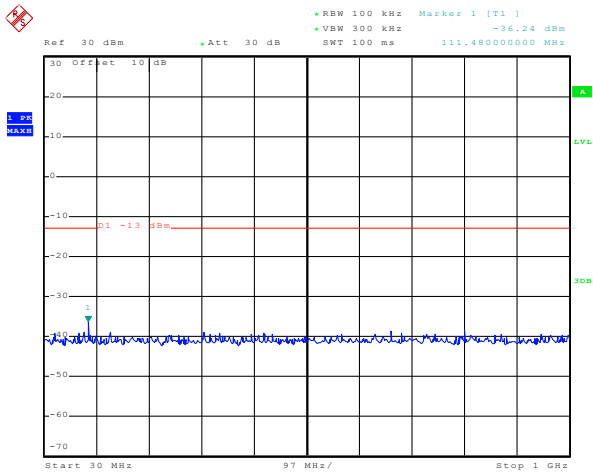

Date: 26.NOV.2015 22:21:58

30MHz~1GHz

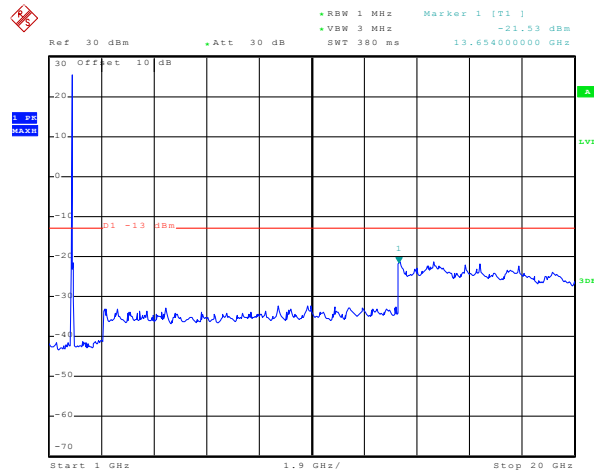

Date: 26.NOV.2015 22:18:02

1GHz~20GHz

Test Mode:	LTE band 2(10MHz QPSK) RB Size 1& RB Offset 0	Test Channel:	Middle channel
------------	--	---------------	----------------

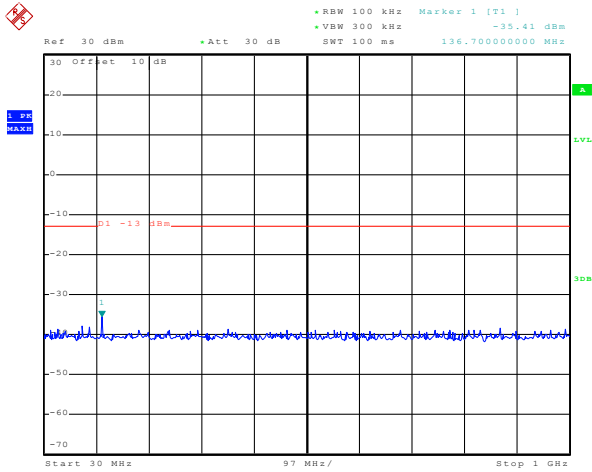

Date: 26.NOV.2015 22:23:38

30MHz~1GHz

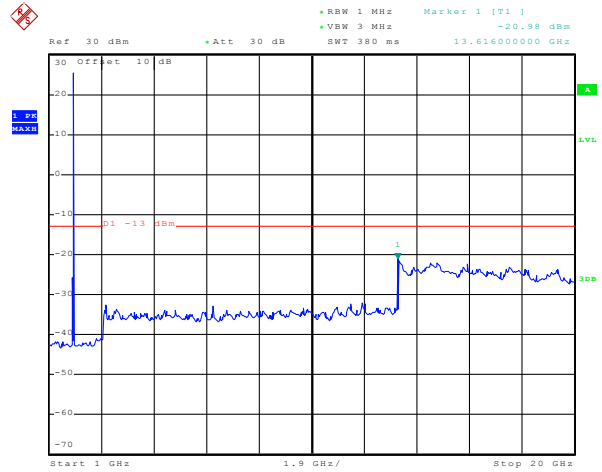

Date: 26.NOV.2015 22:26:26

1GHz~20GHz

Test Mode:	LTE band 2(10MHz QPSK) RB Size 1& RB Offset 0	Test Channel:	Highest channel
------------	--	---------------	-----------------

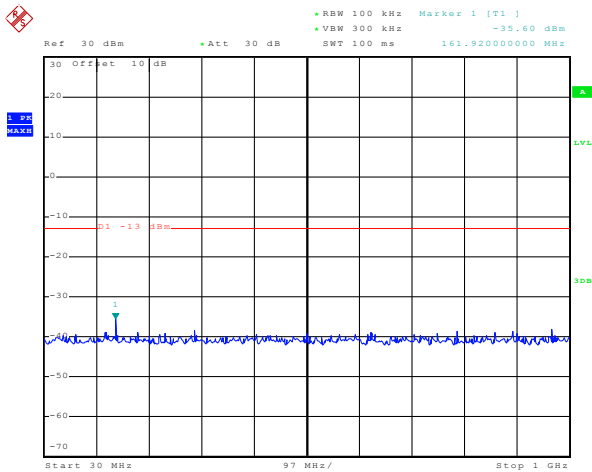

Date: 26.NOV.2015 22:32:35

30MHz~1GHz

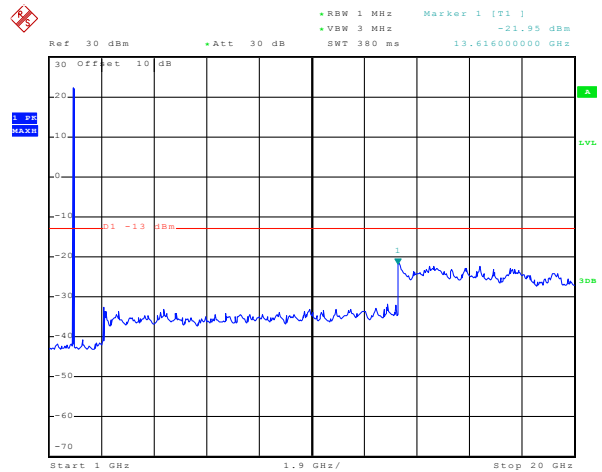

Date: 21.NOV.2015 22:21:49

1GHz~20GHz

Test Mode:	LTE band 2(10MHz QPSK) RB Size 25& RB Offset 0	Test Channel:	Lowest channel
------------	---	---------------	----------------

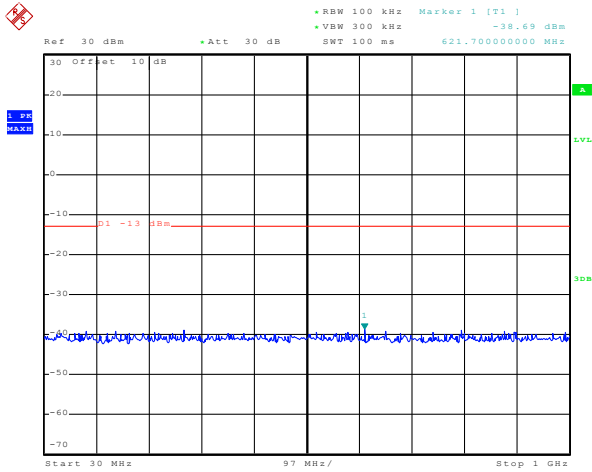

Date: 26.NOV.2015 22:23:00

30MHz~1GHz

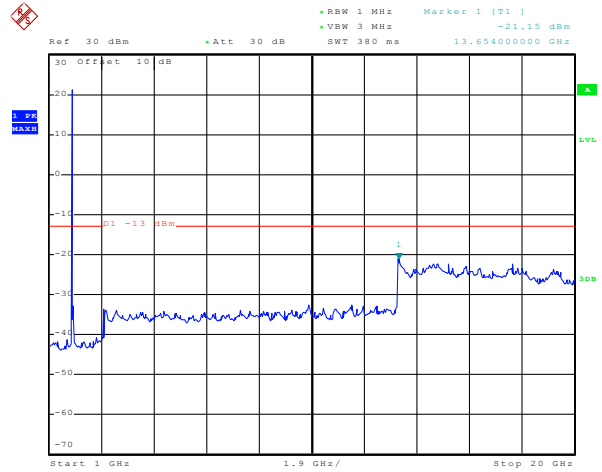

Date: 26.NOV.2015 22:19:13

1GHz~20GHz

Test Mode:	LTE band 2(10MHz QPSK) RB Size 25& RB Offset 0	Test Channel:	Middle channel
------------	---	---------------	----------------

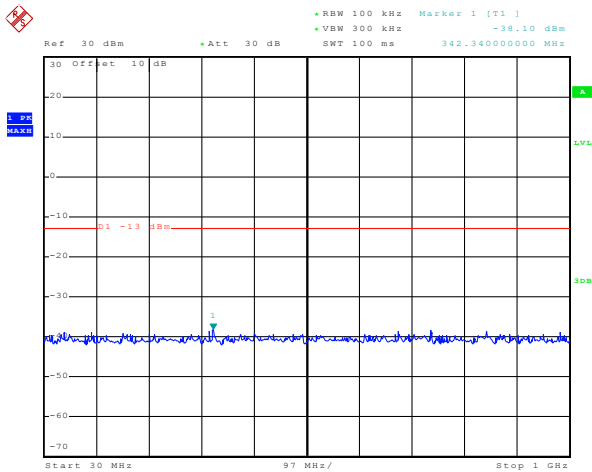

Date: 26.NOV.2015 22:24:35

30MHz~1GHz

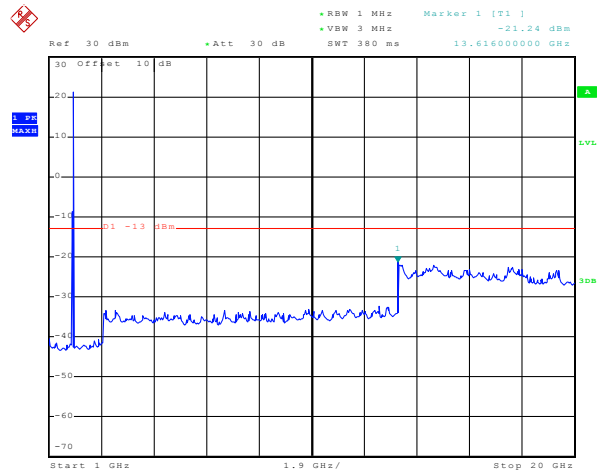

Date: 26.NOV.2015 22:27:51

1GHz~20GHz

Test Mode:	LTE band 2(10MHz QPSK) RB Size 25& RB Offset 0	Test Channel:	Highest channel
------------	---	---------------	-----------------

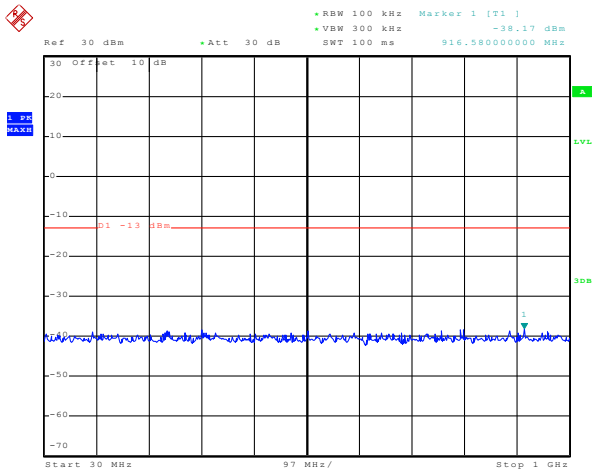

Date: 26.NOV.2015 22:33:35

30MHz~1GHz

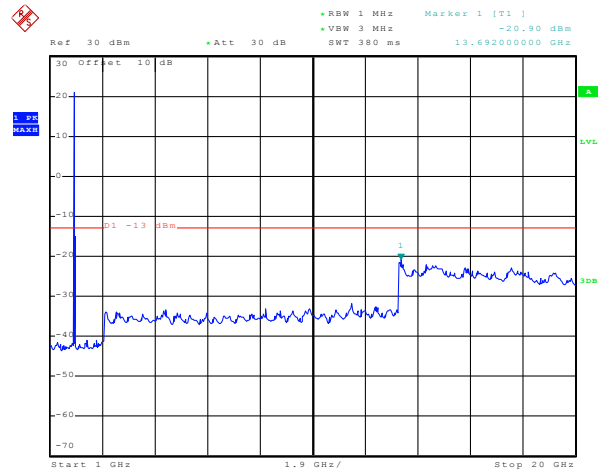

Date: 26.NOV.2015 22:30:39

1GHz~20GHz

Test Mode:	LTE band 2(10MHz QPSK) RB Size 50& RB Offset 0	Test Channel:	Lowest channel
------------	---	---------------	----------------

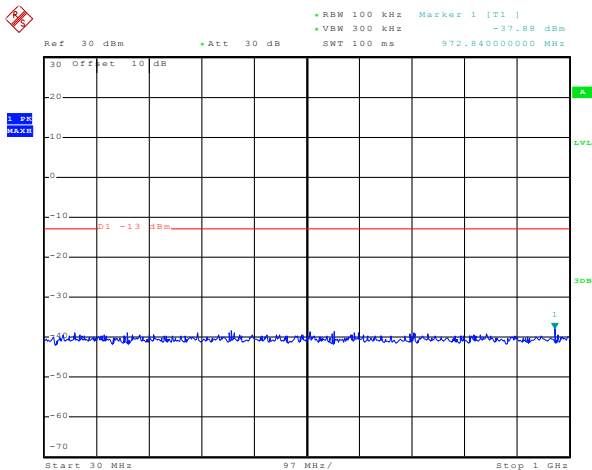

Date: 26.NOV.2015 22:21:43

30MHz~1GHz

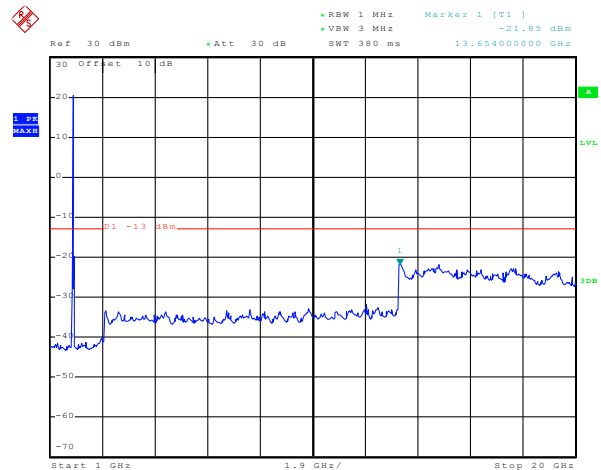

Date: 26.NOV.2015 22:19:37

1GHz~20GHz

Test Mode:	LTE band 2(10MHz QPSK) RB Size 50& RB Offset 0	Test Channel:	Middle channel
------------	---	---------------	----------------

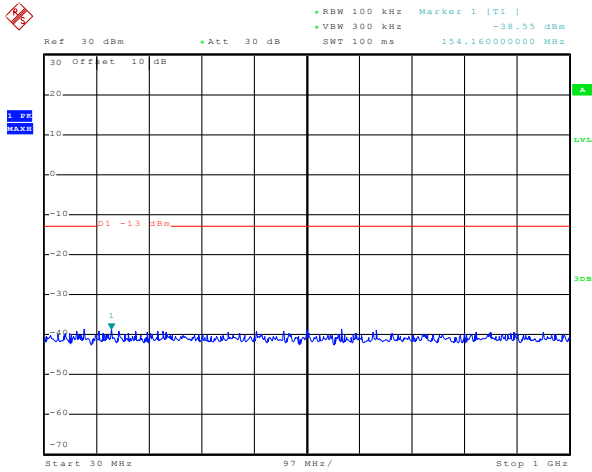

Date: 26.NOV.2015 22:24:48

30MHz~1GHz

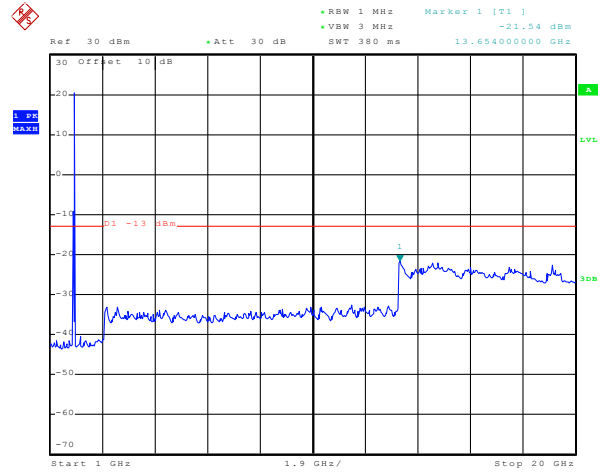

Date: 26.NOV.2015 22:25:58

1GHz~20GHz

Test Mode:	LTE band 2(10MHz QPSK) RB Size 50& RB Offset 0	Test Channel:	Highest channel
------------	---	---------------	-----------------

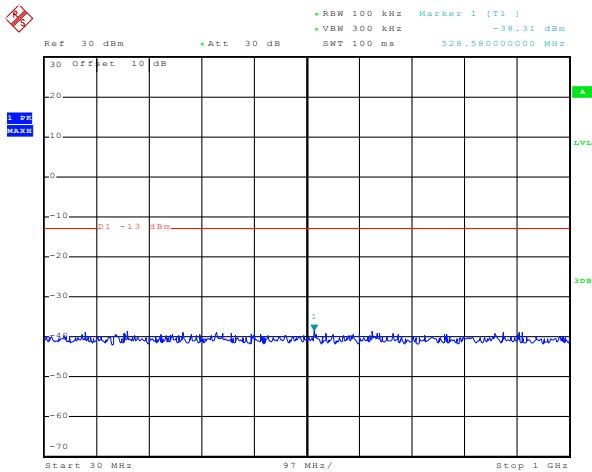

Date: 26.NOV.2015 22:32:18

30MHz~1GHz

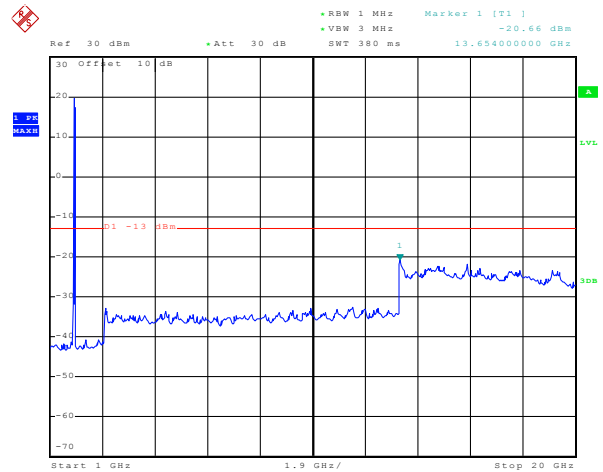

Date: 26.NOV.2015 22:31:10

1GHz~20GHz

15MHz

Test Mode:	LTE band 2(15MHz 16QAM) RB Size 1 & RB Offset 0	Test Channel:	Lowest channel
------------	--	---------------	----------------

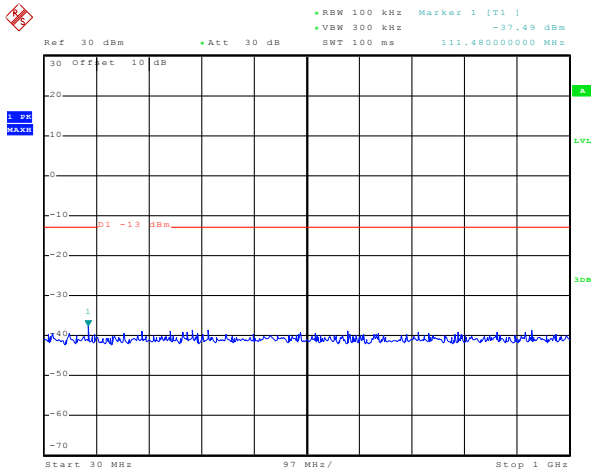

Date: 26.NOV.2015 22:34:45

30MHz~1GHz

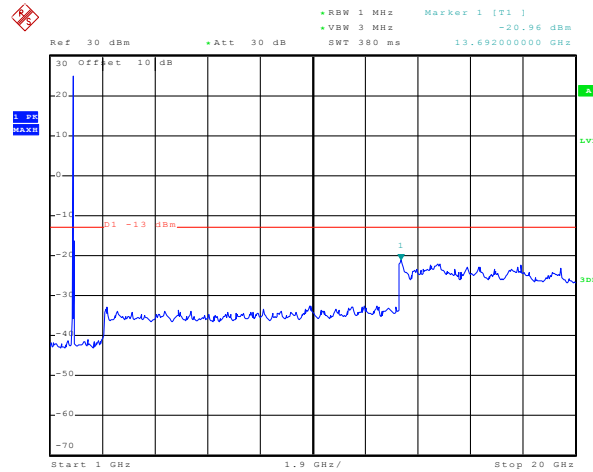

Date: 26.NOV.2015 22:38:58

1GHz~20GHz

Test Mode:	LTE band 2(15MHz 16QAM) RB Size 1 & RB Offset 0	Test Channel:	Middle channel
------------	--	---------------	----------------

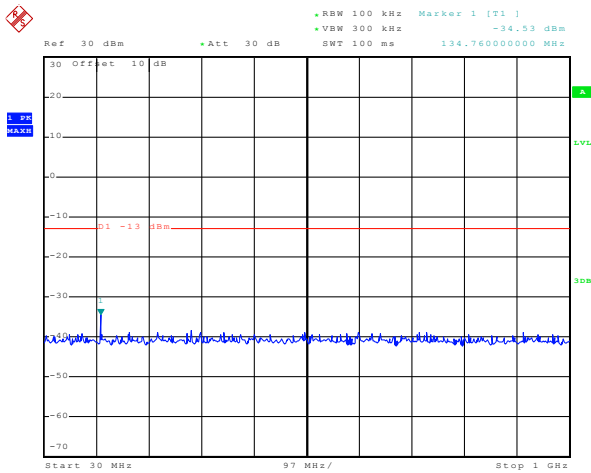

Date: 26.NOV.2015 22:46:03

30MHz~1GHz

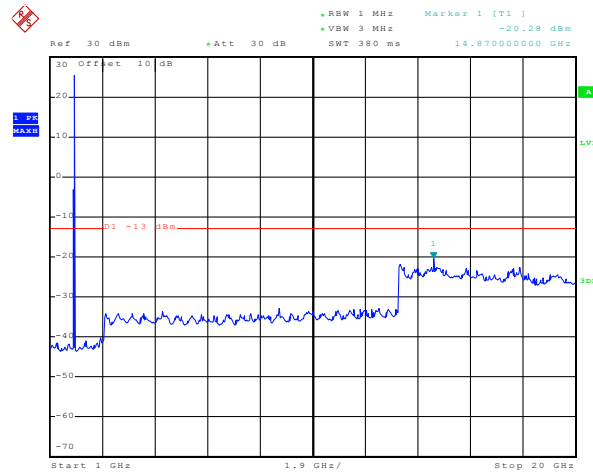

Date: 26.NOV.2015 22:42:15

1GHz~20GHz

Test Mode:	LTE band 2(15MHz 16QAM) RB Size 1& RB Offset 0	Test Channel:	Highest channel
------------	---	---------------	-----------------

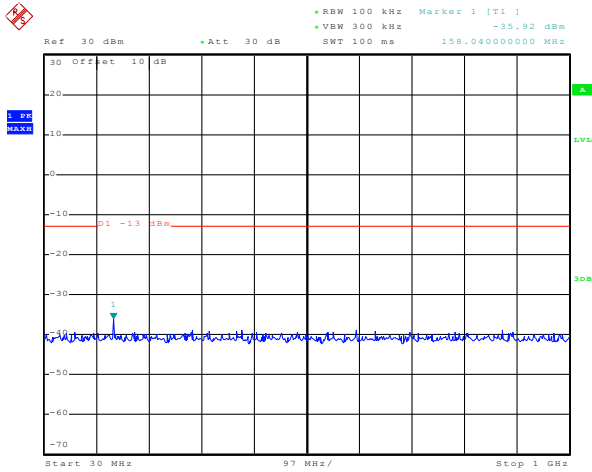

Date: 26.NOV.2015 22:53:48

30MHz~1GHz

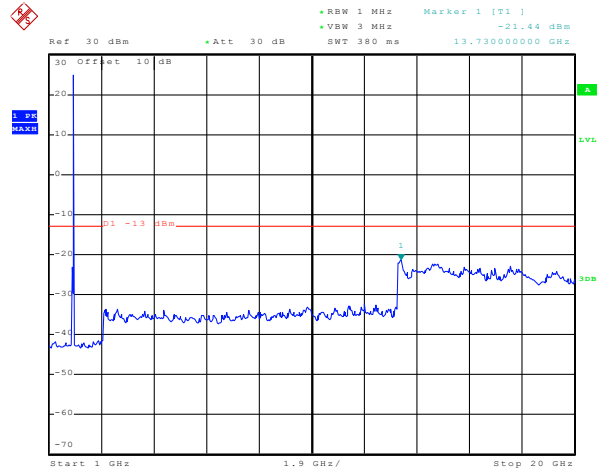

Date: 26.NOV.2015 22:56:58

1GHz~20GHz

Test Mode:	LTE band 2(15MHz 16QAM) RB Size 36& RB Offset 0	Test Channel:	Lowest channel
------------	--	---------------	----------------

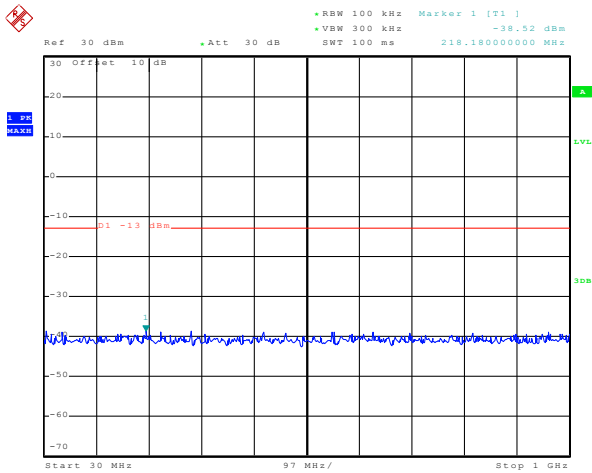

Date: 26.NOV.2015 22:35:04

30MHz~1GHz

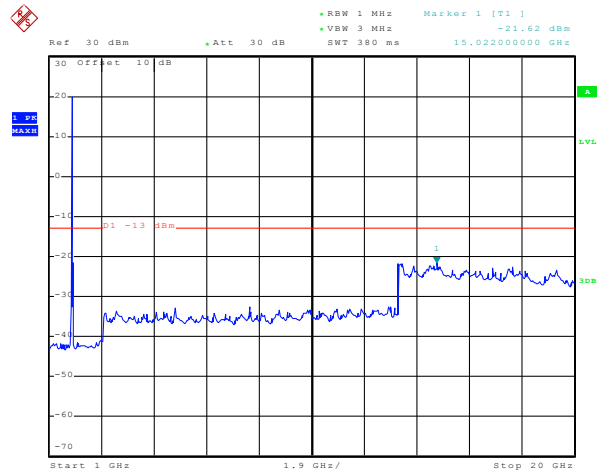

Date: 26.NOV.2015 22:39:23

1GHz~20GHz

Test Mode:	LTE band 2(15MHz 16QAM) RB Size 36& RB Offset 0	Test Channel:	Middle channel
------------	--	---------------	----------------

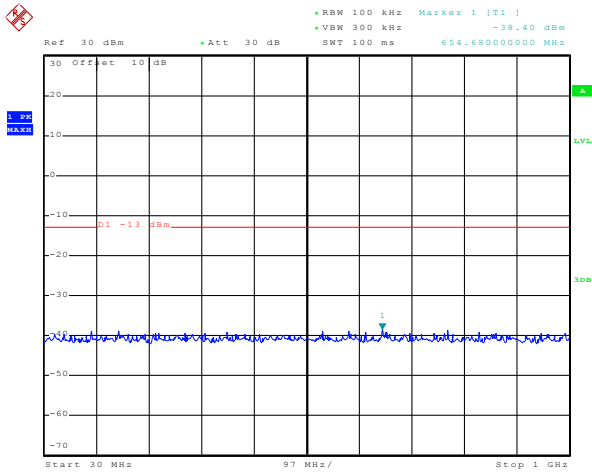

Date: 26.NOV.2015 22:46:24

30MHz~1GHz

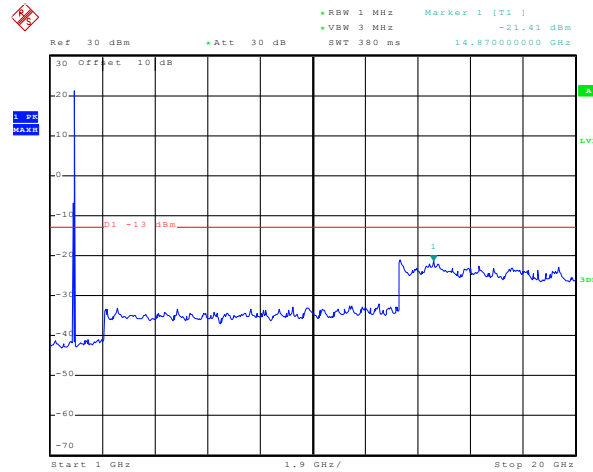

Date: 26.NOV.2015 22:43:24

1GHz~20GHz

Test Mode:	LTE band 2(15MHz 16QAM) RB Size 36& RB Offset 0	Test Channel:	Highest channel
------------	--	---------------	-----------------

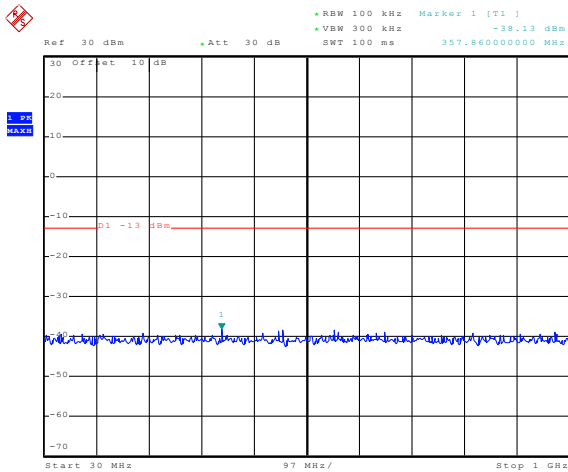

Date: 26.NOV.2015 22:54:04

30MHz~1GHz

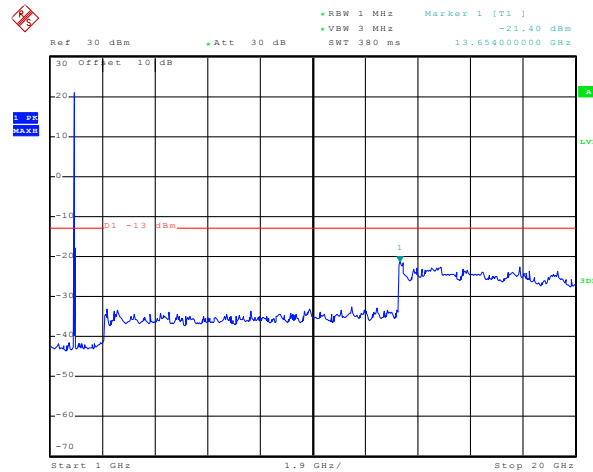

Date: 26.NOV.2015 22:57:17

1GHz~20GHz

Test Mode:	LTE band 2(15MHz 16QAM) RB Size 75& RB Offset 0	Test Channel:	Lowest channel
------------	--	---------------	----------------

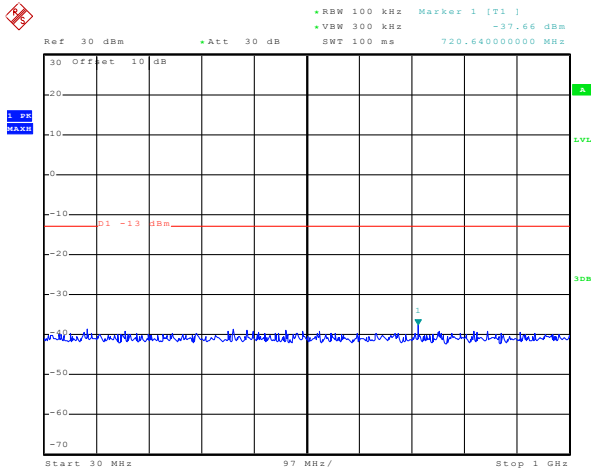

Date: 26.NOV.2015 22:36:02

30MHz~1GHz

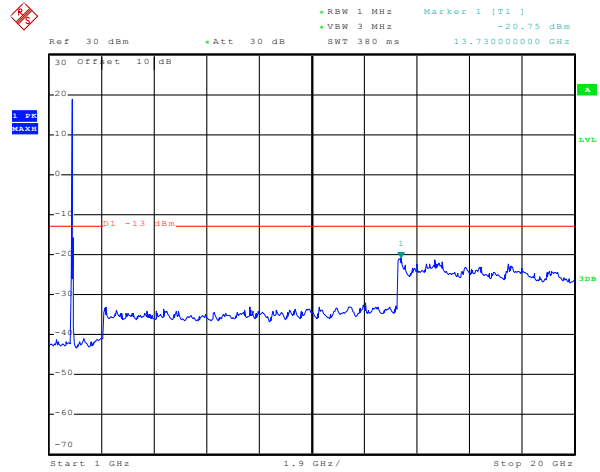

Date: 26.NOV.2015 22:37:07

1GHz~20GHz

Test Mode:	LTE band 2(15MHz 16QAM) RB Size 75& RB Offset 0	Test Channel:	Middle channel
------------	--	---------------	----------------

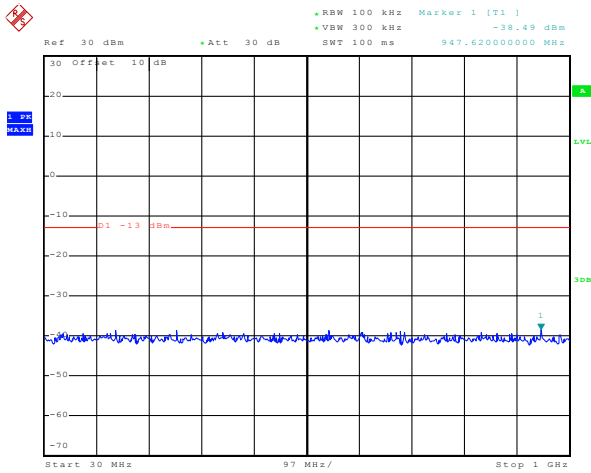

Date: 26.NOV.2015 22:45:15

30MHz~1GHz

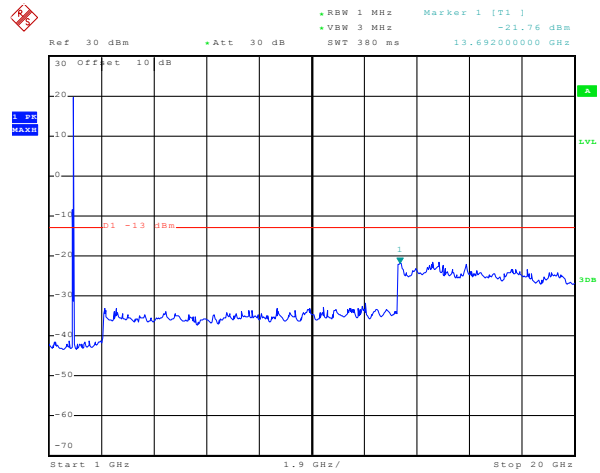

Date: 26.NOV.2015 22:44:44

1GHz~20GHz

Test Mode:	LTE band 2(15MHz 16QAM) RB Size 75& RB Offset 0	Test Channel:	Highest channel
------------	--	---------------	-----------------

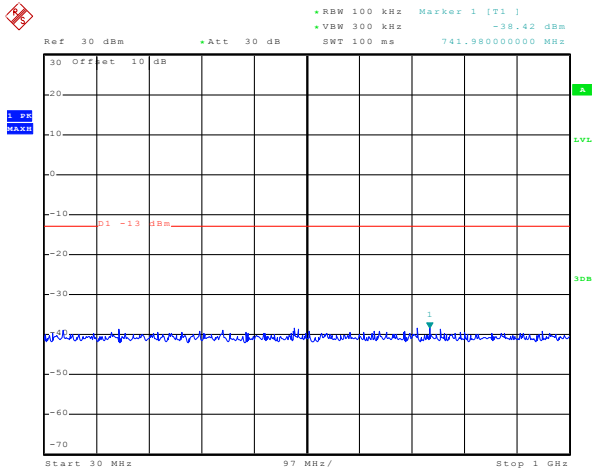

Date: 26.NOV.2015 22:54:55

30MHz~1GHz

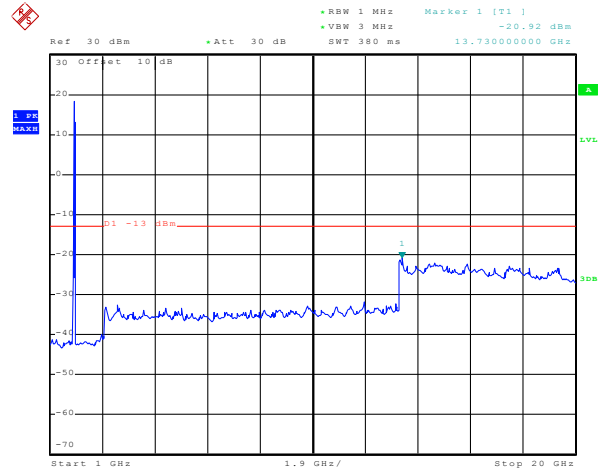

Date: 26.NOV.2015 22:55:51

1GHz~20GHz

Test Mode:	LTE band 2(15MHz QPSK) RB Size 1& RB Offset 0	Test Channel:	Lowest channel
------------	--	---------------	----------------

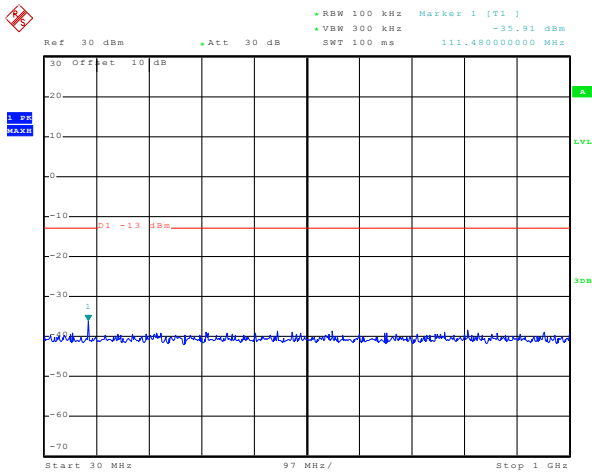

Date: 26.NOV.2015 22:34:27

30MHz~1GHz

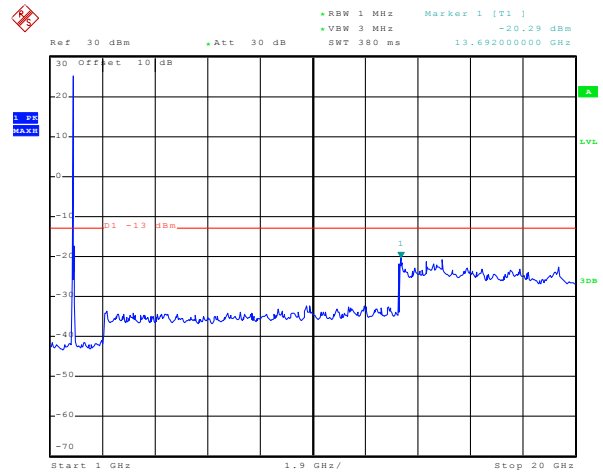

Date: 26.NOV.2015 22:38:18

1GHz~20GHz

Test Mode:	LTE band 2(15MHz QPSK) RB Size 1& RB Offset 0	Test Channel:	Middle channel
------------	--	---------------	----------------

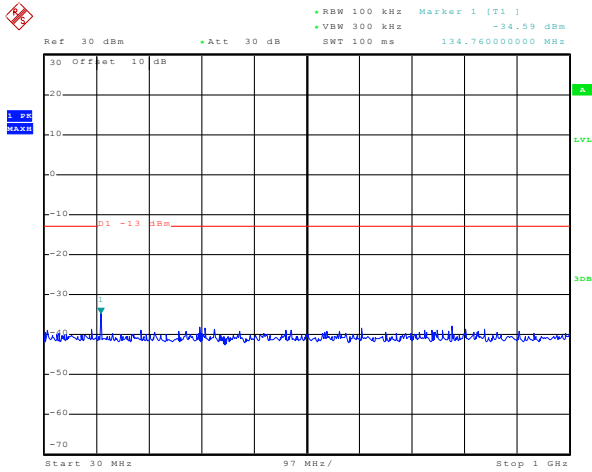

Date: 26.NOV.2015 22:45:46

30MHz~1GHz

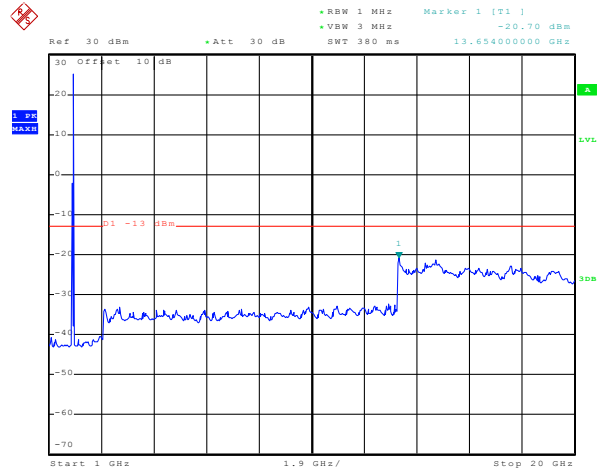

Date: 26.NOV.2015 22:41:51

1GHz~20GHz

Test Mode:	LTE band 2(15MHz QPSK) RB Size 1& RB Offset 0	Test Channel:	Highest channel
------------	--	---------------	-----------------

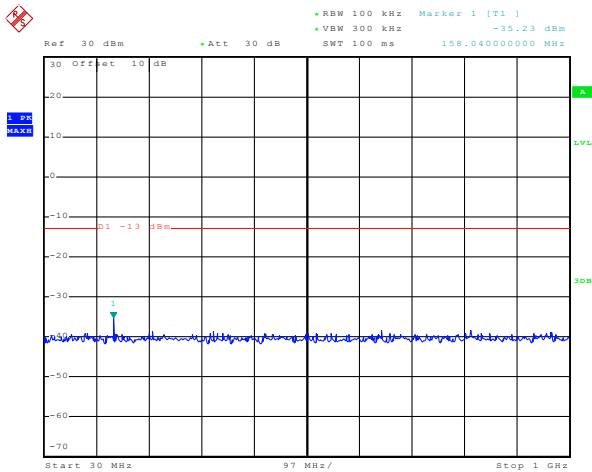

Date: 26.NOV.2015 22:53:32

30MHz~1GHz

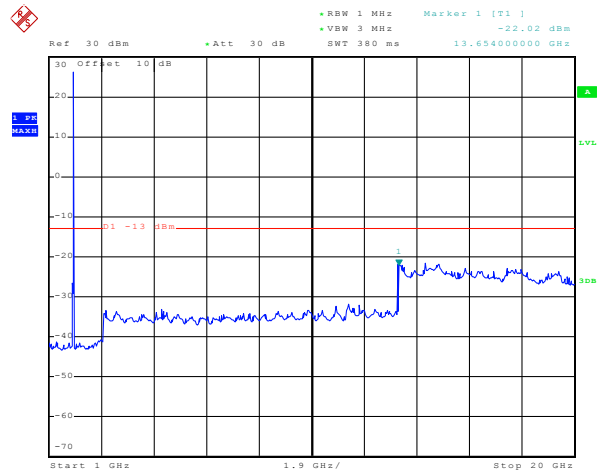

Date: 26.NOV.2015 22:56:39

1GHz~20GHz

Test Mode:	LTE band 2(15MHz QPSK) RB Size 36& RB Offset 0	Test Channel:	Lowest channel
------------	---	---------------	----------------

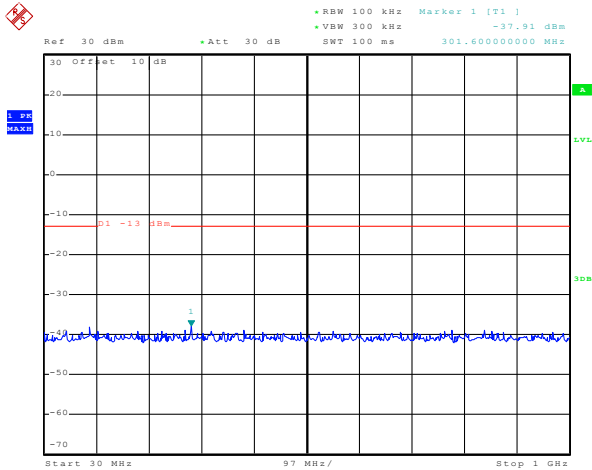

Date: 26.NOV.2015 22:35:24

30MHz~1GHz

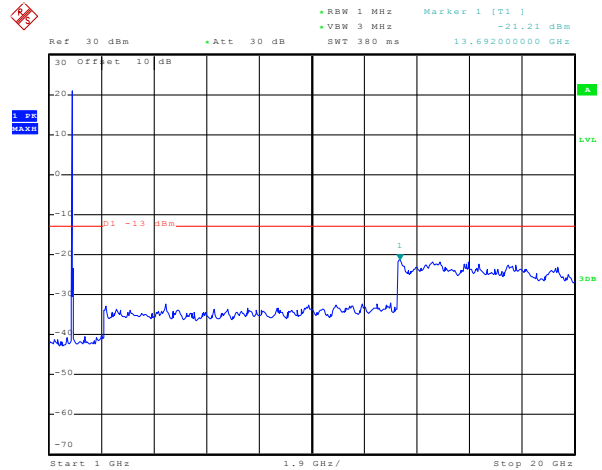

Date: 26.NOV.2015 22:40:49

1GHz~20GHz

Test Mode:	LTE band 2(15MHz QPSK) RB Size 36 & RB Offset 0	Test Channel:	Middle channel
------------	--	---------------	----------------

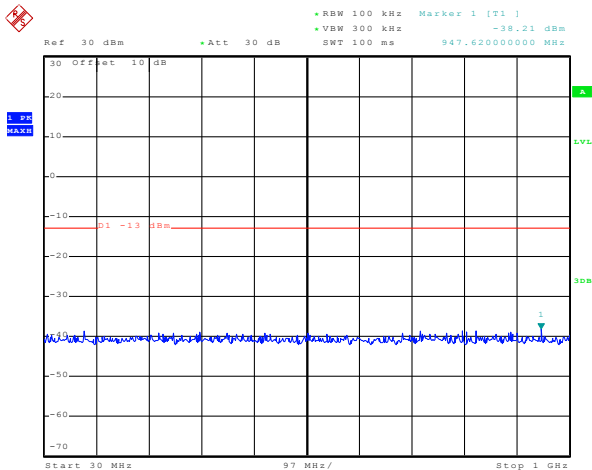

Date: 26.NOV.2015 22:46:44

30MHz~1GHz

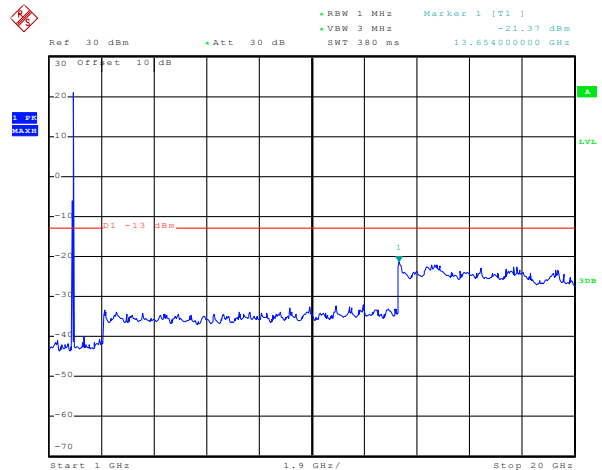

Date: 26.NOV.2015 22:43:53

1GHz~20GHz

Test Mode:	LTE band 2(15MHz QPSK) RB Size 36& RB Offset 0	Test Channel:	Highest channel
------------	---	---------------	-----------------

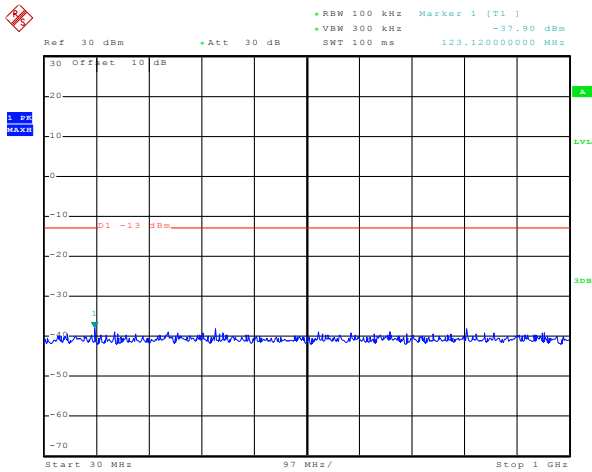

Date: 26.NOV.2015 22:54:24

30MHz~1GHz

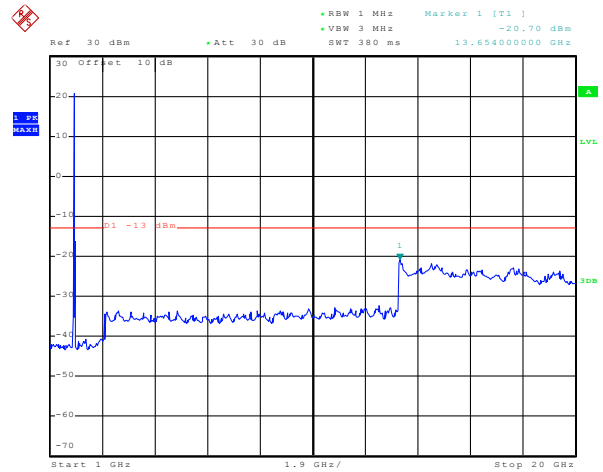

Date: 26.NOV.2015 22:57:51

1GHz~20GHz

Test Mode:	LTE band 2(15MHz QPSK) RB Size 75& RB Offset 0	Test Channel:	Lowest channel
------------	---	---------------	----------------

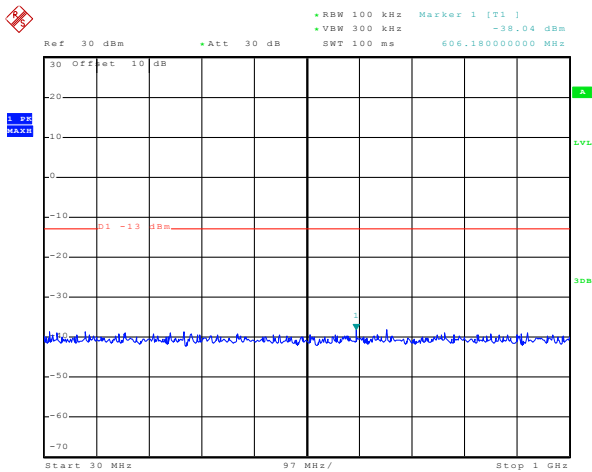

Date: 26.NOV.2015 22:35:45

30MHz~1GHz

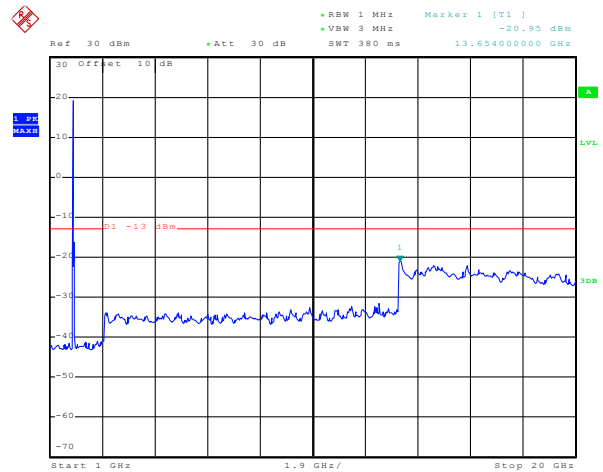

Date: 26.NOV.2015 22:37:45

1GHz~20GHz

Test Mode:	LTE band 2(15MHz QPSK) RB Size 75& RB Offset 0	Test Channel:	Middle channel
------------	---	---------------	----------------

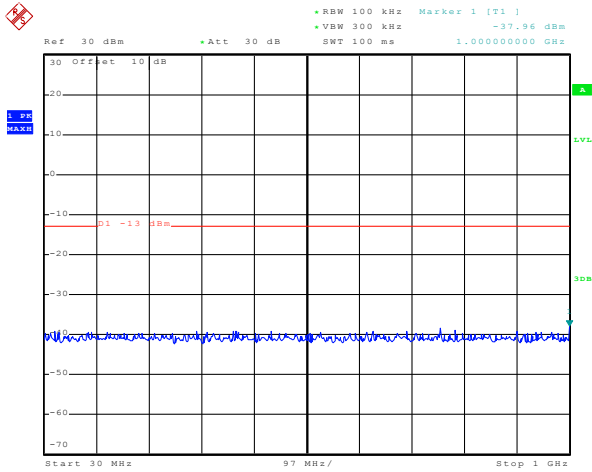

Date: 26.NOV.2015 22:45:30

30MHz~1GHz

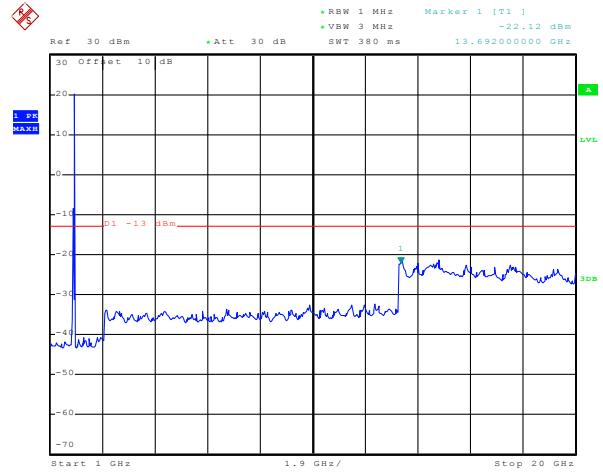

Date: 26.NOV.2015 22:44:20

1GHz~20GHz

Test Mode:	LTE band 2(15MHz QPSK) RB Size 75& RB Offset 0	Test Channel:	Highest channel
------------	---	---------------	-----------------

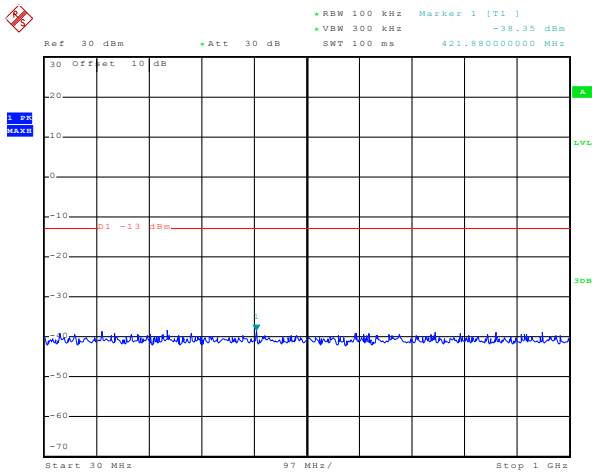

Date: 26.NOV.2015 22:54:39

30MHz~1GHz

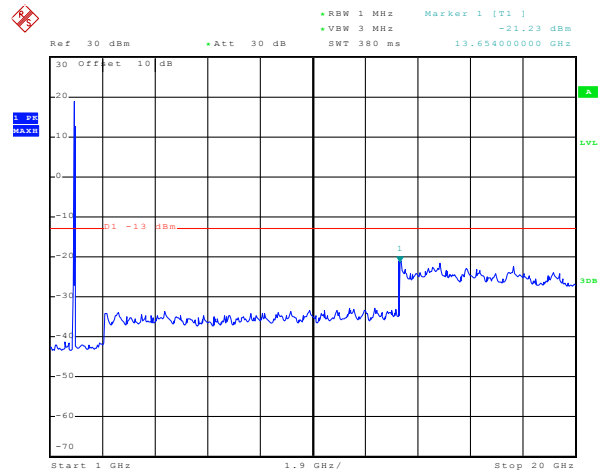

Date: 26.NOV.2015 22:56:09

1GHz~20GHz

20MHz

Test Mode:	LTE band 2(20MHz 16QAM) RB Size 1 & RB Offset 0	Test Channel:	Lowest channel
------------	--	---------------	----------------

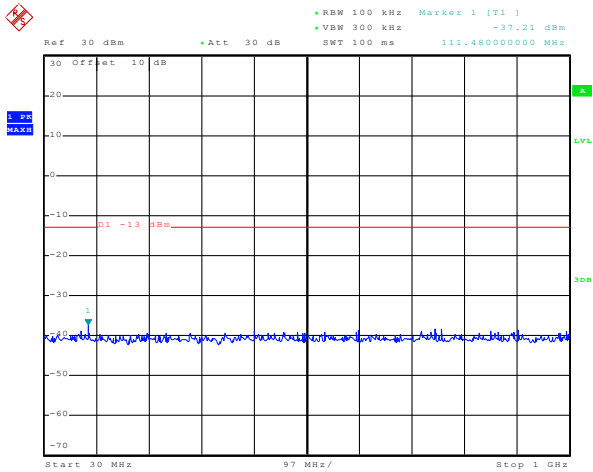

Date: 26.NOV.2015 23:02:57

30MHz~1GHz

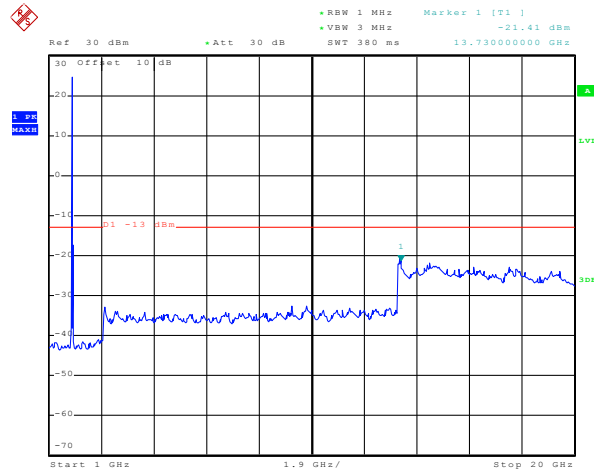

Date: 26.NOV.2015 22:59:11

1GHz~20GHz

Test Mode:	LTE band 2(20MHz 16QAM) RB Size 1 & RB Offset 0	Test Channel:	Middle channel
------------	--	---------------	----------------

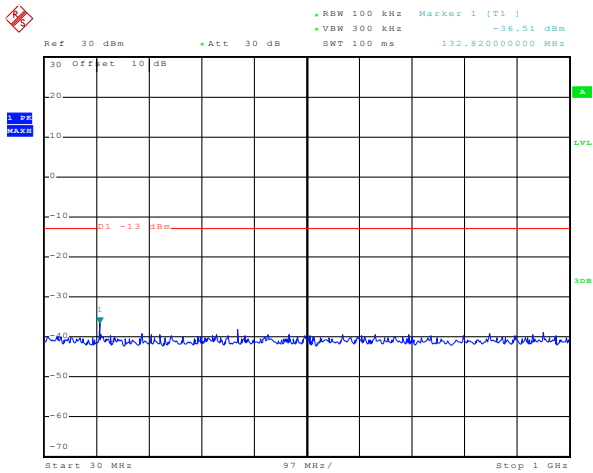

Date: 26.NOV.2015 23:05:00

30MHz~1GHz

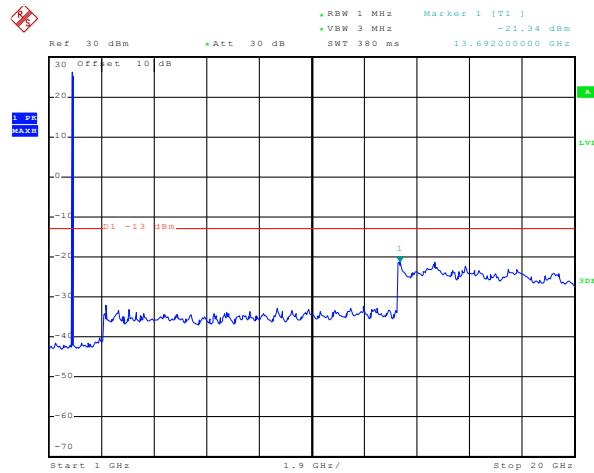

Date: 26.NOV.2015 23:08:10

1GHz~20GHz

Test Mode:	LTE band 2(20MHz 16QAM) RB Size 1 & RB Offset 0	Test Channel:	Highest channel
------------	--	---------------	-----------------

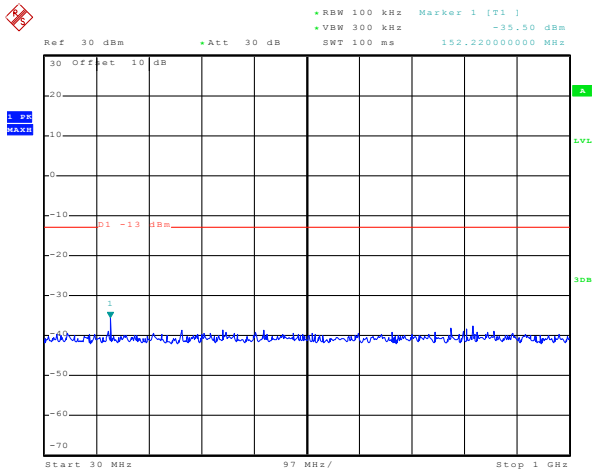

Date: 26.NOV.2015 23:15:27

30MHz~1GHz

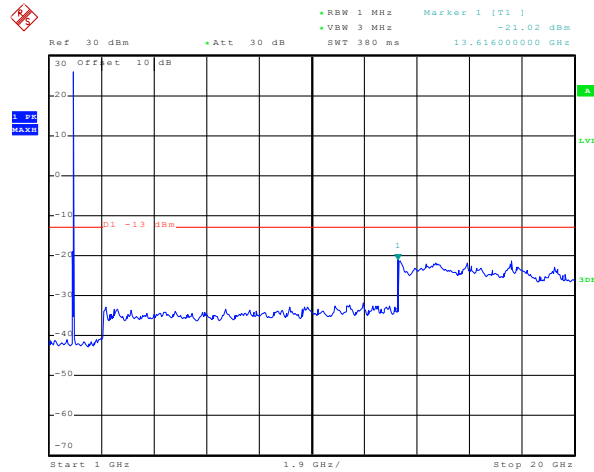

Date: 26.NOV.2015 23:11:37

1GHz~20GHz

Test Mode:	LTE band 2(20MHz 16QAM) RB Size 50& RB Offset 0	Test Channel:	Lowest channel
------------	--	---------------	----------------

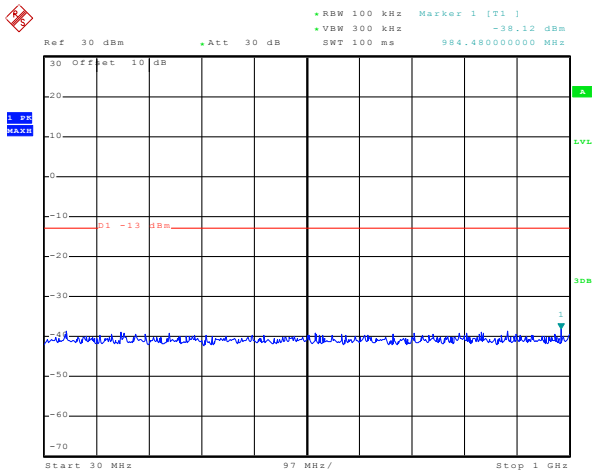

Date: 26.NOV.2015 23:03:24

30MHz~1GHz

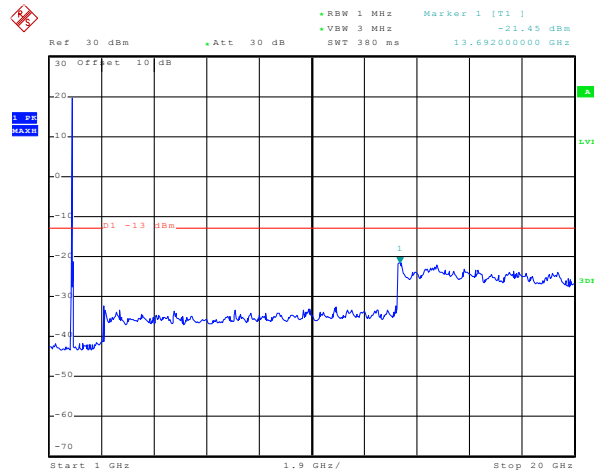

Date: 26.NOV.2015 22:59:36

1GHz~20GHz

Test Mode:	LTE band 2(20MHz 16QAM) RB Size 50& RB Offset 0	Test Channel:	Middle channel
------------	--	---------------	----------------

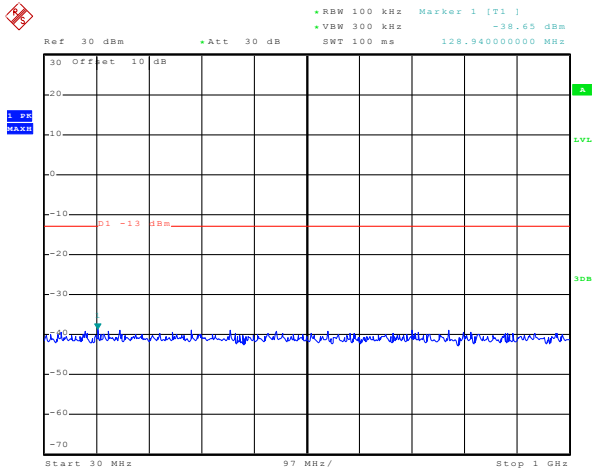

Date: 26.NOV.2015 23:05:16

30MHz~1GHz

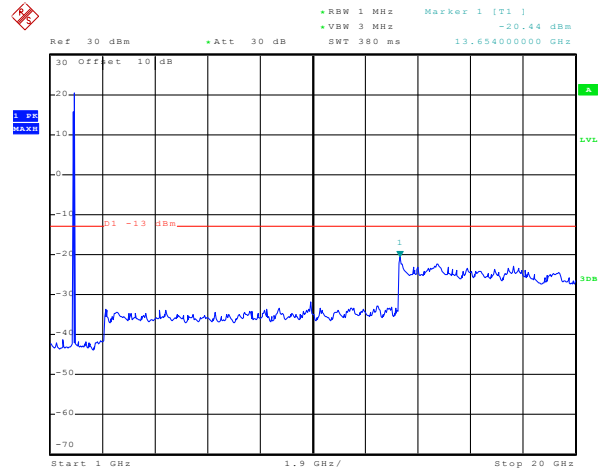

Date: 26.NOV.2015 23:08:35

1GHz~20GHz

Test Mode:	LTE band 2(20MHz 16QAM) RB Size 50& RB Offset 0	Test Channel:	Highest channel
------------	--	---------------	-----------------

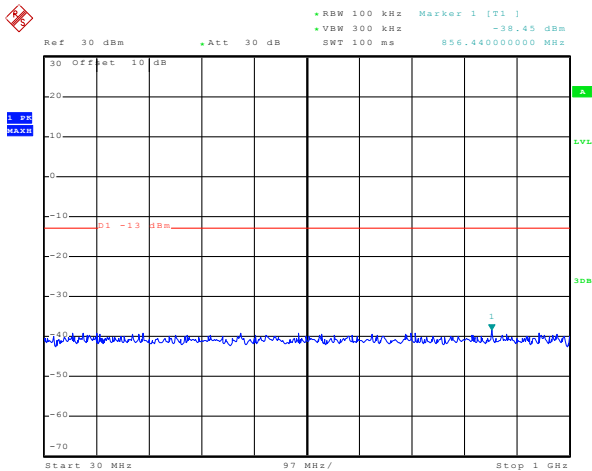

Date: 26.NOV.2015 23:15:56

30MHz~1GHz

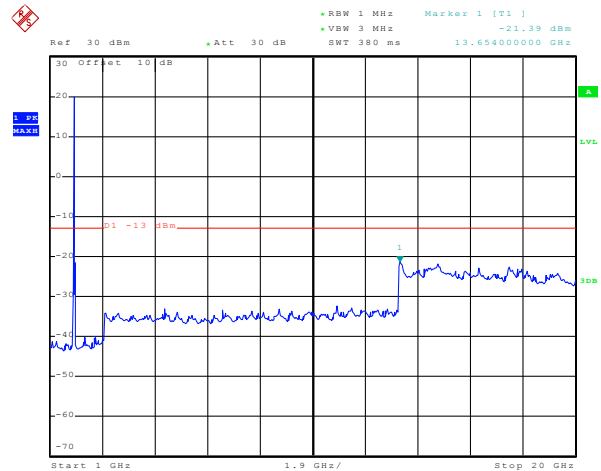

Date: 26.NOV.2015 23:12:21

1GHz~20GHz

Test Mode:	LTE band 2(20MHz 16QAM) RB Size 100& RB Offset 0	Test Channel:	Lowest channel
------------	---	---------------	----------------

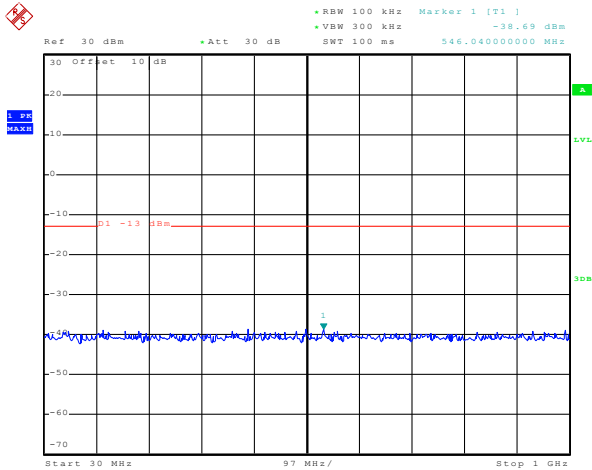

Date: 26.NOV.2015 23:02:10

30MHz~1GHz

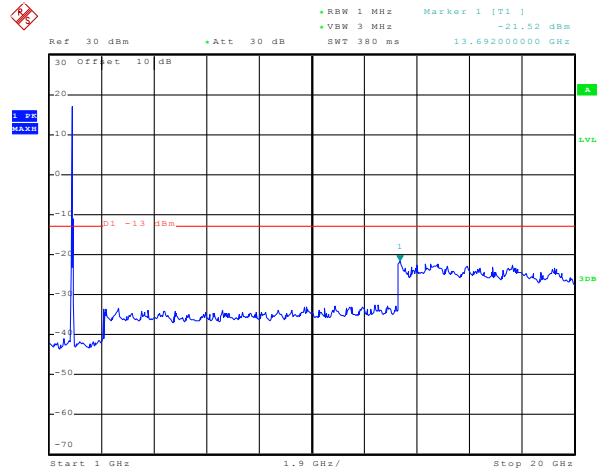

Date: 26.NOV.2015 23:01:40

1GHz~20GHz

Test Mode:	LTE band 2(20MHz 16QAM) RB Size 100& RB Offset 0	Test Channel:	Middle channel
------------	---	---------------	----------------

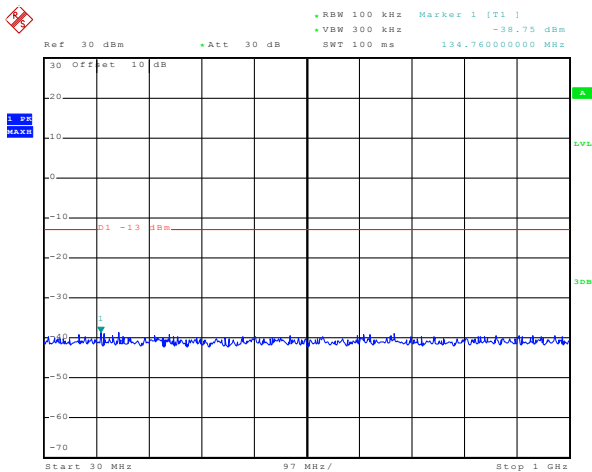

Date: 26.NOV.2015 23:05:56

30MHz~1GHz

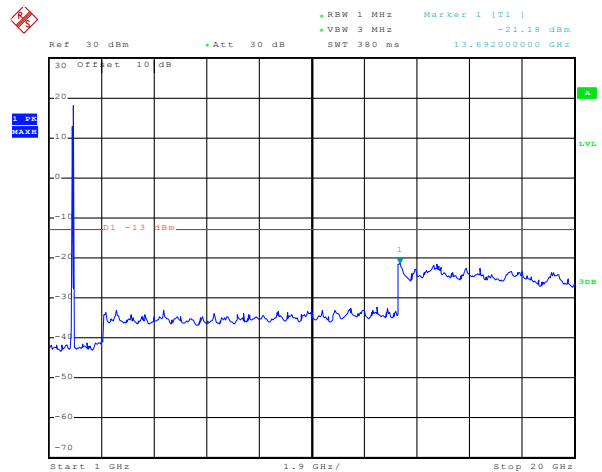

Date: 26.NOV.2015 23:06:45

1GHz~20GHz

Test Mode:	LTE band 2(20MHz 16QAM) RB Size 100& RB Offset 0	Test Channel:	Highest channel
------------	---	---------------	-----------------

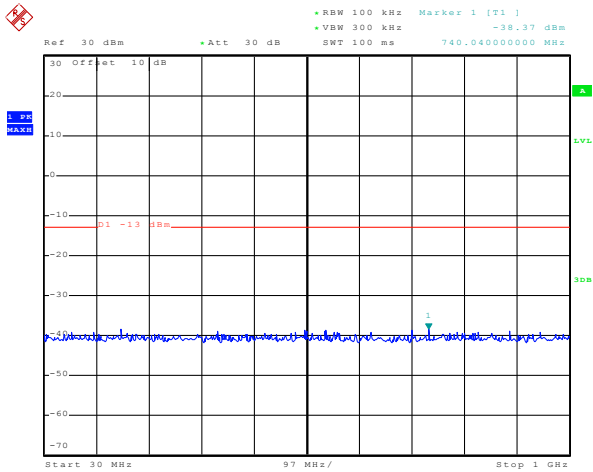

Date: 26.NOV.2015 23:14:36

30MHz~1GHz

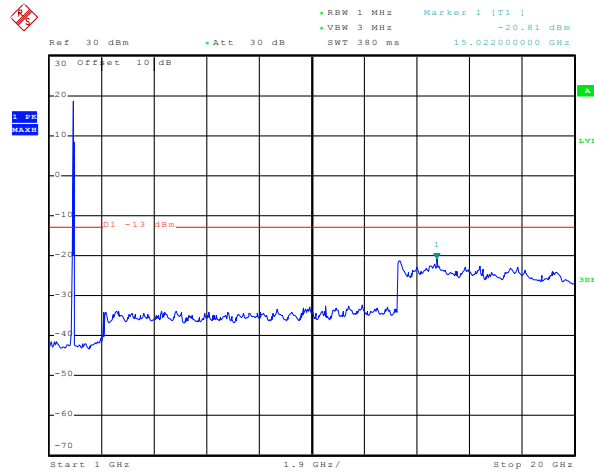

Date: 26.NOV.2015 23:14:05

1GHz~20GHz

Test Mode:	LTE band 2(20MHz QPSK) RB Size 1& RB Offset 0	Test Channel:	Lowest channel
------------	--	---------------	----------------

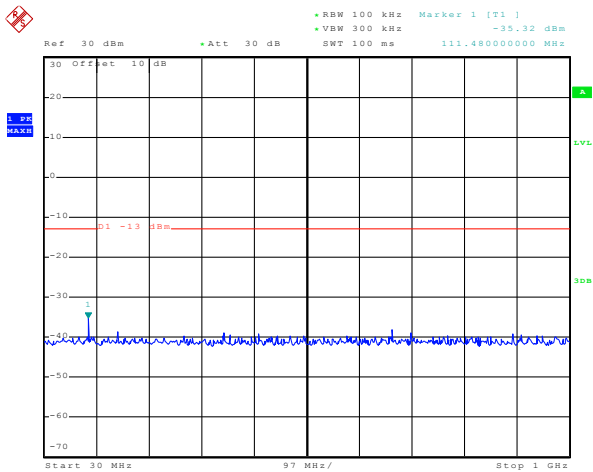

Date: 26.NOV.2015 23:02:39

30MHz~1GHz

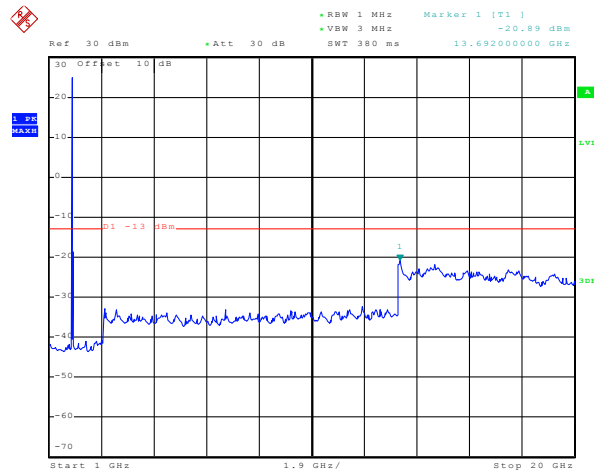

Date: 26.NOV.2015 22:58:47

1GHz~20GHz

Test Mode:	LTE band 2(20MHz QPSK) RB Size 1& RB Offset 0	Test Channel:	Middle channel
------------	--	---------------	----------------

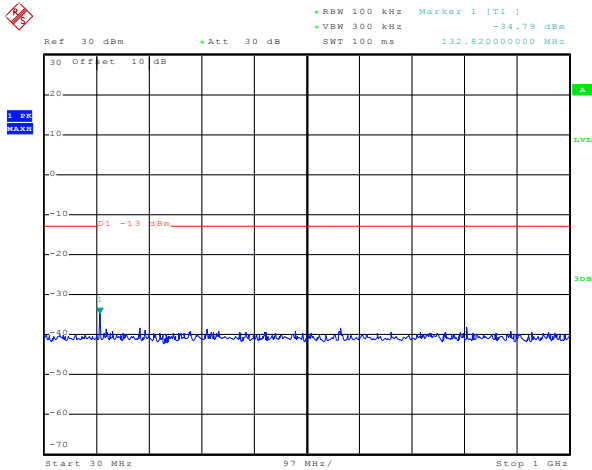

Date: 26.NOV.2015 23:04:46

30MHz~1GHz

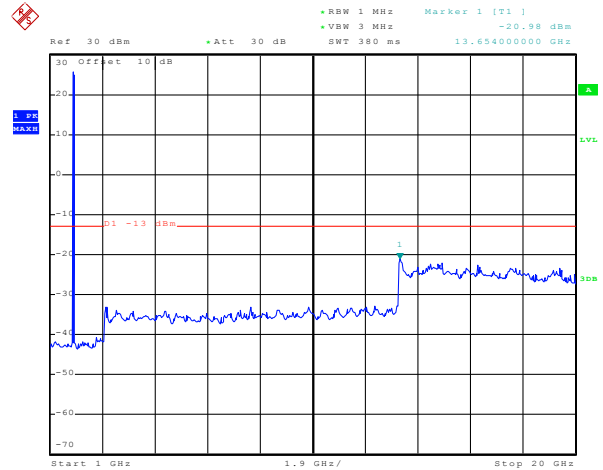

Date: 26.NOV.2015 23:07:29

1GHz~20GHz

Test Mode:	LTE band 2(20MHz QPSK) RB Size 1& RB Offset 0	Test Channel:	Highest channel
------------	--	---------------	-----------------

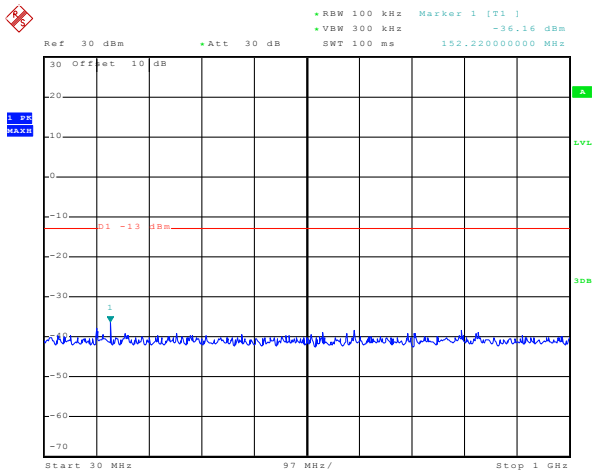

Date: 26.NOV.2015 23:15:09

30MHz~1GHz

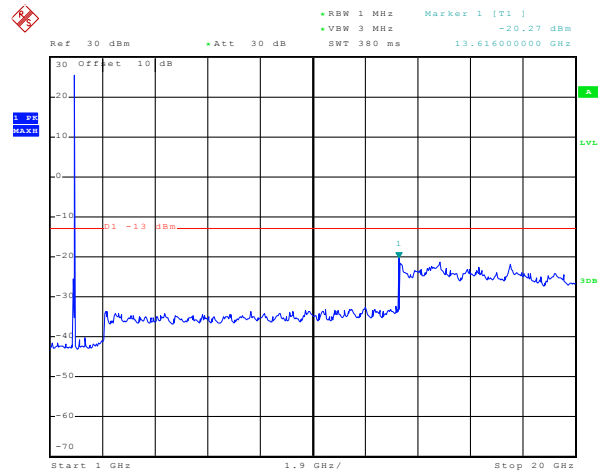

Date: 26.NOV.2015 23:09:56

1GHz~20GHz

Test Mode:	LTE band 2(20MHz QPSK) RB Size 50& RB Offset 0	Test Channel:	Lowest channel
------------	---	---------------	----------------

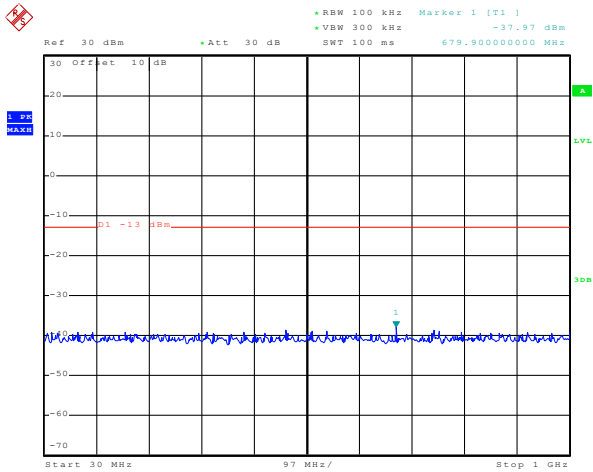

Date: 26.NOV.2015 23:03:42

30MHz~1GHz

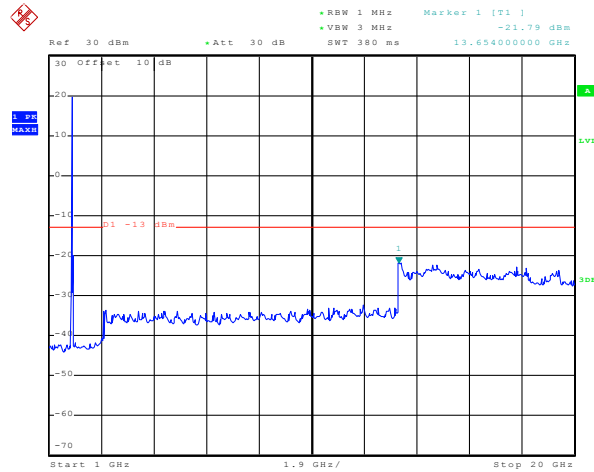

Date: 26.NOV.2015 23:00:01

1GHz~20GHz

Test Mode:	LTE band 2(20MHz QPSK) RB Size 50& RB Offset 0	Test Channel:	Middle channel
------------	---	---------------	----------------

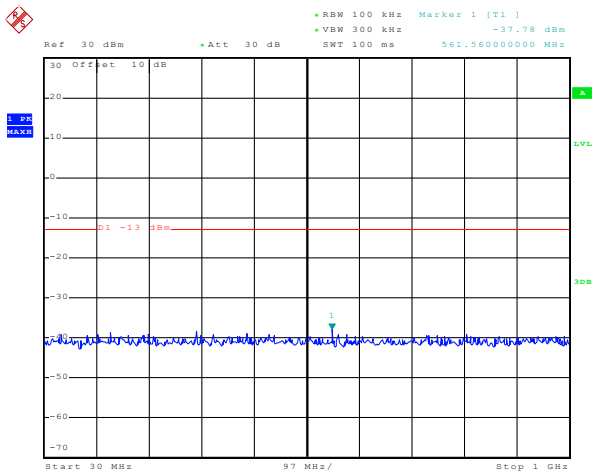

Date: 26.NOV.2015 23:05:31

30MHz~1GHz

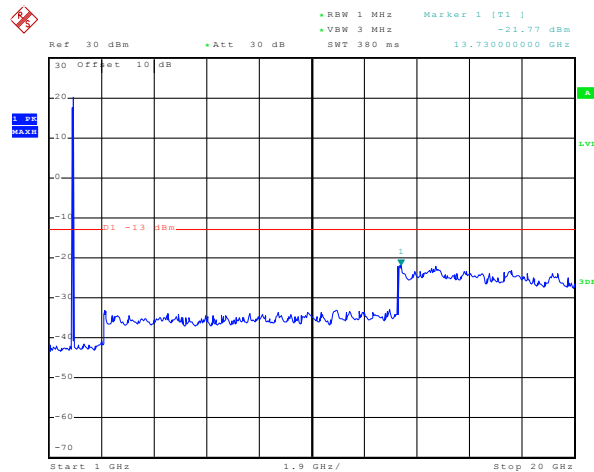

Date: 26.NOV.2015 23:08:54

1GHz~20GHz

Test Mode:	LTE band 2(20MHz QPSK) RB Size 50& RB Offset 0	Test Channel:	Highest channel
------------	---	---------------	-----------------

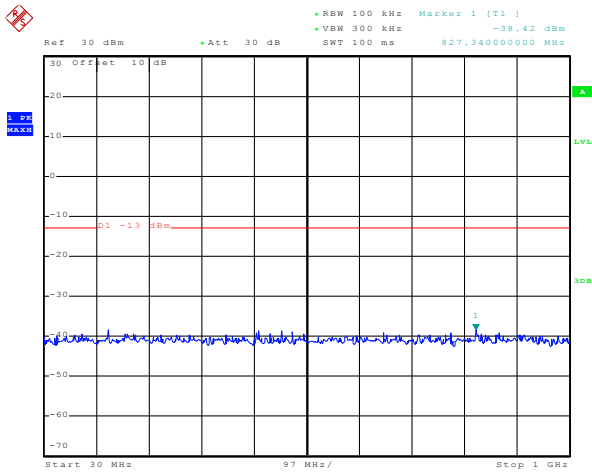

Date: 26.NOV.2015 23:16:10

30MHz~1GHz

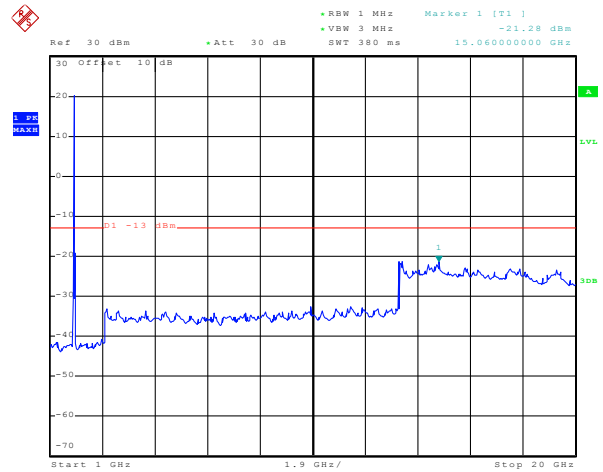

Date: 26.NOV.2015 23:12:49

1GHz~20GHz

Test Mode:	LTE band 2(20MHz QPSK) RB Size 100& RB Offset 0	Test Channel:	Lowest channel
------------	--	---------------	----------------

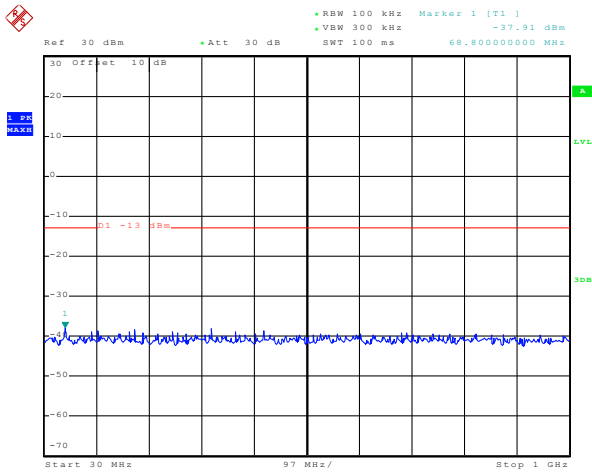

Date: 26.NOV.2015 23:02:26

30MHz~1GHz

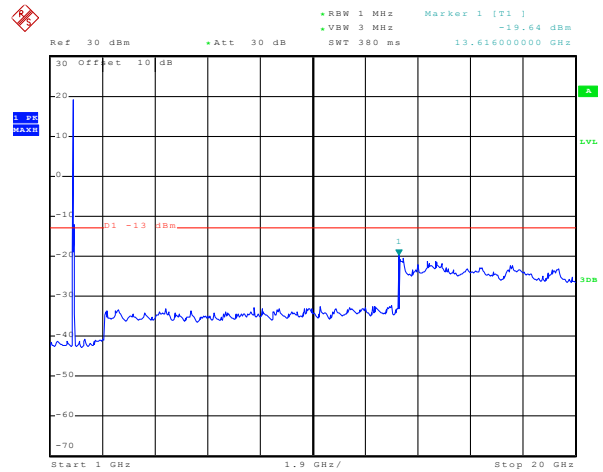

Date: 26.NOV.2015 23:01:16

1GHz~20GHz

Test Mode:	LTE band 2(20MHz QPSK) RB Size 100& RB Offset 0	Test Channel:	Middle channel
------------	--	---------------	----------------

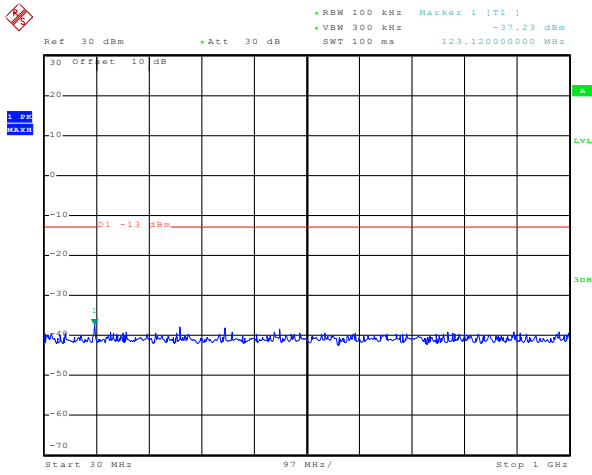

Date: 26.NOV.2015 23:05:43

30MHz~1GHz

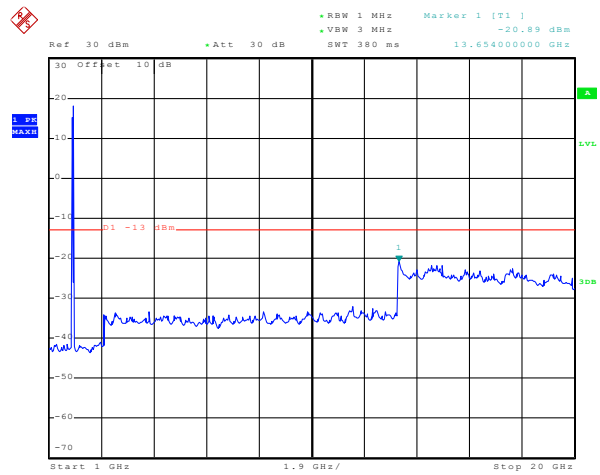

Date: 26.NOV.2015 23:07:08

1GHz~20GHz

Test Mode:	LTE band 2(20MHz QPSK) RB Size 100 & RB Offset 0	Test Channel:	Highest channel
------------	---	---------------	-----------------

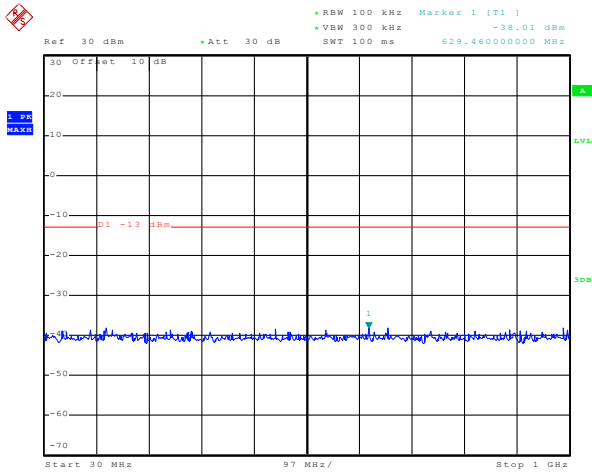

Date: 26.NOV.2015 23:14:57

30MHz~1GHz

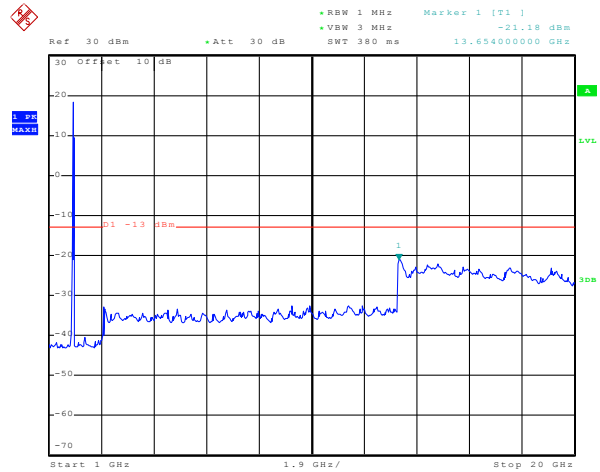

Date: 26.NOV.2015 23:13:24

1GHz~20GHz

LTE band 4 Part:

1.4MHz

Test Mode:	LTE band 4(1.4 MHz 16QAM) RB Size 1& RB Offset 0	Test Channel:	Lowest channel
------------	---	---------------	----------------

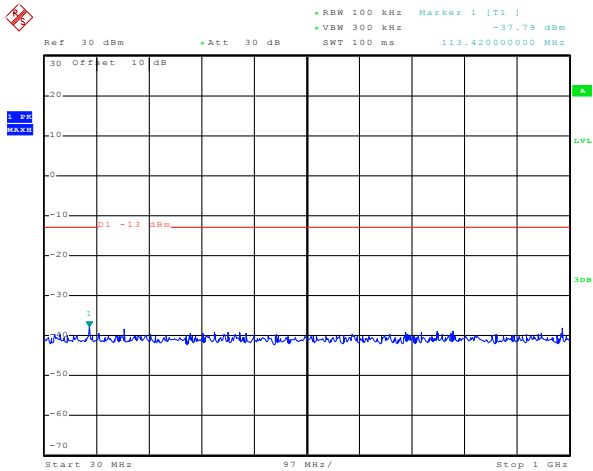

Date: 26.NOV.2015 23:21:11

30MHz~1GHz

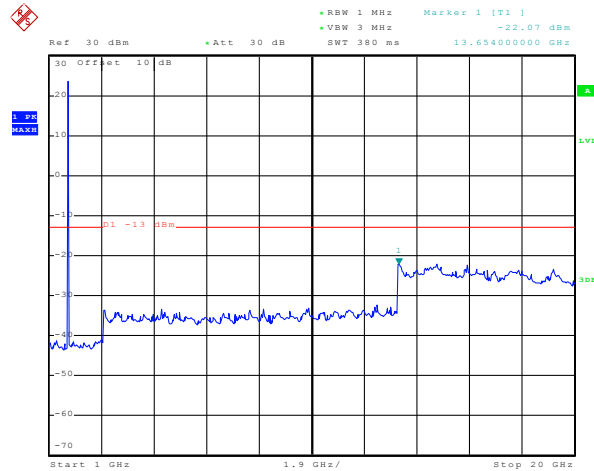

Date: 26.NOV.2015 23:25:05

1GHz~20GHz

Test Mode:	LTE band 4(1.4 MHz 16QAM) RB Size 1& RB Offset 0	Test Channel:	Middle channel
------------	---	---------------	----------------

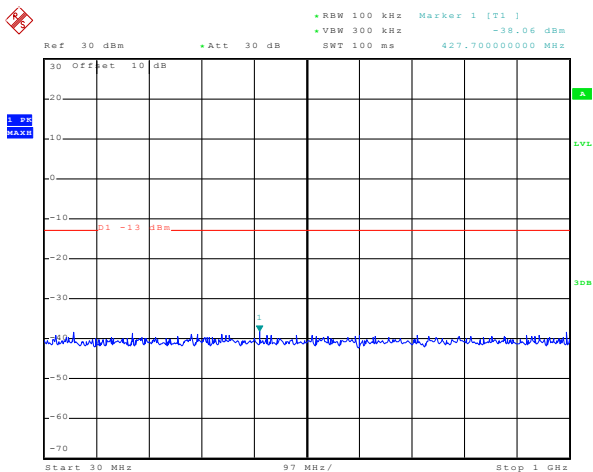

Date: 26.NOV.2015 23:30:06

30MHz~1GHz

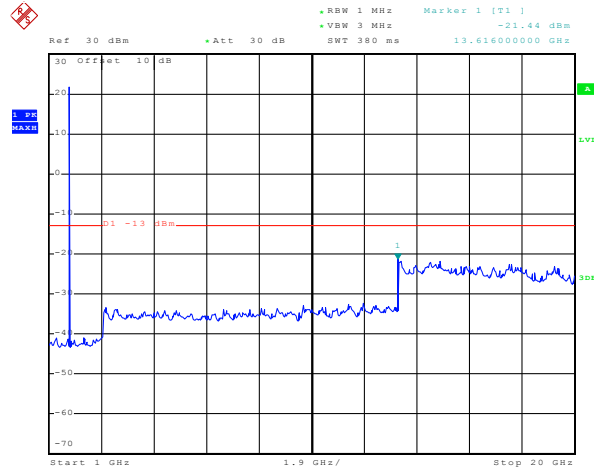

Date: 26.NOV.2015 23:26:53

1GHz~20GHz

Test Mode:	LTE band 4(1.4 MHz 16QAM) RB Size 1& RB Offset 0	Test Channel:	Highest channel
------------	---	---------------	-----------------

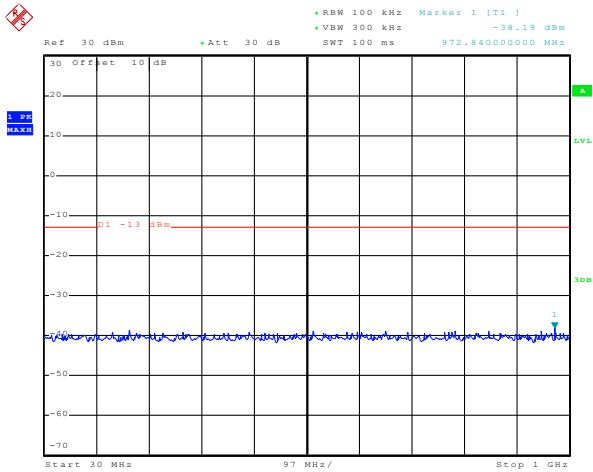

Date: 26.NOV.2015 23:34:00

30MHz~1GHz

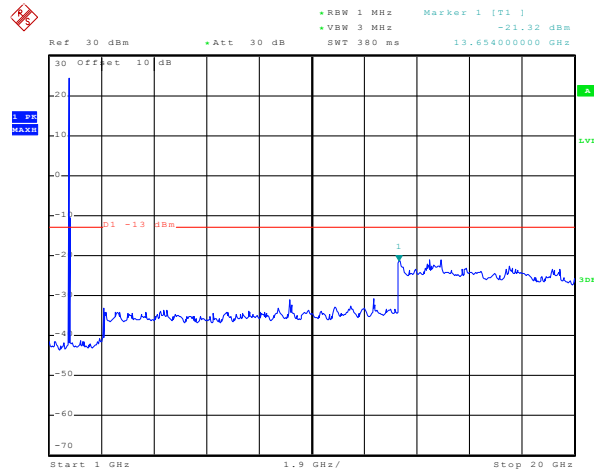

Date: 26.NOV.2015 23:38:04

1GHz~20GHz

Test Mode:	LTE band 4(1.4 MHz 16QAM) RB Size 3& RB Offset 0	Test Channel:	Lowest channel
------------	---	---------------	----------------

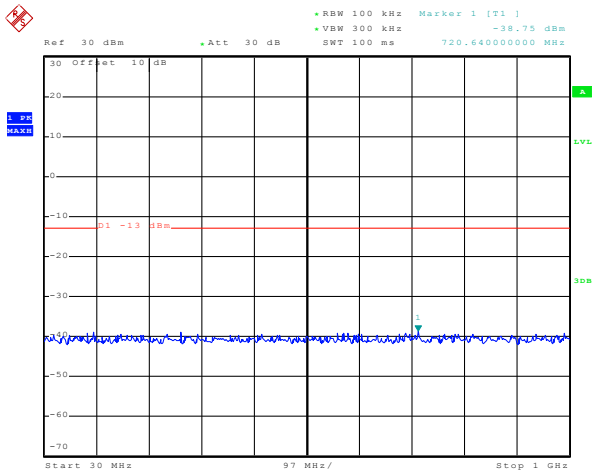

Date: 26.NOV.2015 23:21:45

30MHz~1GHz

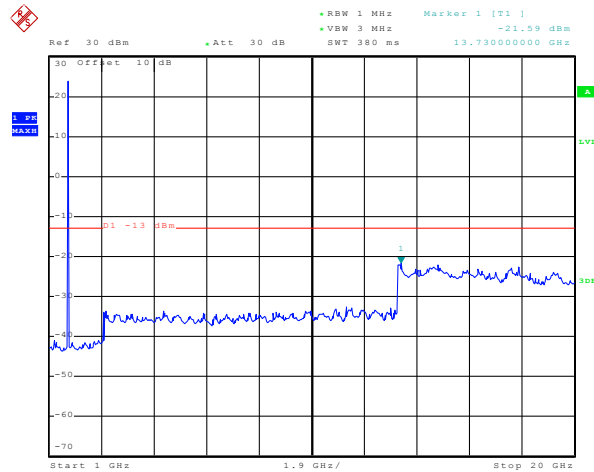

Date: 26.NOV.2015 23:25:32

1GHz~20GHz

Test Mode:	LTE band 4(1.4 MHz 16QAM) RB Size 3& RB Offset 0	Test Channel:	Middle channel
------------	---	---------------	----------------

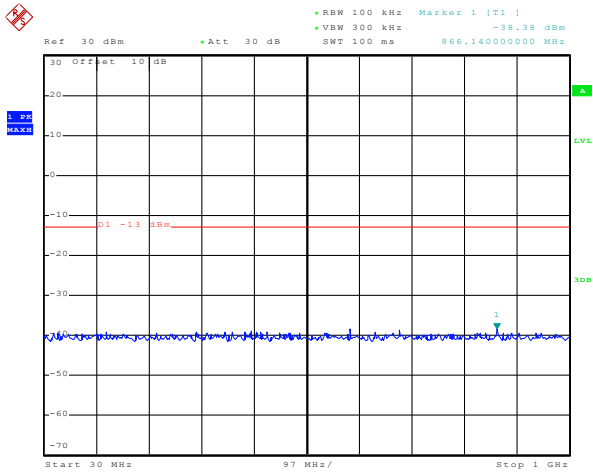

Date: 26.NOV.2015 23:30:41

30MHz~1GHz

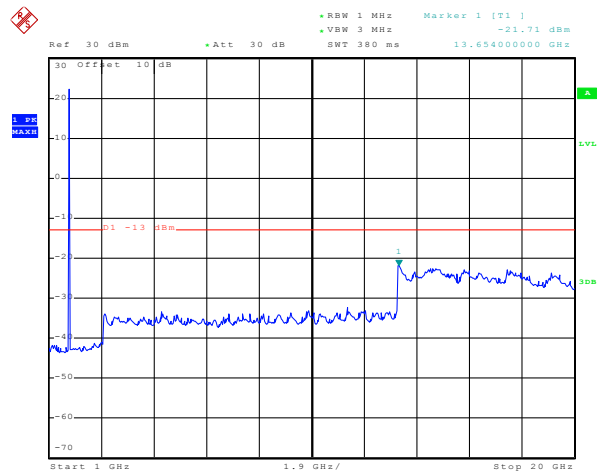

Date: 26.NOV.2015 23:27:16

1GHz~20GHz

Test Mode:	LTE band 4(1.4 MHz 16QAM) RB Size 3& RB Offset 0	Test Channel:	Highest channel
------------	---	---------------	-----------------

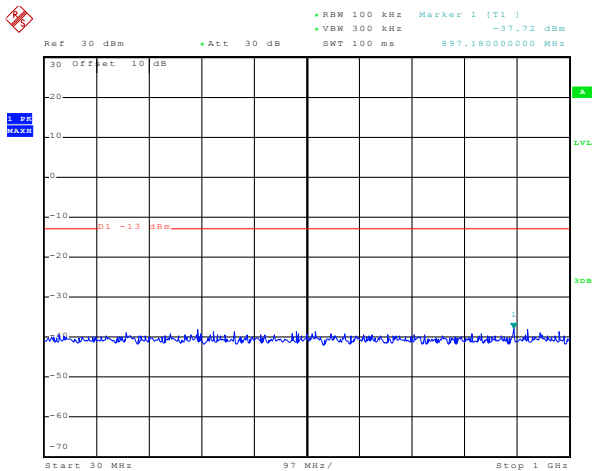

Date: 26.NOV.2015 23:35:16

30MHz~1GHz

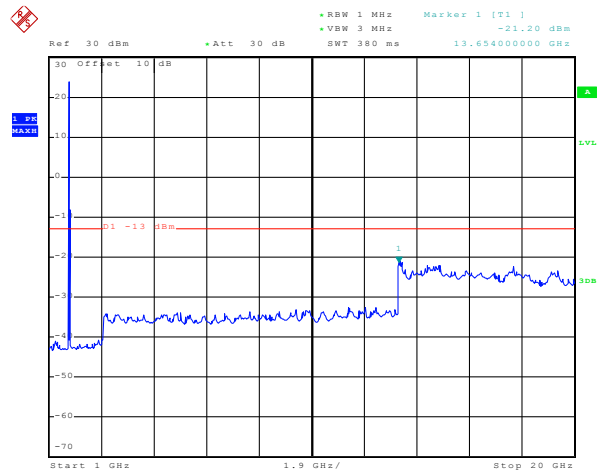

Date: 26.NOV.2015 23:38:33

1GHz~20GHz

Test Mode:	LTE band 4(1.4 MHz 16QAM) RB Size 6& RB Offset 0	Test Channel:	Lowest channel
------------	---	---------------	----------------

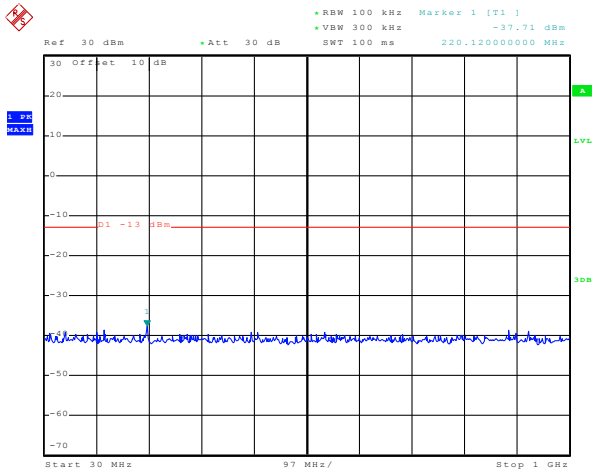

Date: 26.NOV.2015 23:22:25

30MHz~1GHz

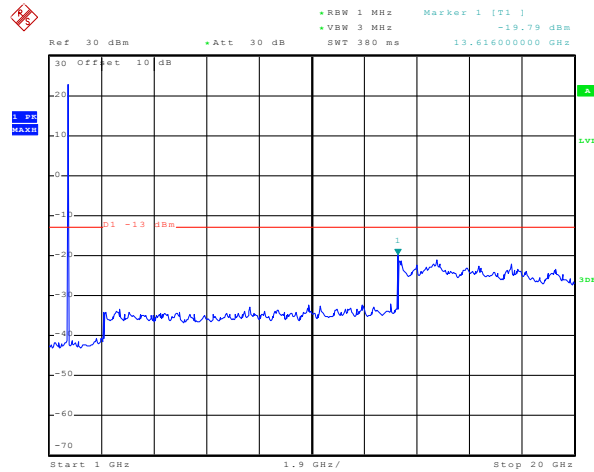

Date: 26.NOV.2015 23:23:57

1GHz~20GHz

Test Mode:	LTE band 4(1.4 MHz 16QAM) RB Size 6& RB Offset 0	Test Channel:	Middle channel
------------	---	---------------	----------------

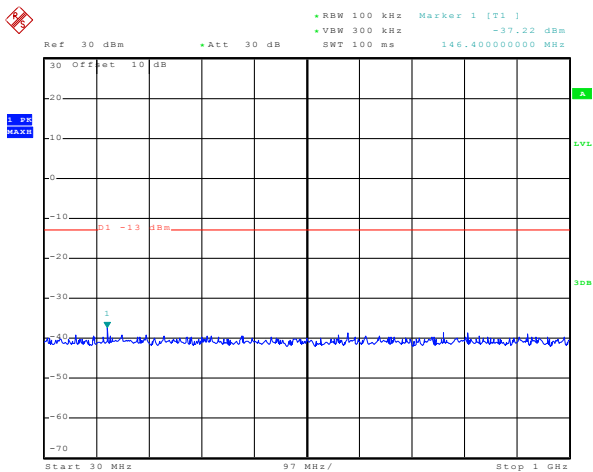

Date: 26.NOV.2015 23:29:15

30MHz~1GHz

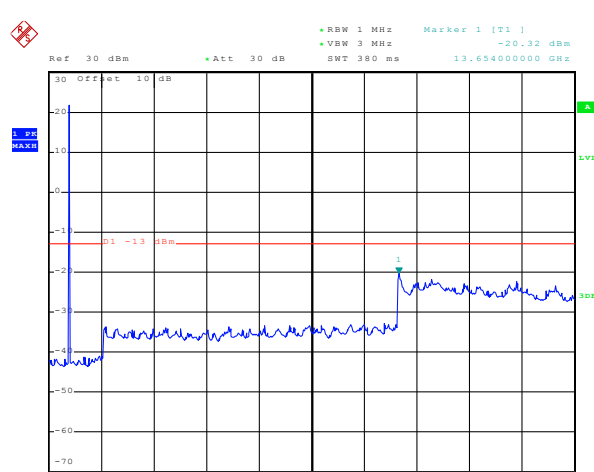

Date: 26.NOV.2015 23:28:39

1GHz~20GHz

Test Mode:	LTE band 4(1.4 MHz 16QAM) RB Size 6& RB Offset 0	Test Channel:	Highest channel
------------	---	---------------	-----------------

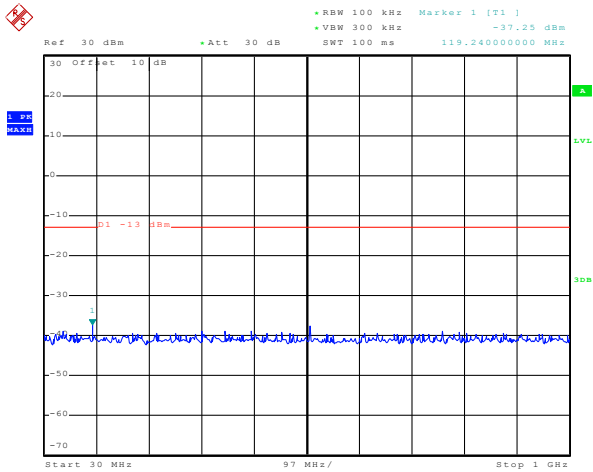

Date: 26.NOV.2015 23:35:54

30MHz~1GHz

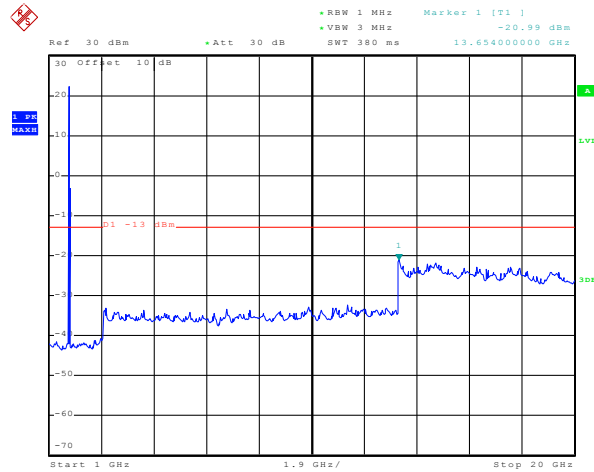

Date: 26.NOV.2015 23:36:51

1GHz~20GHz

Test Mode:	LTE band 4(1.4 MHz QPSK) RB Size 1& RB Offset 0	Test Channel:	Lowest channel
------------	--	---------------	----------------

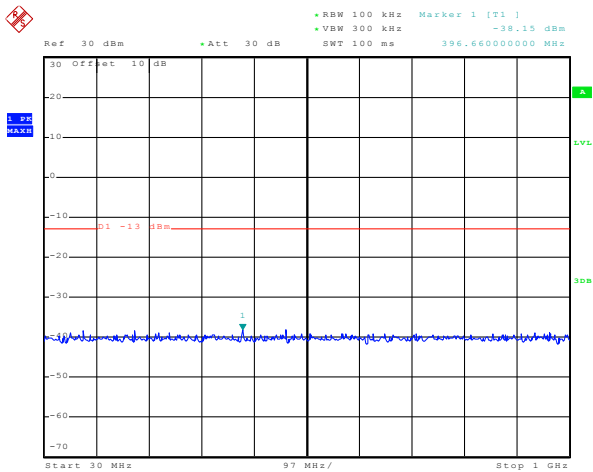

Date: 26.NOV.2015 23:20:51

30MHz~1GHz

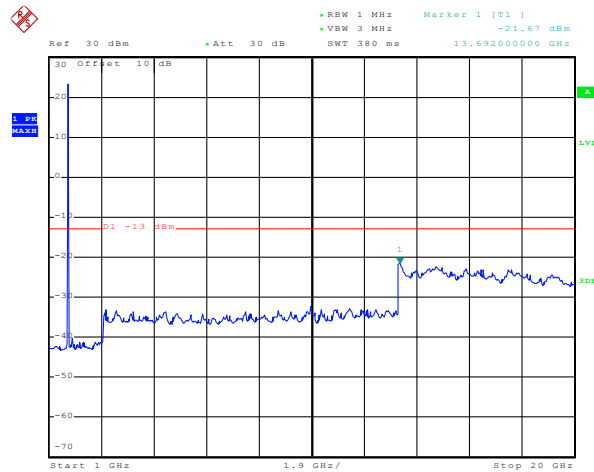

Date: 26.NOV.2015 23:24:44

1GHz~20GHz

Test Mode:	LTE band 4(1.4 MHz QPSK) RB Size 1& RB Offset 0	Test Channel:	Middle channel
------------	--	---------------	----------------

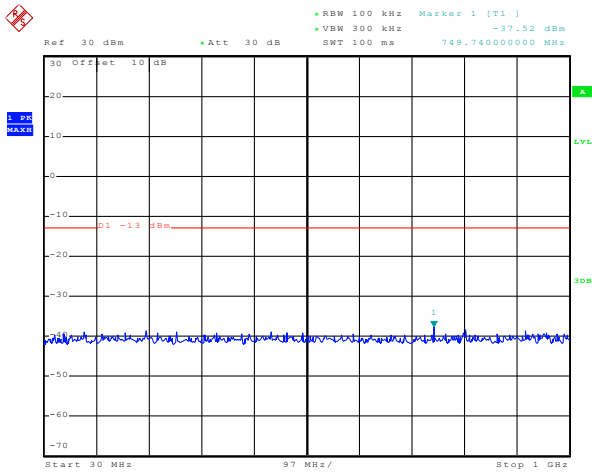

Date: 26.NOV.2015 23:29:43

30MHz~1GHz

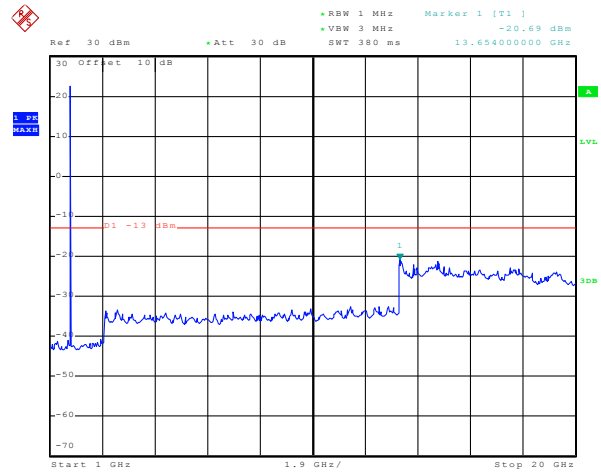

Date: 26.NOV.2015 23:26:26

1GHz~20GHz

Test Mode:	LTE band 4(1.4 MHz QPSK) RB Size 1& RB Offset 0	Test Channel:	Highest channel
------------	--	---------------	-----------------

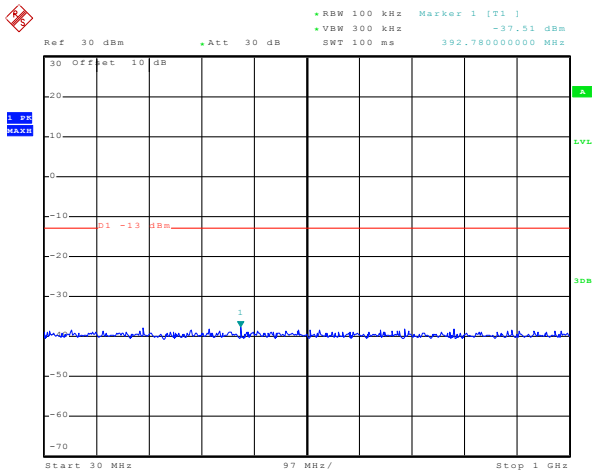

Date: 26.NOV.2015 23:33:34

30MHz~1GHz

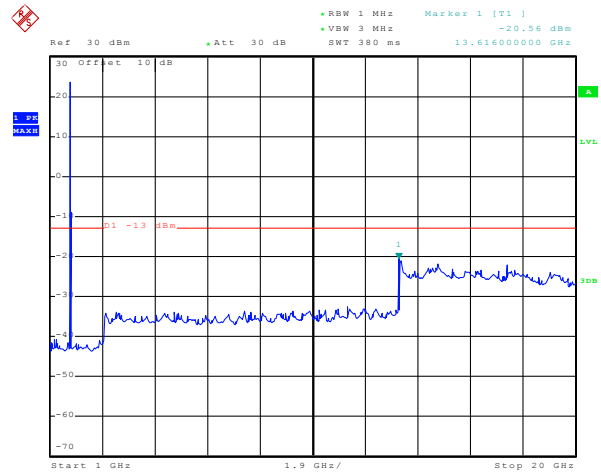

Date: 26.NOV.2015 23:37:29

1GHz~20GHz

Test Mode:	LTE band 4(1.4 MHz QPSK) RB Size 3& RB Offset 0	Test Channel:	Lowest channel
------------	--	---------------	----------------

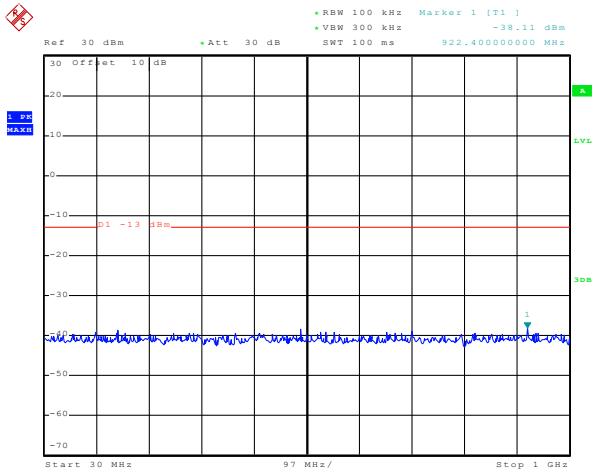

Date: 26.NOV.2015 23:21:59

30MHz~1GHz

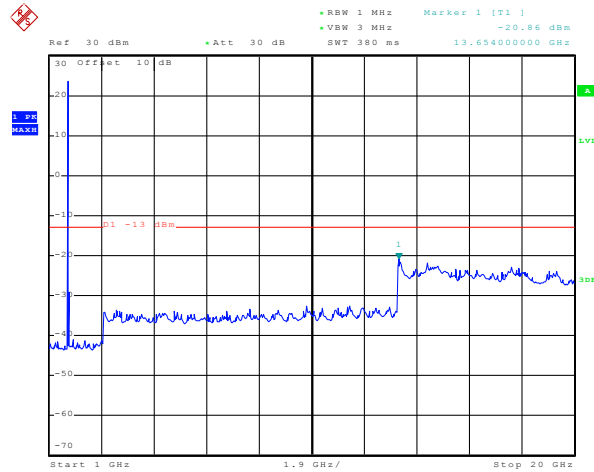

Date: 26.NOV.2015 23:25:52

1GHz~20GHz

Test Mode:	LTE band 4(1.4 MHz QPSK) RB Size 3& RB Offset 0	Test Channel:	Middle channel
------------	--	---------------	----------------

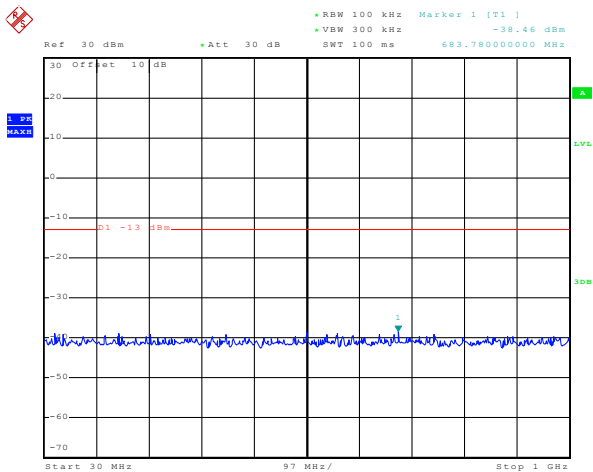

Date: 26.NOV.2015 23:30:53

30MHz~1GHz

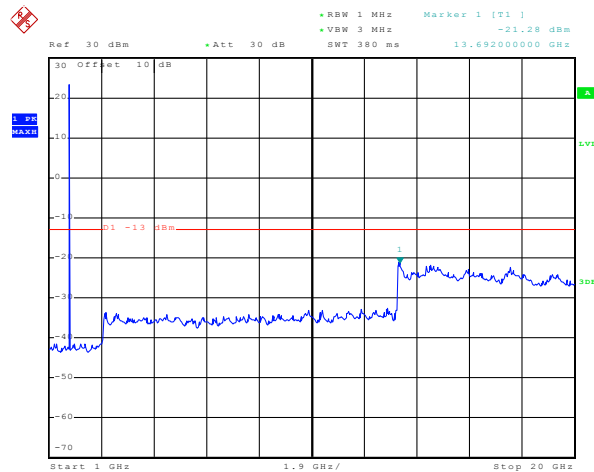

Date: 26.NOV.2015 23:27:39

1GHz~20GHz

Test Mode:	LTE band 4(1.4 MHz QPSK) RB Size 3& RB Offset 0	Test Channel:	Highest channel
------------	--	---------------	-----------------

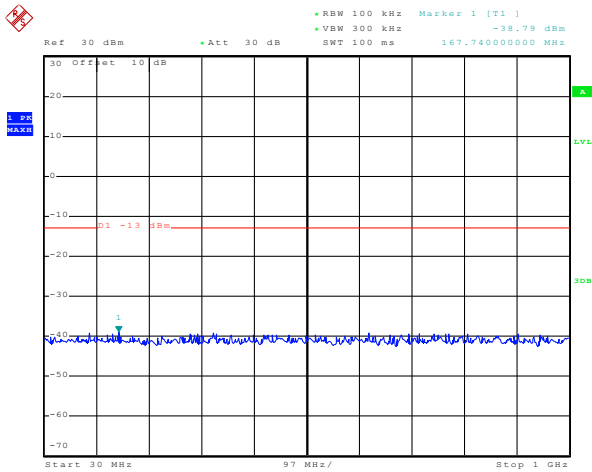

Date: 26.NOV.2015 23:35:29

30MHz~1GHz

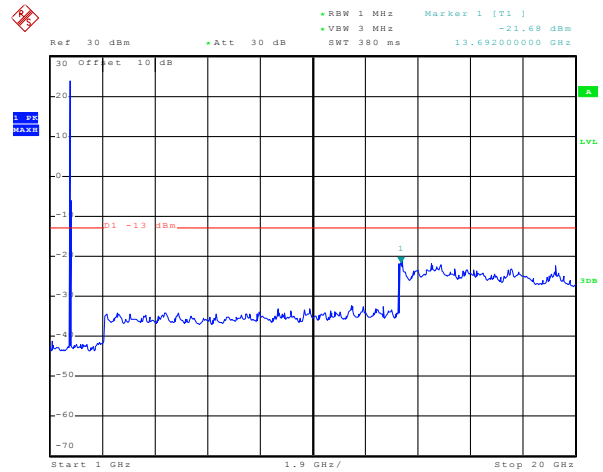

Date: 26.NOV.2015 23:38:54

1GHz~20GHz

Test Mode:	LTE band 4(1.4 MHz QPSK) RB Size 6& RB Offset 0	Test Channel:	Lowest channel
------------	--	---------------	----------------

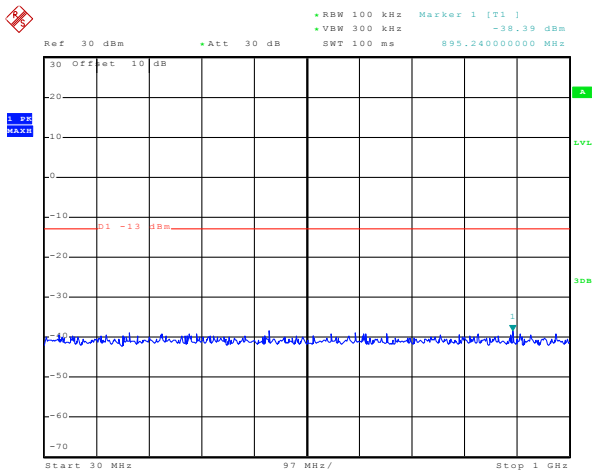

Date: 26.NOV.2015 23:22:12

30MHz~1GHz

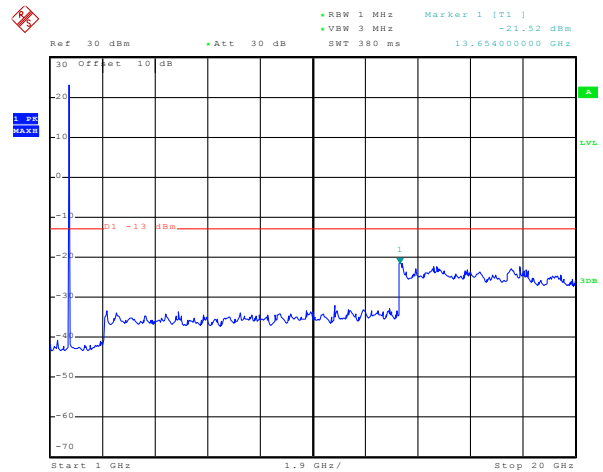

Date: 26.NOV.2015 23:24:17

1GHz~20GHz

Test Mode:	LTE band 4(1.4 MHz QPSK) RB Size 6& RB Offset 0	Test Channel:	Middle channel
------------	--	---------------	----------------

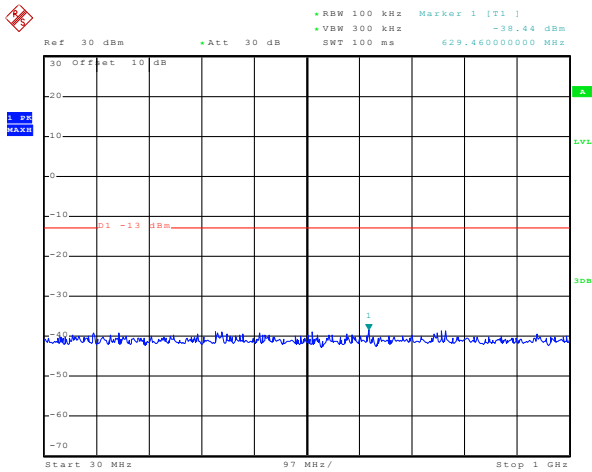

Date: 26.NOV.2015 23:29:27

30MHz~1GHz

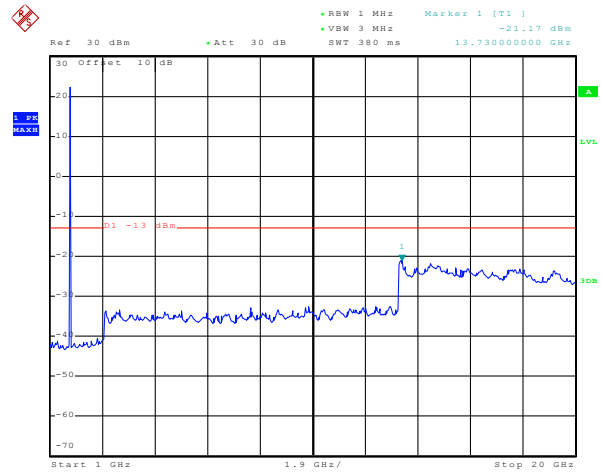

Date: 26.NOV.2015 23:28:20

1GHz~20GHz

Test Mode:	LTE band 4(1.4 MHz QPSK) RB Size 6& RB Offset 0	Test Channel:	Highest channel
------------	--	---------------	-----------------

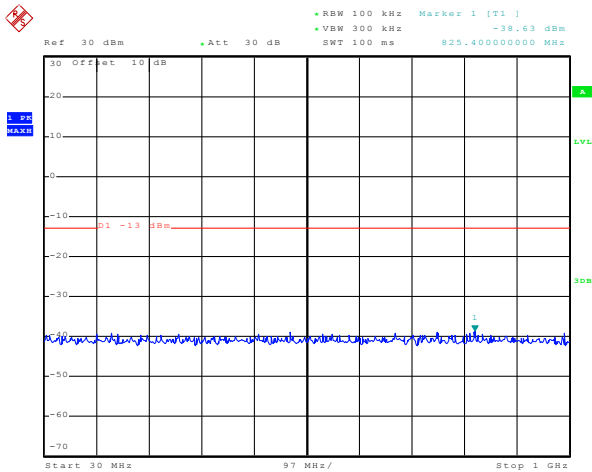

Date: 26.NOV.2015 23:35:42

30MHz~1GHz

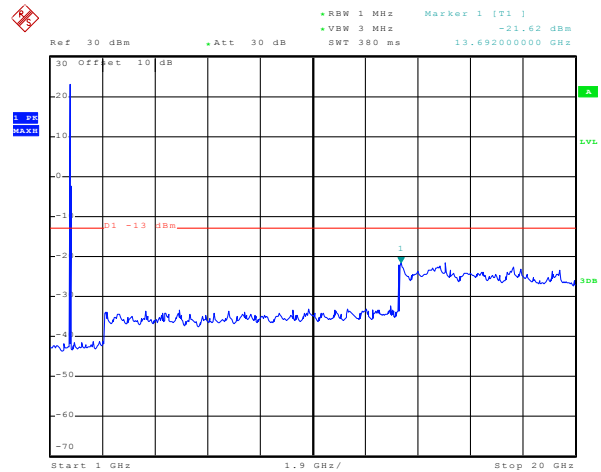

Date: 26.NOV.2015 23:37:11

1GHz~20GHz

3MHz

Test Mode:	LTE band 4(3MHz 16QAM) RB Size 1& RB Offset 0	Test Channel:	Lowest channel
------------	--	---------------	----------------

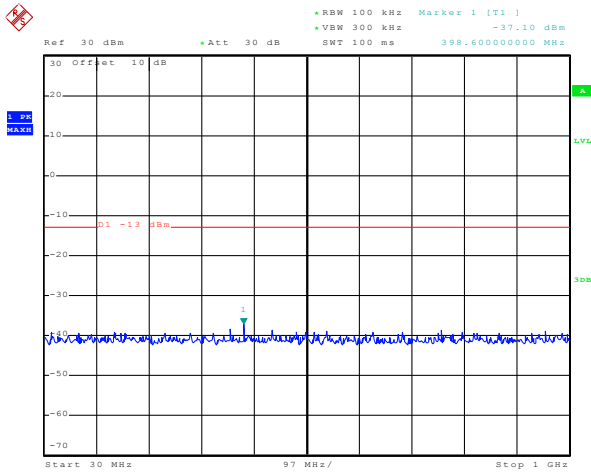

Date: 26.NOV.2015 22:52:17

30MHz~1GHz

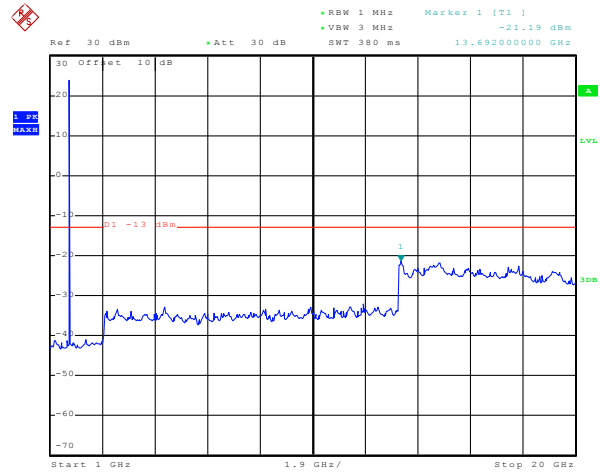

Date: 26.NOV.2015 23:41:48

1GHz~20GHz

Test Mode:	LTE band 4(3MHz 16QAM) RB Size 1& RB Offset 0	Test Channel:	Middle channel
------------	--	---------------	----------------

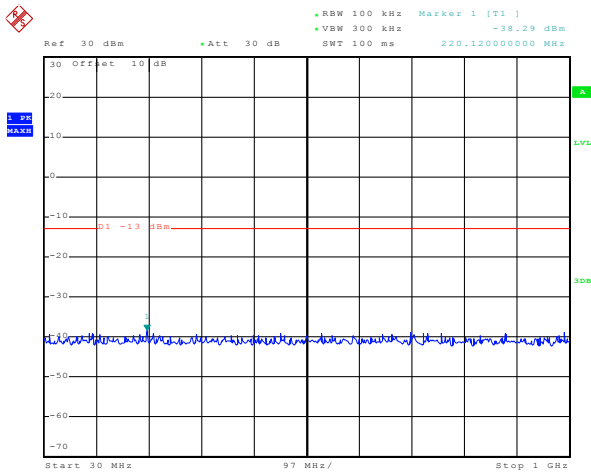

Date: 26.NOV.2015 22:53:52

30MHz~1GHz

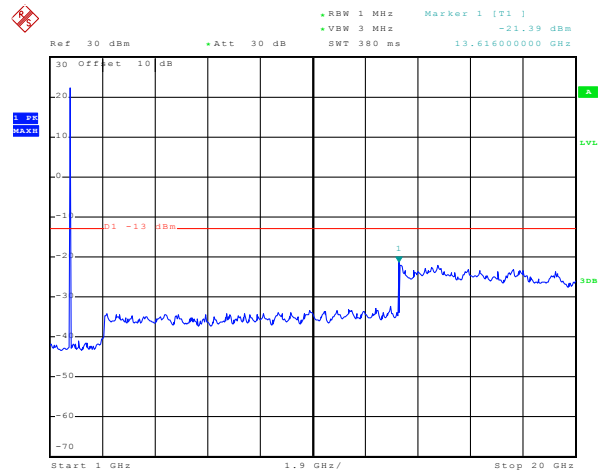

Date: 26.NOV.2015 22:58:31

1GHz~20GHz

Test Mode:	LTE band 4(3MHz 16QAM) RB Size 1& RB Offset 0	Test Channel:	Highest channel
------------	--	---------------	-----------------

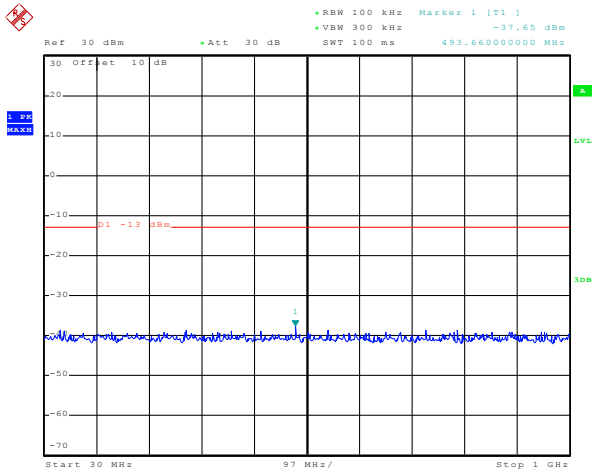

Date: 26.NOV.2015 23:04:20

30MHz~1GHz

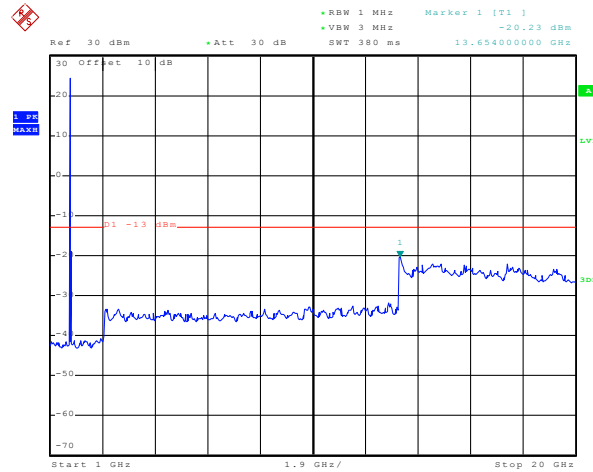

Date: 26.NOV.2015 23:01:09

1GHz~20GHz

Test Mode:	LTE band 4(3MHz 16QAM) RB Size 8& RB Offset 0	Test Channel:	Lowest channel
------------	--	---------------	----------------

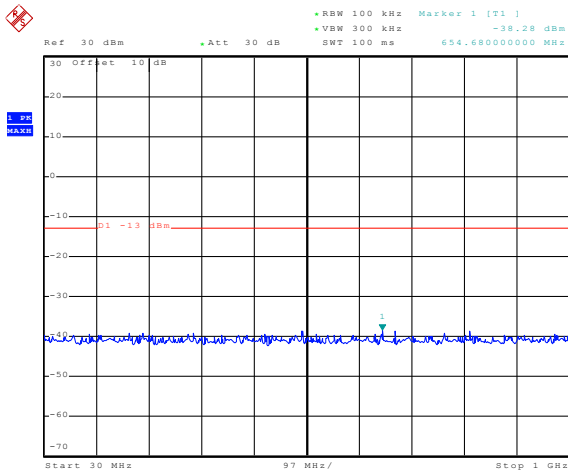

Date: 26.NOV.2015 22:52:38

30MHz~1GHz

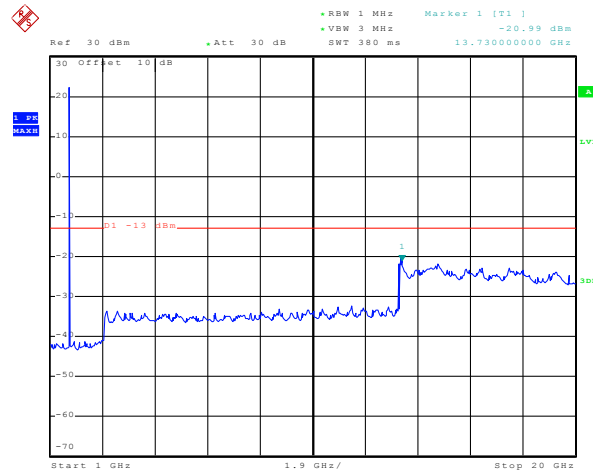

Date: 26.NOV.2015 23:43:41

1GHz~20GHz

Test Mode:	LTE band 4(3MHz 16QAM) RB Size 8& RB Offset 0	Test Channel:	Middle channel
------------	--	---------------	----------------

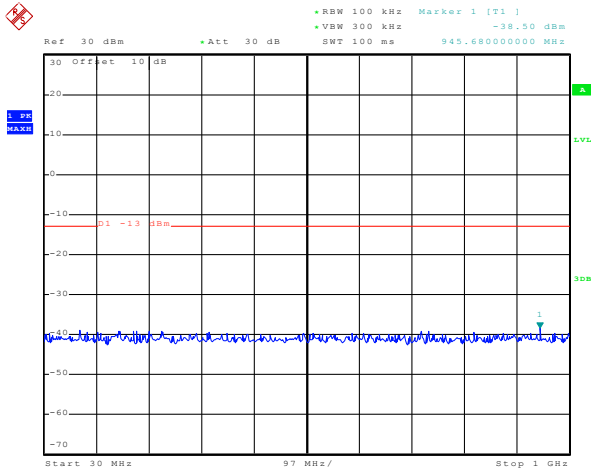

Date: 26.NOV.2015 22:54:23

30MHz~1GHz

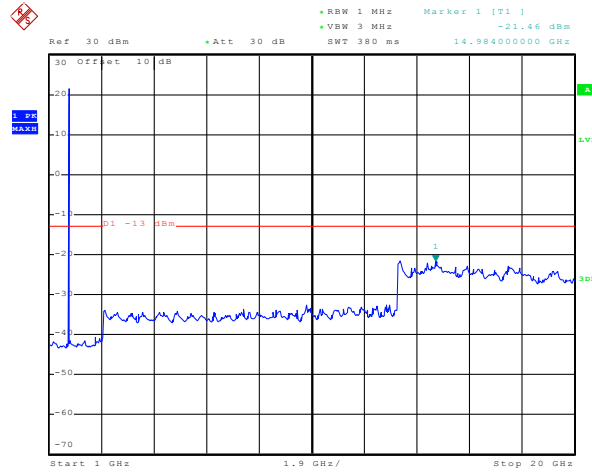

Date: 26.NOV.2015 22:58:54

1GHz~20GHz

Test Mode:	LTE band 4(3MHz 16QAM) RB Size 8& RB Offset 0	Test Channel:	Highest channel
------------	--	---------------	-----------------

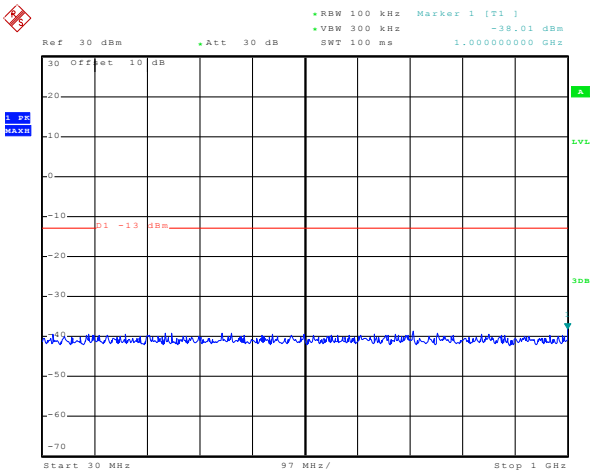

Date: 26.NOV.2015 23:04:35

0MHz~1GHz

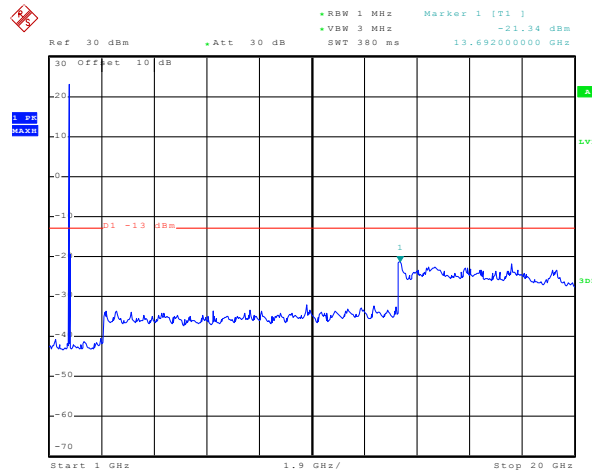

Date: 26.NOV.2015 23:01:33

1GHz~20GHz

Test Mode:	LTE band 4(3MHz 16QAM) RB Size 15& RB Offset 0	Test Channel:	Lowest channel
------------	---	---------------	----------------

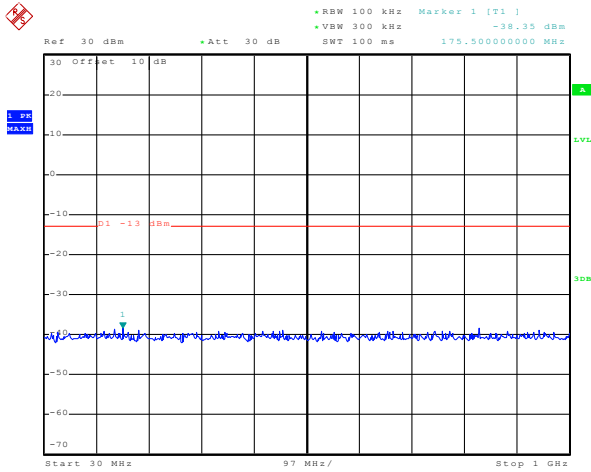

Date: 26.NOV.2015 22:51:38

30MHz~1GHz

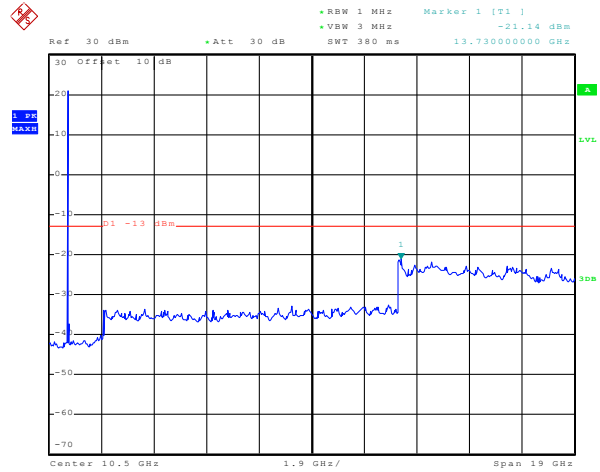

Date: 26.NOV.2015 22:50:47

1GHz~20GHz

Test Mode:	LTE band 4(3MHz 16QAM) RB Size 15& RB Offset 0	Test Channel:	Middle channel
------------	---	---------------	----------------

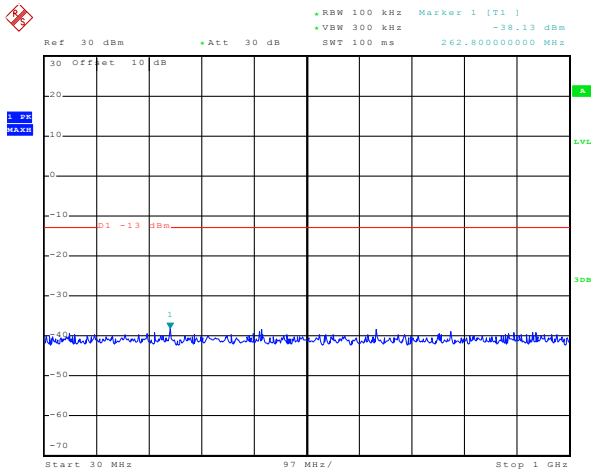

Date: 26.NOV.2015 22:55:01

30MHz~1GHz

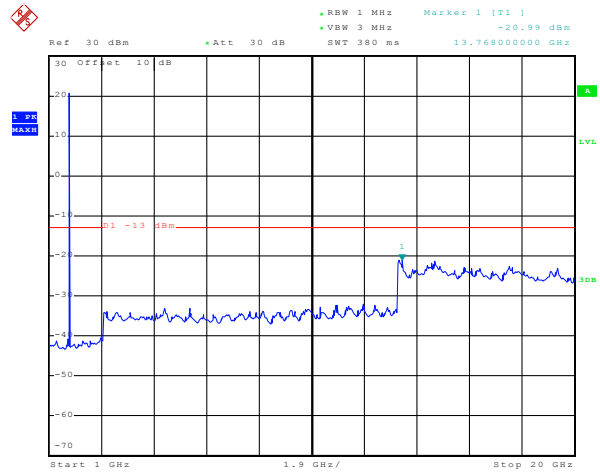

Date: 26.NOV.2015 22:55:53

1GHz~20GHz

Test Mode:	LTE band 4(3MHz 16QAM) RB Size 15& RB Offset 0	Test Channel:	Highest channel
------------	---	---------------	-----------------

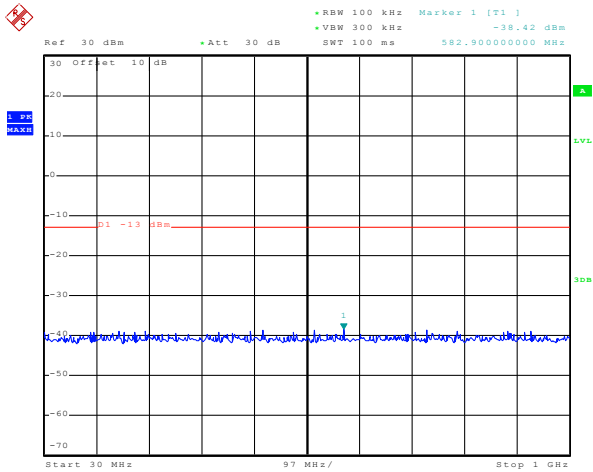

Date: 26.NOV.2015 23:03:25

30MHz~1GHz

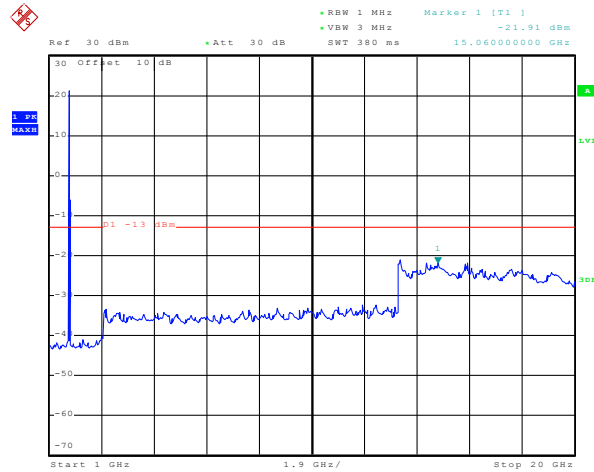

Date: 26.NOV.2015 23:03:02

1GHz~20GHz

Test Mode:	LTE band 4(3MHz QPSK) RB Size 1& RB Offset 0	Test Channel:	Lowest channel
------------	---	---------------	----------------

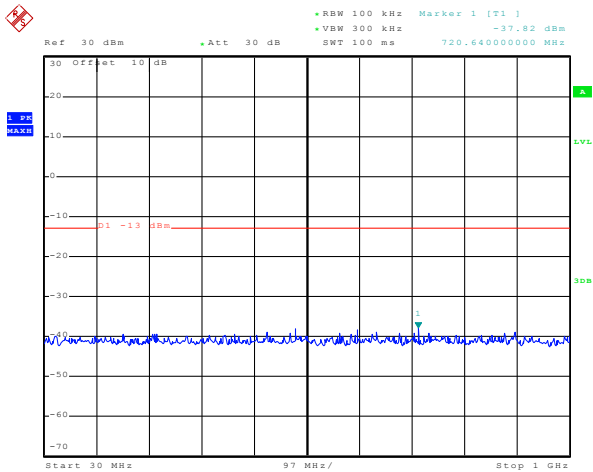

Date: 26.NOV.2015 22:52:05

30MHz~1GHz

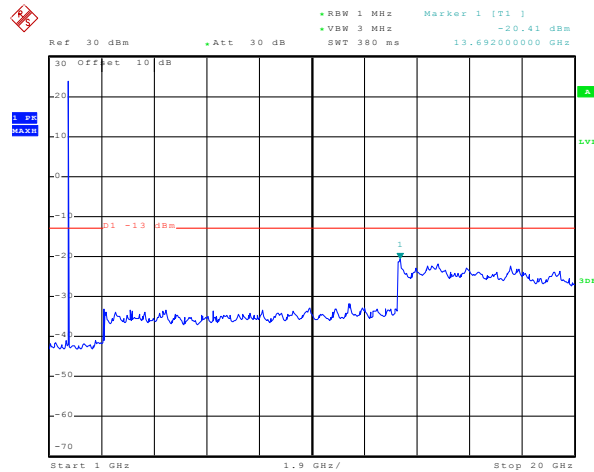

Date: 26.NOV.2015 23:42:42

1GHz~20GHz

Test Mode:	LTE band 4(3MHz QPSK) RB Size 1& RB Offset 0	Test Channel:	Middle channel
------------	---	---------------	----------------

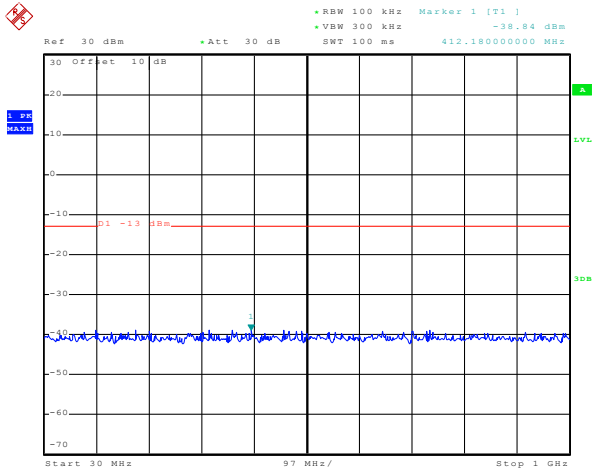

Date: 26.NOV.2015 22:53:40

30MHz~1GHz

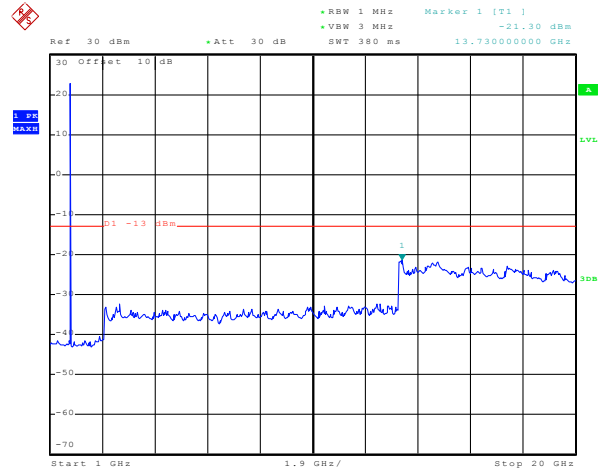

Date: 26.NOV.2015 22:58:07

1GHz~20GHz

Test Mode:	LTE band 4(3MHz QPSK) RB Size 1& RB Offset 0	Test Channel:	Highest channel
------------	---	---------------	-----------------

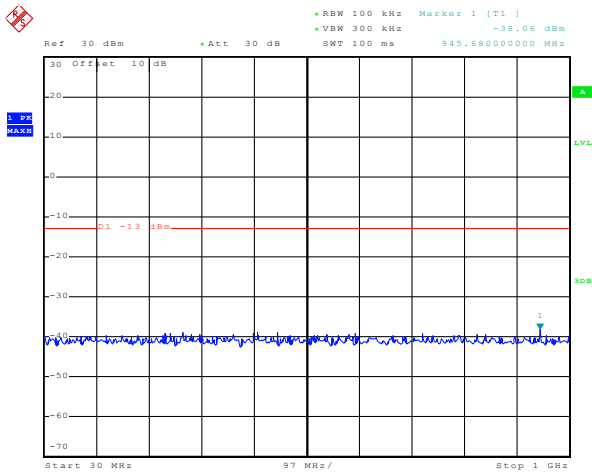

Date: 26.NOV.2015 23:03:57

30MHz~1GHz

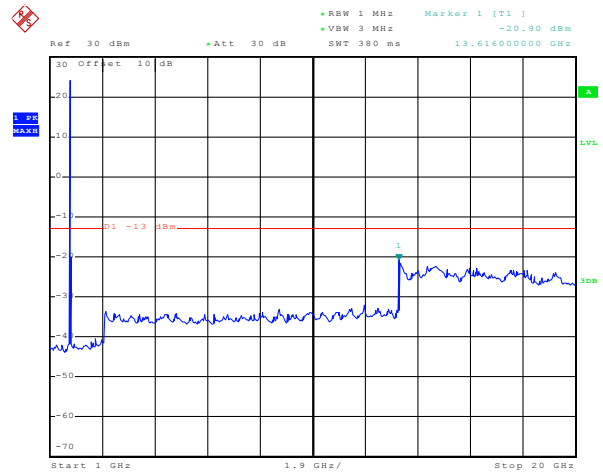

Date: 26.NOV.2015 23:00:15

1GHz~20GHz

Test Mode:	LTE band 4(3MHz QPSK) RB Size 8& RB Offset 0	Test Channel:	Lowest channel
------------	---	---------------	----------------

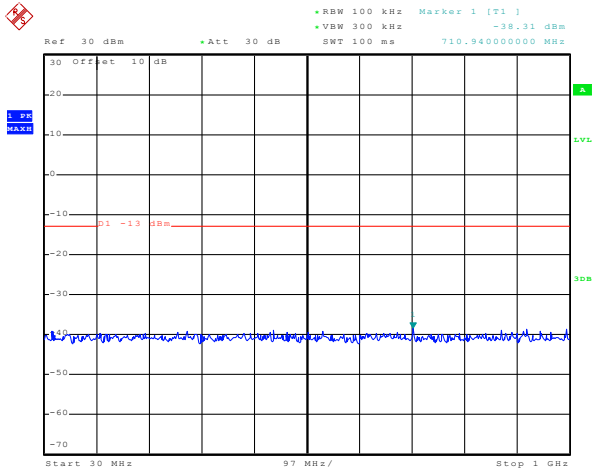

Date: 26.NOV.2015 22:52:55

30MHz~1GHz

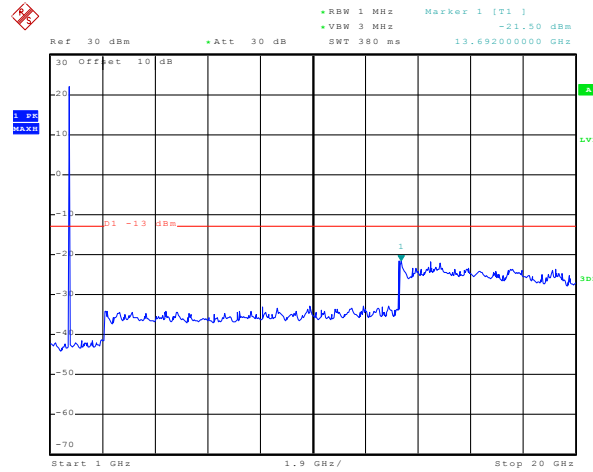

Date: 26.NOV.2015 23:43:02

1GHz~20GHz

Test Mode:	LTE band 4(3MHz QPSK) RB Size 8& RB Offset 0	Test Channel:	Middle channel
------------	---	---------------	----------------

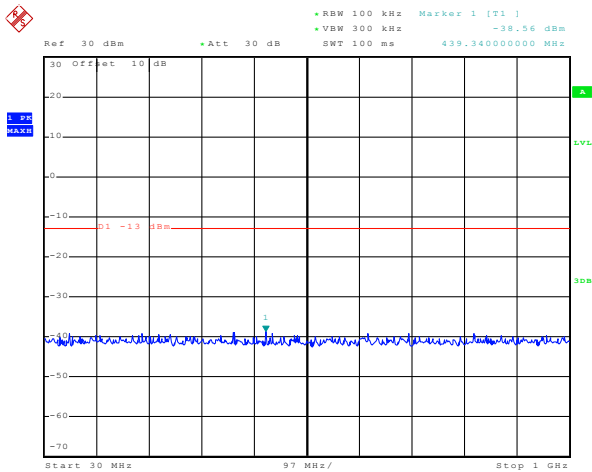

Date: 26.NOV.2015 22:54:36

30MHz~1GHz

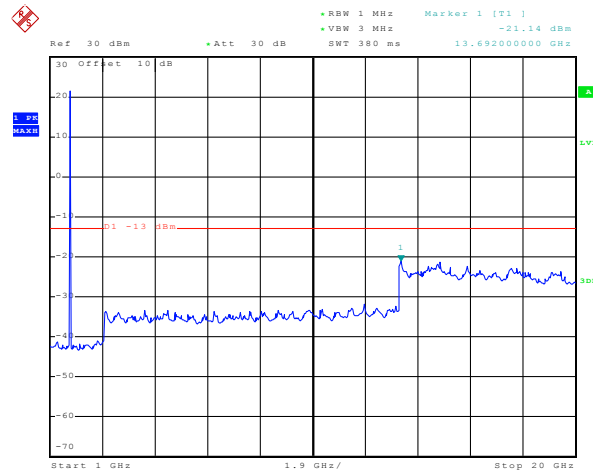

Date: 26.NOV.2015 22:59:31

1GHz~20GHz

Test Mode:	LTE band 4(3MHz QPSK) RB Size 8& RB Offset 0	Test Channel:	Highest channel
------------	---	---------------	-----------------

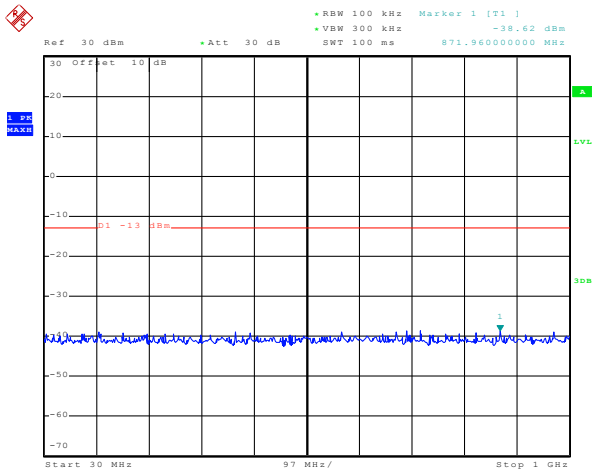

Date: 26.NOV.2015 23:04:53

30MHz~1GHz

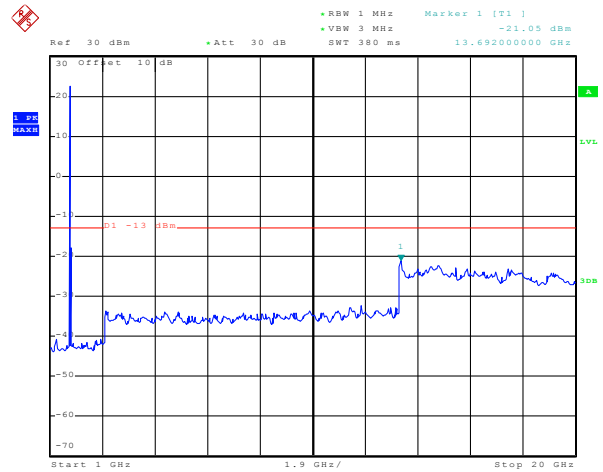

Date: 26.NOV.2015 23:01:56

1GHz~20GHz

Test Mode:	LTE band 4(3MHz QPSK) RB Size 15& RB Offset 0	Test Channel:	Lowest channel
------------	--	---------------	----------------

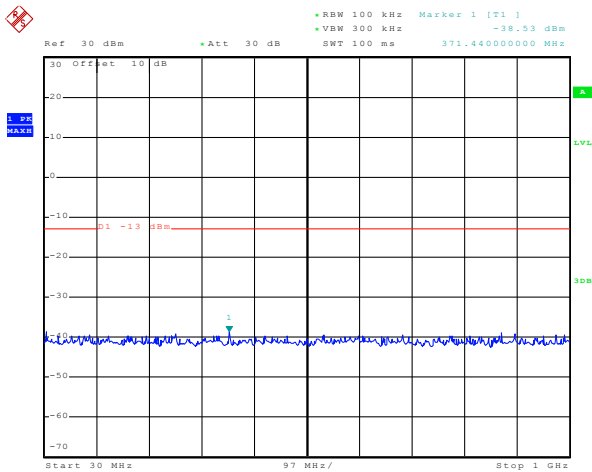

Date: 26.NOV.2015 22:51:54

30MHz~1GHz

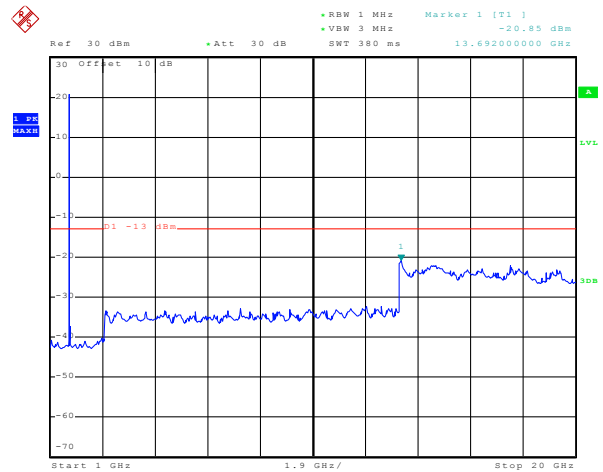

Date: 26.NOV.2015 23:44:40

1GHz~20GHz

Test Mode:	LTE band 4(3MHz QPSK) RB Size 15& RB Offset 0	Test Channel:	Middle channel
------------	--	---------------	----------------

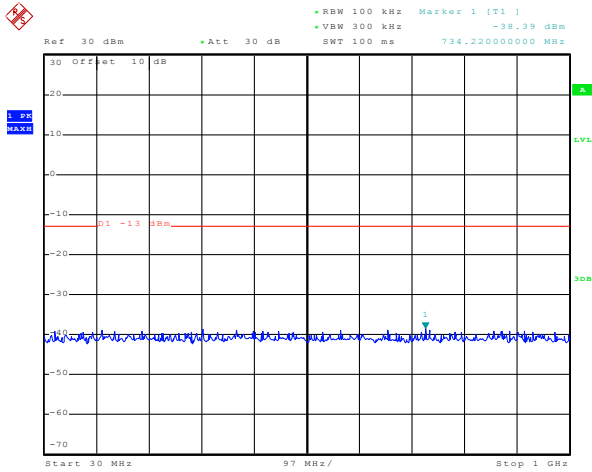

Date: 26.NOV.2015 22:54:50

30MHz~1GHz

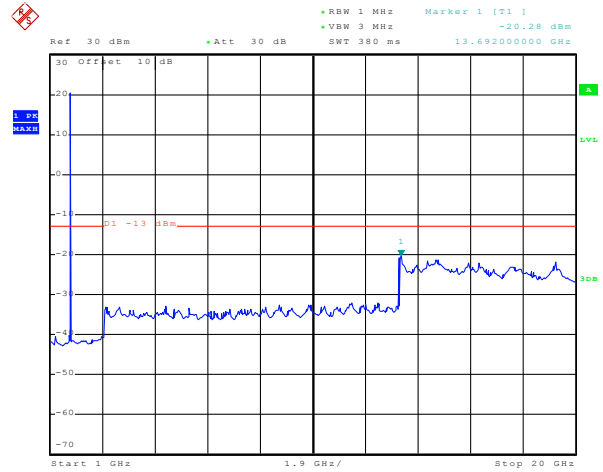

Date: 26.NOV.2015 22:57:28

1GHz~20GHz

Test Mode:	LTE band 4(3MHz QPSK) RB Size 15& RB Offset 0	Test Channel:	Highest channel
------------	--	---------------	-----------------

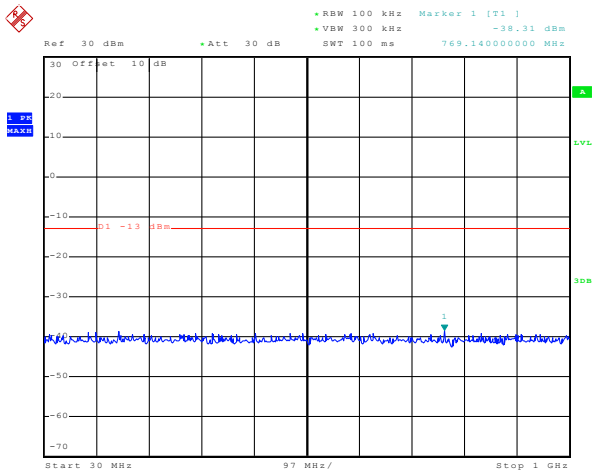

Date: 26.NOV.2015 23:03:41

30MHz~1GHz

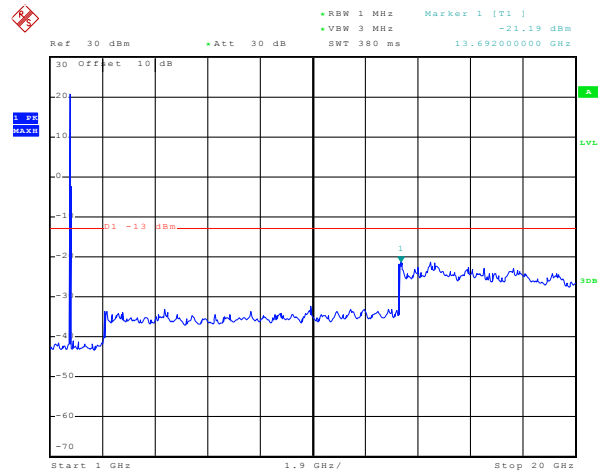

Date: 26.NOV.2015 23:02:36

1GHz~20GHz

5MHz

Test Mode:	LTE band 4(5MHz 16QAM) RB Size 1& RB Offset 0	Test Channel:	Lowest channel
------------	--	---------------	----------------

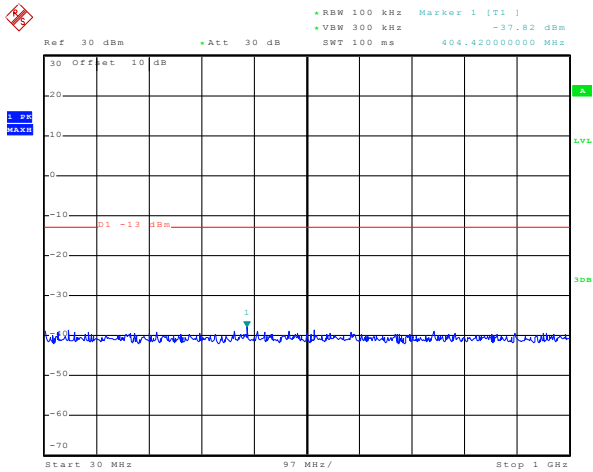

Date: 26.NOV.2015 23:08:57

30MHz~1GHz

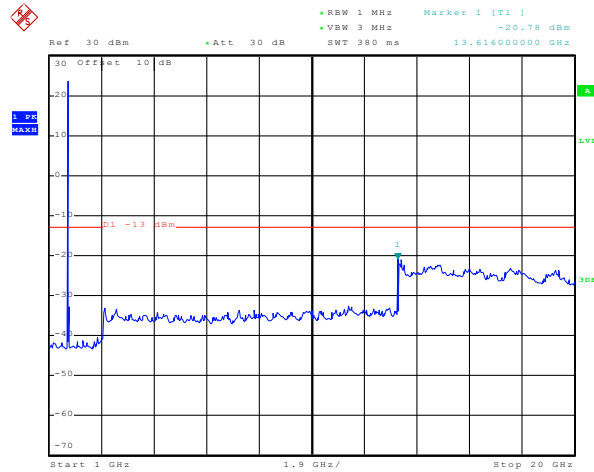

Date: 26.NOV.2015 23:12:58

1GHz~20GHz

Test Mode:	LTE band 4(5MHz 16QAM) RB Size 1& RB Offset 0	Test Channel:	Middle channel
------------	--	---------------	----------------

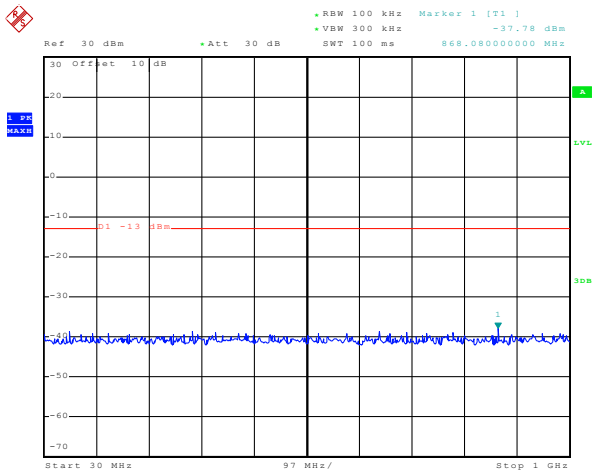

Date: 26.NOV.2015 23:21:10

30MHz~1GHz

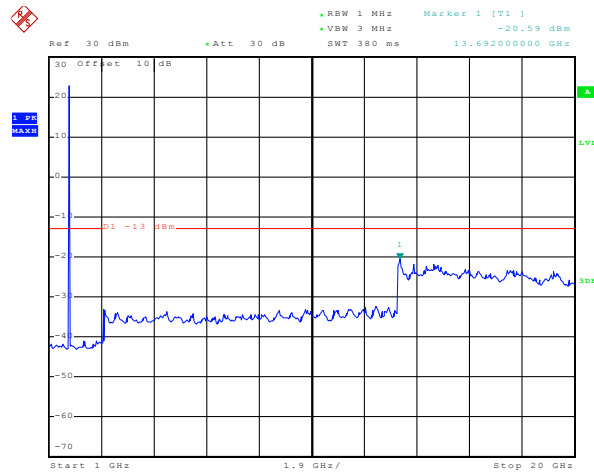

Date: 26.NOV.2015 23:15:51

1GHz~20GHz

Test Mode:	LTE band 4(5MHz 16QAM) RB Size 1& RB Offset 0	Test Channel:	Highest channel
------------	--	---------------	-----------------

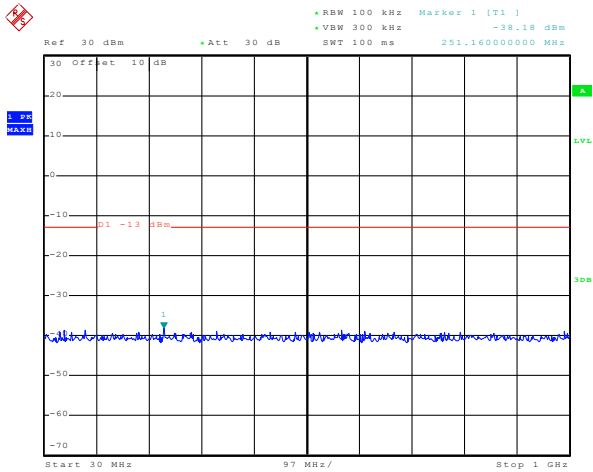

Date: 26.NOV.2015 23:24:12

30MHz~1GHz

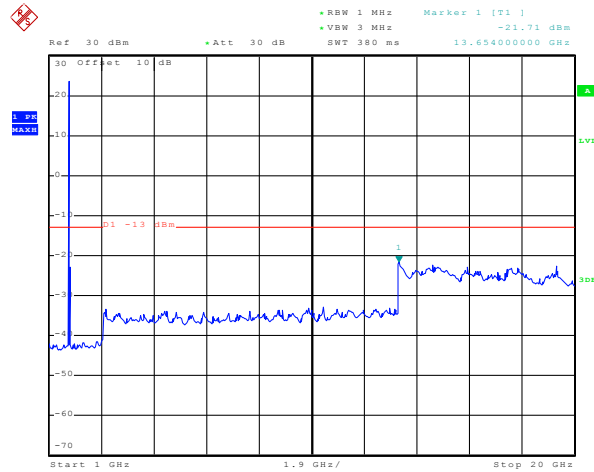

Date: 26.NOV.2015 23:27:19

1GHz~20GHz

Test Mode:	LTE band 4(5MHz 16QAM) RB Size 12& RB Offset 0	Test Channel:	Lowest channel
------------	---	---------------	----------------

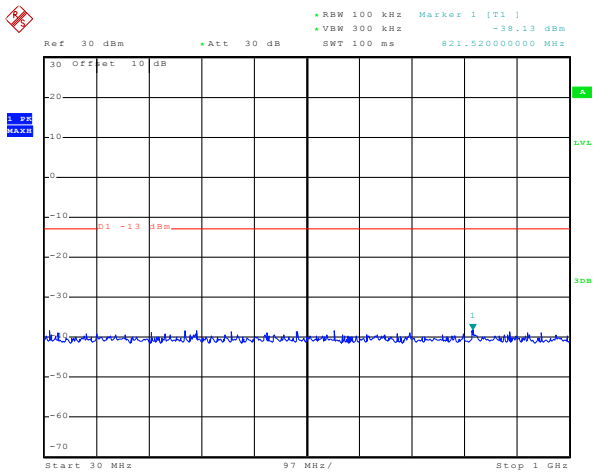

Date: 26.NOV.2015 23:09:27

30MHz~1GHz

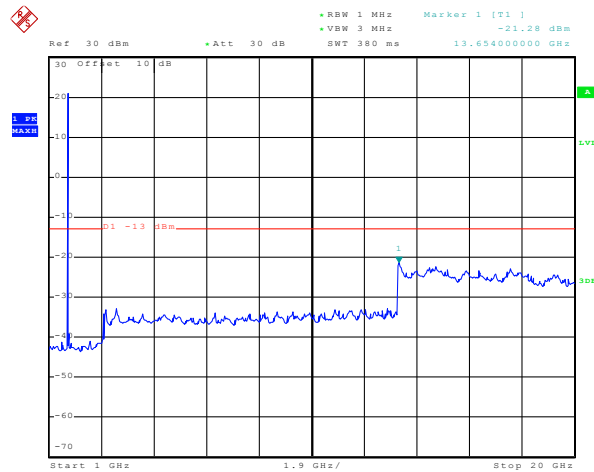

Date: 26.NOV.2015 23:13:23

1GHz~20GHz

Test Mode:	LTE band 4(5MHz 16QAM) RB Size 12& RB Offset 0	Test Channel:	Middle channel
------------	---	---------------	----------------

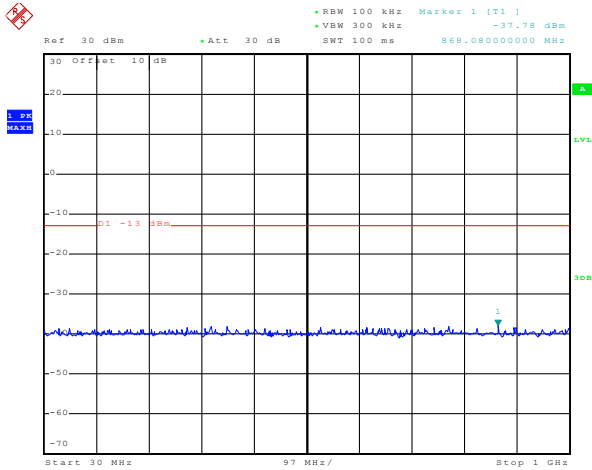

Date: 26.NOV.2015 23:22:27

30MHz~1GHz

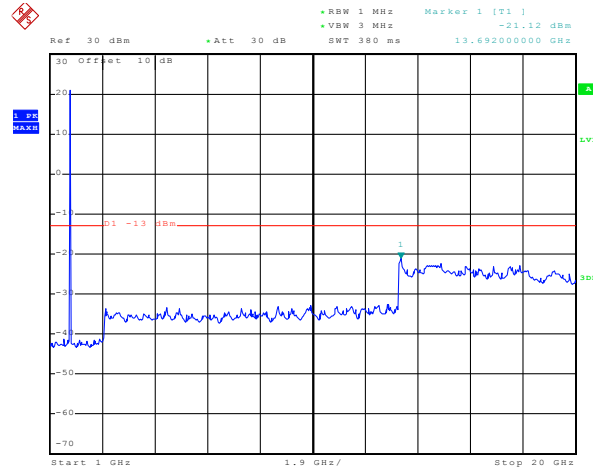

Date: 26.NOV.2015 23:16:17

1GHz~20GHz

Test Mode:	LTE band 4(5MHz 16QAM) RB Size 12& RB Offset 0	Test Channel:	Highest channel
------------	---	---------------	-----------------

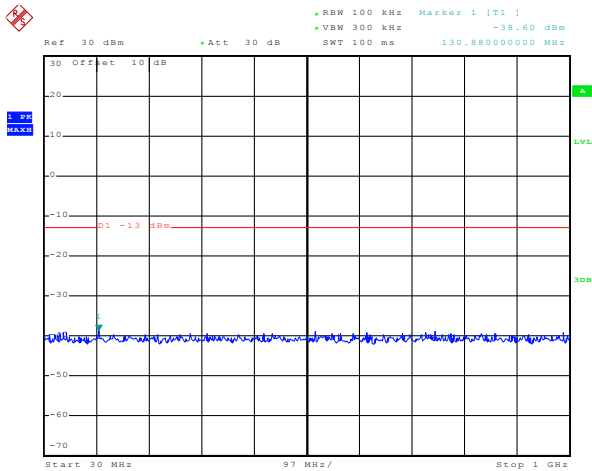

Date: 26.NOV.2015 23:24:31

30MHz~1GHz

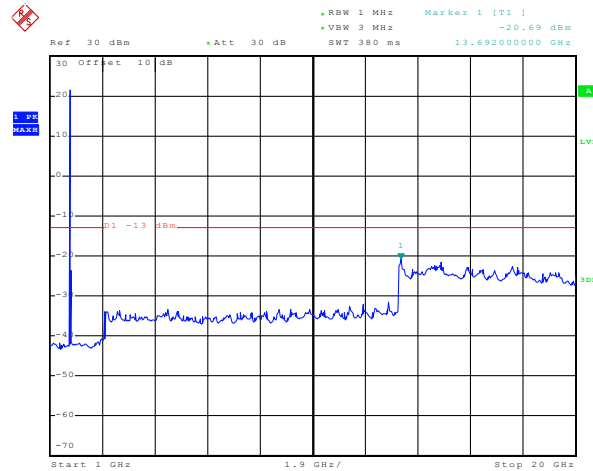

Date: 26.NOV.2015 23:27:52

1GHz~20GHz

Test Mode:	LTE band 4(5MHz 16QAM) RB Size 25& RB Offset 0	Test Channel:	Lowest channel
------------	---	---------------	----------------

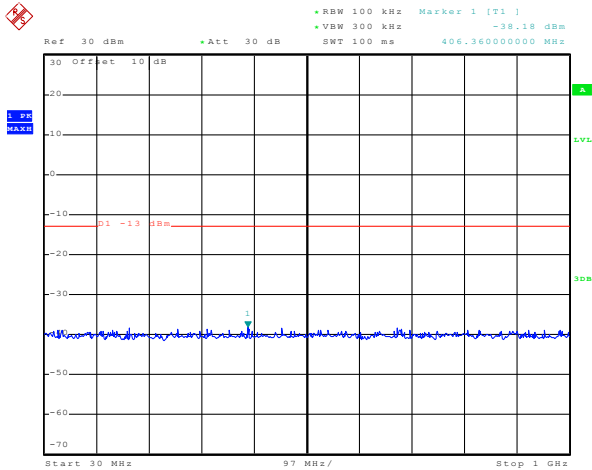

Date: 26.NOV.2015 23:10:40

30MHz~1GHz

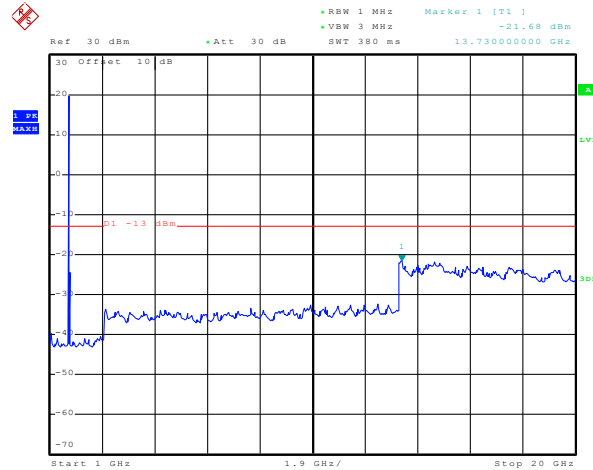

Date: 26.NOV.2015 23:11:47

1GHz~20GHz

Test Mode:	LTE band 4(5MHz 16QAM) RB Size 25& RB Offset 0	Test Channel:	Middle channel
------------	---	---------------	----------------

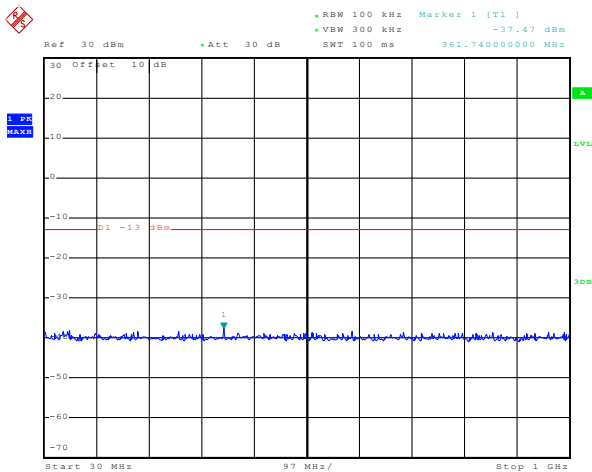

Date: 26.NOV.2015 23:20:05

30MHz~1GHz

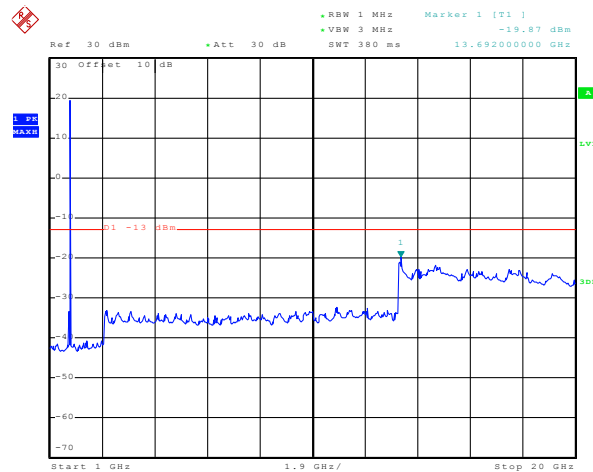

Date: 26.NOV.2015 23:18:23

1GHz~20GHz

Test Mode:	LTE band 4(5MHz 16QAM) RB Size 25& RB Offset 0	Test Channel:	Highest channel
------------	---	---------------	-----------------

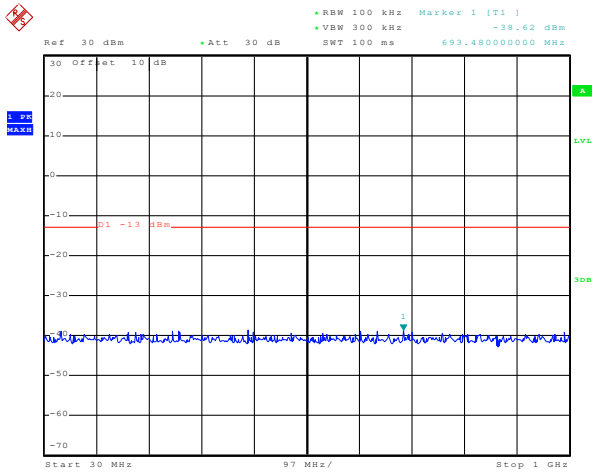

Date: 26.NOV.2015 23:25:18

30MHz~1GHz

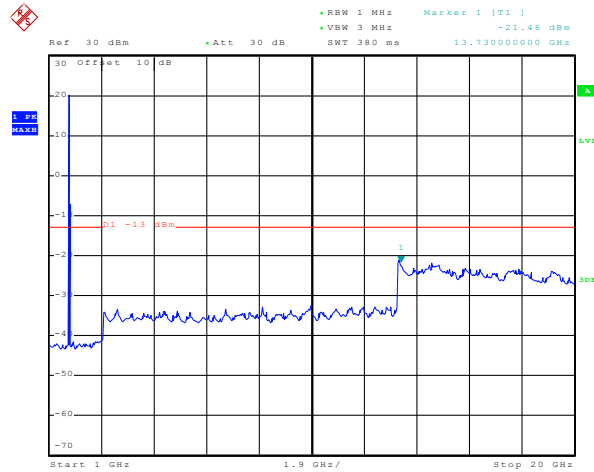

Date: 26.NOV.2015 23:26:13

1GHz~20GHz

Test Mode:	LTE band 4(5MHz QPSK) RB Size 1& RB Offset 0	Test Channel:	Lowest channel
------------	---	---------------	----------------

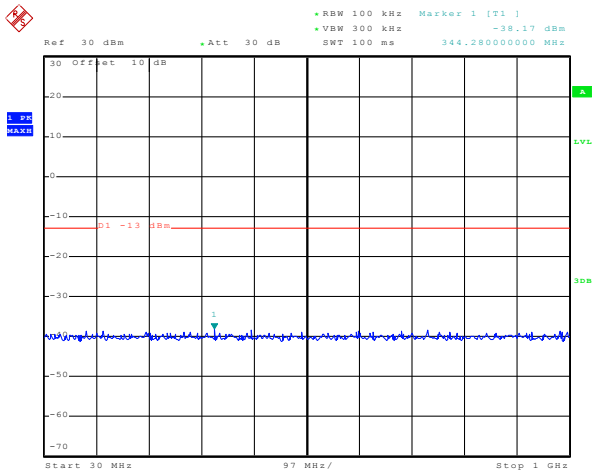

Date: 26.NOV.2015 23:08:38

30MHz~1GHz

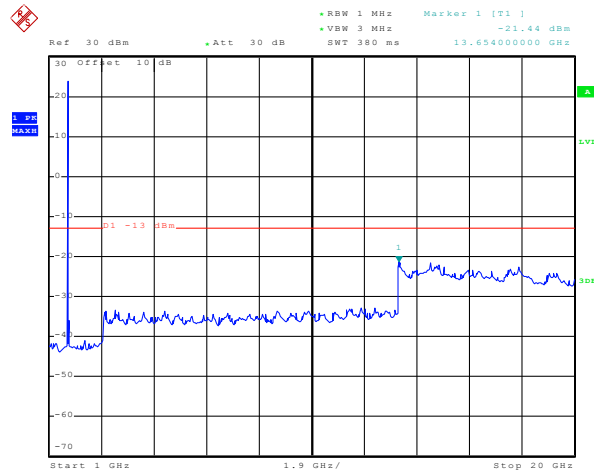

Date: 26.NOV.2015 23:12:31

1GHz~20GHz

Test Mode:	LTE band 4(5MHz QPSK) RB Size 1& RB Offset 0	Test Channel:	Middle channel
------------	---	---------------	----------------

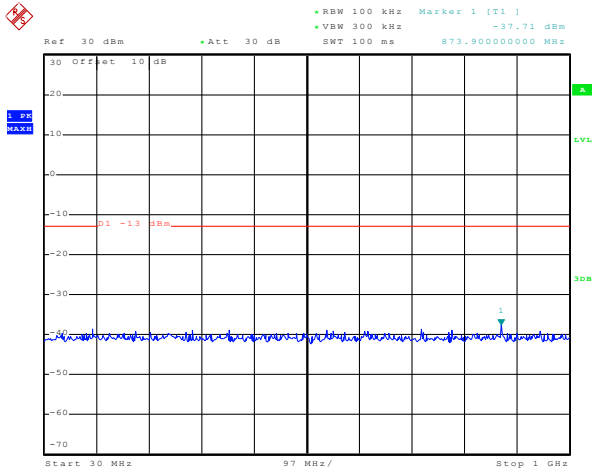

Date: 26.NOV.2015 23:20:53

30MHz~1GHz

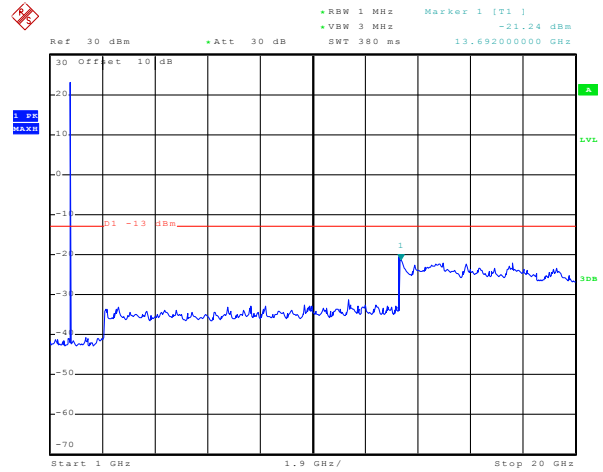

Date: 26.NOV.2015 23:15:14

1GHz~20GHz

Test Mode:	LTE band 4(5MHz QPSK) RB Size 1& RB Offset 0	Test Channel:	Highest channel
------------	---	---------------	-----------------

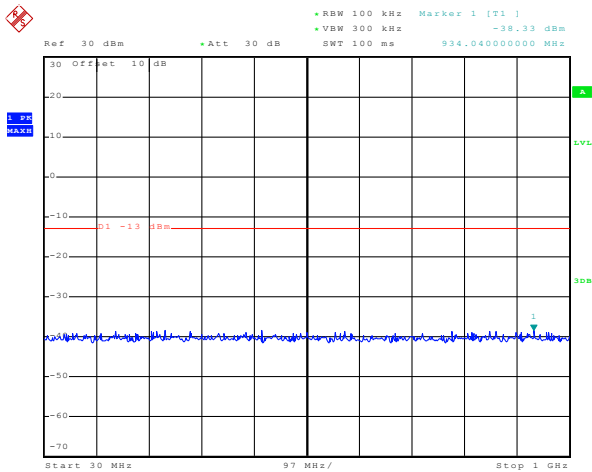

Date: 26.NOV.2015 23:23:50

30MHz~1GHz

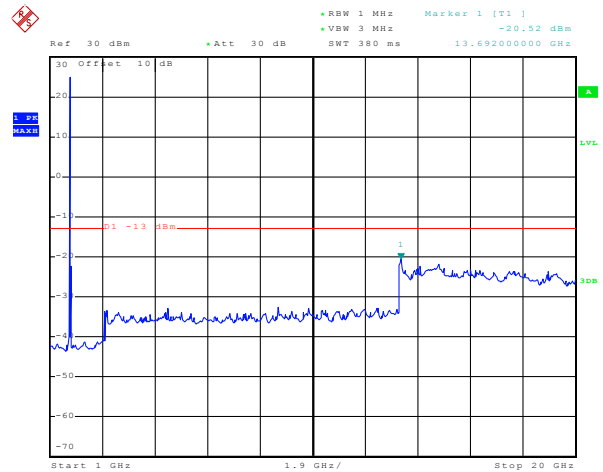

Date: 26.NOV.2015 23:26:58

1GHz~20GHz

Test Mode:	LTE band 4(5MHz QPSK) RB Size 12& RB Offset 0	Test Channel:	Lowest channel
------------	--	---------------	----------------

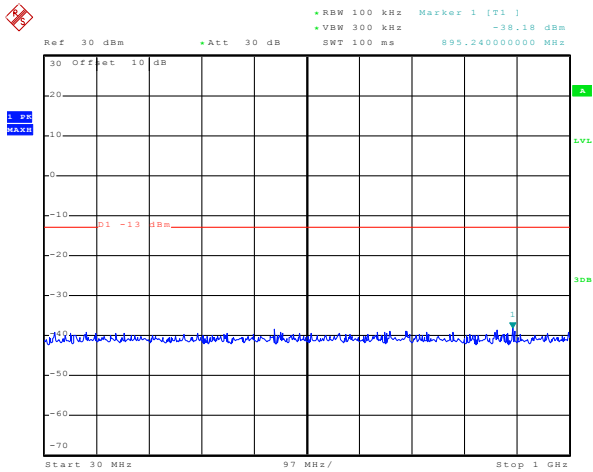

Date: 26.NOV.2015 23:09:43

30MHz~1GHz

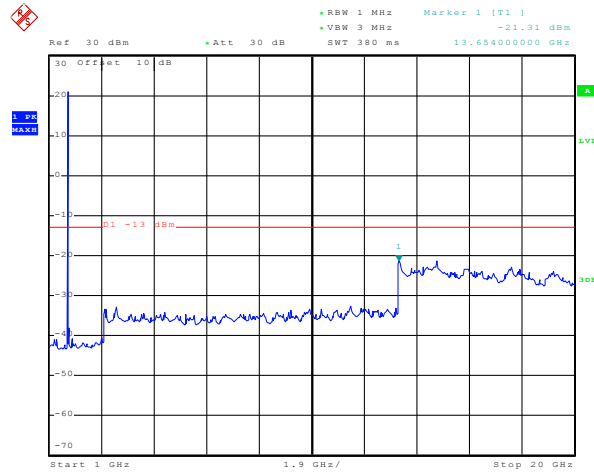

Date: 26.NOV.2015 23:13:46

1GHz~20GHz

Test Mode:	LTE band 4(5MHz QPSK) RB Size 12& RB Offset 0	Test Channel:	Middle channel
------------	--	---------------	----------------

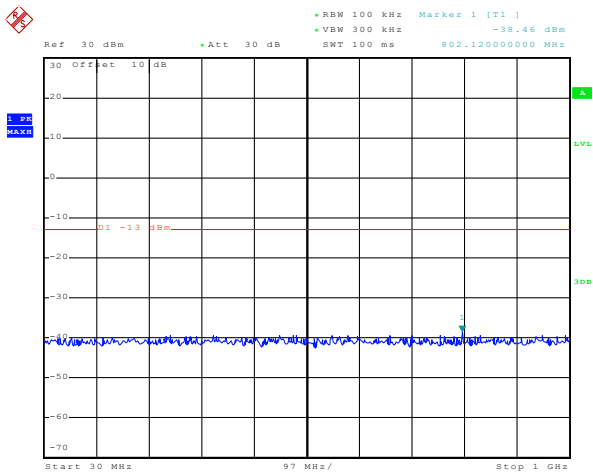

Date: 26.NOV.2015 23:22:44

30MHz~1GHz

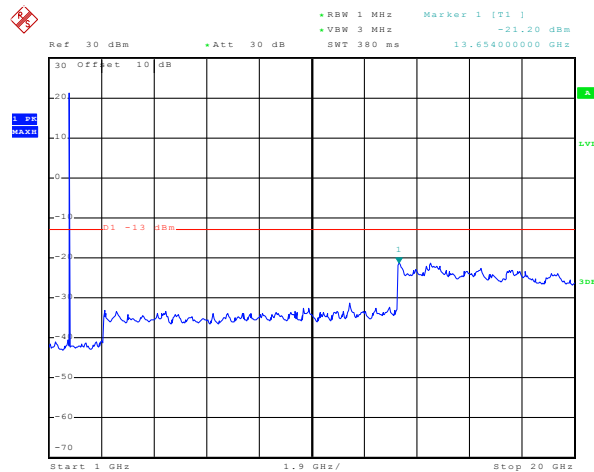

Date: 26.NOV.2015 23:17:18

1GHz~20GHz

Test Mode:	LTE band 4(5MHz QPSK) RB Size 12& RB Offset 0	Test Channel:	Highest channel
------------	--	---------------	-----------------

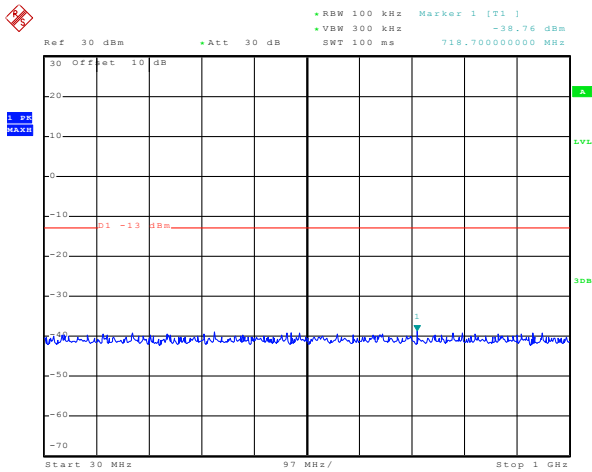

Date: 26.NOV.2015 23:24:51

30MHz~1GHz

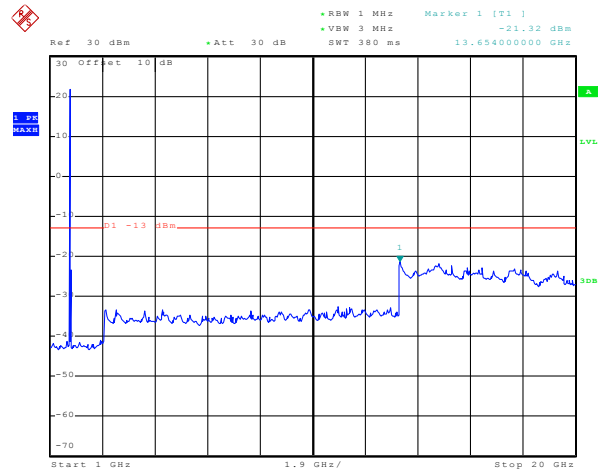

Date: 26.NOV.2015 23:28:20

1GHz~20GHz

Test Mode:	LTE band 4(5MHz QPSK) RB Size 25& RB Offset 0	Test Channel:	Lowest channel
------------	--	---------------	----------------

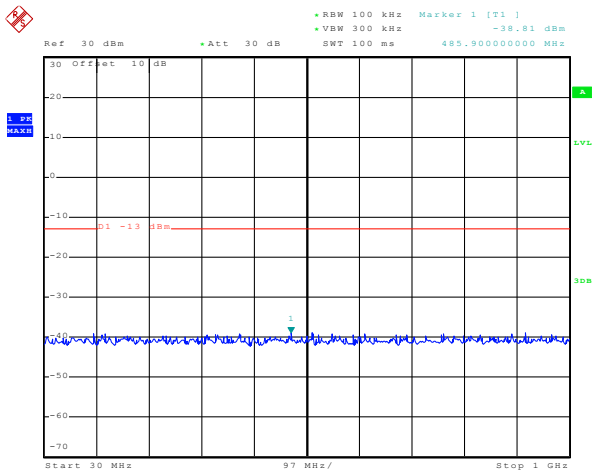

Date: 26.NOV.2015 23:10:02

30MHz~1GHz

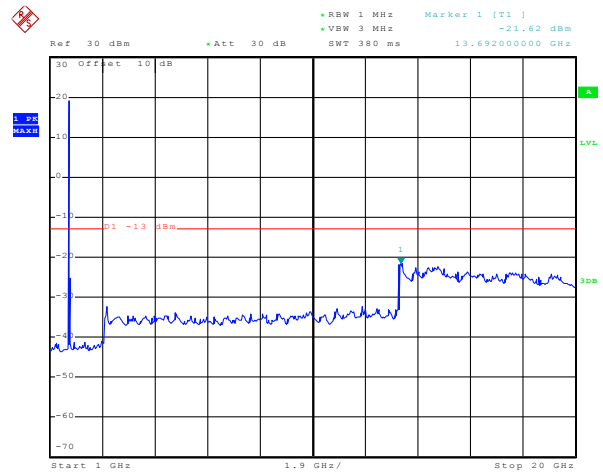

Date: 26.NOV.2015 23:12:09

1GHz~20GHz

Test Mode:	LTE band 4(5MHz QPSK) RB Size 25& RB Offset 0	Test Channel:	Middle channel
------------	--	---------------	----------------

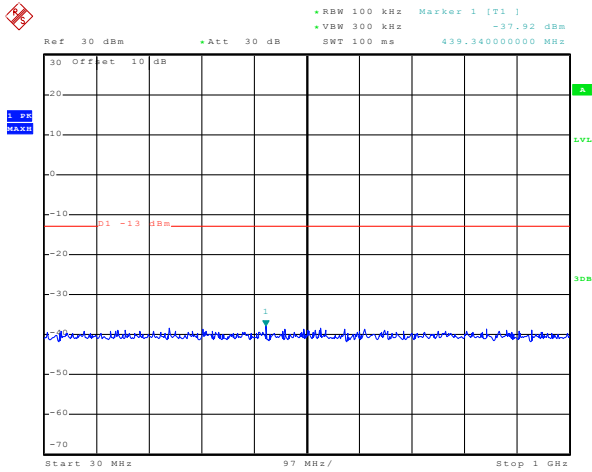

Date: 26.NOV.2015 23:20:35

30MHz~1GHz

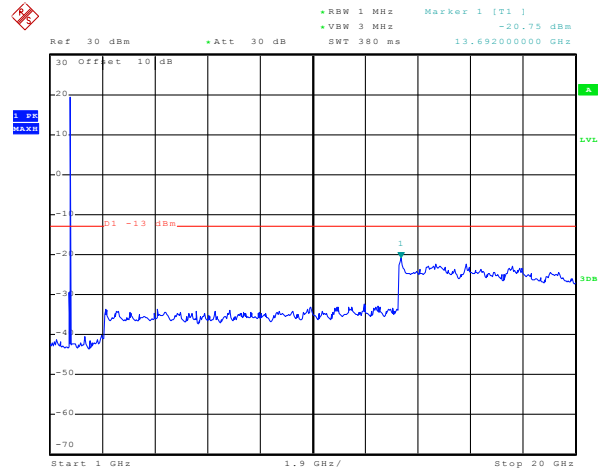

Date: 26.NOV.2015 23:17:50

1GHz~20GHz

Test Mode:	LTE band 4(5MHz QPSK) RB Size 25& RB Offset 0	Test Channel:	Highest channel
------------	--	---------------	-----------------

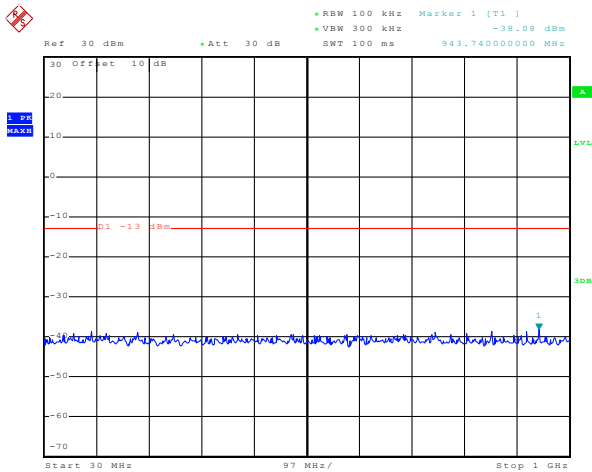

Date: 26.NOV.2015 23:25:04

30MHz~1GHz

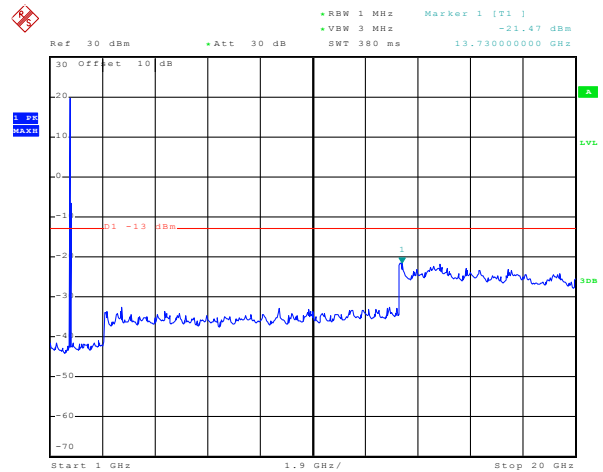

Date: 26.NOV.2015 23:26:31

1GHz~20GHz

10MHz

Test Mode:	LTE band 4(10MHz 16QAM) RB Size 1& RB Offset 0	Test Channel:	Lowest channel
------------	---	---------------	----------------

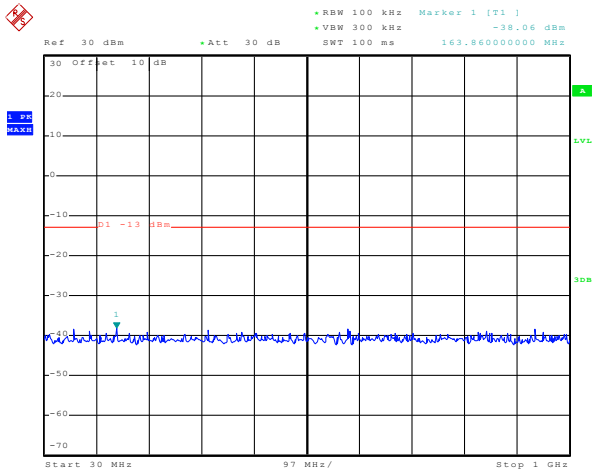

Date: 26.NOV.2015 23:35:26

30MHz~1GHz

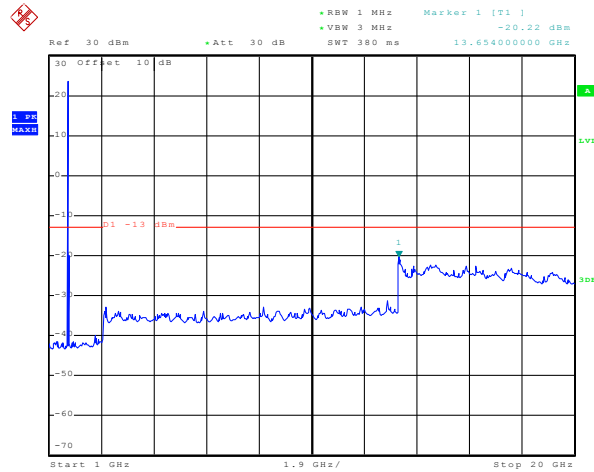

Date: 26.NOV.2015 23:30:45

1GHz~20GHz

Test Mode:	LTE band 4(10MHz 16QAM) RB Size 1& RB Offset 0	Test Channel:	Middle channel
------------	---	---------------	----------------

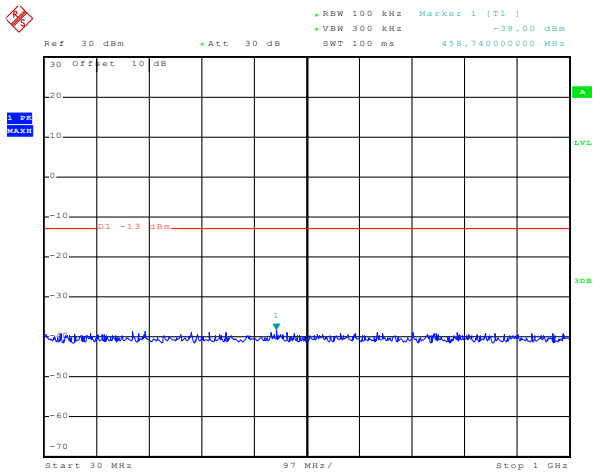

Date: 26.NOV.2015 23:40:59

30MHz~1GHz

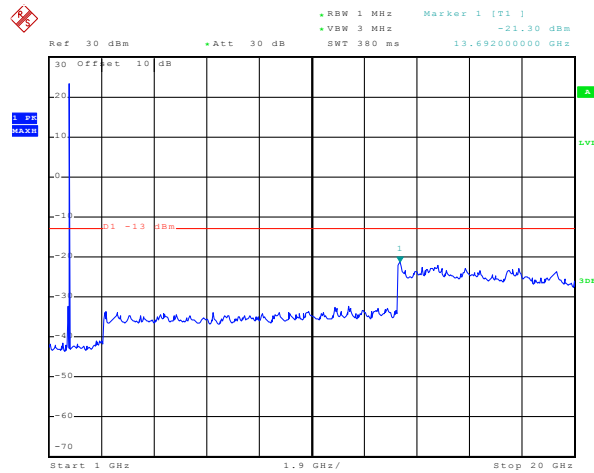

Date: 26.NOV.2015 23:44:24

1GHz~20GHz

Test Mode:	LTE band 4(10MHz 16QAM) RB Size 1& RB Offset 0	Test Channel:	Highest channel
------------	---	---------------	-----------------

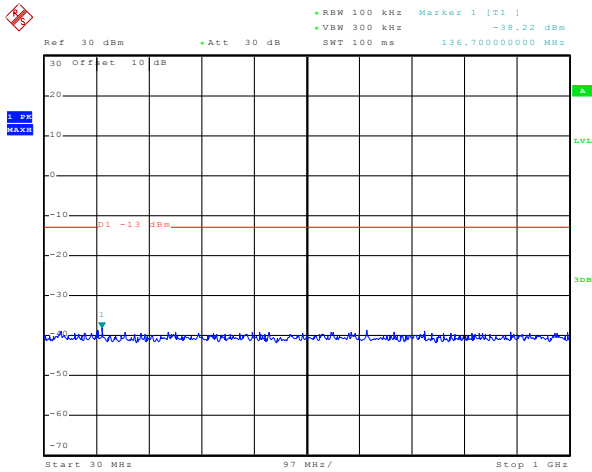

Date: 26.NOV.2015 23:50:46

30MHz~1GHz

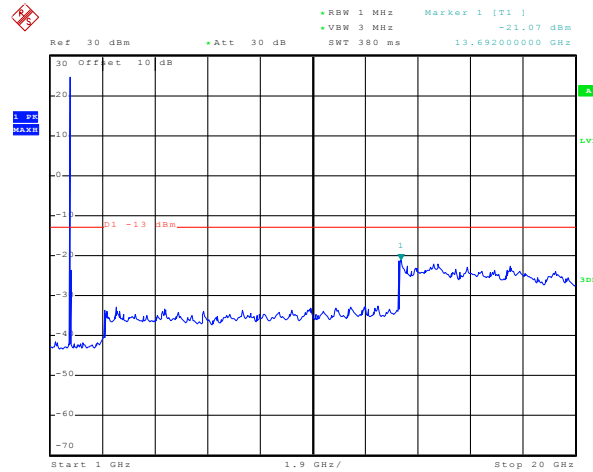

Date: 26.NOV.2015 23:46:38

1GHz~20GHz

Test Mode:	LTE band 4(10MHz 16QAM) RB Size 25& RB Offset 0	Test Channel:	Lowest channel
------------	--	---------------	----------------

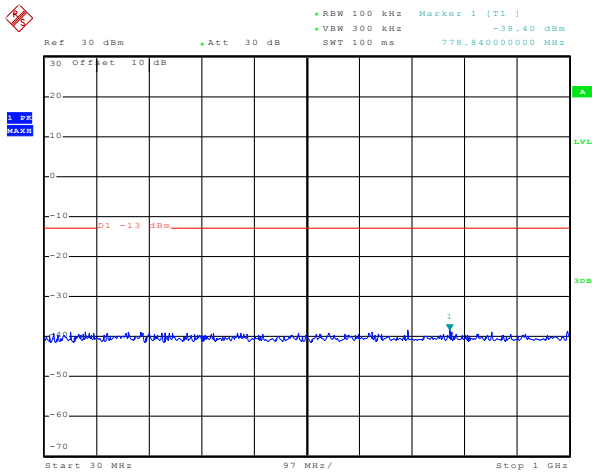

Date: 26.NOV.2015 23:37:06

30MHz~1GHz

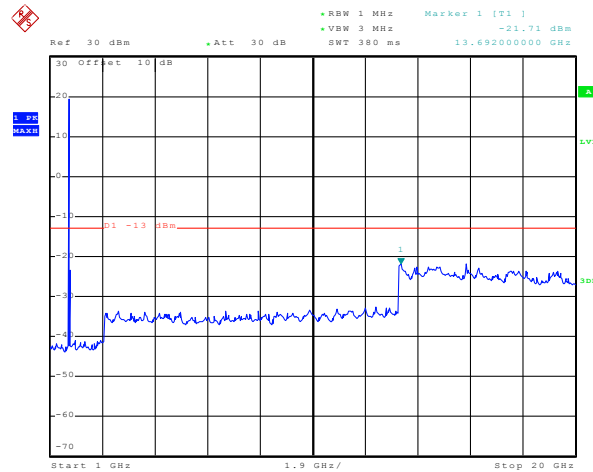

Date: 26.NOV.2015 23:31:19

1GHz~20GHz