

# TEST REPORT

**FCC ID: 2AE2DLSSM008**

**Product: Bluetooth Selfie Stick**

**Model No.: LS-SM008**

**Additional Model: APPSHOT-SN**

**Trade Mark: lionstar™**

**Report No.: TCT150601E011**

**Issued Date: June 17, 2015**

Issued for:

**Shenzhen Laishixing Technology Co., LTD  
918-919 Room Huangjia Center Building, Donghuan 1st Road,  
Shangyousong Village, Longhua District, Shenzhen, China**

Issued By:

**Shenzhen Tongce Testing Lab.  
1F, Leinuo Watch Building, Fuyong Town, Baoan Dist, Shenzhen, China  
TEL: +86-755-27673339  
FAX: +86-755-27673332**

**Note:** This report shall not be reproduced except in full, without the written approval of Shenzhen Tongce Testing Lab.

This document may be altered or revised by Shenzhen Tongce Testing Lab. personnel only, and shall be noted in the revision section of the document. The test results in the report only apply to the tested sample.

**TABLE OF CONTENTS**

<b>1. Test Certification.....</b>	<b>3</b>
<b>2. Test Result Summary .....</b>	<b>4</b>
<b>3. EUT Description.....</b>	<b>5</b>
<b>4. Genera Information.....</b>	<b>6</b>
4.1. Test environment and mode.....	6
4.2. Description of Support Units.....	6
<b>5. Facilities and Accreditations .....</b>	<b>7</b>
5.1. Facilities .....	7
5.2. Location .....	7
5.3. Measurement Uncertainty.....	7
<b>6. Test Results and Measurement Data .....</b>	<b>8</b>
6.1. Antenna requirement .....	8
6.2. Conducted Emission.....	9
6.3. Conducted Output Power .....	13
6.4. 20dB Occupy Bandwidth .....	16
6.5. Carrier Frequencies Separation .....	19
6.6. Hopping Channel Number .....	22
6.7. Dwell Time.....	24
6.8. Pseudorandom Frequency Hopping Sequence.....	26
6.9. Conducted Band Edge Measurement .....	27
6.10. Conducted Spurious Emission Measurement.....	29
6.11. Radiated Spurious Emission Measurement .....	31
<b>Appendix A: Photographs of Test Setup</b>	
<b>Appendix B: Photographs of EUT</b>	

## 1. Test Certification

<b>Product:</b>	Bluetooth Selfie Stick
<b>Model No.:</b>	LS-SM008
<b>Additional Model:</b>	APPSHOT-SN
<b>Applicant:</b>	Shenzhen Laishixing Technology Co., LTD
<b>Address:</b>	918-919 Room Huangjia Center Building, Donghuan 1st Road, Shangyousong Village, Longhua District, Shenzhen, China
<b>Manufacturer:</b>	Shenzhen Laishixing Technology Co., LTD
<b>Address:</b>	918-919 Room Huangjia Center Building, Donghuan 1st Road, Shangyousong Village, Longhua District, Shenzhen, China
<b>Date of Test:</b>	June 01 – June 16, 2015
<b>Applicable Standards:</b>	FCC CFR Title 47 Part 15 Subpart C Section 15.247

The above equipment has been tested by Shenzhen Tongce Testing Lab. and found compliance with the requirements set forth in the technical standards mentioned above. The results of testing in this report apply only to the product/system, which was tested. Other similar equipment will not necessarily produce the same results due to production tolerance and measurement uncertainties.

Tested By:



Neil Wong

Date:

June 16, 2015

Reviewed By:



Joe Zhou

Date:

June 17, 2015

Approved By:



Tomsin

Date:

June 17, 2015

## 2. Test Result Summary

Requirement	CFR 47 Section	Result
Antenna Requirement	§15.203/§15.247 (c)	PASS
AC Power Line Conducted Emission	§15.207	PASS
Conducted Peak Output Power	§15.247 (b)(1)	PASS
20dB Occupied Bandwidth	§15.247 (a)(1)	PASS
Carrier Frequencies Separation	§15.247 (a)(1)	PASS
Hopping Channel Number	§15.247 (a)(1)	PASS
Dwell Time	§15.247 (a)(1)	PASS
Radiated Emission	§15.205/§15.209	PASS
Band Edge	§15.247(d)	PASS

**Note:**

1. PASS: Test item meets the requirement.
2. Fail: Test item does not meet the requirement.
3. N/A: Test case does not apply to the test object.
4. The test result judgment is decided by the limit of test standard.

### 3. EUT Description

<b>Product Name:</b>	Bluetooth Selfie Stick
<b>Model :</b>	LS-SM008
<b>Additional Model:</b>	APPSHOT-SN
<b>Trade Mark:</b>	
<b>BT Version:</b>	V3.0
<b>Operation Frequency:</b>	2402MHz~2480MHz
<b>Transfer Rate:</b>	1Mbits/s
<b>Number of Channel:</b>	79
<b>Modulation Type:</b>	GFSK
<b>Modulation Technology:</b>	FHSS
<b>Antenna Type:</b>	Internal Antenna
<b>Antenna Gain:</b>	0.94dBi
<b>Power Supply:</b>	Rechargeable Li-ion Battery DC3.7V
<b>Remark:</b>	The model LS-SM008 and model APPSHOT-SN are identical in interior structure, electrical circuits and components, and just model names are different for the marketing requirement.

#### Operation Frequency each of channel for GFSK

Channel	Frequency	Channel	Frequency	Channel	Frequency	Channel	Frequency
0	2402MHz	20	2422MHz	40	2442MHz	60	2462MHz
1	2403MHz	21	2423MHz	41	2443MHz	61	2463MHz
...	...	...	...	...	...	...	...
10	2412MHz	30	2432MHz	50	2452MHz	70	2472MHz
11	2413MHz	31	2433MHz	51	2453MHz	71	2473MHz
...	...	...	...	...	...	...	...
18	2420MHz	38	2440MHz	58	2460MHz	78	2480MHz
19	2421MHz	39	2441MHz	59	2461MHz		-

Remark: Channel 0, 39 &78 have been tested for GFSK modulation mode.

## 4. Genera Information

### 4.1. Test environment and mode

Operating Environment:	
Temperature:	25.0 °C
Humidity:	56 % RH
Atmospheric Pressure:	1010 mbar
Test Mode:	
Engineering mode:	Keep the EUT in continuous transmitting by select channel and modulations
<p>The sample was placed 0.8m above the ground plane of 3m chamber. Measurements in both horizontal and vertical polarities were performed. During the test, each emission was maximized by: having the EUT continuously working, investigated all operating modes, rotated about all 3 axis (X, Y &amp; Z) and considered typical configuration to obtain worst position, manipulating interconnecting cables, rotating the turntable, varying antenna height from 1m to 4m in both horizontal and vertical polarizations. The emissions worst-case are shown in Test Results of the following pages.</p>	

### 4.2. Description of Support Units

The EUT has been tested as an independent unit together with other necessary accessories or support units. The following support units or accessories were used to form a representative test configuration during the tests.

Equipment	Model No.	Serial No.	FCC ID	Trade Name
PC	DIPFCG0008HP	/	/	Acer

**Note:**

1. The PC is provided by Testing Lab.
2. All the equipment/cables were placed in the worst-case configuration to maximize the emission during the test.
3. Grounding was established in accordance with the manufacturer's requirements and conditions for the intended use.
4. For conducted measurements (Output Power, 20dB Occupied Bandwidth, Carrier Frequencies Separation, Hopping Channel Number, Dwell Time, Spurious Emissions), the antenna of EUT is connected to the test equipment via temporary antenna connector, the antenna connector is soldered on the antenna port of EUT, and the temporary antenna connector is listed in the Test Instruments.

## 5. Facilities and Accreditations

### 5.1. Facilities

The test facility is recognized, certified, or accredited by the following organizations:

- FCC - Registration No.: 572331

Shenzhen Tongce Testing Lab

The 3m Semi-anechoic chamber has been registered and fully described in a report with the (FCC) Federal Communications Commission. The acceptance letter from the FCC is maintained in our files.

- IC - Registration No.: 10668A-1

The 3m Semi-anechoic chamber of Shenzhen TCT Testing Technology Co., Ltd. has been registered by Certification and Engineering Bureau of Industry Canada for radio equipment testing

- CNAS - Registration No.: CNAS L6165

Shenzhen TCT Testing Technology Co., Ltd. is accredited to ISO/IEC 17025:2005 General Requirements for the Competence of Testing and Calibration laboratories for the competence of testing. The Registration No. is CNAS L6165.

### 5.2. Location

Shenzhen Tongce Testing Lab

Address: 1F, Leinuo Watch Building, Fuyong Town, Baoan Dist, Shenzhen, China

Tel: 86-755-36638142

### 5.3. Measurement Uncertainty

The reported uncertainty of measurement  $y \pm U$ , where expanded uncertainty  $U$  is based on a standard uncertainty multiplied by a coverage factor of  $k=2$ , providing a level of confidence of approximately 95 %.

No.	Item	MU
1	Conducted Emission	$\pm 2.56\text{dB}$
2	RF power, conducted	$\pm 0.12\text{dB}$
3	Spurious emissions, conducted	$\pm 0.11\text{dB}$
4	All emissions, radiated(<1G)	$\pm 3.92\text{dB}$
5	All emissions, radiated(>1G)	$\pm 4.28\text{dB}$
6	Temperature	$\pm 0.1^\circ\text{C}$
7	Humidity	$\pm 1.0\%$



## 6. Test Results and Measurement Data

### 6.1. Antenna requirement

**Standard requirement:**

FCC Part15 C Section 15.203 /247(c)

15.203 requirement:

An intentional radiator shall be designed to ensure that no antenna other than that furnished by the responsible party shall be used with the device. The use of a permanently attached antenna or of an antenna that uses a unique coupling to the intentional radiator, the manufacturer may design the unit so that a broken antenna can be replaced by the user, but the use of a standard antenna jack or electrical connector is prohibited.

15.247(c) (1)(i) requirement:

(i) Systems operating in the 2400-2483.5 MHz band that is used exclusively for fixed. Point-to-point operations may employ transmitting antennas with directional gain greater than 6dBi provided the maximum conducted output power of the intentional radiator is reduced by 1 dB for every 3 dB that the directional gain of the antenna exceeds 6dBi.

**E.U.T Antenna:**

The Bluetooth antenna is an internal antenna which permanently attached, and the best case gain of the antenna is 0.94dBi.

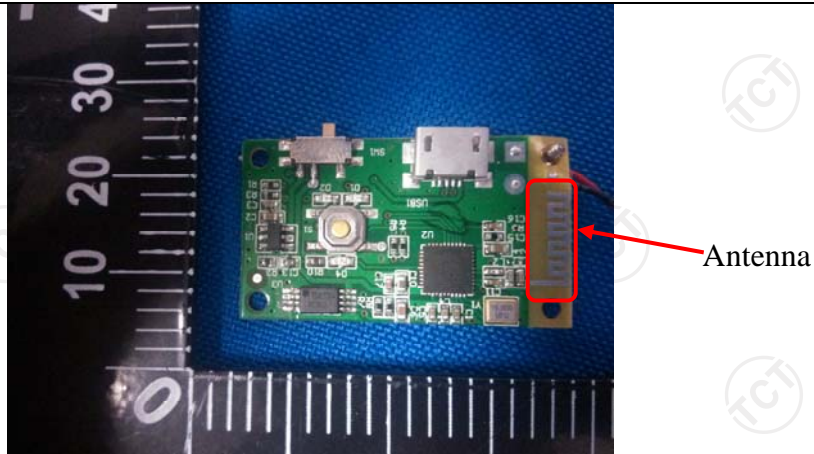



## 6.2. Conducted Emission

### 6.2.1. Test Specification

<b>Test Requirement:</b>	FCC Part15 C Section 15.207														
<b>Test Method:</b>	ANSI C63.4:2009														
<b>Frequency Range:</b>	150 kHz to 30 MHz														
<b>Receiver setup:</b>	RBW=9 kHz, VBW=30 kHz, Sweep time=auto														
<b>Limits:</b>	<table border="1"> <thead> <tr> <th rowspan="2">Frequency range (MHz)</th> <th colspan="2">Limit (dBuV)</th> </tr> <tr> <th>Quasi-peak</th> <th>Average</th> </tr> </thead> <tbody> <tr> <td>0.15-0.5</td> <td>66 to 56*</td> <td>56 to 46*</td> </tr> <tr> <td>0.5-5</td> <td>56</td> <td>46</td> </tr> <tr> <td>5-30</td> <td>60</td> <td>50</td> </tr> </tbody> </table>	Frequency range (MHz)	Limit (dBuV)		Quasi-peak	Average	0.15-0.5	66 to 56*	56 to 46*	0.5-5	56	46	5-30	60	50
Frequency range (MHz)	Limit (dBuV)														
	Quasi-peak	Average													
0.15-0.5	66 to 56*	56 to 46*													
0.5-5	56	46													
5-30	60	50													
<b>Test Setup:</b>	<p><i>Remark</i> E.U.T: Equipment Under Test LISN: Line Impedance Stabilization Network Test table height=0.8m</p>														
<b>Test Mode:</b>	Reference to item 4.1														
<b>Test Procedure:</b>	<ol style="list-style-type: none"> <li>1. The E.U.T and simulators are connected to the main power through a line impedance stabilization network (L.I.S.N.). This provides a 50ohm/50uH coupling impedance for the measuring equipment.</li> <li>2. The peripheral devices are also connected to the main power through a LISN that provides a 50ohm/50uH coupling impedance with 50ohm termination. (Please refer to the block diagram of the test setup and photographs).</li> <li>3. Both sides of A.C. line are checked for maximum conducted interference. In order to find the maximum emission, the relative positions of equipment and all of the interface cables must be changed according to ANSI C63.4: 2009 on conducted measurement.</li> </ol>														
<b>Test Result:</b>	PASS														

**6.2.2. Test Instruments**

Conducted Emission Shielding Room Test Site (843)				
Equipment	Manufacturer	Model	Serial Number	Calibration Due
EMI Test Receiver	R&S	ESCS30	100139	Sept. 16, 2015
LISN	Schwarzbeck	NSLK 8126	8126453	Sept. 29, 2015
Coax cable	TCT	CE-05	N/A	Sept.15 , 2015
EMI Test Software	Shurple Technology	EZ-EMC	N/A	N/A

**Note:** The calibration interval of the above test instruments is 12 months and the calibrations are traceable to international system unit (SI).

6.2.3. Test data

Please refer to following diagram for individual  
Conducted Emission on Line Terminal of the power line (150 kHz to 30MHz)

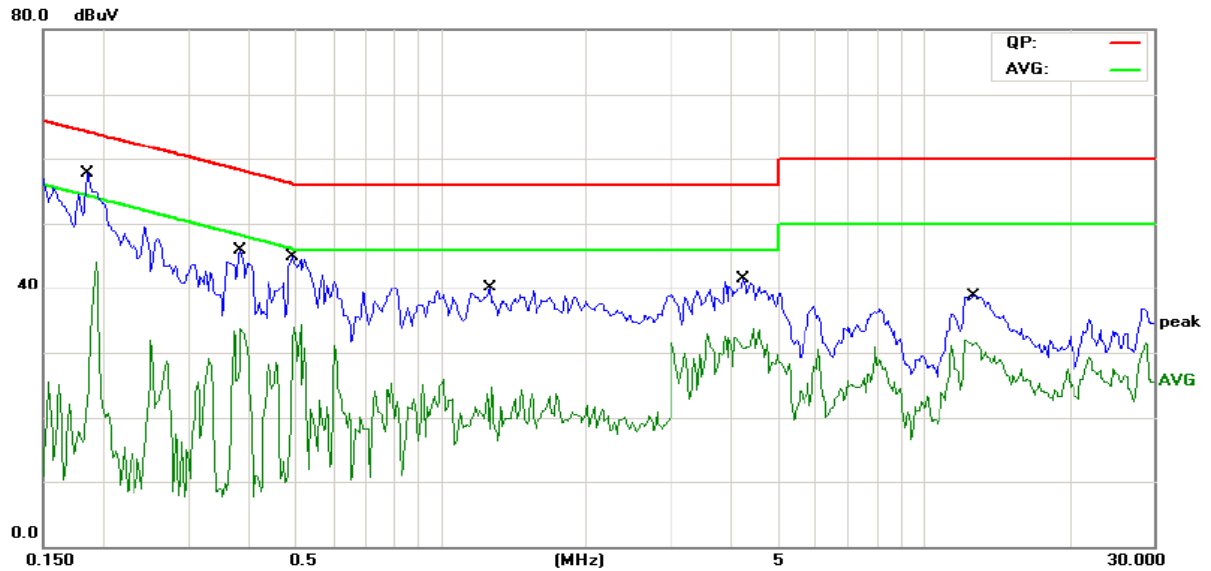

Site Chamber #2 Phase: **L1** Temperature: 25 (C)  
Limit: FCC PART15 Conduction(QP) Power: AC 120V/60Hz Humidity: 56 %

No.	Mk.	Freq. MHz	Reading Level dBuV	Correct Factor dB	Measure- ment dBuV	Limit dBuV	Over dB	Detector	Comment
1	*	0.1852	41.37	11.48	52.85	64.24	-11.39	QP	
2		0.1852	26.51	11.48	37.99	54.24	-16.25	AVG	
3		0.3844	29.51	11.36	40.87	58.18	-17.31	QP	
4		0.3844	16.72	11.36	28.08	48.18	-20.10	AVG	
5		0.4938	28.18	11.30	39.48	56.10	-16.62	QP	
6		0.4938	14.90	11.30	26.20	46.10	-19.90	AVG	
7		1.2633	20.73	11.31	32.04	56.00	-23.96	QP	
8		1.2633	5.24	11.31	16.55	46.00	-29.45	AVG	
9		4.2266	24.79	10.88	35.67	56.00	-20.33	QP	
10		4.2266	12.90	10.88	23.78	46.00	-22.22	AVG	
11		12.6602	21.91	11.41	33.32	60.00	-26.68	QP	
12		12.6602	13.81	11.41	25.22	50.00	-24.78	AVG	

**Note:**

Freq. = Emission frequency in MHz

Reading level (dBuV) = Receiver reading

Corr. Factor (dB) = Antenna factor + Cable loss

Measurement (dBuV) = Reading level (dBuV) + Corr. Factor (dB)

Limit (dBuV) = Limit stated in standard

Margin (dB) = Measurement (dBuV) – Limits (dBuV)

Q.P. =Quasi-Peak

AVG =average

\* is meaning the worst frequency has been tested in the frequency range 150 kHz to 30MHz

**Conducted Emission on Neutral Terminal of the power line (150 kHz to 30MHz)**

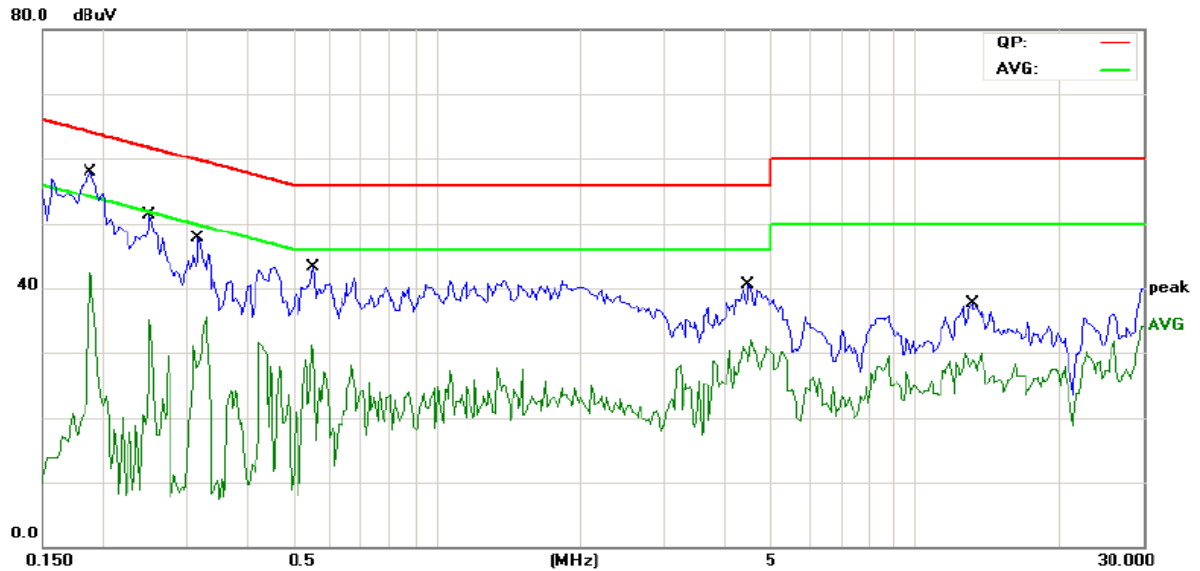

Site Chamber #2 Phase: **N** Temperature: 25 (C)  
Limit: FCC PART15 Conduction(QP) Power: AC 120V/60Hz Humidity: 56 %

No.	Mk.	Freq. MHz	Reading Level dBuV	Correct Factor dB	Measure- ment dBuV	Limit dBuV	Over dB	Detector	Comment
1	*	0.1891	42.99	11.47	54.46	64.07	-9.61	QP	
2		0.1891	27.24	11.47	38.71	54.07	-15.36	AVG	
3		0.2516	34.63	11.43	46.06	61.70	-15.64	QP	
4		0.2516	19.26	11.43	30.69	51.70	-21.01	AVG	
5		0.3180	30.40	11.40	41.80	59.76	-17.96	QP	
6		0.3180	15.43	11.40	26.83	49.76	-22.93	AVG	
7		0.5523	28.32	11.27	39.59	56.00	-16.41	QP	
8		0.5523	13.73	11.27	25.00	46.00	-21.00	AVG	
9		4.4844	24.14	10.80	34.94	56.00	-21.06	QP	
10		4.4844	12.19	10.80	22.99	46.00	-23.01	AVG	
11		13.1289	21.69	11.43	33.12	60.00	-26.88	QP	
12		13.1289	12.76	11.43	24.19	50.00	-25.81	AVG	

**Note1:**

- Freq. = Emission frequency in MHz
- Reading level (dBuV) = Receiver reading
- Corr. Factor (dB) = Antenna factor + Cable loss
- Measurement (dBuV) = Reading level (dBuV) + Corr. Factor (dB)
- Limit (dBuV) = Limit stated in standard
- Margin (dB) = Measurement (dBuV) – Limits (dBuV)
- Q.P. =Quasi-Peak
- AVG =average
- \* is meaning the worst frequency has been tested in the frequency range 150 kHz to 30MHz.

**Note2:**

Measurements were conducted in all three channels (high, middle, low) of the modulation GFSK, and the worst case Mode (Highest channel and GFSK was submitted only).

### 6.3. Conducted Output Power

#### 6.3.1. Test Specification

<b>Test Requirement:</b>	FCC Part15 C Section 15.247 (b)(3)
<b>Test Method:</b>	ANSI C63.4:2009 and DA00-705
<b>Limit:</b>	Section 15.247 (b) The maximum peak conducted output power of the intentional radiator shall not exceed the following: (1) For frequency hopping systems operating in the 2400-2483.5 MHz band employing at least 75 non-overlapping hopping channels, and all frequency hopping systems in the 5725-5850 MHz band: 1 watt. For all other frequency hopping systems in the 2400-2483.5 MHz band 0.125 watts.
<b>Test Setup:</b>	 <p style="text-align: center;">Spectrum Analyzer                      EUT</p>
<b>Test Mode:</b>	Transmitting mode with modulation
<b>Test Procedure:</b>	<p>Use the following spectrum analyzer settings:</p> <p>Span = approximately 5 times the 20 dB bandwidth, centered on a hopping channel</p> <p>RBW &gt; the 20 dB bandwidth of the emission being measured</p> <p>VBW ≥ RBW</p> <p>Sweep = auto</p> <p>Detector function = peak</p> <p>Trace = max hold</p> <p>Allow the trace to stabilize.</p> <p>Use the marker-to-peak function to set the marker to the peak of the emission.</p>
<b>Test Result:</b>	PASS

#### 6.3.2. Test Instruments

Equipment	Manufacturer	Model	Serial Number	Calibration Due
Spectrum Analyzer	R&S	FSU	200054	Sept. 15, 2015
RF Cable	TCT	RE-06	N/A	Sept.15 , 2015
Antenna Connector	TCT	RFC-01	N/A	Sept.15 , 2015

**Note:** The calibration interval of the above test instruments is 12 months and the calibrations are traceable to international system unit (SI).

**6.3.3. Test Data**

GFSK mode			
Test channel	Peak Output Power (dBm)	Limit (dBm)	Result
Lowest	-0.53	21.00	PASS
Middle	0.44	21.00	PASS
Highest	0.68	21.00	PASS

Test plots as follows:

Lowest channel

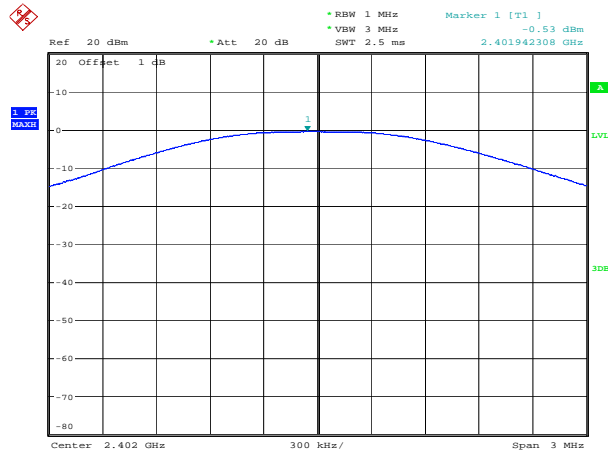

Date: 16.JUN.2015 11:16:05

Middle channel

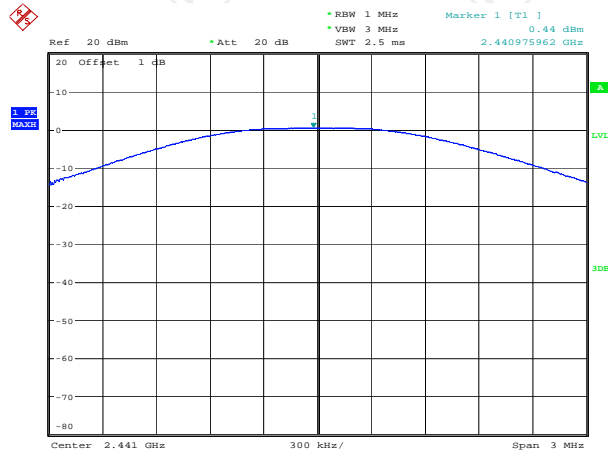

Date: 16.JUN.2015 11:17:52

Highest channel

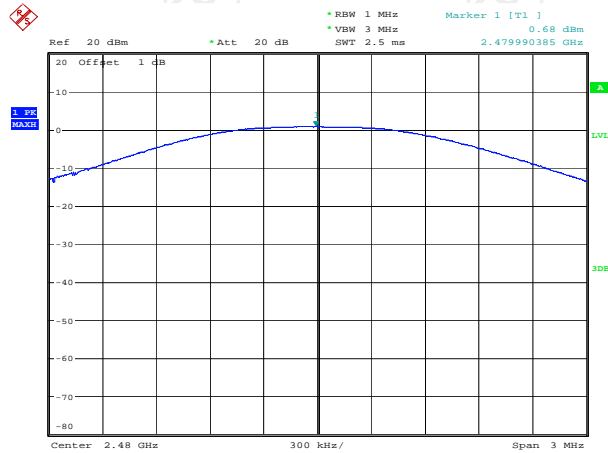

Date: 16.JUN.2015 11:18:21



## 6.4.20dB Occupy Bandwidth

### 6.4.1. Test Specification

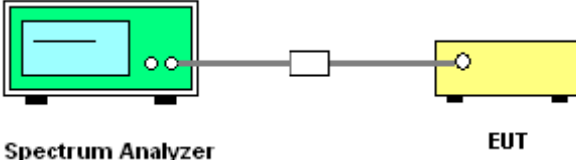
<b>Test Requirement:</b>	FCC Part15 C Section 15.247 (a)(1)
<b>Test Method:</b>	ANSI C63.4:2009 and DA00-705
<b>Limit:</b>	N/A
<b>Test Setup:</b>	 Spectrum Analyzer    EUT
<b>Test Mode:</b>	Transmitting mode with modulation
<b>Test Procedure:</b>	<ol style="list-style-type: none"> <li>1. The testing follows FCC Public Notice DA 00-705 Measurement Guidelines.</li> <li>2. The RF output of EUT was connected to the spectrum analyzer by RF cable and attenuator. The path loss was compensated to the results for each measurement.</li> <li>3. Set to the maximum power setting and enable the EUT transmit continuously.</li> <li>4. Use the following spectrum analyzer settings for 20dB Bandwidth measurement. Span = approximately 2 to 3 times the 20 dB bandwidth, centered on a hopping channel; RBW<math>\geq</math>1% of the 20 dB bandwidth; VBW<math>\geq</math>RBW; Sweep = auto; Detector function = peak; Trace = max hold.</li> <li>5. Measure and record the results in the test report.</li> </ol>
<b>Test Result:</b>	PASS

### 6.4.2. Test Instruments

RF Test Room				
Equipment	Manufacturer	Model	Serial Number	Calibration Due
Spectrum Analyzer	Agilent	N9020A	MY49100060	Oct. 21, 2015
RF cable	TCT	RE-06	N/A	Sept.15 , 2015
Antenna Connector	TCT	RFC-01	N/A	Sept.15 , 2015

**Note:** The calibration interval of the above test instruments is 12 months and the calibrations are traceable to international system unit (SI).

**6.4.3. Test data**

Test channel	20dB Occupy Bandwidth (kHz)	
	GFSK	Conclusion
Lowest	864.9	PASS
Middle	864.5	PASS
Highest	866.1	PASS

Test plots as follows:



Lowest channel

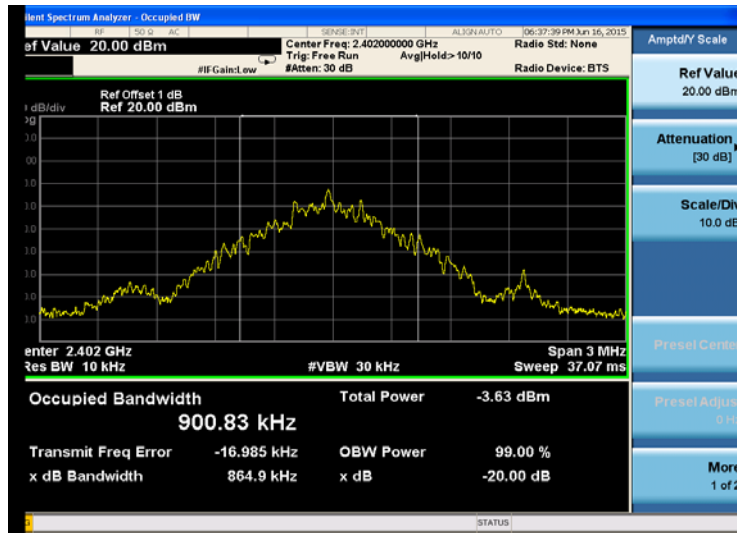

Middle channel

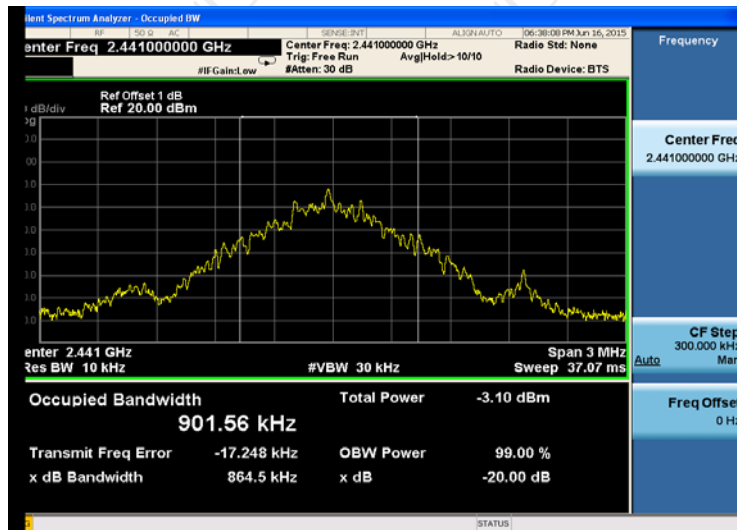

Highest channel

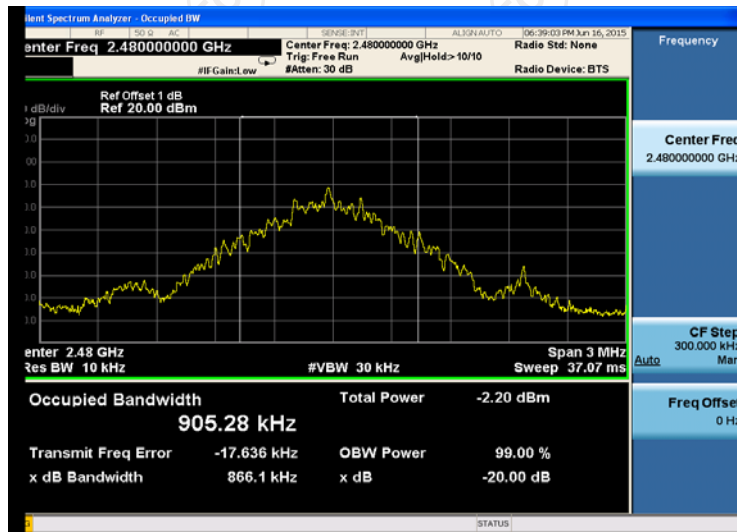

## 6.5. Carrier Frequencies Separation

### 6.5.1. Test Specification

<b>Test Requirement:</b>	FCC Part15 C Section 15.247 (a)(1)
<b>Test Method:</b>	ANSI C63.4:2009 and DA00-705
<b>Limit:</b>	Frequency hopping systems operating in the 2400-2483.5 MHz band may have hopping channel carrier frequencies that are separated by 25 kHz or two-thirds of the 20 dB bandwidth of the hopping channel, whichever is greater.
<b>Test Setup:</b>	<p style="text-align: center;">Spectrum Analyzer                      EUT</p>
<b>Test Mode:</b>	Hopping mode
<b>Test Procedure:</b>	<ol style="list-style-type: none"> <li>1. The testing follows FCC Public Notice DA 00-705 Measurement Guidelines.</li> <li>2. The RF output of EUT was connected to the spectrum analyzer by RF cable and attenuator. The path loss was compensated to the results for each measurement.</li> <li>3. Set to the maximum power setting and enable the EUT transmit continuously.</li> <li>4. Enable the EUT hopping function.</li> <li>5. Use the following spectrum analyzer settings: Span = wide enough to capture the peaks of two adjacent channels; RBW<math>\geq</math>1% of the span; VBW<math>\geq</math>RBW; Sweep = auto; Detector function = peak; Trace = max hold.</li> <li>6. Measure and record the results in the test report.</li> </ol>
<b>Test Result:</b>	PASS

### 6.5.2. Test Instruments

RF Test Room				
Equipment	Manufacturer	Model	Serial Number	Calibration Due
Spectrum Analyzer	Agilent	N9020A	MY49100060	Oct. 21, 2015
RF cable	TCT	RE-06	N/A	Sept.15 , 2015
Antenna Connector	TCT	RFC-01	N/A	Sept.15 , 2015

**Note:** The calibration interval of the above test instruments is 12 months and the calibrations are traceable to international system unit (SI).

**6.5.3. Test data**

GFSK mode			
Test channel	Carrier Frequencies Separation (kHz)	Limit (kHz)	Result
Lowest	1002	577.4	PASS
Middle	1002	577.4	PASS
Highest	993	577.4	PASS

**Note: According to section 6.4**

Mode	20dB bandwidth (kHz) (worse case)	Limit (kHz) (Carrier Frequencies Separation)
GFSK	866.1	577.4

Test plots as follows:



Lowest channel



Middle channel



Highest channel



## 6.6.Hopping Channel Number

### 6.6.1. Test Specification

<b>Test Requirement:</b>	FCC Part15 C Section 15.247 (a)(1)
<b>Test Method:</b>	ANSI C63.4:2009 and DA00-705
<b>Limit:</b>	Frequency hopping systems in the 2400-2483.5 MHz band shall use at least 15 channels.
<b>Test Setup:</b>	 <p style="text-align: center;">Spectrum Analyzer                      EUT</p>
<b>Test Mode:</b>	Hopping mode
<b>Test Procedure:</b>	<ol style="list-style-type: none"> <li>1. The testing follows FCC Public Notice DA 00-705 Measurement Guidelines.</li> <li>2. The RF output of EUT was connected to the spectrum analyzer by RF cable and attenuator. The path loss was compensated to the results for each measurement.</li> <li>3. Set to the maximum power setting and enable the EUT transmit continuously.</li> <li>4. Enable the EUT hopping function.</li> <li>5. Use the following spectrum analyzer settings: Span = the frequency band of operation; RBW <math>\geq</math> 1% of the span; VBW <math>\geq</math> RBW; Sweep = auto; Detector function = peak; Trace = max hold.</li> <li>6. The number of hopping frequency used is defined as the number of total channel.</li> <li>7. Record the measurement data derived from spectrum analyzer.</li> </ol>
<b>Test Result:</b>	PASS

### 6.6.2. Test Instruments

RF Test Room				
Equipment	Manufacturer	Model	Serial Number	Calibration Due
Spectrum Analyzer	Agilent	N9020A	MY49100060	Oct. 21, 2015
RF cable	TCT	RE-06	N/A	Sept.15 , 2015
Antenna Connector	TCT	RFC-01	N/A	Sept.15 , 2015

**Note:** The calibration interval of the above test instruments is 12 months and the calibrations are traceable to international system unit (SI).



6.6.3. Test data

Mode	Hopping channel numbers	Limit	Result
GFSK	79	15	PASS

Test plots as follows:

GFSK



## 6.7.Dwell Time

### 6.7.1. Test Specification

<b>Test Requirement:</b>	FCC Part15 C Section 15.247 (a)(1)
<b>Test Method:</b>	ANSI C63.4:2009 and DA00-705
<b>Limit:</b>	The average time of occupancy on any channel shall not be greater than 0.4 seconds within a period of 0.4 seconds multiplied by the number of hopping channels employed.
<b>Test Setup:</b>	 <p style="text-align: center;">Spectrum Analyzer                      EUT</p>
<b>Test Mode:</b>	Hopping mode
<b>Test Procedure:</b>	<ol style="list-style-type: none"> <li>1. The testing follows FCC Public Notice DA 00-705 Measurement Guidelines.</li> <li>2. The RF output of EUT was connected to the spectrum analyzer by RF cable and attenuator. The path loss was compensated to the results for each measurement.</li> <li>3. Set to the maximum power setting and enable the EUT transmit continuously.</li> <li>4. Enable the EUT hopping function.</li> <li>5. Use the following spectrum analyzer settings: Span = zero span, centered on a hopping channel; RBW = 1 MHz; VBW<math>\geq</math>RBW; Sweep = as necessary to capture the entire dwell time per hopping channel; Detector function = peak; Trace = max hold.</li> <li>6. Measure and record the results in the test report.</li> </ol>
<b>Test Result:</b>	PASS

### 6.7.2. Test Instruments

RF Test Room				
Equipment	Manufacturer	Model	Serial Number	Calibration Due
Spectrum Analyzer	Agilent	N9020A	MY49100060	Oct. 21, 2015
RF cable	TCT	RE-06	N/A	Sept.15 , 2015
Antenna Connector	TCT	RFC-01	N/A	Sept.15 , 2015

**Note:** The calibration interval of the above test instruments is 12 months and the calibrations are traceable to international system unit (SI).

**6.7.3. Test Data**

Mode	Packet	Hops Over Occupancy Time (hops)	Package Transfer Time (ms)	Dwell time (second)	Limit (second)	Result
GFSK	DH5	106.67	2.92	0.31	0.4	PASS

**Note:** 1. In normal mode, hopping rate is 1600 hops/s with 6 slots in 79 hopping channels.

With channel hopping rate (1600 / 6 / 79) in Occupancy Time Limit (0.4 x 79) (s), Hops Over Occupancy Time comes to (1600 / 6 / 79) x (0.4 x 79) = 106.67 hops

2. Dwell Time(s) = Hops Over Occupancy Time (hops) x Package Transfer Time

Test plots as follows:

**GFSK**

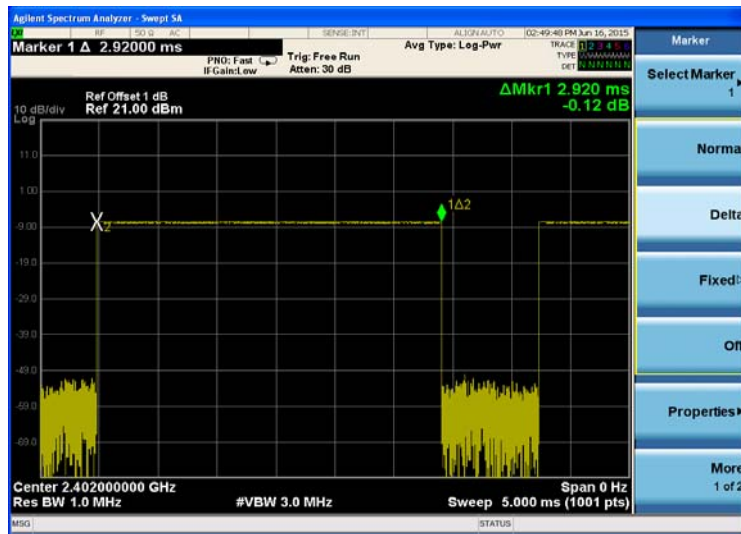

### 6.8.Pseudorandom Frequency Hopping Sequence

**Test Requirement:** FCC Part15 C Section 15.247 (a)(1) requirement:

Frequency hopping systems shall have hopping channel carrier frequencies separated by a minimum of 25 kHz or the 20 dB bandwidth of the hopping channel, whichever is greater.

Alternatively. Frequency hopping systems operating in the 2400-2483.5 MHz band may have hopping channel carrier frequencies that are separated by 25 kHz or two-thirds of the 20 dB bandwidth of the hopping channel, whichever is greater, provided the systems operate with an output power no greater than 125 mW. The system shall hop to channel frequencies that are selected at the system hopping rate from a Pseudorandom ordered list of hopping frequencies. Each frequency must be used equally on the average by each transmitter. The system receivers shall have input bandwidths that match the hopping channel bandwidths of their corresponding transmitters and shall shift frequencies in synchronization with the transmitted signals.

#### EUT Pseudorandom Frequency Hopping Sequence

The pseudorandom sequence may be generated in a nine-stage shift register whose 5th and 9th stage outputs are added in a modulo-two addition stage. And the result is fed back to the input of the first stage. The sequence begins with the first one of 9 consecutive ones; i.e. the shift register is initialized with nine ones.

- Number of shift register stages: 9
- Length of pseudo-random sequence:  $2^9 - 1 = 511$  bits
- Longest sequence of zeros: 8 (non-inverted signal)

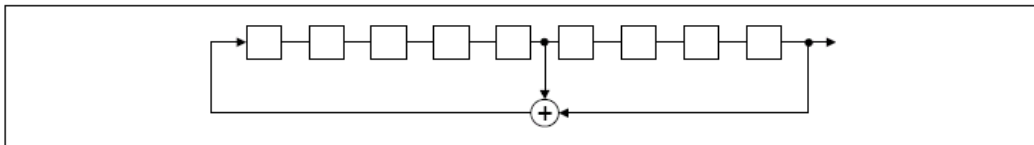

Linear Feedback Shift Register for Generation of the PRBS sequence

An example of Pseudorandom Frequency Hopping Sequence as follow:

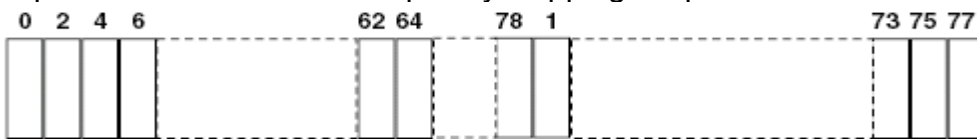

Each frequency used equally on the average by each transmitter. The system receivers have input bandwidths that match the hopping channel bandwidths of their corresponding transmitters and shift frequencies in synchronization with the transmitted signals.

## 6.9. Conducted Band Edge Measurement

### 6.9.1. Test Specification

<b>Test Requirement:</b>	FCC Part15 C Section 15.247 (d)
<b>Test Method:</b>	ANSI C63.4:2009 and DA00-705
<b>Limit:</b>	In any 100 kHz bandwidth outside the intentional radiation frequency band, the radio frequency power shall be at least 20 dB below the highest level of the radiated power. In addition, radiated emissions which fall in the restricted bands must also comply with the radiated emission limits.
<b>Test Setup:</b>	 <p style="text-align: center;">Spectrum Analyzer                      EUT</p>
<b>Test Mode:</b>	Transmitting mode with modulation
<b>Test Procedure:</b>	<ol style="list-style-type: none"> <li>1. The testing follows the guidelines in Band-edge Compliance of RF Conducted Emissions of FCC Public Notice DA 00-705 Measurement Guidelines.</li> <li>2. Set to the maximum power setting and enable the EUT transmit continuously.</li> <li>3. Set RBW = 100 kHz (<math>\geq 1\%</math> span=10MHz), VBW = 300 kHz (<math>\geq</math>RBW). Band edge emissions must be at least 20 dB down from the highest emission level within the authorized band as measured with a 100kHz RBW. The attenuation shall be 30 dB instead of 20 dB when RMS conducted output power procedure is used.</li> <li>4. Enable hopping function of the EUT and then repeat step 2 and 3.</li> <li>5. Measure and record the results in the test report.</li> </ol>
<b>Test Result:</b>	PASS

### 6.9.2. Test Instruments

RF Test Room				
Equipment	Manufacturer	Model	Serial Number	Calibration Due
Spectrum Analyzer	Agilent	N9020A	MY49100060	Oct. 21, 2015
RF cable	TCT	RE-06	N/A	Sept.15 , 2015
Antenna Connector	TCT	RFC-01	N/A	Sept.15 , 2015

**Note:** The calibration interval of the above test instruments is 12 months and the calibrations are traceable to international system unit (SI).

6.9.3. Test Data

GFSK Modulation

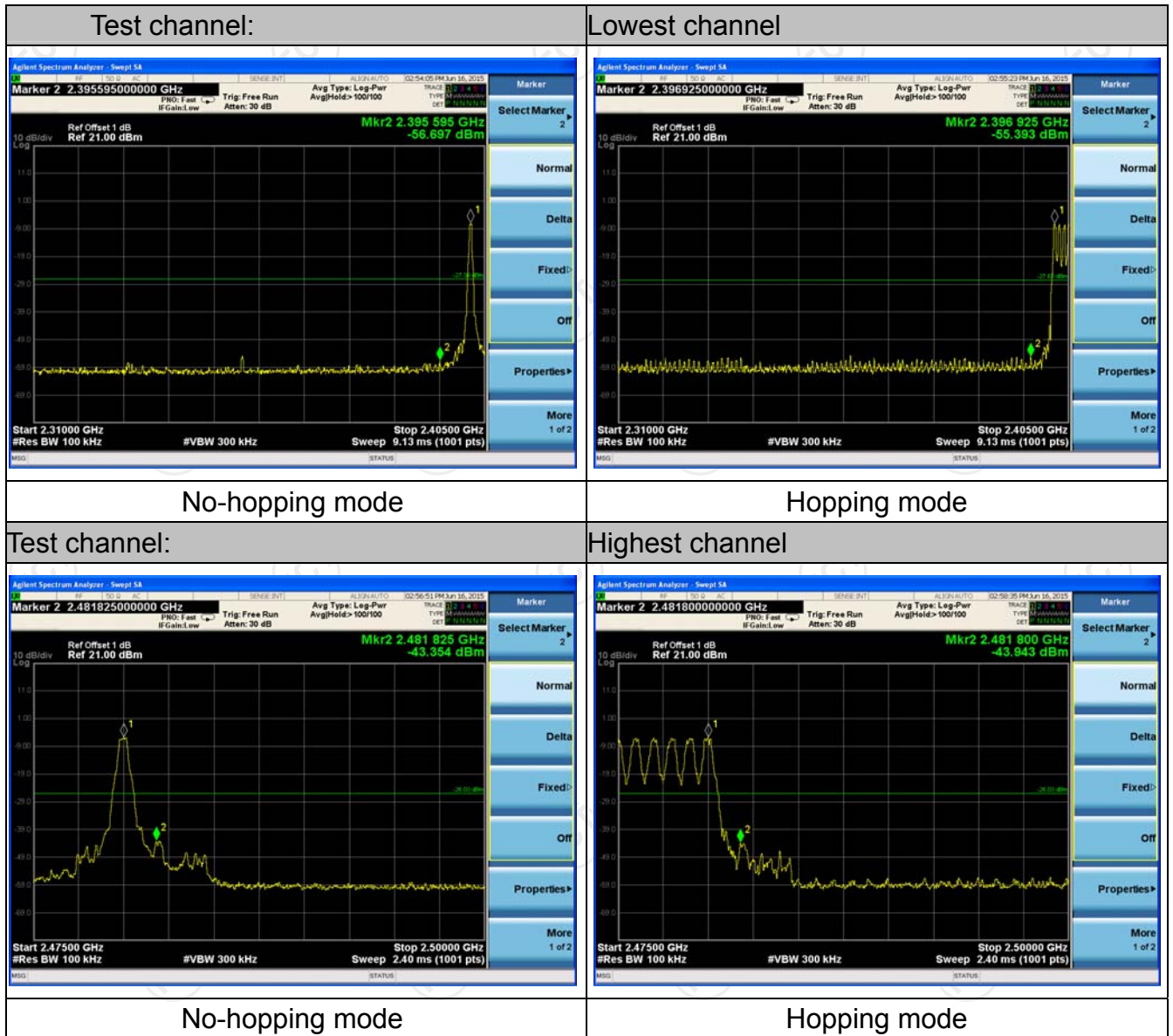



## 6.10. Conducted Spurious Emission Measurement

### 6.10.1. Test Specification

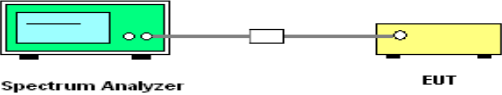
<b>Test Requirement:</b>	FCC Part15 C Section 15.247 (d)
<b>Test Method:</b>	ANSI C63.4:2009 and DA00-705
<b>Limit:</b>	In any 100 kHz bandwidth outside the intentional radiation frequency band, the radio frequency power shall be at least 20 dB below the highest level of the radiated power. In addition, radiated emissions which fall in the restricted bands must also comply with the radiated emission limits.
<b>Test Setup:</b>	 <p style="text-align: center;">Spectrum Analyzer                      EUT</p>
<b>Test Mode:</b>	Transmitting mode with modulation
<b>Test Procedure:</b>	<ol style="list-style-type: none"> <li>1. The testing follows the guidelines in Spurious RF Conducted Emissions of FCC Public Notice DA 00-705 Measurement Guidelines</li> <li>2. The RF output of EUT was connected to the spectrum analyzer by RF cable and attenuator. The path loss was compensated to the results for each measurement.</li> <li>3. Set to the maximum power setting and enable the EUT transmit continuously.</li> <li>4. Set RBW = 100 kHz, VBW = 300kHz, scan up through 10th harmonic. All harmonics / spurs must be at least 20 dB down from the highest emission level within the authorized band as measured with a 100 kHz RBW.</li> <li>5. Measure and record the results in the test report.</li> <li>6. The RF fundamental frequency should be excluded against the limit line in the operating frequency band.</li> </ol>
<b>Test Result:</b>	PASS

### 6.10.2. Test Instruments

RF Test Room				
Equipment	Manufacturer	Model	Serial Number	Calibration Due
Spectrum Analyzer	Agilent	N9020A	MY49100060	Oct. 21, 2015
RF cable	TCT	RE-06	N/A	Sept.15 , 2015
Antenna Connector	TCT	RFC-01	N/A	Sept.15 , 2015

**Note:** The calibration interval of the above test instruments is 12 months and the calibrations are traceable to international system unit (SI).



6.10.3. Test Data

GFSK mode

Lowest Channel

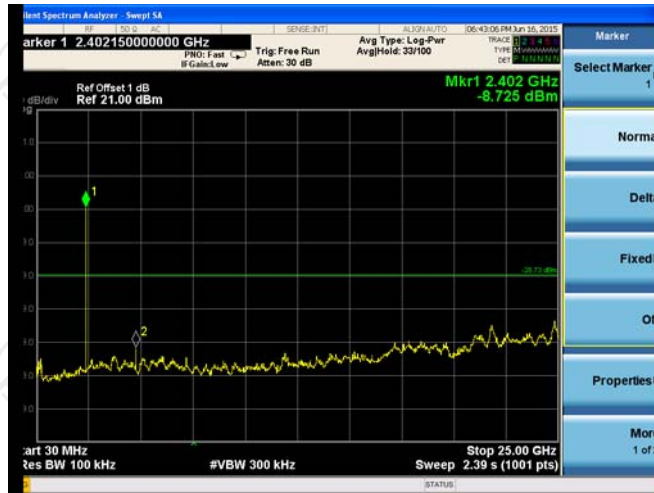

Middle Channel



Highest Channel



## 6.11. Radiated Spurious Emission Measurement

### 6.11.1. Test Specification

<b>Test Requirement:</b>	FCC Part15 C Section 15.209				
<b>Test Method:</b>	ANSI C63.4: 2009 and ANSI C63.10: 2009				
<b>Frequency Range:</b>	9 kHz to 25 GHz				
<b>Measurement Distance:</b>	3 m				
<b>Antenna Polarization:</b>	Horizontal & Vertical				
<b>Receiver Setup:</b>	Frequency	Detector	RBW	VBW	Remark
	9kHz- 150kHz	Quasi-peak	200Hz	1kHz	Quasi-peak Value
	150kHz- 30MHz	Quasi-peak	9kHz	30kHz	Quasi-peak Value
	30MHz-1GHz	Quasi-peak	100KHz	300KHz	Quasi-peak Value
	Above 1GHz	Peak	1MHz	3MHz	Peak Value
		Peak	1MHz	10Hz	Average Value
<b>Limit:</b>	Frequency	Field Strength (microvolts/meter)	Measurement Distance (meters)		
	0.009-0.490	2400/F(KHz)	300		
	0.490-1.705	24000/F(KHz)	30		
	1.705-30	30	30		
	30-88	100	3		
	88-216	150	3		
	216-960	200	3		
	Above 960	500	3		
	Frequency	Field Strength (microvolts/meter)	Measurement Distance (meters)	Detector	
	Above 1GHz	500	3	Average	
		5000	3	Peak	
<b>Test setup:</b>	For radiated emissions below 30MHz				
	<p>Distance = 3m</p> <p>EUT</p> <p>Turn table</p> <p>Ground Plane</p> <p>Computer</p> <p>Pre -Amplifier</p> <p>Receiver</p>				
	30MHz to 1GHz				

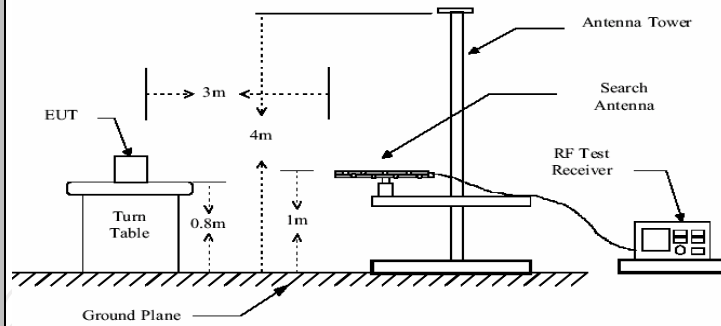

Above 1GHz

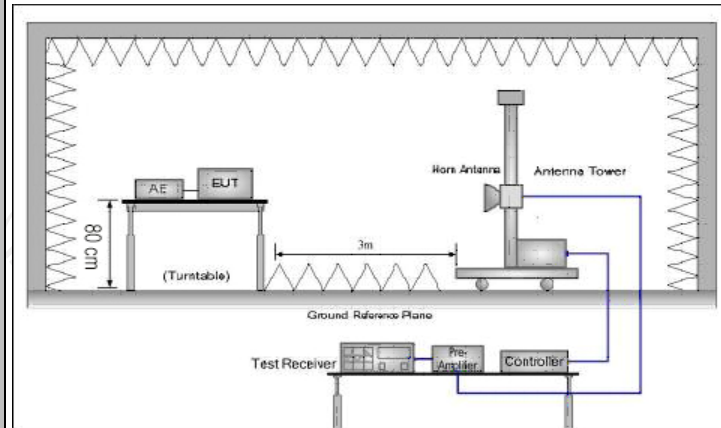

**Test Mode:**

Transmitting mode with modulation

**Test Procedure:**

1. The testing follows the guidelines in Spurious Radiated Emissions of FCC Public Notice DA 00-705 Measurement Guidelines.
2. For the radiated emission test below 1GHz:  
The EUT was placed on a turntable with 0.8 meter above ground. The EUT was set 3 meters from the interference receiving antenna, which was mounted on the top of a variable height antenna tower. The EUT was arranged to its worst case and then tune the antenna tower (from 1 m to 4 m) and turntable (from 0 degree to 360 degrees) to find the maximum reading. A pre-amp and a high pass filter are used for the test in order to get better signal level.
- For the radiated emission test above 1GHz:  
Place the measurement antenna on a turntable with 0.8 meter above ground, which is away from each area of the EUT determined to be a source of emissions at the specified measurement distance, while keeping the measurement antenna aimed at the source of emissions at each frequency of significant emissions, with polarization oriented for maximum response. The measurement antenna may have to be higher or lower than the EUT, depending on the radiation pattern of the emission and staying aimed at the emission source for

	<p>receiving the maximum signal. The final measurement antenna elevation shall be that which maximizes the emissions. The measurement antenna elevation for maximum emissions shall be restricted to a range of heights of from 1 m to 4 m above the ground or reference ground plane.</p> <p>3. Set to the maximum power setting and enable the EUT transmit continuously.</p> <p>4. Use the following spectrum analyzer settings:</p> <p>(1) Span shall wide enough to fully capture the emission being measured;</p> <p>(2) Set RBW=100 kHz for <math>f &lt; 1</math> GHz, RBW=1MHz for <math>f &gt; 1</math>GHz ; VBW<math>\geq</math>RBW; Sweep = auto; Detector function = peak; Trace = max hold for peak</p> <p>(3) For average measurement: use duty cycle correction factor method per 15.35(c). Duty cycle = On time/100 milliseconds On time = <math>N1*L1+N2*L2+...+Nn-1*Ln-1+Nn*Ln</math> Where N1 is number of type 1 pulses, L1 is length of type 1 pulses, etc. Average Emission Level = Peak Emission Level + <math>20*\log(\text{Duty cycle})</math> Corrected Reading: Antenna Factor + Cable Loss + Read Level - Preamp Factor = Level</p>
<b>Test results:</b>	PASS

6.11.2. Test Instruments

Radiated Emission Test Site (966)				
Name of Equipment	Manufacturer	Model	Serial Number	Calibration Due
ESPI Test Receiver	ROHDE&SCHW ARZ	ESVD	100008	Sept.16 , 2015
Spectrum Analyzer	ROHDE&SCHW ARZ	FSEM	848597/001	Sept.16 , 2015
Spectrum Analyzer	R&S	FSU	200054	Sept. 15, 2015
Pre-amplifier	EM Electronics Corporation CO.,LTD	EM30265	07032613	Sept.16 , 2015
Pre-amplifier	HP	8447D	2727A05017	Sept.16 , 2015
Loop antenna	ZHINAN	ZN30900A	12024	Dec.14 , 2015
Broadband Antenna	Schwarzbeck	VULB9163	340	Sept.16 , 2015
Horn Antenna	Schwarzbeck	BBHA 9120D	631	Sept.16 , 2015
Horn Antenna	Schwarzbeck	BBHA 9170	373	Sept.16 , 2015
Antenna Mast	CCS	CC-A-4M	N/A	N/A
Coax cable	TCT	RE-low-01	N/A	Sept.15 , 2015
Coax cable	TCT	RE-high-02	N/A	Sept.15 , 2015
Coax cable	TCT	RE-low-03	N/A	Sept.15 , 2015
Coax cable	TCT	RE-high-04	N/A	Sept.15 , 2015
EMI Test Software	Shurple Technology	EZ-EMC	N/A	N/A

**Note:** The calibration interval of the above test instruments is 12 months and the calibrations are traceable to international system unit (SI).

**6.11.3. Test Data**

**Duty cycle correction factor for average measurement**

DH5 on time (One Pulse) Plot on Channel 00

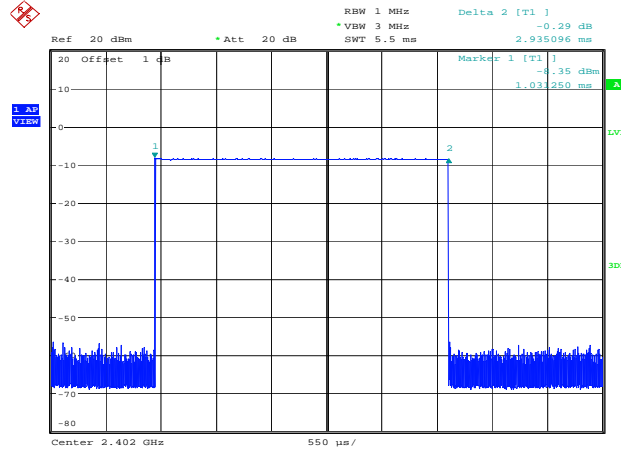

Date: 16 JUN 2015 14:33:12

DH5 on time (Count Pulses) Plot on Channel 00

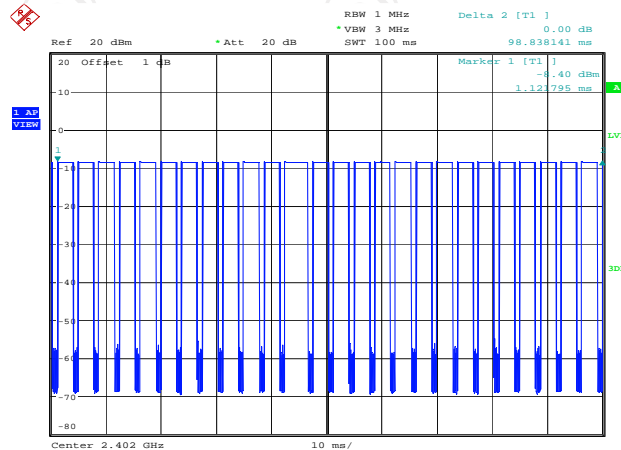

Date: 16 JUN 2015 14:35:32

**Note:**

1. Worst case Duty cycle = on time/100 milliseconds = (2.935\*26+1.122)/ 100 = 0.77432
2. Worst case Duty cycle correction factor = 20\*log (Duty cycle) = -2.22dB
3. DH5 has the highest duty cycle worst case and is reported.
4. The average levels were calculated from the peak level corrected with duty cycle correction factor (-2.22dB) derived from 20log (dwell time/100ms). This correction is only for signals that hop with the fundamental signal, such as band-edge and harmonic. Other spurious signals that are independent of the hopping signal would not use this correction.

Please refer to following diagram for individual

Below 1GHz

Horizontal:

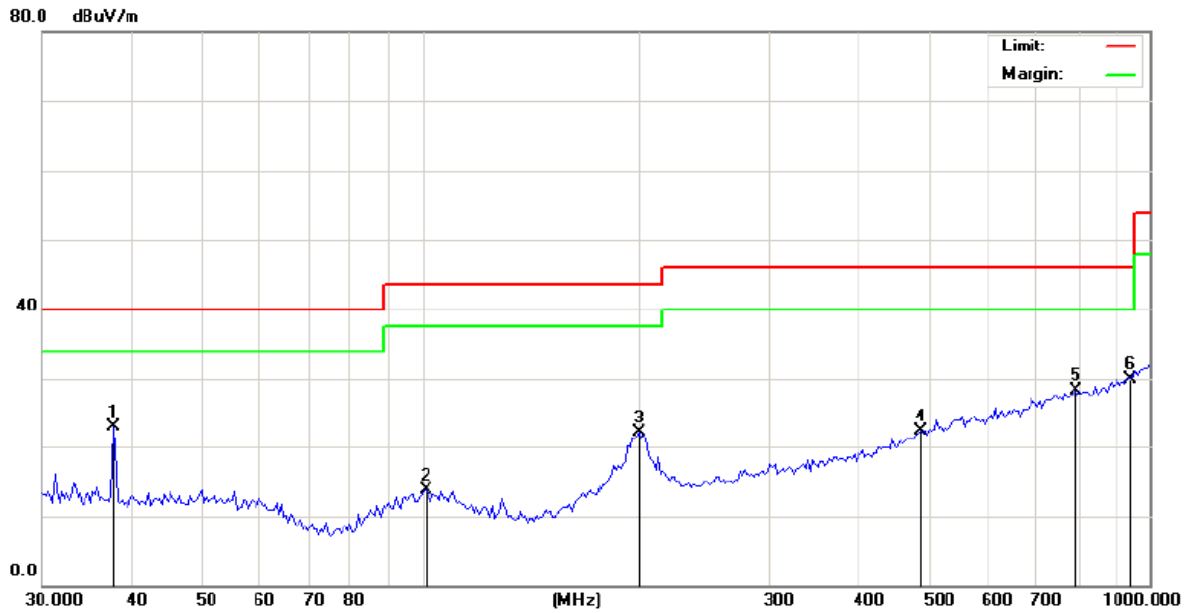

Site: Limit: FCC Part 15B Class B RE\_3 m      Polarization: **Horizontal**      Temperature: 25  
 Power:      Humidity: 56 %

No.	Mk.	Freq. MHz	Reading Level dBuV	Correct Factor dB	Measure- ment dBuV/m	Limit dBuV/m	Over dB	Antenna Height cm	Table Degree	Comment
1		37.5648	35.65	-12.78	22.87	40.00	-17.13	peak	0	
2		101.1797	25.20	-11.50	13.70	43.50	-29.80	peak	0	
3		198.6424	33.93	-11.77	22.16	43.50	-21.34	peak	0	
4		484.9068	25.86	-3.46	22.40	46.00	-23.60	peak	0	
5		793.0281	26.85	1.37	28.22	46.00	-17.78	peak	0	
6	*	938.7140	26.01	3.99	30.00	46.00	-16.00	peak	0	



Vertical:

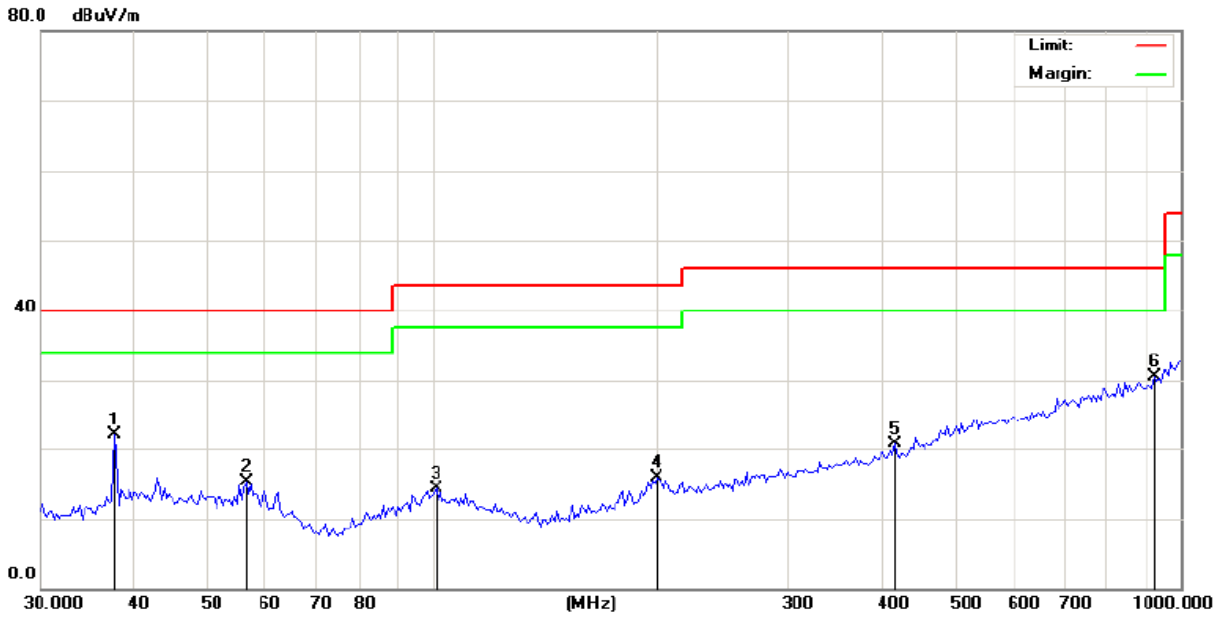

Site: Polarization: **Vertical** Temperature: 25  
 Limit: FCC Part 15B Class B RE\_3 m Power: Humidity: 56 %

No.	Mk.	Freq. MHz	Reading Level dBuV	Correct Factor dB	Measure- ment dBuV/m	Limit dBuV/m	Over dB	Detector	Antenna Height cm	Table Degree degree	Comment
1		37.5648	34.93	-12.78	22.15	40.00	-17.85	peak		0	
2		56.4662	27.92	-12.53	15.39	40.00	-24.61	peak		0	
3		101.1797	25.73	-11.50	14.23	43.50	-29.27	peak		0	
4		200.0432	27.53	-11.67	15.86	43.50	-27.64	peak		0	
5		415.4486	26.38	-5.69	20.69	46.00	-25.31	peak		0	
6	*	925.6132	26.91	3.54	30.45	46.00	-15.55	peak		0	

**Note:** 1. The low frequency, which started from 9KHz~30MHz, was pre-scanned and the result which was 20dB lower than the limit line per 15.31(o) was not reported

2. Measurements were conducted in all three channels (high, middle, low) of the modulation GFSK, and the worst case Mode (Highest channel and GFSK) was submitted only.

## Above 1GHz

Modulation Type: GFSK									
Low channel: 2402 MHz									
Frequency (MHz)	Ant. Pol. H/V	Peak reading (dB $\mu$ V)	AV reading (dB $\mu$ V)	Correction Factor (dB/m)	Emission Level		Peak limit (dB $\mu$ V/m)	AV limit (dB $\mu$ V/m)	Margin (dB)
					Peak (dB $\mu$ V/m)	AV (dB $\mu$ V/m)			
2390	H	46.39	---	-8.23	38.16	---	74	54	-15.84
4804	H	41.12	---	6.59	47.71	---	74	54	-6.29
7206	H	37.05	---	12.87	49.92	---	74	54	-4.08
---	H	---	---	---	---	---	---	---	---
2390	V	38.76	---	-8.23	30.53	---	74	54	-23.47
4804	V	39.06	---	6.59	45.65	---	74	54	-8.35
7206	V	35.41	---	12.87	48.28	---	74	54	-5.72
---	V	---	---	---	---	---	---	---	---

Middle channel: 2441 MHz									
Frequency (MHz)	Ant. Pol. H/V	Peak reading (dB $\mu$ V)	AV reading (dB $\mu$ V)	Correction Factor (dB/m)	Emission Level		Peak limit (dB $\mu$ V/m)	AV limit (dB $\mu$ V/m)	Margin (dB)
					Peak (dB $\mu$ V/m)	AV (dB $\mu$ V/m)			
4882	H	39.76	---	7.01	46.77	---	74	54	-7.23
7323	H	38.10	---	13.21	51.31	---	74	54	-2.69
---	H	---	---	---	---	---	---	---	---
4882	V	39.72	---	7.01	46.73	---	74	54	-7.27
7323	V	38.09	---	13.21	51.30	---	74	54	-2.70
---	V	---	---	---	---	---	---	---	---

High channel: 2480 MHz									
Frequency (MHz)	Ant. Pol. H/V	Peak reading (dB $\mu$ V)	AV reading (dB $\mu$ V)	Correction Factor (dB/m)	Emission Level		Peak limit (dB $\mu$ V/m)	AV limit (dB $\mu$ V/m)	Margin (dB)
					Peak (dB $\mu$ V/m)	AV (dB $\mu$ V/m)			
2483.5	H	42.62	---	-7.52	35.10	---	74	54	-18.90
4960	H	41.36	---	7.44	48.80	---	74	54	-5.20
7440	H	36.66	---	13.54	50.20	---	74	54	-3.80
---	H	---	---	---	---	---	---	---	---
2483.5	V	39.00	---	-7.52	31.48	---	74	54	-22.52
4960	V	39.81	---	7.44	47.25	---	74	54	-6.75
7440	V	37.80	---	13.54	51.34	---	74	54	-2.66
---	V	---	---	---	---	---	---	---	---

**Note:**

1. Emission Level=Peak Reading + Correction Factor; Correction Factor= Antenna Factor + Cable loss – Pre-amplifier
2. Margin (dB) = Emission Level (Peak) (dB $\mu$ V/m)-Average limit (dB $\mu$ V/m)
3. The emission levels of other frequencies are very lower than the limit and not show in test report.
4. Measurements were conducted from 1 GHz to the 10th harmonic of highest fundamental frequency.
5. Data of measurement shown “---“in the above table mean that the reading of emissions is attenuated more than 20 dB below the limits or the field strength is too small to be measured.
6. Measurements were recorded in the modulation GFSK.

**\*\*\*\*\*END OF REPORT\*\*\*\*\***