



FastMile 2.1

Nokia FastMile 4G Receiver Product Overview

3TG-00386-ABAA-TCZZA Issue: 01 DRAFT September 2019

Nokia — Proprietary and confidential
Use pursuant to applicable agreements

DRAFT

Nokia is a registered trademark of Nokia Corporation. Other products and company names mentioned herein may be trademarks or tradenames of their respective owners.

The information presented is subject to change without notice. No responsibility is assumed for inaccuracies contained herein.

© 2019 Nokia.

Contains proprietary/trade secret information which is the property of Nokia and must not be made available to, or copied or used by anyone outside Nokia without its written authorization. Not to be used or disclosed except in accordance with applicable agreements.

1 Preface

This preface provides general information about the Product Overview for the Nokia FastMile 4G Receiver.

1.1 Scope

This document provides an overview of the Nokia FastMile 4G Receiver along with information about safety and troubleshooting the Nokia FastMile 4G Receiver.

1.2 Audience

This document is intended for planners, administrators, operators, and maintenance personnel involved in installing, upgrading, or maintaining the Nokia FastMile 4G Receiver.

1.3 Required knowledge

The reader must be familiar with general telecommunications principles.

1.4 Acronyms and initialisms

The expansions and optional descriptions of most acronyms and initialisms used in this document appear in the glossary at the back of the document.

1.5 Assistance and ordering phone numbers

Nokia provides global technical support through regional call centers. Phone numbers for the regional call centers are available at the following URL: <http://support.alcatel-lucent.com>.

For ordering information, contact your Nokia sales representative.

1.6 Nokia quality processes

Nokia's FastMile 4G Receiver quality practices are in compliance with TL 9000 requirements. These requirements are documented in the Fixed Networks Quality Manual 3FQ-30146-6000-QRZZA. The quality practices adequately ensure that technical requirements and customer end-point requirements are met. The customer or its representatives may be allowed to perform on-site quality surveillance audits, as agreed upon during contract negotiations.

1.7 Safety information

For safety information, see the appropriate safety guideline chapters.

1.8 Documents

Documents are available from Nokia using OnLine Customer Support (OLCS).

Procedure 1 To access a document on OLCS

Individual PDFs of customer documents are accessible through OLCS.

-
- 1 Navigate to <http://support.alcatel-lucent.com> and enter your user name and password. If you are a new user and require access to this service, please contact your Nokia sales representative.

 - 2 From the Product information drop-down menu, select FastMile Home Unit as the product and click on Submit.

 - 3 From the Select release drop-down menu, select the appropriate release and click on Submit.

 - 4 Click on the PDF to open or save the file.
-

1.9 Special information

The following are examples of how special information is presented in this document.



Danger — Danger indicates that the described activity or situation may result in serious personal injury or death; for example, high voltage or electric shock hazards.



Warning — Warning indicates that the described activity or situation may, or will, cause equipment damage or serious performance problems.



Caution — Caution indicates that the described activity or situation may, or will, cause service interruption.



Note — A note provides information that is, or may be, of special interest.

1.9.1 Steps with options or substeps

When there are options in a step, they are identified by letters. When there are required substeps in a step, they are identified by roman numerals.

Procedure 2 Example of options in a step

At step ¹, you must choose option a or b.

¹This step offers two options. You must choose one of the following:

- a** This is one option. **b**
This is another option.

-
- 2 You must perform this step.
-

Procedure 3 Example of required substeps in a step

At step 1, you must perform a series of substeps within the step.

-
- 1 This step has a series of substeps that you must perform to complete the step. You must perform the following substeps:
 - i This is the first substep.
 - ii This is the second substep.
 - iii This is the third substep.
 - 2 You must perform this step.
-

1.10 Multiple PDF document search

You can use Adobe Reader Release 6.0 and later to search multiple PDF files for a common term. Adobe Reader displays the results in a single display panel. The results are grouped by PDF file, and you can expand the entry for each file.



Note — The PDF files in which you search must be in the same folder.

Procedure 4 To search multiple PDF files for a common term

-
- 1 Open Adobe Acrobat Reader.
 - 2 Choose Edit→Search from the Acrobat Reader main menu. The Search PDF panel appears.
 - 3 Enter the search criteria.
 - 4 Click on the All PDF Documents In radio button.
 - 5 Select the folder in which to search using the drop-down menu.
-

-
- 6** Click on the Search button.
Acrobat Reader displays the search results. You can expand the entries for each document by clicking on the + symbol.
-

2 ETSI environmental and CRoHS guidelines

This chapter provides information about the ETSI environmental China Restriction of Hazardous Substances (CRoHS) regulations that govern the installation and operation of Nokia FastMile 4G Receiver equipment. This chapter also includes environmental operation parameters of general interest.

2.1 Environmental labels

This section describes the environmental instructions that are provided with the customer documentation, equipment, and location where the equipment resides.

2.1.1 Overview

CRoHS is applicable to Electronic Information Products (EIP) manufactured or sold and imported in the territory of the mainland of the People's Republic of China. EIP refers to products and their accessories manufactured by using electronic information technology, including electronic communications products and such subcomponents as batteries and cables.

2.1.2 Environmental related labels

Environmental labels are located on appropriate equipment. The following are sample labels.

2.1.2.1 Products below Maximum Concentration Value (MCV) label

Figure 1 shows the label that indicates a product is below the maximum concentration value, as defined by standard SJ/T11363-2006 (Requirements for Concentration Limits for Certain Hazardous Substances in Electronic Information Products). Products with this label are recyclable. The label may be found in this documentation or on the product.

Figure 1 Products below MCV value label



18986

2.1.2.2 Products containing hazardous substances above Maximum Concentration Value (MCV) label

Figure 2 shows the label that indicates a product is above the maximum concentration value, as defined by standard SJ/T11363-2006 (Requirements for Concentration Limits for Certain Hazardous Substances in Electronic Information Products). The number contained inside the label indicates the Environment-Friendly User Period (EFUP) value. The label may be found in this documentation or on the product.

Figure 2 Products above MCV value label



Together with major international telecommunications equipment companies, Nokia has determined it is appropriate to use an EFUP of 50 years for network infrastructure equipment and an EFUP of 20 years for handsets and accessories. These values are based on manufacturers' extensive practical experience of the design, manufacturing, maintenance, usage conditions, operating environments, and physical condition of infrastructure and handsets after years of service. The values reflect minimum values and refer to products operated according to the intended use conditions. See "[Hazardous Substances Table \(HST\)](#)" for more information.

2.2 Hazardous Substances Table (HST)

This section describes the compliance of the Nokia FastMile 4G Receiver equipment to the CRoHS standard when the product and subassemblies contain hazardous substances beyond the MCV value. This information is found in this user documentation where part numbers for the product and subassemblies are listed. It may be referenced in other documentation that describes the Nokia FastMile 4G Receiver equipment.

In accordance with the People's Republic of China Electronic Industry Standard Marking for the Control of Pollution Caused by Electronic Information Products (SJ/T11364-2006), customers may access the Nokia Hazardous Substance Table, in Chinese, from the following location:

- <http://www.alcatel-sbell.com.cn/wwwroot/images/upload/private/1/media/ChinaRoHS.pdf>

2.3 Other environmental requirements

Observe the following environmental requirements when handling Nokia FastMile 4G Receiver equipment.

2.3.1 Environmental requirements

See chapter 16 in this document for more information about temperature ranges for the Nokia FastMile 4G Receiver equipment and other Nokia FastMile 4G Receiver specifications.

2.3.2 Storage

According to ETS 300-019-1-1 - Class 1.1, storage of Nokia FastMile 4G Receiver equipment must be in Class 1.1, weather-protected, temperature-controlled locations.

2.3.3 Transportation

According to EN 300-019-1-2 - Class 2.3, transportation of Nokia FastMile 4G Receiver equipment must be in packed, public transportation.

2.3.4 Stationary use

According to EN 300-019-1-3 - Class 3.1/3.2/3.E, stationary use of Nokia FastMile 4G Receiver equipment must be in a temperature-controlled location with no condensation allowed.

2.3.5 Thermal limitations

The thermal limitations for the Nokia FastMile 4G Receiver equipment are:

- operating temperature (ambient):
- Compact mono-band and ABA models: -30°C to 65°C (-22°F to 149°F)
- Compact multi-band models: -30°C to 55°C (-22°F to 131°F)
- operating relative humidity: 5% to 85% relative humidity, non-condensing
- short-term relative humidity: 5% to 93% relative humidity, non-condensing

2.3.6 Material content compliance

European Union (EU) Directive 2002/95/EC, "Restriction of the use of certain Hazardous Substances" (RoHS), restricts the use of lead, mercury, cadmium, hexavalent chromium, and certain flame retardants in electrical and electronic equipment. This Directive applies to electrical and electronic products placed on the EU market after 1 July 2006, with various exemptions, including an exemption for lead solder in network infrastructure equipment. Nokia products shipped to the EU after 1 July 2006 comply with the EU RoHS Directive.

Nokia has implemented a material/substance content management process. The process is described in: Nokia process for ensuring RoHS Compliance (1AA002660031ASZZA). This ensures compliance with the European Union Directive 2011/65/EU on the Restriction of the Use of Certain Hazardous Substances in Electrical and Electronic Equipment (RoHS2). With the process equipment is assessed in accordance with the Harmonised Standard EN50581:2012 (CENELEC) on Technical documentation for the assessment of electrical and electronic products with respect to the restriction of hazardous substances.

2.3.7 End-of-life collection and treatment

Electronic products bearing or referencing the symbol shown in Figure 3, when put on the market within the European Union (EU), shall be collected and treated at the end of their useful life, in compliance with applicable EU and local legislation. They shall not be disposed of as part of unsorted municipal waste. Due to materials that may be contained in the product, such as heavy metals or batteries, the environment and human health may be negatively impacted as a result of inappropriate disposal.

Figure 3 Recycling/take back/disposal of product symbol



At the end of its life, Nokia FastMile 4G Receiver equipment is subject to the applicable local legislations that implement the European Directive 2012/19EU on waste electrical and electronic equipment (WEEE).

There can be different requirements for collection and treatment in different member states of the European Union.

In compliance with legal requirements and contractual agreements, where applicable, Nokia will offer to provide for the collection and treatment of Nokia products bearing the logo shown in Figure 3 at the end of their useful life, or products displaced by Nokia equipment offers. For information regarding take-back of equipment by Nokia, or for more information regarding the requirements for recycling/disposal of product, contact your Nokia account manager or Nokia take back support at sustainability.global@nokia.com.

2.4 Additional information

See chapter [17](#) for RF exposure information.

3 ETSI safety guidelines

This chapter provides information about the mandatory regulations that govern the installation and operation of Nokia FastMile 4G Receiver equipment in the ETSI market.

3.1 Safety instructions

This section describes the safety instructions that are provided in the customer documentation and on the Nokia FastMile 4G Receiver equipment.

3.1.1 Safety instruction boxes

The safety instruction boxes are provided in the Nokia FastMile 4G Receiver customer documentation. Observe the instructions to meet safety requirements.

The following is an example of the Danger box.



Danger — Possibility of personal injury.

The Danger box indicates that the described activity or situation may pose a threat to personal safety. It calls attention to a situation or procedure which, if not correctly performed or adhered to, may result in death or serious physical harm.

Do not proceed beyond a Danger box until the indicated conditions are fully understood and met.

The following is an example of the Warning box.



Warning 1 — Possibility of equipment damage.

Warning 2 — Possibility of data loss.

The Warning box indicates that the described activity or situation may, or will, cause equipment damage, loss of data, or serious performance problems. It identifies a possible equipment-damaging situation or provides essential information to avoid the degradation of system operations or data.

Do not proceed beyond a warning until the indicated conditions are fully understood and met.

The following is an example of the Caution box.



Caution 1 — Possibility of service interruption.

Caution 2 — Service interruption.

The Caution box indicates that the described activity or situation may, or will, cause service interruption.

Do not proceed beyond a caution until the indicated conditions are fully understood and met.

The following is an example of the Note box.



Note — Information of special interest.

The Note box provides information that assists the personnel working with Nokia FastMile 4G Receiver equipment. It does not provide safety-related instructions.

3.1.2 Safety-related labels

The Nokia FastMile 4G Receiver equipment is labeled with the specific safety instructions and compliance information that is related to a product, or product variant or model, of the equipment. Observe the instructions on the safety labels.

Table 1 provides sample safety labels on Nokia FastMile 4G Receiver equipment.

Table 1 Safety labels

Description	Label text
ESD warning	Caution: This assembly contains an electrostatic sensitive device.

3.2 Safety standards compliance

This section describes Nokia FastMile 4G Receiver equipment compliance with the European safety standards.

3.2.1 EMC compliance

The Nokia FastMile 4G Receiver equipment complies with the following EMC requirements:

- Electromagnetic compatibility of multimedia equipment - Emission requirements CISPR 32, EN 55032
- Electromagnetic compatibility of multimedia equipment - Immunity requirements CISPR 35, EN55035
- Electromagnetic Compatibility (EMC) standard for radio equipment and services; Part 1: Common technical requirements; Harmonized Standard covering the essential requirements of article 3.1(b) of Directive 2014/53/EU and the essential requirements of article 6 of Directive 2014/30/EU EN 301489-1
- Electromagnetic Compatibility (EMC) standard for radio equipment and services; Part 17: Specific conditions for Broadband Data Transmission Systems; Harmonized Standard covering the essential requirements of article 3.1(b) of Directive 2014/53/EU EN 301489-17

3.2.2 Equipment safety standard compliance

The Nokia FastMile 4G Receiver equipment complies with the requirements of the following:

- EN 60950-1, Safety of Information Technology Equipment for use in a restricted location (per R-269)
- IEC 60950-22, EN 60950-22: Information Technology Equipment- Safety - Part 22 Equipment to be installed Outdoors

3.2.3 Environmental standard compliance

The Nokia FastMile 4G Receiver equipment complies with the EN 300 019 European environmental standards.

3.2.4 Laser product standard compliance

The Nokia FastMile 4G Receiver equipment is not a laser product.

3.3 Electrical safety guidelines

This section provides the electrical safety guidelines for the Nokia FastMile 4G Receiver equipment.



Note 1 — The Nokia FastMile 4G Receiver equipment complies with the U.S. National Electrical Code. However, local electrical authorities have jurisdiction when there are differences between the local and U.S. standards.

Note 2 — The Nokia FastMile 4G Receiver equipment complies with BS EN 61140.

3.3.1 Power supplies

The use of any non-Nokia approved power supplies or power adapters is not supported or endorsed by Nokia. Such use will void any warranty or support contract with Nokia. Such use greatly increases the danger of damage to equipment or property.

3.3.2 Cabling

The following are the guidelines regarding cables used for the Nokia FastMile 4G Receiver equipment:

- All cables must be approved by the relevant national electrical code.
- Cables for outdoor connection to the Nokia FastMile 4G Receiver equipment must be suitable for outdoor use.
- The Nokia FastMile 4G Receiver equipment must be used with the cabling supplied with the equipment.

3.3.3 Protective earth

Earthing and bonding of the Nokia FastMile 4G Receiver equipment must comply with the requirements of local electrical codes.

3.4 ESD safety guidelines

The Nokia FastMile 4G Receiver equipment is sensitive to ESD if opened. Operations personnel must observe the following ESD instructions when they handle the Nokia FastMile 4G Receiver equipment.



Caution — This equipment is ESD sensitive if opened. Proper ESD protections should be used if you open the Nokia FastMile 4G Receiver.

Service personnel are not required to wear wrist straps when performing normal installation or maintenance activities.

3.5 Environmental requirements

See chapter 16 in this document for information about temperature ranges for the Nokia FastMile 4G Receiver equipment and other Nokia FastMile 4G Receiver specifications.

During operation in the supported temperature range, condensation inside the Nokia FastMile 4G Receiver equipment caused by humidity is not an issue because the Nokia FastMile 4G Receiver is a sealed unit.

3.6 Additional information

See chapter 17 for RF exposure information.

4 ANSI safety guidelines

This chapter provides information about the mandatory regulations that govern the installation and operation of the Nokia FastMile 4G Receiver equipment in the North American or ANSI market.

4.1 Safety instructions

This section describes the safety instructions that are provided in the customer documentation and on the Nokia FastMile 4G Receiver equipment.

4.1.1 Safety instruction boxes in customer documentation

The safety instruction boxes are provided in the Nokia FastMile 4G Receiver customer documentation. Observe the instructions to meet safety requirements.

The following is an example of the Danger box.



Danger — Possibility of personal injury.

The Danger box indicates that the described activity or situation may pose a threat to personal safety. It calls attention to a situation or procedure which, if not correctly performed or adhered to, may result in death or serious physical harm.

Do not proceed beyond a Danger box until the indicated conditions are fully understood and met.

The following is an example of the Warning box.



Warning 1 — Possibility of equipment damage.

Warning 2 — Possibility of data loss.

The Warning box indicates that the described activity or situation may, or will, cause equipment damage, loss of data, or serious performance problems. It identifies a possible equipment-damaging situation or provides essential information to avoid the degradation of system operations or data.

Do not proceed beyond a warning until the indicated conditions are fully understood and met.

The following is an example of the Caution box.



Caution 1 — Possibility of service interruption.

Caution 2 — Service interruption.

The Caution box indicates that the described activity or situation may, or will, cause service interruption.

Do not proceed beyond a caution until the indicated conditions are fully understood and met.

The following is an example of the Note box.



Note — Information of special interest.

The Note box provides information that assists the personnel working with Nokia FastMile 4G Receiver equipment. It does not provide safety-related instructions.

4.1.2 Safety-related labels

The Nokia FastMile 4G Receiver equipment is labeled with specific safety compliance information and instructions that are related to a product, or product model, of the equipment. Observe the instructions on the safety labels.

Table 2 provides examples of the text in the various Nokia FastMile 4G Receiver equipment safety labels.

Table 2 Safety labels

Description	Label text
UL compliance	ETL/cETL
UL50E compliance	Type 3
ESD warning	Caution: This assembly contains electrostatic sensitive device.
FCC standards compliance	Tested to comply with FCC standards for home or office use.
Operation conditions	This device complies with Part 15 of the FCC Rules. Operation is subject to the following two conditions: (1) this device may not cause harmful interference, and (2) this device must accept any interference received, including interference that may cause undesired operation.

CE marking	There are various CE symbols for CE compliance.
------------	---

Figure 4 shows a sample safety label for FCC and Figure 5 shows a sample safety label for ETL.

Figure 4 Sample safety label for FCC

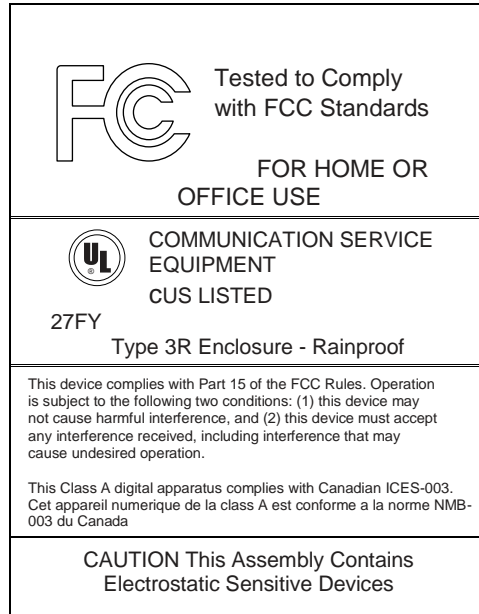

18533

Figure 5 Sample safety label for ETL



27799

4.2 Safety standards compliance

This section describes the Nokia FastMile 4G Receiver equipment compliance with North American safety standards.



Warning — Changes or modifications to this unit not expressly approved by the party responsible for compliance could void the user's authority to operate the equipment.

4.2.1 EMC, EMI, and ESD compliance

The Nokia FastMile 4G Receiver equipment complies with the following EMC, EMI, and ESD requirements:

- Federal Communications Commission PART 15-RADIO FREQUENCY DEVICES Subpart C-INTENTIONAL RADIATORS Title 47 CFR Part 15. Part 15.247, Part 15.255

This equipment has been tested and found to comply with the limits for a Class B digital device, pursuant to Part 15 of the FCC Rules. These limits are designed to provide reasonable protection against harmful interference in a residential installation. This equipment generates, uses and can radiate radio frequency energy and, if not installed and used in accordance with the instructions, may cause harmful interference to radio communications.

However, there is no guarantee that interference will not occur in a particular installation. If this equipment does cause harmful interference to radio or television reception, which can be determined by turning the equipment off and on, the user is encouraged to try to correct the interference by one or more of the following measures:

- Reorient or relocate the receiving antenna.
- Increase the separation between the equipment and receiver.
- Connect the equipment into an outlet on a circuit different from that to which the receiver is needed.
- Consult the dealer or an experienced radio/TV technician for help.

4.2.2 Equipment safety standard compliance

The Nokia FastMile 4G Receiver equipment complies with the requirements of:

- UL62368-1, Outdoor ONTs to “Communication Service Equipment” (CSE) and Indoor ONTs to Information Technology Equipment (ITE)
- Information Technology Equipment- Safety - Part 22 Equipment to be installed Outdoors
- UL 60950-22

4.3 Electrical safety guidelines

This section provides the electrical safety guidelines for the Nokia FastMile 4G Receiver equipment.



Note — The Nokia FastMile 4G Receiver equipment complies with the U.S. National Electrical Code. However, local electrical authorities have jurisdiction when there are differences between the local and U.S. standards.

4.3.1 Power supplies

The use of any non-Nokia approved power supplies or power adapters is not supported or endorsed by Nokia. Such use will void any warranty or support contract with Nokia. Such use greatly increases the danger of damage to equipment or property.

4.3.2 Cabling

The following are the guidelines regarding cables used for the Nokia FastMile 4G Receiver equipment:

- All cables must be approved by the relevant national electrical code.
- Cables for outdoor connection to the Nokia FastMile 4G Receiver equipment must be suitable for outdoor use.
- The Nokia FastMile 4G Receiver equipment must be used with the cabling supplied with the equipment.

4.3.3 Protective earth

Earthing and bonding of the Nokia FastMile 4G Receiver equipment must comply with the requirements of NEC article 250 or local electrical codes.

4.4 ESD safety guidelines

The Nokia FastMile 4G Receiver equipment is sensitive to ESD if opened. Operations personnel must observe the following ESD instructions when they handle the Nokia FastMile 4G Receiver equipment.



Caution — This equipment is ESD sensitive if opened. Proper ESD protections should be used if you open the Nokia FastMile 4G Receiver.

Service personnel are not required to wear wrist straps when performing normal installation or maintenance activities.

4.5 Environmental requirements

See chapter 16 in this document for information about temperature ranges for the Nokia FastMile 4G Receiver equipment and other Nokia FastMile 4G Receiver specifications.

During operation in the supported temperature range, condensation inside the Nokia FastMile 4G Receiver equipment caused by humidity is not an issue because the Nokia FastMile 4G Receiver is a sealed unit.

4.6 Additional information

See chapter 17 for RF exposure information.

See chapter 18 for additional FCC compliance information.

Table of contents

1 Preface.....	3
1.1 Scope.....	3
1.2 Audience.....	3
1.3 Required knowledge.....	3
1.4 Acronyms and initialisms.....	3
1.5 Assistance and ordering phone numbers.....	3
1.6 Nokia quality processes.....	4
1.7 Safety information.....	4
1.8 Documents.....	4
1.9 Special information.....	4
1.9.1 Steps with options or substeps.....	5
1.10 Multiple PDF document search.....	6
2 ETSI environmental and CRoHS guidelines.....	9
2.1 Environmental labels.....	9
2.1.1 Overview.....	9
2.1.2 Environmental related labels.....	9
2.1.2.1 Products below Maximum Concentration Value (MCV) label.....	9
2.1.2.2 Products containing hazardous substances above Maximum Concentration Value (MCV) label.....	10
2.2 Hazardous Substances Table (HST).....	11
2.3 Other environmental requirements.....	11
2.3.1 Environmental requirements.....	11
2.3.2 Storage.....	12
2.3.3 Transportation.....	12
2.3.4 Stationary use.....	12
2.3.5 Thermal limitations.....	12
2.3.6 Material content compliance.....	12
2.3.7 End-of-life collection and treatment.....	13
2.4 Additional information.....	14
3 ETSI safety guidelines.....	15
3.1 Safety instructions.....	15
3.1.1 Safety instruction boxes.....	15
3.1.2 Safety-related labels.....	16
3.2 Safety standards compliance.....	16
3.2.1 EMC compliance.....	17
3.2.2 Equipment safety standard compliance.....	17
3.2.3 Environmental standard compliance.....	17
3.2.4 Laser product standard compliance.....	17
3.3 Electrical safety guidelines.....	18
3.3.1 Power supplies.....	18
3.3.2 Cabling.....	18
3.3.3 Protective earth.....	18
3.4 ESD safety guidelines.....	19
3.5 Environmental requirements.....	19
3.6 Additional information.....	19

4 ANSI safety guidelines	20
4.1 Safety instructions	20
4.1.1 Safety instruction boxes in customer documentation	20
4.1.2 Safety-related labels	21
4.2 Safety standards compliance	22
4.2.1 EMC, EMI, and ESD compliance	23
4.2.2 Equipment safety standard compliance	23
4.3 Electrical safety guidelines	23
4.3.1 Power supplies	24
4.3.2 Cabling	24
4.3.3 Protective earth	24
4.4 ESD safety guidelines	24
4.5 Environmental requirements	25
4.6 Additional information	25
5 Product overview	34
5.1 Overview of the Nokia FastMile 4G Receiver	34
5.2 End-to-end example	36
6 Functional overview	38
6.1 Overview	38
6.1.1 Nokia Wireless app	38
6.1.2 Web UI	39
6.1.3 Remote management	39
6.2 LTE characteristics	39
6.3 Data forwarding	40
6.4 Ethernet characteristics	40
6.5 Power supply characteristics	41
6.6 Remote management protocols	41
7 Model overview	44
7.1 Models of the Nokia FastMile 4G Receiver	44
7.1.1 Label information	45
8 Physical interfaces	45
8.1 Physical interfaces of the Compact mono-band and ABA models	46
8.2 Physical interfaces of the Compact multi-band models	47
9 SIM cards	50
9.1 SIM card information for the Compact mono-band and ABA models	50
9.2 SIM card information for the Compact multi-band models	51
10 LEDs	51
10.1 Status LED	52
10.2 Signal strength LEDs	53
11 Power information	55
11.1 Power information for the Nokia FastMile 4G Receiver	55
12 Performance information	56
12.1 Performance overview	56
12.2 Throughput information	56
12.3 Carrier aggregation information	57
12.4 Power consumption information	60
13 Management using the Nokia Wireless app	62
13.1 Using the Nokia Wireless app to manage the Nokia FastMile 4G Receiver	62

13.2 Using the Nokia Wireless app to manage a unit managed by the Nokia Altiplano FastMile Controller62

13.3 Using the Nokia Wireless app to manage a unit managed by an ACS81

14 Management using the Web UI 95

14.1 Using the Web UI to manage the Nokia FastMile 4G Receiver95

14.2 Using the Web UI status screen95

14.3 Using the Web UI network screen97

14.4 Using the Web UI system screen 109

15 Standards certification 114

15.1 Standards certification for Compact mono-band and ABA models 114

15.2 Standards certification for the Compact multi-band models..... 115

16 Appendix A: Specifications 115

16.1 Specifications115

17 Appendix B: RF exposure 117

17.1 RF exposure 117

18 Appendix C: FCC statements and label instructions 118

18.1 FCC compliance statement 118

18.2 FCC radiation exposure statement..... 118

18.3 FCC label instructions 119

19 Glossary 119

List of figures

2	ETSI environmental and CRoHS guidelines.....	9
Figure 1	Products below MCV value label.....	10
Figure 2	Products above MCV value label	11
Figure 3	Recycling/take back/disposal of product symbol.....	13
4	ANSI safety guidelines.....	21
Figure 4	Sample safety label for FCC.....	23
Figure 5	Sample safety label for ETL	23
5	Product overview.....	37
Figure 6	Application example of the Nokia FastMile 4G Receiver.....	38
Figure 7	Examples of model types of the Nokia FastMile 4G Receiver.....	39
Figure 8	End-to-end example featuring the Nokia FastMile 4G Receiver with a residential gateway and POE injector.....	40
6	Functional overview	41
Figure 9	Remote management of the Nokia FastMile 4G Receiver through the Nokia Altiplano FastMile Controller	45
Figure 10	Remote management of the Nokia FastMile 4G Receiver through an ACS.....	46
8	Physical interfaces	49
Figure 11	Location of physical interfaces on the Compact mono-band and ABA models of the Nokia FastMile 4G Receiver.....	50
Figure 12	Location of the ground point for the Compact multi-band models of the Nokia FastMile 4G Receiver.....	51
Figure 13	Location of physical interfaces on the underside of the Compact multi-band models of the Nokia FastMile 4G Receiver	52
9	SIM cards.....	53
Figure 14	Detailed view of SIM card slot on the Compact mono-band and ABA models.....	53
Figure 15	Detailed view of SIM card slot on the Compact multi-band models	54
10	LEDs.....	55
Figure 16	Location of the status LED on the Compact mono-band and ABA models of the Nokia FastMile 4G Receiver.....	55
Figure 17	Location of the status LED on the Compact multi-band models of the Nokia FastMile 4G Receiver.....	55
Figure 18	Location of the signal strength LEDs.....	57
Figure 19	Location of the measurement button.....	57
13	Management using the Nokia Wireless app.....	67
Figure 20	Introductory screen for unit managed by the Nokia Altiplano FastMile Controller through NETCONF.....	69
Figure 21	Screen with prompt to scan the QR code for unit managed by the Nokia Altiplano FastMile Controller through NETCONF.....	70
Figure 22	QR code screen for unit managed by the Nokia Altiplano FastMile Controller through NETCONF	71

Figure 23	Screen showing the Already Installed option for unit managed by the Nokia Altiplano FastMile Controller through NETCONF.....	72
Figure 24	Screen for connecting to the Nokia FastMile 4G Receiver.....	73
Figure 25	Screen for enabling the VPN profile.....	74
Figure 26	Prompt for accepting the connection request.....	75
Figure 27	Screen to log in to a Nokia FastMile 4G Receiver managed by the Nokia Altiplano FastMile Controller	76
Figure 28	System state screen example for a Nokia FastMile 4G Receiver managed by the Nokia Altiplano FastMile Controller.....	78
Figure 29	System state screen with Beam Angle information for a Nokia FastMile 4G Receiver managed by the Nokia Altiplano FastMile Controller.	79
Figure 30	Screen that has the “Upload CA certificates” option for a Nokia FastMile 4G Receiver managed by the Nokia Altiplano FastMile Controller.	80
Figure 31	Screen that lists the CA certificates for a Nokia FastMile 4G Receiver managed by the Nokia Altiplano FastMile Controller	81
Figure 32	Screen indicating that uploading of the CA certificates was successful for a Nokia FastMile 4G Receiver managed by the Nokia Altiplano FastMile Controller	82
Figure 33	Screen showing the “Reboot Device” option for a Nokia FastMile 4G Receiver managed by the Nokia Altiplano FastMile Controller.....	83
Figure 34	Screen showing the reboot message for a Nokia FastMile 4G Receiver managed by the Nokia Altiplano FastMile Controller	84
Figure 35	Screen showing the “Perform Factory Reset” option for a Nokia FastMile 4G Receiver managed by the Nokia Altiplano FastMile Controller.	85
Figure 36	Screen showing the factory reset message for a Nokia FastMile 4G Receiver managed by the Nokia Altiplano FastMile Controller	86
Figure 37	Introductory screen for unit managed by an ACS through TR-069	88
Figure 38	Screen with prompt to scan the QR code for unit managed by an ACS through TR-069.....	89
Figure 39	QR code screen for unit managed by an ACS through TR-069.....	90
Figure 40	Screen showing the Already Installed option for unit managed by an ACS through TR-069.....	91
Figure 41	Screen for connecting to the Nokia FastMile 4G Receiver.....	92
Figure 42	Screen for enabling the VPN profile.....	93
Figure 43	Prompt for accepting the connection request.....	94
Figure 44	Screen to log in to a Nokia FastMile 4G Receiver managed by an ACS through TR-069.....	95
Figure 45	System state screen example for a Nokia FastMile 4G Receiver managed by an ACS	97
Figure 46	System state screen with Beam Angle information for a Nokia FastMile 4G Receiver managed by an ACS.....	98
Figure 47	Screen that has the “Upload CA certificates” option for a Nokia FastMile 4G Receiver managed by an ACS.....	99
Figure 48	Screen showing the “Reboot Device” option for a Nokia FastMile 4G Receiver managed by an ACS	100
14	Management using the Web UI.....	101

Figure 49	Example of the Status screen when the FastMile 4G Receiver is not connected to a cell.....	102
Figure 50	Example of the Status screen when the FastMile 4G Receiver is connected to a cell.....	103
Figure 51	Example of the Login screen.....	105
Figure 52	Example of the Network screen.....	106
Figure 53	Example of scroll down for the Network screen	107
Figure 54	Example of the Add Access Point window	108
Figure 55	Example of the Delete APN window.....	109
Figure 56	Example of the Edit Location window.....	110
Figure 57	Example of the Edit Controller window.....	111
Figure 58	Example of the Edit DHCP window.....	112
Figure 59	Example of the Certificates information window.....	113
Figure 60	Example of the Add Cell window.....	114
Figure 61	Example of the Delete Cell window.....	115
Figure 62	Example of the System screen.....	116
Figure 63	Example of the Restart Device confirmation window	117
Figure 64	Example of the Restore Device confirmation window	118
Figure 65	Example of the screen that displays while firmware is being updated.....	119

List of tables

3	ETSI safety guidelines.....	15
Table 1	Safety labels.....	16
4	ANSI safety guidelines.....	21
Table 2	Safety labels.....	22
6	Functional overview	41
Table 3	E-UTRA bands supported by the Nokia FastMile 4G Receiver.....	43
Table 4	Data forwarding methods supported by the Nokia FastMile 4G Receiver	43
7	Model overview.....	47
Table 5	Models of the Nokia FastMile 4G Receiver.....	47
Table 6	Label information for the Nokia FastMile 4G Receiver.....	48
8	Physical interfaces	49
Table 7	Physical interfaces of the Compact mono-band and ABA models of the Nokia FastMile 4G Receiver.....	49
Table 8	Physical interfaces of the Compact multi-band models of the Nokia FastMile 4G Receiver.....	50
10	LEDs.....	55
Table 9	Status LED behavior for Nokia FastMile 4G Receiver managed from the Nokia Altiplano FastMile Controller.....	56
Table 10	Status LED behavior for Nokia FastMile 4G Receiver managed from an ACS.....	56
12	Performance information.....	61
Table 11	LTE throughput information.....	61
Table 12	Carrier aggregation support for the Compact mono-band and ABA models	62
Table 13	Carrier aggregation support for Model 4G04-A.....	63
Table 14	Carrier aggregation support for Model 4G05-A.....	64
Table 15	Power consumption information for all models.....	65
15	Standards certification.....	121
Table 16	Standards certifications for the Nokia FastMile 4G Receiver Compact mono-band and ABA models.....	121
Table 17	Standards certifications for the Nokia FastMile 4G Receiver Compact multi-band models.....	122
16	Appendix A: Specifications	123
Table 18	Specifications for the Nokia FastMile 4G Receiver	123
18	Appendix C: FCC statements and label instructions.....	127
Table 19	FCC ID for Nokia FastMile 4G Receiver.....	127

5 Product overview

5.1 Overview of the Nokia FastMile 4G Receiver

5.2 End-to-end example

5.1 Overview of the Nokia FastMile 4G Receiver

The Nokia FastMile 4G Receiver is an outdoor device used in the Nokia FastMile 4G solution.

The Nokia FastMile 4G solution uses 3GPP based LTE radio technology to provide indoor and outdoor broadband connectivity with guaranteed high bitrates in larger service areas in a more cost-efficient manner than is possible with other existing solutions. The Nokia FastMile 4G solution can overcome network performance challenges faced by today's mobile networks by optimizing all of the following:

- intra site interference due to neighbor sectors in same LTE base station
- inter site interference due to neighbor base stations
- link performance due to wall penetration loss and several miles path loss

The Nokia FastMile 4G Receiver provides high-performing, outdoor wireless broadband access over LTE to meet residential users' total home connectivity needs for urban, suburban, rural, and deep rural spots.

The Nokia FastMile 4G Receiver supports LTE connectivity to an LTE base station in the network, and provides 1 Gbps Ethernet connectivity through an Ethernet cable connected to a residential gateway such as the following in the home:

- Nokia 7368 ISAM CPE A-020W-A
- Nokia 7368 ISAM CPE A-240Z-A

The Nokia FastMile 4G Receiver can be installed on the side of a house or on a pole close to the house. A pole mount kit that includes a pole adapter can be ordered from Nokia.

Figure 6 shows an application example where the Nokia FastMile 4G Receiver is mounted on the side of a house.

Figure 6 Application example of the Nokia FastMile 4G Receiver

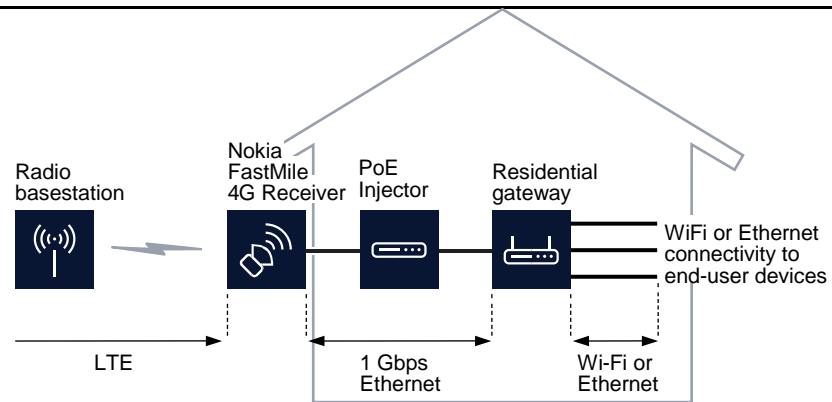

28814

The Nokia FastMile 4G Receiver is available in the following model types:

- Compact multi-band; this model type has the following features:
 - fixed beamforming antennas
 - multi-band transmission
- Compact mono-band; this model type has the following features:
 - fixed beamforming antennas
 - mono-band transmission
- ABA; this model type has the following features:
 - high gain beam steering antenna
 - automated beam alignment

Figure 7 shows examples of the model types of the Nokia FastMile 4G Receiver.

Figure 7 Examples of model types of the Nokia FastMile 4G Receiver

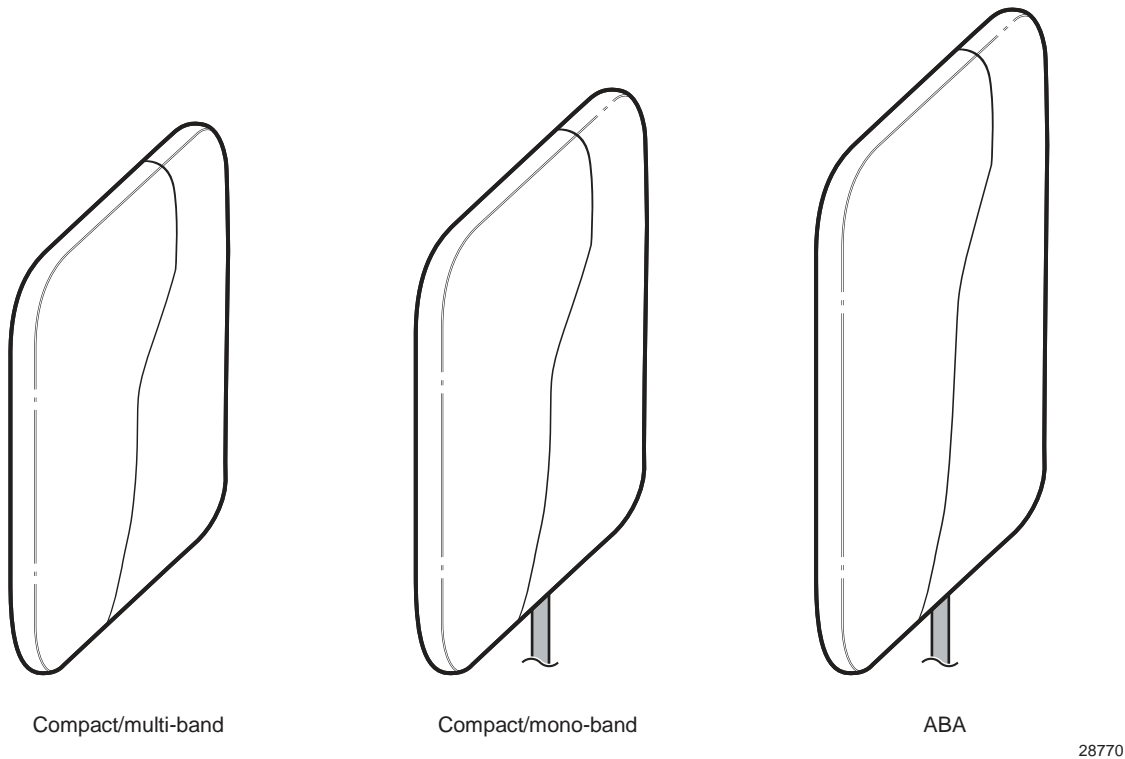

The Nokia FastMile 4G Receiver has built-in antenna and LTE modem that provide the LTE broadband access to the network.

The Nokia FastMile 4G Receiver is capable of withstanding outdoor environmental conditions. It has an IP rating of IP66 TYPE3. Compact mono-band and ABA models can operate in a temperature of -30°C to 65°C (-22°F to 149°F), and Compact multi-band models can operate in a temperature of -30°C to 55°C (-22°F to 131°F). See chapter 16 for additional specifications of the Nokia FastMile 4G Receiver.

5.2 End-to-end example

The Nokia FastMile 4G Receiver can be used to provide IPTV, Internet, and VoIP services to end-users that are connected to the Nokia FastMile 4G Receiver through a residential gateway and POE injector. The Nokia FastMile 4G Receiver can also connect directly to a video monitor, personal computer, and so on rather than using a residential gateway and POE injector.

Due to the independence between the Nokia FastMile 4G Receiver and the gateway,

the Nokia FastMile 4G Receiver also addresses the business market. The business customer can seamlessly re-use their existing business gateway. The Nokia FastMile 4G Receiver supports extended QCI and multiple APNs that can be mapped on VLANs to support QoS for different services.

Product overview

Figure 8 shows an end-to-end example that features the Nokia FastMile 4G Receiver with a residential gateway and POE injector.

Figure 8 End-to-end example featuring the Nokia FastMile 4G Receiver with a residential gateway and POE injector

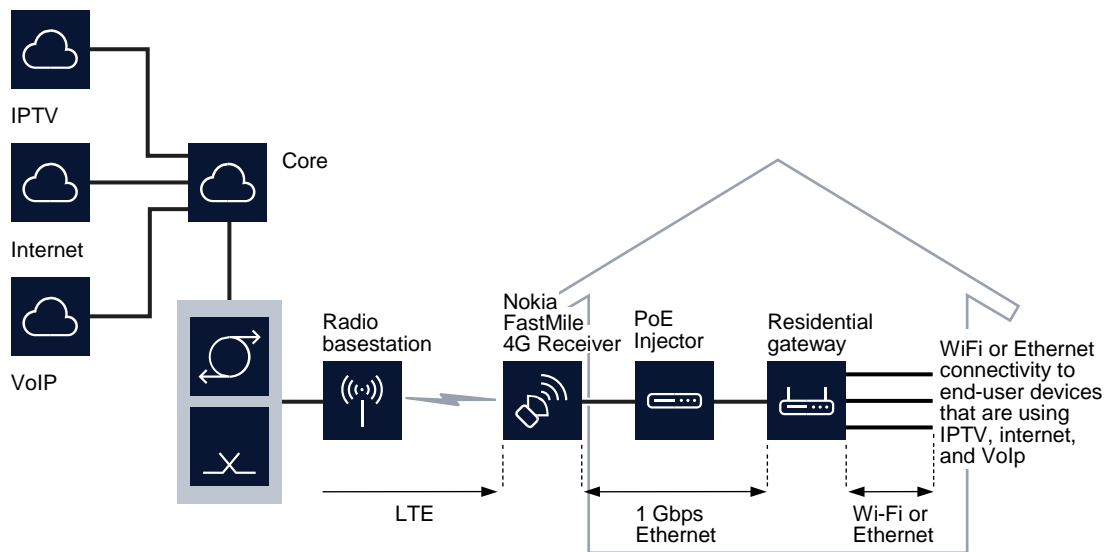

28815

6 Functional overview

6.1 Overview

6.2 LTE characteristics

6.3 Data forwarding

6.4 Ethernet characteristics

6.5 Power supply characteristics

6.6 Remote management protocols

6.1 Overview

The Nokia FastMile 4G Receiver provides wireless broadband access in the form of LTE to meet the ever growing network needs of end users. The Nokia FastMile 4G Receiver is an outdoor device that lets operators use LTE to offer fixed wireless broadband to their customers.

The Nokia FastMile 4G Receiver is easy to install and is user-friendly to operate.

6.1.1 Nokia Wireless app

The Nokia FastMile 4G Receiver can be installed with the assistance of an Android application, known as Nokia Wireless app, installed on a mobile phone. The app in general lets you scan the QR code of the receiver, identify the best location to install the receiver by measuring the signal strength and connect to the receiver over a VPN connection in order to apply configuration.

The Nokia Wireless app also provides management and troubleshooting capabilities for the Nokia FastMile 4G Receiver such as the following:

- viewing information that includes:
- LTE cell info such as connection state, status, EARFCN, and PCI
- current and average signal stats for RSRP, RSRQ, RSSI, and SINR
- other stats (for example, bytes sent and bytes received)
- uploading CA certificates to the Nokia FastMile 4G Receiver
- resetting the 4G Receiver to factory settings
- rebooting the 4G Receiver

See the Installation guide for more information about how the Nokia Wireless app is used in the installation process. See chapter 13 in this document for more information about how Nokia Wireless app can be used for management of the Nokia FastMile 4G Receiver.

6.1.2 Web UI

The Nokia FastMile 4G Receiver supports local management capability, allowing status view and configuration operations, through a Web UI for a Nokia FastMile 4G Receiver managed by an ACS through TR-069.

The Web UI can be accessed directly from a laptop through the Ethernet port of the Nokia FastMile 4G Receiver via the dedicated static IP address 192.168.0.1 (<https://192.168.0.1>). Alternatively, it is possible to access the Web UI from behind a Nokia-approved residential gateway which is appropriately configured.

It is recommended not to change or reconfigure the Nokia FastMile 4G Receiver static IP for the Web UI interface, since changing the default IP address (that is, 192.168.0.1) would impede access from the Web UI.

Web UI functionality is optimized for the Chrome browser (74.0.3729 or greater), but is not restricted to it.

The Web UI design is optimized for a resolution of 1920x1080 pixels, but is not restricted to it.

See chapter 14 in this document for information about using the Web UI to manage the Nokia FastMile 4G Receiver.

6.1.3 Remote management

The Nokia FastMile 4G Receiver supports remote management capability, allowing management and health monitoring of it from the Nokia Altiplano FastMile Controller (through NETCONF) or from an ACS (through TR-069).

See the documentation for the Nokia Altiplano FastMile Controller for information about managing and monitoring the Nokia FastMile 4G Receiver through the Nokia Altiplano FastMile Controller.

See section 6.6 for information about the remote management protocols.

6.2 LTE characteristics

The following are some of the key LTE characteristics of the Nokia FastMile 4G Receiver:

- LTE 3GPP Release 12 Compliant, UE Category 12
- supports the E-UTRA bands listed in Table 3

Table 3 E-UTRA bands supported by the Nokia FastMile 4G Receiver

E-UTRA bands	Model
Band 42/43/48 (mono-band support)	4G01-A
Band 42/43/48 (ABA support)	4G01-B
Band 3 (mono-band support)	4G02-A
Band 7/38/40/41 (mono-band support)	4G03-A
Band B3/B7/B20/B32 (multi-band support)	4G04-A
Band B1/B3/B7/B38/B40/B41/B20/B28 (multi-band support)	4G05-A

6.3 Data forwarding

The Nokia FastMile 4G Receiver supports the following data forwarding methods:

Table 4 Data forwarding methods supported by the Nokia FastMile 4G Receiver

Forwarding mode	Typical use
Single APN with multi-bearers for route mode	Recommended for using only one APN specific for Nokia FastMile 4G Receiver
Single APN with multi-bearers for bridge mode	Could be used for WAN of IDU with VLAN tag
Multiple APNs with bridge mode	Used as multi-APN, separated service with APNs: each APN is for each service. Note in this case, a specific port should be reserved for service traffic.
Multiple APNs with mixed mode	Can be used for separated APNs on OAM and also other APNs for separated services: <ul style="list-style-type: none"> • Only default APN is in route mode which could be OAM • Besides APN, each APN is for each service
Tunnel mode	Can be used for using tunnel for L2 forwarding such as PPPoE

6.4 Ethernet characteristics

The following are some of the key Ethernet characteristics of the Nokia FastMile 4G Receiver:

- provides a 1 Gbps Ethernet LAN Interface that, depending on the model of the Nokia FastMile 4G Receiver, has the following:
- the Compact mono-band and ABA models have a pre-attached 3 m (9.8 ft) Cat5e shielded twisted pair Ethernet cable with a male RJ 45 connector at the free end • the Compact multi-band and models have a female RJ 45 connector that supports

connection of a customer-supplied Cat5e shielded twisted pair Ethernet cable with standard pinouts that is up to a maximum of 80 m (262 ft) in length

- supports IEEE802.3 1000BASE-T
- supports IEEE802.3az energy efficient Ethernet
- the Ethernet cable for all models is also used for power over Ethernet (PoE) as per IEEE802.3 at type-2

6.5 Power supply characteristics

The following are some of the key power supply characteristics of the Nokia FastMile 4G Receiver:

- powered through PoE from a residential gateway, or through a PoE injector
- supports PoE+ as per IEEE802.3 at type-2
- rating: 53 VDC at 600 mA

See section [11.1](#) for power information.

6.6 Remote management protocols

Remote management of the Nokia FastMile 4G Receiver can be done from the Nokia Altiplano FastMile Controller through NETCONF or from an ACS through TR-069/TR181 depending on the installed SIM card.

For the first startup, the Nokia FastMile 4G Receiver starts from the NETCONF version. The Nokia FastMile 4G Receiver will automatically detect the remote management protocol through information that is on the SIM card installed in the unit. If the Nokia FastMile 4G Receiver detects that the remote management protocol on the SIM card is TR-069/TR181, it restarts and starts up with TR-069/TR181 management.

If the remote management protocol is NETCONF, the Nokia FastMile 4G Receiver can be managed remotely from the Nokia Altiplano FastMile Controller.

If the remote management protocol is TR-069, the Nokia FastMile 4G Receiver can be managed remotely from an ACS.

Figure 9 shows the Nokia Altiplano FastMile Controller being used for remote management of the Nokia FastMile 4G Receiver. Note that NETCONF is used by the Nokia Altiplano FastMile Controller to manage the Nokia FastMile 4G Receiver, and that an ACS manages the residential gateway through TR-069.

Figure 9 Remote management of the Nokia FastMile 4G Receiver through the Nokia Altiplano FastMile Controller

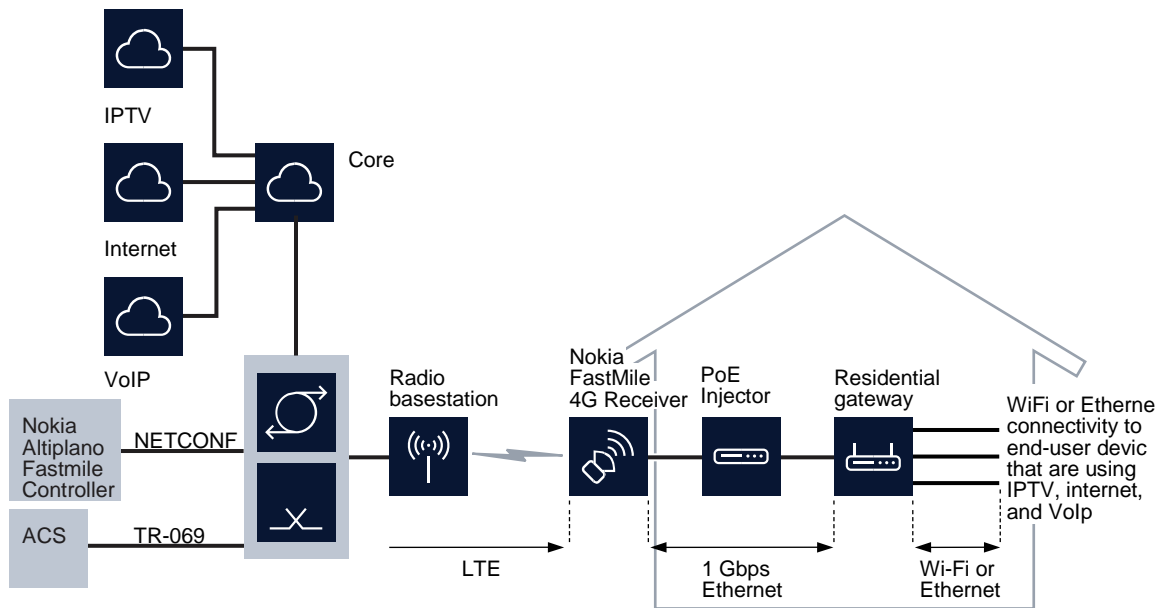
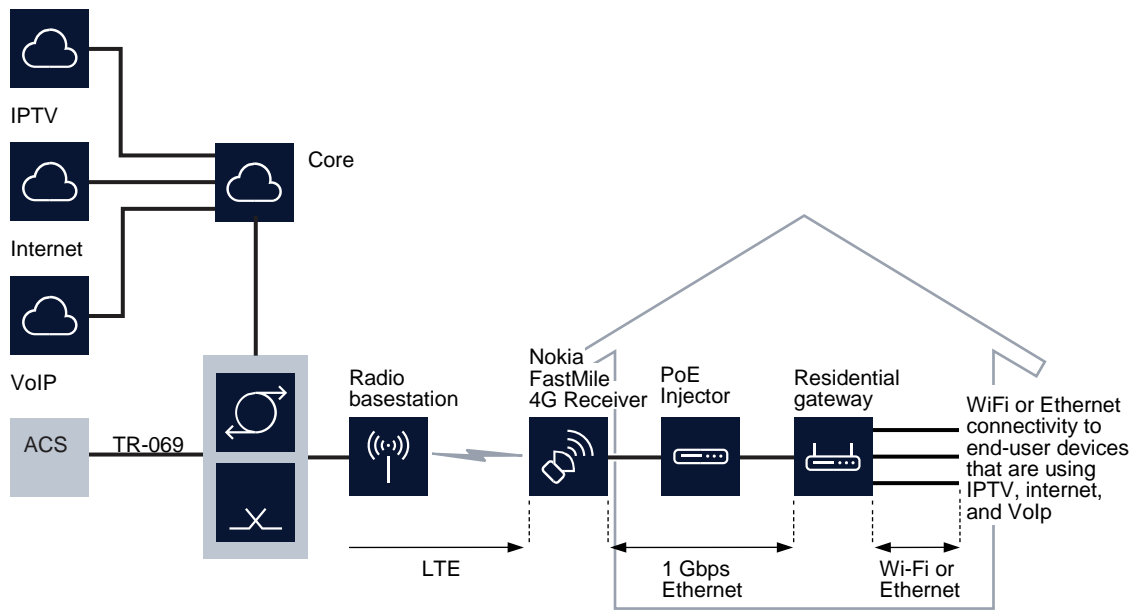

Figure 10 shows an ACS being used for remote management of the Nokia FastMile 4G Receiver. Note that the ACS uses TR-069 to manage both the Nokia FastMile 4G Receiver and the residential gateway.

Figure 10 Remote management of the Nokia FastMile 4G Receiver through an ACS



28817

7 Model overview

7.1 Models of the Nokia FastMile 4G Receiver

7.1 Models of the Nokia FastMile 4G Receiver

A wide range of models are available for the Nokia FastMile 4G Receiver to support different E-UTRA bands and band combinations for LTE.

All models can be wall-mounted or pole-mounted. If you will be mounting the Nokia FastMile 4G Receiver on a pole, you will need kit 3TG-00291-AA that contains the pole adapter for the Nokia FastMile 4G Receiver. Note that pole strapping and wall fasteners are not provided by Nokia.

Table 5 describes the E-UTRA band and frequency support and the antenna configurations for each model of the Nokia FastMile 4G Receiver.

Table 5 Models of the Nokia FastMile 4G Receiver

Model	E-UTRA band support and frequencies	Antenna configuration	Model type
4G01-A	<ul style="list-style-type: none"> Band 42: TDD, 3400 MHz – 3600 MHz Band 43: TDD, 3600 MHz – 3800 MHz Band 48: TDD, 3650 MHz – 3700 MHz 	Integrated with 15 dBi fixed beamforming antenna	Compact mono-band
4G01-B	<ul style="list-style-type: none"> Band 42: TDD, 3400 MHz – 3600 MHz Band 43: TDD, 3600 MHz – 3800 MHz Band 48: TDD, 3650 MHz – 3700 MHz 	Integrated with 3x4 dual polarized antenna array, electronic beam steering +/- 45° horizontally, and up to 17 dBi peak antenna gain with beam steering	ABA
4G02-A	<ul style="list-style-type: none"> Band 3: FDD, Tx 1710 MHz – 1785 MHz, Rx 1805 MHz – 1880 MHz 	Integrated with 10.5 dBi fixed beamforming antenna	Compact mono-band
4G03-A	<ul style="list-style-type: none"> Band 7: FDD, Tx 2500 MHz – 2570 MHz, Rx 2620 MHz – 2690 MHz Band 38: TDD, 2570 MHz – 2620 MHz Band 40: TDD, 2300 MHz – 2400 MHz Band 41: TDD, 2496 MHz – 2690 MHz 	Integrated with 12.5 dBi fixed beamforming antenna	Compact mono-band
4G04-A	<ul style="list-style-type: none"> Band 3: FDD, Tx 1710 MHz – 1785 MHz, Rx 1805 MHz – 1880 MHz Band 7: FDD, Tx 2500 MHz – 2570 MHz, Rx 2620 MHz – 2690 MHz Band 20: FDD, Tx 832 MHz – 862 MHz, Rx 791 MHz – 821 MHz Band 32: FDD, Rx 1452 MHz – 1496 MHz 	<ul style="list-style-type: none"> Band 7 is integrated with > 11 dBi fixed beamforming antenna Band 3 is integrated with > 9 dBi fixed beamforming antenna Band 32 is integrated with > 6 dBi fixed beamforming antenna Band 20 is integrated with > 3 dBi fixed beamforming antenna 	Compact multi-band

(1 of 2)

Model	E-UTRA band support and frequencies	Antenna configuration	Model type
4G05-A	<ul style="list-style-type: none"> • Band 1: FDD, Tx 1920 MHz –1980 MHz, Rx 2110 MHz –2170 MHz • Band 3: FDD, Tx 1710 MHz –1785 MHz, Rx 1805 MHz – 1880 MHz • Band 7: FDD, Tx 2500 MHz – 2570 MHz, Rx 2620 MHz – 2690 MHz • Band 38: TDD, 2570 MHz – 2620 MHz • Band 40: TDD, 2300 MHz – 2400 MHz • Band 41: TDD, 2496 MHz – 2690 MHz • Band 20: FDD, Tx 832 MHz – 862 MHz, Rx 791 MHz – 821 MHz • Band 28: FDD, Tx 703 MHz – 748 MHz, Rx 758 MHz – 803 MHz 	Bands 7, 38, 40, and 41 are integrated with > 11 dBi fixed beamforming antenna Bands 1 and 3 are integrated with > 9 dBi fixed beamforming antenna Bands 20 and 28 are integrated with > 3 dBi fixed beamforming antenna	Compact multi-band

(2 of 2)

7.1.1 Label information

Table 6 describes the label information for the Nokia FastMile 4G Receiver.

Table 6 Label information for the Nokia FastMile 4G Receiver

Model	Product details
4G01-A	Nokia FM compact
4G01-B	Nokia FM ABA
4G02-A	Nokia FM compact
4G03-A	Nokia FM compact
4G04-A	Nokia FastMile Receiver
4G05-A	Nokia FastMile Receiver

Physical interfaces

8 Physical interfaces

8.1 Physical interfaces of the Compact mono-band and ABA models

8.2 Physical interfaces of the Compact multi-band models

8.1 Physical interfaces of the Compact mono-band and ABA models

Table 7 describes the physical interfaces of the Compact mono-band and ABA models of the Nokia FastMile 4G Receiver.

Table 7 Physical interfaces of the Compact mono-band and ABA models of the Nokia FastMile 4G Receiver

Interface	Description
Ground point	Point for connecting to external ground Located on the underside of the unit; see Figure 11.
Ethernet cable	Ethernet connectivity for the Compact mono-band and ABA models is through a pre-attached 3 m (9.8 ft) cat5e shielded Ethernet cable; the same cable is also used for power (PoE as per IEEE802.3 at type-2). Located on the underside of the unit; see Figure 11. The pre-attached Ethernet cable has a male RJ 45 connector at the free end. An additional length of cat5e shielded Ethernet cabling can be attached to the Ethernet cable up to a maximum of 80 m (262 ft) in combined length. A waterproof IP67 female RJ 45 plug is needed to connect the Ethernet cabling to the Ethernet cable of the Nokia FastMile 4G Receiver.
Status LED	Single multifunction LED that indicates status information for the Nokia FastMile 4G Receiver. Located on the underside of the unit; see Figure 11. See section 10.1 for the behavior of the status LED of the Compact mono-band and ABA models.
Reset button	Button to reset the Nokia FastMile 4G Receiver. Located on the underside of the unit; see Figure 11.
SIM slot	Slot for Nano/4FF SIM card for a Compact mono-band model or ABA model of the Nokia FastMile 4G Receiver. Located on the underside of the unit; see Figure 11. If the SIM card needs to be replaced, the Nokia FastMile 4G Receiver needs to be put in a powered off state before the SIM card can be removed and the new one inserted See section 9.1 for SIM card information for the Compact mono-band and ABA models of the Nokia FastMile 4G Receiver.

Figure 11 shows the location of the physical interfaces on the Compact mono-band and ABA models of the Nokia FastMile 4G Receiver.

Physical interfaces

Figure 11 Location of physical interfaces on the Compact mono-band and ABA models of the

Nokia FastMile 4G Receiver

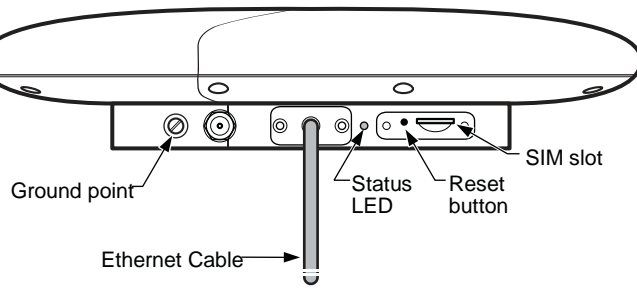

28797

8.2 Physical interfaces of the Compact multi-band models

Table 8 describes the physical interfaces of Compact multi-band models of the Nokia FastMile 4G Receiver.

Table 8 Physical interfaces of the Compact multi-band models of the Nokia FastMile 4G Receiver

Interface	Description
Ground point	Point for connecting to external ground Located on the back of the unit; see Figure 12.
Ethernet port	The Compact multi-band models have a female RJ 45 connector for attaching a customer-supplied cat5e shielded Ethernet cable with standard pinouts that is a maximum of 80 m (262 ft) in length; the same cable is also used for power (PoE as per IEEE802.3 at type-2). Located on the underside of the unit; see Figure 13.
Status LED	Single multifunction LED that indicates status information for the Nokia FastMile 4G Receiver. Located on the top of the unit. See section 10.1 for a figure showing the location of the status LED of the Compact multi-band models and information about its behavior.
Signal strength LEDs	The Compact multi-band models have a set of five LEDs that work together to indicate the LTE signal strength detected by the Nokia FastMile 4G Receiver. Located on the top of the unit. See section 10.2 for a figure showing the location of the signal strength LEDs and information about their behavior.
Measurement button	Button to activate the signal strength LEDs Located on the side of the unit. See section 10.2 for a figure showing the location of the measurement button and information about using it to activate the signal strength LEDs.

(1 of 2)

Physical interfaces

Interface	Description
Reset button	Button to reset the Nokia FastMile 4G Receiver. Located on the underside of the unit; see Figure 13.
SIM slot	Slot for Nano/4FF SIM card for a Compact multi-band model of the Nokia FastMile 4G Receiver. Located on the underside of the unit; see Figure 13. See section 9.2 for SIM card information for the Compact multi-band models of the Nokia FastMile 4G Receiver.

(2 of 2)

Figure 12 shows the location of the ground point for the Compact multi-band models of the Nokia FastMile 4G Receiver.

Figure 12 Location of the ground point for the Compact multi-band models of the Nokia FastMile 4G Receiver

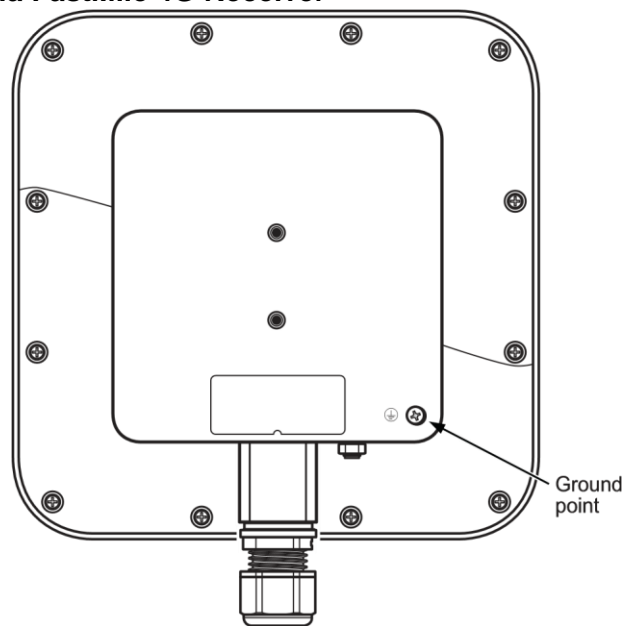

28798

Figure 13 shows the location of the physical interfaces that are on the underside of the Compact multi-band models of the Nokia FastMile 4G Receiver.

Physical interfaces

Figure 13 Location of physical interfaces on the underside of the Compact

multi-band models of the Nokia FastMile 4G Receiver

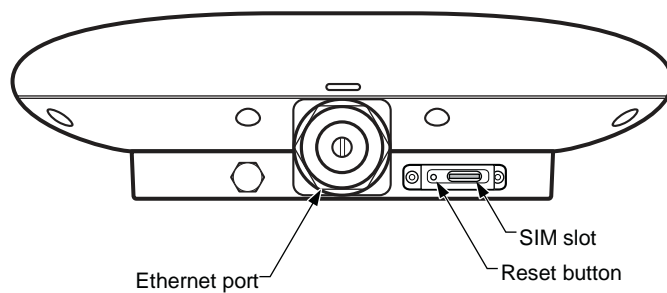

28771

9 SIM cards

9.1 SIM card information for the Compact mono-band and ABA models

9.2 SIM card information for the Compact multi-band models

9.1 SIM card information for the Compact mono-band and ABA models

The SIM card installed in the Nokia FastMile 4G Receiver allows the Nokia FastMile 4G Receiver to connect to the LTE network and determines the remote management protocol supported for the Nokia FastMile 4G Receiver; see section 6.6 for more information about remote management.

Figure 14 shows a detailed view of the SIM card slot on the Compact mono-band and ABA models of the Nokia FastMile 4G Receiver.

Figure 14 Detailed view of SIM card slot on the Compact mono-band and ABA models

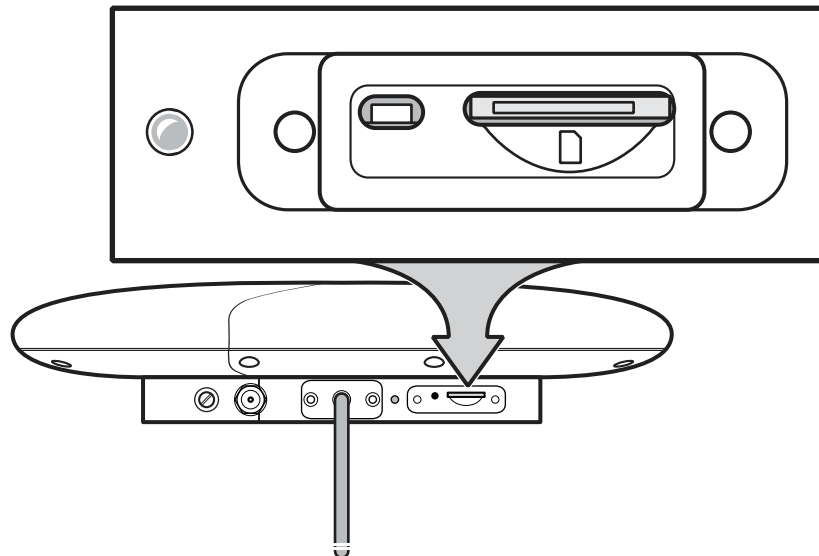

28642

The Nokia FastMile 4G Receiver Installation Guide provides detailed steps for inserting the SIM card. The SIM card must be appropriate for the remote management protocol to be used for the Nokia FastMile 4G Receiver.

9.2 SIM card information for the Compact multi-band models

The SIM card installed in the Nokia FastMile 4G Receiver allows the Nokia FastMile 4G Receiver to connect to the LTE network and determines the remote management protocol supported for the Nokia FastMile 4G Receiver; see section 6.6 for more information about remote management.

Figure 15 shows a detailed view of the SIM card slot on the Compact multi-band models of the Nokia FastMile 4G Receiver.

Figure 15 Detailed view of SIM card slot on the Compact multi-band models

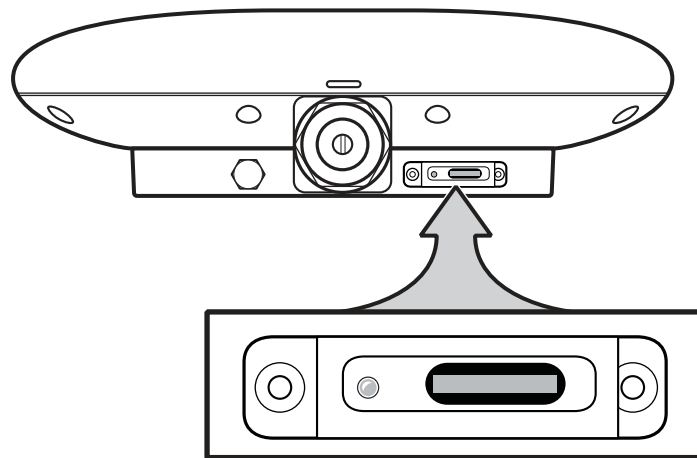

28802

The Nokia FastMile 4G Receiver Installation Guide provides detailed steps for inserting the SIM card. The SIM card must be appropriate for the remote management protocol to be used for the Nokia FastMile 4G Receiver.

LEDs

10 LEDs

10.1 Status LED

10.2 Signal strength LEDs

10.1 Status LED

All models of the Nokia FastMile 4G Receiver have a status LED:

- Figure 16 shows the location of the status LED on the Compact mono-band and ABA models of the Nokia FastMile 4G Receiver
- Figure 17 shows the location of the status LED on the Compact multi-band models of the Nokia FastMile 4G Receiver

Figure 16 Location of the status LED on the Compact mono-band and ABA models of the Nokia FastMile 4G Receiver

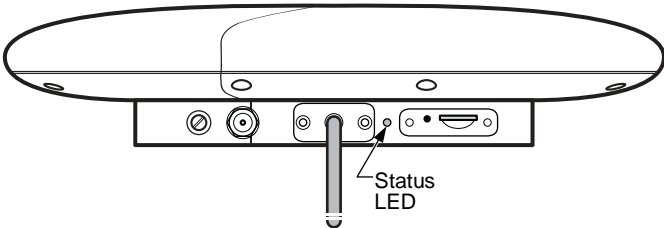

28799

Figure 17 Location of the status LED on the Compact multi-band models of the Nokia FastMile 4G Receiver

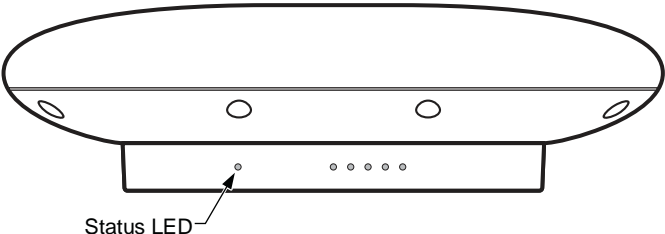

28772

The status LED behaves differently depending on whether the Nokia FastMile 4G Receiver is managed from:

- the Nokia Altiplano FastMile Controller (through NETCONF): see Table 9 •
- an ACS (through TR-069): see Table 10

LEDs

Table 9 Status LED behavior for Nokia FastMile 4G Receiver managed from the Nokia Altiplano FastMile Controller

LED color	LED priority	LED behavior	Status information
-----------	--------------	--------------	--------------------

Blue	First priority	Blinking	Bluetooth connection in progress
		Solid	Bluetooth connection established
		Off	No Bluetooth connection
Red	Second priority	Blinking	Critical alarm
		Solid	Major or minor alarm
		Off	No alarm
Green	Third priority	Blinking twice per second	Kernel and application start up
		Blinking one per second	Application start up
		Solid	Start up
		Off	OAM link is established

Table 10 Status LED behavior for Nokia FastMile 4G Receiver managed from an ACS

LED color	LED priority	LED behavior	Status information
Blue	First priority	Blinking	Bluetooth connection in progress
		Solid	Bluetooth connection established
		Off	No Bluetooth connection
Green	Second priority	Blinking twice per second	Kernel and application start up
		Blinking one per second	Application start up
		Solid	Start up
		Off	Software is stable

10.2 Signal strength LEDs

Five signal strength LEDs are provided on the Compact multi-band models of the Nokia FastMile 4G Receiver as shown in Figure 18.

LEDs

Figure 18 Location of the signal strength LEDs

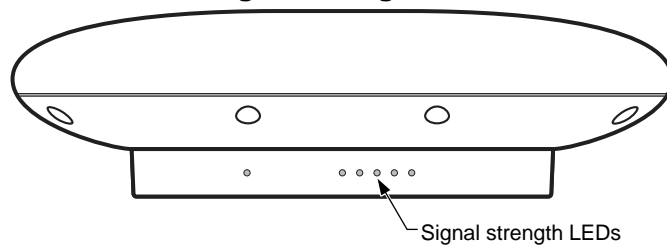

28773

The signal strength LEDs can be activated by pressing the measurement button on the side of the Compact multi-band models of the Nokia FastMile 4G Receiver.

Figure 19 shows the location of the measurement button.

Figure 19 Location of the measurement button

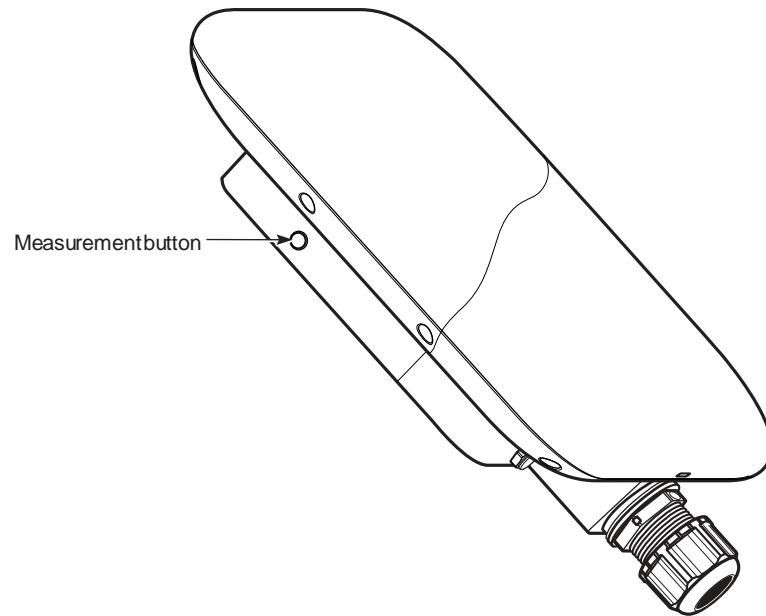

28885

The signal strength LEDs act as a set to indicate the LTE signal strength detected by the Nokia FastMile 4G Receiver. For example, if the signal strength is fourth level, then LEDs 1, 2, 3, and 4 are lit. The Nokia FastMile 4G Receiver Installation Guide provides more information about the signal strength LEDs.

LEDs

11 Power information

11.1 Power information for the Nokia FastMile 4G Receiver

11.1 Power information for the Nokia FastMile 4G Receiver

The Nokia FastMile 4G Receiver receives power through a Cat5e shielded Ethernet cable connected to a residential gateway or a PoE injector:

- The Compact mono-band and ABA models have a pre-attached 3 m (9.8 ft) Cat5e shielded twisted pair Ethernet cable with a male RJ 45 connector at the free end. An additional length of cat5e shielded Ethernet cabling can be attached to the Ethernet cable up to a maximum of 80 m (262 ft) in combined length. A waterproof IP67 female RJ 45 plug is needed to connect the Ethernet cabling to the Ethernet cable of the Nokia FastMile 4G Receiver.
- The Compact multi-band models have a female RJ 45 connector for attaching a customer-supplied cat5e shielded Ethernet cable with standard pinouts that is a maximum of 80 m (262 ft) in length.

See section [12.4](#) for power consumption information.

Power information

12 Performance information

12.1 Performance overview

12.2 Throughput information

12.3 Carrier aggregation information

12.4 Power consumption information

12.1 Performance overview

This chapter provides the following performance information for the Nokia FastMile 4G Receiver:

- throughput information: see section [12.2](#)
- carrier aggregation information: see section [12.3](#)
- power consumption information: section [12.4](#)

Some performance metrics for the Nokia FastMile 4G Receiver can be viewed through the Nokia Wireless app or Web UI or accessed through the Nokia Altiplano FastMile Controller:

- see chapter [13](#) for more information about viewing information for the Nokia FastMile 4G Receiver through the Nokia Wireless app
- see chapter [14](#) for more information about viewing information for the Nokia FastMile 4G Receiver through the Web UI
- see the documentation for the Nokia Altiplano FastMile Controller for more information about accessing information for the Nokia FastMile 4G Receiver through the Nokia Altiplano FastMile Controller

12.2 Throughput information

Table [11](#) provides LTE throughput information for the Nokia FastMile 4G Receiver.

Table 11 LTE throughput information

Mode	UDP DL (3CA)	TCP DL (3CA)	UDP UL	TCP UL
FDD	560M	360M	73M	73M
TDD	415M	360M	14M	18M

The results in the above table are based on the following:

- Downlink: DL 3xCA 2x2MIMO 256 QAM
- Uplink: single carrier 64 QAM
- FDD inter-band 3CA
- TDD Band 41 intra-Band 3CA, configuration is configuration 2, subframe 7
- Base Bandwidth 20M
- Data rates can have a margin of 2%
- Packet length is 1470B for UDP
- Window is 1000k for TCP
- Data rates are for IPv4 cases
- Data forwarding working on router model

The end-to-end throughput is achieved in the conductive mode with cable connected.

Ethernet throughput for the Nokia FastMile 4G Receiver is as per standard Ethernet 1000BASE-T, with a maximum of 1000 Mbps. The Ethernet link gets negotiated at 1000 Mbps when a residential gateway or a PoE injector is connected to the Nokia FastMile 4G Receiver.

12.3 Carrier aggregation information

The following tables provide carrier aggregation support information for the Nokia FastMile 4G Receiver:

- Compact mono-band and ABA models: Table 12
- Compact multi-band B3/B7/B20/B32 (Model 4G04-A): Table 13
- Compact multi-band B1/B3/B7/B38/B40/B41/B20/B28 (Model 4G05-A): Table 14

Table 12 Carrier aggregation support for the Compact mono-band and ABA models

Band	Downlink	Carrier aggregation support
B42	3400 MHz-3600 MHz	Up to 40 MHz bandwidth contiguous 2CA
		Up to 40 MHz bandwidth non-contiguous 2CA
		Up to 60 MHz bandwidth contiguous 3CA
		Up to 60 MHz bandwidth non-contiguous 3CA
B43	3600 MHz-3800 MHz	Up to 40 MHz bandwidth contiguous 2CA
		Up to 40 MHz bandwidth non-contiguous 2CA
		Up to 60 MHz bandwidth contiguous 3CA
		Up to 60 MHz bandwidth non-contiguous 3CA

(1 of 2)

Band	Downlink	Carrier aggregation support
B48	3650 Mhz-3700 MHz	Up to 40 MHz bandwidth contiguous 2CA
		Up to 40 MHz bandwidth non-contiguous 2CA
		Up to 50 MHz bandwidth contiguous 3CA
		Up to 50 MHz bandwidth non-contiguous 3CA
B3	1805 MHz-1880 MHz	Up to 40 MHz bandwidth contiguous 2CA
		Up to 40 MHz bandwidth non-contiguous 2CA
B7	2620 MHz-2690 MHz	Up to 40 MHz bandwidth contiguous 2CA
		Up to 40 MHz bandwidth non-contiguous 2CA
		Up to 60 MHz bandwidth contiguous 3CA
B38	2570 MHz-2620 MHz	Up to 40 MHz bandwidth contiguous 2CA
		Up to 40 MHz bandwidth non-contiguous 2CA
		Up to 60 MHz bandwidth contiguous 3CA
B40	2300 MHz-2400 MHz	Up to 40 MHz bandwidth contiguous 2CA
		Up to 40 MHz bandwidth non-contiguous 2CA
		Up to 60 MHz bandwidth contiguous 3CA
B41	2496 MHz-2690 MHz	Up to 40 MHz bandwidth contiguous 2CA
		Up to 40 MHz bandwidth non-contiguous 2CA
		Up to 60 MHz bandwidth contiguous 3CA
B42 and B43	3400 MHz-3800 MHz	Up to 40 MHz bandwidth interband 2CA

(2 of 2)

Table 13 provides carrier aggregation support information for the Compact multi-band B3/B7/B20/B32 (Model 4G04-A) of the Nokia FastMile 4G Receiver.

Table 13 Carrier aggregation support for Model 4G04-A

Bands	Downlinks	Uplinks	Carrier aggregation support
B3+B20	1805 MHz - 1880 MHz +791 MHz - 821 MHz		Up to 40 MHz bandwidth inter band 2CA
B7+B20	2620 MHz - 2690 MHz +791 MHz - 821 MHz		Up to 40 MHz bandwidth inter band 2CA
B3+B7	1805 MHz - 1880 MHz +2620 MHz - 2690 MHz		Up to 40 MHz bandwidth inter band 2CA
B3+B32	1805 MHz - 1880 MHz +1452 MHz - 1496 MHz		Up to 40 MHz bandwidth inter band 2CA

B20+B32	791 MHz - 821 MHz +1452 MHz - 1496 MHz		Up to 40 MHz bandwidth inter band 2CA
---------	---	--	--

(1 of 2)

Bands	Downlinks	Uplinks	Carrier aggregation support
B7+B32	2620 MHz - 2690 MHz +1452 MHz - 1496 MHz		Up to 40 MHz bandwidth inter band 2CA
B3+B7+B20	1805 MHz - 1880 MHz +2620 MHz - 2690 MHz +791 MHz - 821 MHz		Up to 60 MHz bandwidth inter band 3CA
B3+B7+B32	1805 MHz - 1880 MHz +2620 MHz - 2690 MHz +1452 MHz - 1496 MHz		Up to 60 MHz bandwidth inter band 3CA
B3+B20		1805 MHz - 1880 MHz +791 MHz - 821 MHz	Up to 40 MHz bandwidth inter band 2CA
B7+B20		2620 MHz - 2690 MHz +791 MHz - 821 MHz	Up to 40 MHz bandwidth inter band 2CA
B3+B7		1805 MHz - 1880 MHz +2620 MHz - 2690 MHz	Up to 40 MHz bandwidth inter band 2CA

(2 of 2)

Table 14 provides carrier aggregation support information for the Compact multi-band B1/B3/B7/B38/B40/B41/B20/B28 (Model 4G05-A) of the Nokia FastMile 4G Receiver.

Table 14 Carrier aggregation support for Model 4G05-A

Band	Downlink	Carrier aggregation support
B1	2110 MHz - 2170 MHz	Up to 40 MHz bandwidth contiguous 2CA
		Up to 60 MHz bandwidth contiguous 3CA
B3	1805 MHz - 1880 MHz	Up to 40 MHz bandwidth contiguous 2CA
		Up to 60 MHz bandwidth contiguous 3CA
B7	2620 MHz - 2690 MHz	Up to 40 MHz bandwidth contiguous 2CA
		Up to 60 MHz bandwidth contiguous 3CA
B38	2570 MHz - 2620 MHz	Up to 40 MHz bandwidth contiguous 2CA
		Up to 50 MHz bandwidth contiguous 3CA
B40	2300 MHz - 2400 MHz	Up to 40 MHz bandwidth contiguous 2CA
		Up to 60 MHz bandwidth contiguous 3CA
		Up to 80 MHz bandwidth contiguous 3CA

B41	2496 MHz – 2690 MHz	Up to 40 MHz bandwidth contiguous 2CA
		Up to 60 MHz bandwidth contiguous 3CA
		Up to 80 MHz bandwidth contiguous 3CA

(1 of 2)

Band	Downlink	Carrier aggregation support
B20	791 MHz - 821 MHz	Up to 30 MHz bandwidth contiguous 2CA
		Up to 30 MHz bandwidth non-contiguous 2CA
B28	758 MHz - 803 MHz	Up to 40 MHz bandwidth contiguous 2CA
B3+B41	1805 MHz - 1880 MHz +2496 MHz - 2690 MHz	Up to 40 MHz bandwidth inter band 2CA
B1+B41	2110 MHz - 2170 MHz +2496 MHz - 2690 MHz	Up to 40 MHz bandwidth inter band 2CA
B1+B38	2110 MHz - 2170 MHz +2570 MHz - 2620 MHz	Up to 40 MHz bandwidth inter band 2CA
B3+B40+B28	1805 MHz - 1880 MHz +2300 MHz - 2400 MHz +758 MHz - 803 MHz	Up to 40 MHz bandwidth inter band 2CA (all permutations)
		Up to 60 MHz bandwidth inter band 3CA
B1+B3+B40	2110 MHz - 2170 MHz +1805 MHz - 1880 MHz +2300 MHz - 2400 MHz	Up to 40 MHz bandwidth inter band 2CA (all permutations)
		Up to 60 MHz bandwidth inter band 3CA
B1+B3+B7+B28	2110 MHz - 2170 MHz +1805 MHz - 1880 MHz +2620 MHz - 2690 MHz +758 MHz - 803 MHz	Up to 40 MHz bandwidth inter band 2CA (all permutations)
		Up to 60 MHz bandwidth inter band 3CA (all permutations)
B1+B3+B7+B20	2110 MHz - 2170 MHz +1805 MHz - 1880 MHz +2620 MHz - 2690 MHz +791 MHz - 821 MHz	Up to 40 MHz bandwidth inter band 2CA (all permutations)
		Up to 60 MHz bandwidth inter band 3CA (all permutations)

(2 of 2)

12.4 Power consumption information

Table 15 provides power consumption information for all models of the Nokia FastMile 4G Receiver.

Table 15 Power consumption information for all models

Condition	Power consumption
-----------	-------------------

Maximum power output	7 w
Idle power	1 w

13 Management using the Nokia Wireless app

13.1 Using the Nokia Wireless app to manage the Nokia FastMile 4G Receiver

13.2 Using the Nokia Wireless app to manage a unit managed by the Nokia Altiplano FastMile Controller

13.3 Using the Nokia Wireless app to manage a unit managed by an ACS

13.1 Using the Nokia Wireless app to manage the Nokia FastMile 4G Receiver

After the Nokia FastMile 4G Receiver has been installed as described in the installation guide, you can use the Nokia Wireless app to perform management activities on it, such as viewing information, uploading CA certificates, rebooting the Nokia FastMile 4G Receiver, or resetting to factory settings.

There are some differences in managing the Nokia FastMile 4G Receiver through the Nokia Wireless app depending on whether the Nokia FastMile 4G Receiver is managed remotely by the Nokia Altiplano FastMile Controller (through NETCONF) or by an ACS (through TR-069):

- if the Nokia Altiplano FastMile Controller is being used for remote management of the Nokia FastMile 4G Receiver (through NETCONF), see section [13.2](#)
- if an ACS is being used for remote management of the Nokia FastMile 4G Receiver (through TR-069), see section [13.3](#)

13.2 Using the Nokia Wireless app to manage a unit managed by the Nokia Altiplano FastMile Controller

If the Nokia Altiplano FastMile Controller is being used for remote management of the Nokia FastMile 4G Receiver (through NETCONF), you can use the Nokia Wireless app to perform management activities on it, such as viewing information, uploading CA certificates, rebooting the Nokia FastMile 4G Receiver, or resetting to factory settings, as described in the following procedure.

You will need the QR code that was saved as described during installation the Nokia FastMile 4G Receiver in order to scan it when logging in to it through the Nokia Wireless app. Logging in to the Nokia FastMile 4G Receiver also includes the following:

- initiating a Bluetooth connection
- enabling Bluetooth
- allowing the Bluetooth pairing request
- establishing the VPN connection
- entering the username and password

Procedure 5 To perform management activities

Use the following procedure to perform management activities through the Nokia Wireless app for a Nokia FastMile 4G Receiver that is managed remotely by the Nokia Altiplano FastMile Controller through NETCONF.

-
- 1 When you are close to the Nokia FastMile 4G Receiver, connect the mobile phone to the Internet and open the Nokia Wireless app on the phone.

An introductory screen with a video appears.

Figure 20 shows the introductory screen.

Figure 20 **Introductory screen for unit managed by the Nokia Altiplano FastMile Controller through NETCONF**

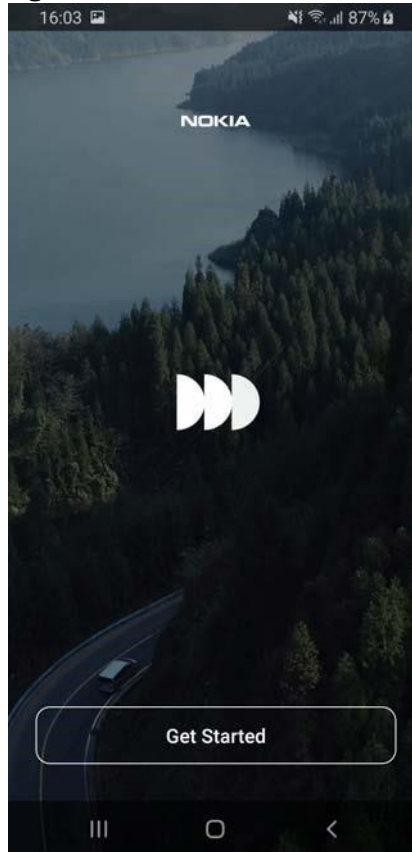

Continue by tapping on “Get started”.

2 After the introductory screen has cleared, the Nokia Wireless app shows an animation of how to scan the QR code of the Nokia FastMile 4G Receiver so that the app can obtain the MAC address, unique device identifier, enterprise id, and device type of the Nokia FastMile 4G Receiver.

The QR code was provided on a sheet of paper in the shipping package of the Nokia FastMile 4G Receiver. The sheet of paper, or a photograph of it, should have been saved and made available for anyone who later needs to scan the QR code when accessing the Nokia FastMile 4G Receiver.

Figure 21 shows the screen for the prompt to scan the QR code.

Figure 21 Screen with prompt to scan the QR code for unit managed by the Nokia Altiplano FastMile Controller through NETCONF

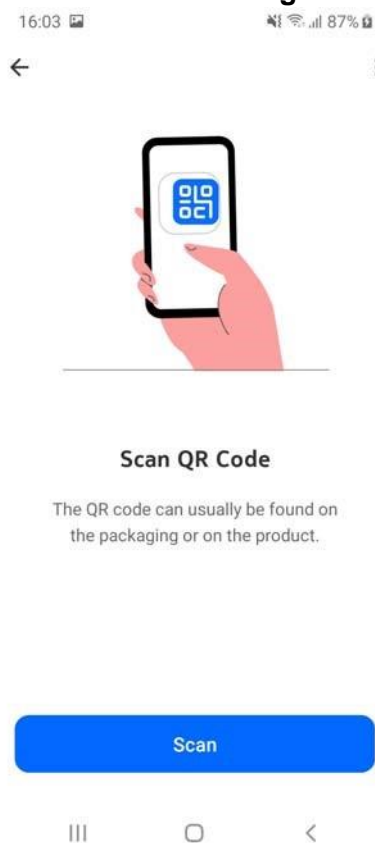

Tap on “Scan” to start the scan of the QR code.

Use the viewfinder of the phone to align with the QR code.

Figure 22 shows the QR code screen.

Figure 22 QR code screen for unit managed by the Nokia Altiplano FastMile Controller through NETCONF



- 3 The Nokia Wireless app displays the screen to install the Nokia FastMile 4G Receiver.
Tap on the "Already Installed?" option.
Figure 23 shows the Already Installed option.

Figure 23 Screen showing the Already Installed option for unit managed by the Nokia Altiplano FastMile Controller through NETCONF



- 4 The Nokia Wireless app prompts you to connect to the Nokia FastMile 4G Receiver. The connection will be done through a VPN. You will need to be close to the Nokia FastMile 4G Receiver and you will need to have Bluetooth enabled on the mobile phone and accept the pairing request when it appears.

Figure 24 shows the screen to connect to the Nokia FastMile 4G Receiver.

Figure 24 Screen for connecting to the Nokia FastMile 4G Receiver

Connect to the Nokia FastMile 4G Receiver by tapping on “Connect”.

- 5 The Nokia Wireless app prompts you to enable the VPN profile for a secure method to communicate with the Nokia FastMile 4G Receiver.

Figure 25 shows the screen to enable the VPN profile.

Figure 25 Screen for enabling the VPN profile

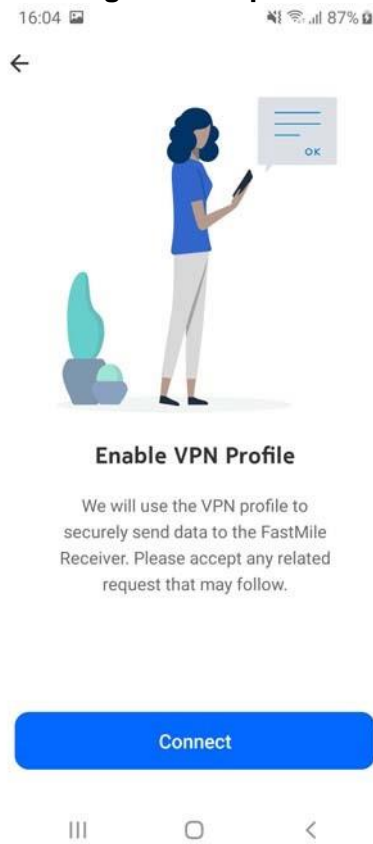

Enable the VPN profile by tapping on “Connect”.

- 6 The android system of the mobile phone prompts you to accept the connection request. Figure 26 shows the prompt to accept the connection request.

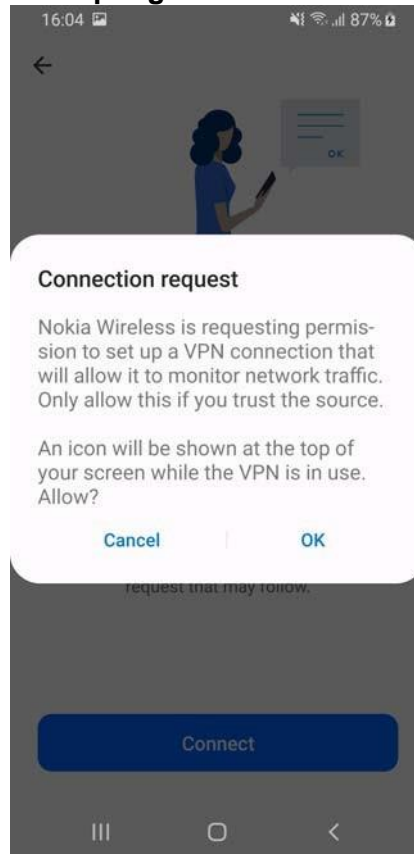
Figure 26 Prompt for accepting the connection request

Accept the connection request by tapping on "OK".

- 7 The Nokia Wireless app prompts you to log in to the Nokia FastMile 4G Receiver. You will need to input the username and password for the Nokia FastMile 4G Receiver.

Figure 27 shows the screen to log in to the Nokia FastMile 4G Receiver.

Figure 27 Screen to log in to a Nokia FastMile 4G Receiver managed by the Nokia Altiplano FastMile Controller



Log in to the Nokia FastMile 4G Receiver by tapping on “Log in”.

After you have logged in, you can:

- view information for the Nokia FastMile 4G Receiver: see step 8
- upload updated certificates to the Nokia FastMile 4G Receiver: see step 9
- reboot the Nokia FastMile 4G Receiver: see step 10
- change the configuration settings to the default factory load settings; see step 11

8 You can view the following information for a Nokia FastMile 4G Receiver managed by the Nokia Altiplano FastMile Controller by selecting the Connection Status option of the main screen and scrolling through the screen by swiping up or down:

- LTE cell info:
- connection state: Does the Nokia FastMile 4G Receiver connect to this cell

-
- status: The current operational state of the PDN connection • EARFCN: The carrier frequency in the uplink and downlink is designated by the E-UTRA. Absolute Radio Frequency Channel Number (EARFCN) in the range 0 - 65535.
 - PCI: The physical cellid of cell
 - Current signal stats: • RSRP: RSRP (Reference Signals Received Power) is a measurement of the received power level in an LTE cell network in dBm • RSRQ: RSRQ (Reference Signals Received Quality) is a measurement of the received power quality in an LTE cell network in dB
 - RSSI: RSSI (Received Signal Strength Indicator) is a measurement of the power present in a received radio signal by the Nokia FastMile 4G Receiver
 - SINR: SINR (the Signal-to-Interference-plus-Noise ratio) is used in the LTE network from the Nokia FastMile 4G Receiver side to measure the quality of wireless connections in dB
 - Average signal stats: • RSRP: average value of Reference Signal Received Power (dBm) in the measured interval, resolution 1dBm • RSRQ: average value of Reference Signal Received Quality (dB) in the measured interval, resolution 1dB • RSSI: average value of Received Signal Strength indicator (dBm) in the measured interval, resolution 1 • SINR: average value of Signal-to-Interference-plus-Noise Ratio (dB) in the measured interval, resolution 1dB
 - Other stats:
 - bytes sent: the total number of bytes sent on the interface
 - bytes received: the total number of bytes received on the interface

Figure 28 shows an example of the System state screen.

Figure 28 System state screen example for a Nokia FastMile 4G Receiver managed by the Nokia Altiplano FastMile Controller

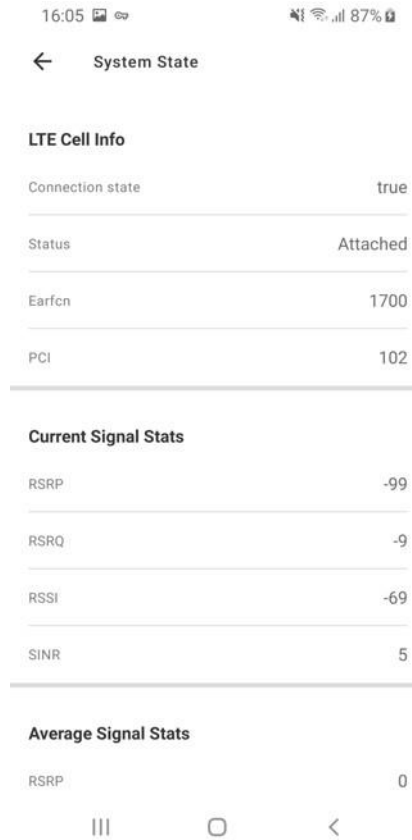

Note — The Nokia Wireless app will display a value of “N/A” for parameters that are not supported by the installed Home 4G Receiver Software version.

The following additional Beam Angle information is displayed only for an ABA version as shown in Figure 29:

- Antenna mode: wide or narrow
- Horizontal angle: the horizontal angle is expressed as a degree if the Antenna mode is narrow or as N/A if the antenna mode is wide

Figure 29 System state screen with Beam Angle information for a Nokia FastMile 4G Receiver managed by the Nokia Altiplano FastMile Controller

System State	
SINR	40
Average Signal Stats	
RSRP	10
RSRQ	11
RSSI	12
SINR	13
Other Stats	
Bytes Sent	101
Bytes Received	100
Beam Angle Information	
Antenna mode	narrow
Horizontal angle	20

9 You can upload updated certificates (stored under downloads in the mobile phone's directory) to the Nokia FastMile 4G Receiver.

i Tap on the "Upload CA certificates" option.

Figure 30 shows the screen that has the "Upload CA certificates" option.

Figure 30 Screen that has the “Upload CA certificates” option for a Nokia FastMile 4G Receiver managed by the Nokia Altiplano FastMile Controller

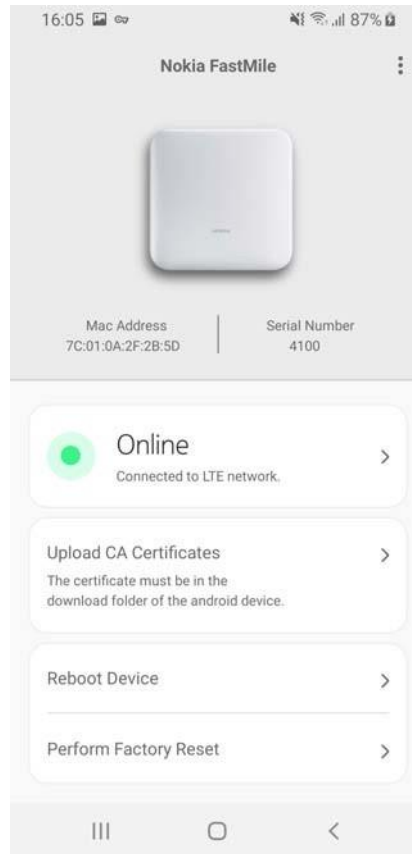

- ii Select the required CA certificates and tap on “Ok”. Note that the certificates must be in the download folder of the mobile phone before you can upload them to the Nokia FastMile 4G Receiver.

Figure 31 shows the screen that lists the CA certificates.

Figure 31 Screen that lists the CA certificates for a Nokia FastMile 4G Receiver managed by the Nokia Altiplano FastMile Controller

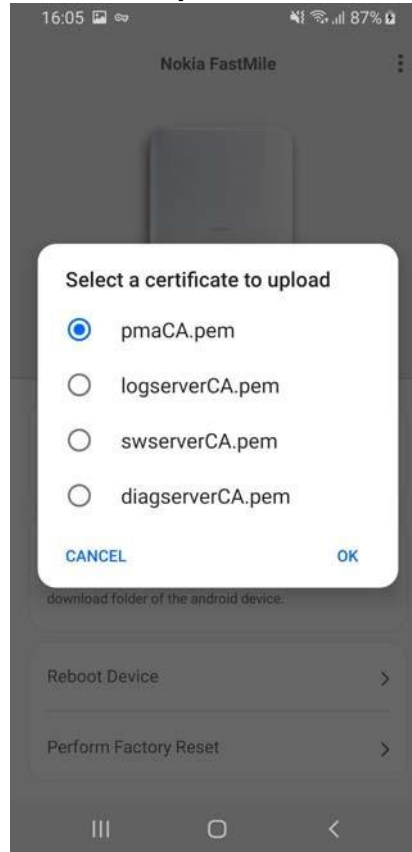

The following CA certificates are supported for a Nokia FastMile 4G Receiver managed by the Nokia Altiplano FastMile Controller through TR-069:

- pmaCA.pem (used for authenticating the Nokia Altiplano FastMile Controller)
- logserverCA.pem (used for authenticating the log server)
- swserverCA.pem (used for authenticating the software upgrade server)
- diagserverCA.pem (used for authenticating the optional diagnostics server)

iii Figure 32 shows the screen that indicates that uploading of the CA certificates was successful.

Figure 32 Screen indicating that uploading of the CA certificates was successful for a Nokia FastMile 4G Receiver managed by the Nokia Altiplano FastMile Controller

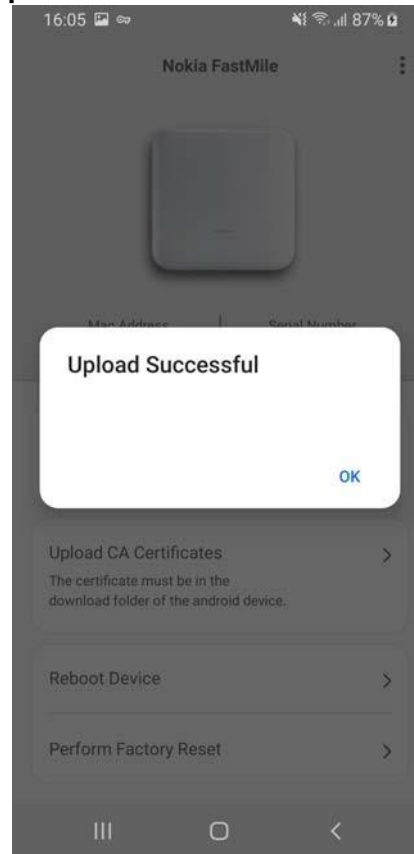

Tap on "Ok" to clear the message.

- 10 You can reboot a Nokia FastMile 4G Receiver managed by the Nokia Altiplano FastMile Controller through NETCONF by tapping on the "Reboot Device" option.

Figure 33 shows the "Reboot Device" option.

Figure 33 Screen showing the “Reboot Device” option for a Nokia FastMile 4G Receiver managed by the Nokia Altiplano FastMile Controller

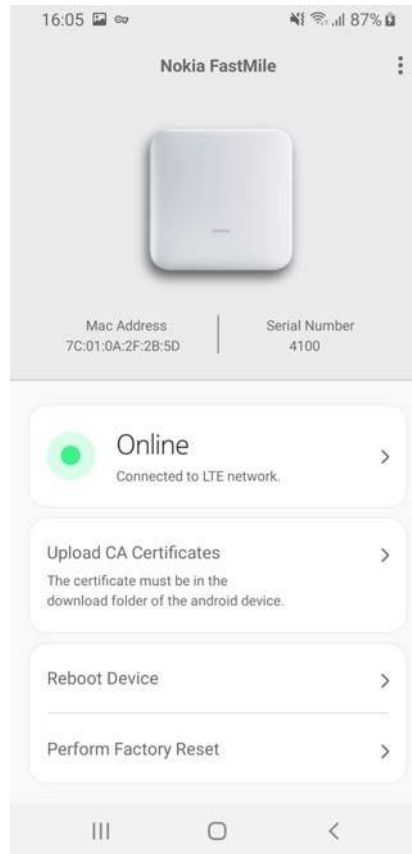

The screen shows the reboot message indicating that the Bluetooth connection will be interrupted and that you will be disconnected.

Figure 34 shows the screen that has the reboot message.

Figure 34 Screen showing the reboot message for a Nokia FastMile 4G Receiver managed by the Nokia Altiplano FastMile Controller

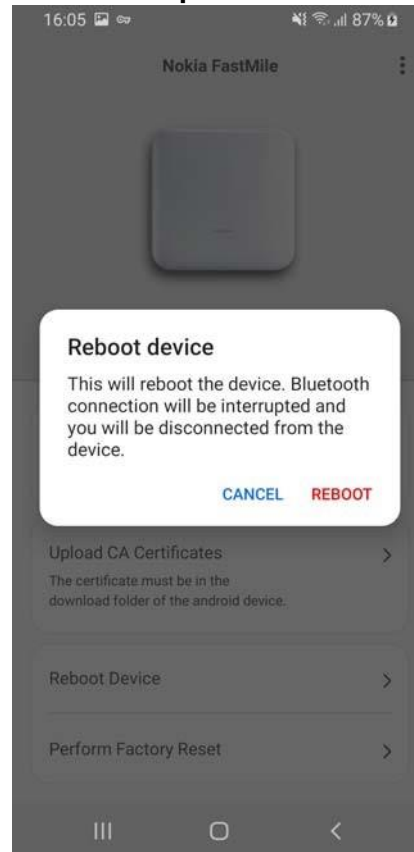

Press the Reboot option if you want to proceed with the reboot, or press the Cancel option.

If you pressed the Reboot option, press OK.

-
- 11** You can change the configuration settings for a Nokia FastMile 4G Receiver managed by the Nokia Altiplano FastMile Controller through NETCONF to the default factory load settings by tapping on the “Perform Factory Reset” option.

Figure 35 shows the “Perform Factory Reset” option.

Figure 35 Screen showing the “Perform Factory Reset” option for a Nokia FastMile 4G Receiver managed by the Nokia Altiplano FastMile Controller

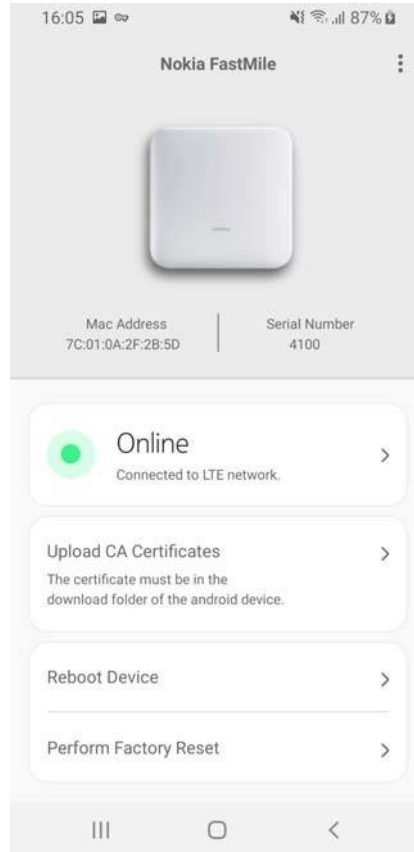

The screen shows the factory reset message indicating that the factory reset will reset the device back to factory settings and that all changes will be lost and that you will be disconnected.

Figure 36 shows the screen that has the factory reset message.

Figure 36 Screen showing the factory reset message for a Nokia FastMile 4G Receiver managed by the Nokia Altiplano FastMile Controller

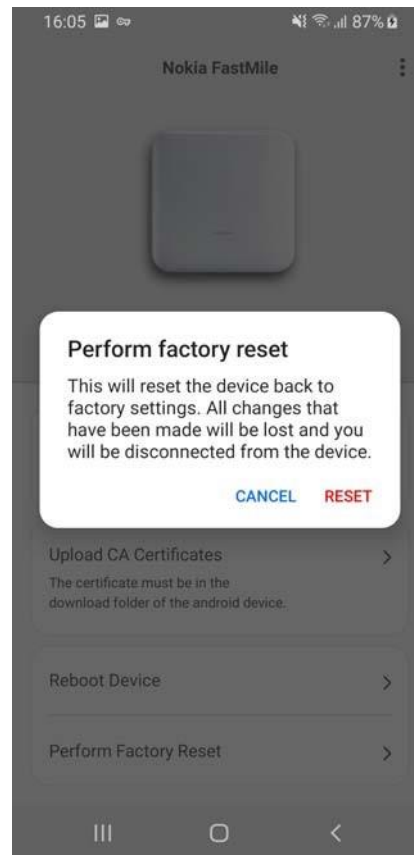

Press the Reset option if you want to proceed with the reset to factory settings, or press the Cancel option.

If you pressed the Reset option, press OK.

13.3 Using the Nokia Wireless app to manage a unit managed by an ACS

If an ACS is being used for remote management of the Nokia FastMile 4G Receiver (through TR-069), you can use the Nokia Wireless app to perform management activities on the Nokia FastMile 4G Receiver after it has been installed, such as viewing information, uploading CA certificates, and rebooting, as described in the following procedure.

You will need the QR code that was saved as described during installation of the Nokia FastMile 4G Receiver in order to scan it when logging in to the 4G Receiver

through the Nokia Wireless app. Logging in to the Nokia FastMile 4G Receiver also includes the following:

- initiating a Bluetooth connection
- enabling Bluetooth
- allowing the Bluetooth pairing request
- establishing the VPN connection
- entering the username and password

Procedure 6 To perform management activities

Use the following procedure to use the Nokia Wireless app to perform management activities for a Nokia FastMile 4G Receiver that is managed remotely by an ACS through TR-069.

-
- 1 When you are close to the Nokia FastMile 4G Receiver, connect the mobile phone to the Internet and open the Nokia Wireless app on the phone.

An introductory screen with a video appears.

Figure 37 shows the introductory screen.

Figure 37 Introductory screen for unit managed by an ACS through TR-069

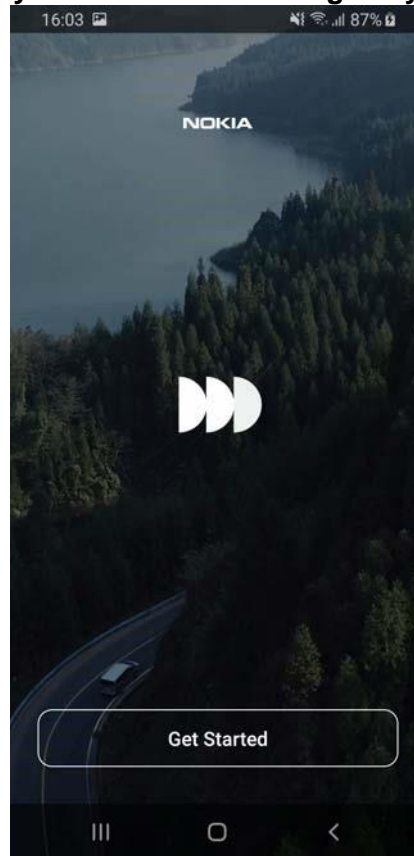

Continue by tapping on "Get started".

-
- 2 After the introductory screen has cleared, the Nokia Wireless app shows an animation of how to scan the QR code of the Nokia FastMile 4G Receiver so that the app can obtain the MAC address, unique device identifier, enterprise id, and device type of the Nokia FastMile 4G Receiver.

The QR code was provided on a sheet of paper in the shipping package of the Nokia FastMile 4G Receiver. The sheet of paper, or a photograph of it, should have been saved and made available for anyone who later needs to scan the QR code when accessing the Nokia FastMile 4G Receiver.

Figure 38 shows the screen for the prompt to scan the QR code.

Figure 38 Screen with prompt to scan the QR code for unit managed by an ACS through TR-069

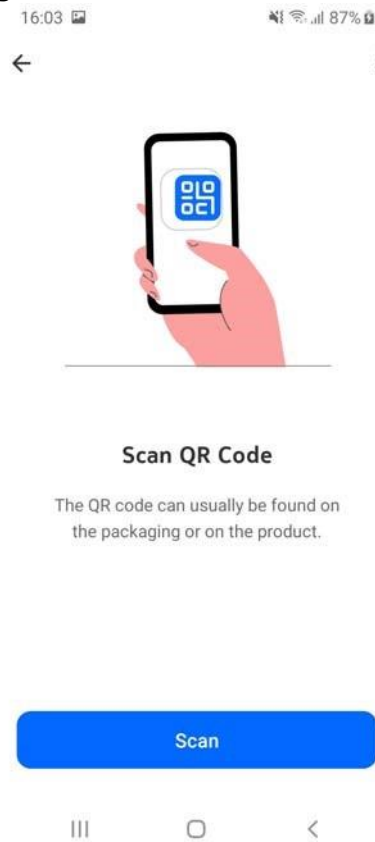

Tap on “Scan” to start the scan of the QR code.

Use the viewfinder of the phone to align with the QR code.

Figure 39 shows the QR code screen.

Figure 39 QR code screen for unit managed by an ACS through TR-069



- 3 The Nokia Wireless app displays the screen to install the Nokia FastMile 4G Receiver.
Tap on the "Already Installed?" option.
Figure 40 shows the Already Installed option.

Figure 40 Screen showing the Already Installed option for unit managed by an ACS through TR-069



- 4 The Nokia Wireless app prompts you to connect to the Nokia FastMile 4G Receiver. The connection will be done through a VPN. You will need to be close to the Nokia FastMile 4G Receiver and you will need to have Bluetooth enabled on the mobile phone and accept the pairing request when it appears.

Figure 41 shows the screen to connect to the Nokia FastMile 4G Receiver.

Figure 41 Screen for connecting to the Nokia FastMile 4G Receiver

Connect to the Nokia FastMile 4G Receiver by tapping on “Connect”.

- 5 The Nokia Wireless app prompts you to enable the VPN profile for a secure method to communicate with the Nokia FastMile 4G Receiver.

Figure 42 shows the screen to enable the VPN profile.

Figure 42 Screen for enabling the VPN profile

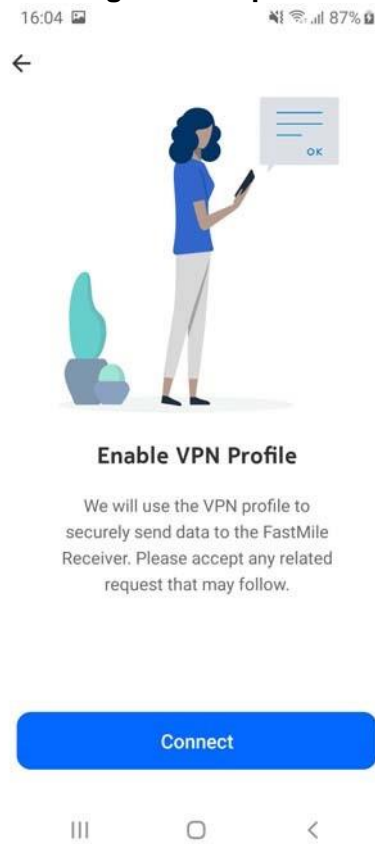

Enable the VPN profile by tapping on “Connect”.

- 6 The android system of the mobile phone prompts you to accept the connection request. Figure 43 shows the prompt to accept the connection request.

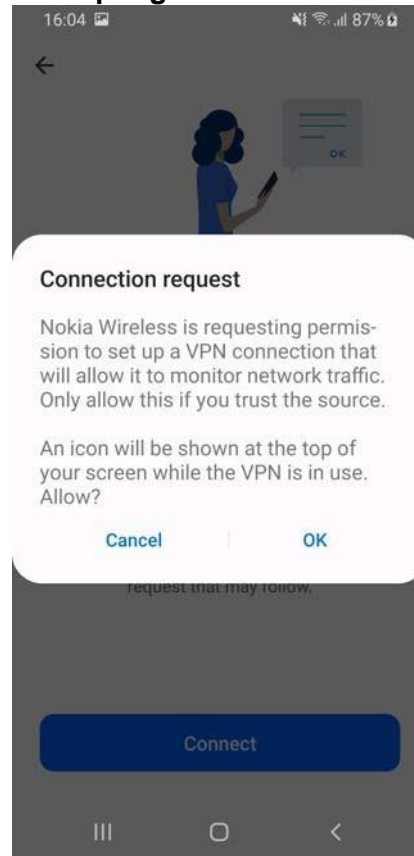
Figure 43 Prompt for accepting the connection request

Accept the connection request by tapping on “OK”.

- 7 The Nokia Wireless app prompts you to log in to the Nokia FastMile 4G Receiver. You will need to input the username and password for the Nokia FastMile 4G Receiver.

Figure 44 shows the screen to log in to the Nokia FastMile 4G Receiver.

Figure 44 Screen to log in to a Nokia FastMile 4G Receiver managed by an ACS through TR-069



Log in to the Nokia FastMile 4G Receiver by tapping on “Log in”.

After you have logged in, you can:

- view information for the Nokia FastMile 4G Receiver: see step 8
- upload updated certificates to the Nokia FastMile 4G Receiver: see step 9
- reboot the Nokia FastMile 4G Receiver: see step 10

8 You can view the following information for a Nokia FastMile 4G Receiver managed by an ACS by selecting the Connection Status option of the main screen and scrolling through the screen by swiping up or down:

- LTE cell info:
- connection state: Does the Nokia FastMile 4G Receiver connect to this cell
- status: The current operational state of the PDN connection • EARFCN: The carrier frequency in the uplink and downlink is designated by the E-UTRA.

Absolute Radio Frequency Channel Number (EARFCN) in the range 0 - 65535.

- PCI: The physical cellid of cell
- Current signal stats: • RSRP: RSRP (Reference Signals Received Power) is a measurement of the received power level in an LTE cell network in dBm
- RSRQ: RSRQ (Reference Signals Received Quality) is a measurement of the received power quality in an LTE cell network expressed as a ratio
- RSSI: RSSI (Received Signal Strength Indicator) is a measurement of the power present in a received radio signal by the Nokia FastMile 4G Receiver in dBm
- SINR: SINR (the Signal-to-Interference-plus-Noise ratio) is used in the LTE network from the Nokia FastMile 4G Receiver side to measure the quality of wireless connections in dB
- Other stats:
 - bytes sent: the total number of bytes sent on the interface
 - bytes received: the total number of bytes received on the interface

Figure 45 shows an example of the System state screen.

Figure 45 System state screen example for a Nokia FastMile 4G Receiver managed by an ACS

The screenshot shows the 'System State' screen with a back arrow at the top left. The content is organized into three sections: 'LTE Cell Info', 'Current Signal Stats', and 'Other Stats'. Each section contains a list of key-value pairs.

LTE Cell Info	
Connection state	true
Status	Attached.
Earfcn	1000
PCI	150

Current Signal Stats	
RSRP	10
RSRQ	20
RSSI	30
SINR	40

Other Stats	
Bytes Sent	101



Note — The Nokia Wireless app will display a value of “N/A” for parameters that are not supported by the installed Home 4G Receiver Software version.

The following additional Beam Angle information is displayed only for an ABA version as shown in Figure 46:

- Antenna mode: wide or narrow
- Horizontal angle: the horizontal angle is expressed as a degree if the Antenna mode is narrow or as N/A if the antenna mode is wide

Figure 46 System state screen with Beam Angle information for a Nokia FastMile 4G Receiver managed by an ACS

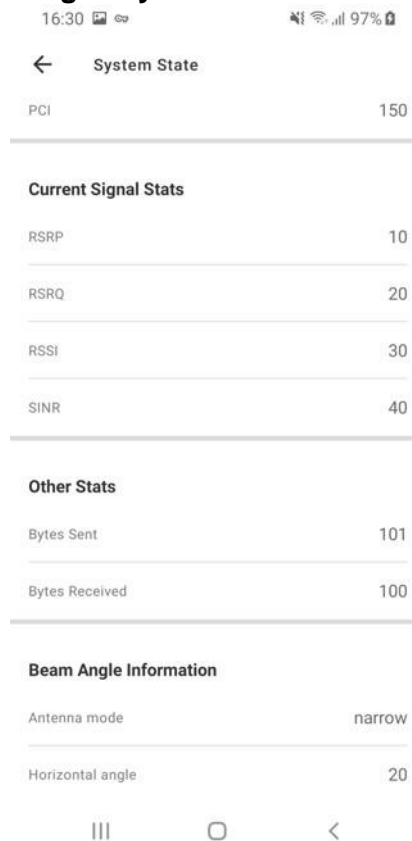

- 9 You can upload updated certificates (stored under downloads in the mobile phone's directory) to the Nokia FastMile 4G Receiver. iTap on the “Upload CA certificates” option.

Figure 47 shows the screen that has the “Upload CA certificates” option.

Figure 47 Screen that has the “Upload CA certificates” option for a Nokia FastMile 4G Receiver managed by an ACS

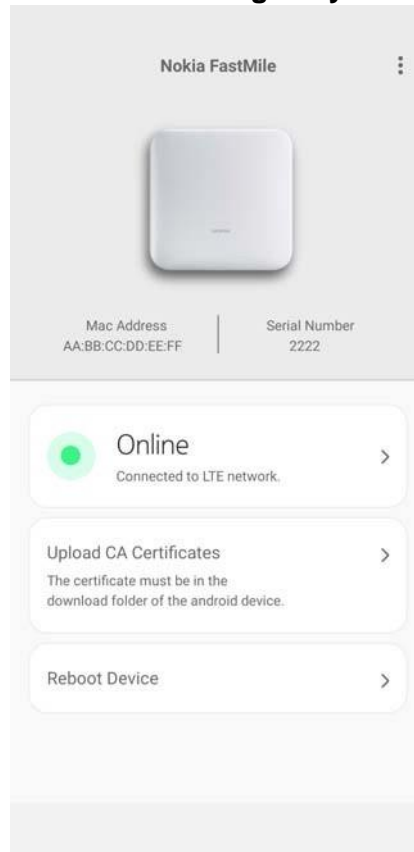

- ii Select the required CA certificates and tap on “Ok”. Note that the certificates must be in the download folder of the mobile phone before you can upload them to the Nokia FastMile 4G Receiver.

The following CA certificates are supported for a Nokia FastMile 4G Receiver Nokia FastMile 4G Receiver managed by an ACS:

- logserverCA.pem (used for authenticating the log server)
- swserverCA.pem (used for authenticating the software upgrade server)
- diagserverCA.pem (used for authenticating the optional diagnostics server) •

acsCA.pem (used for authenticating the ACS) **iii** The screen indicates when uploading of the CA certificates was successful.

Tap on “Ok” to clear the message.

- 10 You can reboot a Nokia FastMile 4G Receiver managed by an ACS through TR-069 by tapping on the “Reboot Device” option.
Figure 48 shows the “Reboot Device” option.

Figure 48 Screen showing the “Reboot Device” option for a Nokia FastMile 4G Receiver managed by an ACS

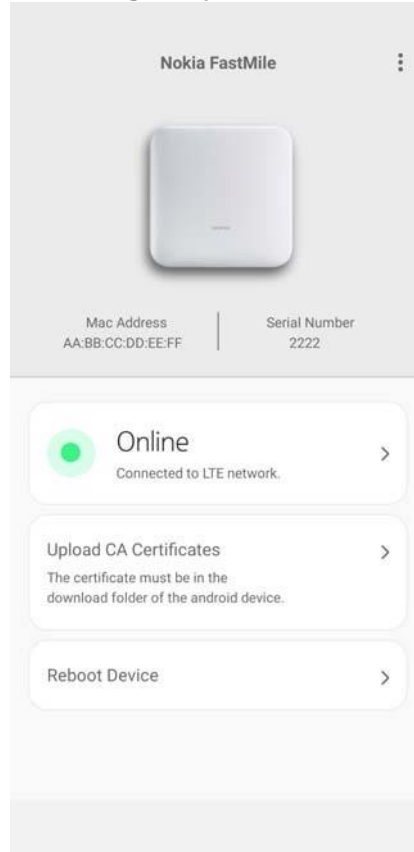

When you reboot the Nokia FastMile 4G Receiver, the screen shows the reboot message indicating that the Bluetooth connection will be interrupted and that you will be disconnected. Press the Reboot option if you want to proceed with the reboot, or press the Cancel option. If you pressed the Reboot option, press OK.

14 Management using the Web UI

14.1 Using the Web UI to manage the Nokia FastMile 4G Receiver

14.2 Using the Web UI status screen

14.3 Using the Web UI network screen

14.4 Using the Web UI system screen

14.1 Using the Web UI to manage the Nokia FastMile 4G Receiver

After the Nokia FastMile 4G Receiver has been installed, you can use the Web UI to perform some management-type activities on a Nokia FastMile 4G Receiver that is managed by an ACS through TR-069. See section [6.1.2](#) for more information about the Web UI.

The Web UI provides the following screens to provide support for management of the Nokia FastMile 4G Receiver:

- Status screen: allows viewing of FastMile 4G Receiver status parameter values, see section [14.2](#)
- Network screen: allows configuration of specific FastMile 4G Receiver parameters (login is required), see section [14.3](#)
- System screen: allows performing of advanced system actions (login is required), see section [14.4](#)

14.2 Using the Web UI status screen

The Web UI status screen allows you to view FastMile 4G Receiver status parameters. No login is required.

The following parameters are shown:

- The attached cell
- The Signal Strength of the attached cell: This animated model shows the RSRP (Reference Signals Received Power) of the attached cell
- The RSSI (Received Signal Strength Indication) of the attached cell
- The RSRQ (Reference Signal Received Quality) of the attached cell
- The SINR (Signal to Interference and Noise Ratio) of the attached cell

- Total number of MB sent on the LTE interface since last FastMile 4G Receiver restart
- Total number of MB received on the LTE interface since last FastMile 4G Receiver restart
- Total number of MB sent on the Ethernet interface since last FastMile 4G Receiver restart
- Total number of MB received on the Ethernet interface since last FastMile 4G Receiver restart
- Data Model (TR-069)
- Software Version
- Name and corresponding IP address of the configured Access Points

Figure 49 shows an example of the Status screen when the FastMile 4G Receiver is not connected to a cell.

Figure 49 Example of the Status screen when the FastMile 4G Receiver is not connected to a cell

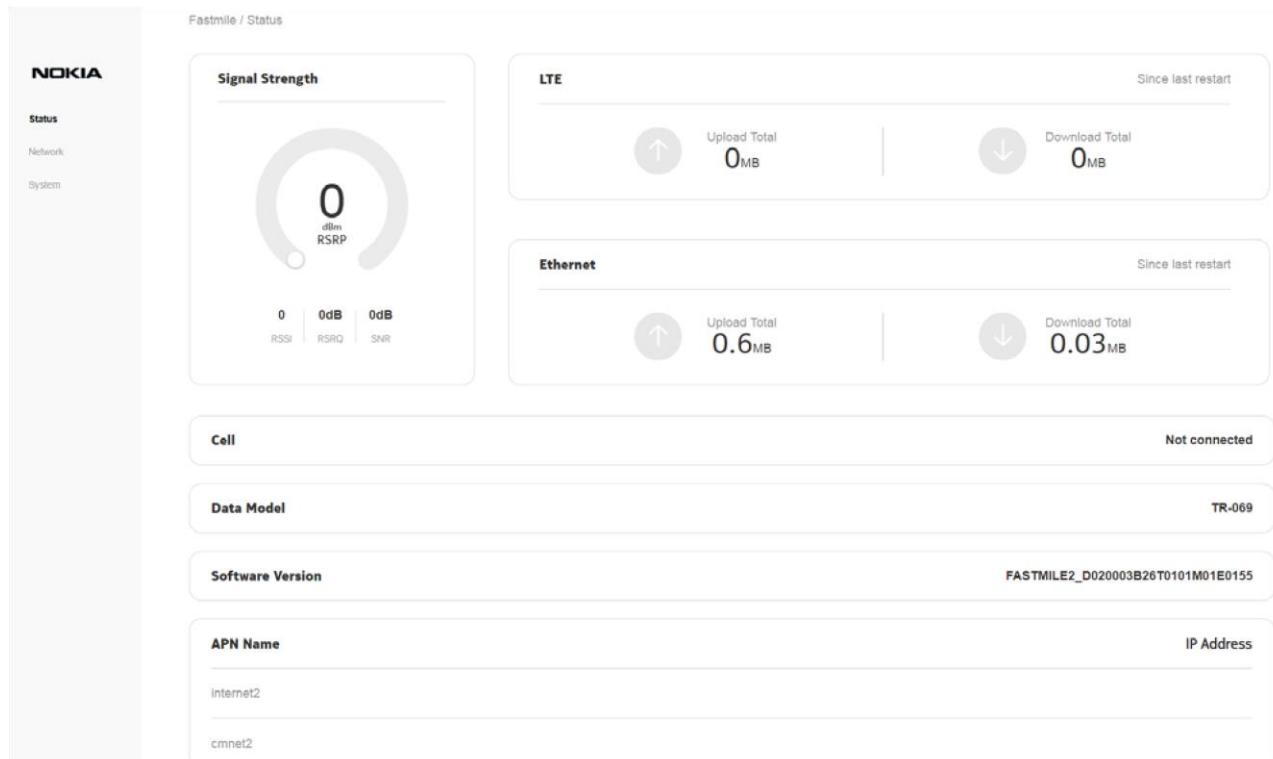
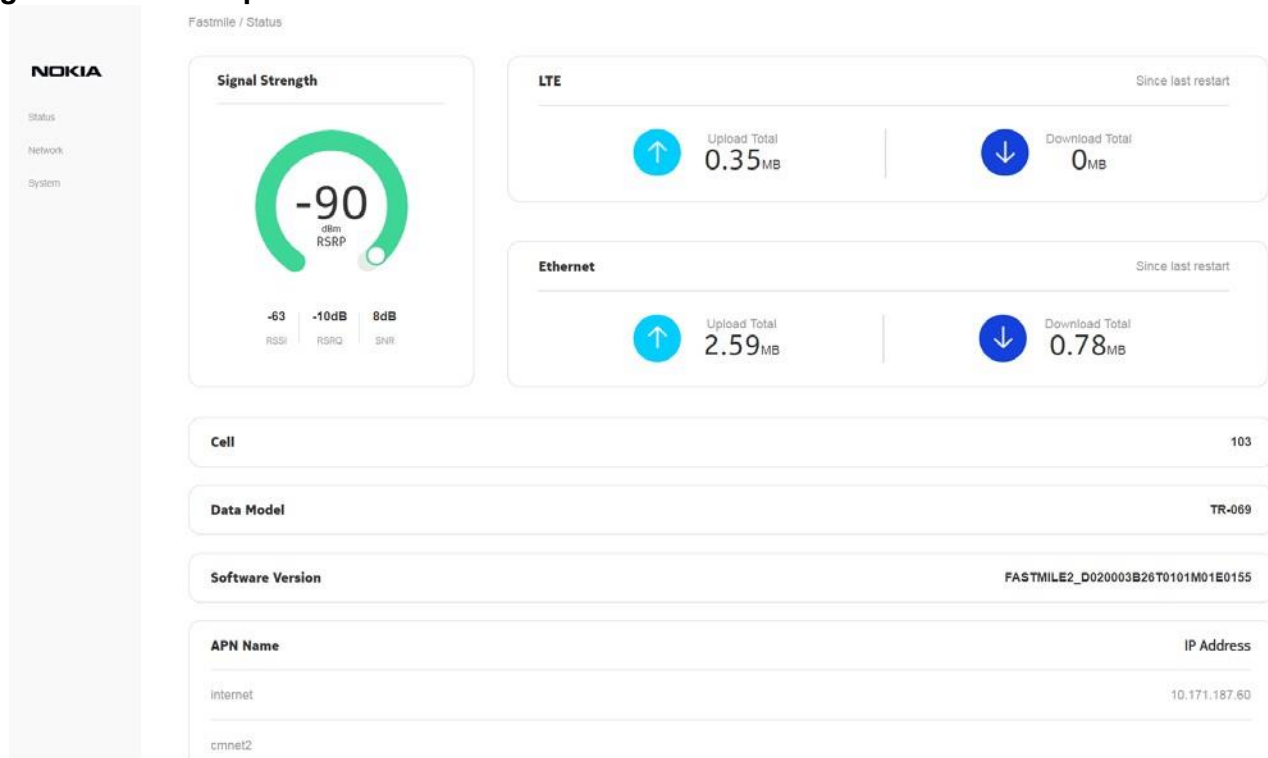

Figure 50 shows an example of the Status screen when the FastMile 4G Receiver is connected to a cell.

Figure 50 Example of the Status screen when the FastMile 4G Receiver is connected to a cell

14.3 Using the Web UI network screen

The Web UI network screen allows you to perform FastMile4G Receiver configuration actions. Login is required. For details on the Web UI login, please refer to the Customer Release Notes.

The following configuration capabilities are supported:

- Configuration of ACS URL
- Configuration of ACS username
- Configuration of ACS password
- Configuration of Connection Request Port
- Configuration of Connection Request Username
- Configuration of Connection Request Password
- Configuration of Periodic Inform Interval
- Configuration of Periodic Inform Request
- Setting of location; that is, geocoordinates (latitude and longitude)

-
- Configuration of Access Points (up to one default AP in router mode and up to four APs in bridge mode; a total of five APs can be configured). AP configuration includes configuration of:
 - AP name
 - forwarding mode (router or bridge)
 - Username
 - Password
 - VLAN
 - MTU size
 - subnet mask
 - Note that the default APN cannot be deleted
 - Configuration of cell list (up to nine cells can be configured)
 - Configuration of the DHCP server for router mode
 - Uploading of CA certificates



Note — CA certificates must be pre-downloaded to the laptop so that they can be browsed and found via the 'Upload Certificate' action. The CA Certificates must comply to the naming rules required by the FastMile4G Receiver.

The following CA certificates are supported:

- logserverCA.pem (used for authenticating the log server)
- swserverCA.pem (used for authenticating the software upgrade server)
- diagserverCA.pem (used for authenticating the optional diagnostics server)
- acsCA.pem (used for authenticating the ACS)

Figure 51 shows an example of the Login screen.

Figure 51 Example of the Login screen

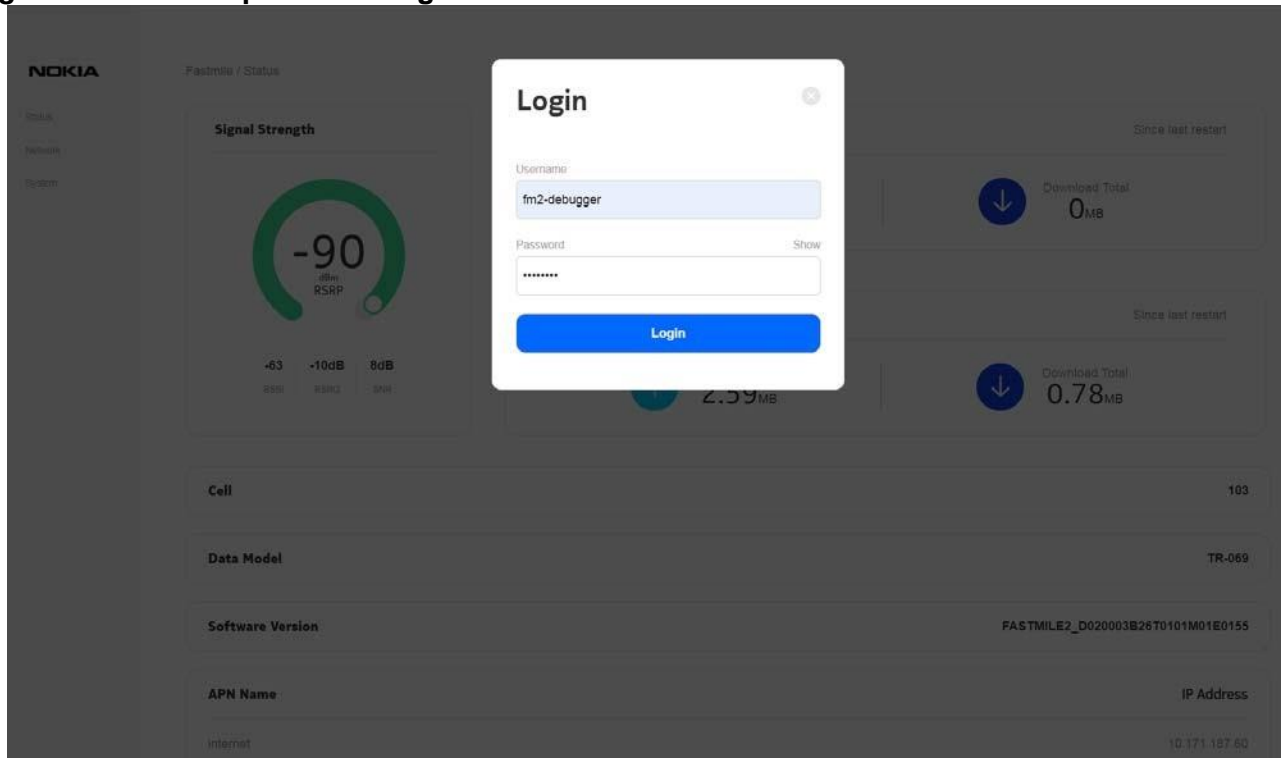

Figure 52 shows an example of the Network screen.

Figure 52 Example of the Network screen

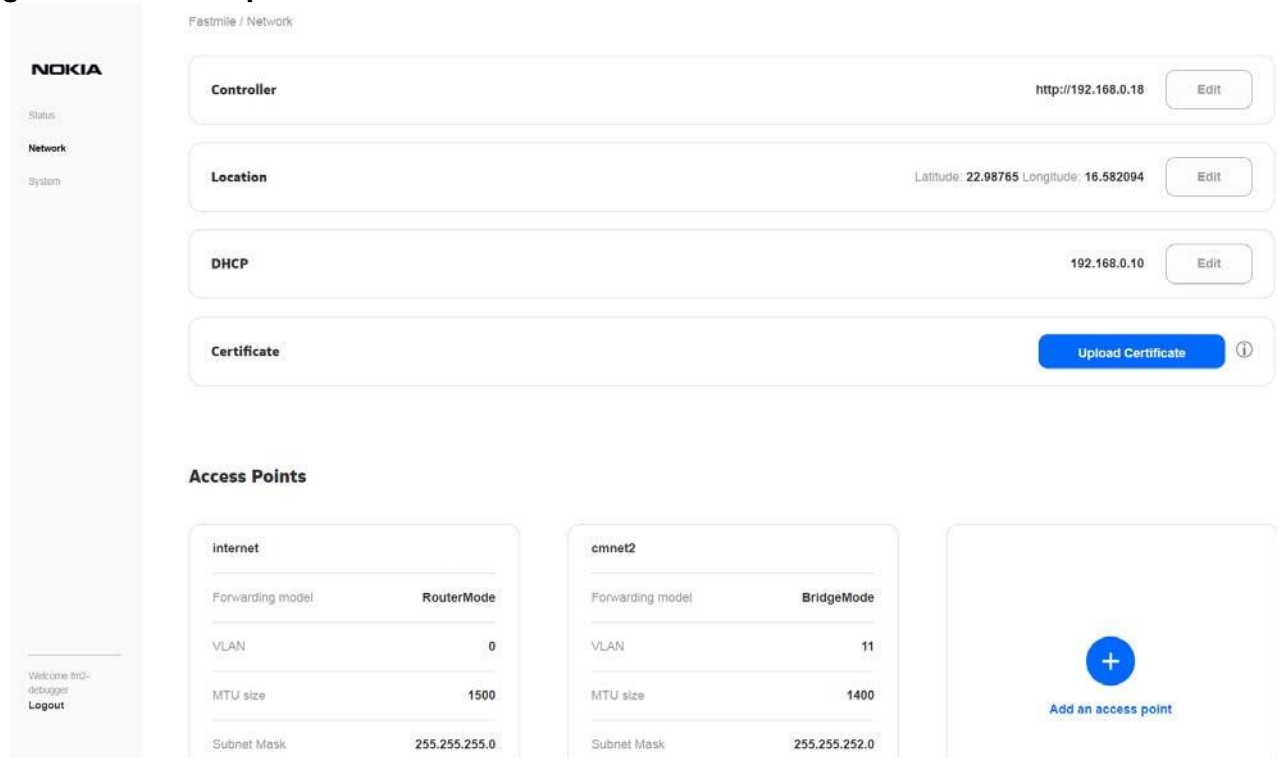

Figure 53 shows an example of scroll down for the Network screen.

Figure 53 Example of scroll down for the Network screen

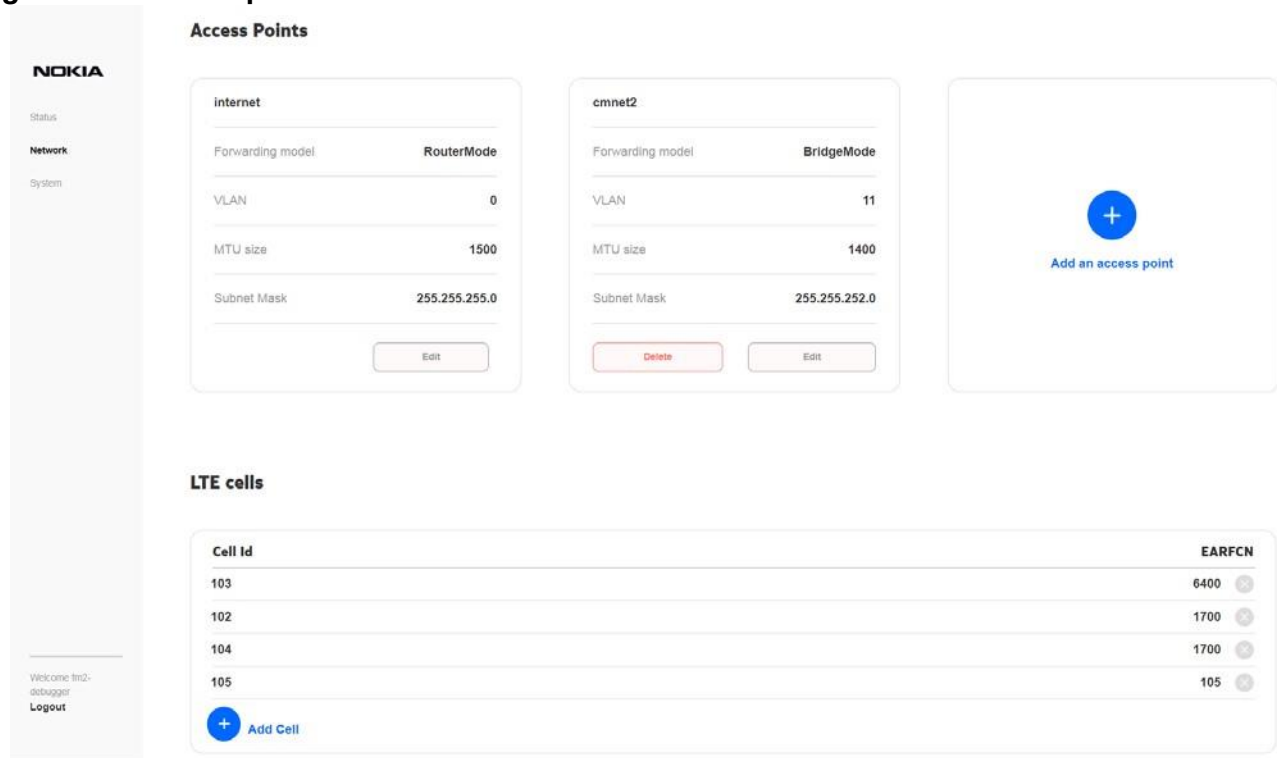

Figure 54 shows an example of the Add Access Point window.

Figure 54 Example of the Add Access Point window

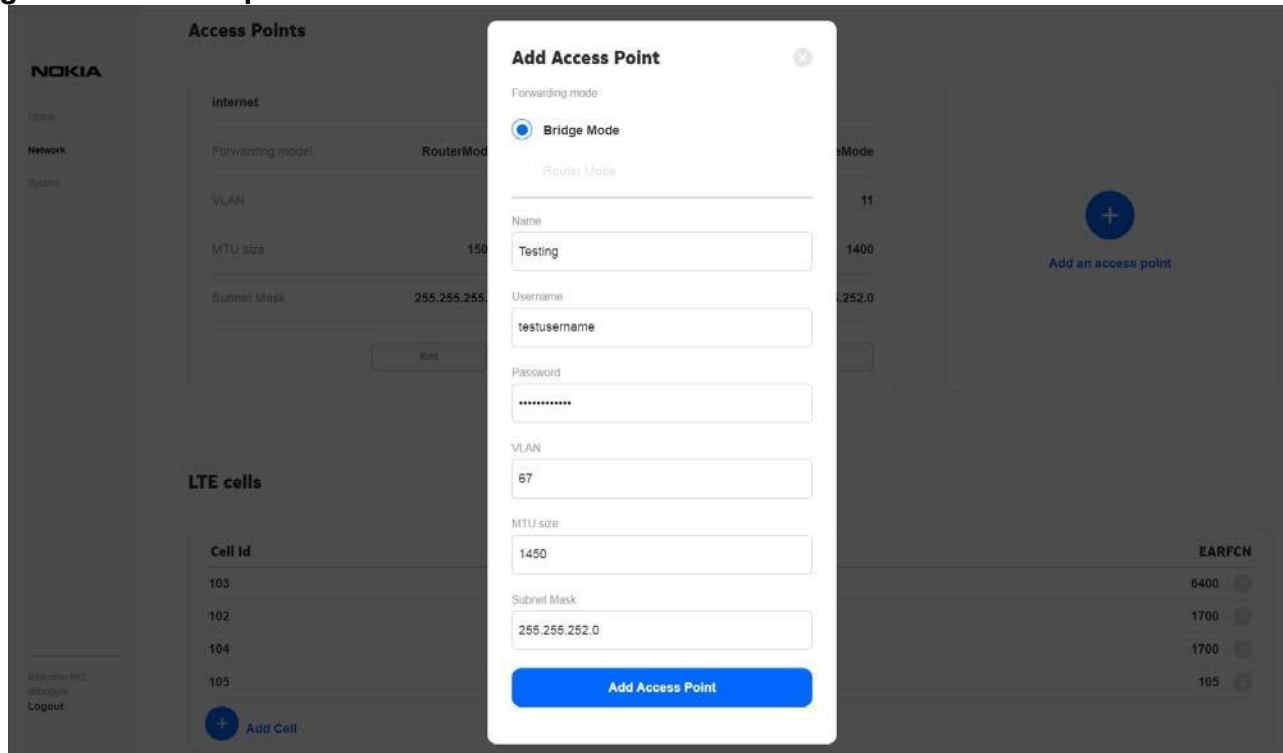

Figure 55 shows an example of the Delete APN window.

Figure 55 Example of the Delete APN window

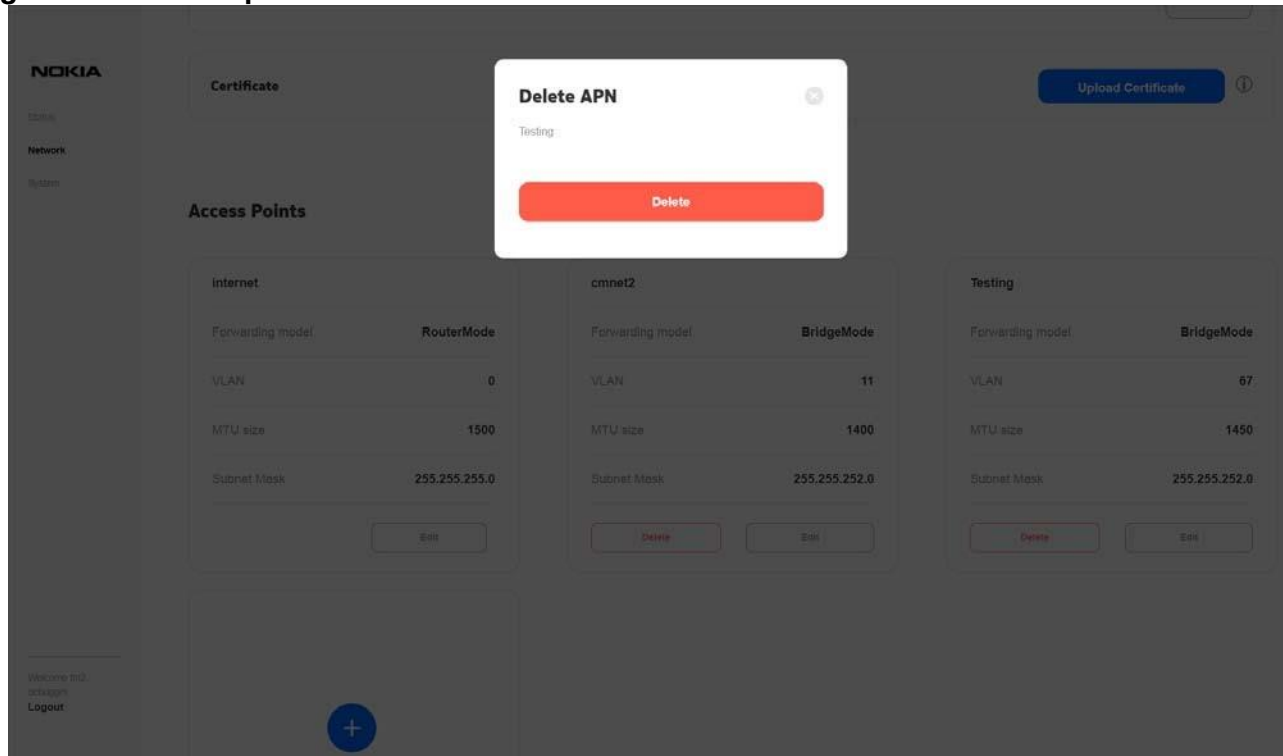

Figure 56 shows an example of the Edit Location window.

Figure 56 Example of the Edit Location window

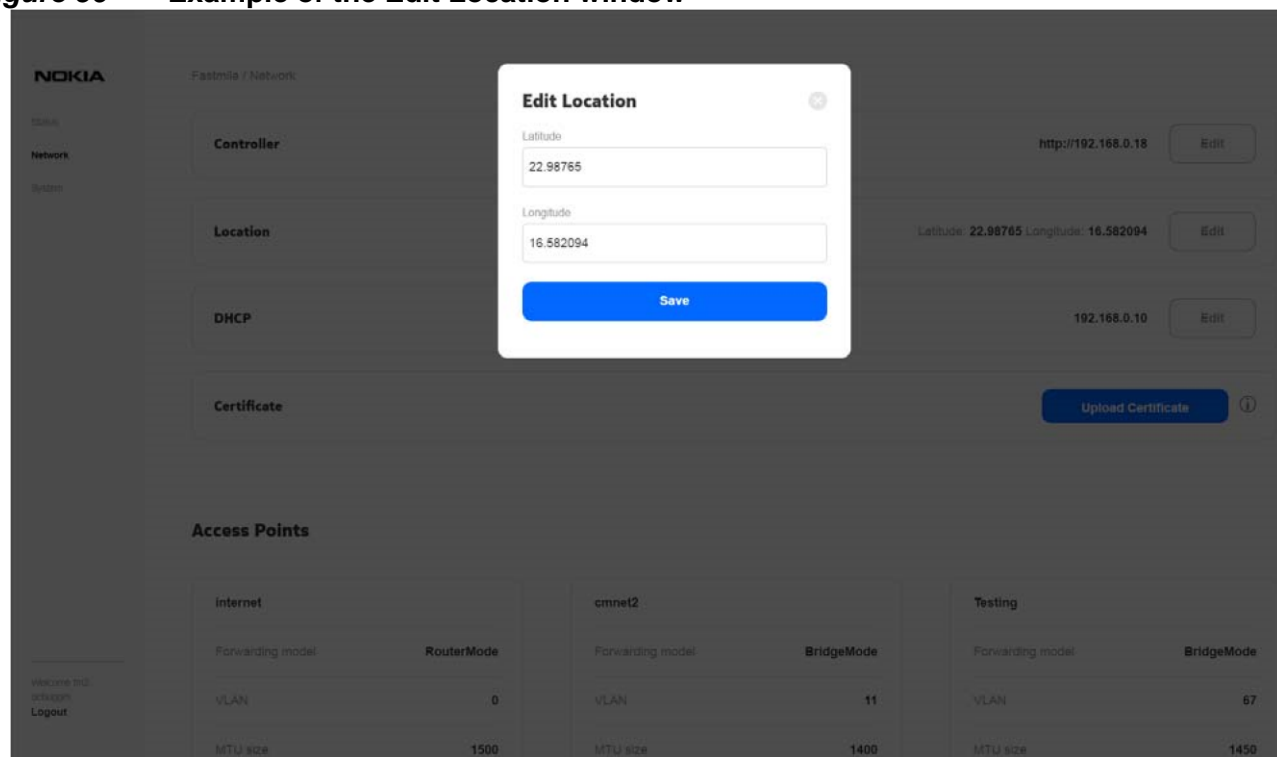

Figure 57 shows an example of the Edit Controller window (used to configure ACS-related parameters).

Figure 57 Example of the Edit Controller window

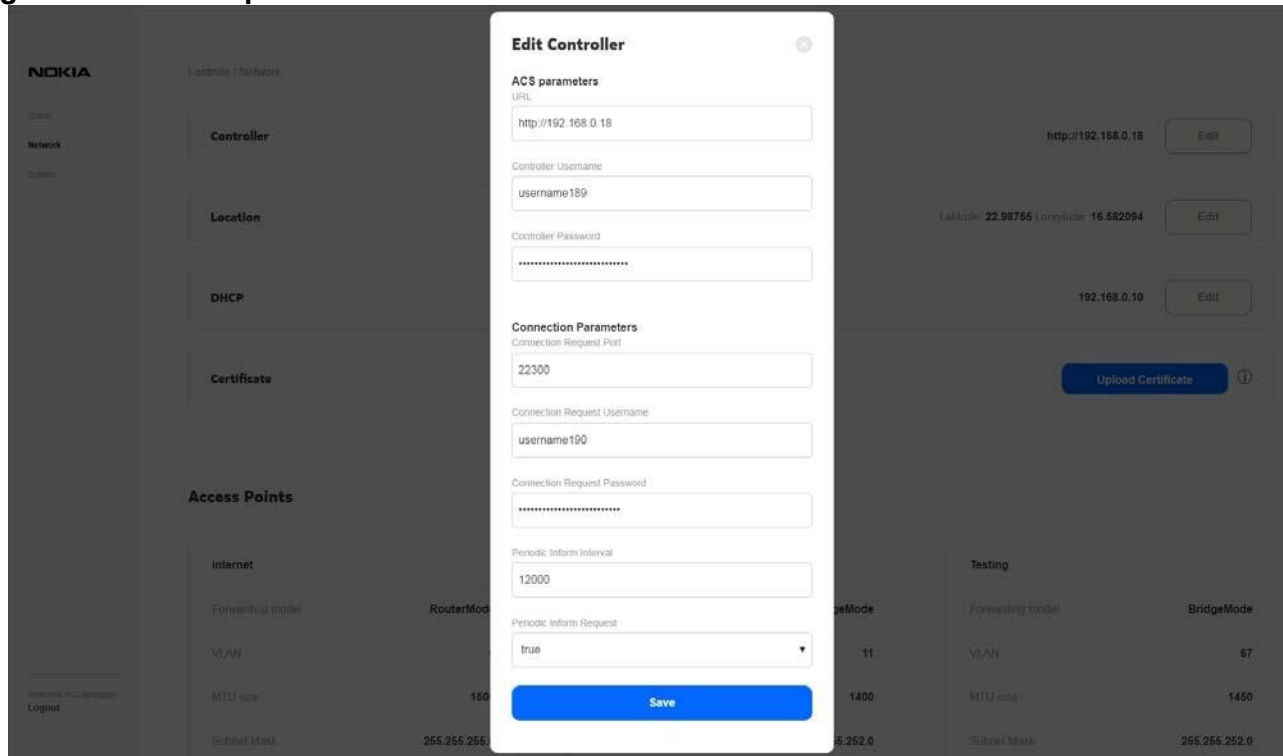

Figure 58 shows an example of the Edit DHCP window.

Figure 58 Example of the Edit DHCP window

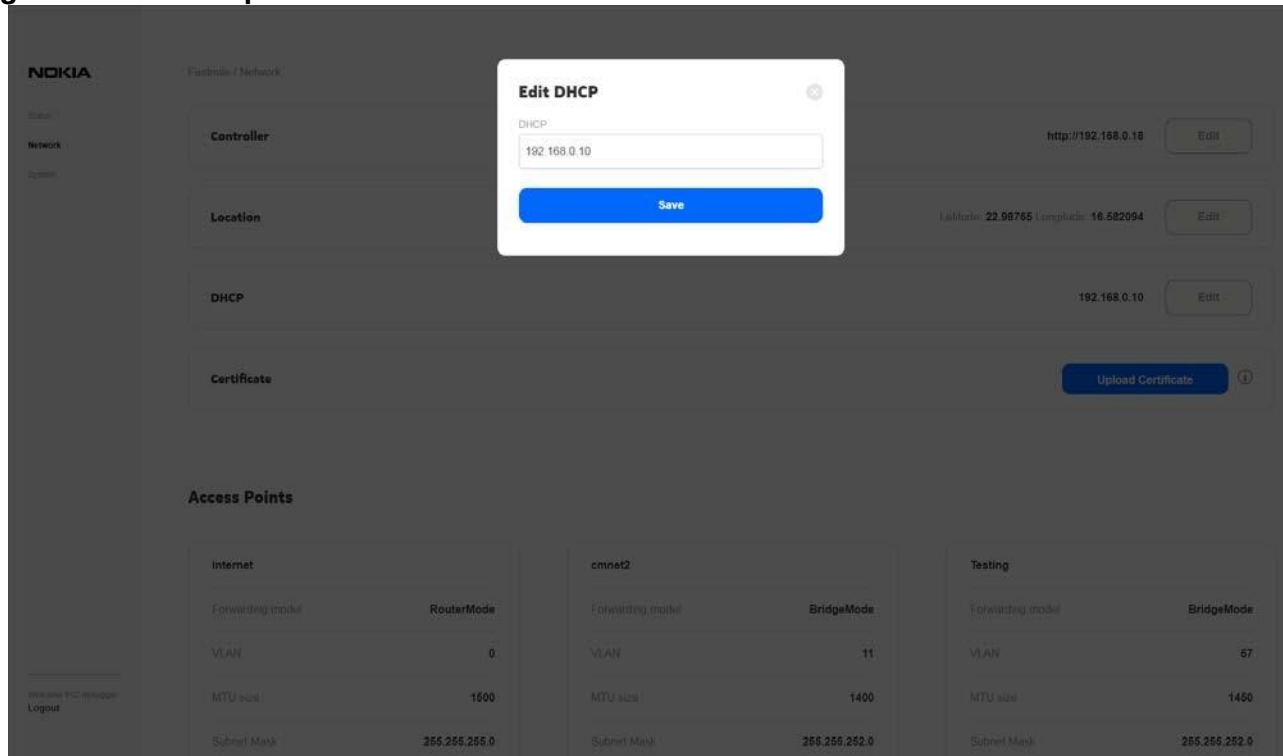

Figure 59 shows an example of the Certificates information window that opens when you click on Upload Certificate.

Figure 59 Example of the Certificates information window

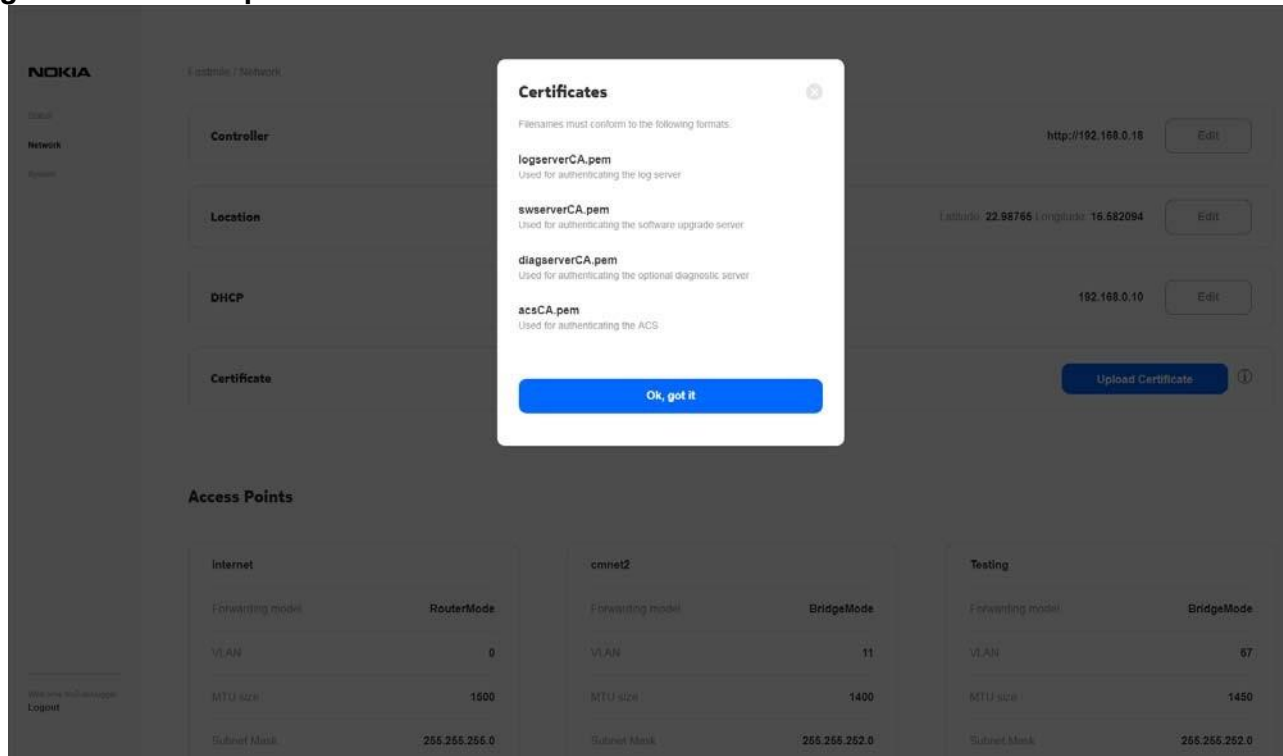

Figure 60 shows an example of the Add Cell window.

Figure 60 Example of the Add Cell window

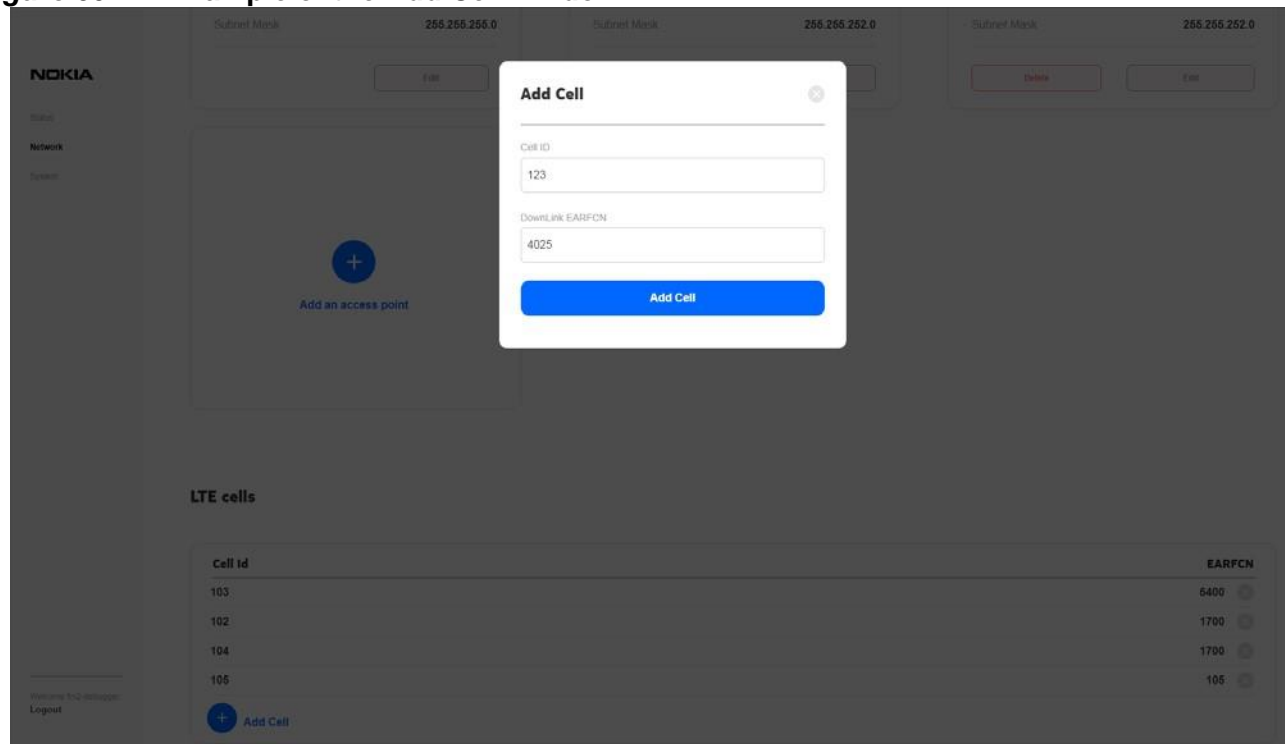
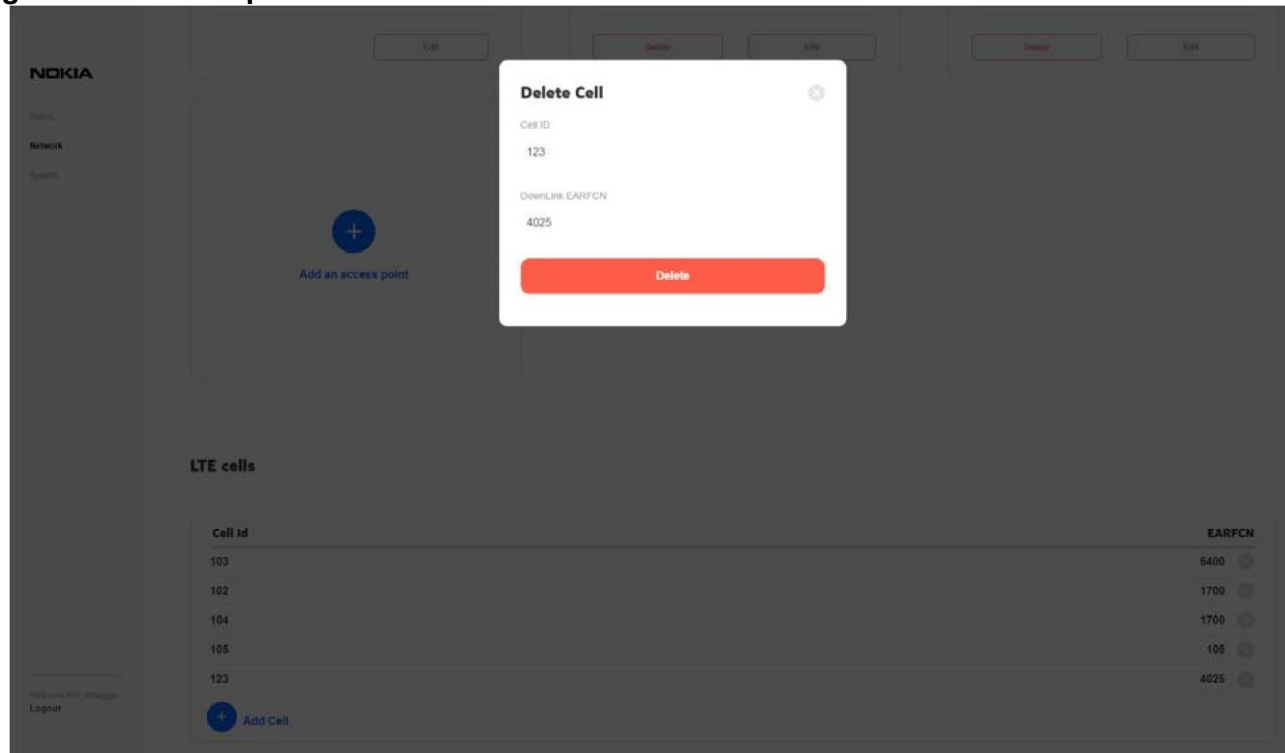

Figure 61 shows an example of the Delete Cell window.

Figure 61 Example of the Delete Cell window

14.4 Using the Web UI system screen

The Web UI system screen allows you to perform advanced system actions on the FastMile 4G Receiver. Login is required. For details on the Web UI login, please refer to the Customer Release Notes.

The following advanced system capabilities are supported:

- Restart device: the FastMile 4G Receiver configuration remains intact
- Restore factory settings: factory configuration of the FastMile 4G Receiver is used; subsequent configuration is lost
- Update firmware:
 - before doing any firmware update action, make sure that the update path from the existing firmware to new firmware is supported by the FastMile 4G Receiver
 - new image is installed in the FastMile 4G Receiver; the FastMile 4G Receiver configuration remains intact

Figure 62 shows an example of the System screen.

Figure 62 Example of the System screen

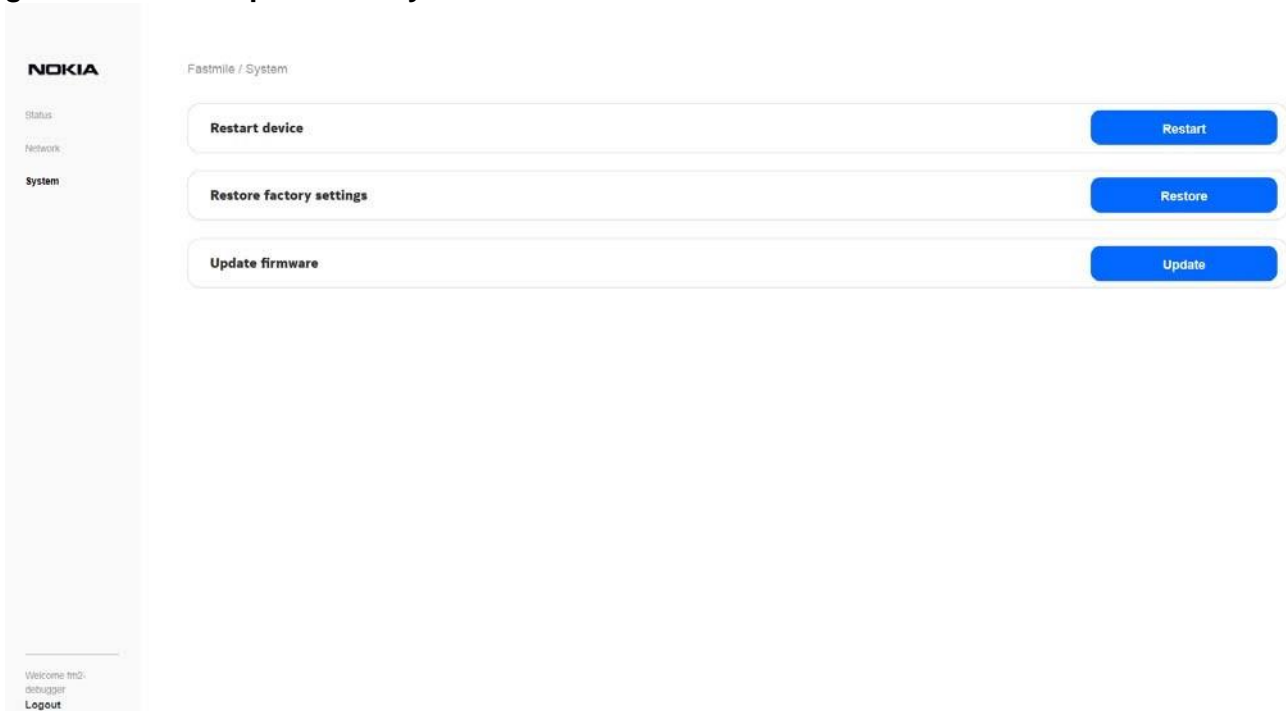

Figure 63 shows an example of the Restart Device confirmation window.

Figure 63 Example of the Restart Device confirmation window

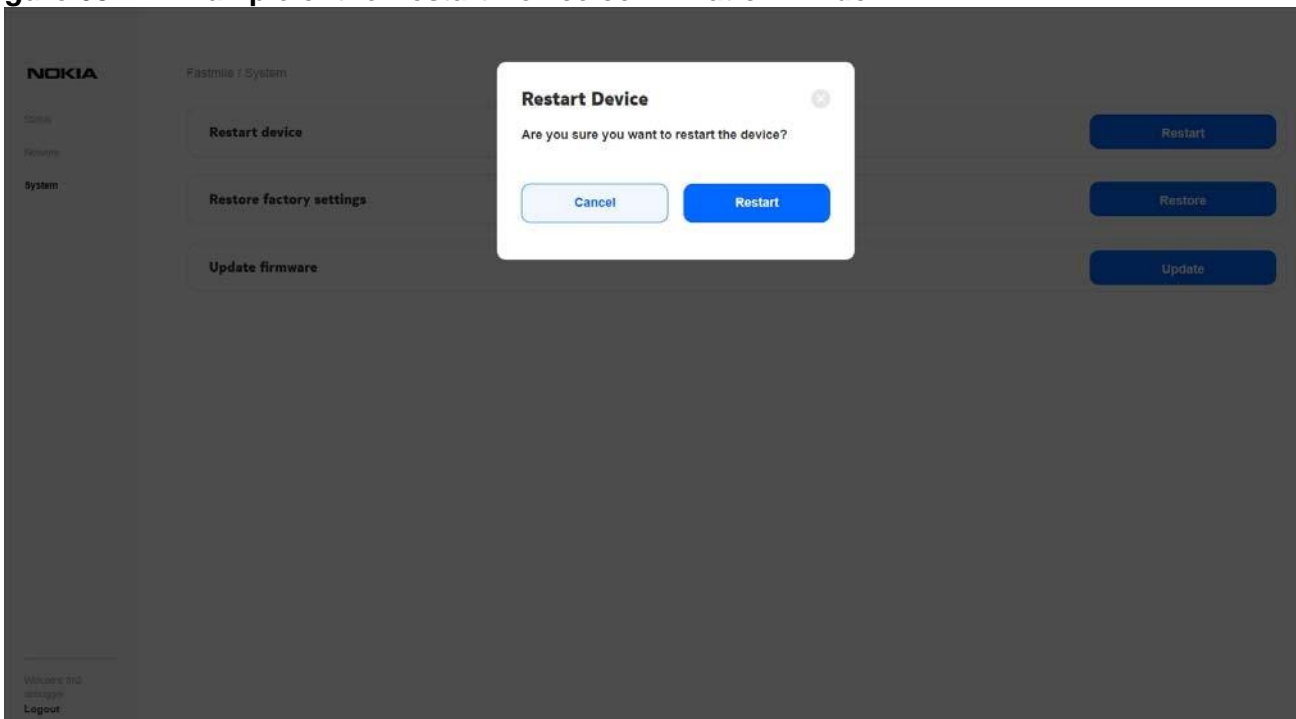

Figure 64 shows an example of the Restore Device confirmation window used to restore the device to factory settings.

Figure 64 Example of the Restore Device confirmation window

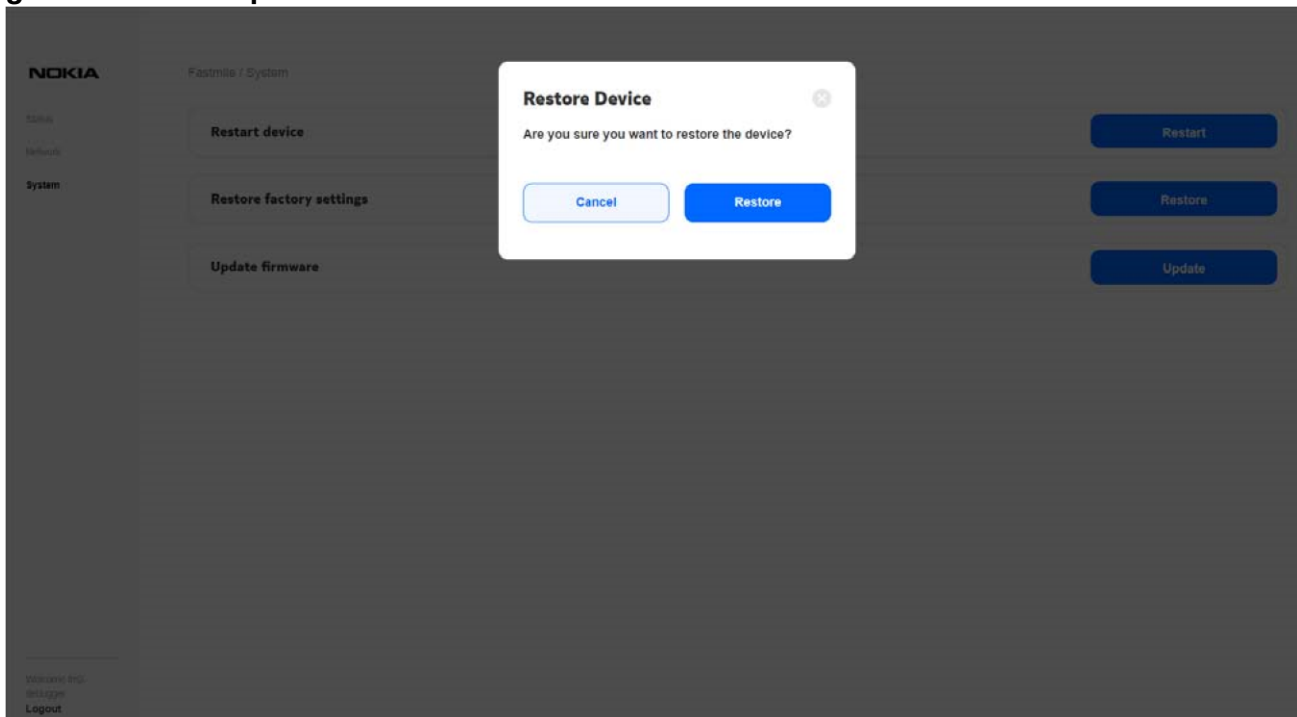
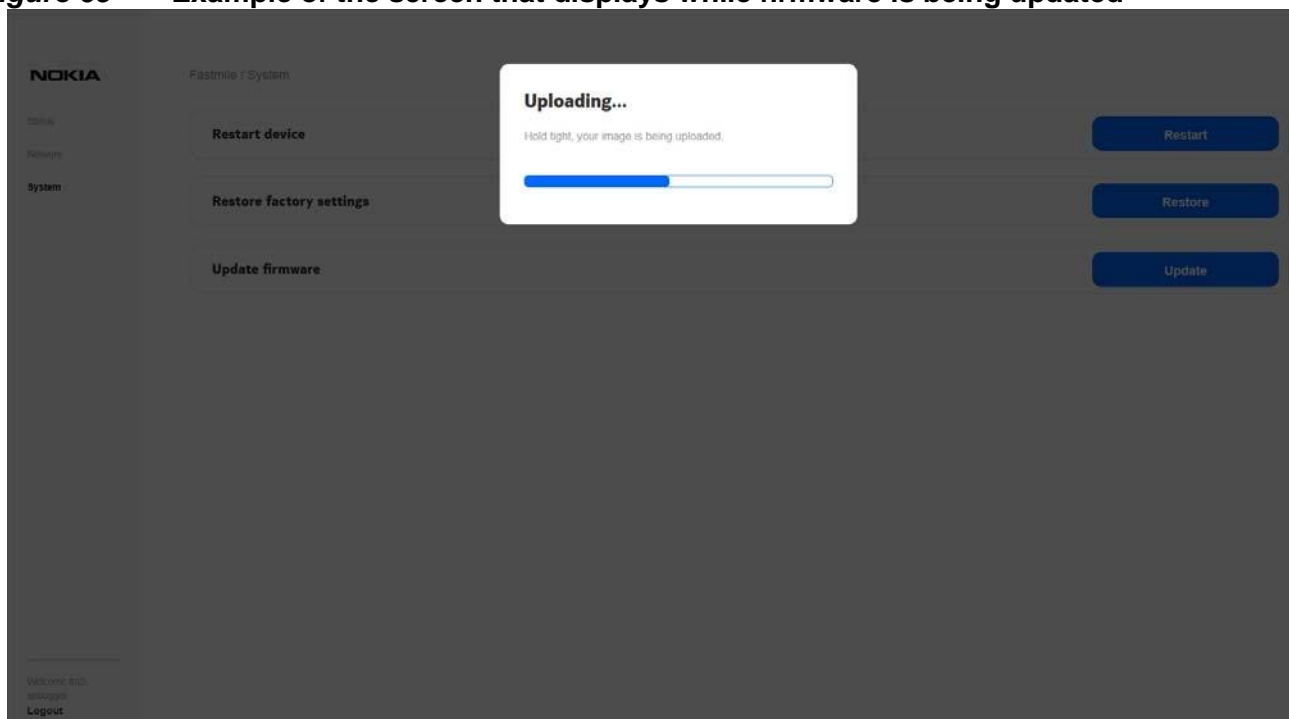

Figure 65 shows an example of the screen that displays while firmware is being updated.

Figure 65 Example of the screen that displays while firmware is being updated



15 Standards certification

15.1 Standards certification for Compact mono-band and ABA models

15.2 Standards certification for the Compact multi-band models

15.1 Standards certification for Compact mono-band and ABA models

Table 16 provides standards certification information for the Compact mono-band and ABA models of the Nokia FastMile 4G Receiver.

Table 16 Standards certifications for the Nokia FastMile 4G Receiver Compact mono-band and ABA models

Category	Certifications
RF	EN 301 908-13 for Band 3, 7, 38, 40, 42, 43 of the Compact mono-band models and Band 42, 43 of the ABA model FCC 47 Parts 27 for Band 7 and 41 of the Compact mono-band models ISED for Band 42 and 43 of the ABA model
EMC	ETSI EN 301 489-1 and -52 for Band 3, 7, 38, 40, 42, 43 of the Compact mono-band models and Band 42, 43 of the ABA model FCC 47 part 2/15 for Band 7 and 41 of the Compact mono-band models ISED for Band 42 and 43 of the ABA model
RoHS	Directive 2011/65/EU
Safety	EN/IEC 60950-1; 60950-22 UL 62368-1, UL 60950-22, UL 50E, EN/IEC 60529 (IP66)

The CE mark is valid for Band 3, 7, 38, 40, 42, 43 of the Compact mono-band models and Band 42, 43 of the ABA models.

The FCC ID is valid for Band 7 and 41 of the Compact mono-band models. See section 18.1 for the FCC ID for each model.

The ISED ID is valid for Band 42 and 43 of the ABA model.

See chapter 18 for FCC statements and label instructions.

Standards certification

15.2 Standards certification for the Compact multi-band models

Table 17 provides standards certification information for the Compact multi-band models of the Nokia FastMile 4G Receiver.

Table 17 Standards certifications for the Nokia FastMile 4G Receiver Compact multi-band models

Category	Certifications
RF	EN 301 908-13 for Band 1, 3, 7, 20, 28, 38, 40 of the Compact multi-band 4G05-A model and Band 3, 7, 20, and 32 of the Compact multi-band 4G04-A model FCC 47 Part 27 for Band 41 of the Compact multi-band 4G05-A model
EMC	ETSI EN 301 489-1 and -52 for Band 1, 3, 7, 20, 28, 38, 40 of the Compact multi-band 4G05-A model and Band 3, 7, 20, 32 of the Compact multi-band 4G04-A model FCC 47 part 2/15 for Band 41 of the Compact multi-band 4G05-A model
RoHS	Directive 2011/65/EU
Safety	EN/IEC 60950-1; 60950-22 UL 62368-1, UL 60950-22, UL 50E, EN/IEC 60529 (IP66)

The CE mark is valid for Band 3, 7, 20, 32 of the Compact multi-band 4G04-A model and Band 1, 3, 7, 20, 28, 38, 40 of the Compact multi-band 4G05-A model. The FCC ID is valid for Band 41 of the Compact multi-band 4G05-A model. See section 18.1 for the FCC ID for each model.

See chapter 18 for FCC statements and label instructions.

Appendix A: Specifications

16 Appendix A: Specifications

16.1 Specifications

16.1 Specifications

Table 18 provides some specifications for the Nokia FastMile 4G Receiver.

Table 18 Specifications for the Nokia FastMile 4G Receiver

Item	Description
------	-------------

Dimensions	Compact multi-band models: 22.7 cm by 22.7 cm by 6.4 cm (8.94 in by 8.94 in by 2.52 in) Compact mono-band models: 23.5 cm by 23.5 cm by 5.2 cm (9.3 in by 9.3 in by 2 in) ABA: 31.8 cm by 31.8 cm by 5.6 cm (12.5 in by 12.5 in by 2.2 in)
Weight	Compact multi-band models: 0.88 kg (1.9 lb) Compact mono-band models: 1.3 kg (2.9 lb) ABA: 2 kg (4.4 lb)
Power consumption	7 w
Operating altitude	Maximum operating altitude is 3048 m (10 000 ft) above mean sea level
Non-operating altitude	Maximum non-operating altitude is 12 192 m (40 000 ft) above mean sea level
Operating temperature	Compact mono-band and ABA models: -30°C to 65°C (-22°F to 149°F) Compact multi-band models: -30°C to 55°C (-22°F to 131°F)
Storage temperature	-40°C to 85°C (-85°F to 185°F)
Operating humidity	5% to 85% relative humidity, non-condensing
Storage humidity	5% to 93% relative humidity, non-condensing
IP rating	IP66 TYPE3

Appendix A: Specifications

17 Appendix B: RF exposure

17.1 RF exposure

17.1 RF exposure

The international standard used for the assessment of this device provides simple conformity assessment methods for low power electronic and electrical equipment to an exposure limit relevant to electromagnetic fields (EMF).

Based on the compliance criteria for maximum permissible exposure as in EN 50385:2017 and CE Council Recommendation Directive 2014/53/EU, there should be a minimum of 50 cm (20 in) separation distance from the user for Band 3, 7, 38, 40, 42, 43 of the Compact mono-band models and Band 42, 43 of the ABA model.

Based on the compliance criteria for maximum permissible exposure as in EN 50385:2017 and CE Council Recommendation Directive 2014/53/EU, there should be a minimum of 50 cm (20 in) separation distance from the user for Band 3, 7, 20, 32 of the Compact multi-band 4G04-A model and Band 1, 3, 7, 20, 28, 38, 40 of the Compact multi-band 4G05-A model.

Based on the compliance criteria for maximum permissible exposure as in FCC 47 Part 27, there should be a minimum of 50 cm (20 in) separation distance from the user for Band 41 of the Compact multi-band 4G05-A model.

Appendix B: RF exposure

18 Appendix C: FCC statements and label instructions

18.1 FCC compliance statement

18.2 FCC radiation exposure statement

18.3 FCC label instructions

18.1 FCC compliance statement

Table 19 provides the FCC ID for the Nokia FastMile 4G Receiver.

Table 19 FCC ID for Nokia FastMile 4G Receiver

Model	FCC ID
4G01-A	2ADZR34003800FM20
4G01-B	2ADZR34003800FM201
4G02-A	Not applicable
4G03-A	2ADZR23002690FM20
4G05-A	2ADZR4G05A

Any Changes or modifications not expressly approved by the party responsible for compliance could void the user's authority to operate the equipment.

This device complies with part 15 of the FCC Rules. Operation is subject to the following two conditions:

- 1) This device may not cause harmful interference, and
- 2) This device must accept any interference received, including Interference that may cause undesired operation.

18.2 FCC radiation exposure statement

This equipment complies with FCC radiation exposure limits set forth for an uncontrolled environment. This equipment should be installed and operated with minimum distance 50 cm (20 in) between the radiator and your body.

19 Glossary

This glossary provides the expansions and optional descriptions of most acronyms and initialisms that appear in this document.

3GPP	3rd Generation Partnership Project
ABA	Automated Beam Alignment
ACS	Auto Configuration Server
ALED	Alcatel-Lucent Electronic Download
ANSI	American National Standards Institute
AP	Access Point
APN	Access Point Name
CA	Certificate Authority or Carrier Aggregation
CRoHS	China Restriction of Hazardous Substances
DSCP	Differentiated Services Code Point
DUID	Device Unique Identifier
EARFCN	E-UTRA Absolute Radio Frequency Channel Number
ECI	External Call Interface
EPC	Evolved Packet Core
E-UTRA	Evolved Universal Terrestrial Radio Access
EIP	Electronic Information Products
EMC	Electromagnetic Compatibility
EMI	Electromagnetic Interference
EPC	Evolved Packet Core
ESD	Electrostatic Discharge
ETL	Electrotechnical Laboratory

ETSI	European Telecommunications Standards Institute
FCC	Federal Communications Commission
FDD	Frequency Division Duplex
FM	FastMile
Glossary	
HSS	Home Subscriber Server
IEEE	Institute of Electrical and Electronics Engineers
IP	International Protection or Internet Protocol
IPTV	Internet Protocol over Television
LAN	Local Area Network
LED	Light Emitting Diode
LTE	Long-Term Evolution
MAC	Media Access Control
MCV	Maximum Concentration Value or Minimum Concentration Value
MIMO	Multiple-Input Multiple-Output
MME	Mobility Management Entity
NAC	Network Access Control
NEC	National Electrical Code
OAM	Operations and Maintenance
OLCS	On-line Customer Support
PCI	Physical Cell Identifier
PCRF	Policy and Charging Rules Function
PDF	Portable Document Format
PIN	Personal Identification Number
PoE	Power over Ethernet
QCI	QoS Class Identifier
QoS	Quality of Service
QR	Quick Response

RF	Radio Frequency
RoHS	Restriction of Hazardous Substances
RSRP	Reference Signal Received Power
RSRQ	Reference Signal Received Quality
RSSI	Received Signal Strength Indicator
SIM	Subscriber Identify Module
SINR	Signal-to-Interference-plus-Noise Ratio
TCP	Transmission Control Protocol
TDD	Time Division Duplex
UDP	User Datagram Protocol
UL	Underwriters' Laboratories
URL	Uniform Resource Locator
VDC	Volts Direct Current
VoIP	Voice over Internet Protocol
VPN	Virtual Private Network
WiFi	Wireless Fidelity
ZIP	Compressed File

Glossary

Customer document and product support

Customer documentation



[Customer Documentation Welcome Page](#)

Technical Support



[Customer Documentation Technical Support](#)

Documentation feedback



[Customer Documentation Feedback](#)

Copyright 2019 Nokia.
3TG-00386-ABAA-TCZZA