

AP20 Installation Guide

1 Contents of the box and important features:

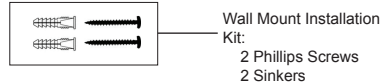

Factory Reset Switch

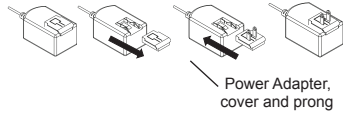
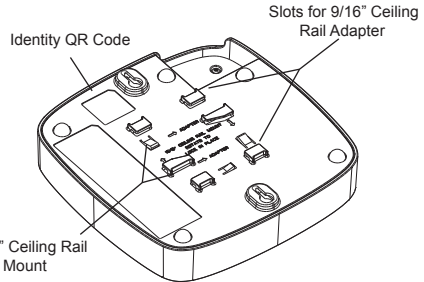
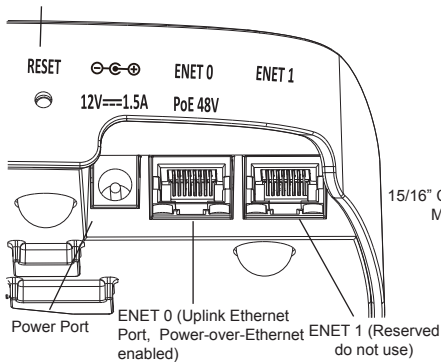

2 Setting up your AP20 Access Point

There are four steps to setting up an AP20 access point:

1. Linking the access point to your Art2Wave account
2. Connecting the access point to your network and power supply
3. Mounting the access point
4. Verifying connectivity

3 Linking the Access Point to your Art2Wave account

There are two ways to link your access point to your account: using your mobile device or using the Art2Wave website.

3.1 Using your mobile device

By installing the Art2Wave mobile device app, you can scan the QR code on the back of the access point and link it to your account. Information about the app is available at <http://art2wave.com>. The mobile device app includes instructions for completing the process.

3.2 Using the Website

To link the access point to your account using the Website, sign into your account at <http://art2wave.com> and follow the instructions in the Art2Wave web site to complete the process.

4 Connecting the Access Point to your network and power supply

Connect the access point to your network by plugging an Ethernet cable into the ENET 0 port. Do not connect to the ENET 1 port (this port is reserved for future use).

The Access point is powered either by connecting the supplied power adapter to an AC wall outlet or by connecting the ENET 0 port to a device that provides 802.3af Power-over-Ethernet. If using the supplied power adapter, remove the cover and insert the prong as shown in Section 1.

5 Mounting the Access Point

Note: Do not mount the access point until it is linked to your Art2Wave account.

You can mount the AP20 in the following ways:

- Ceiling mounting (with 15/16" or 9/16" rails)
- Wall mounting
- Desk mounting

5.1 Tips for selecting a location

The best location for your access point is at the center of your wireless coverage area, within line of sight of all wireless devices. To get the best performance, consider the following:

- Mount the access point as high as possible above any obstructions
- Do not mount the access point next to building support columns or any other physical obstructions that may cause dead zones
- Do not mount the access point near any material that may absorb or reflect Wi-Fi signals



Warning

This unit must be installed indoors. The unit, AC power adapter, and its cables are not designed for outdoor use.

5.2 Ceiling mounting to a 15/16" rail

The figure below shows you how to clip the access point to a 15/16" ceiling rail. Printed instructions on the back of the unit explain which clips to use.

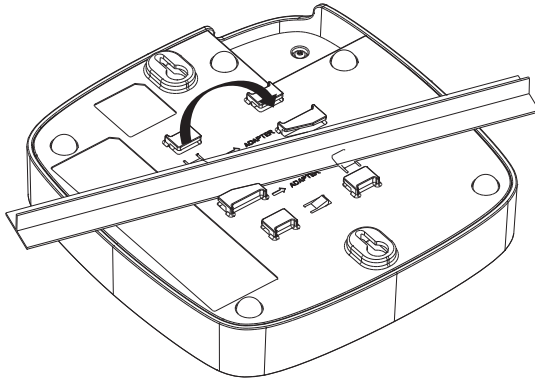

Slide the Access point diagonally over the rail and rotate until the unit clicks into place.

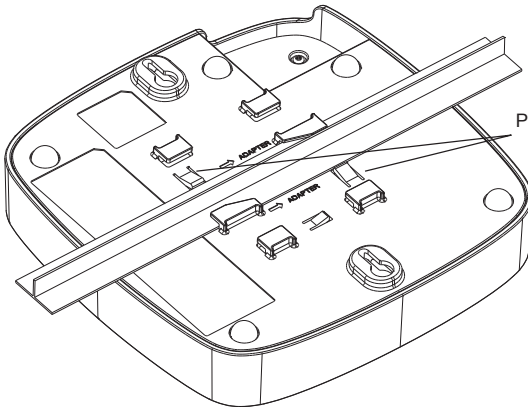

Press these clips in and turn to dismount the Access Point

5.3 Ceiling mounting to a 9/16" rail

The figure below shows you how to use the adapter to clip the access point to a 9/16" ceiling rail. Printed instructions on the back of the unit explain which clips to use.

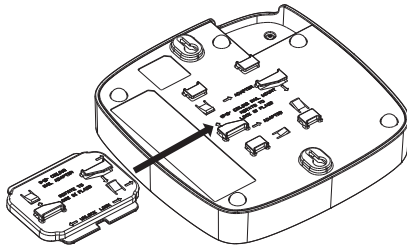

1. Slide the adapter into the clips on the back on the unit.

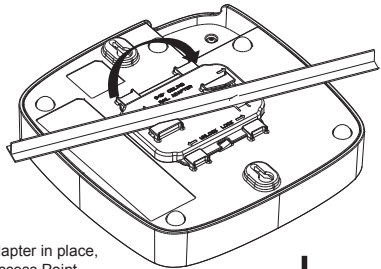
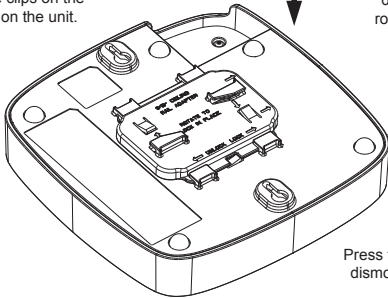

2. With the adapter in place, slide the Access Point diagonally over the rail and rotate until the unit clicks into place.

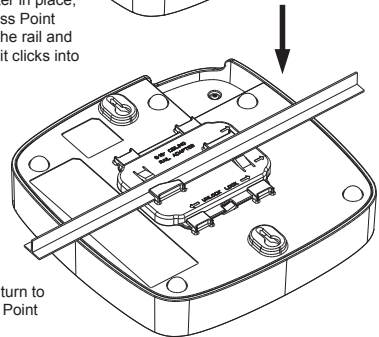

Press these clips and turn to
dismount the Access Point

5.4 Wall mounting

The figure below shows you how to mount the access point to a wall using screws and sinkers.
Note: Screw center distance = 141mm.

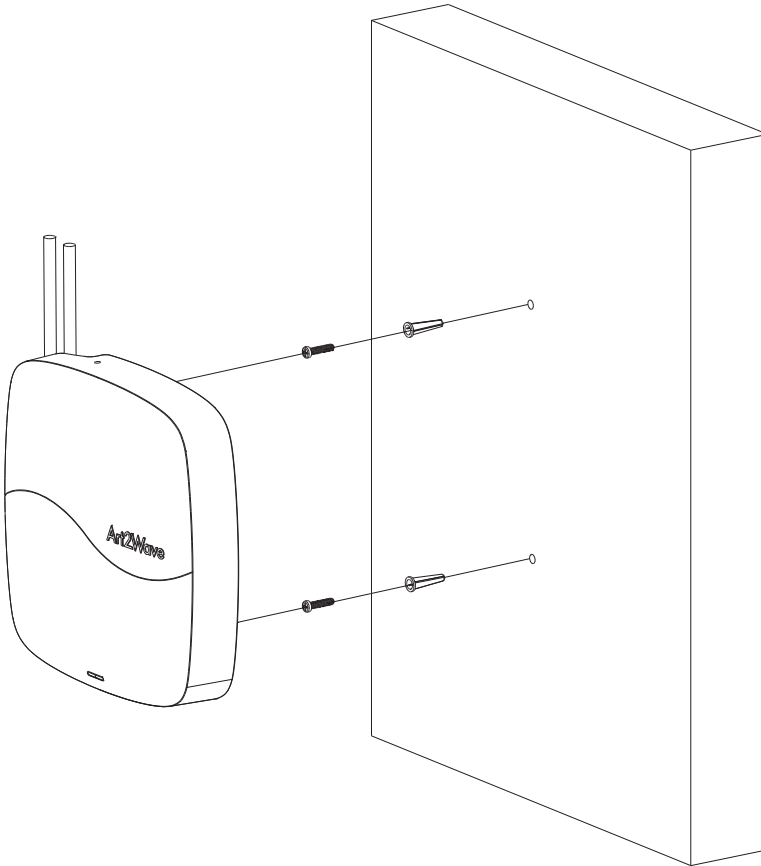

6 Verifying connectivity

You can verify that the AP20 Access point is connected to your network by using either the Art2Wave website, or mobile device app that you used to link the unit to your Account.

Check the Status LED to determine whether the access point is operating correctly. The access point is properly installed and connected to the Art2Wave management services when the LED turns solid blue after a few minutes.

When the access point is powered on, the Status LED should display the following sequence:

#	LED	Status Description
1	Solid red <i>(for less than 5 seconds)</i>	Unit has just received power and has started booting
2	Solid Yellow <i>(for less than a minute)</i>	Unit is starting up. Or if the Factory Reset switch has been pressed, the unit is resetting to factory condition.
3	Blinking blue <i>(for less than a minute)</i>	Access point is negotiating a connection with Art2Wave management services in the cloud.
4	Solid blue	Access point is successfully set up to be managed by Art2Wave management services in the cloud.

Note: See the Tips and Troubleshooting section if the access point does not reach Solid blue. For a full description of LED Status Description visit the Support website (www.art2wave.com/support).

7 Tips and Troubleshooting

7.1 If your access point status light is flashing yellow

The access point cannot connect to the Art2Wave management services. This usually occurs when the unit cannot get an IP Address from your network using DHCP and has switched to Local Network Configuration mode.

While in this mode, the access point will not pass data through the ENET 0 port and will broadcast an SSID that contains a portion of the access point's MAC Address. You can use any Wi-Fi enabled device to connect to this SSID and configure the network settings for this access point using a web browser

To connect to the access point using the Local Network Configuration interface:

1. Connect your Wi-Fi enabled device to the SSID in the form of "AP-XX:XX:XX" (where X is a placeholder). You are successfully connected when the LED on the Access Point becomes solid purple
2. Use your web browser to navigate to <http://192.168.100.1>
3. Follow the on-screen instructions

See the Support section (<http://art2wave.com/support>) for information about Local Network Configuration.

Note: Local Configuration mode will only activate if the access point is in Factory Default condition and has never connected to the Art2Wave management services in the cloud.

7.2 Resetting back to factory defaults

If the access point is disconnected from a power source, press and hold the reset button, and connect power to the unit. The LED will turn solid white to indicate the unit is restoring itself to Factory Defaults.

OR

If the access point is connected to a power source, press and hold the reset button until the LED turns solid white and then release. This will restore the unit to the factory default settings.

8 Learning More, Service, and Support

8.1 Online Resources

Our support website (<http://art2wave.com/support>) contains links to online resources available to help you get the most out of your access point.

8.2 Copyright and Trademark

Copyright © 2015 Art2Wave, Inc. All rights reserved. The contents of this Installation Guide are the copyrighted and proprietary property of Art2Wave, Inc. Reproduction, distribution or modification without the express, written permission of Art2Wave, Inc. is not permitted. “Art2Wave” is a trademark of Art2Wave, Inc. All other trademarks are the property of their respective owners.

8.3 Open Source Code

Certain Art2Wave products include open source software code subject to the GNU General Public License (GPL) and other Open Source Licenses. For more information, see: <http://art2wave.com/opensource>

9 Legal Notice

EXCEPT FOR ANY WRITTEN EXPRESS WARRANTY WE MAY SEPARATELY OFFER TO YOU, AND TO THE EXTENT PERMITTED BY LAW, THIS PRODUCT IS PROVIDED “AS IS” AND WE SPECIFICALLY DISCLAIM ALL EXPRESS, STATUTORY AND IMPLIED WARRANTIES, INCLUDING, BUT NOT LIMITED TO, WARRANTIES OF MERCHANTABILITY, FITNESS FOR A PARTICULAR PURPOSE, NON-INFRINGEMENT AND AGAINST HIDDEN OR LATENT DEFECTS. IF WE CANNOT LAWFULLY DISCLAIM STATUTORY OR IMPLIED WARRANTIES, THEN TO THE EXTENT PERMITTED BY LAW, ALL SUCH WARRANTIES SHALL BE LIMITED IN DURATION TO THE DURATION OF ANY WRITTEN EXPRESS WARRANTY WE MAY SEPARATELY OFFER TO YOU, AS APPLICABLE, AND TO REPAIR OR REPLACEMENT SERVICE. SOME JURISDICTIONS DO NOT ALLOW LIMITATIONS ON HOW LONG A STATUTORY OR IMPLIED WARRANTY LASTS, SO THE ABOVE LIMITATION MAY NOT APPLY TO YOU. WE ARE NOT RESPONSIBLE FOR DIRECT, SPECIAL, INCIDENTAL OR CONSEQUENTIAL DAMAGES RESULTING FROM ANY BREACH OF WARRANTY OR UNDER ANY OTHER LEGAL THEORY. IN SOME JURISDICTIONS THE FOREGOING LIMITATION DOES NOT APPLY TO DEATH OR PERSONAL INJURY CLAIMS, OR ANY STATUTORY LIABILITY FOR INTENTIONAL AND GROSS NEGLIGENT ACTS AND/OR OMISSIONS, SO THE ABOVE EXCLUSION OR LIMITATION MAY NOT APPLY TO YOU. SOME JURISDICTIONS DO NOT ALLOW THE EXCLUSION OR LIMITATION OF DIRECT, INCIDENTAL OR CONSEQUENTIAL DAMAGES, SO THE ABOVE EXCLUSION OR LIMITATION MAY NOT APPLY TO YOU.

10 AP20 Specifications and Safety Guidelines

Specifications:

Frequency Band: 2.4GHz and 5GHz

Standards: 802.11a, 802.11b, 802.11g, 802.1n, and 802.11ac specifications

Interfaces:

1 RJ-45 10/100/1000Base-T Gigabit Ethernet Uplink with 802.3af Power-over-Ethernet (PoE) support (15.4W)

1 RJ-45 10/100/1000Base-T Gigabit Ethernet LAN

Simultaneous dual-band 802.11ac Wi-Fi

Environmental Specifications:

Operating Temperature: 0 to 40°C

Storage Temperature: -40 to 80°C

Relative Humidity (Operational): 10 to 90% RH (non-condensing)

Relative Humidity (Storage): 5 to 95% RH (non-condensing)

11 Regulatory Compliance Information

11.1 FCC

This equipment has been tested and found to comply with the limits for a Class B digital device, pursuant to Part 15 of the FCC Rules. These limits are designed to provide reasonable protection against harmful interference in a residential installation. This equipment generates, uses and can radiate radio frequency energy and, if not installed and used in accordance with the instructions, may cause harmful interference to radio communications. However, there is no guarantee that interference will not occur in a particular installation. If this equipment does cause harmful interference to radio or television reception, which can be determined by turning the equipment off and on, the user is encouraged to try to correct the interference by one of the following measures:

- Reorient or relocate the receiving antenna
- Increase the separation between the equipment and receiver
- Connect the equipment into an outlet on a circuit different from that to which the receiver is connected
- Consult the dealer or an experienced radio/TV technician for help

FCC Caution: Any changes or modifications not expressly approved by the party responsible for compliance could void the user's authority to operate this equipment. See 47 CFR 1.80.

This device complies with Part 15 of the FCC Rules. Operation is subject to the following two conditions: (1) This device may not cause harmful interference, and (2) this device must accept any interference received, including interference that may cause undesired operation.

IMPORTANT NOTE:

Radiation Exposure Statement:

This equipment complies with FCC radiation exposure limits set forth for an uncontrolled environment. This equipment should be installed and operated with minimum distance 20cm between the radiator & your body.

This transmitter must not be co-located or operating in conjunction with any other antenna or transmitter.

Regulatory domain cannot be altered for US/CANADA products.

Operation of this device is restricted to indoor use only.

11.2 Industry Canada

This device complies with Industry Canada's licence-exempt RSSs. Operation is subject to the following two conditions:

(1) This device may not cause interference; and (2) This device must accept any interference, including interference that may cause undesired operation of the device.

Cet appareil est conforme aux CNR exemptes de licence d'Industrie Canada. Son fonctionnement est soumis aux deux conditions suivantes:

(1) Ce dispositif ne peut causer d'interférences; et(2) Ce dispositif doit accepter toute interférence, y compris les interférences qui peuvent causer un mauvais fonctionnement de l'appareil.

Caution:

- (i) the device for operation in the band 5150-5250 MHz is only for indoor use to reduce the potential for harmful interference to co-channel mobile satellite systems;
- (ii) the maximum antenna gain permitted for devices in the bands 5250-5350 MHz and 5470-5725 MHz shall comply with the e.i.r.p. limit; and
- (iii) the maximum antenna gain permitted for devices in the band 5725-5825 MHz shall comply with the e.i.r.p. limits specified for point-to-point and non point-to-point operation as appropriate.

(iv) Users should also be advised that high-power radars are allocated as primary users (i.e. priority users) of the bands 5250-5350 MHz and 5650-5850 MHz and that these radars could cause interference and/or damage to LE-LAN devices.

Avertissement:

- (i) les dispositifs fonctionnant dans la bande 5150-5250 MHz sont réservés uniquement pour une utilisation à l'intérieur afin de réduire les risques de brouillage préjudiciable aux systèmes de satellites mobiles utilisant les mêmes canaux;
- (ii) le gain maximal d'antenne permis pour les dispositifs utilisant les bandes 5 250-5 350 MHz et 5 470-5 725 MHz doit se conformer à la limite de p.i.r.e.;
- (iii) le gain maximal d'antenne permis (pour les dispositifs utilisant la bande 5 725-5 825 MHz) doit se conformer à la limite de p.i.r.e. spécifiée pour l'exploitation point à point et non point à point, selon le cas.
- (iv) De plus, les utilisateurs devraient aussi être avisés que les utilisateurs de radars de haute puissance sont désignés utilisateurs principaux (c.-à-d., qu'ils ont la priorité) pour les bandes 5 250-5 350 MHz et 5 650-5 850 MHz et que ces radars pourraient causer du brouillage et/ou des dommages aux dispositifs LAN-EL.

Radiation Exposure Statement:

This equipment complies with IC radiation exposure limits set forth for an uncontrolled environment. This equipment should be installed and operated with minimum distance 20cm between the radiator & your body.

Déclaration d'exposition aux radiations:

Cet équipement est conforme aux limites d'exposition aux rayonnements IC établies pour un environnement non contrôlé. Cet équipement doit être installé et utilisé avec un minimum de 20 cm de distance entre la source de rayonnement et votre corps.



ICES-003 issue 5(2013/08/01)
CAN ICES-3(*)/NMB-3(*)
[*] = Class A or B



5018095201