

FCC Radio Test Report

FCC ID: 2ADQS-107001535

Report No. : BTL-FCCP-1-2311T124
Equipment : Portable Bluetooth Speaker
Model Name : Rockster Cross
Brand Name : **Teufel**
Applicant : Lautsprecher Teufel GmbH
Address : Budapester Strasse 44,10787 Berlin, Germany
Radio Function : Bluetooth
FCC Rule Part(s) : FCC CFR Title 47, Part 15, Subpart C (15.247)
Measurement Procedure(s) : ANSI C63.10-2013
Date of Receipt : 2023/11/27
Date of Test : 2023/12/14 ~ 2023/12/18
Issued Date : 2024/1/31

The above equipment has been tested and found in compliance with the requirement of the above standards by BTL Inc.

Prepared by

Jerry Chuang, Supervisor

Approved by

Peter Chen, Manager



BTL Inc.

No.18, Ln. 171, Sec. 2, Jiuzong Rd., Neihu Dist., Taipei City 114, Taiwan

Tel: +886-2-2657-3299 Fax: +886-2-2657-3331 Web: www.newbtl.com Service mail: btl_qa@newbtl.com

Declaration

BTL represents to the client that testing is done in accordance with standard procedures as applicable and that test instruments used has been calibrated with standards traceable to international standard(s) and/or national standard(s).

BTL's reports apply only to the specific samples tested under conditions. It is manufacture's responsibility to ensure that additional production units of this model are manufactured with the identical electrical and mechanical components. **BTL** shall have no liability for any declarations, inferences or generalizations drawn by the client or others from **BTL** issued reports.

This report is the confidential property of the client. As a mutual protection to the clients, the public and ourselves, the test report shall not be reproduced, except in full, without our written approval.

BTL's laboratory quality assurance procedures are in compliance with the **ISO/IEC 17025** requirements, and accredited by the conformity assessment authorities listed in this test report.

BTL is not responsible for the sampling stage, so the results only apply to the sample as received.

The information, data and test plan are provided by manufacturer which may affect the validity of results, so it is manufacturer's responsibility to ensure that the apparatus meets the essential requirements of applied standards and in all the possible configurations as representative of its intended use.

Limitation

For the use of the authority's logo is limited unless the Test Standard(s)/Scope(s)/Item(s) mentioned in this test report is (are) included in the conformity assessment authorities acceptance respective.

Please note that the measurement uncertainty is provided for informational purpose only and are not use in determining the Pass/Fail results.

CONTENTS

1	SUMMARY OF TEST RESULTS	6
1.1	TEST FACILITY	7
1.2	MEASUREMENT UNCERTAINTY	7
1.3	TEST ENVIRONMENT CONDITIONS	7
1.4	DUTY CYCLE	8
2	GENERAL INFORMATION	9
2.1	DESCRIPTION OF EUT	9
2.2	TEST MODES	11
2.3	BLOCK DIAGRAM SHOWING THE CONFIGURATION OF SYSTEM TESTED	12
2.4	SUPPORT UNITS	13
3	AC POWER LINE CONDUCTED EMISSIONS TEST	14
3.1	LIMIT	14
3.2	TEST PROCEDURE	14
3.3	DEVIATION FROM TEST STANDARD	14
3.4	TEST SETUP	15
3.5	TEST RESULT	15
4	RADIATED EMISSIONS TEST	16
4.1	LIMIT	16
4.2	TEST PROCEDURE	17
4.3	DEVIATION FROM TEST STANDARD	17
4.4	TEST SETUP	17
4.5	EUT OPERATING CONDITIONS	19
4.6	TEST RESULT – BELOW 30 MHZ	19
4.7	TEST RESULT – 30 MHZ TO 1 GHZ	19
4.8	TEST RESULT – ABOVE 1 GHZ	19
5	NUMBER OF HOPPING CHANNEL	20
5.1	APPLIED PROCEDURES	20
5.2	TEST PROCEDURE	20
5.3	DEVIATION FROM STANDARD	20
5.4	TEST SETUP	20
5.5	EUT OPERATION CONDITIONS	20
5.6	TEST RESULTS	20
6	AVERAGE TIME OF OCCUPANCY	21
6.1	APPLIED PROCEDURES / LIMIT	21
6.2	TEST PROCEDURE	21
6.3	DEVIATION FROM STANDARD	21
6.4	TEST SETUP	21
6.5	EUT OPERATION CONDITIONS	21
6.6	TEST RESULTS	21
7	HOPPING CHANNEL SEPARATION MEASUREMENT	22
7.1	APPLIED PROCEDURES / LIMIT	22
7.2	TEST PROCEDURE	22
7.3	DEVIATION FROM STANDARD	22
7.4	TEST SETUP	22
7.5	TEST RESULTS	22
8	BANDWIDTH TEST	23
8.1	APPLIED PROCEDURES	23

8.2	TEST PROCEDURE	23
8.3	DEVIATION FROM STANDARD	23
8.4	TEST SETUP	23
8.5	EUT OPERATION CONDITIONS	23
8.6	TEST RESULTS	23
9	OUTPUT POWER TEST	24
9.1	LIMIT	24
9.2	TEST PROCEDURE	24
9.3	DEVIATION FROM STANDARD	24
9.4	TEST SETUP	24
9.5	EUT OPERATION CONDITIONS	24
9.6	TEST RESULTS	24
10	ANTENNA CONDUCTED SPURIOUS EMISSION	25
10.1	APPLIED PROCEDURES / LIMIT	25
10.2	TEST PROCEDURE	25
10.3	DEVIATION FROM STANDARD	25
10.4	TEST SETUP	25
10.5	EUT OPERATION CONDITIONS	25
10.6	TEST RESULTS	25
11	LIST OF MEASURING EQUIPMENTS	26
12	EUT TEST PHOTO	28
13	EUT PHOTOS	28
APPENDIX A	AC POWER LINE CONDUCTED EMISSIONS	29
APPENDIX B	RADIATED EMISSIONS - 9 KHZ TO 30 MHZ	34
APPENDIX C	RADIATED EMISSIONS - 30 MHZ TO 1 GHZ	39
APPENDIX D	RADIATED EMISSIONS - ABOVE 1 GHZ	42
APPENDIX E	NUMBER OF HOPPING CHANNEL	61
APPENDIX F	AVERAGE TIME OF OCCUPANCY	63
APPENDIX G	HOPPING CHANNEL SEPARATION MEASUREMENT	66
APPENDIX H	BANDWIDTH	69
APPENDIX I	OUTPUT POWER	72
APPENDIX J	ANTENNA CONDUCTED SPURIOUS EMISSION	74

REVISION HISTORY

Report No.	Version	Description	Issued Date	Note
BTL-FCCP-1-2311T124	R00	Original Report.	2024/1/31	Valid

1 SUMMARY OF TEST RESULTS

Test procedures according to the technical standards.

Standard(s) Section	Description	Test Result	Judgement	Remark
15.207	AC Power Line Conducted Emissions	APPENDIX A	Pass	-----
15.205 15.209 15.247(d)	Radiated Emissions	APPENDIX B APPENDIX C APPENDIX D	Pass	-----
15.247 (a)(1)(iii)	Number of Hopping Frequency	APPENDIX E	Pass	-----
15.247 (a)(1)(iii)	Average Time of Occupancy	APPENDIX F	Pass	-----
15.247 (a)(1)	Hopping Channel Separation	APPENDIX G	Pass	-----
15.247 (a)(1)	Bandwidth	APPENDIX H	Pass	-----
15.247 (b)(1)	Output Power	APPENDIX I	Pass	-----
15.247(d)	Antenna conducted Spurious Emission	APPENDIX J	Pass	-----
15.203	Antenna Requirement	-----	Pass	-----

NOTE:

- (1) "N/A" denotes test is not applicable in this Test Report.
- (2) The report format version is TP.1.1.1.

1.1 TEST FACILITY

The test locations stated below are under the TAF Accreditation Number 0659.

The test location(s) used to collect the test data in this report are:

No. 68-1, Ln. 169, Sec. 2, Datong Rd., Xizhi Dist., New Taipei City 221, Taiwan
(FCC DN: TW0659)

C05 CB08 CB11 SR10 SR11

No. 72, Ln. 169, Sec. 2, Datong Rd., Xizhi Dist., New Taipei City 221, Taiwan
(FCC DN: TW0659)

C06 CB21 CB22

1.2 MEASUREMENT UNCERTAINTY

The reported uncertainty of measurement $y \pm U$, where expanded uncertainty U is based on a standard uncertainty multiplied by a coverage factor of $k = 2$, providing a level of confidence of approximately **95 %**. The measurement instrumentation uncertainty considerations contained in CISPR 16-4-2. The BTL measurement uncertainty is less than the CISPR 16-4-2 $U_{\text{cisp}} requirement$.

A. AC power line conducted emissions test:

Test Site	Method	Measurement Frequency Range	U (dB)
C05	CISPR	150 kHz ~ 30MHz	3.44

B. Radiated emissions test:

Test Site	Measurement Frequency Range	U, (dB)
CB21	0.03 GHz ~ 0.2 GHz	4.17
	0.2 GHz ~ 1 GHz	4.72
	1 GHz ~ 6 GHz	5.21
	6 GHz ~ 18 GHz	5.51
	18 GHz ~ 26 GHz	3.69
	26 GHz ~ 40 GHz	4.23

C. Conducted test :

Test Item	U (dB)
Occupied Bandwidth	0.5338
Output power	0.3659
Conducted Spurious emissions	0.5416
Conducted Band edges	0.5348
Dwell time	0.6606
Channel separation	0.6606
Channel numbers	0.6606

NOTE:

Unless specifically mentioned, the uncertainty of measurement has not been taken into account to declare the compliance or non-compliance to the specification.

1.3 TEST ENVIRONMENT CONDITIONS

Test Item	Environment Condition	Test Voltage	Tested by
AC Power Line Conducted Emissions	18 °C, 44 %	AC 120V	Jerry Chuang
Radiated emissions below 1 GHz	Refer to data	AC 120V	Kevin Zhen
Radiated emissions above 1 GHz	Refer to data	AC 120V	Kevin Zhen
Number of Hopping Frequency	22 °C, 70 %	AC 120V	Jerry Chuang
Average Time of Occupancy	22 °C, 70 %	AC 120V	Jerry Chuang
Hopping Channel Separation	22 °C, 70 %	AC 120V	Jerry Chuang
Bandwidth	22 °C, 70 %	AC 120V	Jerry Chuang
Output Power	21.1 °C, 66 %	AC 120V	Jerry Chuang
Antenna conducted Spurious Emission	22 °C, 70 %	AC 120V	Jerry Chuang

1.4 DUTY CYCLE

If duty cycle is $\geq 98\%$, duty factor is not required.
 If duty cycle is $< 98\%$, duty factor shall be considered.

Remark	Delta 1			Delta 2	On Time/Period	10 log(1/Duty Cycle)
Mode	ON (ms)	Numbers (ON)	On Time (B) (ms)	Period (ON+OFF) (ms)	Duty Cycle (%)	Duty Factor (dB)
BT (1 Mbps)	2.890	1	2.890	3.760	76.86%	1.14
BT (2 Mbps)	2.880	1	2.880	3.760	76.60%	1.16
BT (3 Mbps)	2.890	1	2.890	3.760	76.86%	1.14

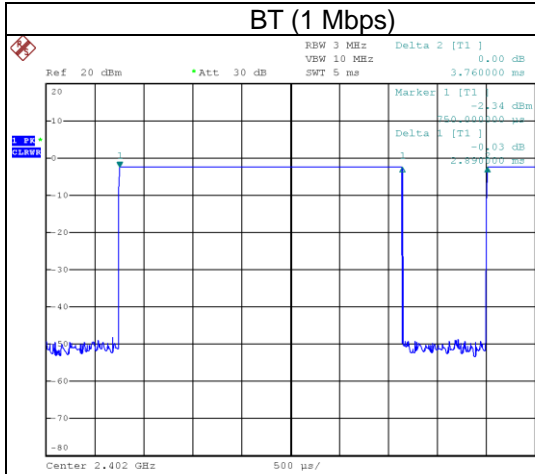

Date: 14.DEC.2023 17:13:07

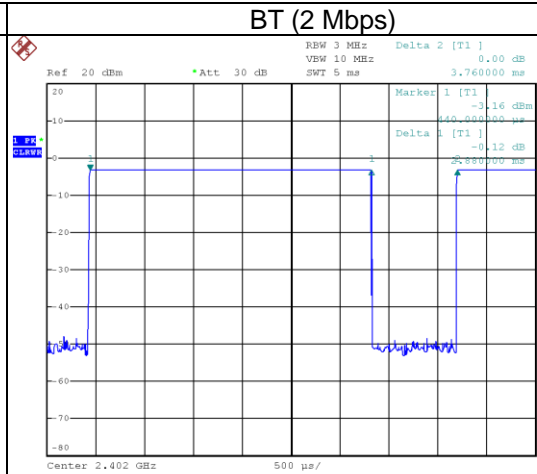

Date: 14.DEC.2023 17:15:09

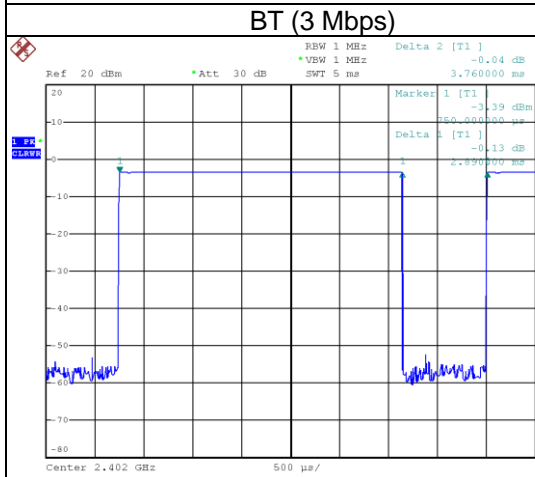

Date: 14.DEC.2023 17:17:11

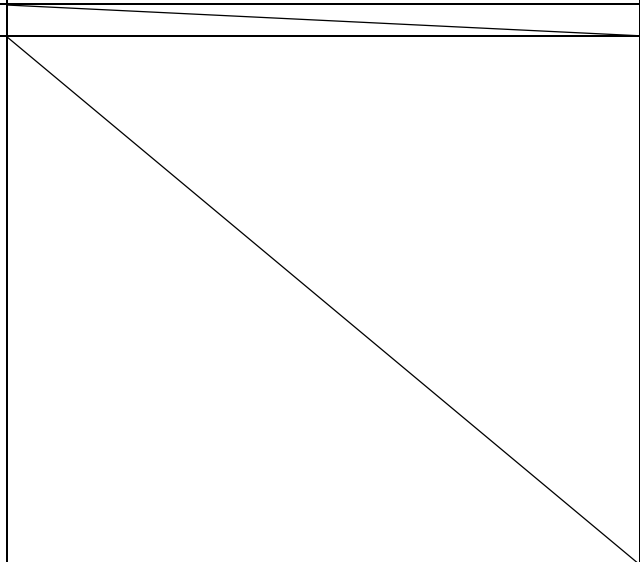

2 GENERAL INFORMATION

2.1 DESCRIPTION OF EUT

Equipment	Portable Bluetooth Speaker
Model Name	Rockster Cross
Brand Name	Teufel
Model Difference	N/A
Power Source	#1 DC Voltage supplied from AC/DC adapter. #2 DC Voltage supplied from battery.
Power Rating	#1 I/P: 100-240Vac, 50/60Hz, 1.5A MAX, O/P: 20.0V ---3.25A, 65.0W #2 DC 7.4V/5510mAh
Products Covered	1 * Battery: Pow-Tech / C0417A1 1 * Adapter: DS / DYS865-200325W 2 * Power Cable (EU Plug and US Plug)
Operation Band	2400 MHz ~ 2483.5 MHz
Operation Frequency	2402 MHz ~ 2480 MHz
Modulation Technology	FHSS
Transfer Rate	1/2/3Mbps
Maximum Output Power	1 Mbps: 9.26 dBm (0.0084 W) 2 Mbps: 8.42 dBm (0.0070 W) 3 Mbps: 8.46 dBm (0.0070 W)
Test Software Version	BlueTest3
Test Model	Rockster Cross
Sample Status	Engineering Sample
EUT Modification(s)	N/A

NOTE:

- (1) The above EUT information is declared by manufacturer and for more detailed features description, please refers to the manufacturer's specifications or user's manual.

(2) Channel List:

Channel	Frequency (MHz)	Channel	Frequency (MHz)	Channel	Frequency (MHz)
00	2402	27	2429	54	2456
01	2403	28	2430	55	2457
02	2404	29	2431	56	2458
03	2405	30	2432	57	2459
04	2406	31	2433	58	2460
05	2407	32	2434	59	2461
06	2408	33	2435	60	2462
07	2409	34	2436	61	2463
08	2410	35	2437	62	2464
09	2411	36	2438	63	2465
10	2412	37	2439	64	2466
11	2413	38	2440	65	2467
12	2414	39	2441	66	2468
13	2415	40	2442	67	2469
14	2416	41	2443	68	2470
15	2417	42	2444	69	2471
16	2418	43	2445	70	2472
17	2419	44	2446	71	2473
18	2420	45	2447	72	2474
19	2421	46	2448	73	2475
20	2422	47	2449	74	2476
21	2423	48	2450	75	2477
22	2424	49	2451	76	2478
23	2425	50	2452	77	2479
24	2426	51	2453	78	2480
25	2427	52	2454		
26	2428	53	2455		

(3) Table for Filed Antenna:

Antenna	Manufacture	Model Name	Type	Connector	Frequency Range (MHz)	Gain (dBi)
1	FIHONEST COMMUNICA CO.,LTD	Onkyo Ryoma SAS200	PCB printed antenna	N/A	2400-2500	-0.017

(4) The above Antenna information are derived from the antenna data sheet provided by manufacturer and for more detailed features description, please refer to the manufacturer's specifications, the laboratory shall not be held responsible.

2.2 TEST MODES

Test Items	Test mode	Channel	Note
AC power line conducted emissions	Normal/Idle	-	-
Transmitter Radiated Emissions (below 1GHz)	1 Mbps	39	-
Transmitter Radiated Emissions (above 1GHz)	1/3 Mbps	00/78	Bandedge
	1/3 Mbps	00/39/78	Harmonic
Transmitter Radiated Emissions (above 18GHz)	1 Mbps	39	-
Number of Hopping Frequency	1/3 Mbps	00~78	-
Average Time of Occupancy	1/3 Mbps	00/39/78	-
Hopping Channel Separation	1/3 Mbps	00/39/78	-
Bandwidth	1/3 Mbps	00/39/78	-
Output Power	1/2/3 Mbps	00/39/78	-
Antenna conducted Spurious Emission	1/3 Mbps	00/39/78	-

NOTE:

- (1) For radiated emission band edge test, both Vertical and Horizontal are evaluated, but only the worst case (Horizontal) is recorded.
- (2) All X, Y and Z axes are evaluated, but only the worst case (X axis) is recorded.

2.3 BLOCK DIAGRAM SHOWING THE CONFIGURATION OF SYSTEM TESTED

Equipment letters and Cable numbers refer to item numbers described in the tables of clause 2.4.

AC Power Line Conducted Emissions Test

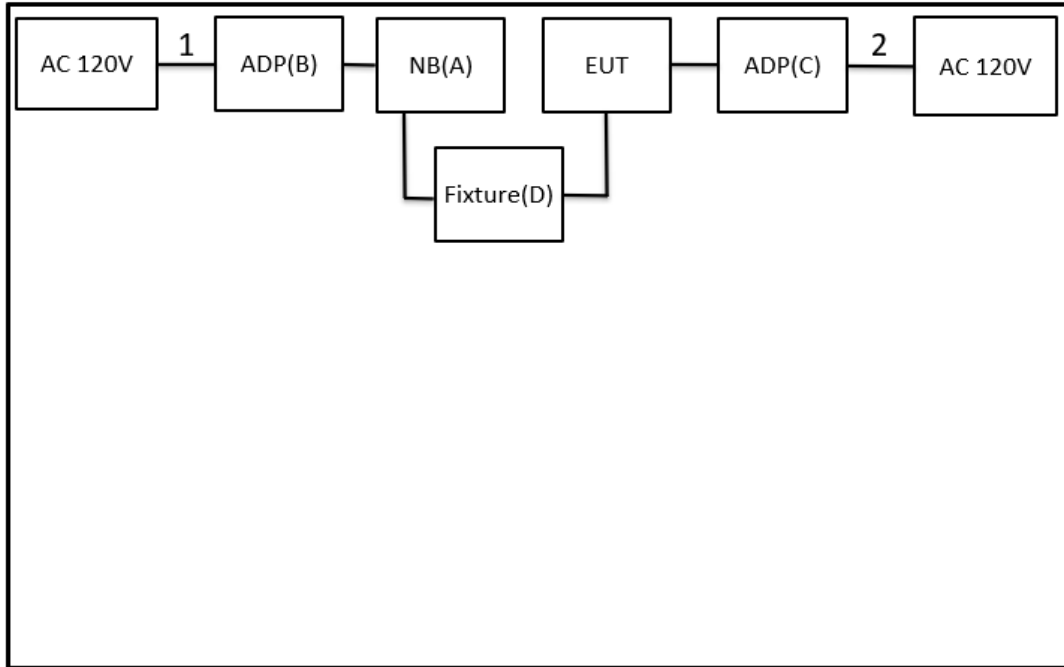

Radiated Emissions Test

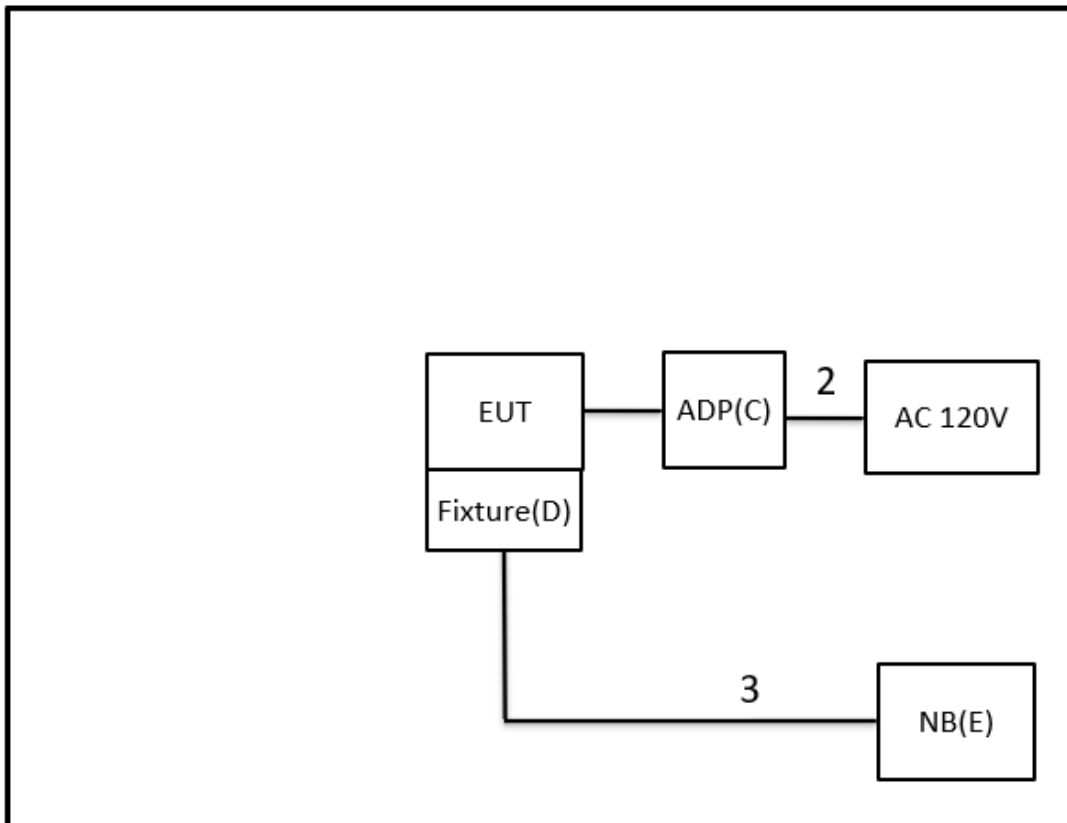

2.4 SUPPORT UNITS

Item	Equipment	Brand	Model No.	Series No.	Remarks
A	NB	HP	240 G5	N/A	Furnished by test lab.
B	ADP	HP	HSTNN-CA40	N/A	Furnished by test lab.
C	ADP	DS	DYS865-200325W	N/A	Supplied by test requester.
D	Fixture	N/A	N/A	N/A	Furnished by test lab.
E	NB	HP	TPN-I119	N/A	Furnished by test lab.

Item	Shielded	Ferrite Core	Length	Cable Type	Remarks
1	N/A	N/A	1m	Power Cord	Furnished by test lab.
2	N/A	N/A	1m	Power Cord	Supplied by test requester.
3	N/A	N/A	1m	USB extension Cable	Furnished by test lab.

3 AC POWER LINE CONDUCTED EMISSIONS TEST

3.1 LIMIT

Frequency (MHz)	Limit (dB μ V)	
	Quasi-peak	Average
0.15 - 0.5	66 - 56 *	56 - 46 *
0.50 - 5.0	56	46
5.0 - 30.0	60	50

NOTE:

- (1) The tighter limit applies at the band edges.
- (2) The limit of " * " marked band means the limitation decreases linearly with the logarithm of the frequency in the range.
- (3) The test result calculated as following:
 Measurement Value = Reading Level + Correct Factor
 Correct Factor = Insertion Loss + Cable Loss + Attenuator Factor (if use)
 Margin Level = Measurement Value – Limit Value

Calculation example:

Reading Level (dB μ V)		Correct Factor (dB)		Measurement Value (dB μ V)
38.22	+	3.45	=	41.67

Measurement Value (dB μ V)		Limit Value (dB μ V)		Margin Level (dB)
41.67	-	60	=	-18.33

The following table is the setting of the receiver.

Receiver Parameter	Setting
Attenuation	10 dB
Start Frequency	0.15 MHz
Stop Frequency	30 MHz
IF Bandwidth	9 KHz

3.2 TEST PROCEDURE

- a. The EUT was placed 0.8 m above the horizontal ground plane with the EUT being connected to the power mains through a line impedance stabilization network (LISN).
 All other support equipment were powered from an additional LISN(s).
 The LISN provides 50 Ohm/50 μ H of impedance for the measuring instrument.
- b. Interconnecting cables that hang closer than 40 cm to the ground plane shall be folded back and forth in the center forming a bundle to keep the cable above 40 cm.
- c. Excess I/O cables that are not connected to a peripheral shall be bundled in the center.
 The end of the cable will be terminated, using the correct terminating impedance.
 The overall length shall not exceed 1 m.
- d. The LISN is spaced at least 80 cm from the nearest part of the EUT chassis.
- e. For the actual test configuration, please refer to the related Item - EUT TEST PHOTO.

NOTE:

- (1) In the results, each reading is marked as Peak, QP or AVG per the detector used.
 BW=9 kHz (6 dB Bandwidth)
- (2) All readings are Peak unless otherwise stated QP or AVG in column of Note. Both the QP and the AVG readings must be less than the limit for compliance.

3.3 DEVIATION FROM TEST STANDARD

No deviation.

3.4 TEST SETUP

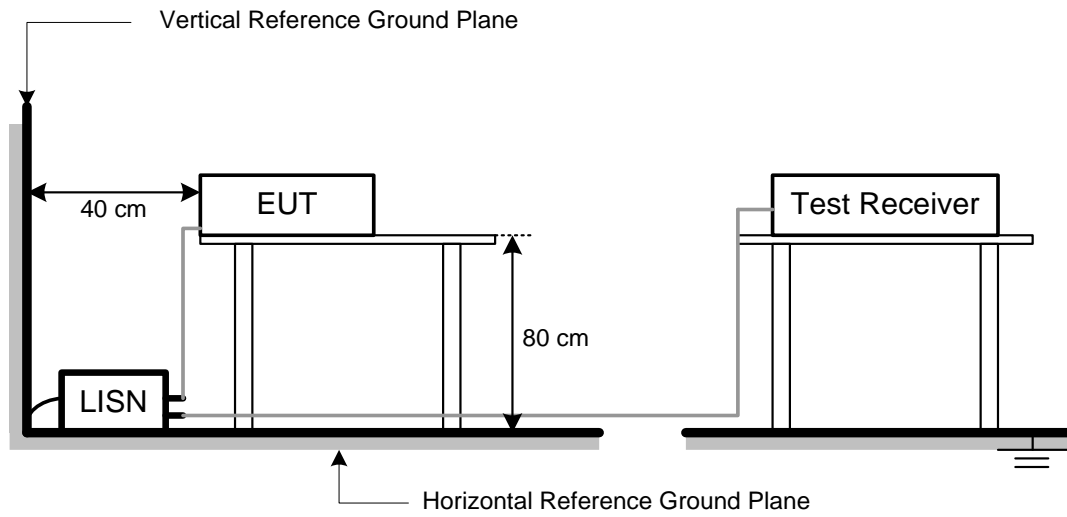

3.5 TEST RESULT

Please refer to the APPENDIX A.

4 RADIATED EMISSIONS TEST

4.1 LIMIT

In case the emission fall within the restricted band specified on 15.205, then the 15.209 limit in the table below has to be followed.

LIMITS OF RADIATED EMISSIONS MEASUREMENT (9 kHz to 1000 MHz)

Frequency (MHz)	Field Strength (microvolts/meter)	Measurement Distance (meters)
0.009~0.490	2400/F(KHz)	300
0.490~1.705	24000/F(KHz)	30
1.705~30.0	30	30
30~88	100	3
88~216	150	3
216~960	200	3
960~1000	500	3

LIMITS OF RADIATED EMISSIONS MEASUREMENT (Above 1000 MHz)

Frequency (MHz)	Radiated Emissions (dBuV/m)		Measurement Distance (meters)
	Peak	Average	
Above 1000	74	54	3

NOTE:

- (1) The limit for radiated test was performed according to FCC Part 15, Subpart C.
- (2) The tighter limit applies at the band edges.
- (3) Emission level (dBuV/m)=20log Emission level (uV/m).
- (4) The test result calculated as following:

Measurement Value = Reading Level + Correct Factor

Correct Factor = Antenna Factor + Cable Loss - Amplifier Gain(if use)

Margin Level = Measurement Value - Limit Value

Calculation example:

Reading Level (dBuV)		Correct Factor (dB)		Measurement Value (dBuV/m)
19.11	+	2.11	=	21.22

Measurement Value (dBuV/m)		Limit Value (dBuV/m)		Margin Level (dB)
21.22	-	54	=	-32.78

Spectrum Parameter	Setting
Attenuation	Auto
Start Frequency	1000 MHz
Stop Frequency	10th carrier harmonic
RBW / VBW (Emission in restricted band)	1MHz / 3MHz for Peak, 1MHz / 1/T for Average

Spectrum Parameter	Setting
Attenuation	Auto
Start ~ Stop Frequency	9KHz~90KHz for PK/AVG detector
Start ~ Stop Frequency	90KHz~110KHz for QP detector
Start ~ Stop Frequency	110KHz~490KHz for PK/AVG detector
Start ~ Stop Frequency	490KHz~30MHz for QP detector
Start ~ Stop Frequency	30MHz~1000MHz for QP detector

4.2 TEST PROCEDURE

- a. The measuring distance of 3 m shall be used for measurements. The EUT was placed on the top of a rotating table 0.8 meter above the ground at a 3 meter semi-anechoic chamber. The table was rotated 360 degrees to determine the position of the highest radiation.(below 1GHz)
- b. The measuring distance of 3 m shall be used for measurements. The EUT was placed on the top of a rotating table 1.5 meter above the ground at a 3 meter semi-anechoic chamber. The table was rotated 360 degrees to determine the position of the highest radiation.(above 1GHz)
- c. The height of the equipment or of the substitution antenna shall be 0.8 m or 1.5 m, the height of the test antenna shall vary between 1 m to 4 m. Both horizontal and vertical polarizations of the antenna are set to make the measurement.
- d. For each suspected emission, the EUT was arranged to its worst case and then the antenna was tuned to heights find the maximum reading (used Bore sight function).
- e. The receiver system was set to peak and average detect function and specified bandwidth with maximum hold mode when the test frequency is above 1GHz.
- f. The initial step in collecting radiated emission data is a receiver peak detector mode pre-scanning the measurement frequency range. Significant peaks are then marked and then Quasi Peak detector mode re-measured.
- g. All readings are Peak unless otherwise stated QP in column of Note. Peak denotes that the Peak reading complies with the QP Limits and then QP Mode measurement didn't perform. (below 1GHz)
- h. All readings are Peak Mode value unless otherwise stated AVG in column of Note. If the Peak Mode Measured value complies with the Peak Limits and lower than AVG Limits, the EUT shall be deemed to meet both Peak & AVG Limits and then only Peak Mode was measured, but AVG Mode didn't perform. (above 1GHz)
- i. For the actual test configuration, please refer to the related Item – EUT TEST PHOTO.

4.3 DEVIATION FROM TEST STANDARD

No deviation.

4.4 TEST SETUP

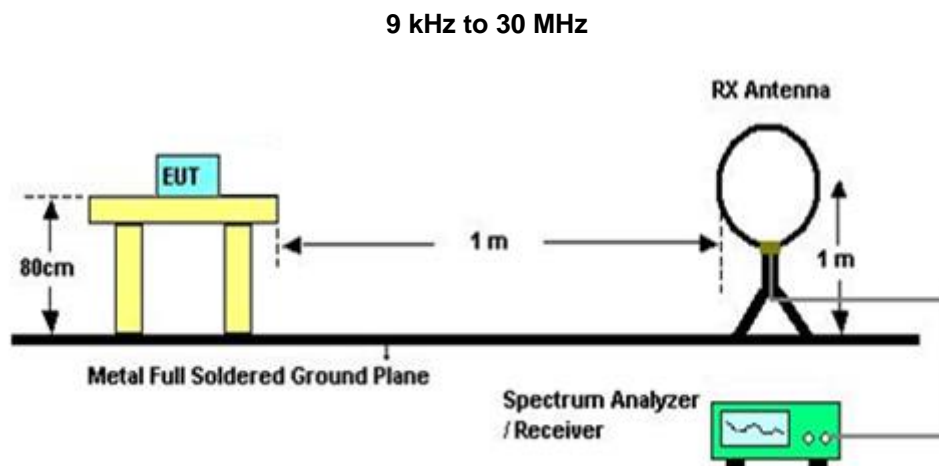

30 MHz to 1 GHz

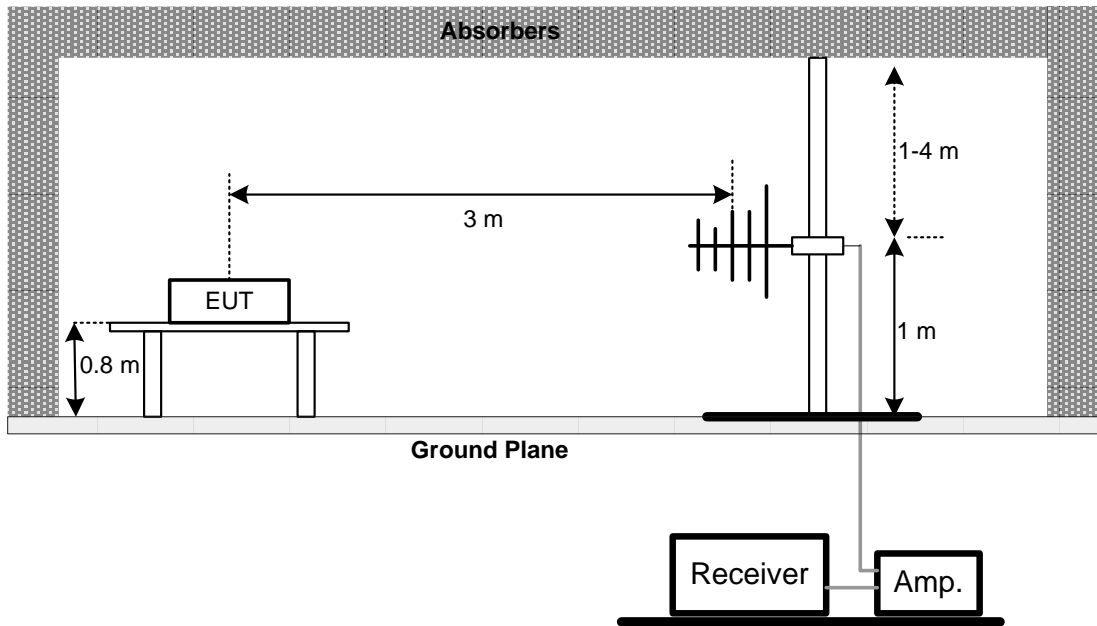

Above 1 GHz

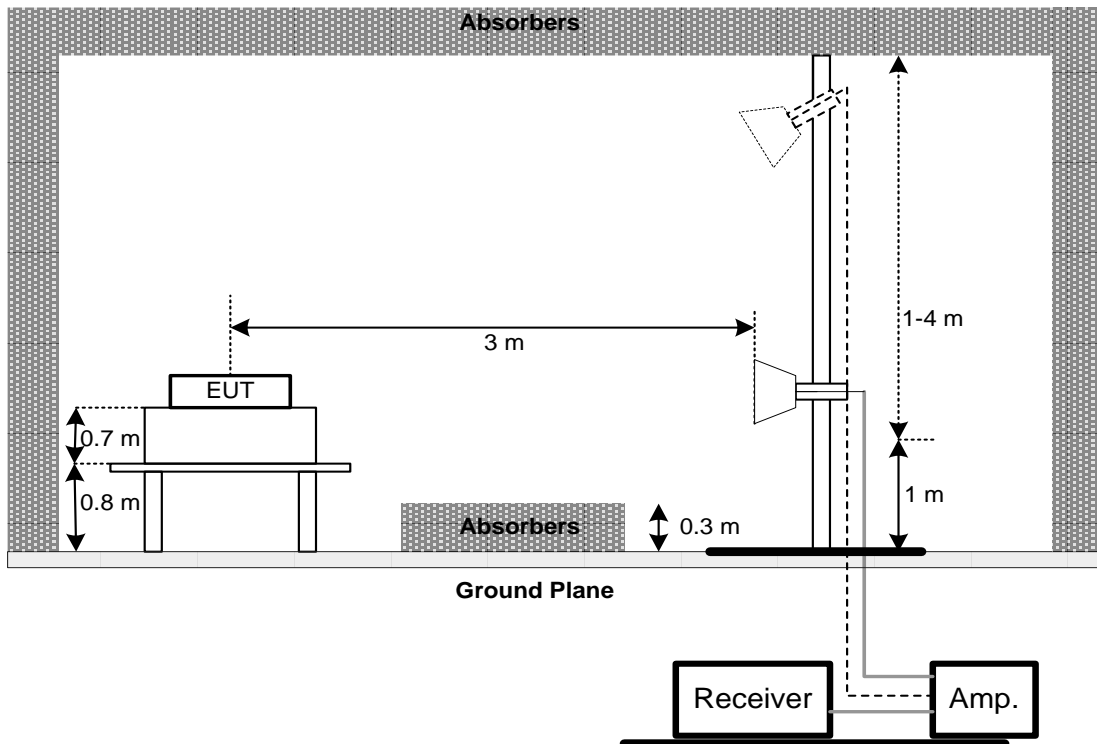

4.5 EUT OPERATING CONDITIONS

The EUT was programmed to be in continuously transmitting mode.

4.6 TEST RESULT – BELOW 30 MHZ

Please refer to the APPENDIX B.

4.7 TEST RESULT – 30 MHZ TO 1 GHZ

Please refer to the APPENDIX C.

4.8 TEST RESULT – ABOVE 1 GHZ

Please refer to the APPENDIX D.

NOTE:

- (1) No limit: This is fundamental signal, the judgment is not applicable.
For fundamental signal judgment was referred to Peak output test.

5 NUMBER OF HOPPING CHANNEL

5.1 APPLIED PROCEDURES

Section	Test Item	Frequency Range (MHz)	Result
15.247(a)(1)(iii)	Number of Hopping Channel	2400-2483.5	PASS

Spectrum Parameters	Setting
Attenuation	Auto
Span Frequency	> Operating Frequency Range
RBW	100 KHz
VBW	100 KHz
Detector	Peak
Trace	Max Hold
Sweep Time	Auto

5.2 TEST PROCEDURE

- a. The EUT was directly connected to the spectrum analyzer and antenna output port as show in the block diagram below,
- b. Spectrum Setting: RBW=100KHz, VBW=100KHz, Sweep time = Auto.

5.3 DEVIATION FROM STANDARD

No deviation.

5.4 TEST SETUP



5.5 EUT OPERATION CONDITIONS

The EUT tested system was configured as the statements of 3.5 unless otherwise a special operating condition is specified in the follows during the testing.

5.6 TEST RESULTS

Please refer to the APPENDIX E.

6 AVERAGE TIME OF OCCUPANCY

6.1 APPLIED PROCEDURES / LIMIT

Section	Test Item	Limit	Frequency Range (MHz)	Result
15.247(a)(1)(iii)	Average Time of Occupancy	0.4sec	2400-2483.5	PASS

6.2 TEST PROCEDURE

- a. The transmitter output (antenna port) was connected to the spectrum analyzer
- b. Set RBW of spectrum analyzer to 1MHz and VBW to 1MHz.
- c. Use a video trigger with the trigger level set to enable triggering only on full pulses.
- d. Sweep Time is more than once pulse time.
- e. Set the center frequency on any frequency would be measure and set the frequency span to zero span.
- f. Measure the maximum time duration of one single pulse.
- g. Set the EUT for DH5, DH3 and DH1 packet transmitting.
- h. Measure the maximum time duration of one single pulse.
- i. Measure the maximum time duration of one single pulse.
A Period Time = (channel number)*0.4

For Normal Mode (79 Channel):

DH1 Time Solt: Reading * (1600/2)*31.6/(channel number)

DH3 Time Solt: Reading * (1600/2)*31.6/(channel number)

DH5 Time Solt: Reading * (1600/2)*31.6/(channel number)

For AFH Mode (20 Channel):

DH1 Time Solt: Reading * (1600/2)*8/(channel number)

DH3 Time Solt: Reading * (1600/4)*8/(channel number)

DH5 Time Solt: Reading * (1600/6)*8/(channel number)

6.3 DEVIATION FROM STANDARD

No deviation.

6.4 TEST SETUP



6.5 EUT OPERATION CONDITIONS

The EUT tested system was configured as the statements of 3.5 unless otherwise a special operating condition is specified in the follows during the testing.

6.6 TEST RESULTS

Please refer to the APPENDIX F.

7 Hopping Channel Separation Measurement

7.1 APPLIED PROCEDURES / LIMIT

Frequency hopping systems operating in the 2400-2483.5 MHz band may have hopping channel carrier frequencies that are separated by 25 KHz or two-thirds of the 20 dB bandwidth of the hopping channel, whichever is greater.

Spectrum Parameter	Setting
Attenuation	Auto
Span Frequency	> Measurement Bandwidth or Channel Separation
RBW	30 KHz
VBW	100 KHz
Detector	Peak
Trace	Max Hold
Sweep Time	Auto

7.2 TEST PROCEDURE

- a. The EUT must have its hopping function enabled
- b. Span = wide enough to capture the peaks of two adjacent channels
 Resolution (or IF) Bandwidth (RBW) \geq 1% of the span
 Video (or Average) Bandwidth (VBW) \geq RBW
 Sweep = Auto
 Detector function = Peak
 Trace = Max Hold

7.3 DEVIATION FROM STANDARD

No deviation.

7.4 TEST SETUP

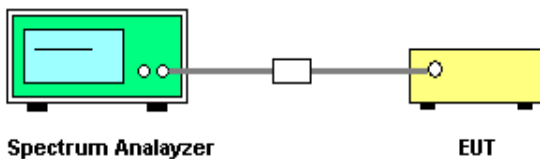

7.5 TEST RESULTS

Please refer to the APPENDIX G.

8 BANDWIDTH TEST

8.1 APPLIED PROCEDURES

Section	Test Item	Frequency Range (MHz)
15.247(a)(1)	Bandwidth	2400-2483.5

Spectrum Parameter	Setting
Attenuation	Auto
Span Frequency	> Measurement Bandwidth or Channel Separation
RBW	30 KHz (20dB Bandwidth) / 30 KHz (Channel Separation)
VBW	100 KHz (20dB Bandwidth) / 100 KHz (Channel Separation)
Detector	Peak
Trace	Max Hold
Sweep Time	Auto

8.2 TEST PROCEDURE

- a. The EUT was directly connected to the spectrum analyzer and antenna output port as show in the block diagram below,
- b. Spectrum Setting: RBW= 30KHz, VBW=100KHz, Sweep Time = Auto.

8.3 DEVIATION FROM STANDARD

No deviation.

8.4 TEST SETUP

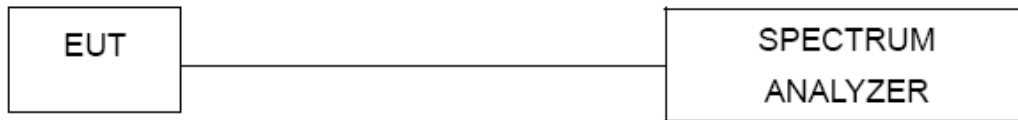

8.5 EUT OPERATION CONDITIONS

The EUT tested system was configured as the statements of 3.5 unless otherwise a special operating condition is specified in the follows during the testing.

8.6 TEST RESULTS

Please refer to the APPENDIX H.

9 OUTPUT POWER TEST

9.1 LIMIT

Section	Test Item	Limit	Frequency Range (MHz)	Result
15.247(b)(1)	Maximum peak conducted output power	0.125 Watts (20.97 dBm)	2400-2483.5	PASS

9.2 TEST PROCEDURE

- a. The EUT was directly connected to the Peak Power Analyzer and antenna output port as show in the block diagram below.
- b. Spectrum Setting: RBW= 1/3MHz, VBW= 1/3MHz, Sweep time = Auto.

9.3 DEVIATION FROM STANDARD

No deviation.

9.4 TEST SETUP

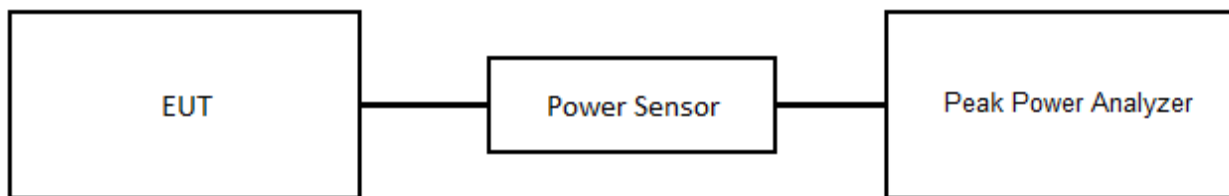

9.5 EUT OPERATION CONDITIONS

The EUT was programmed to be in continuously transmitting mode.

9.6 TEST RESULTS

Please refer to the APPENDIX I.

10 ANTENNA CONDUCTED SPURIOUS EMISSION

10.1 APPLIED PROCEDURES / LIMIT

In any 100 kHz bandwidth outside the frequency band in which the spread spectrum or digitally modulated device is operating, the RF power that is produced shall be at least 20 dB below that in the 100 kHz bandwidth within the band that contains the highest level of the desired power, based on either an RF conducted or a radiated measurement, provided that the transmitter demonstrates compliance with the peak conducted power limits.

10.2 TEST PROCEDURE

- a. The EUT was directly connected to the spectrum analyzer and antenna output port as show in the block diagram below,
- b. Spectrum Setting: RBW= 100KHz, VBW=100KHz, Sweep time = Auto.
- c. Offset=antenna gain+cable loss

10.3 DEVIATION FROM STANDARD

No deviation.

10.4 TEST SETUP

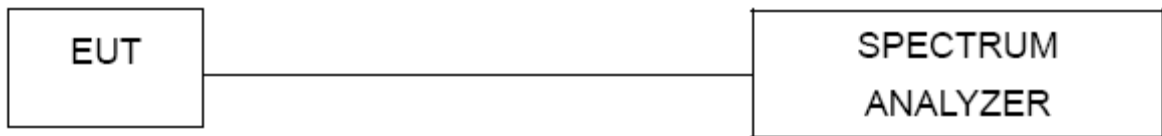

10.5 EUT OPERATION CONDITIONS

The EUT tested system was configured as the statements of 3.5 unless otherwise a special operating condition is specified in the follows during the testing.

10.6 TEST RESULTS

Please refer to the APPENDIX J.

11 LIST OF MEASURING EQUIPMENTS

AC Power Line Conducted Emissions						
Item	Kind of Equipment	Manufacturer	Type No.	Serial No.	Calibrated Date	Calibrated Until
1	TWO-LINE V-NETWORK	R&S	ENV216	101521	2023/9/13	2024/9/12
2	Test Cable	EMCI	EMCCFD300-BM-BMR-5000	220331	2023/3/30	2024/3/29
3	EMI Test Receiver	R&S	ESR 7	101433	2023/11/10	2024/11/9
4	Measurement Software	EZ	EZ_EMG (Version NB-03A1-01)	N/A	N/A	N/A

Radiated Emissions						
Item	Kind of Equipment	Manufacturer	Type No.	Serial No.	Calibrated Date	Calibrated Until
1	Preamplifier	EMCI	EMC330N	980850	2023/9/6	2024/9/5
2	Preamplifier	EMCI	EMC118A45SE	980819	2023/3/7	2024/3/6
3	Pre-Amplifier	EMCI	EMC184045SE	980907	2023/9/21	2024/9/20
4	Preamplifier	EMCI	EMC001340	980579	2023/9/6	2024/9/5
5	Test Cable	EMCI	EMC104-SM-1000	180809	2023/7/10	2024/7/9
6	Test Cable	EMCI	EMC104-SM-SM-3000	220322	2023/3/14	2024/3/13
7	Test Cable	EMCI	EMC104-SM-SM-7000	220324	2023/3/14	2024/3/13
8	EXA Signal Analyzer	keysight	N9020B	MY57120120	2023/2/24	2024/2/23
9	Loop Ant	Electro-Metrics	EMCI-LPA600	291	2023/9/12	2024/9/11
10	Horn Antenna	RFSPIN	DRH18-E	211202A18EN	2023/5/12	2024/5/11
11	Horn Ant	Schwarzbeck	BBHA 9170D	1136	2023/5/12	2024/5/11
12	Log-bicon Antenna	Schwarzbeck	VULB9168	1369	2023/5/9	2024/5/8
13	6dB Attenuator	EMCI	EMCI-N-6-06	AT-06001	2023/5/9	2024/5/8
14	Test Cable	EMCI	EMC101G-KM-KM-3000	220329	2023/3/14	2024/3/13
15	Test Cable	EMCI	EMC102-KM-KM-1000	220327	2023/3/14	2024/3/13
16	Measurement Software	EZ	EZ_EMG (Version NB-03A1-01)	N/A	N/A	N/A

Number of Hopping Frequency						
Item	Kind of Equipment	Manufacturer	Type No.	Serial No.	Calibrated Date	Calibrated Until
1	Spectrum Analyzer	R&S	FSP 40	101139	2023/3/9	2024/3/8

Average Time of Occupancy						
Item	Kind of Equipment	Manufacturer	Type No.	Serial No.	Calibrated Date	Calibrated Until
1	Spectrum Analyzer	R&S	FSP 40	101139	2023/3/9	2024/3/8

Hopping Channel Separation						
Item	Kind of Equipment	Manufacturer	Type No.	Serial No.	Calibrated Date	Calibrated Until
1	Spectrum Analyzer	R&S	FSP 40	101139	2023/3/9	2024/3/8

Bandwidth						
Item	Kind of Equipment	Manufacturer	Type No.	Serial No.	Calibrated Date	Calibrated Until
1	Spectrum Analyzer	R&S	FSP 40	101139	2023/3/9	2024/3/8

Output Power						
Item	Kind of Equipment	Manufacturer	Type No.	Serial No.	Calibrated Date	Calibrated Until
1	Peak Power Analyzer	Keysight	8990B	MY51000517	2023/3/15	2024/3/14
2	Power Sensor	Keysight	N1923A	MY58310005	2023/3/15	2024/3/14

Antenna conducted Spurious Emission						
Item	Kind of Equipment	Manufacturer	Type No.	Serial No.	Calibrated Date	Calibrated Until
1	Spectrum Analyzer	R&S	FSP 40	101139	2023/3/9	2024/3/8

Remark: "N/A" denotes no model name, no serial no. or no calibration specified.
 All calibration period of equipment list is one year.

12 EUT TEST PHOTO

Please refer to document Appendix No.: TP-2311T124-FCCP-1 (APPENDIX-TEST PHOTOS).

13 EUT PHOTOS

Please refer to document Appendix No.: EP-2311T124-1 (APPENDIX-EUT PHOTOS).

APPENDIX A AC POWER LINE CONDUCTED EMISSIONS

Test Mode	Normal	Tested Date	2023/12/15
Test Frequency	-	Phase	Line

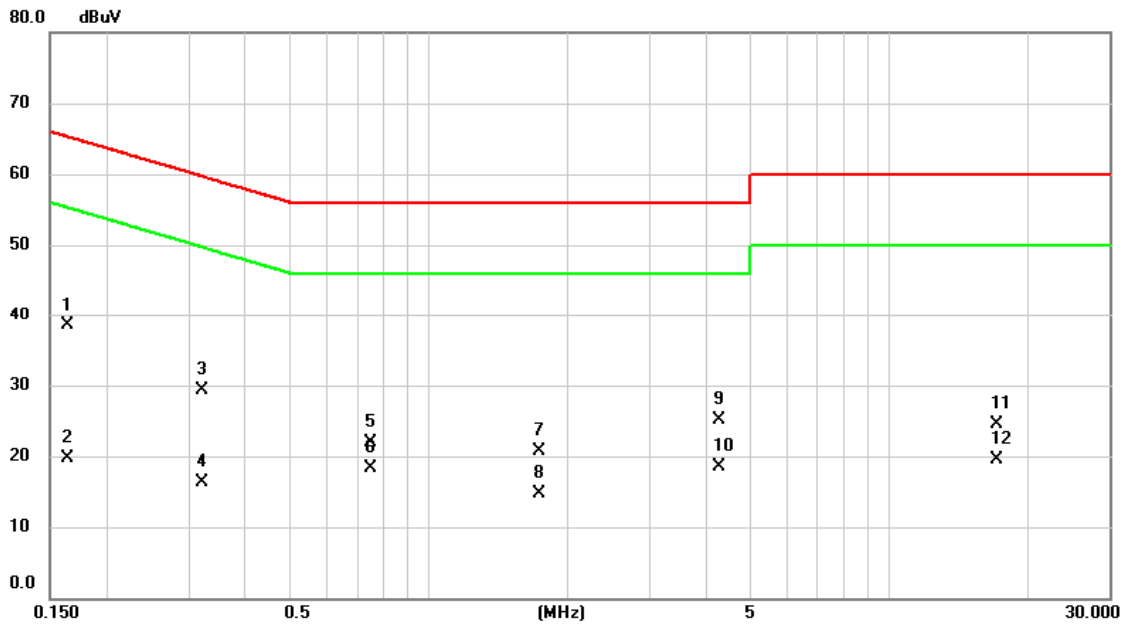

No.	Mk.	Freq. MHz	Reading Level dBuV	Correct Factor dB	Measure- ment dBuV	Limit dBuV	Margin dB	Detector	Comment
1	*	0.1635	28.94	9.60	38.54	65.28	-26.74	QP	
2		0.1635	10.18	9.60	19.78	55.28	-35.50	AVG	
3		0.3210	19.63	9.58	29.21	59.68	-30.47	QP	
4		0.3210	6.68	9.58	16.26	49.68	-33.42	AVG	
5		0.7462	12.40	9.59	21.99	56.00	-34.01	QP	
6		0.7462	8.72	9.59	18.31	46.00	-27.69	AVG	
7		1.7295	10.99	9.63	20.62	56.00	-35.38	QP	
8		1.7295	4.99	9.63	14.62	46.00	-31.38	AVG	
9		4.2585	15.50	9.64	25.14	56.00	-30.86	QP	
10		4.2585	8.85	9.64	18.49	46.00	-27.51	AVG	
11		17.0812	14.75	9.71	24.46	60.00	-35.54	QP	
12		17.0812	9.75	9.71	19.46	50.00	-30.54	AVG	

REMARKS:

- (1) Measurement Value = Reading Level + Correct Factor.
- (2) Margin Level = Measurement Value - Limit Value.

Test Mode	Normal	Tested Date	2023/12/15
Test Frequency	-	Phase	Neutral

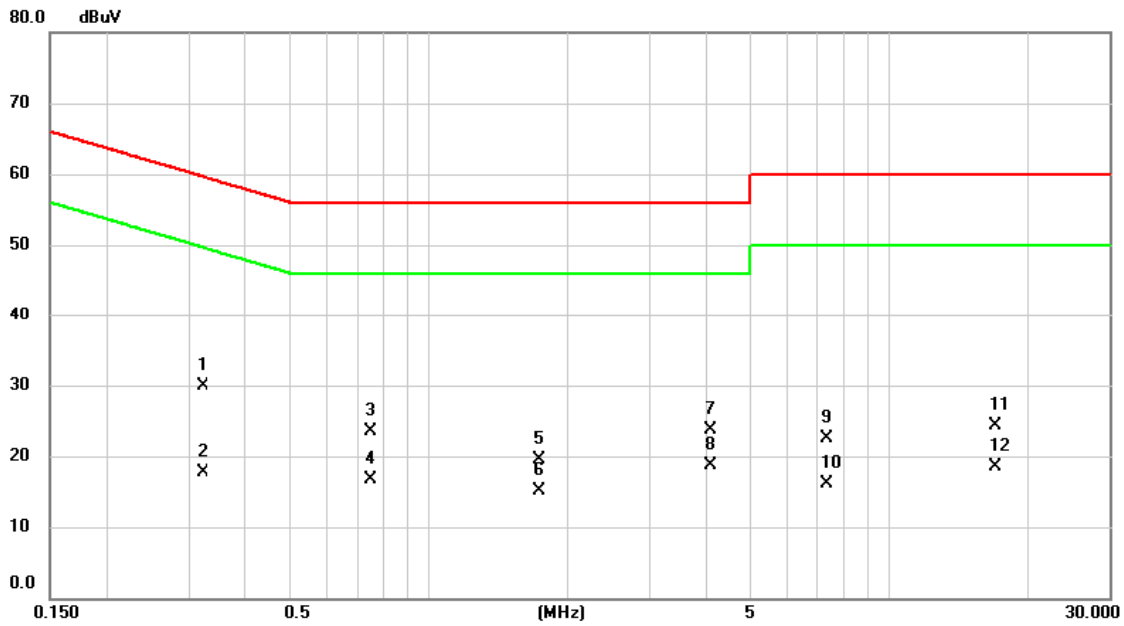

No.	Mk.	Freq. MHz	Reading Level dBuV	Correct Factor dB	Measure- ment dBuV	Limit dBuV	Margin dB	Detector	Comment
1		0.3232	20.32	9.57	29.89	59.62	-29.73	QP	
2		0.3232	8.14	9.57	17.71	49.62	-31.91	AVG	
3		0.7462	13.96	9.58	23.54	56.00	-32.46	QP	
4		0.7462	7.06	9.58	16.64	46.00	-29.36	AVG	
5		1.7340	9.85	9.62	19.47	56.00	-36.53	QP	
6		1.7340	5.48	9.62	15.10	46.00	-30.90	AVG	
7		4.0896	14.06	9.63	23.69	56.00	-32.31	QP	
8	*	4.0896	9.05	9.63	18.68	46.00	-27.32	AVG	
9		7.3387	12.90	9.69	22.59	60.00	-37.41	QP	
10		7.3387	6.49	9.69	16.18	50.00	-33.82	AVG	
11		17.0002	14.45	9.80	24.25	60.00	-35.75	QP	
12		17.0002	8.66	9.80	18.46	50.00	-31.54	AVG	

REMARKS:

(1) Measurement Value = Reading Level + Correct Factor.

(2) Margin Level = Measurement Value - Limit Value.

Test Mode	Idle	Tested Date	2023/12/15
Test Frequency	-	Phase	Line

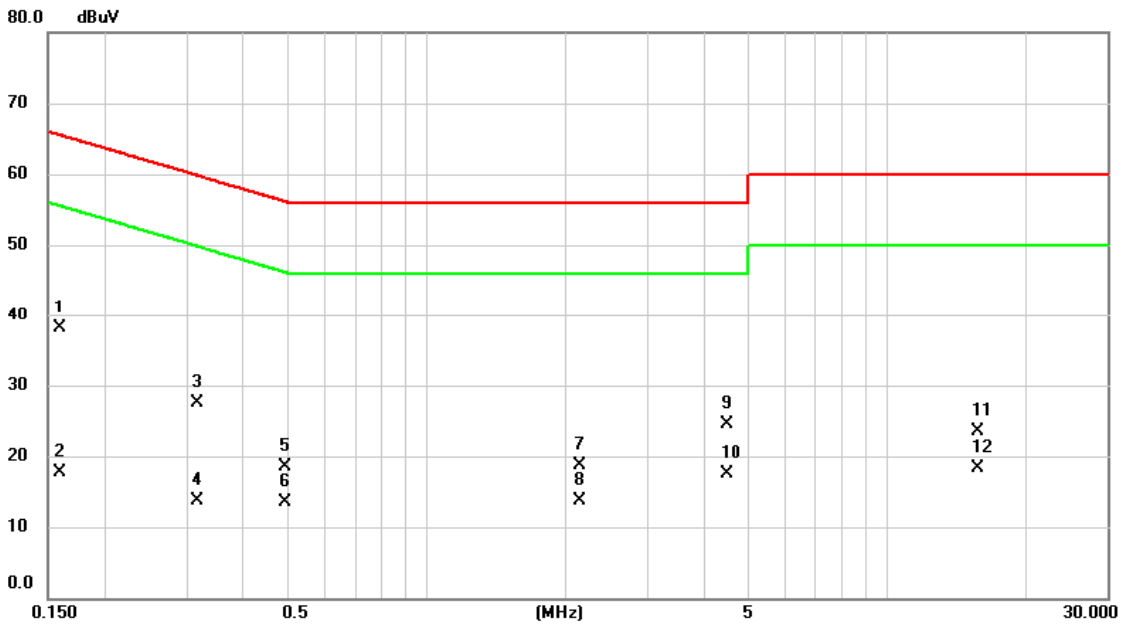

No.	Mk.	Freq. MHz	Reading Level dBuV	Correct Factor dB	Measure- ment dBuV	Limit dBuV	Margin dB	Detector	Comment
1	*	0.1590	28.56	9.60	38.16	65.52	-27.36	QP	
2		0.1590	8.05	9.60	17.65	55.52	-37.87	AVG	
3		0.3164	17.95	9.58	27.53	59.80	-32.27	QP	
4		0.3164	4.03	9.58	13.61	49.80	-36.19	AVG	
5		0.4920	8.96	9.58	18.54	56.13	-37.59	QP	
6		0.4920	4.02	9.58	13.60	46.13	-32.53	AVG	
7		2.1435	8.96	9.65	18.61	56.00	-37.39	QP	
8		2.1435	4.10	9.65	13.75	46.00	-32.25	AVG	
9		4.4700	14.88	9.64	24.52	56.00	-31.48	QP	
10		4.4700	7.85	9.64	17.49	46.00	-28.51	AVG	
11		15.7605	13.72	9.71	23.43	60.00	-36.57	QP	
12		15.7605	8.63	9.71	18.34	50.00	-31.66	AVG	

REMARKS:

(1) Measurement Value = Reading Level + Correct Factor.

(2) Margin Level = Measurement Value - Limit Value.

Test Mode	Idle	Tested Date	2023/12/15
Test Frequency	-	Phase	Neutral

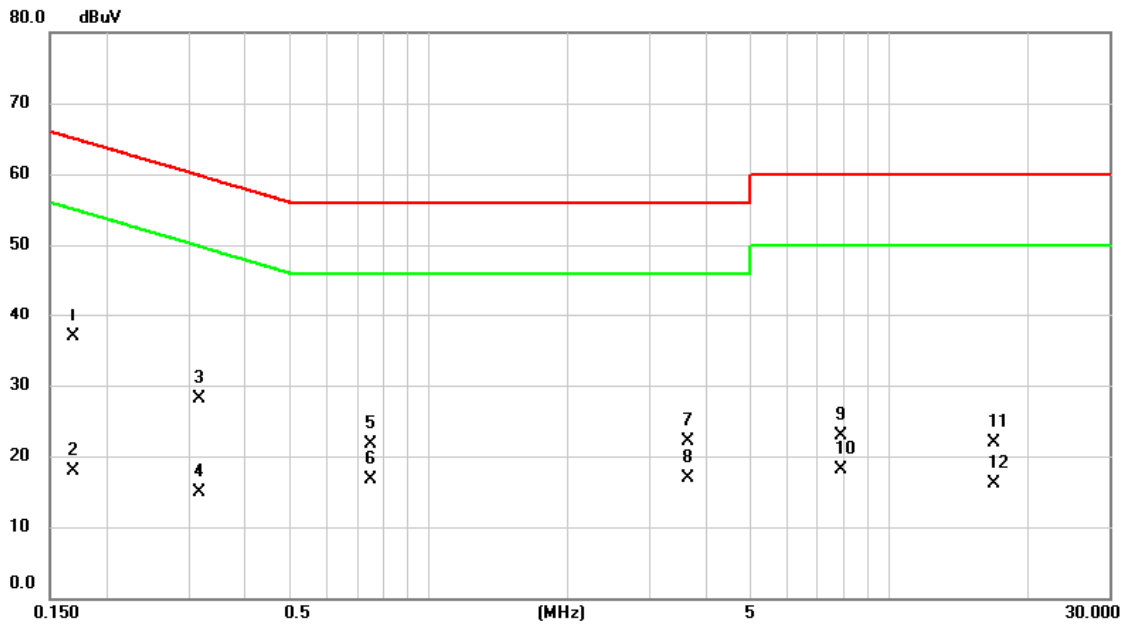

No.	Mk.	Freq. MHz	Reading Level dBuV	Correct Factor dB	Measure- ment dBuV	Limit dBuV	Margin dB	Detector	Comment
1	*	0.1680	27.38	9.59	36.97	65.06	-28.09	QP	
2		0.1680	8.33	9.59	17.92	55.06	-37.14	AVG	
3		0.3164	18.60	9.57	28.17	59.80	-31.63	QP	
4		0.3164	5.33	9.57	14.90	49.80	-34.90	AVG	
5		0.7507	12.09	9.57	21.66	56.00	-34.34	QP	
6		0.7507	7.22	9.57	16.79	46.00	-29.21	AVG	
7		3.6307	12.48	9.63	22.11	56.00	-33.89	QP	
8		3.6307	7.33	9.63	16.96	46.00	-29.04	AVG	
9		7.8742	13.17	9.70	22.87	60.00	-37.13	QP	
10		7.8742	8.45	9.70	18.15	50.00	-31.85	AVG	
11		16.9215	12.19	9.80	21.99	60.00	-38.01	QP	
12		16.9215	6.31	9.80	16.11	50.00	-33.89	AVG	

REMARKS:

- (1) Measurement Value = Reading Level + Correct Factor.
- (2) Margin Level = Measurement Value - Limit Value.

APPENDIX B RADIATED EMISSIONS - 9 KHZ TO 30 MHZ

Test Mode	BT (1 Mbps)	Test Date	2023/12/19
Test Frequency	2441MHz	Polarization	Vertical
Temp	23°C	Hum.	57%

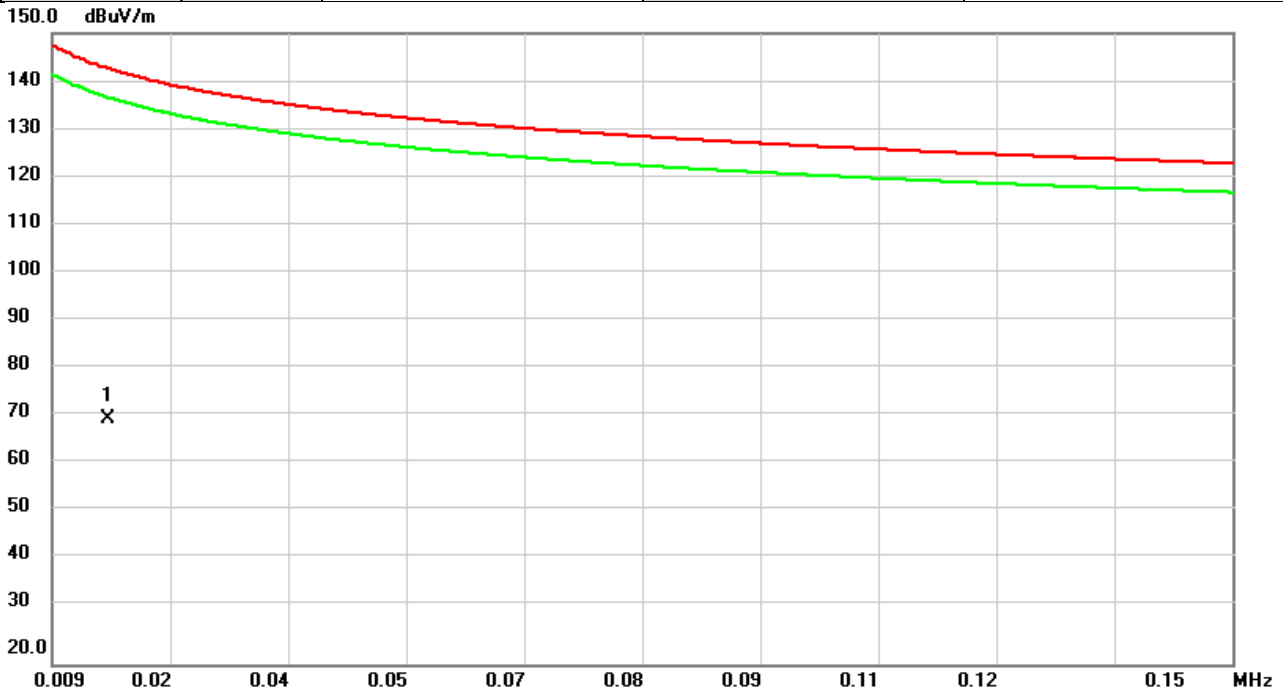

No.	Mk.	Freq.	Reading Level	Correct Factor	Measurement	Limit	Over	Detector	Comment
		MHz	dBuV	dB	dBuV/m	dBuV/m	dB		
1	*	0.0156	36.79	33.71	70.50	142.82	-72.32	AVG	

REMARKS:

- (1) Measurement Value = Reading Level + Correct Factor.
- (2) Margin Level = Measurement Value - Limit Value.

Test Mode	BT (1 Mbps)	Test Date	2023/12/19
Test Frequency	2441MHz	Polarization	Vertical
Temp	23°C	Hum.	57%

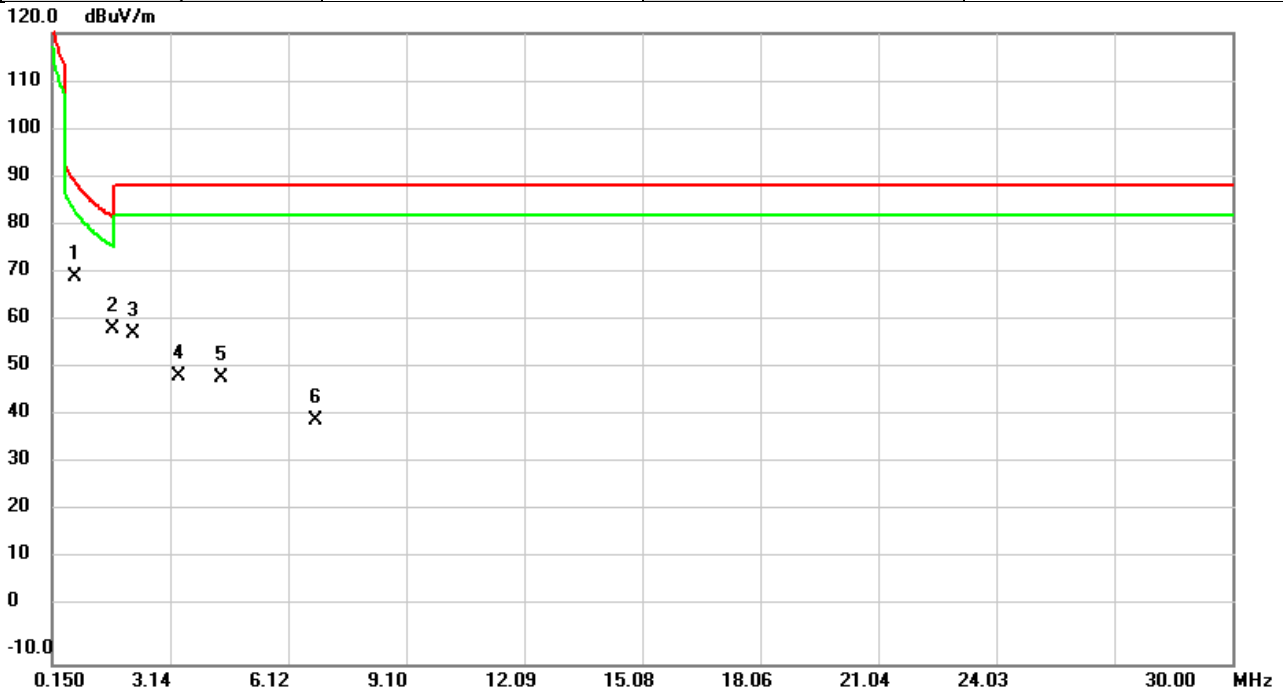

No.	Mk.	Freq.	Reading Level	Correct Factor	Measurement	Limit	Over	Detector	Comment
		MHz	dBuV	dB	dBuV/m	dBuV/m	dB		
1	*	0.7221	66.56	3.26	69.82	89.51	-19.69	QP	
2		1.6853	60.04	-0.97	59.07	82.14	-23.07	QP	
3		2.2057	60.40	-2.20	58.20	88.62	-30.42	QP	
4		3.3390	53.33	-3.90	49.43	88.62	-39.19	QP	
5		4.4155	53.29	-4.26	49.03	88.62	-39.59	QP	
6		6.8265	44.20	-4.00	40.20	88.62	-48.42	QP	

REMARKS:

- (1) Measurement Value = Reading Level + Correct Factor.
- (2) Margin Level = Measurement Value - Limit Value.

Test Mode	BT (1 Mbps)	Test Date	2023/12/19
Test Frequency	2441MHz	Polarization	Horizontal
Temp	23°C	Hum.	57%

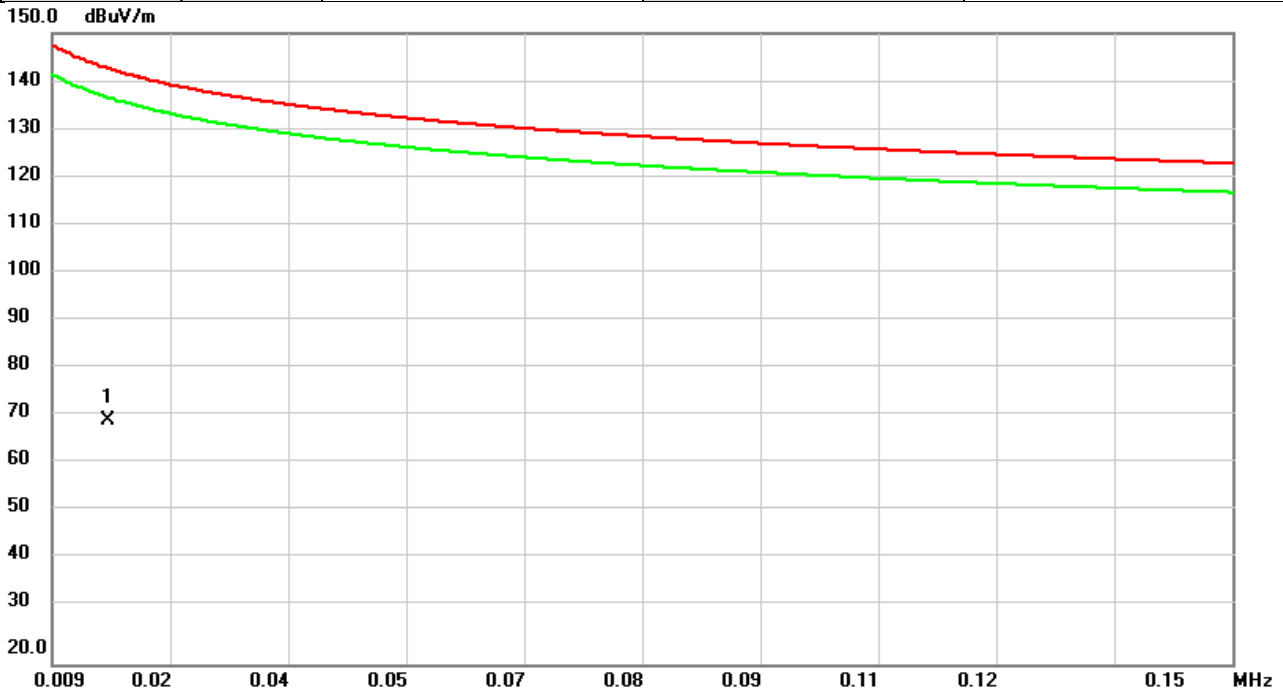

No.	Mk.	Freq.	Reading Level	Correct Factor	Measurement	Limit	Over	Detector	Comment
		MHz	dBuV	dB	dBuV/m	dBuV/m	dB		
1	*	0.0156	36.35	33.71	70.06	142.82	-72.76	AVG	

REMARKS:

- (1) Measurement Value = Reading Level + Correct Factor.
- (2) Margin Level = Measurement Value - Limit Value.

Test Mode	BT (1 Mbps)	Test Date	2023/12/19
Test Frequency	2441MHz	Polarization	Horizontal
Temp	23°C	Hum.	57%

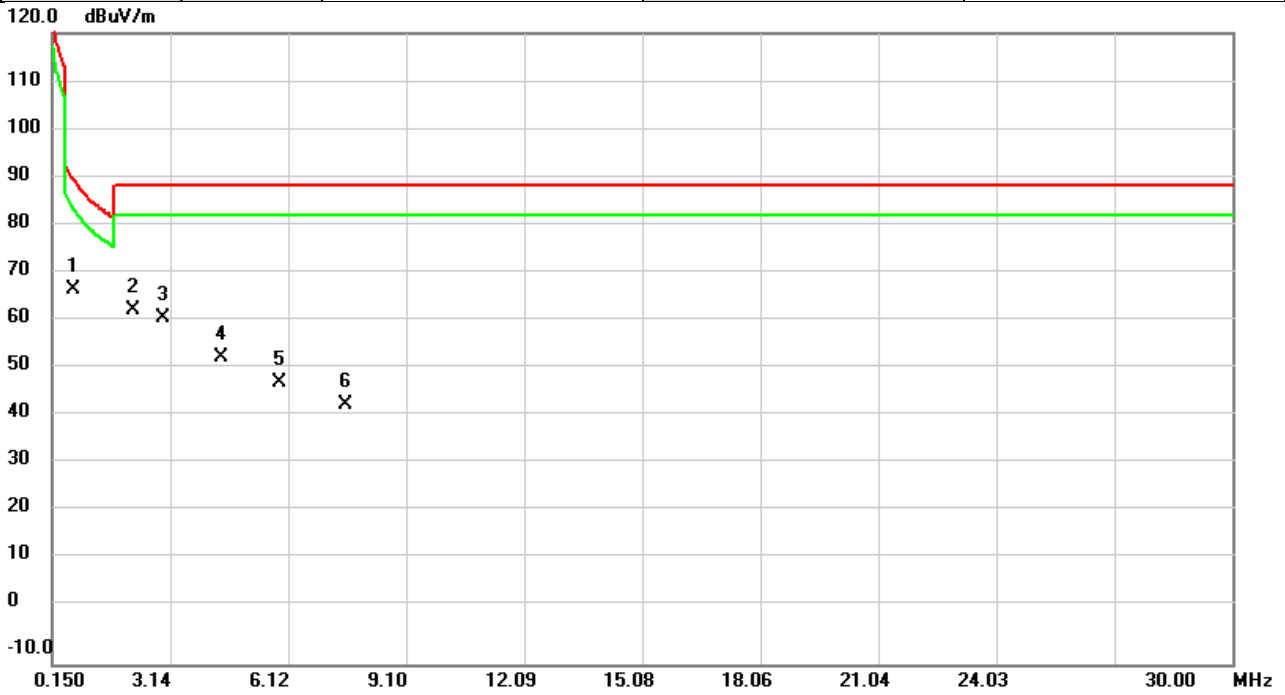

No.	Mk.	Freq.	Reading Level	Correct Factor	Measurement	Limit	Over	Detector	Comment
		MHz	dBuV	dB	dBuV/m	dBuV/m	dB		
1	*	0.6943	63.76	3.51	67.27	89.85	-22.58	QP	
2		2.2087	65.18	-2.21	62.97	88.62	-25.65	QP	
3		2.9490	65.00	-3.69	61.31	88.62	-27.31	QP	
4		4.4284	57.49	-4.27	53.22	88.62	-35.40	QP	
5		5.8950	52.13	-4.23	47.90	88.62	-40.72	QP	
6		7.5797	47.23	-3.81	43.42	88.62	-45.20	QP	

REMARKS:

- (1) Measurement Value = Reading Level + Correct Factor.
- (2) Margin Level = Measurement Value - Limit Value.

APPENDIX C RADIATED EMISSIONS - 30 MHZ TO 1 GHZ

Test Mode	BT (1 Mbps)	Test Date	2023/12/19
Test Frequency	2441MHz	Polarization	Vertical
Temp	23°C	Hum.	57%

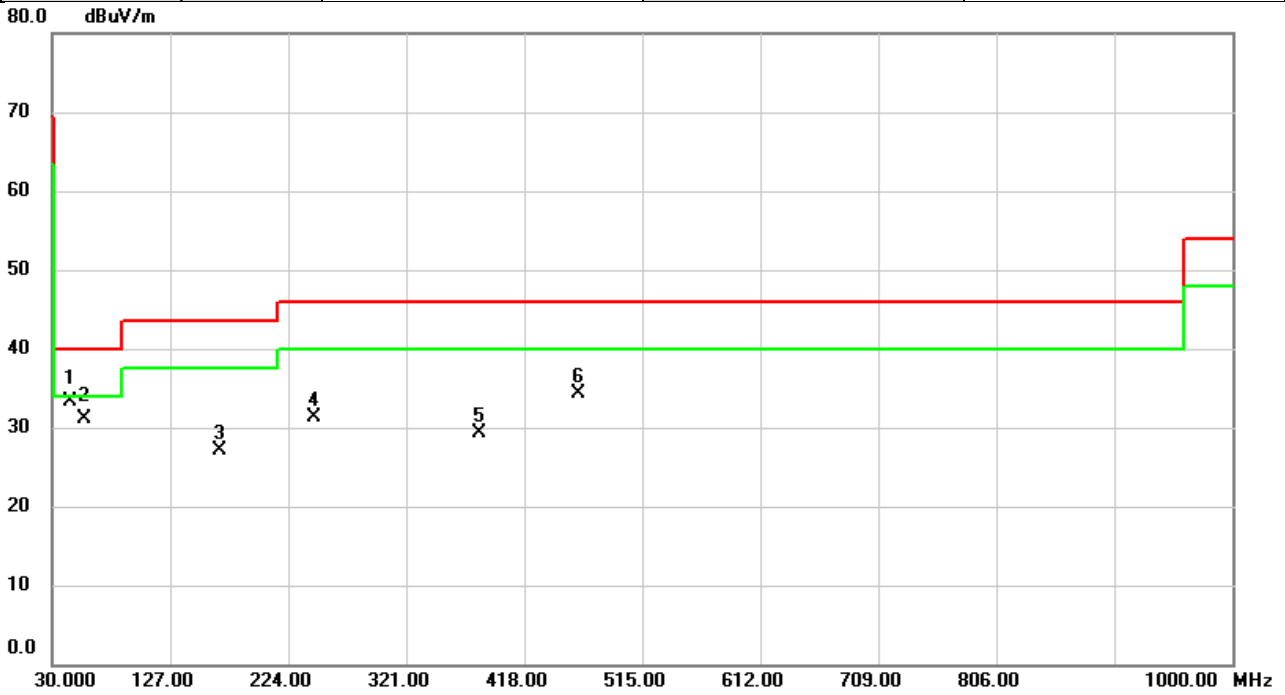

No.	Mk.	Freq. MHz	Reading Level dBuV	Correct Factor dB	Measure- ment dBuV/m	Limit dBuV/m	Over dB	Detector	Comment
1	*	44.6793	44.53	-11.16	33.37	40.00	-6.63	QP	
2		56.0283	42.54	-11.53	31.01	40.00	-8.99	QP	
3		167.9987	39.22	-12.18	27.04	43.50	-16.46	peak	
4		245.7603	44.43	-13.21	31.22	46.00	-14.78	peak	
5		380.9137	38.57	-9.20	29.37	46.00	-16.63	peak	
6		462.3613	41.29	-6.95	34.34	46.00	-11.66	peak	

REMARKS:

- (1) Measurement Value = Reading Level + Correct Factor.
- (2) Margin Level = Measurement Value - Limit Value.

Test Mode	BT (1 Mbps)	Test Date	2023/12/19
Test Frequency	2441MHz	Polarization	Horizontal
Temp	23°C	Hum.	57%

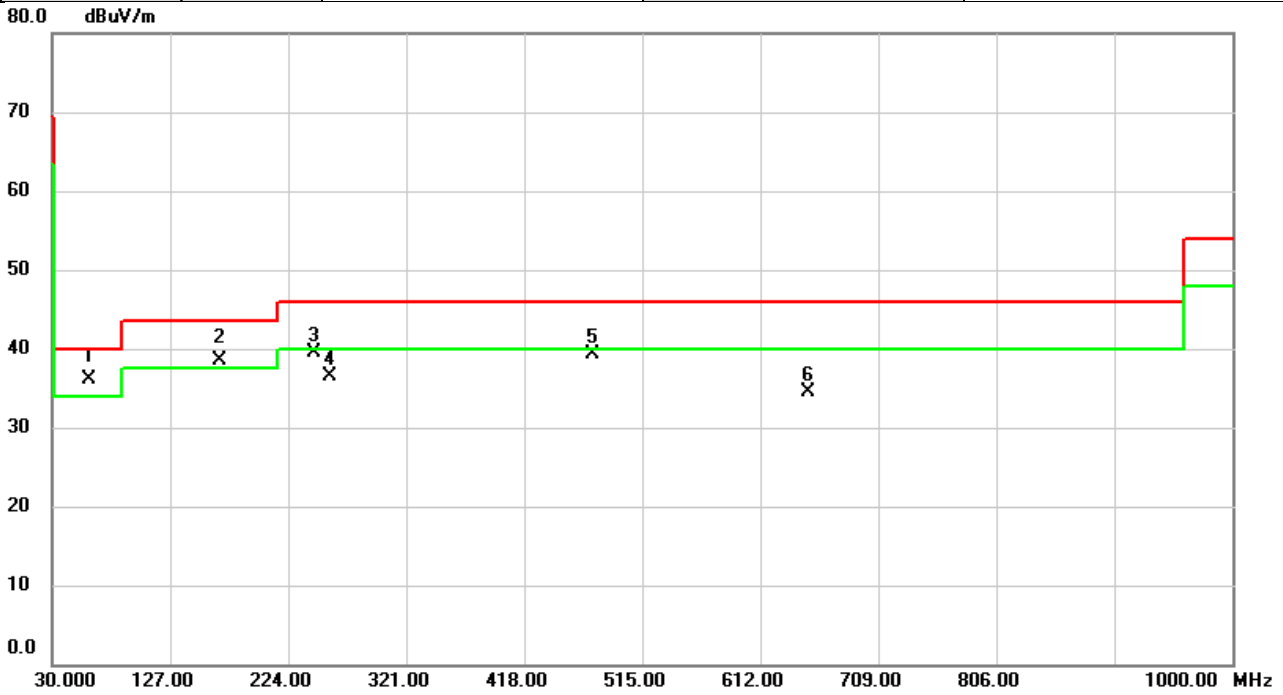

No.	Mk.	Freq.	Reading Level	Correct Factor	Measurement	Limit	Over	Detector	Comment
		MHz	dBuV	dB	dBuV/m	dBuV/m	dB		
1	*	60.0053	47.76	-11.73	36.03	40.00	-3.97	QP	
2	!	167.9987	50.77	-12.18	38.59	43.50	-4.91	QP	
3		245.7927	52.67	-13.21	39.46	46.00	-6.54	peak	
4		258.0470	49.22	-12.79	36.43	46.00	-9.57	peak	
5		474.5187	46.08	-6.75	39.33	46.00	-6.67	peak	
6		651.2527	37.59	-3.18	34.41	46.00	-11.59	peak	

REMARKS:

- (1) Measurement Value = Reading Level + Correct Factor.
- (2) Margin Level = Measurement Value - Limit Value.

APPENDIX D RADIATED EMISSIONS - ABOVE 1 GHZ

Test Mode	BT (1 Mbps)	Test Date	2023/12/19
Test Frequency	2402MHz	Polarization	Horizontal
Temp	23°C	Hum.	57%

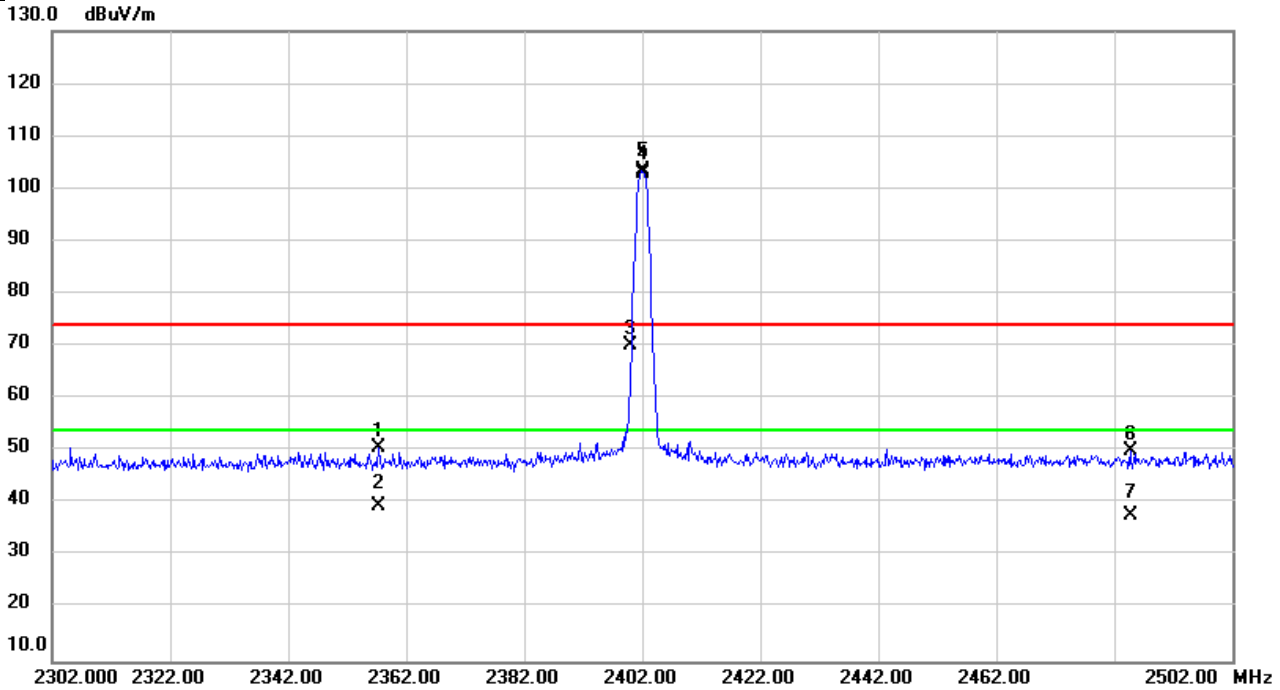

No.	Mk.	Freq.	Reading Level	Correct Factor	Measurement	Limit	Over	Detector	Comment
		MHz	dBuV	dB	dBuV/m	dBuV/m	dB		
1		2357.347	56.37	-5.63	50.74	74.00	-23.26	peak	
2		2357.347	45.09	-5.63	39.46	54.00	-14.54	AVG	
3		2400.000	75.63	-5.56	70.07	74.00	-3.93	peak	NoLimit
4	X	2402.000	109.07	-5.55	103.52	74.00	29.52	peak	NoLimit
5	*	2402.000	108.48	-5.55	102.93	54.00	48.93	AVG	NoLimit
6		2484.780	55.42	-5.40	50.02	74.00	-23.98	peak	
7		2484.780	43.22	-5.40	37.82	54.00	-16.18	AVG	

REMARKS:

- (1) Measurement Value = Reading Level + Correct Factor.
- (2) Margin Level = Measurement Value - Limit Value.

Test Mode	BT (1 Mbps)	Test Date	2023/12/19
Test Frequency	2480MHz	Polarization	Horizontal
Temp	23°C	Hum.	57%

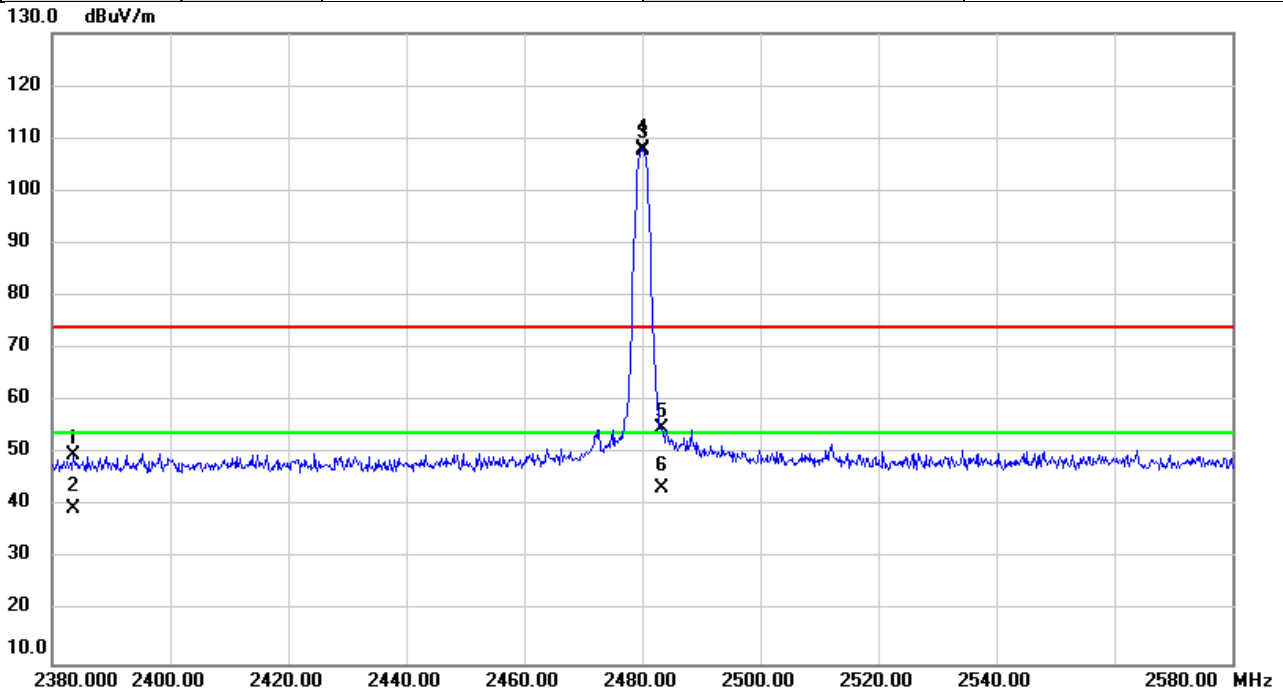

No.	Mk.	Freq.	Reading Level	Correct Factor	Measurement	Limit	Over	Detector	Comment
		MHz	dBuV	dB	dBuV/m	dBuV/m	dB		
1		2383.633	55.28	-5.58	49.70	74.00	-24.30	peak	
2		2383.633	45.10	-5.58	39.52	54.00	-14.48	AVG	
3	X	2480.000	113.44	-5.41	108.03	74.00	34.03	peak	NoLimit
4	*	2480.000	113.13	-5.41	107.72	54.00	53.72	AVG	NoLimit
5		2483.407	60.33	-5.42	54.91	74.00	-19.09	peak	
6		2483.407	48.99	-5.42	43.57	54.00	-10.43	AVG	

REMARKS:

- (1) Measurement Value = Reading Level + Correct Factor.
- (2) Margin Level = Measurement Value - Limit Value.

Test Mode	BT (3 Mbps)	Test Date	2023/12/19
Test Frequency	2402MHz	Polarization	Horizontal
Temp	23°C	Hum.	57%

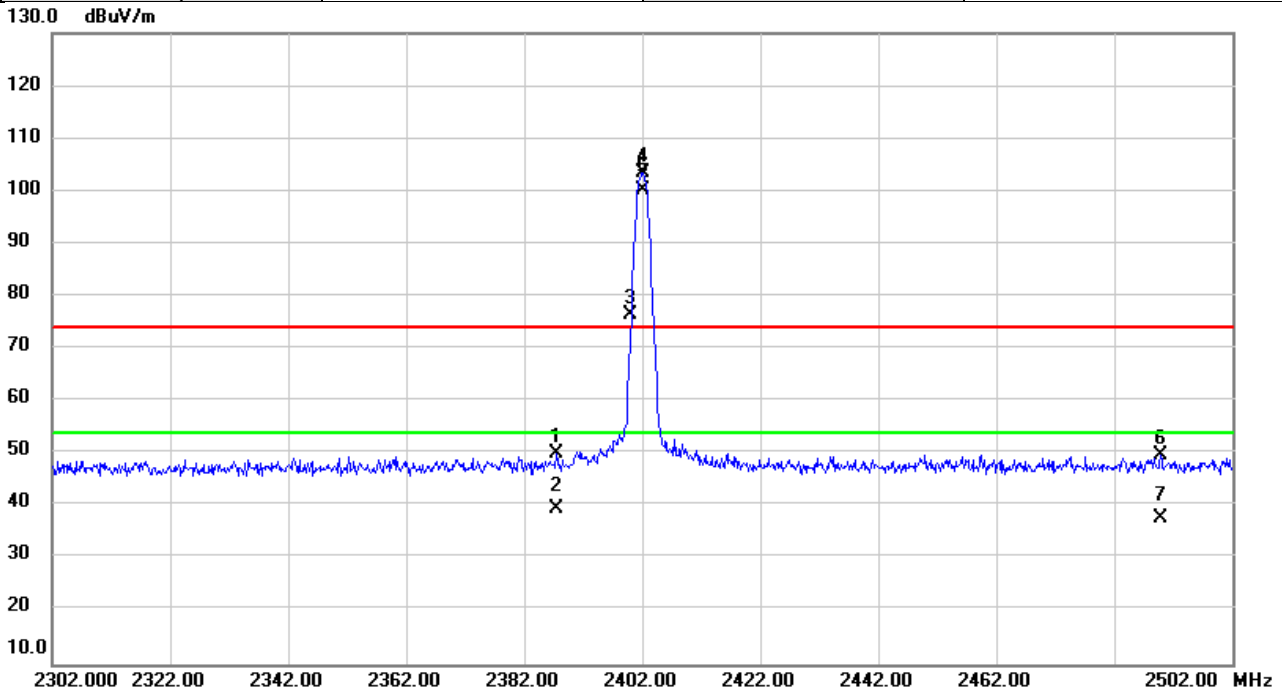

No.	Mk.	Freq.	Reading Level	Correct Factor	Measurement	Limit	Over	Detector	Comment
		MHz	dBuV	dB	dBuV/m	dBuV/m	dB		
1		2387.487	55.50	-5.58	49.92	74.00	-24.08	peak	
2		2387.487	45.13	-5.58	39.55	54.00	-14.45	AVG	
3	X	2400.000	81.94	-5.56	76.38	74.00	2.38	peak	NoLimit
4	X	2402.000	109.03	-5.55	103.48	74.00	29.48	peak	NoLimit
5	*	2402.000	105.65	-5.55	100.10	54.00	46.10	AVG	NoLimit
6		2489.920	55.09	-5.40	49.69	74.00	-24.31	peak	
7		2489.920	43.27	-5.40	37.87	54.00	-16.13	AVG	

REMARKS:

- (1) Measurement Value = Reading Level + Correct Factor.
- (2) Margin Level = Measurement Value - Limit Value.

Test Mode	BT (3 Mbps)	Test Date	2023/12/19
Test Frequency	2480MHz	Polarization	Horizontal
Temp	23°C	Hum.	57%

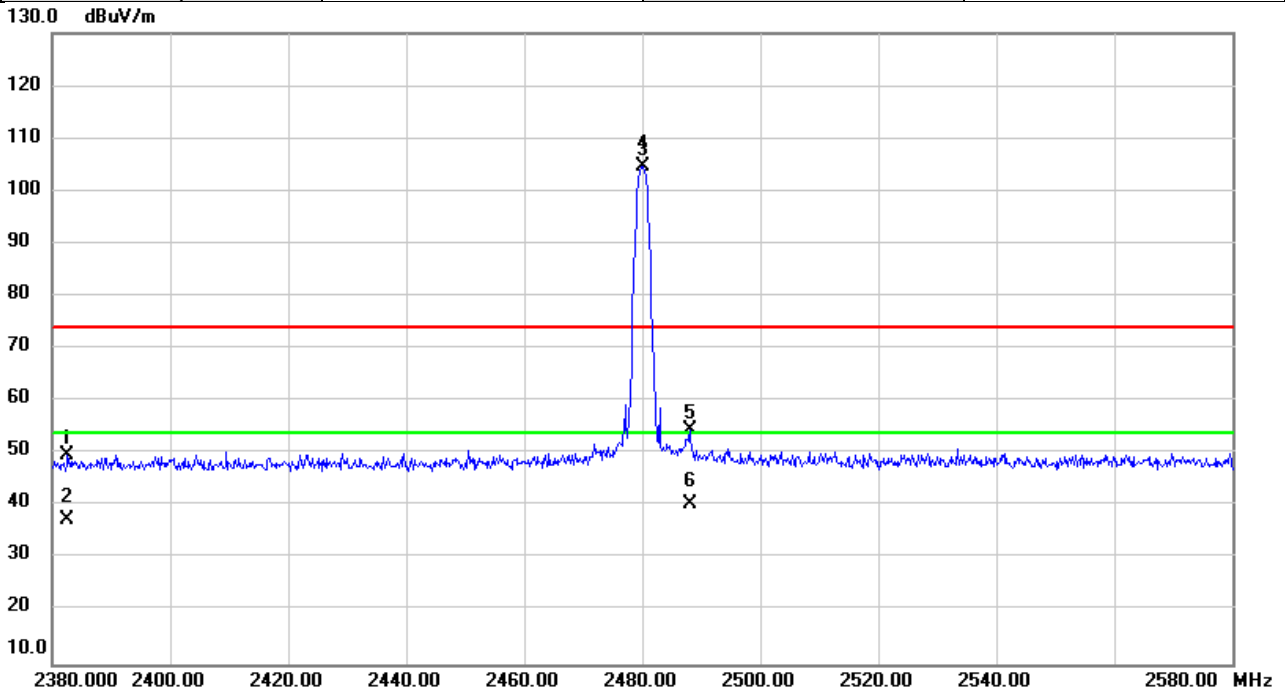

No.	Mk.	Freq.	Reading Level	Correct Factor	Measurement	Limit	Over	Detector	Comment
		MHz	dBuV	dB	dBuV/m	dBuV/m	dB		
1		2382.660	55.31	-5.58	49.73	74.00	-24.27	peak	
2		2382.660	43.03	-5.58	37.45	54.00	-16.55	AVG	
3	X	2480.000	110.08	-5.41	104.67	74.00	30.67	peak	NoLimit
4	*	2480.000	109.93	-5.41	104.52	54.00	50.52	AVG	NoLimit
5		2488.160	59.90	-5.40	54.50	74.00	-19.50	peak	
6		2488.160	45.99	-5.40	40.59	54.00	-13.41	AVG	

REMARKS:

- (1) Measurement Value = Reading Level + Correct Factor.
- (2) Margin Level = Measurement Value - Limit Value.

Test Mode	BT (1 Mbps)	Test Date	2023/12/19
Test Frequency	2402MHz	Polarization	Vertical
Temp	23°C	Hum.	57%

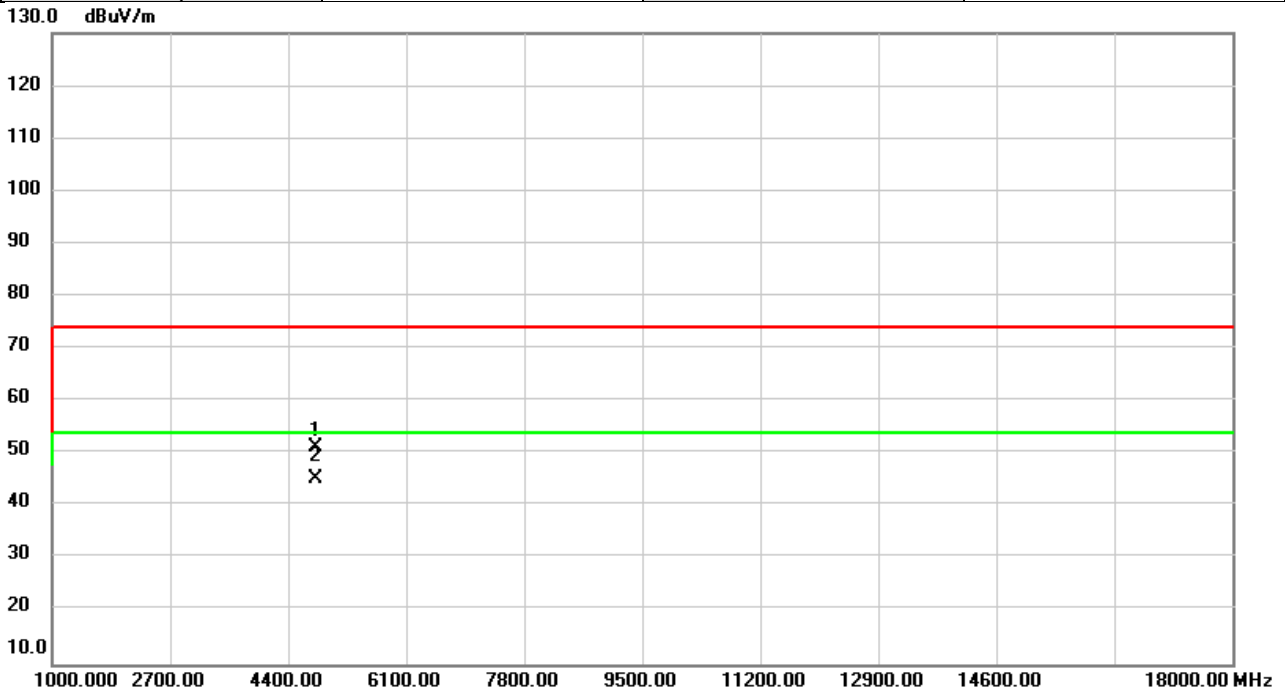

No.	Mk.	Freq. MHz	Reading Level dBuV	Correct Factor dB	Measure- ment dBuV/m	Limit dBuV/m	Over dB	Detector	Comment
1		4804.000	50.66	0.50	51.16	74.00	-22.84	peak	
2	*	4804.000	44.83	0.50	45.33	54.00	-8.67	AVG	

REMARKS:

- (1) Measurement Value = Reading Level + Correct Factor.
- (2) Margin Level = Measurement Value - Limit Value.

Test Mode	BT (1 Mbps)	Test Date	2023/12/19
Test Frequency	2402MHz	Polarization	Horizontal
Temp	23°C	Hum.	57%

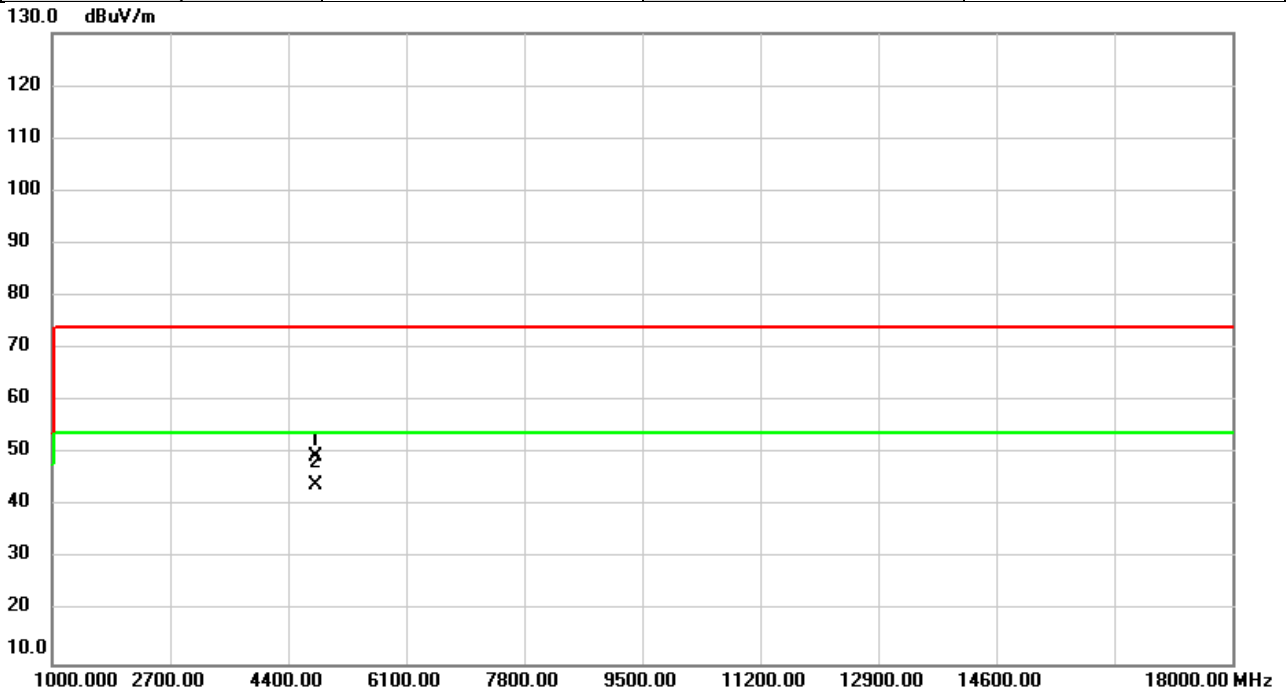

No.	Mk.	Freq. MHz	Reading Level dBuV	Correct Factor dB	Measure- ment dBuV/m	Limit dBuV/m	Over dB	Detector	Comment
1		4804.000	49.10	0.50	49.60	74.00	-24.40	peak	
2	*	4804.000	43.44	0.50	43.94	54.00	-10.06	AVG	

REMARKS:

- (1) Measurement Value = Reading Level + Correct Factor.
- (2) Margin Level = Measurement Value - Limit Value.

Test Mode	BT (1 Mbps)	Test Date	2023/12/19
Test Frequency	2441MHz	Polarization	Vertical
Temp	23°C	Hum.	57%

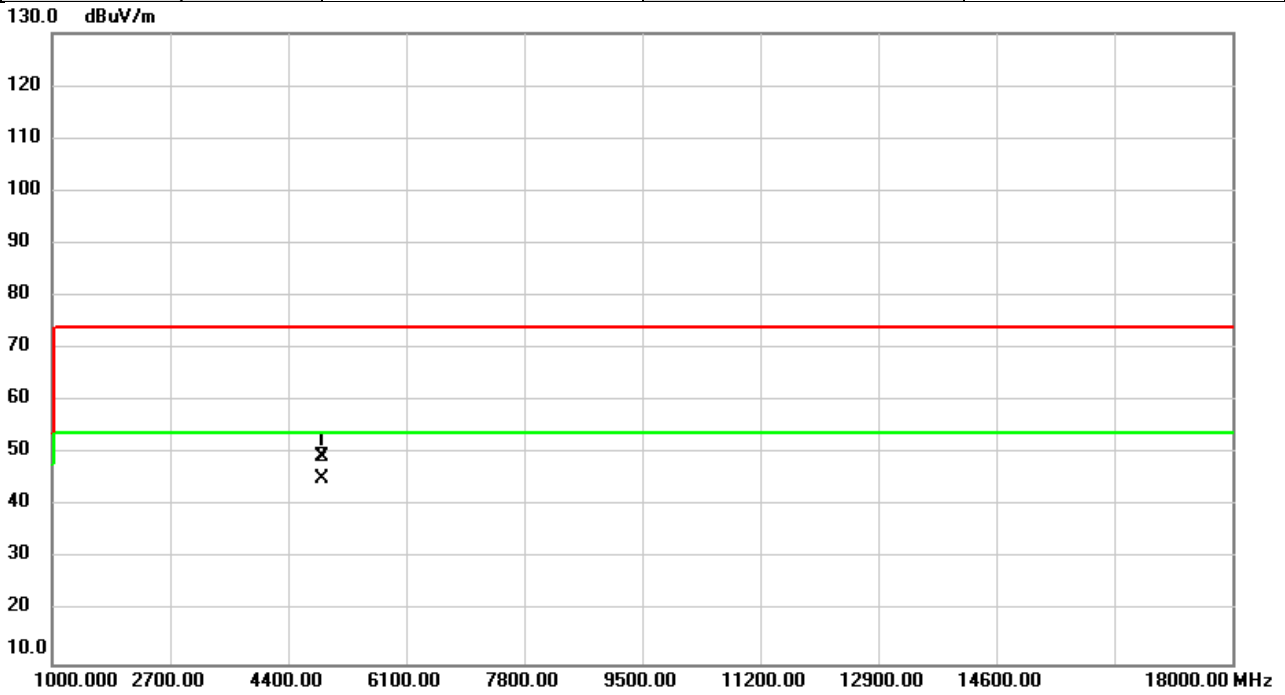

No.	Mk.	Freq. MHz	Reading Level dBuV	Correct Factor dB	Measure- ment dBuV/m	Limit dBuV/m	Over dB	Detector	Comment
1		4882.000	48.74	0.74	49.48	74.00	-24.52	peak	
2	*	4882.000	44.61	0.74	45.35	54.00	-8.65	AVG	

REMARKS:

- (1) Measurement Value = Reading Level + Correct Factor.
- (2) Margin Level = Measurement Value - Limit Value.

Test Mode	BT (1 Mbps)	Test Date	2023/12/19
Test Frequency	2441MHz	Polarization	Horizontal
Temp	23°C	Hum.	57%

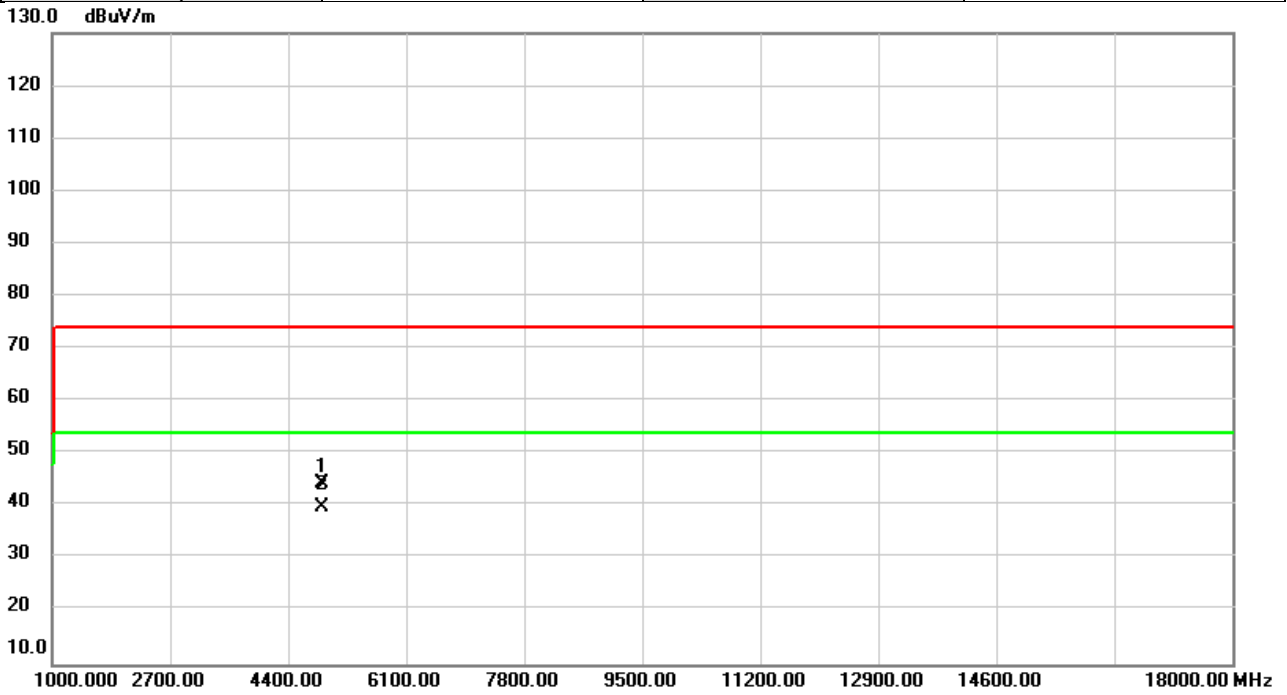

No.	Mk.	Freq. MHz	Reading Level dBuV	Correct Factor dB	Measure- ment dBuV/m	Limit dBuV/m	Over dB	Detector	Comment
1		4882.000	43.52	0.74	44.26	74.00	-29.74	peak	
2	*	4882.000	39.09	0.74	39.83	54.00	-14.17	AVG	

REMARKS:

- (1) Measurement Value = Reading Level + Correct Factor.
- (2) Margin Level = Measurement Value - Limit Value.

Test Mode	BT (1 Mbps)	Test Date	2023/12/19
Test Frequency	2480MHz	Polarization	Vertical
Temp	23°C	Hum.	57%

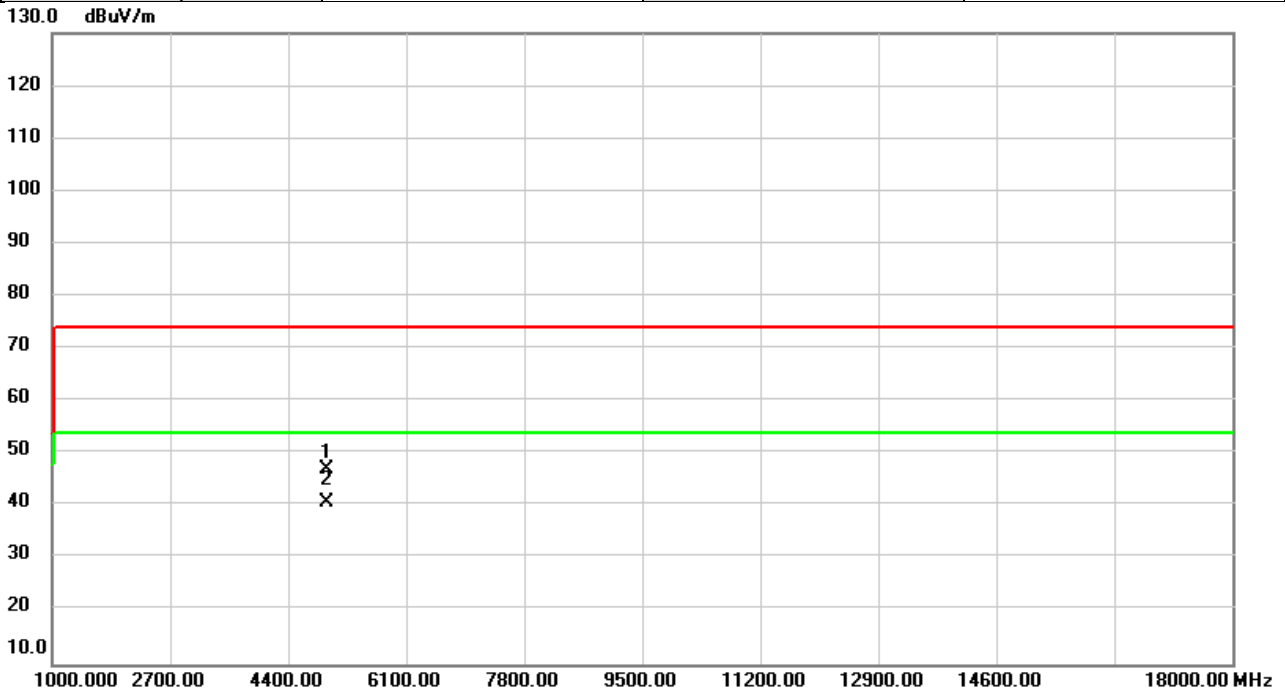

No.	Mk.	Freq. MHz	Reading Level dBuV	Correct Factor dB	Measure- ment dBuV/m	Limit dBuV/m	Over dB	Detector	Comment
1		4960.000	46.09	0.99	47.08	74.00	-26.92	peak	
2	*	4960.000	39.83	0.99	40.82	54.00	-13.18	AVG	

REMARKS:

- (1) Measurement Value = Reading Level + Correct Factor.
- (2) Margin Level = Measurement Value - Limit Value.

Test Mode	BT (1 Mbps)	Test Date	2023/12/19
Test Frequency	2480MHz	Polarization	Horizontal
Temp	23°C	Hum.	57%

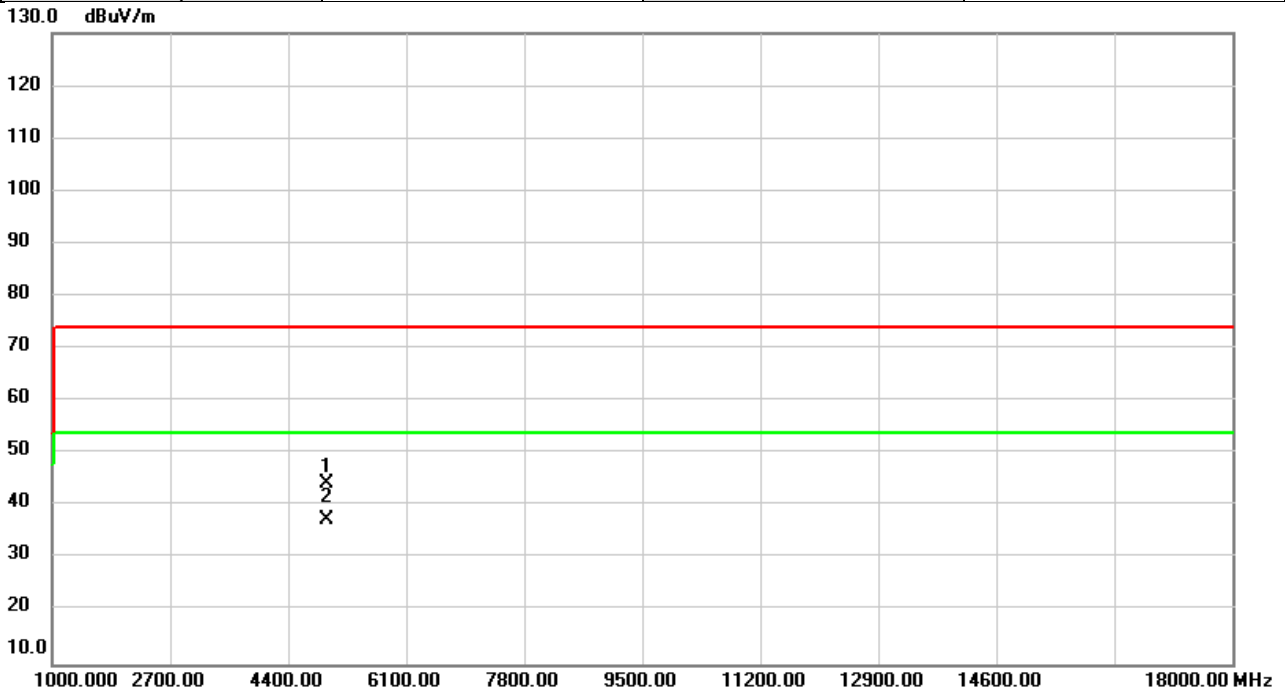

No.	Mk.	Freq. MHz	Reading Level dBuV	Correct Factor dB	Measure- ment dBuV/m	Limit dBuV/m	Over dB	Detector	Comment
1		4960.000	43.41	0.99	44.40	74.00	-29.60	peak	
2	*	4960.000	36.51	0.99	37.50	54.00	-16.50	AVG	

REMARKS:

- (1) Measurement Value = Reading Level + Correct Factor.
- (2) Margin Level = Measurement Value - Limit Value.

Test Mode	BT (3 Mbps)	Test Date	2023/12/19
Test Frequency	2402MHz	Polarization	Vertical
Temp	23°C	Hum.	57%

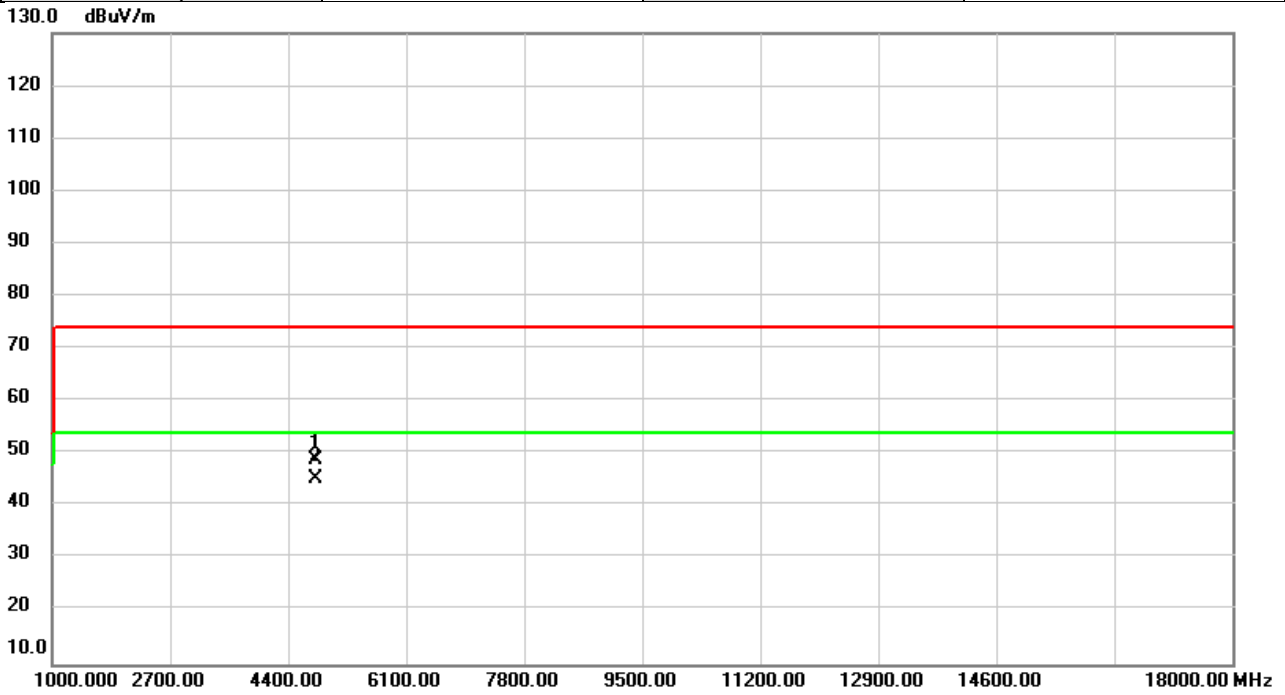

No.	Mk.	Freq. MHz	Reading Level dBuV	Correct Factor dB	Measure- ment dBuV/m	Limit dBuV/m	Over dB	Detector	Comment
1		4804.000	48.24	0.50	48.74	74.00	-25.26	peak	
2	*	4804.000	44.78	0.50	45.28	54.00	-8.72	AVG	

REMARKS:

- (1) Measurement Value = Reading Level + Correct Factor.
- (2) Margin Level = Measurement Value - Limit Value.

Test Mode	BT (3 Mbps)	Test Date	2023/12/19
Test Frequency	2402MHz	Polarization	Horizontal
Temp	23°C	Hum.	57%

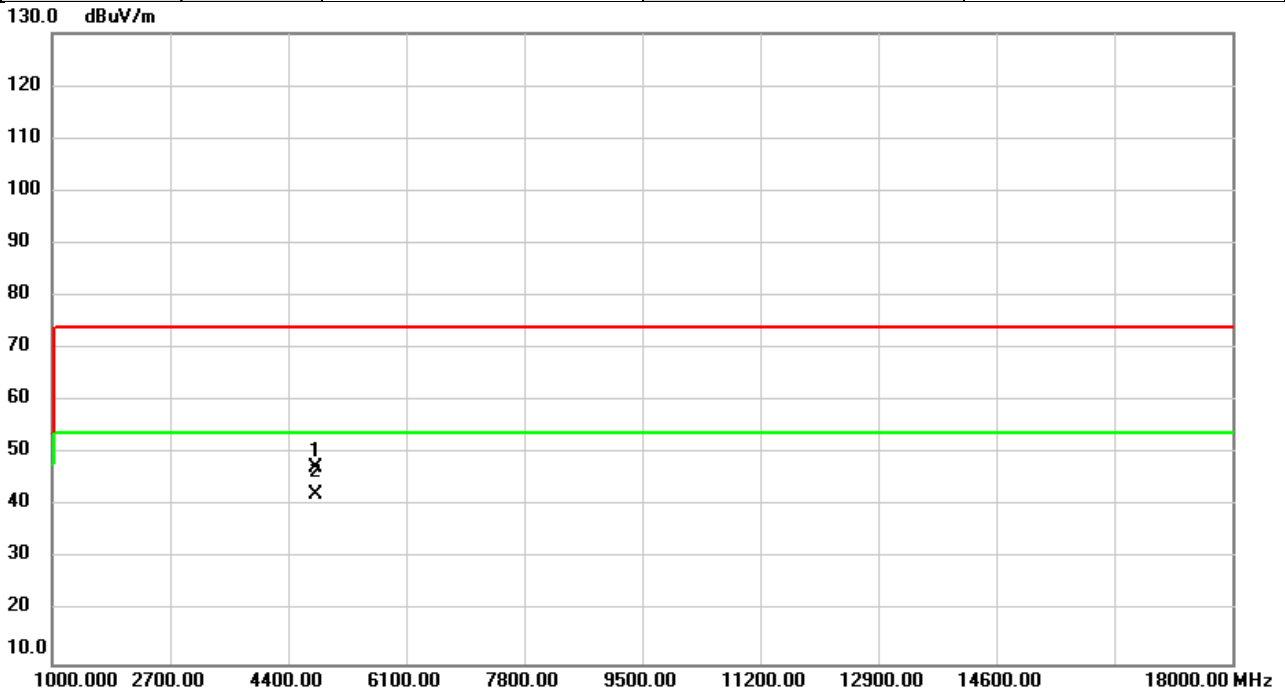

No.	Mk.	Freq. MHz	Reading Level dBuV	Correct Factor dB	Measure- ment dBuV/m	Limit dBuV/m	Over dB	Detector	Comment
1		4804.000	46.89	0.50	47.39	74.00	-26.61	peak	
2	*	4804.000	41.64	0.50	42.14	54.00	-11.86	AVG	

REMARKS:

- (1) Measurement Value = Reading Level + Correct Factor.
- (2) Margin Level = Measurement Value - Limit Value.

Test Mode	BT (3 Mbps)	Test Date	2023/12/19
Test Frequency	2441MHz	Polarization	Vertical
Temp	23°C	Hum.	57%

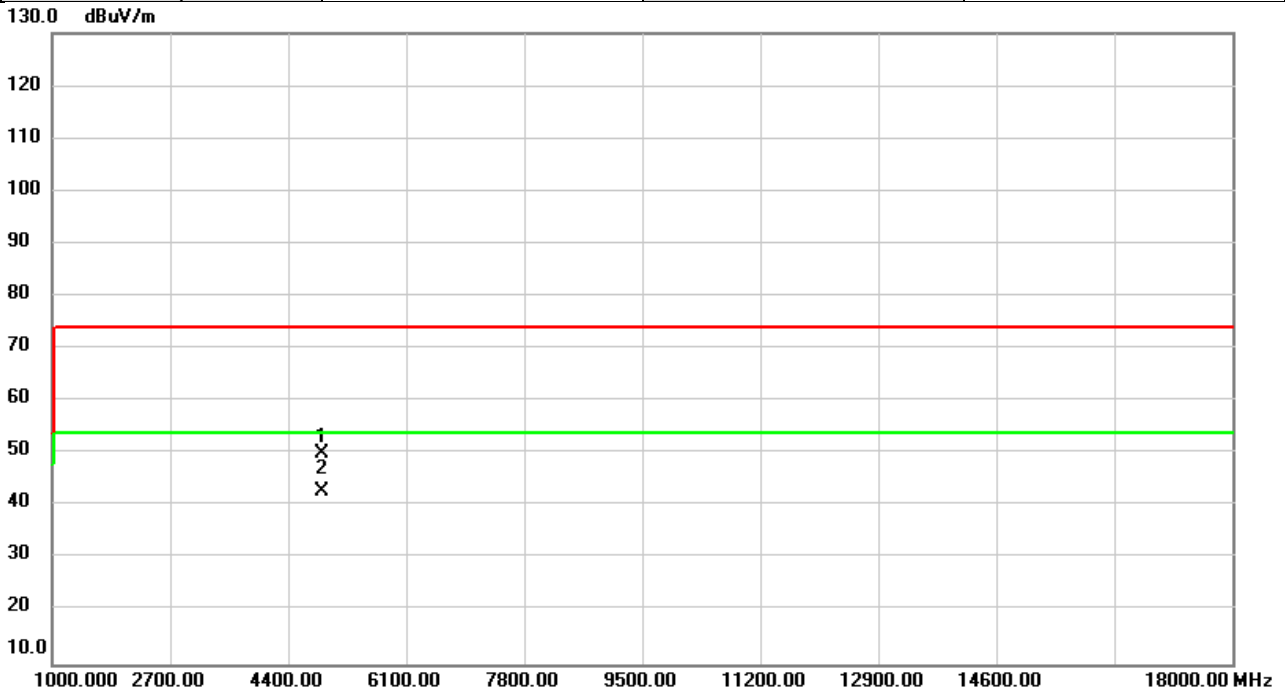

No.	Mk.	Freq. MHz	Reading Level dBuV	Correct Factor dB	Measure- ment dBuV/m	Limit dBuV/m	Over dB	Detector	Comment
1		4882.000	49.25	0.74	49.99	74.00	-24.01	peak	
2	*	4882.000	42.25	0.74	42.99	54.00	-11.01	AVG	

REMARKS:

- (1) Measurement Value = Reading Level + Correct Factor.
- (2) Margin Level = Measurement Value - Limit Value.

Test Mode	BT (3 Mbps)	Test Date	2023/12/19
Test Frequency	2441MHz	Polarization	Horizontal
Temp	23°C	Hum.	57%

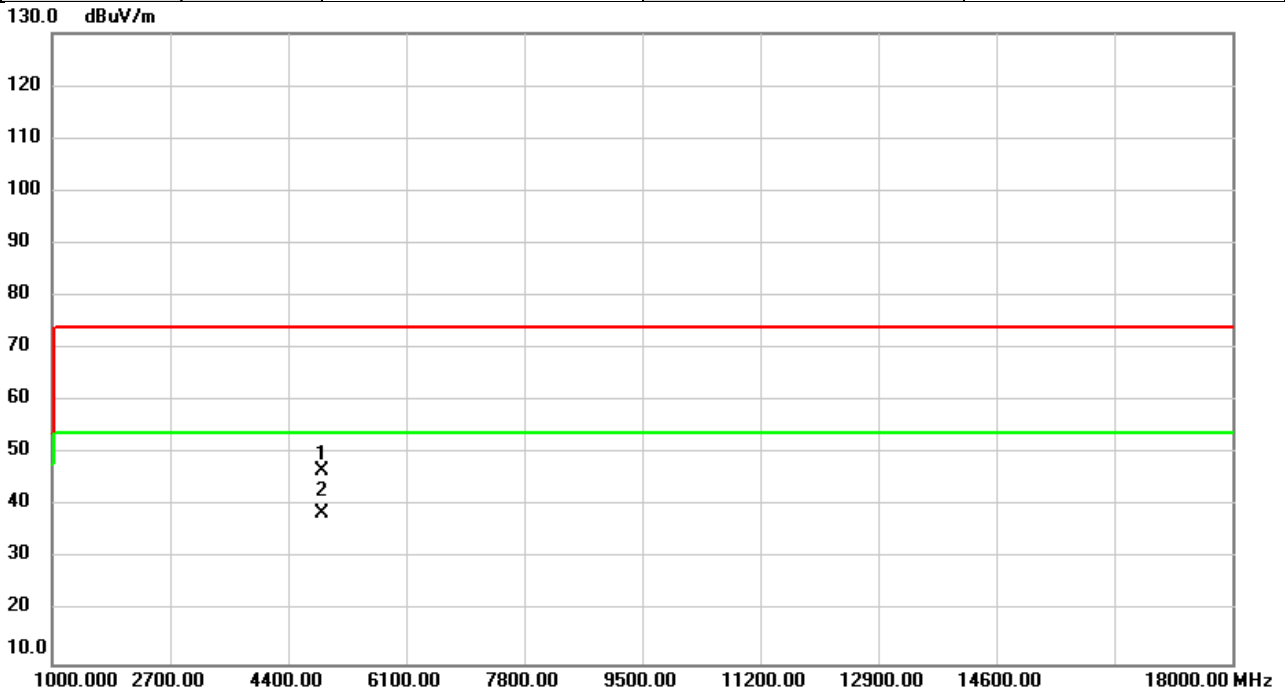

No.	Mk.	Freq. MHz	Reading Level dBuV	Correct Factor dB	Measure- ment dBuV/m	Limit dBuV/m	Over dB	Detector	Comment
1		4882.000	45.86	0.74	46.60	74.00	-27.40	peak	
2	*	4882.000	37.93	0.74	38.67	54.00	-15.33	AVG	

REMARKS:

- (1) Measurement Value = Reading Level + Correct Factor.
- (2) Margin Level = Measurement Value - Limit Value.

Test Mode	BT (3 Mbps)	Test Date	2023/12/19
Test Frequency	2480MHz	Polarization	Vertical
Temp	23°C	Hum.	57%

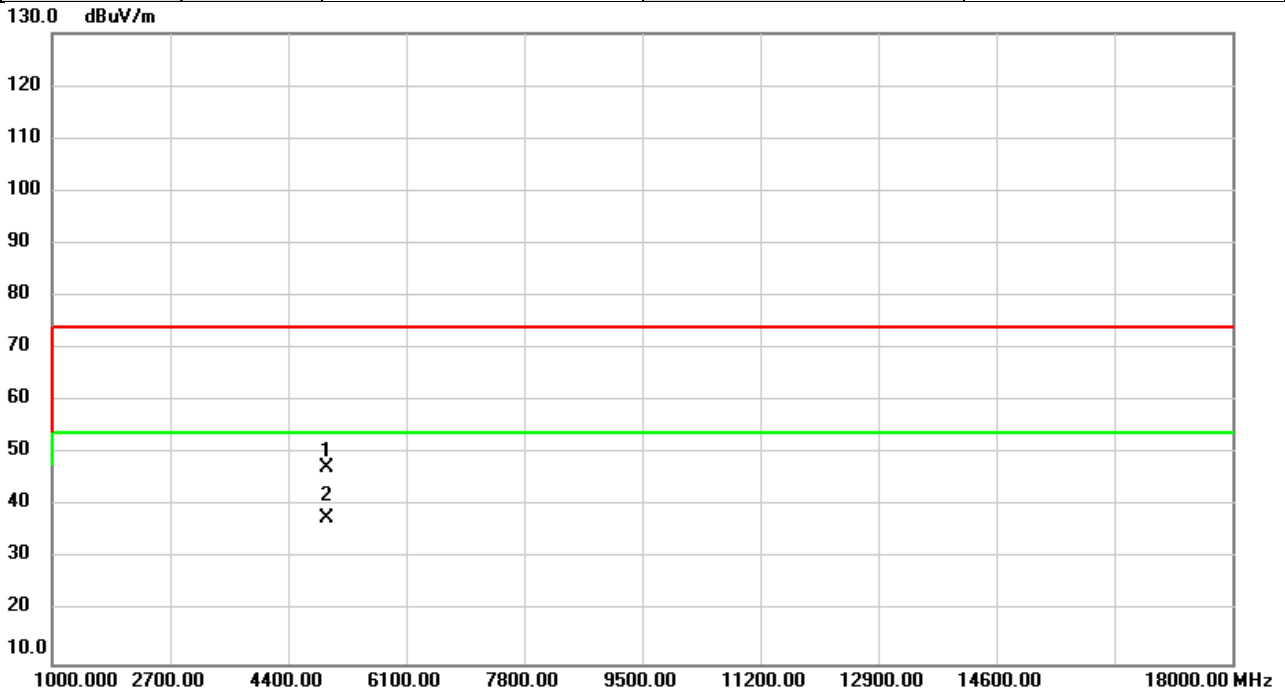

No.	Mk.	Freq. MHz	Reading Level dBuV	Correct Factor dB	Measure- ment dBuV/m	Limit dBuV/m	Over dB	Detector	Comment
1		4960.000	46.25	0.99	47.24	74.00	-26.76	peak	
2	*	4960.000	36.69	0.99	37.68	54.00	-16.32	AVG	

REMARKS:

- (1) Measurement Value = Reading Level + Correct Factor.
- (2) Margin Level = Measurement Value - Limit Value.

Test Mode	BT (3 Mbps)	Test Date	2023/12/19
Test Frequency	2480MHz	Polarization	Horizontal
Temp	23°C	Hum.	57%

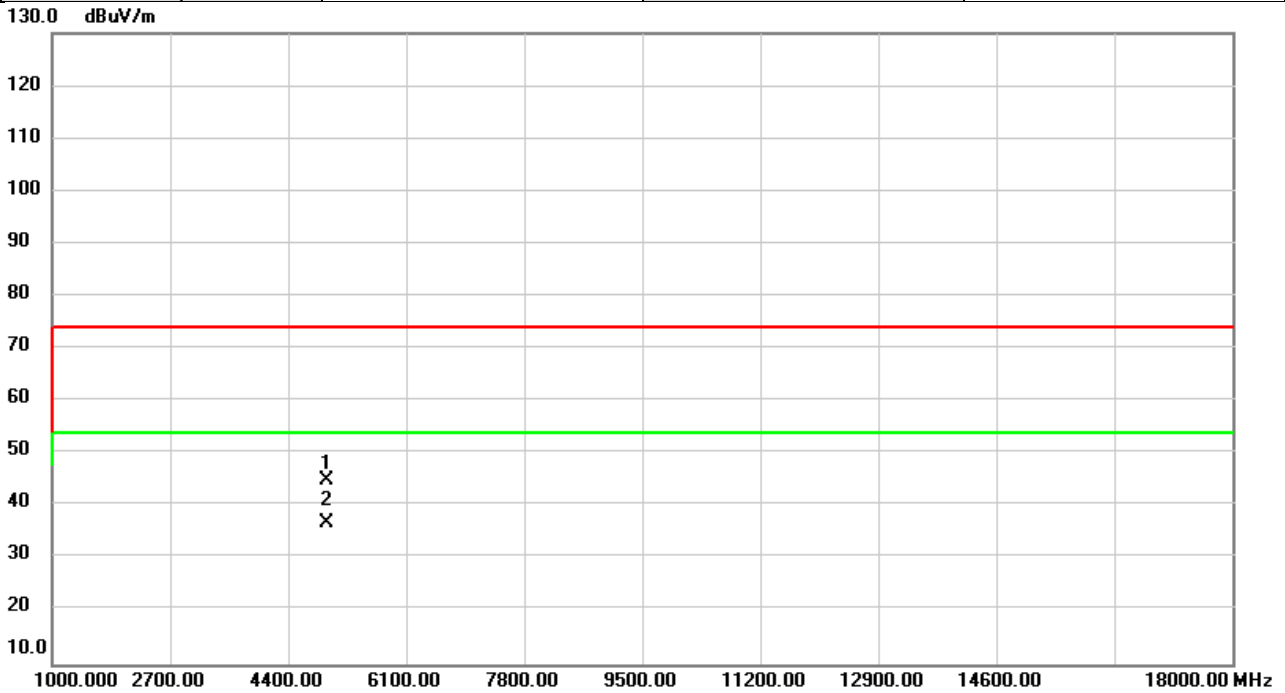

No.	Mk.	Freq. MHz	Reading Level dBuV	Correct Factor dB	Measure- ment dBuV/m	Limit dBuV/m	Over dB	Detector	Comment
1		4960.000	43.86	0.99	44.85	74.00	-29.15	peak	
2	*	4960.000	35.79	0.99	36.78	54.00	-17.22	AVG	

REMARKS:

- (1) Measurement Value = Reading Level + Correct Factor.
- (2) Margin Level = Measurement Value - Limit Value.

Test Mode	BT (1 Mbps)	Test Date	2023/12/19
Test Frequency	2441MHz	Polarization	Vertical
Temp	23°C	Hum.	57%

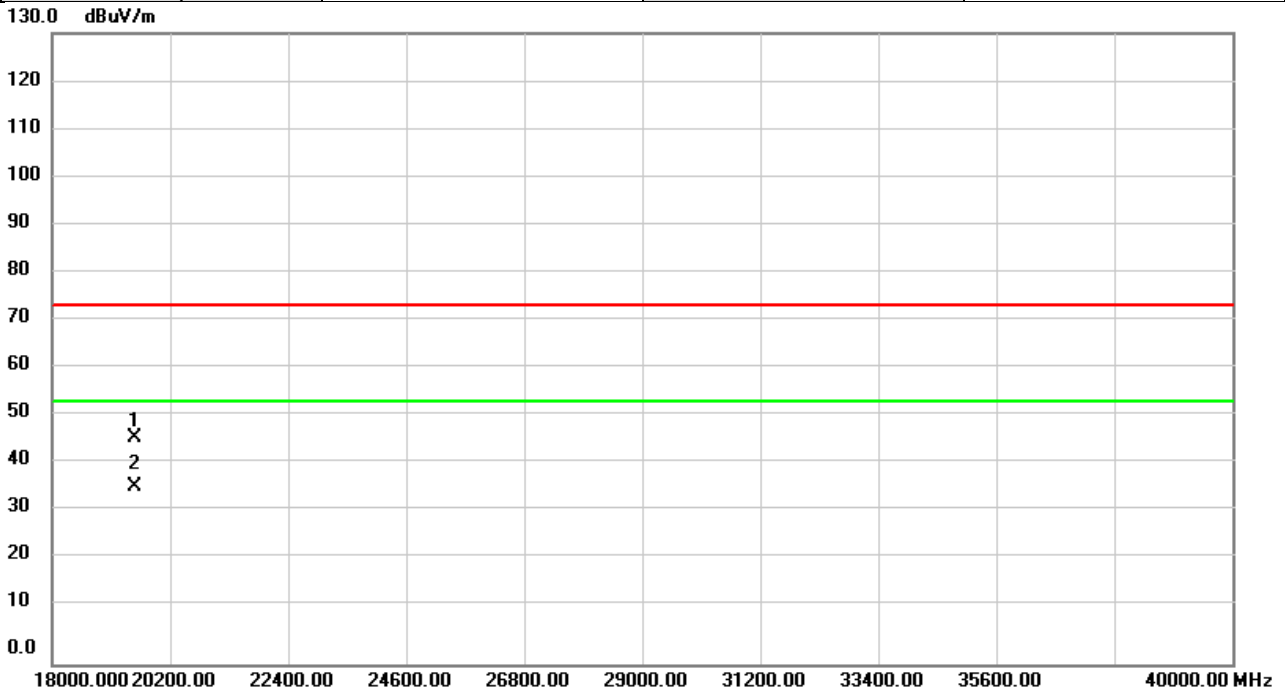

No.	Mk.	Freq. MHz	Reading Level dBuV	Correct Factor dB	Measure- ment dBuV/m	Limit dBuV/m	Over dB	Detector	Comment
1		19528.00	54.30	-7.63	46.67	74.00	-27.33	peak	
2	*	19528.00	44.13	-7.63	36.50	54.00	-17.50	AVG	

REMARKS:

- (1) Measurement Value = Reading Level + Correct Factor.
- (2) Margin Level = Measurement Value - Limit Value.

Test Mode	BT (1 Mbps)	Test Date	2023/12/19
Test Frequency	2441MHz	Polarization	Horizontal
Temp	23°C	Hum.	57%

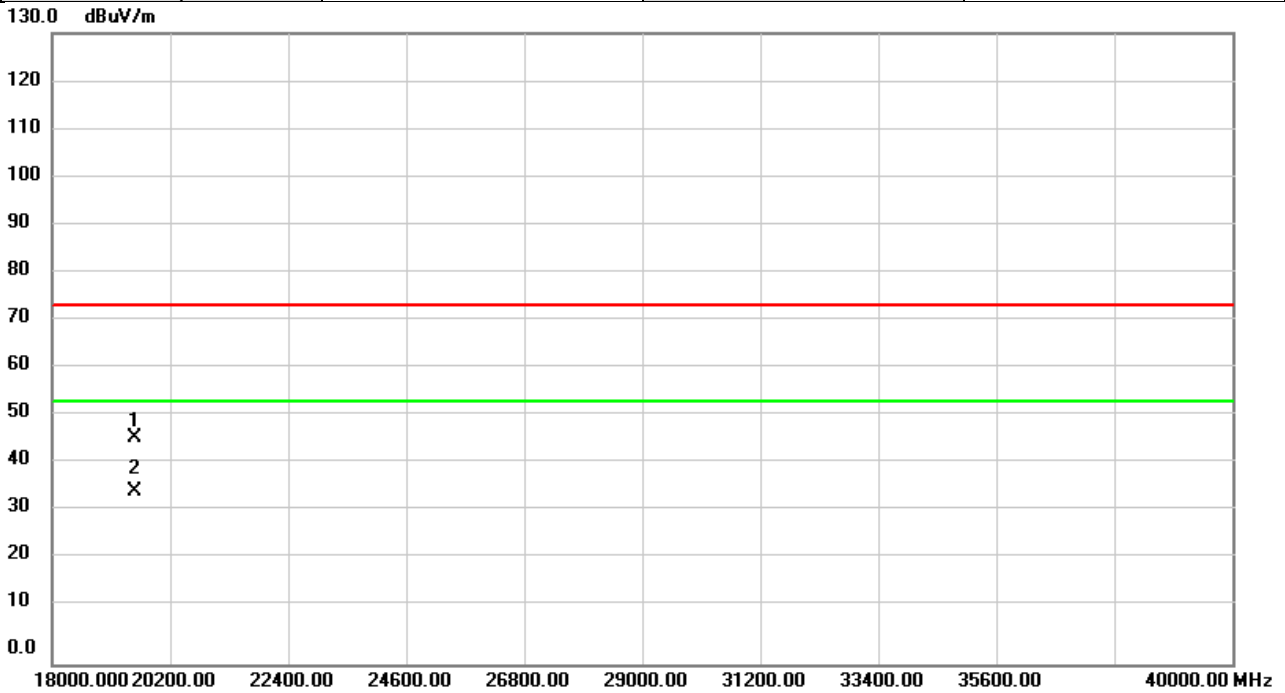

No.	Mk.	Freq. MHz	Reading Level dBuV	Correct Factor dB	Measure- ment dBuV/m	Limit dBuV/m	Over dB	Detector	Comment
1		19528.00	54.30	-7.63	46.67	74.00	-27.33	peak	
2	*	19528.00	43.29	-7.63	35.66	54.00	-18.34	AVG	

REMARKS:

- (1) Measurement Value = Reading Level + Correct Factor.
- (2) Margin Level = Measurement Value - Limit Value.

APPENDIX E NUMBER OF HOPPING CHANNEL

Test Mode	1/3Mbps
-----------	---------

Test Mode	Number of Hopping Channel	≥ Limit	Test Result
1 Mbps	79	15	Pass
3 Mbps	79	15	Pass

1 Mbps

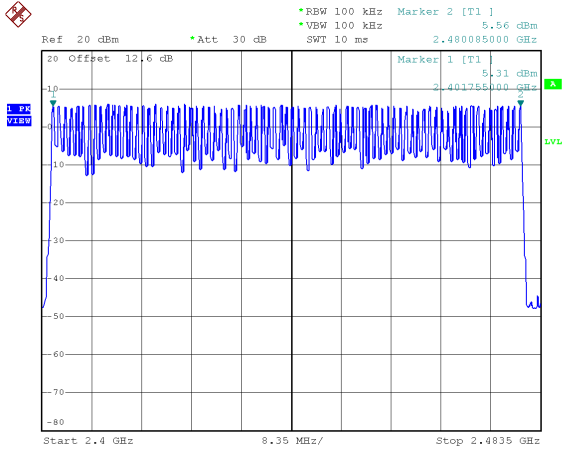

3 Mbps

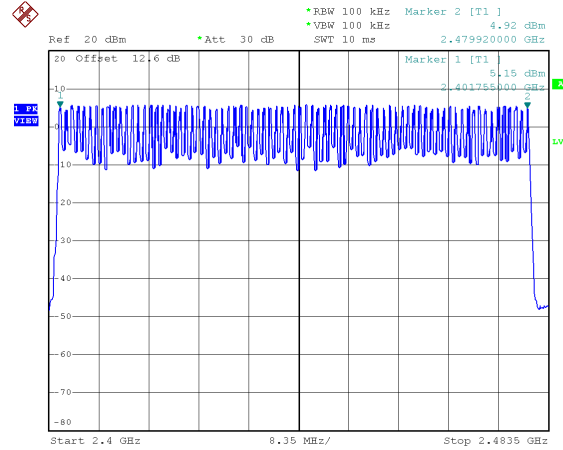

Date: 18.DEC.2023 17:55:01

Date: 18.DEC.2023 18:04:52

APPENDIX F AVERAGE TIME OF OCCUPANCY

Test Mode : 1Mbps

Data Packet	Frequency (MHz)	Pulse Duration (ms)	Dwell Time (s)	Limits (s)	Test Result
DH5	2402	2.9200	0.3115	0.4000	Pass
DH3	2402	1.6400	0.2624	0.4000	Pass
DH1	2402	0.3800	0.1216	0.4000	Pass
DH5	2441	2.9200	0.3115	0.4000	Pass
DH3	2441	1.6400	0.2624	0.4000	Pass
DH1	2441	0.3800	0.1216	0.4000	Pass
DH5	2480	2.9200	0.3115	0.4000	Pass
DH3	2480	1.6400	0.2624	0.4000	Pass
DH1	2480	0.3850	0.1232	0.4000	Pass

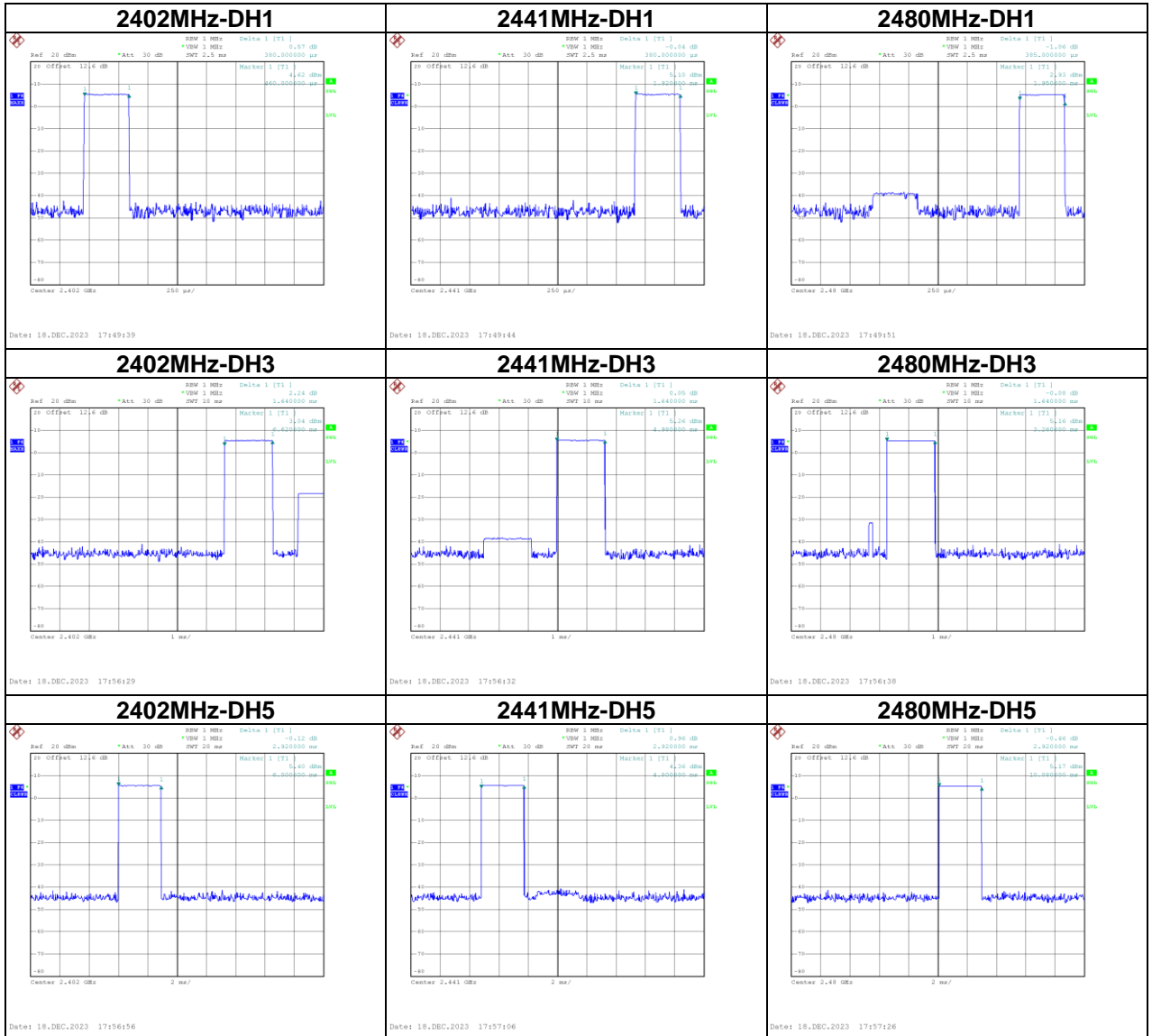

Test Mode : 3Mbps

Data Packet	Frequency	Pulse Duration(ms)	Dwell Time(s)	Limits(s)	Test Result
3DH5	2402	2.9200	0.3115	0.4000	Pass
3DH3	2402	1.6400	0.2624	0.4000	Pass
3DH1	2402	0.3800	0.1216	0.4000	Pass
3DH5	2441	2.9200	0.3115	0.4000	Pass
3DH3	2441	1.6400	0.2624	0.4000	Pass
3DH1	2441	0.3850	0.1232	0.4000	Pass
3DH5	2480	2.9200	0.3115	0.4000	Pass
3DH3	2480	1.6400	0.2624	0.4000	Pass
3DH1	2480	0.3800	0.1216	0.4000	Pass

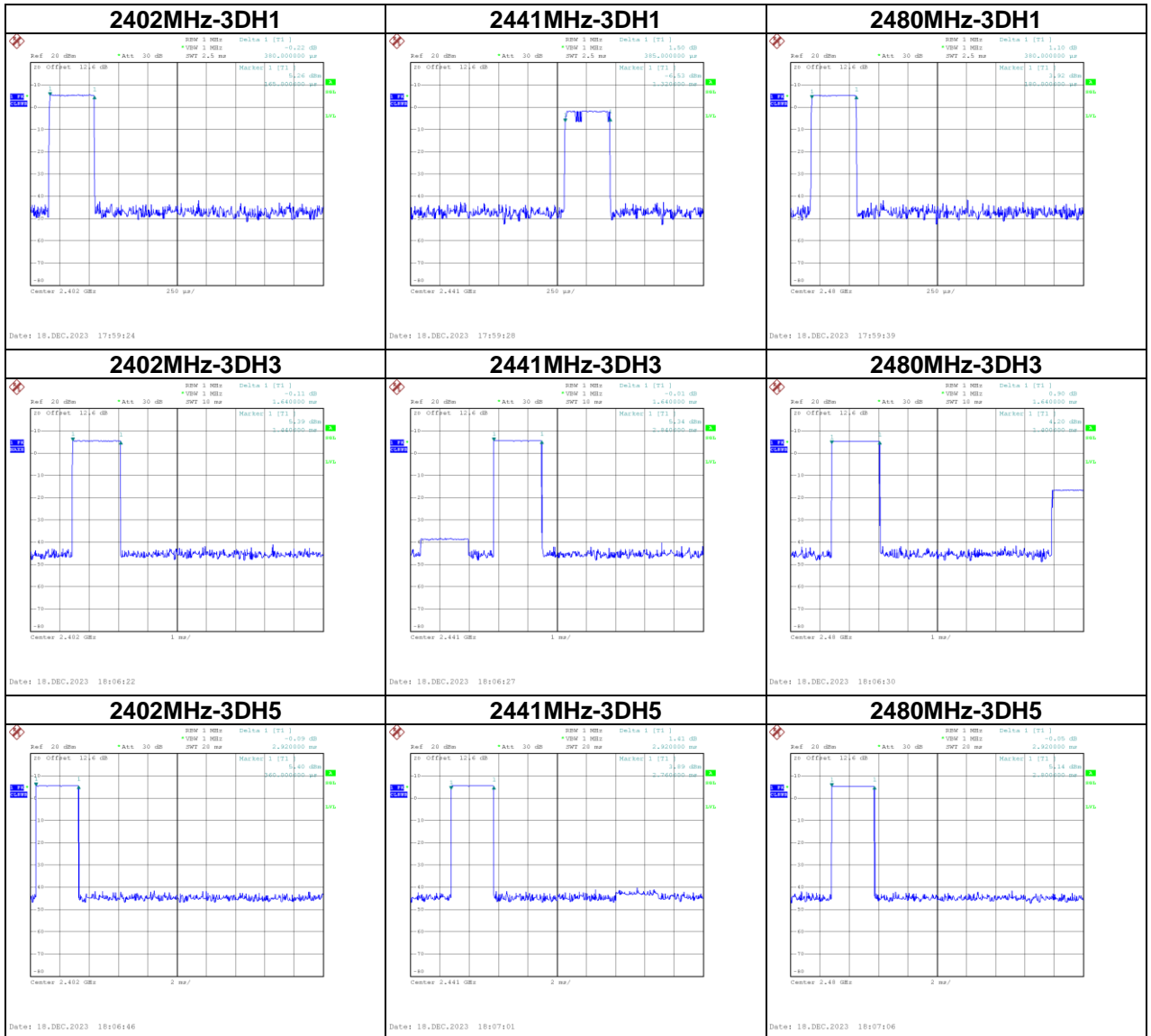

APPENDIX G HOPPING CHANNEL SEPARATION MEASUREMENT

Test Mode : Hopping on _1Mbps

Frequency (MHz)	Channel Separation (MHz)	2/3 of 20dB Bandwidth (MHz)	Test Result
2402	0.822	0.639	Pass
2441	1.184	0.634	Pass
2480	0.843	0.640	Pass

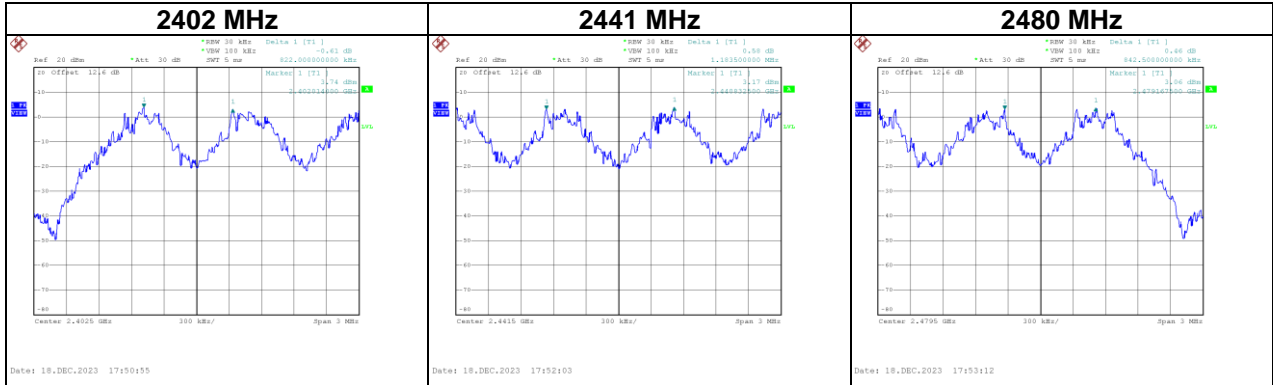

Test Mode : Hopping on _3Mbps

Frequency (MHz)	Channel Separation (MHz)	2/3 of 20dB Bandwidth (MHz)	Test Result
2402	0.822	0.389	Pass
2441	0.959	0.444	Pass
2480	1.151	0.439	Pass

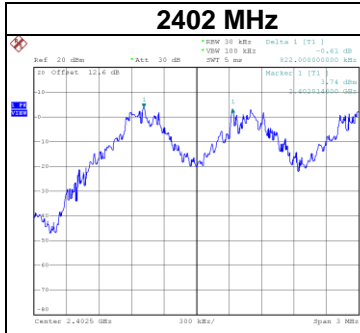

Date: 18 DEC 2023 18:00:43

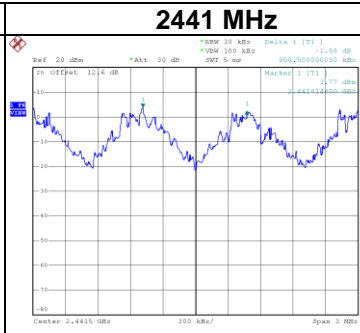

Date: 18 DEC 2023 18:01:53

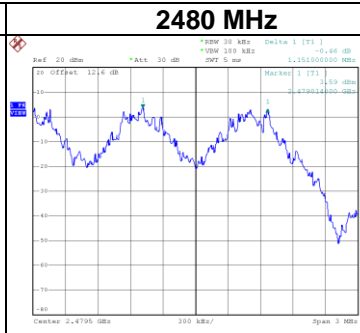

Date: 18 DEC 2023 18:03:03

APPENDIX H BANDWIDTH

Test Mode : 1Mbps

Frequency (MHz)	20dB Bandwidth (MHz)	99% Occupied BW (MHz)	Test Result
2402	0.958	0.884	Pass
2441	0.951	0.884	Pass
2480	0.960	0.868	Pass

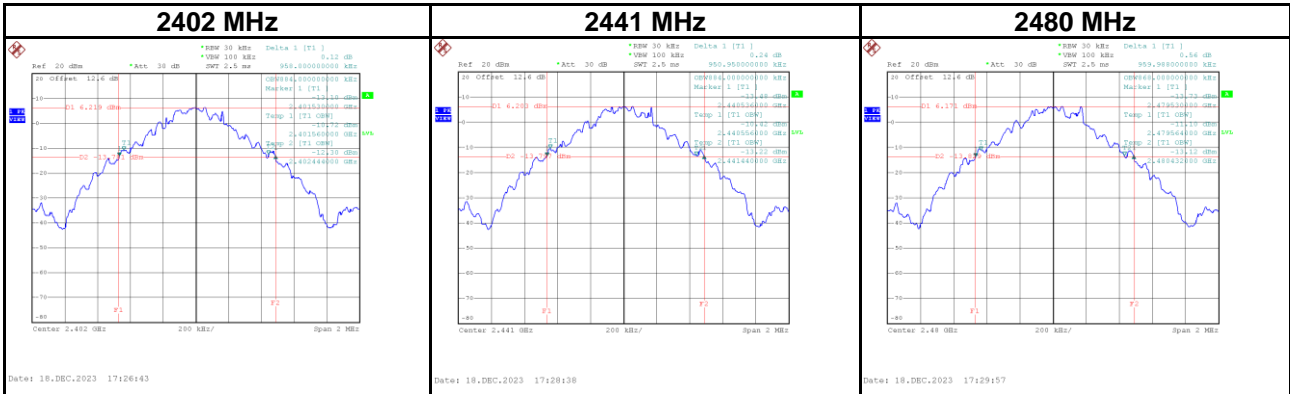

Test Mode : 3Mbps

Frequency (MHz)	20dB Bandwidth (MHz)	99% Occupied BW (MHz)	Test Result
2402	0.584	0.920	Pass
2441	0.666	0.800	Pass
2480	0.658	0.744	Pass

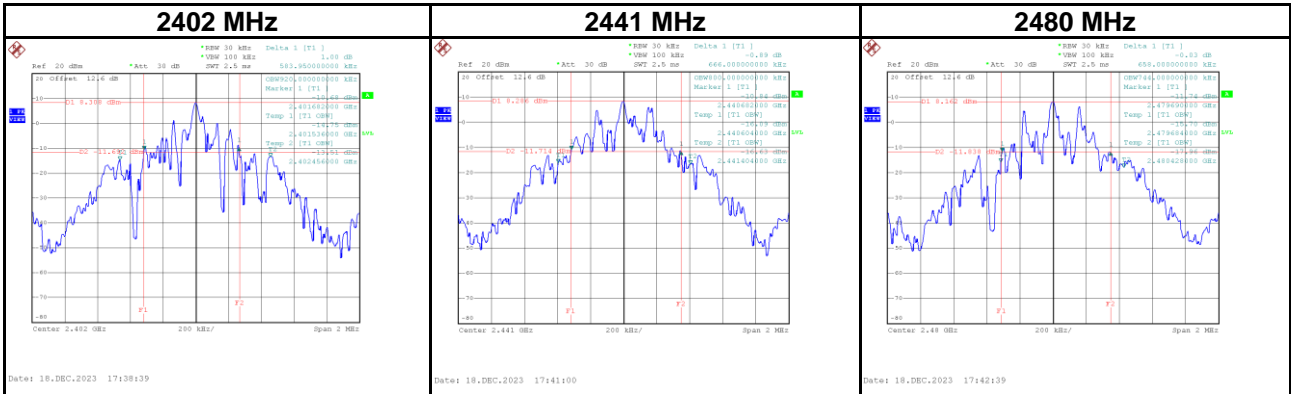

APPENDIX I OUTPUT POWER

Test Mode :	BT(1 Mbps)	Tested Date	2023/12/15
-------------	------------	-------------	------------

Frequency (MHz)	Conducted Power (dBm)	Conducted Power (W)	Max. Limit (dBm)	Max. Limit (W)	Test Result
2402	9.26	0.0084	20.97	0.1250	Pass
2441	9.19	0.0083	20.97	0.1250	Pass
2480	9.10	0.0081	20.97	0.1250	Pass

Test Mode :	BT(2 Mbps)	Tested Date	2023/12/15
-------------	------------	-------------	------------

Frequency (MHz)	Conducted Power (dBm)	Conducted Power (W)	Max. Limit (dBm)	Max. Limit (W)	Test Result
2402	8.42	0.0070	20.97	0.1250	Pass
2441	8.33	0.0068	20.97	0.1250	Pass
2480	8.04	0.0064	20.97	0.1250	Pass

Test Mode :	BT(3 Mbps)	Tested Date	2023/12/15
-------------	------------	-------------	------------

Frequency (MHz)	Conducted Power (dBm)	Conducted Power (W)	Max. Limit (dBm)	Max. Limit (W)	Test Result
2402	8.40	0.0069	20.97	0.1250	Pass
2441	8.46	0.0070	20.97	0.1250	Pass
2480	8.19	0.0066	20.97	0.1250	Pass

APPENDIX J ANTENNA CONDUCTED SPURIOUS EMISSION

Test Mode | 1Mbps

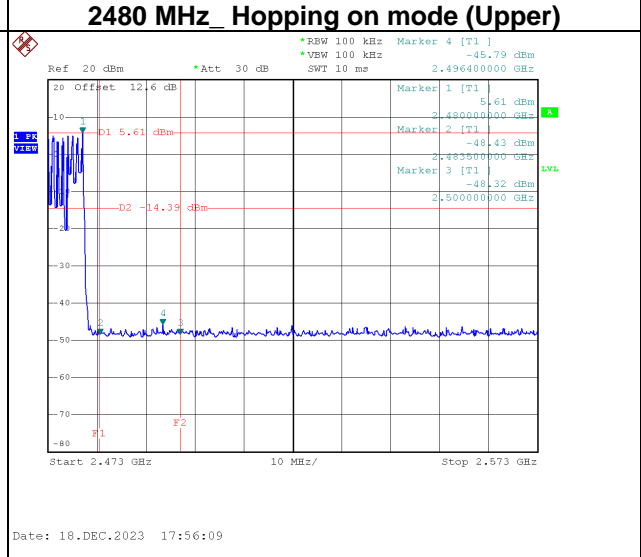
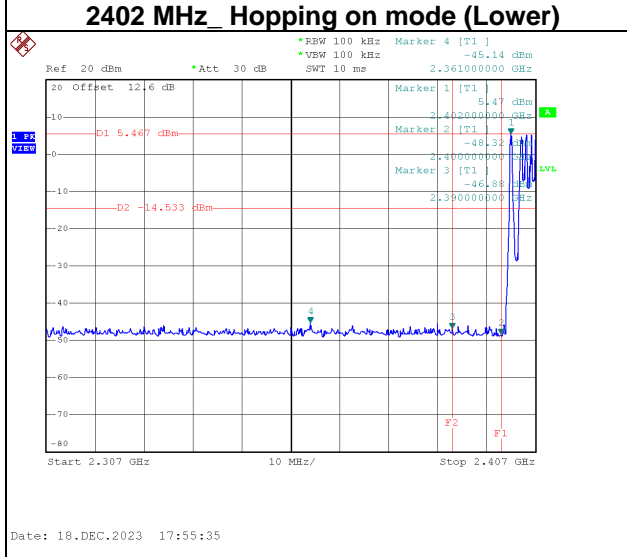
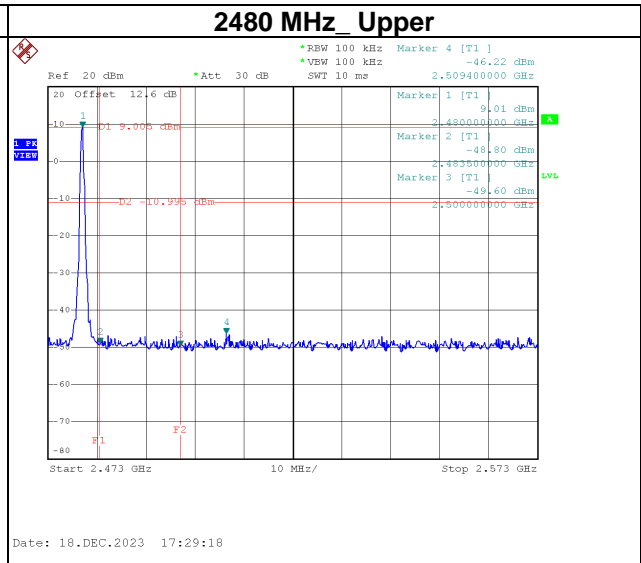
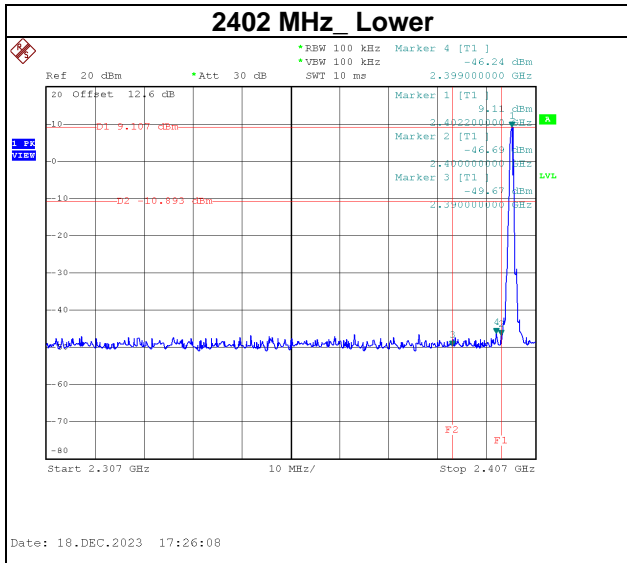

2402 MHz – 10th Harmonics

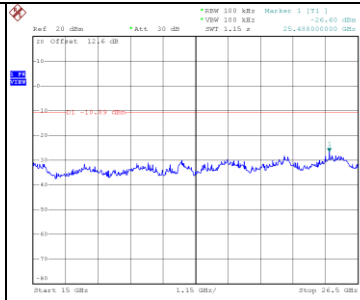
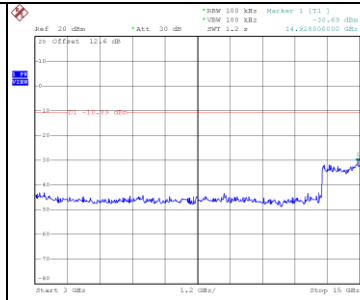
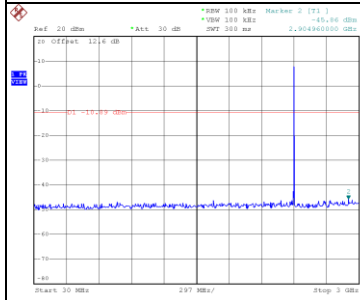

2441 MHz – 10th Harmonics

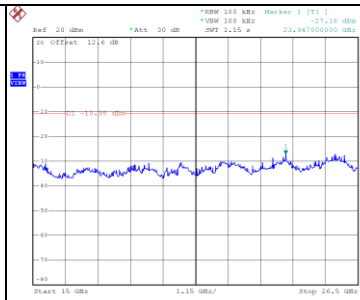
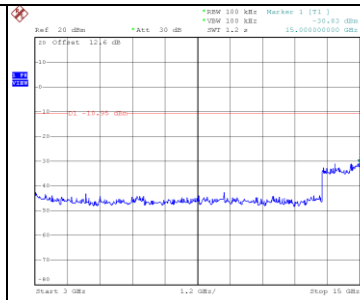
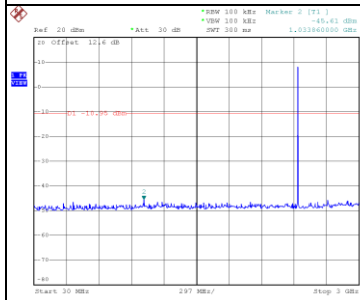

2480 MHz – 10th Harmonics

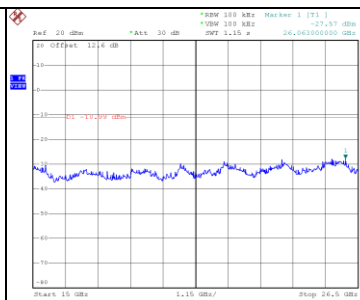
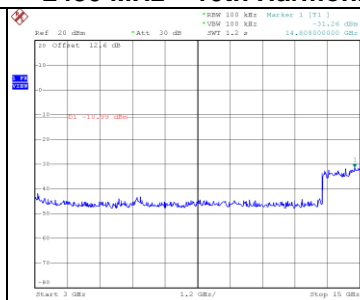
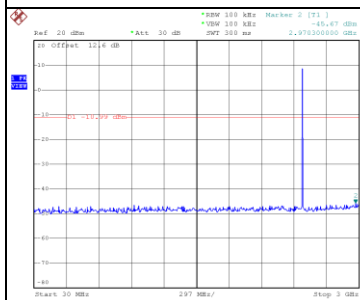

Test Mode 3Mbps

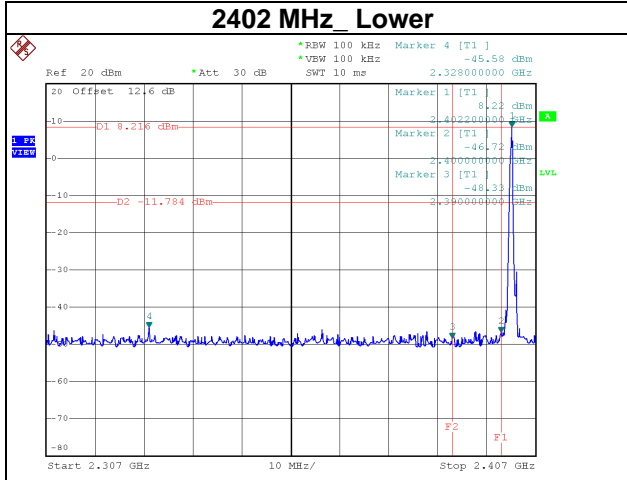

Date: 18.DEC.2023 17:37:42

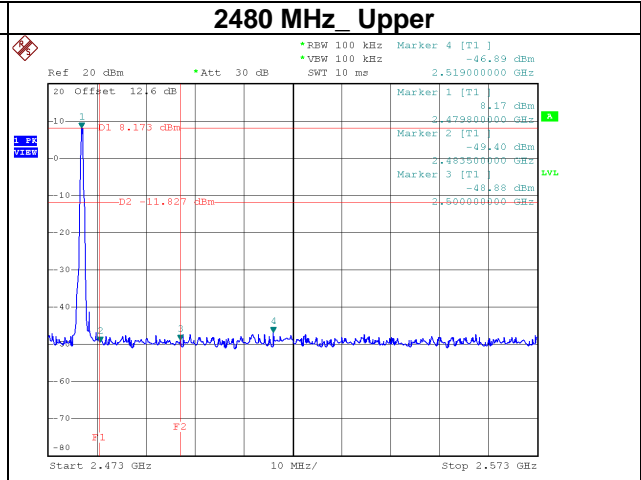

Date: 18.DEC.2023 17:41:46

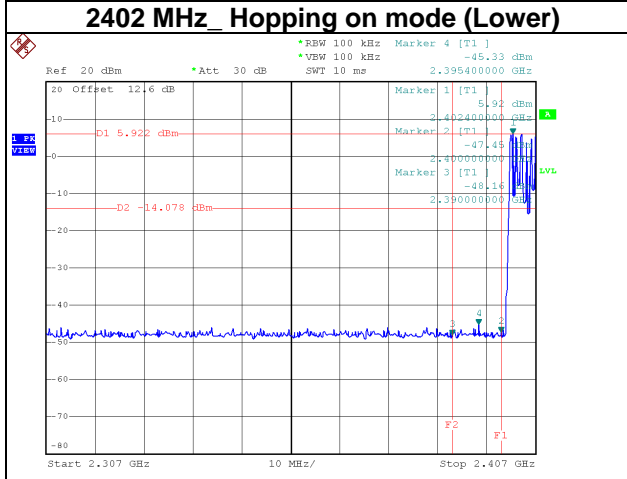

Date: 18.DEC.2023 18:05:26

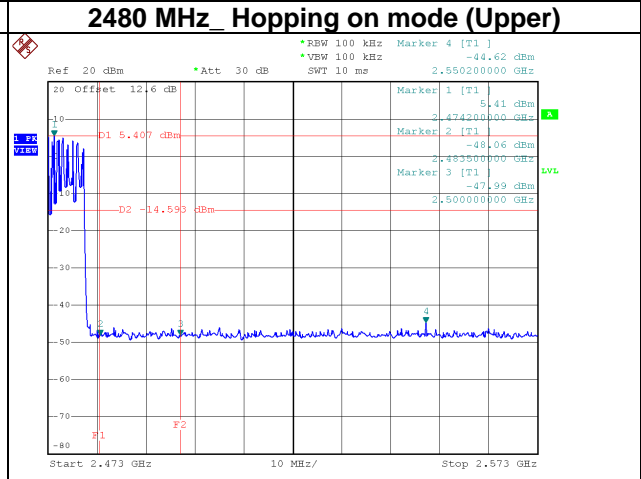

Date: 18.DEC.2023 18:06:00

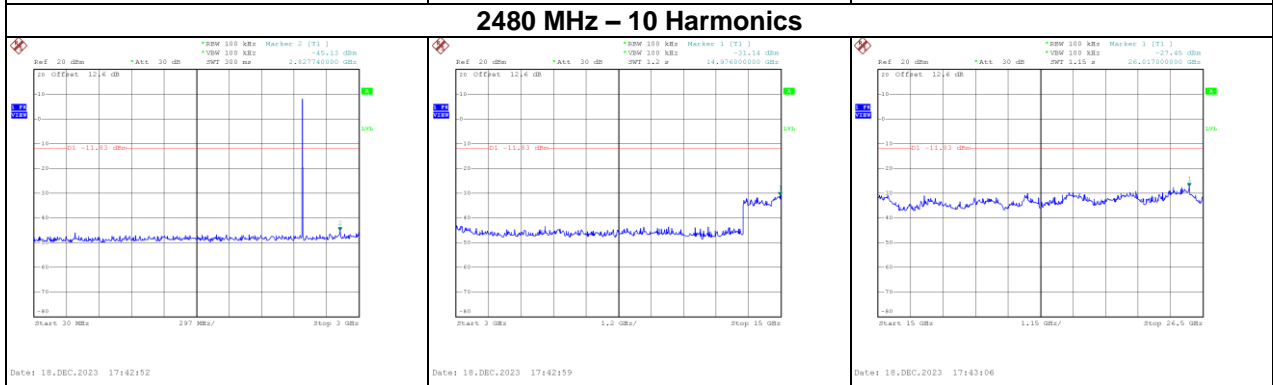
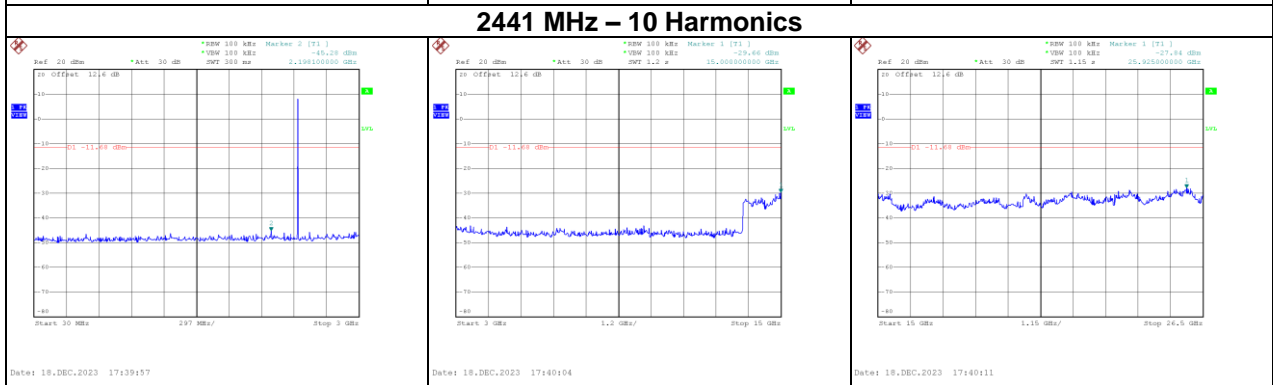
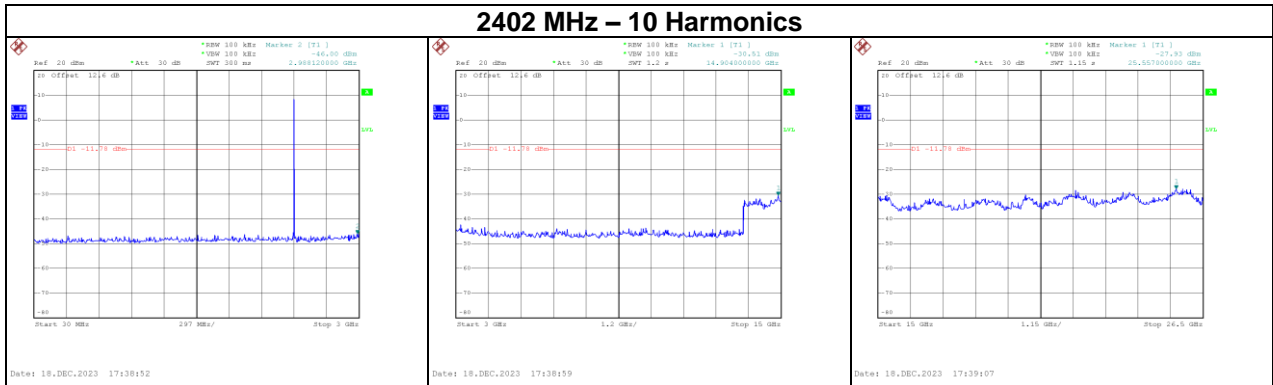

End of Test Report